



LCIE

TEST REPORT

Number
Composition of document

RADIO

119405-638393E-Cr2014-01-20
46 pages

Standards

ETSI EN 301 839-1 V1.2.1 (Limited program)
ETSI EN 301 839-2 V1.3.1 (Limited program)
FCC RULES PART 95I (Limited program)
FCC RULES PART 15 (Limited program)
FCC RULES PART 2 (Limited program)
IC RADIO STANDARDS RSS-243 (Limited program)
Specified low-power radio equipment (Item 8 of Article 2 Paragraph 1 of Certification Ordinance) (Limited program)

Issued to

SORIN CRM
Parc d'affaires NOVEOS
4, Avenue Réaumur
92140 Clamart Cedex , FRANCE

Apparatus under test

Trade mark
Manufacturer
Type
Serial number

Syndeli RF V2 implantable cardioverter defibrillator
SORIN Group
SORIN BIOMEDICA CRM
INTENSIA — DR 154
F48AE01A

Test date

From February 26th to March 6th, 2013

Tests performed by

Julien BOUTAUD & Laurent DENEUX

Test site

Fontenay Aux Roses & Ecuelles

File issued on

January 20th, 2014

Written by :
Julien BOUTAUD & Laurent DENEUX
Tests operator

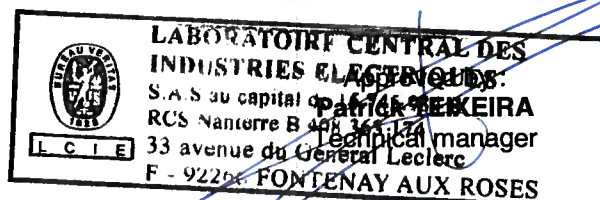

This document shall not be reproduced, except in full, without the written approval of the LCIE. This document contains results related only to the item tested. It does not imply the conformity of the whole production to the items tested. Unless otherwise specified, the decision of conformity takes into account the uncertainty of measures.



SUMMARY

1.	TEST PROGRAM	3
2.	EQUIPMENT DESCRIPTION.....	5
3.	FREQUENCY ERROR & FREQUENCY STABILITY	8
4.	EFFECTIVE RADIATED POWER, MAXIMUM TRANSMITTER POWER & ANTENNA POWER	9
5.	EMISSION BANDWIDTH & OCCUPIED BANDWIDTH.....	11
6.	SPURIOUS EMISSIONS OF TRANSMITTER & TOLERANCE OF UNWANTED EMISSION INTENSITY.....	12
7.	UNWANTED RADIATION	17
8.	RECEIVER SPURIOUS RADIATION & SECONDARY RADIATED EMISSION	19
9.	RADIATION EMISSIONS.....	22
10.	TEST EQUIPMENT LIST	24
11.	UNCERTAINTIES CHART	25
12.	ANNEX 1 (GRAPHS)	26
13.	ANNEX 2 (FLUID DATA SHEET MSL 450).....	45



1. TEST PROGRAM

• **References**

- Standards :
- ETSI EN 301 839-1 V1.3.1
 - ETSI EN 301 839-2 V1.2.1
 - ERC Recommendation 70-03
 - FCC RULES PART 95I
 - FCC RULES PART 15
 - FCC RULES PART 2
 - IC RADIO STANDARDS RSS-243
 - Specified low-power radio equipment (Item 8 of Article 2 Paragraph 1 of Certification Ordinance)

• **Transmitter requirement:**

<p>Clause (ETSI EN 301 839-1) Clause (FCC PART 95I) Clause (RSS 243) Clause (Specified low-power radio equipment (Item 8 of Article 2 Paragraph 1 of Certification Ordinance)) Test Description</p>	<p>TEST RESULT - Comments</p>
<p>EN § 8.1 – Frequency error FCC § 95.627 (e) – Frequency stability FCC § 2.1055 – Measurements required: Frequency stability RSS § 3.3 – Frequency stability Specified low-power radio equipment (Item 8 of Article 2 Paragraph 1 of Certification Ordinance) –Tolerance of frequency</p>	<p>PASS (Remark 1) PASS (Remark 1) PASS (Remark 1) PASS (Remark 1) PASS (Remark 1)</p>
<p>EN § 8.3 – Effective radiated power of the fundamental emission FCC § 95.639 (f) – Maximum transmitter power FCC § 2.1046 – Measurements required: RF power output RSS § 5.4 – Maximum transmitter power Specified low-power radio equipment (Item 8 of Article 2 Paragraph 1 of Certification Ordinance) – Antenna gain</p>	<p>PASS PASS PASS PASS PASS</p>
<p>EN § 8.2 – Emission bandwidth FCC § 95.633 (e) – Emission bandwidth FCC § 2.1049 – Measurements required: Occupied bandwidth RSS § 3.2 – Occupied bandwidth Specified low-power radio equipment (Item 8 of Article 2 Paragraph 1 of Certification Ordinance) – Tolerance of occupied bandwidth</p>	<p>PASS (Remark 1) PASS (Remark 1) PASS (Remark 1) PASS (Remark 1) PASS (Remark 1)</p>
<p>EN § 8.5 – Frequency stability under low voltage conditions</p>	<p>N/A (EUT hermetically sealed: See last paragraph in clause 5.2.2 of ETSI EN 301 839-1 V1.3.1)</p>
<p>EN § 8.4 – Spurious emissions of transmitter Specified low-power radio equipment (Item 8 of Article 2 Paragraph 1 of Certification Ordinance) – Tolerance of unwanted emission intensity</p>	<p>PASS PASS</p>
<p>FCC § 95.635 (d) – Unwanted radiation FCC § 2.1053 – Measurements required: Field strength of spurious radiation RSS § 3.4 – Unwanted radiation Specified low-power radio equipment (Item 8 of Article 2 Paragraph 1 of Certification Ordinance) – Limit of secondary radiated emission</p>	<p>PASS PASS PASS PASS</p>
<p>15.207 – Conducted emission</p>	<p>N/A (Equipment powered by battery)</p>
<p>FCC § 2.1047 – Measurements required: Modulation characteristics</p>	<p>PASS (please refer to §2.1 Equipment information p.5)</p>
<p>FCC § 2.1057 – Frequency spectrum to be investigated</p>	<p>PASS (see §2.1 Equipment information p.5)</p>



• **Receiver requirement:**

Clause (ETSI EN 301 839-1) Clause (FCC PART 15) (only for 400MHz receiver) Clause (FCC PART 95I) Clause (RSS 243-243) Test Description	TEST RESULT - Comments
EN § 9.1 – Spurious radiation of receivers FCC § 2.1053 – Measurements required: Field strength of spurious radiation	PASS PASS
FCC § 15.109 – Radiated emissions RSS § 3.5 – Radiated emissions	PASS PASS
EN § 10.1 – Monitoring system threshold power level FCC § 95.627 (a)(3) – Monitoring system threshold power level RSS § 5.7.1 – Monitoring system threshold power level	N/A N/A N/A
EN § 10.2 – Monitoring system bandwidth FCC § 95.627 (a)(1) – Monitoring system bandwidth RSS § 5.7.2 – Monitoring system bandwidth	N/A N/A N/A
EN § 10.3.1.1 & 10.3.3.1 – Scan cycle time FCC § 95.627 (a)(2) – Scan cycle time RSS § 5.7.3 – Scan cycle time	N/A N/A N/A
EN § 10.3.1.2 & 10.3.3.2 – Minimum channel monitoring period FCC § 95.627 (a)(2) – Minimum channel monitoring period RSS § 5.7.4 – Minimum channel monitoring period	N/A N/A N/A
EN § 10.4 – Channel access FCC § 95.627 (a)(4) – Channel access RSS § 5.7.5 – Channel access	N/A N/A N/A
EN § 10.5 – Discontinuation of MICS session 95.627 (a)(4) – Discontinuation of MICS session RSS § 5.7.6 – Discontinuation of MICS session Specified low-power radio equipment (Item 8 of Article 2 Paragraph 1 of Certification Ordinance) – Transmission suspension function due to interruption of communications	N/A N/A N/A N/A
EN § 10.6 – Use of pre-scanned alternate channel FCC § 95.627 (a)(5) – Use of pre-scanned alternate channel RSS § 5.7.7 – Use of pre-scanned alternate channel	N/A N/A N/A

PASS: EUT complies with standard's requirement

FAIL: EUT does not comply with standard's requirement

N/A: Not Applicable

N/P: Test Not Performed

Remark 1:

The major difference between SORIN INTENSIA — DR 154 & SORIN PARADYM RF – DR model 9550 is the radiated header. Electronic & radio parts are exactly the same between the two models.

So, tests results for SORIN INTENSIA — DR 154 are retrieved from SORIN PARADYM RF – DR model 9550 (FCC ID: YSGDR9550 IC: 10270A-DR9550 Japanese Logo: 207-DR9550) in test report N°112624-622708-K-Cr2012-10-22.

Remark 2: The equipment is: - transmitter and receiver at 400MHz
- only receiver at 2400 MHz.

2. EQUIPMENT DESCRIPTION

2.1. HARDWARE IDENTIFICATION

- **Equipment under test (EUT):**



The EUT is housed in a single cabinet that cannot be readily opened because the enclosure is hermetically sealed.

- **Auxiliary equipment used for testing:**

- Human torso simulator
- Fluid corresponding to human tissue characteristics at that frequency.
- Lead IS-1 BI (reference S BFT6 43868)
- Lead DF4-DLHH (reference 0296)

- **Equipment information:**

- External antenna connector: No
- Frequency band allocated: 402MHz to 405MHz
- Frequency used for test:
 - Fmin: 402,15MHz
 - Fnom: 403,65MHz
 - Fmax: 404,85MHz
- Modulation: 2 FSK
- Data rate: 200kb/s
- Number of channel: 10
- Antenna type: Integral
- Equipment intended for use as a mobile station
- Equipment designed for continuous operation
- Stand By mode: No

2.2. RUNNING MODE

The EUT is set in the following modes during tests:

- Permanent emission with modulation
- Permanent emission without modulation
- Permanent reception

2.3. EQUIPEMENT SET UP AND TESTING CONFIGURATION

Equipment (ULP-AMIs) intended to be implanted in a human body shall be tested in a simulated man constructed as follows in order to simulate operation of the ULP-AMI under actual operation conditions as shown in figure A.2 of EN 301 489-1.

An appropriate simulator for testing ULP-AMI consists of a cylindrical acrylic container with an outside diameter of 300 mm, a sidewall thickness of 6 mm, and a fluid-filled height of 760 mm. It shall be filled with a material that is sufficiently fluid that it will flow around the AIMD without any voids. The dielectric and conductivity properties of this material shall match the dielectric and conductivity properties of human muscle tissue at 403,5 MHz (conductivity = 0,93 and relative permittivity = 57,2). Simple saline solutions do not meet the dielectric and conductivity requirements for use as a substitute for human tissue. All emissions measurements will be made using the above specification with the tissue substitute material at a nominal temperature between 22 °C and 38 °C.

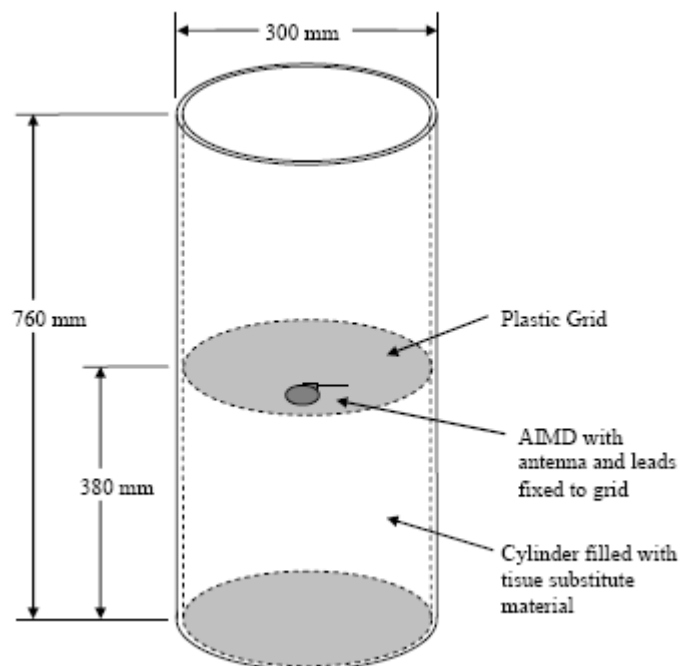

For the testing, the equipment under test (EUT) was suspended in a Plexiglas torso simulator as specified above. The simulator used was constructed in accordance with FCC 95.627(g)(3)(i), EN 301 839-1 (A.113) and EN 301 489-27 annex B.

During the test, the EUT was centred vertically in Plexiglas cylinder. The torso simulator was filled with a fluid formulated in accordance with the specification by using tissue material corresponding to human tissue characteristics at that frequency. The fluid temperature was maintained between 20° to 25° C. There is also the reference for simulator fluid (see annex 2).



2.4. EQUIPEMENT LABELLING

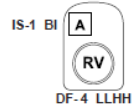

2.5. EQUIPMENT MODIFICATIONS

No equipment modification has been necessary during testing.



3. FREQUENCY ERROR & FREQUENCY STABILITY

3.1. TEST CONDITIONS

Test performed by : Stéphane PHOUDIAH
Date of test : 2012/03/27
Ambient temperature : 24°C
Relative humidity : 32%

3.2. TEST SETUP

FCC 95.627(e)
RSS 243 §3.3
ETSI EN 301 839-1 §8.1
Specified low-power radio equipment (Item 8 of Article 2 Paragraph 1 of Certification Ordinance)

The test is performed on EUT in permanent emission without modulation mode. For measurement under normal and extreme test conditions, the Equipment Under Test is installed in the climatic chamber. A test fixture is created to perform the measurement.

3.3. RESULTS

Frequency: Fmin

Temperature	Tmin	Tnom	Tmax
Power voltage: Vnom			
Frequency (MHz)	402,15	402,1474	402,1502
Frequency Drift (ppm)	0	-6,46	0,49

Frequency: Fnom

Temperature	Tmin	Tnom	Tmax
Power voltage: Vnom			
Frequency (MHz)	403,653	403,6504	403,6522
Frequency Drift (ppm)	7,43	0,99	5,45

Frequency: Fmax

Temperature	Tmin	Tnom	Tmax
Power voltage: Vnom			
Frequency (MHz)	404,853	404,8538	404,852
Frequency Drift (ppm)	7,41	9,39	4,94

See graphics in annex 1

Result: **PASS**

Limit: → ± 100 ppm

4. EFFECTIVE RADIATED POWER, MAXIMUM TRANSMITTER POWER & ANTENNA POWER

4.1. TEST CONDITIONS

Test performed by : Julien BOUTAUD & Laurent DENEUX
Date of test : 2013/02/27 and 2013/03/04
Ambient temperature : 21°C
Relative humidity : 36%

4.2. TEST SETUP

FCC 95.639(f)
RSS 243 §5.4
ETSI EN 301 839-1 §8.3
Specified low-power radio equipment (Item 8 of Article 2 Paragraph 1 of Certification Ordinance)

The test is performed on EUT in permanent emission without modulation mode on vertically and horizontally position. The setup is 1.5m above the ground reference plane on a wooden table. Distance between measuring antenna and the EUT is 3 meters. The measuring antenna is in vertical and then in horizontal polarization. Measurement bandwidth was 100kHz. Continuous linear turntable azimuth search was performed with 360 degrees range.

The substitution method is used to obtain the effective isotropic radiated power and effective radiated power. (KDB 412172 D01 Determining ERP and EIRP)

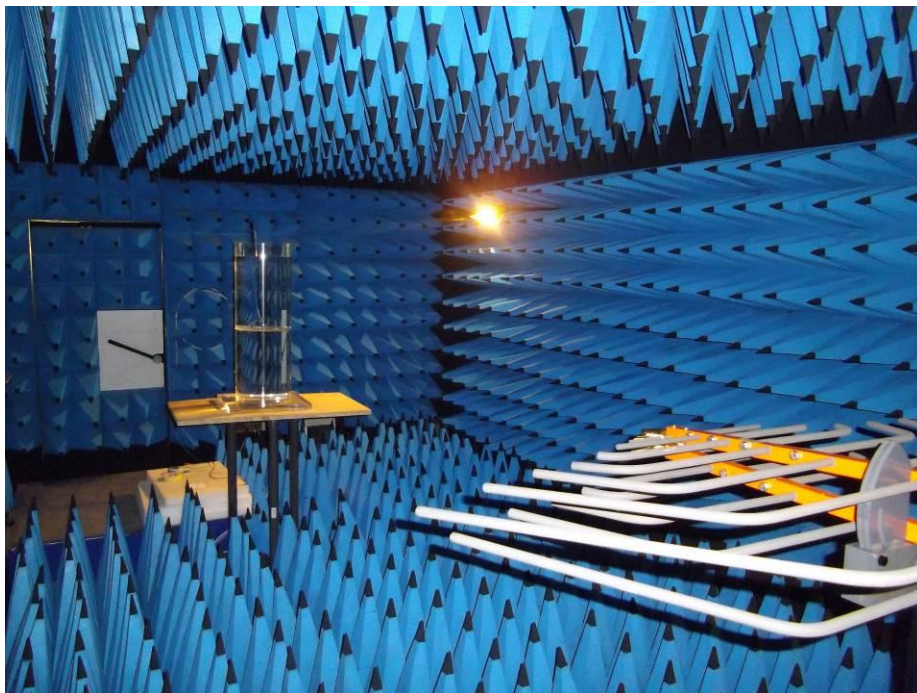

**4.3. RESULTS**

Maximum values for both polarizations:

Frequency (MHz)	Generator (dBm)	Cables loss (dB)	Attenuator (dB)	Antenna Gain (dBi)	ERP (dBm)	ERP (μ W)	EIRP (dBm)	EIRP (μ W)
Fmin	-17	1,6	10	-8.2	-38.94	0,1276	-36,80	0,2088
Fnom	-18.2	1,6	10	-8.17	-40.1	0,0977	-37,97	0,1596
Fmax	-18.6	1,65	10	-8.15	-40.53	0,0885	-38,39	0,1447

Result: **PASS**Limit: → 25 μ W or -16dBm

**5. EMISSION BANDWIDTH & OCCUPIED BANDWIDTH****5.1. TEST CONDITIONS**

Test performed by : Stéphane PHOUDIAH
Date of test : 2012/03/28
Ambient temperature : 25°C
Relative humidity : 30%

5.2. TEST SETUP

FCC 95.633(e)
RSS 243 §3.2
ETSI EN 301 839-1 §8.2
Specified low-power radio equipment (Item 8 of Article 2 Paragraph 1 of Certification Ordinance)

The test is performed on EUT in permanent emission with modulation. the Equipment Under Test is installed in the climatic chamber. A test fixture is created to perform the measurement. RBW was 3kHz and VBW was 10kHz. The Emission Bandwidth is measured 20dB below the peak power.

5.3. RESULTS

•

Frequency (MHz)	Emission Bandwidth (kHz)	Occupied Bandwidth (kHz)
Fmin	206,9	210,18
Fnom	206,9	205,33
Fmax	206,9	203,71

See graphics in annex 1

Result: **PASS**

Limit: → Shall not exceed 300kHz

**6. SPURIOUS EMISSIONS OF TRANSMITTER & TOLERANCE OF UNWANTED EMISSION INTENSITY****6.1. TEST CONDITIONS**

Test performed by : Julien BOUTAUD and Laurent DENEUX
Date of test : 2013/03/06 and 2013/02/27
Ambient temperature : 21°C
Relative humidity : 36%

6.2. TEST SETUP

ETSI EN 301 839-1 §8.2

Specified low-power radio equipment (Item 8 of Article 2 Paragraph 1 of Certification Ordinance)

The test is performed on EUT in permanent emission with modulation mode.

- **Method of measurement**

- Effective Radiated Power, cabinet radiation
- Effective Radiated Power, cabinet and antenna radiation

- **Qualification measurements on an open test site (25MHz to 1000MHz):**

The setup is 1.5m above the ground reference plane.

Distance between measuring antenna and the EUT is 10meters for frequency 25MHz to 1000MHz.

Test is performed in horizontal (H) and vertical (V) polarization with a bilog antenna. Measurement bandwidth was 100kHz. Continuous linear turntable azimuth search was performed with 360 degrees range. Vertical search was performed between 1m and 4m with the measuring antenna.

The Substitution Method is applied on the maximum values observed during the azimuth and vertical search in order to obtain the spurious radiated emission.

- **Qualification measurements in full anechoic chamber (1GHz to 4GHz):**

The setup is 1.5m above the ground reference plane.

Distance between measuring antenna and the EUT is 3meters for frequency 1GHz to 4GHz.

Test is performed in horizontal (H) and vertical (V) polarization with a logperiodic antenna. Measurement bandwidth was 1MHz. Continuous linear turntable azimuth search was performed with 360 degrees range.

The Normalized Site Attenuation (NSA) is added to the maximum values observed during the azimuth search in order to obtain the spurious radiated emission.

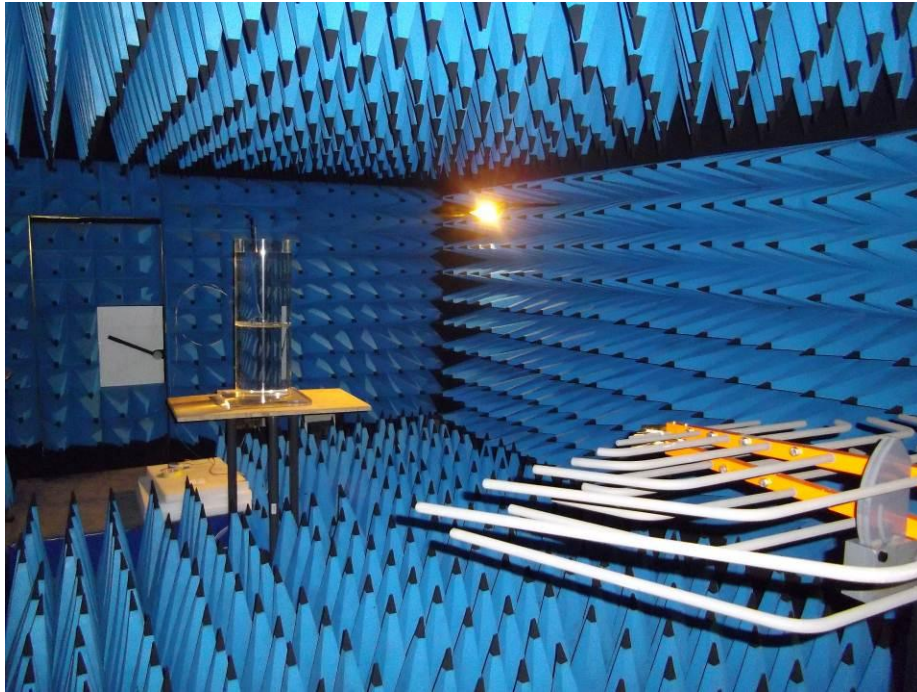

Test Set up for measurements in full anechoic chamber



Test Set up for measurements on an open test site

**6.3. RESULTS**

- Characterization on open test site (25MHz to 1000MHz):

Vertical antenna

Operating		
Frequency (MHz)	Measure E.R.P (dBm)	Limit (dBm)
32	-63	-36
34.7	-65	-36
36	-63	-36
39.5	-65	-36
41.6	-68	-36
50.4	-67	-36
60.9	-62	-36
115	-65	-36
120	-65	-36
131.1	-65	-36
144.3	-70	-54



Horizontal antenna

Operating		
Frequency (MHz)	Measure E.R.P (dBm)	Limit (dBm)
32	-67	-36
34.7	-68	-36
47.2	-69	-54
55.9	-68	-54
144.1	-66	-36
166	-64	-36
175.6	-65	-54

- **Characterization in full anechoic chamber (1000MHz to 4GHz):**

No spurious observed

Result: PASS

ETSI EN 301 839-1 §8.2

Limit: → 25MHz to 47MHz: -36dBm (operating)/ -57dBm (Standby)
47MHz to 74MHz: -54dBm (operating)/ -57dBm (Standby)
74MHz to 87,5MHz: -36dBm (operating)/ -57dBm (Standby)
87,5MHz to 118MHz: -54dBm (operating)/ -57dBm (Standby)
118MHz to 174MHz: -36dBm (operating)/ -57dBm (Standby)
174MHz to 230MHz: -54dBm (operating)/ -57dBm (Standby)
230MHz to 470MHz: -36dBm (operating)/ -57dBm (Standby)
470MHz to 862MHz: -54dBm (operating)/ -57dBm (Standby)
862MHz to 1GHz: -36dBm (operating)/ -57dBm (Standby)
1GHz to 4GHz: -30dBm (operating)/ -47dBm (Standby)

Specified low-power radio equipment (Item 8 of Article 2 Paragraph 1 of Certification Ordinance)

Limit: → -36dBm (operating)

See graphics in annex 1



7. UNWANTED RADIATION

7.1. TEST CONDITIONS

Test performed by : Laurent DENEUX
Date of test : 2012/03/20
Ambient temperature : 19°C
Relative humidity : 50%

7.2. TEST SETUP

FCC 95.635(d)
RSS 243 §3.4

The test is performed on EUT in permanent emission with modulation mode.

- **Method of measurement**

- Effective Radiated Power, cabinet radiation
- Effective Radiated Power, cabinet and antenna radiation

The setup is 1.5m above the ground reference plane.

Distance between measuring antenna and the EUT is 10 meters for frequency 30MHz to 25GHz.

Test is performed in horizontal (H) and vertical (V) polarization with a bilog antenna below 1GHz and with a horn antenna above 1GHz. Measurement bandwidth was 100kHz below 1GHz and 1MHz above 1GHz. Continuous linear turntable azimuth search was performed with 360 degrees range. Vertical and horizontal search was performed between 1m and 4m with the measuring antenna.

7.3. RESULTS

Out-Of-Band Emissions

- Characterization on open test site (30MHz to 25GHz):

Fcc Part.15 CLASS B

SORIN
 IMPLANT
 MODEL : INTENSIA DR 154 – VVED-DDDR
 400 Tx

Quasi peak measurement

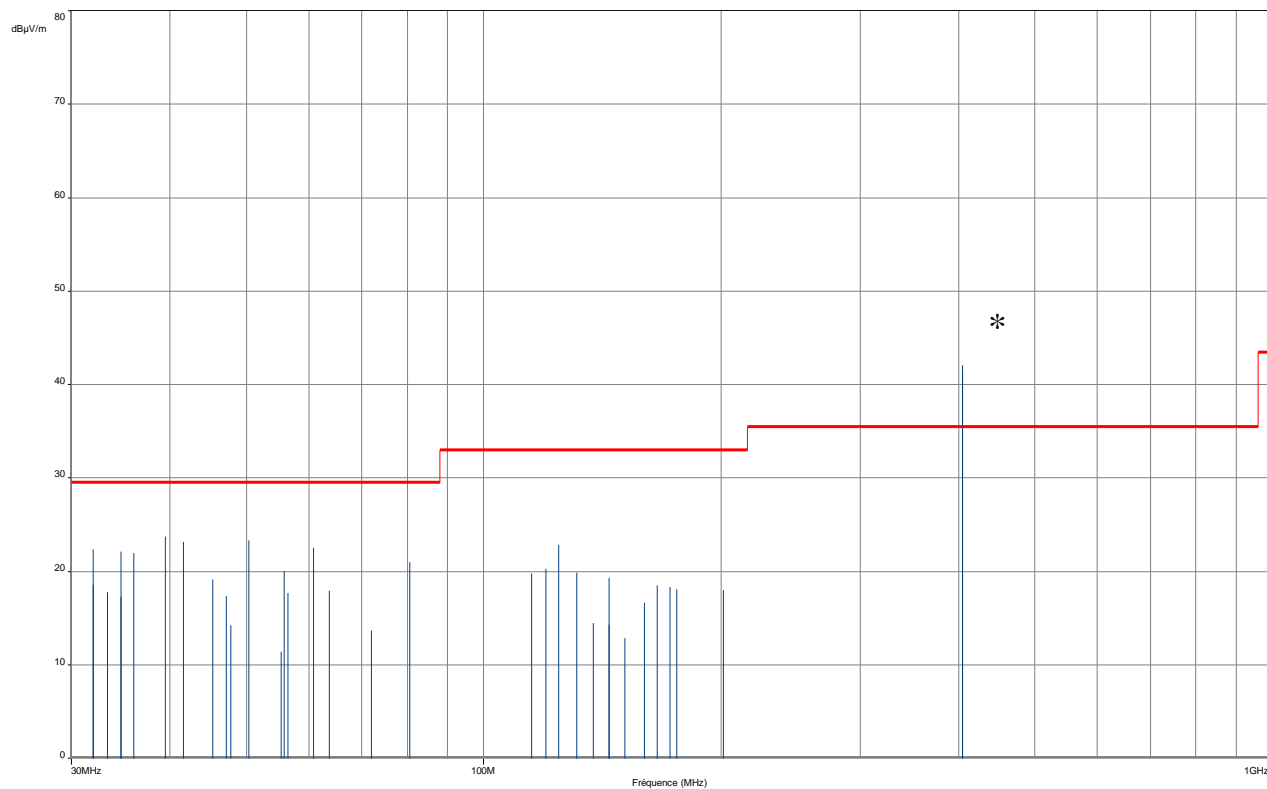

Limit level

* Transmitter frequency

Remark: During the Scan, no unwanted emission has been detected in the frequency range 1 GHz to 25 GHz.

Result: PASS

Limit: → 30MHz to 88MHz: 29.5dBµV/m at 10m ($20\log(100\mu\text{V/m}) + 20\log(3\text{m}/10\text{m})$)
 88MHz to 216MHz: 33dBµV/m at 10m ($20\log(150\mu\text{V/m}) + 20\log(3\text{m}/10\text{m})$)
 216MHz to 960MHz: 35.5dBµV/m at 10m ($20\log(200\mu\text{V/m}) + 20\log(3\text{m}/10\text{m})$)
 Above 960MHz: 43.5dBµV/m at 10m ($20\log(500\mu\text{V/m}) + 20\log(3\text{m}/10\text{m})$)



8. RECEIVER SPURIOUS RADIATION & SECONDARY RADIATED EMISSION

8.1. TEST CONDITIONS

Test performed by : Julien BOUTAUD and Laurent DENEUX
Date of test : 2013/03/06 and 2013/02/27
Ambient temperature : 21°C
Relative humidity : 36%

8.2. TEST SETUP

ETSI EN 301 839-1 §9.1

Specified low-power radio equipment (Item 8 of Article 2 Paragraph 1 of Certification Ordinance)

The test is performed on EUT in reception mode.

- **Method of measurement**

- Effective Radiated Power, cabinet radiation
- Effective Radiated Power, cabinet and antenna radiation

- **Qualification measurements on an open test site (25MHz to 1000MHz):**

The setup is 1.5m above the ground reference plane.

Distance between measuring antenna and the EUT is 10 meters for frequency 25MHz to 1000MHz.

Test is performed in horizontal (H) and vertical (V) polarization with a bilog antenna. Measurement bandwidth was 100kHz. Continuous linear turntable azimuth search was performed with 360 degrees range. Vertical search was performed between 1m and 4m with the measuring antenna.

The Substitution Method is applied on the maximum values observed during the azimuth and vertical search in order to obtain the spurious radiated emission.

- **Qualification measurements in full anechoic chamber (1GHz to 4GHz):**

The setup is 1.5m above the ground reference plane.

Distance between measuring antenna and the EUT is 3meters for frequency 1GHz to 4GHz.

Test is performed in horizontal (H) and vertical (V) polarization with a logperiodic antenna. Measurement bandwidth was 100kHz. Continuous linear turntable azimuth search was performed with 360 degrees range.

The Normalized Site Attenuation (NSA) is added to the maximum values observed during the azimuth search in order to obtain the spurious radiated emission.

8.3. RESULTS

- Characterization on open test site (25MHz to 1000MHz):

Vertical antenna

Operating		
Frequency (MHz)	Measure E.R.P (dBm)	Limit (dBm)
32	-65	-57
33.3	-67	-57
34.7	-63	-57
36	-63	-57
39.5	-64	-57
41.6	-63	-57
45.3	-66	-57
47.8	-71	-57
50.4	-63	-57
60.9	-62	-57
63.7	-67	-57
72	-71	-57
80.6	-64	-57
115	-65	-57
120	-65	-57
131.1	-65	-57
144.3	-70	-57
151	-72	-57
172.4	-66	-57
201.3	-67	-57



Horizontal antenna

Operating		
Frequency (MHz)	Measure E.R.P (dBm)	Limit (dBm)
32	-65	-57
34.7	-66	-57
175.6	-67	-57

- **Characterization in full anechoic chamber (1GHz to 4GHz):**

No spurious observed

Limit: → -57dBm below 1000 MHz
-47dBm above 1000 MHz

Specified low-power radio equipment (Item 8 of Article 2 Paragraph 1 of Certification Ordinance)

Limit: → -54dBm

Result: **PASS**

See graphics in annex 1



9. RADIATION EMISSIONS

9.1. TEST CONDITIONS

Test performed by : Laurent DENEUX
Date of test : 2012/02/27
Ambient temperature : 19°C
Relative humidity : 50%

9.2. TEST SETUP

FCC 15.109
RSS 243 §3.5

The test is performed on EUT in reception mode.

- **Method of measurement**

- Effective Radiated Power, cabinet radiation
- Effective Radiated Power, cabinet and antenna radiation

- **Qualification measurements on an open test site (30MHz to 25GHz):**

The setup is 1.5m above the ground reference plane.

Distance between measuring antenna and the EUT is 10 meters for frequency 30MHz to 25GHz.

Test is performed in horizontal (H) and vertical (V) polarization with a bilog antenna below 1GHz and with 2 horn antenna above 1GHz. Measurement bandwidth was 100kHz below 1GHz and 1MHz above 1GHz. Continuous linear turntable azimuth search was performed with 360 degrees range. Vertical and horizontal search was performed between 1m and 4m with the measuring antenna.

9.3. RESULTS

• **Characterization on open test site (30MHz to 25GHz):**

Fcc Part.15 CLASS B

SORIN
 IMPLANT
 MODEL : INTENSIA DR 154 – VVED-DDDR
 400 Rx mode

Quasi peak measurement

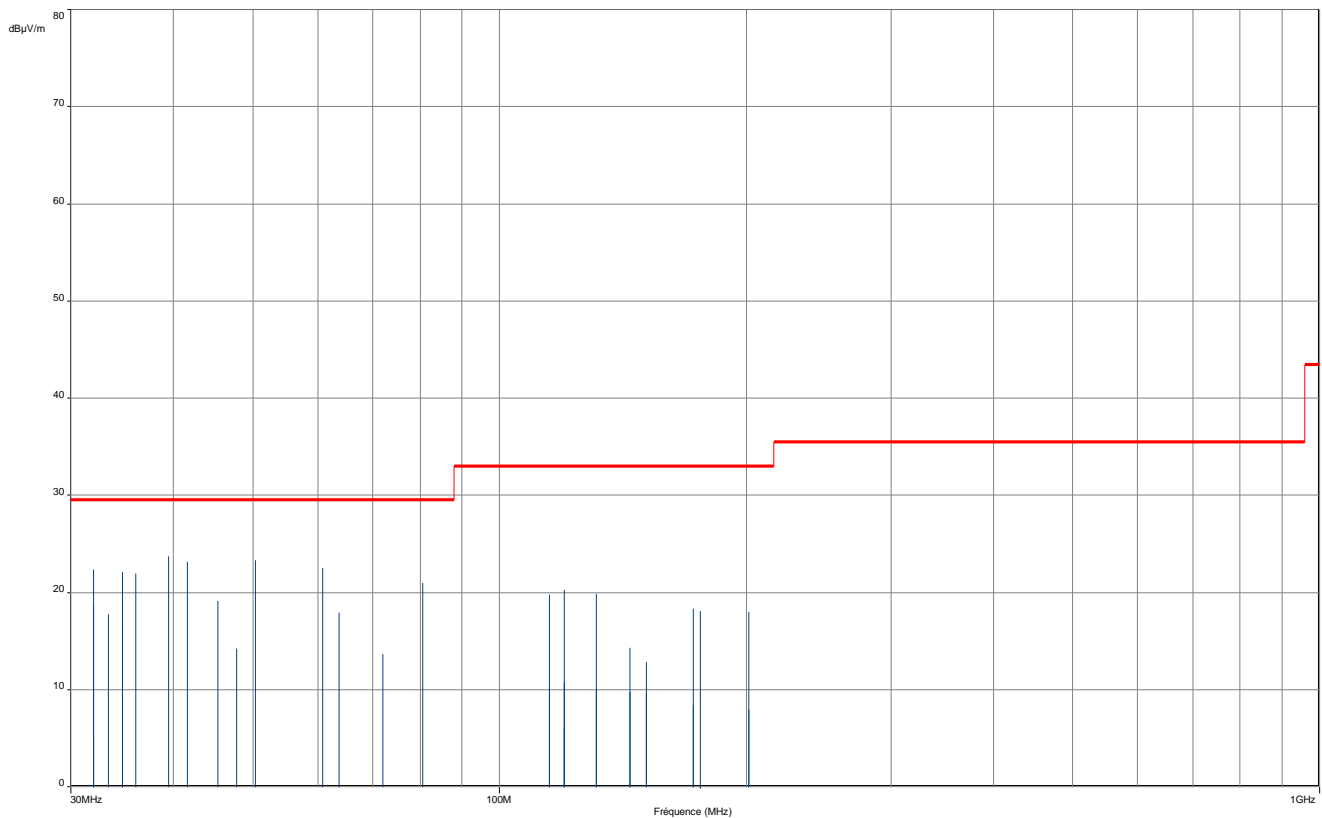

— Limit level

Remark: During the Scan, no radiated emission has been detected in the frequency range 1 GHz to 25 GHz.

Result: PASS

Limit: → 30MHz to 88MHz: $29.5 \text{ dB}\mu\text{V/m}$ at 10m ($20 \log (100\mu\text{V/m}) + 20 \log (3\text{m}/10\text{m})$)
 88MHz to 216MHz: $33 \text{ dB}\mu\text{V/m}$ at 10m ($20 \log (150\mu\text{V/m}) + 20 \log (3\text{m}/10\text{m})$)
 216MHz to 960MHz: $35.5 \text{ dB}\mu\text{V/m}$ at 10m ($20 \log (200\mu\text{V/m}) + 20 \log (3\text{m}/10\text{m})$)
 Above 960MHz: $43.5 \text{ dB}\mu\text{V/m}$ at 10m ($20 \log (500\mu\text{V/m}) + 20 \log (3\text{m}/10\text{m})$)



10. TEST EQUIPMENT LIST

Test	Apparatus	Trade Mark	Type	Registration number
Effective Radiated Power Of The Fundamental Emission, Maximum Transmitter Power, Antenna Power				
X	Full anechoic chamber	SIEPEL	S36	D3044019
X	Logperiodic antenna	AMPLIFIER RESEARCH	ATR80M6G	C2040149
X	EMI Test Receiver	ROHDE & SCHWARZ	ESMI	A2642009
X	Signal Generator	ROHDE & SCHWARZ	SMIQ03b	A5442039
X	Substitution Cable	-	CNJ01	A5329393
X	Substitution Cable	-	CNS1E 04	A5329434
X	Dipole Antenna	SCHWARZBECK	VHAP	C2040020
X	Dipole Antenna	SCHWARZBECK	UHAP	C2040022
Transmitter Spurious Emissions & Unwanted Radiation				
X	Full anechoic chamber	SIEPEL	S36	D3044019
X	EMI Test Receiver	ROHDE & SCHWARZ	ESMI	A2642009
X	Preamplifier	BONN Elektronik	BLNA 3018-8F30S	A7080053
X	Horn Antenna	A.H. SYSTEMS	SAS-571	C2042041
X	Logperiodic antenna	AMPLIFIER RESEARCH	ATR80M6G	C2040149
X	Open test site	LCIE	-	F2000400
X	EMI Test Receiver	ROHDE & SCHWARZ	ESCI	A2642017
X	Bilog antenna	CHASE	CBL 6112A	C2040040
X	Dipole	ROHDE & SCHWARZ	HUF-Z1	C2040011
X	Logperiodic antenna	ROHDE & SCHWARZ	HL 023 A2	C2040001
X	Horn antenna	EMCO	3115	C2042016
X	Horn antenna	AH SYSTEMS	SAS-572	C2042026
X	Signal Generator	ROHDE & SCHWARZ	SMY02	A5442014
Receiver Spurious Emissions & Radiated Emissions				
X	Full anechoic chamber	SIEPEL	S36	D3044019
X	EMI Test Receiver	ROHDE & SCHWARZ	ESCI	A2642017
X	Preamplifier	BONN Elektronik	BLNA 3018-8F30S	A7080053
X	Horn Antenna	A.H. SYSTEMS	SAS-571	C2042041
X	Logperiodic antenna	AMPLIFIER RESEARCH	ATR80M6G	C2040149
X	Open test site	LCIE	-	F2000400
X	Bilog antenna	CHASE	CBL 6112A	C2040040
X	Dipole	ROHDE & SCHWARZ	HUF-Z1	C2040011
X	Logperiodic antenna	ROHDE & SCHWARZ	HL 023 A2	C2040001
X	Horn antenna	EMV	3115	C2040023
X	Horn antenna	EMCO	3115	C2042016
X	Signal Generator	ROHDE & SCHWARZ	SMY02	A5442014
X	Horn antenna	AH SYSTEMS	SAS-572	C2042026
Emission Bandwidth, Occupied Bandwidth, Band-Edge Emissions, In-Band Emissions				
X	Antenna	KATHREIN	-	-
X	Climatic Chamber	SECASI Technologies	SLT-34	D1024029
X	Spectrum Analyser	ROHDE & SCHWARZ	FSL	A4060032
Frequency error & Frequency stability				
X	Spectrum Analyser	ROHDE & SCHWARZ	FSL	A4060032
X	Antenna	KATHREIN	-	-
X	Climatic Chamber	SECASI Technologies	SLT-34	D1024029



11. UNCERTAINTIES CHART

	Measurement uncertainties (k=2) ±x(dB) / (Hz)	Limit for uncertainties ±y(dB)
TRANSMITTER REQUIREMENTS		
Frequency Error	±2.10 ⁻⁸ Hz	±1.10 ⁻⁷ Hz
Modulation Bandwidth	± 100 kHz	-
Effective Radiated Power	±3.9 dB	±6 dB
Adjacent Channel Power	±1.6 dB	±3 dB
Spurious emissions <ul style="list-style-type: none"> • Frequency < 1000 MHz • Frequency > 1000 MHz 	±3.9 dB ±3.1 dB	±6 dB
Conducted power	±0.6 dB	±1.5 dB
Spectral density in conduction	±0.6 dB	±1.5 dB
Spurious emissions in conduction	±1.6 dB	±3 dB
Temperature	±0.5°C	±1°C
Humidity	±2.5 %	±5 %
RECEIVER REQUIREMENTS		
Spurious emissions <ul style="list-style-type: none"> • Frequency < 1000 MHz • Frequency > 1000 MHz 	±3.9 dB ±3.1 dB	±6 dB
Spurious emissions in conduction	±0.6 dB	±3 dB

12. ANNEX 1 (GRAPHS)

Frequency: Fmin
 Frequency error
 Temperature: Tmin
 Voltage: Vnom



Att 0 dB * RBW 1 kHz **M1[1]** **-45.38 dBm**
 Ref -20.0 dBm * VBW 3 kHz **402.15000000 MHz**
 SWT 100ms

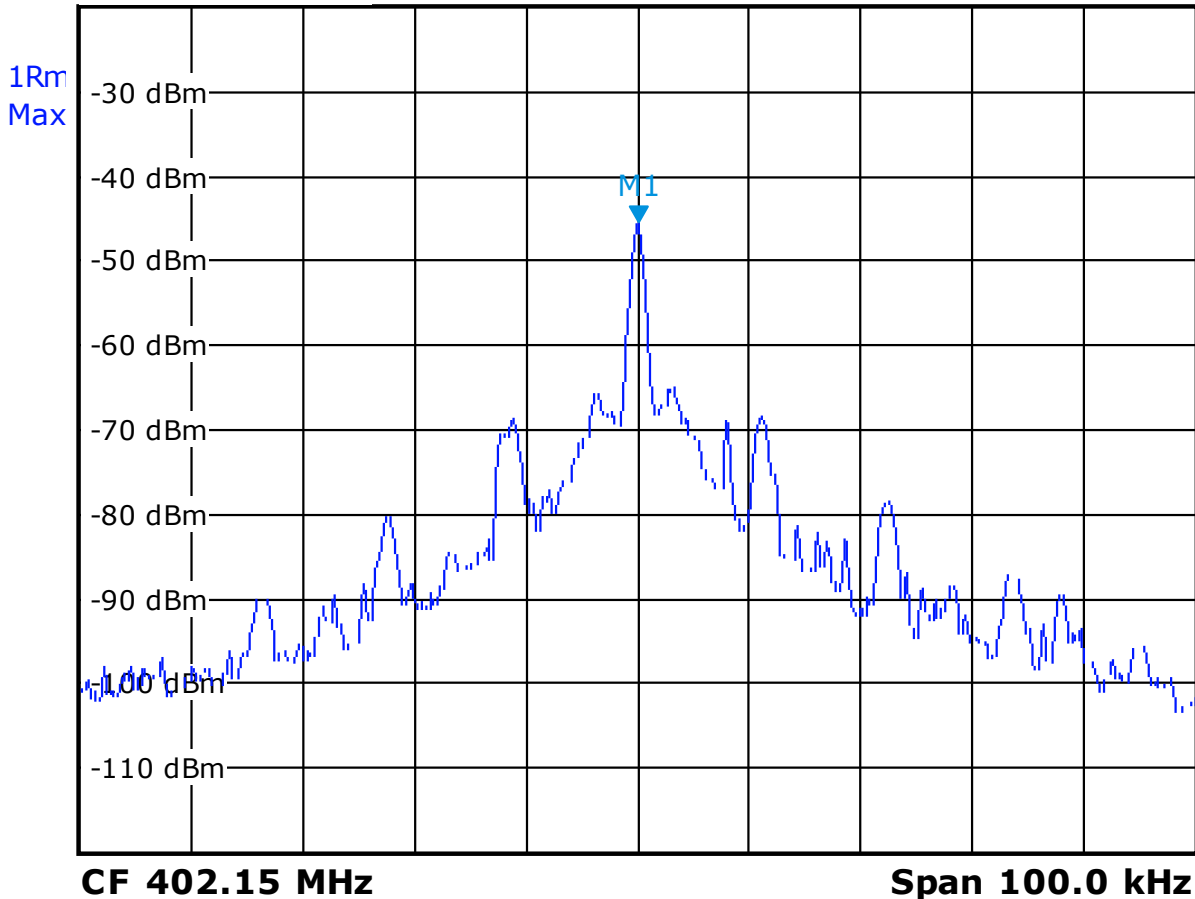

Date: 30.MAR.2012 10:43:55



Frequency: Fmin
Frequency error
Temperature: Tnom
Voltage: Vnom



* RBW 1 kHz

* VBW 3 kHz

Att 0 dB

Ref -20.0 dBm

SWT 100ms

M1[1]

-48.60 dBm

402.147410000 MHz

1Rm
Max

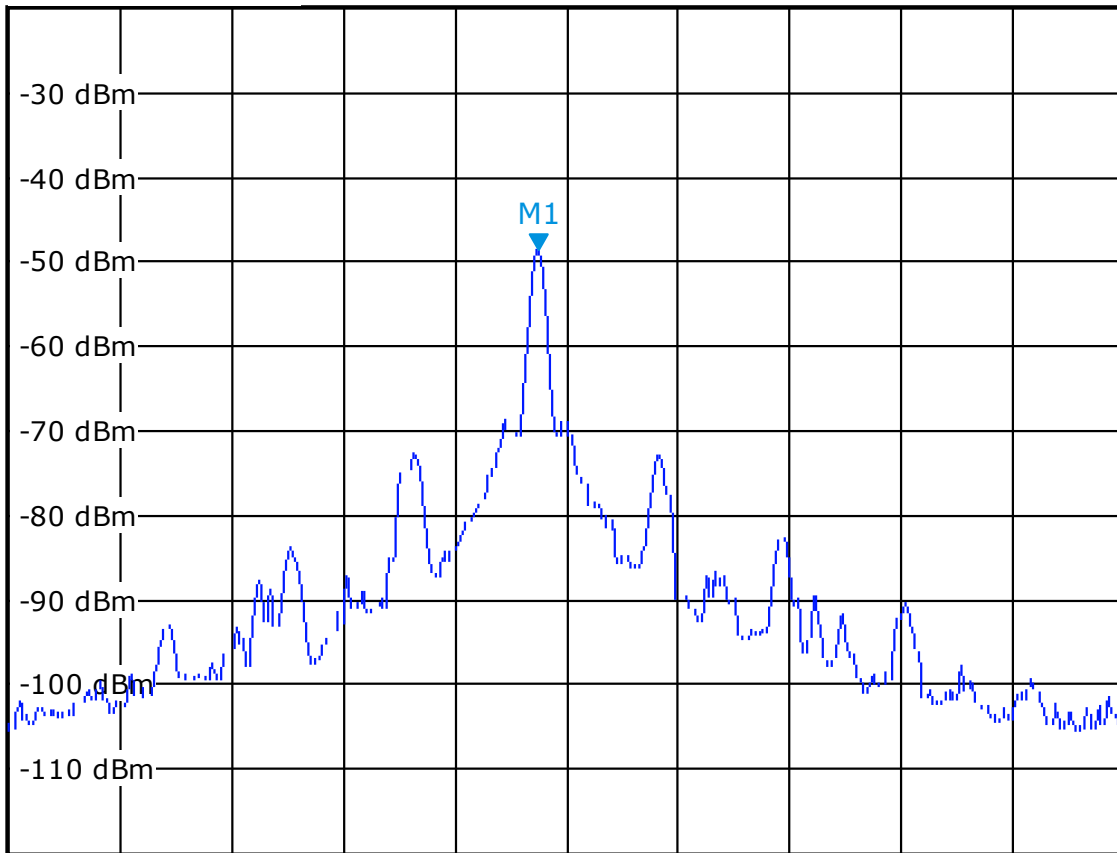

CF 402.15 MHz

Span 100.0 kHz



Frequency: Fmin
Frequency error
Temperature: Tmax
Voltage: Vnom



* RBW 1 kHz

* VBW 3 kHz

Att 0 dB

Ref -20.0 dBm

SWT 100ms

M1[1]

-46.55 dBm

402.15020000 MHz

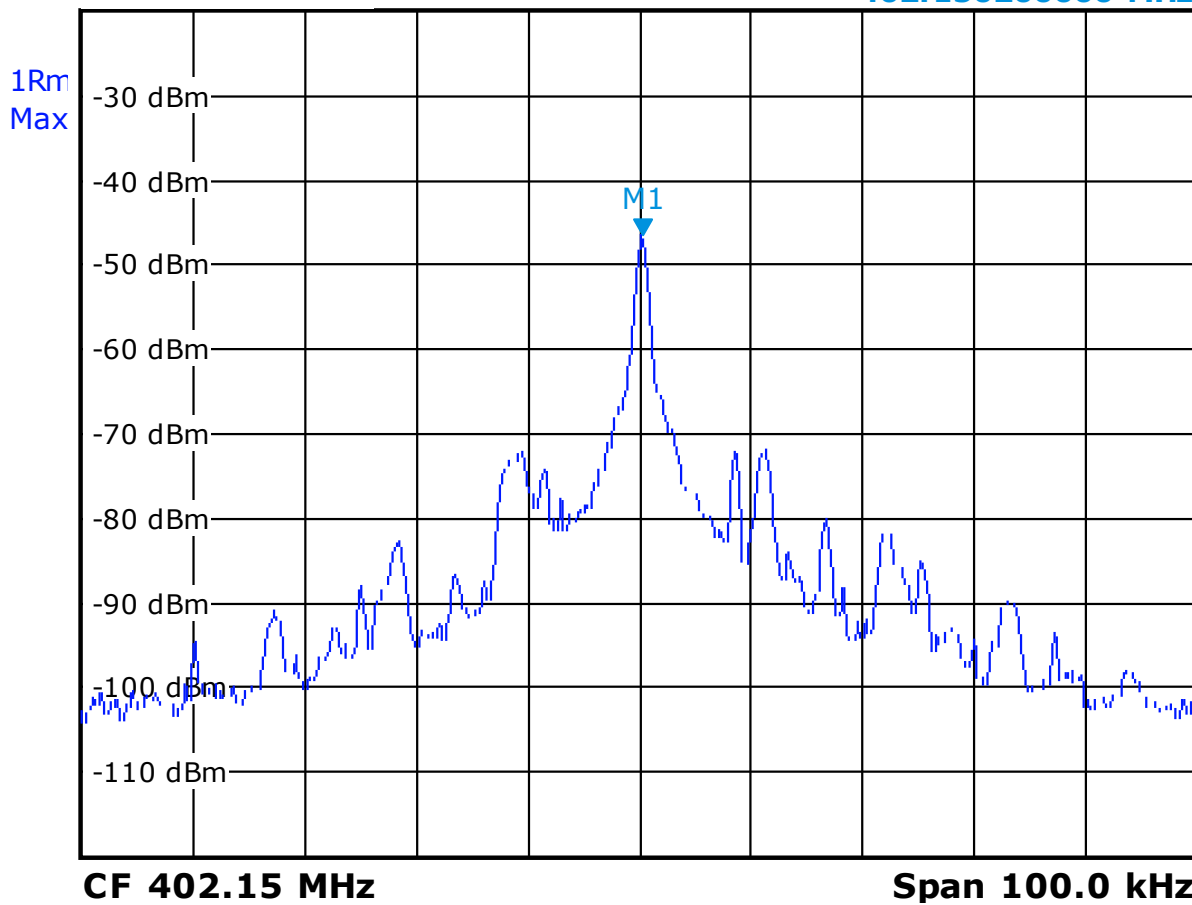



Frequency: Fnom
Frequency error
Temperature: Tmin
Voltage: Vnom



* RBW 1 kHz

* VBW 3 kHz

Att 0 dB

Ref -20.0 dBm

SWT 100ms

M1[1]

-45.29 dBm

403.65279000 MHz

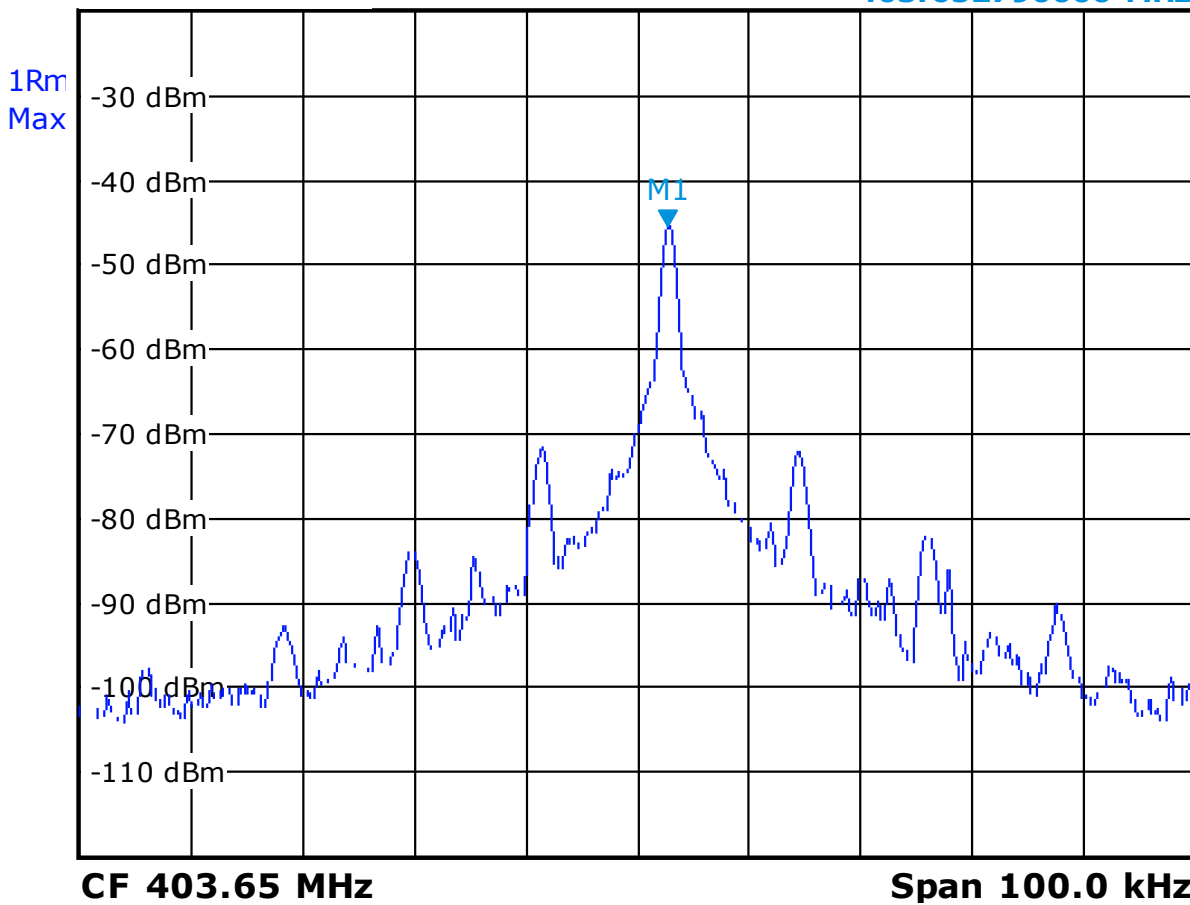

Date: 30.MAR.2012 10:33:10



Frequency: Fnom
Frequency error
Temperature: Tnom
Voltage: Vnom



* RBW 1 kHz

* VBW 3 kHz

Att 0 dB

Ref -20.0 dBm

SWT 100ms

M1[1]

-46.90 dBm

403.65040000 MHz

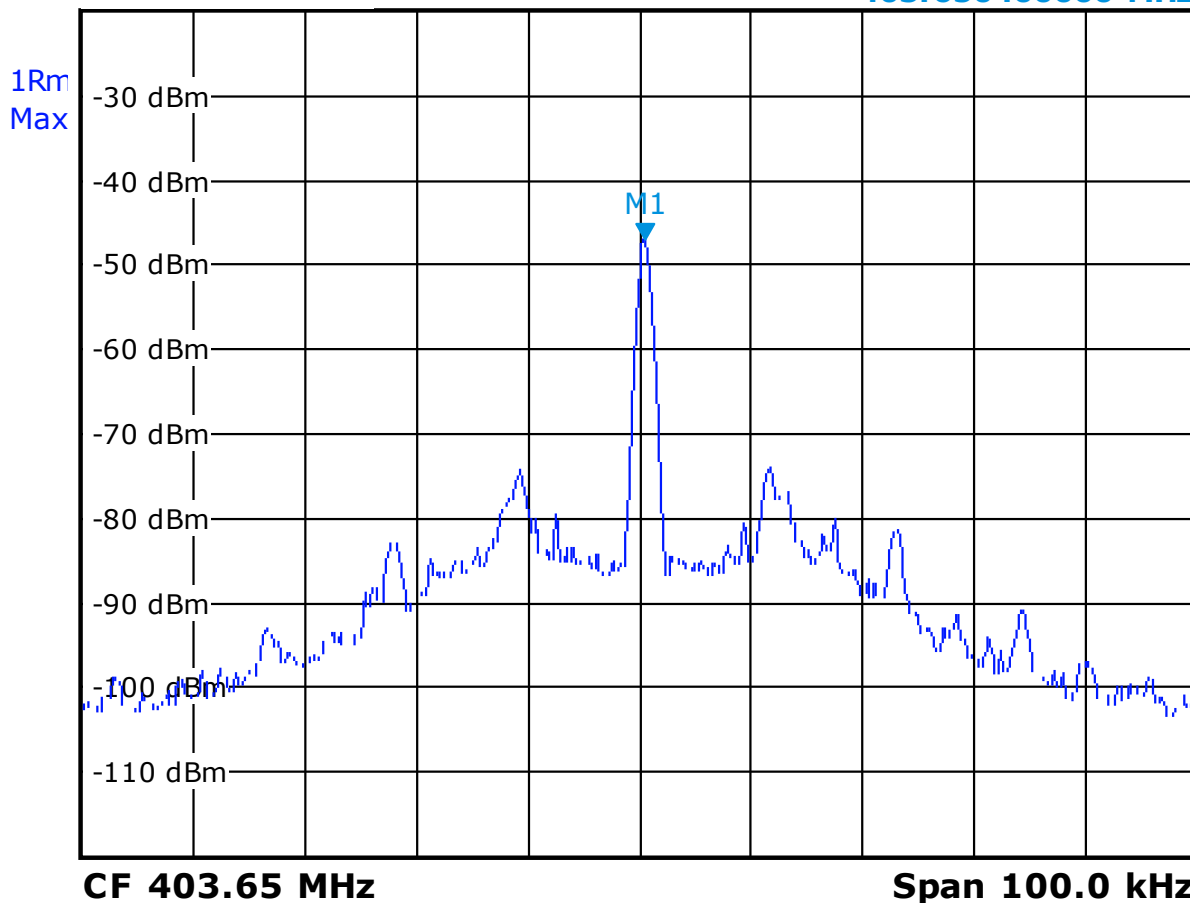



Frequency: Fnom
Frequency error
Temperature: Tmax
Voltage: Vnom



* RBW 1 kHz

* VBW 3 kHz

Att 0 dB

Ref -20.0 dBm

SWT 100ms

M1[1]

-45.52 dBm

403.65220000 MHz

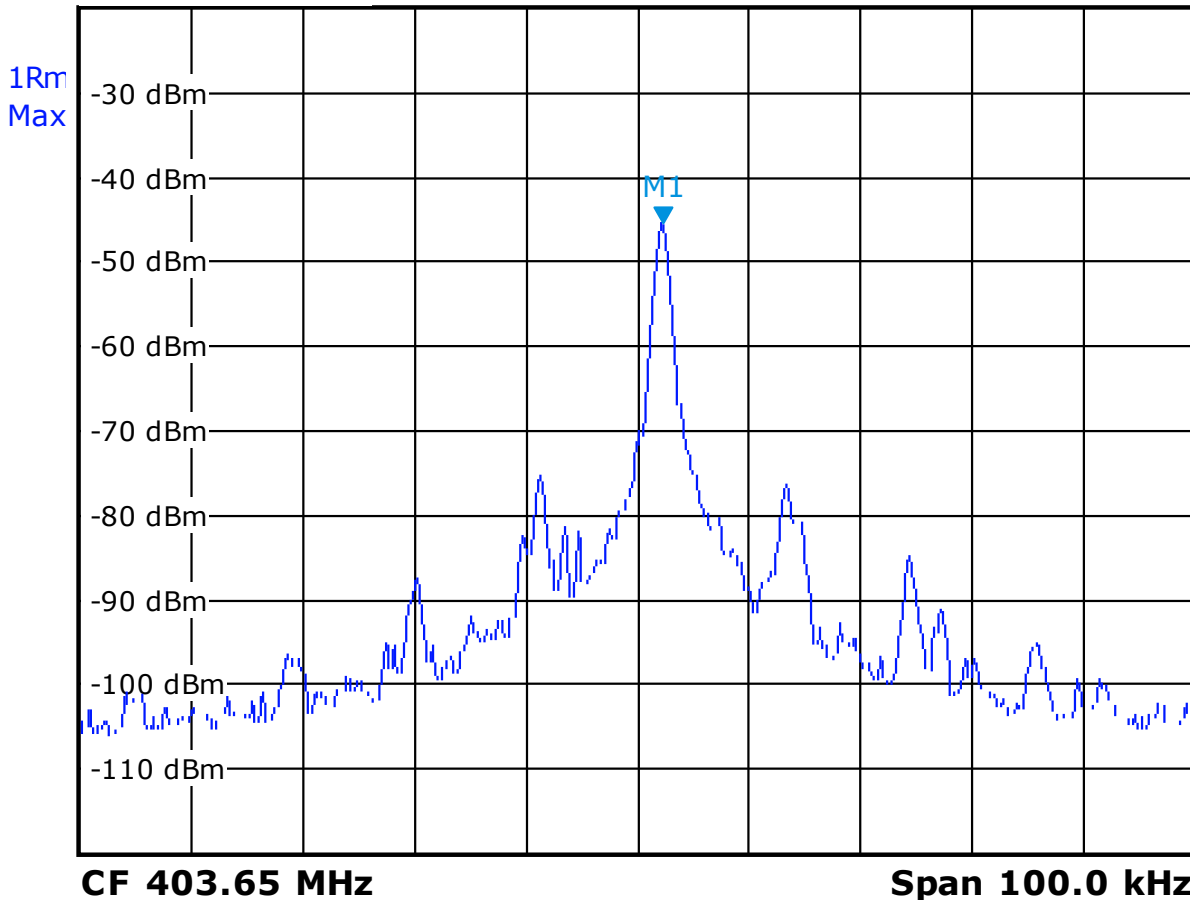

Date: 30.MAR.2012 16:40:41



Frequency: Fmax
Frequency error
Temperature: Tmin
Voltage: Vnom



Att 0 dB * RBW 1 kHz **M1[1]** **-45.36 dBm**
Ref -20.0 dBm * VBW 3 kHz **404.85299000 MHz**
SWT 100ms

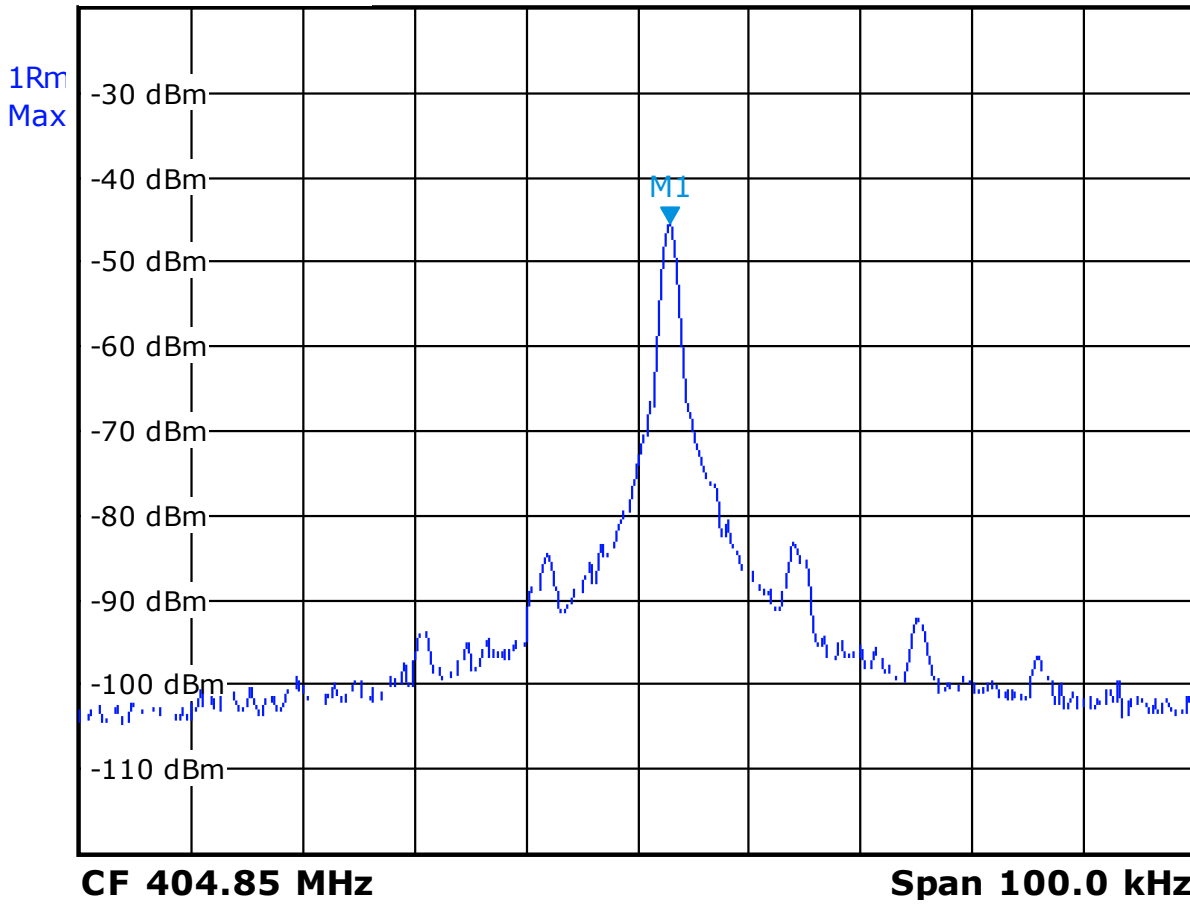

Date: 30.MAR.2012 10:29:33



Frequency: Fmax
Frequency error
Temperature: Tnom
Voltage: Vnom



Att 0 dB * RBW 1 kHz
Ref -20.0 dBm * VBW 3 kHz **M1[1]** **-46.40 dBm**
SWT 100ms **404.85379000 MHz**

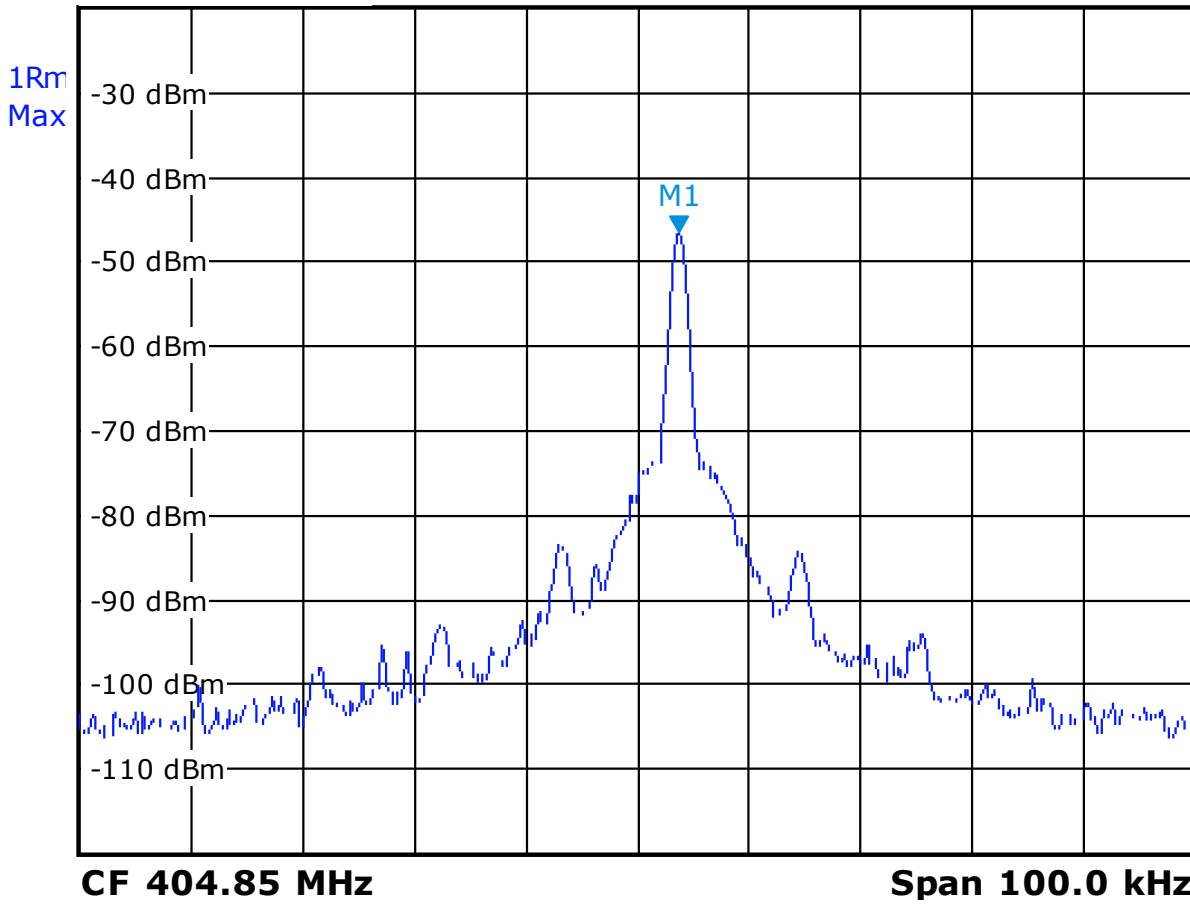

Date: 30.MAR.2012 15:26:09



Frequency: Fmax
Frequency error
Temperature: Tmax
Voltage: Vnom



Att 0 dB * RBW 1 kHz
Ref -20.0 dBm * VBW 3 kHz **M1[1]** **-45.64 dBm**
SWT 100ms **404.85200000 MHz**

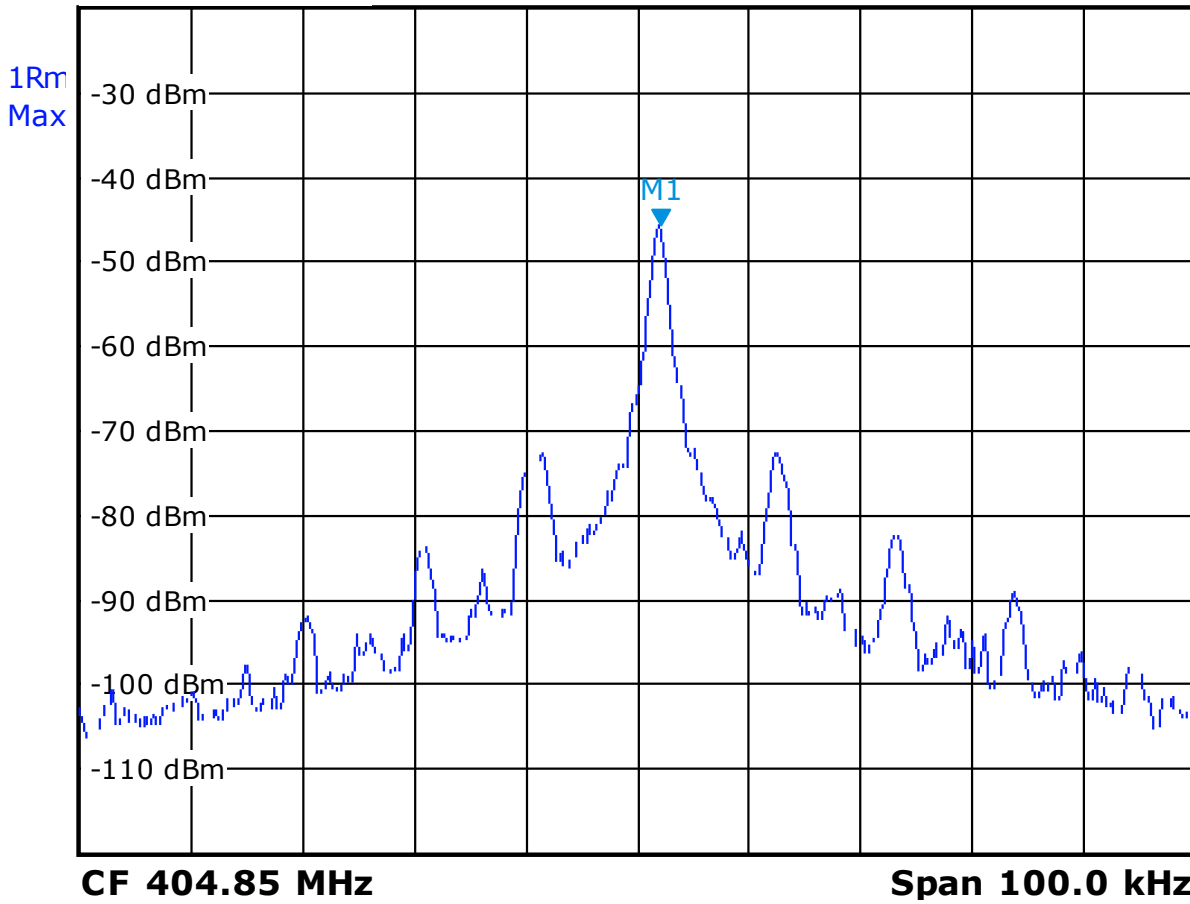

Date: 30.MAR.2012 16:32:02

Frequency: Fmin
 Emission Bandwidth
 Band-Edge Emissions
 In-Band Emissions

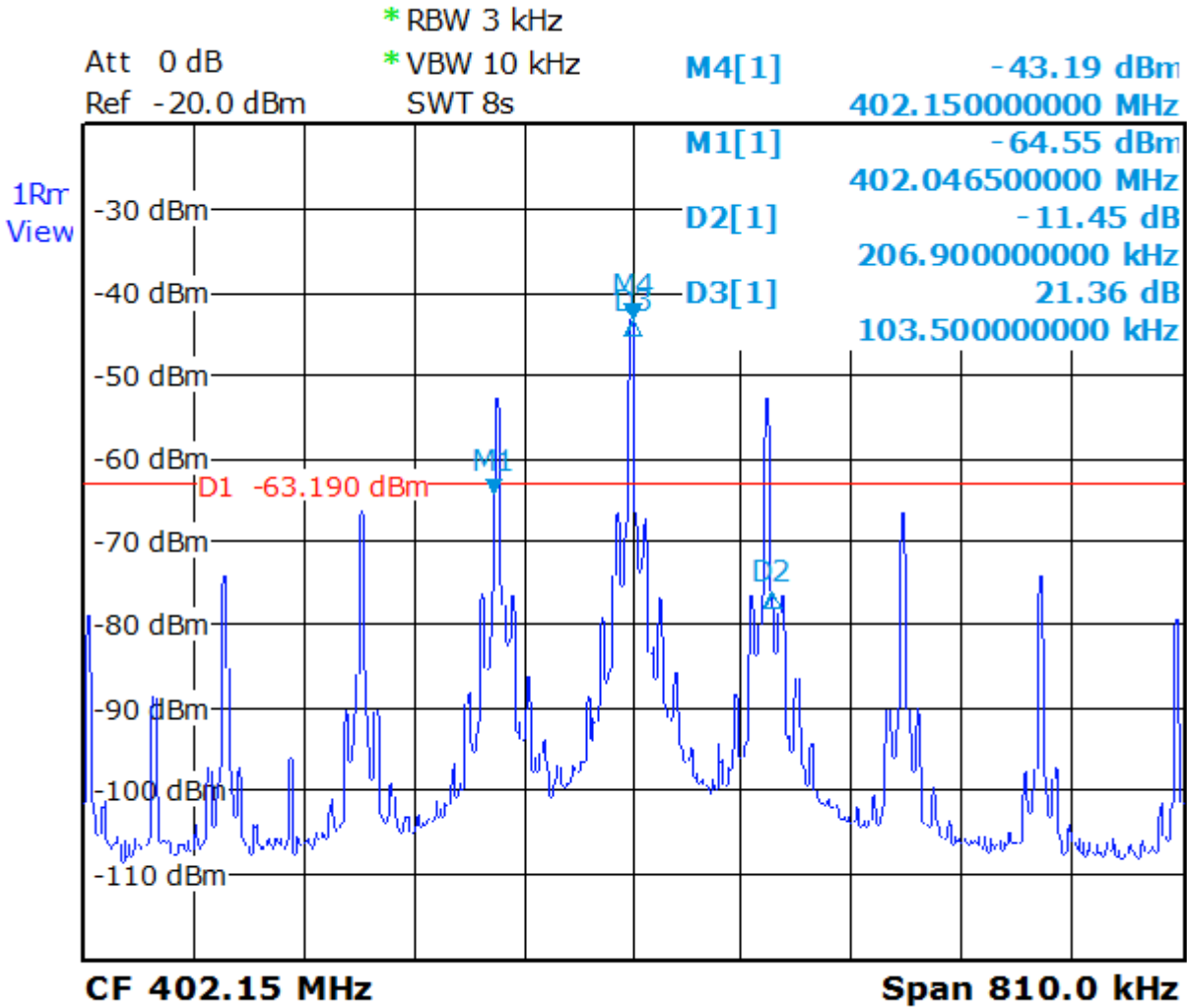

Date: 29.MAR.2012 14:20:33

Frequency: From
Emission Bandwidth
In-Band Emissions

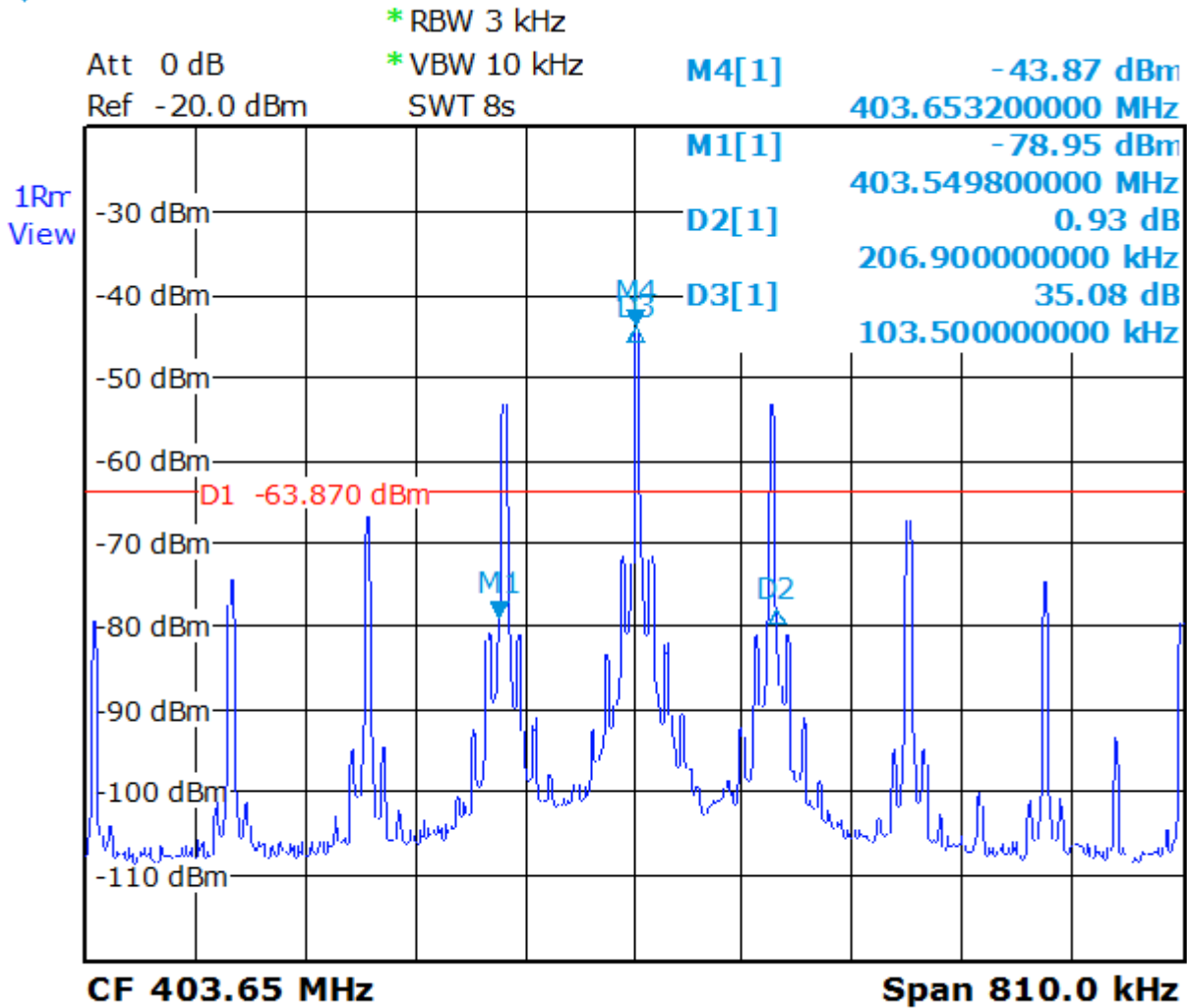

Date: 29.MAR.2012 14:28:58

Frequency: Fmax
 Emission Bandwidth
 Band-Edge Emissions
 In-Band Emission

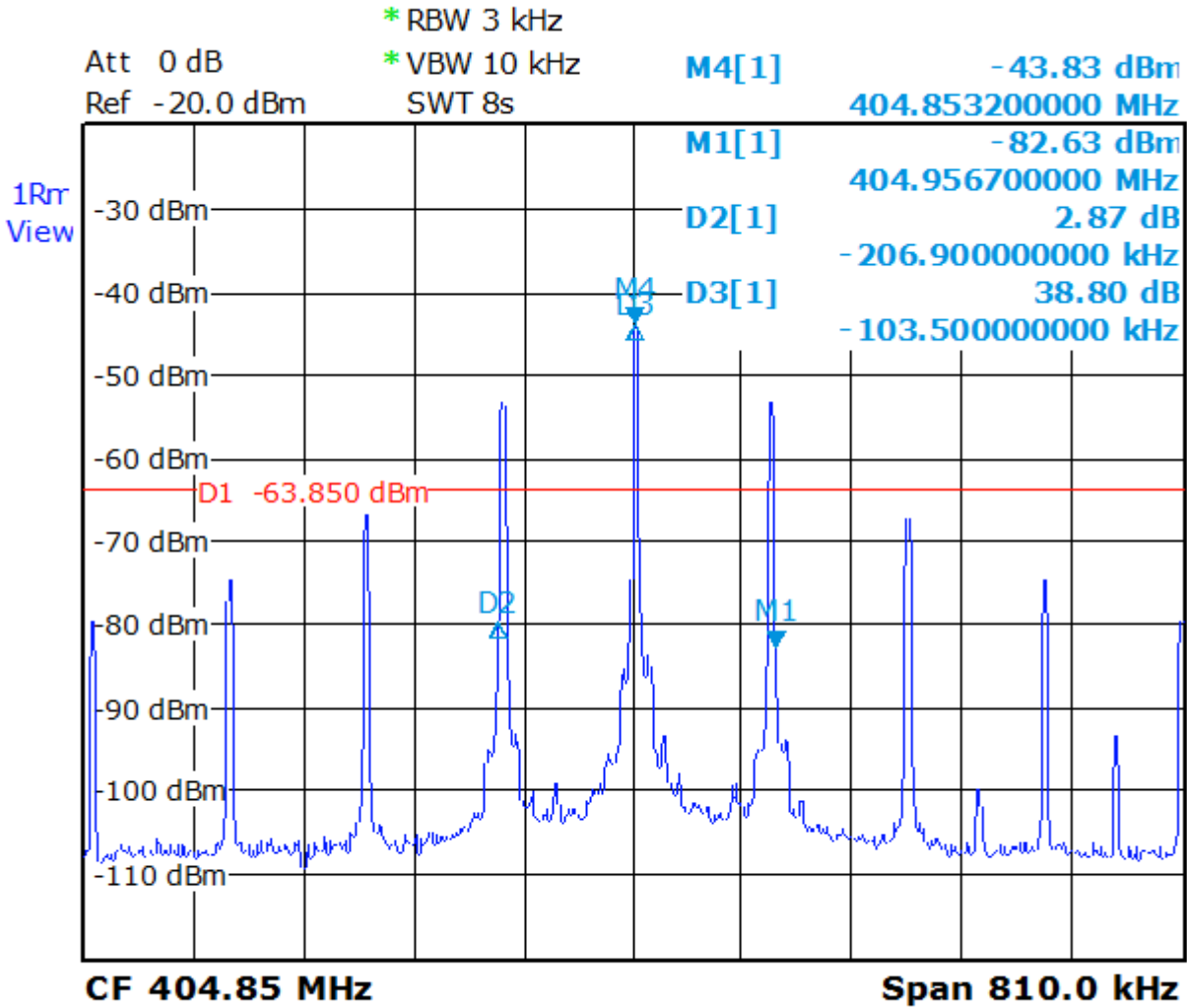

Date: 29.MAR.2012 14:12:25

Frequency: Fmin
Occupied Bandwidth

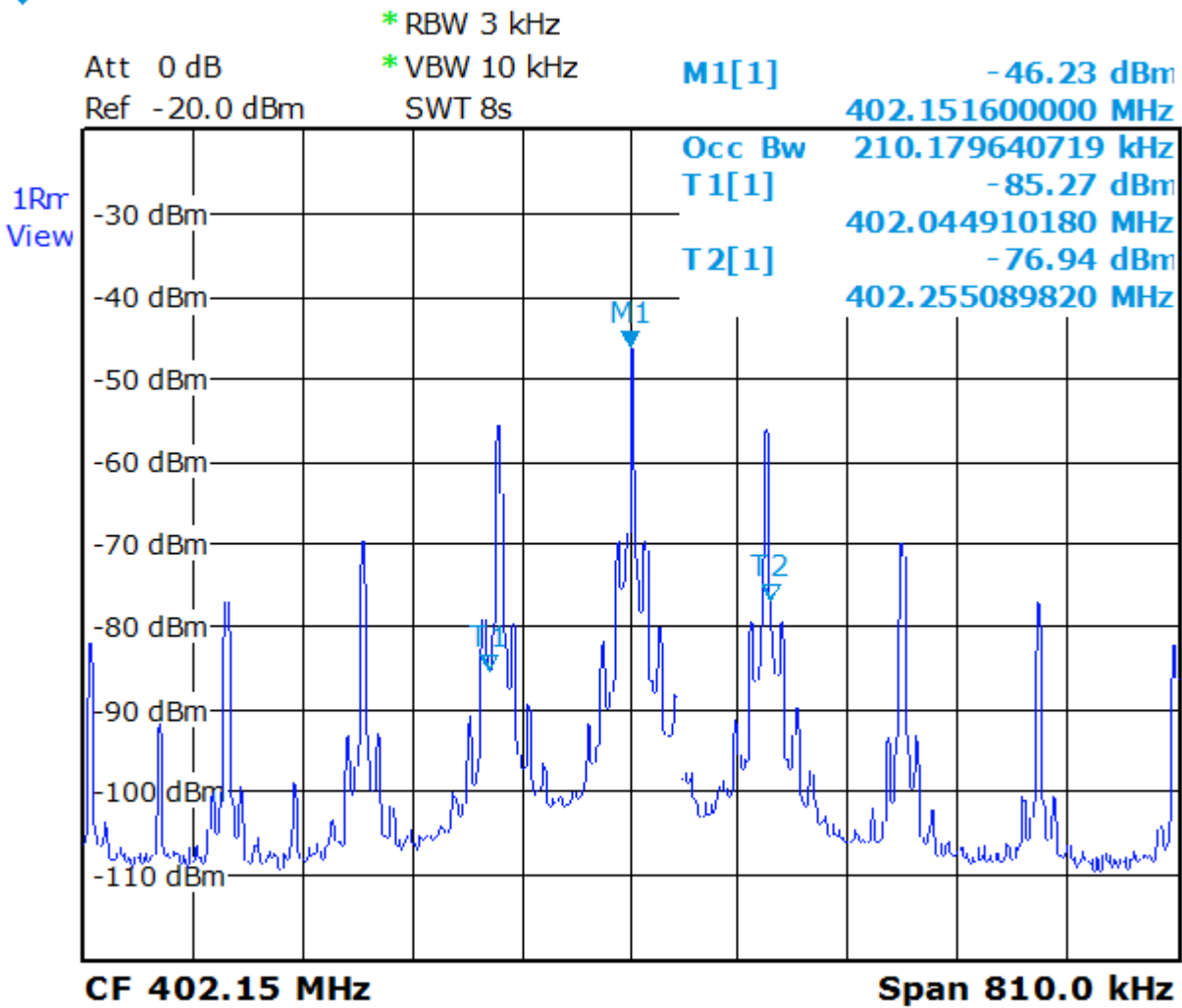

Date: 29.MAR.2012 13:45:01



Frequency: From
Occupied Bandwidth

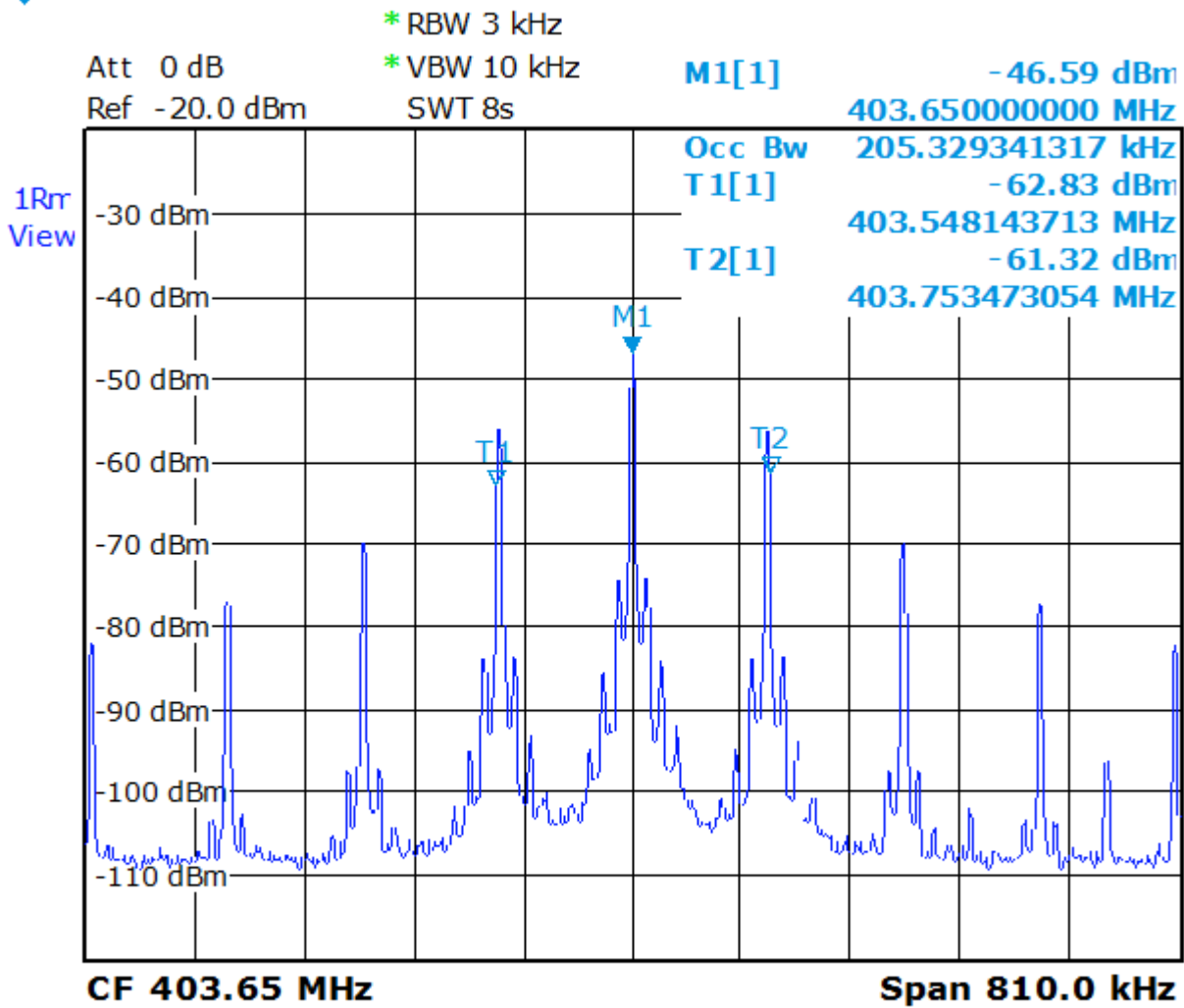

Date: 29.MAR.2012 13:40:11



Frequency: Fmax
Occupied Bandwidth

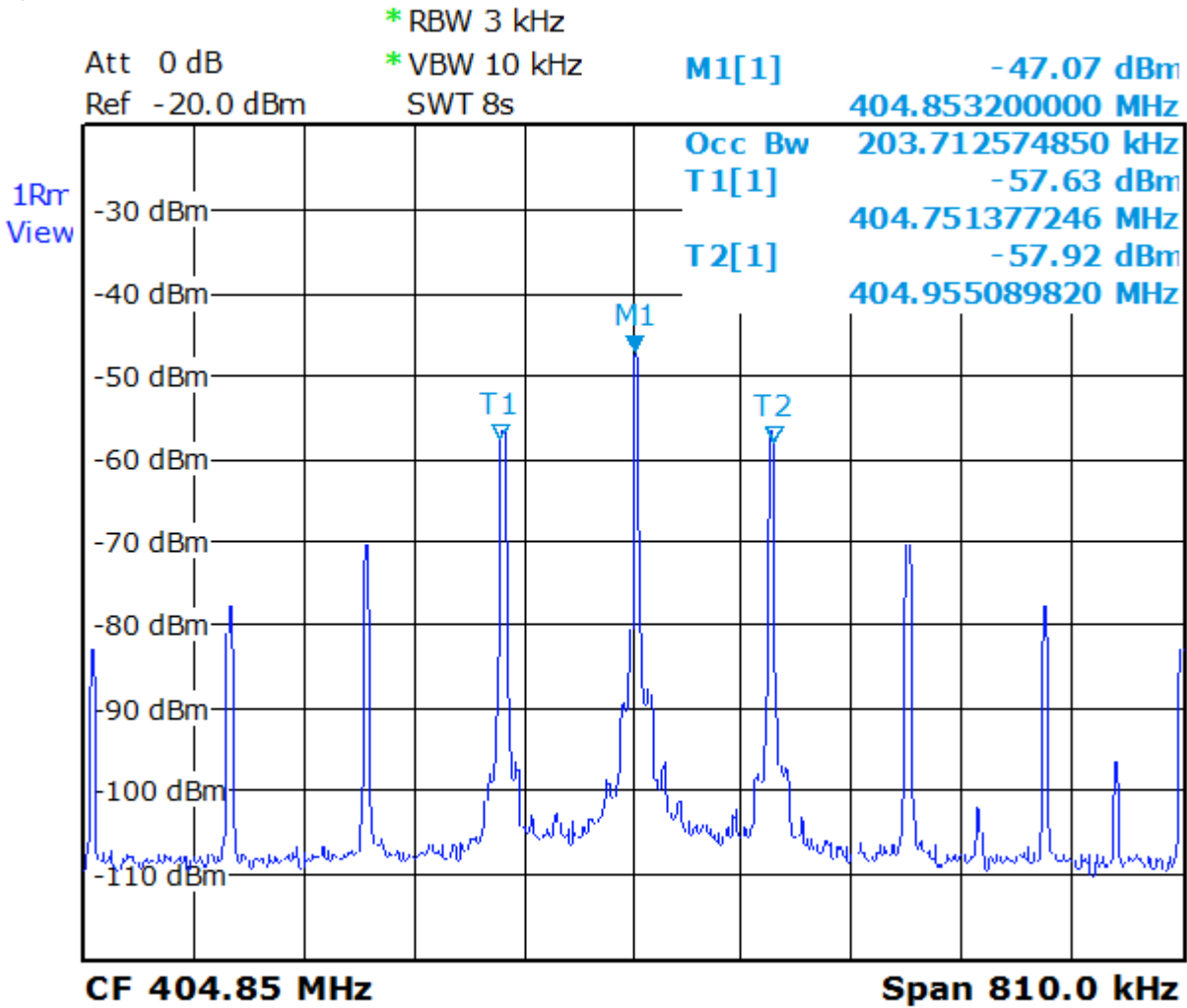

Date: 29.MAR.2012 13:53:19



Spurious emissions
Operating mode
Vertical polarisation

— Radio/ETSI EN 301 839 V1.3.1 - Classe:Op - Crête/
— Radio/Item 8 of article 2 Paragraph 1 of Certification Ordinance - Classe:OP - Crête/
— Mes.Peak

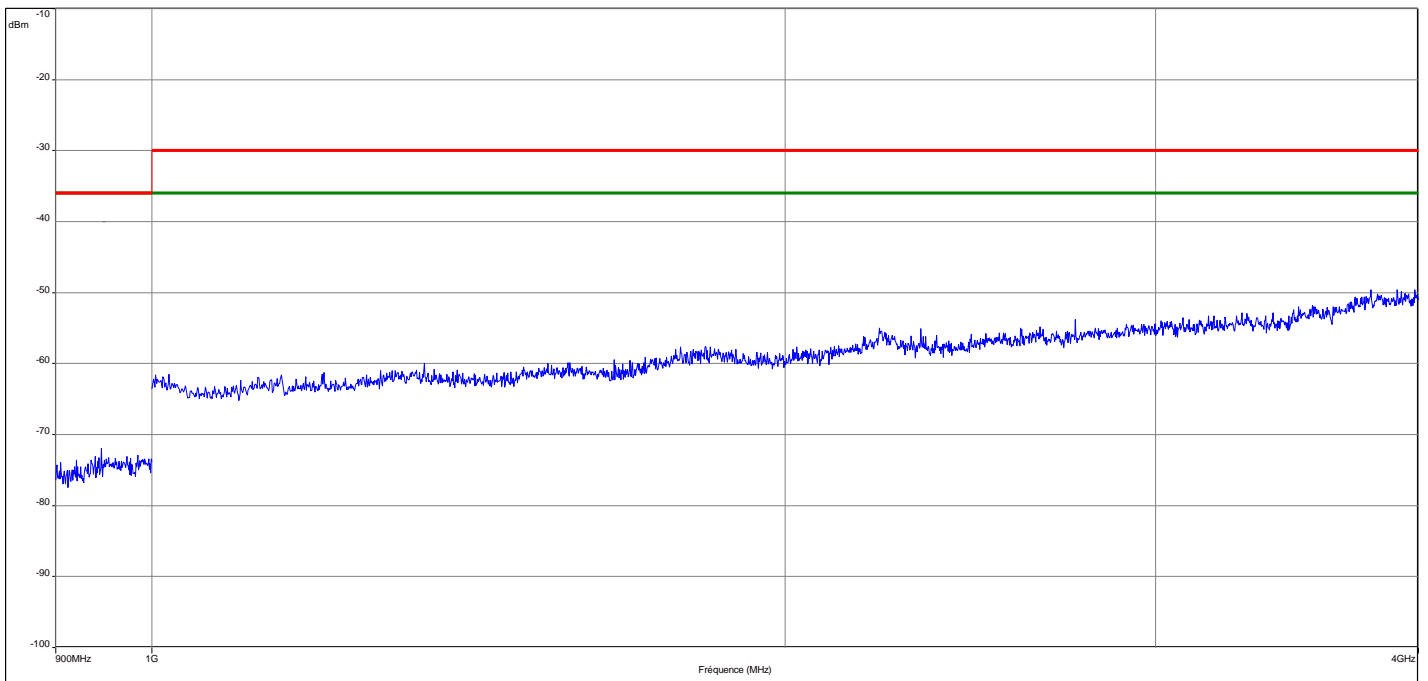



Spurious emissions
Operating mode
Horizontal polarisation

— Radio/ETSI EN 301 839 V1.3.1 - Classe:Op - Crête/
— Radio/Item 8 of article 2 Paragraph 1 of Certification Ordinance - Classe:OP - Crête/
— Mes.Peak

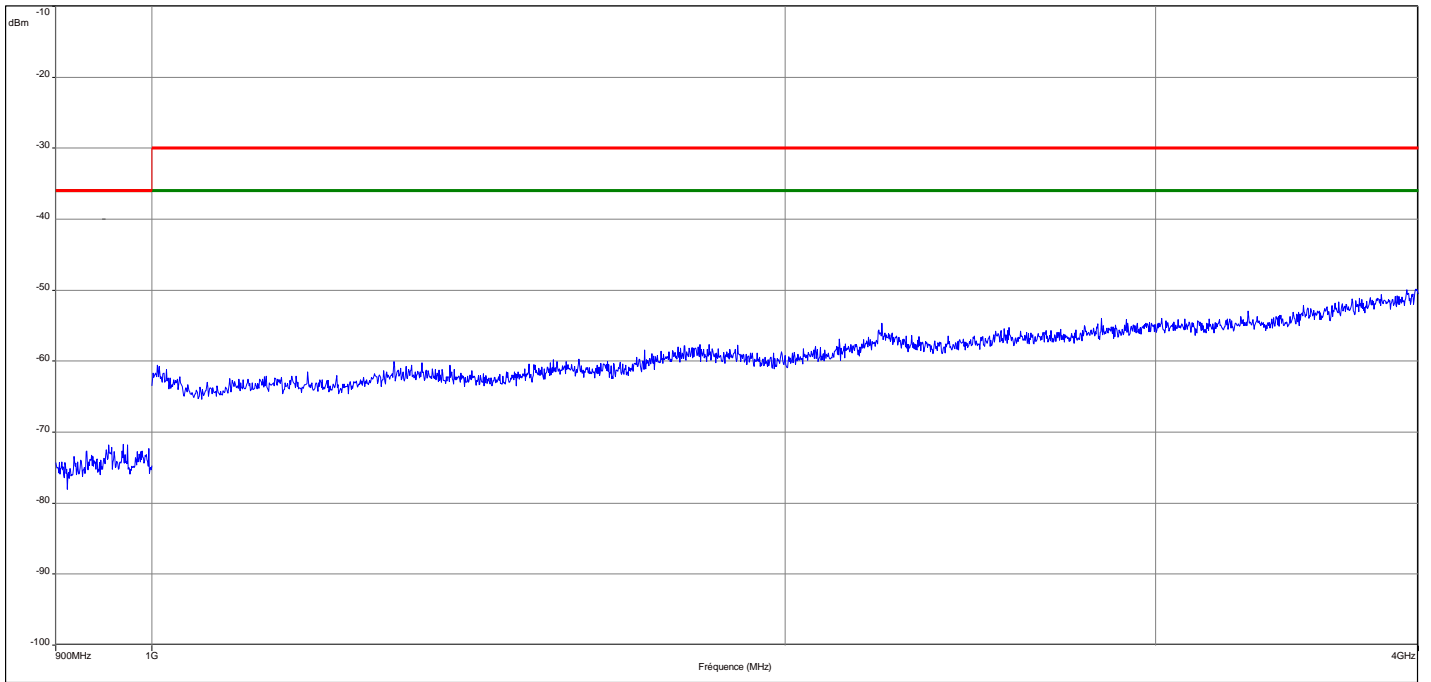

Spurious emissions
Receiver mode
Vertical polarisation

- Radio/ETSI EN 301 839 V1.3.1 - Classe:SB - Crête/
- Radio/Specified low-power radio equipment (Item 8 of Article 2 Paragraph 1 of Certification Ordinance) - Classe:SB - Crête/
- Mes.Peak

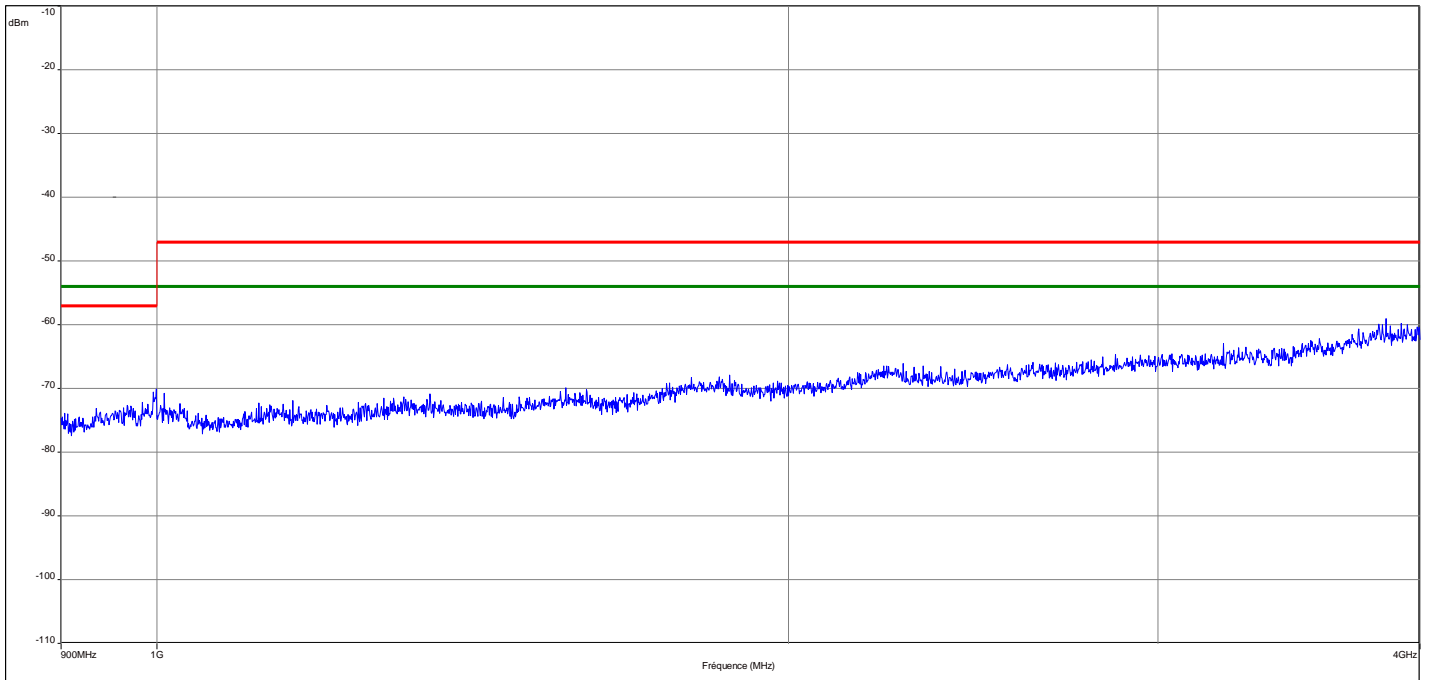

Spurious emissions
Receiver mode
Horizontal polarisation

— Radio/ETSI EN 301 839 V1.3.1 - Classe:SB - Crête/
— Radio/Specified low-power radio equipment (Item 8 of Article 2 Paragraph 1 of Certification Ordinance) - Classe:SB - Crête/
— Mes.Peak

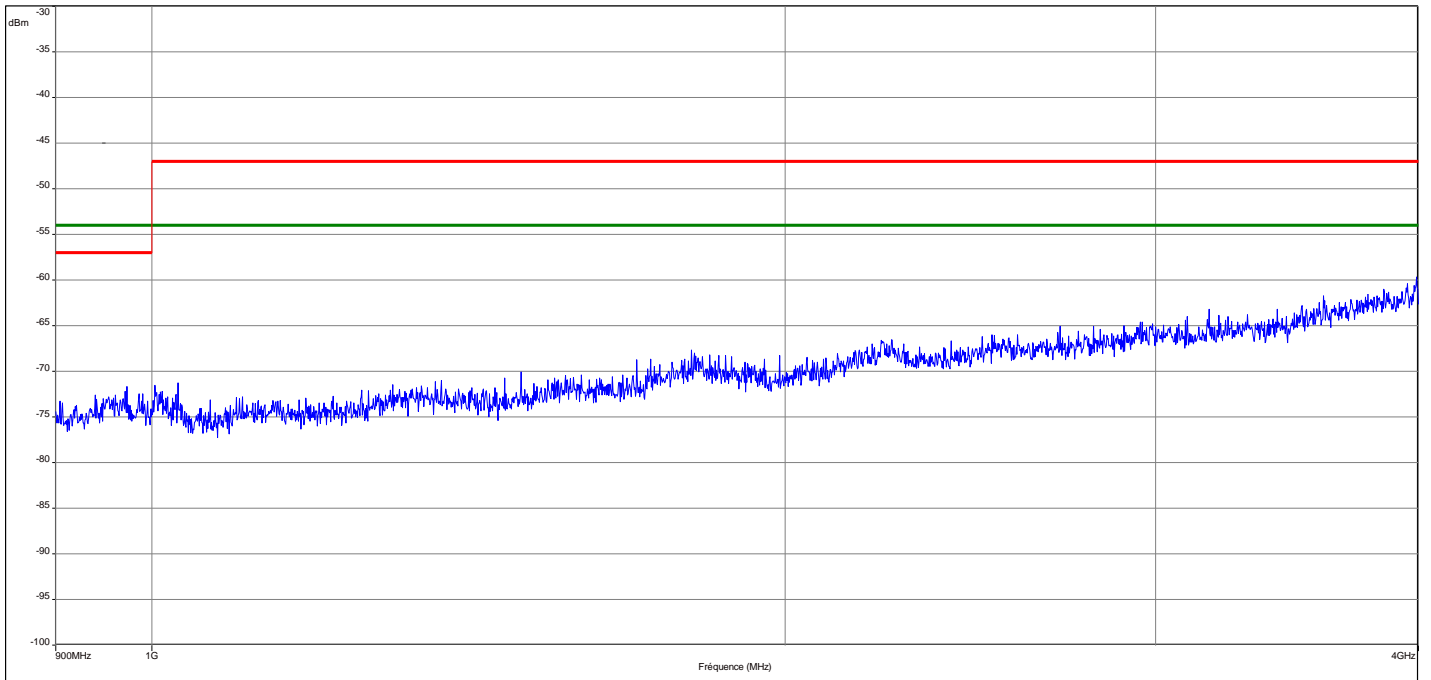



13. ANNEX 2 (FLUID DATA SHEET MSL 450)

COMOSAR BODY Liquid 450 MHz Calibration Report			
	Ref: CR.50.1.13.SATB.A		
	Page: 3/4	Issue: A	Date: 19/02/2013

PRODUCT DESCRIPTION

Components :

De-ionised water
Sodium chloride
1,2 - Propanediol

CALIBRATION TEST EQUIPMENT

TYPE	IDENTIFICATION	DATE OF CALIBRATION
Vector Network Analyzer	HP8753D (SN: 5410A08882)	23/03/2011
Dielectric probe kit	SATIMO OCP (SN:SN1410OCPG35)	09/2012

FCC RECOMMENDED REFERENCE VALUES

Frequency (MHz)	Relative Dielectric Constant (ϵ_r)	Conductivity (σ) (S/m)
150	61.9	0.8
300	58.2	0.92
450	56.7	0.94
835	55.2	0.97
900	55	1.05
915	55	1.06
1450	54	1.3
1610	53.8	1.4
1800-2000	53.3	1.52
2450	52.7	1.95
3000	52	2.73
5800	48.2	6



COMOSAR BODY Liquid 450 MHz Calibration Report	 Ref: CR.50.1.13.SATB.A		
	Page: 4/4	Issue: A	Date: 19/02/2013

DIELECTRIC PARAMETERS MEASURED

Frequency (MHz)	Epsilon'	Epsilon''	Sigma (S/m)	FCC Recommendations (Body Liquid) (+/-5%)
400.00	56.54	41.41	0.92	Epsilon': -1.16 % Epsilon'': -1.40 %
410.00	56.54	40.06	0.93	Epsilon': -0.99 % Epsilon'': -0.43 %
420.00	56.47	39.87	0.93	Epsilon': -0.93 % Epsilon'': -0.62 %
430.00	56.21	39.55	0.94	Epsilon': -1.20 % Epsilon'': 0.79 %
440.00	55.77	38.72	0.95	Epsilon': -1.62 % Epsilon'': 0.84 %
450.00	55.84	37.95	0.95	Epsilon': -1.52 % Epsilon'': 0.93 %
460.00	55.98	37.84	0.97	Epsilon': -1.20 % Epsilon'': 2.80 %
470.00	55.81	37.04	0.97	Epsilon': -1.44 % Epsilon'': 2.72 %
480.00	55.69	36.87	0.98	Epsilon': -1.58 % Epsilon'': 4.33 %
490.00	55.97	35.85	0.98	Epsilon': -1.02 % Epsilon'': 3.49 %
500.00	55.78	35.40	0.98	Epsilon': -1.29 % Epsilon'': 4.19 %

Freq (MHz)	Parameters	Liquid Temp (°C)	Target Value	Measured Values	Deviation (%)	Limits (%)
450	Permittivity	21.0	56.7	55.84	-1.52	± 5
	Conductivity (S/m)	21.0	0.94	0.95	0.93	± 5