



L C I E

Test report

N°: 131328-664445HCr2015-08-04

Subject Radio spectrum Matters (ERM) tests according to standards:
47 CFR Part 95I & RSS-243 & RSS-Gen, Issue 4

Issued to SORIN CRM
Parc d'Affaires NOVEOS
4 avenue Réaumur
92143 Clamart cedex

Apparatus under test

↪ Product Platinum implantable cardioverter defibrillator
↪ Trade mark SORIN Group
↪ Manufacturer Sorin CRM S.r.l — Italy
↪ Model SonR CRT-D 1811
↪ Serial number 128DL02B
↪ FCC ID YSGCRTDSOR1811
↪ IC ID 10270A-CRTDSOR1811
↪ IC Site number OATS 6230B

Test date 2014/11/04 to 2014/11/20
Test location Ecuelles Fontenay Aux Roses
Test performed by Mathieu CERISIER & Laurent DENEUX
Composition of document 41 pages

Modification of the last version 2015/08/04
Document issued on 2015/03/11

Written by :
Mathieu CERISIER & Laurent DENEUX
Tests operator



This document shall not be reproduced, except in full, without the written approval of the LCIE. This document contains results related only to the item tested. It does not imply the conformity of the whole production to the item tested. Unless otherwise specified, the decision of conformity takes into account the uncertainty of measures. This document does not anticipate any certification decision.

LCIE 33, av du Général Leclerc Tél : +33 1 40 95 60 60 Société par Actions Simplifiée
Laboratoire Central BP 8 Fax : +33 1 40 95 86 56 au capital de 15 745 984 €
des Industries Electriques 92266 Fontenay-aux-Roses cedex contact@lcie.fr RCS Nanterre B 408 363 174
Une société de Bureau Veritas France www.lcie.fr



SUMMARY

- 1. TEST PROGRAM 3
- 2. EQUIPMENT DESCRIPTION..... 4
- 3. FREQUENCY ERROR..... 9
- 4. EMISSION BANDWIDTH 13
- 5. OCCUPIED BANDWIDTH..... 18
- 6. TRANSMITTER OUTPUT POWER..... 22
- 7. TRANSMITTER UNWANTED EMISSIONS..... 25
- 8. RECEIVER SPURIOUS EMISSIONS..... 34
- 9. SAR EVALUATION 38
- 10. UNCERTAINTIES CHART 41



1. TEST PROGRAM

• **References**

- Standards: -47 CFR FCC Part 95l
-RSS-243
-RSS-Gen
-FCC 15.207
-FCC 15.109

• **Requirements:**

Clause (FCC Part 95l) Test Description	TEST RESULT - Comments
FCC § 95.627(e) & RSS-243 § 5.3 – Frequency error	<input checked="" type="checkbox"/> PASS <input type="checkbox"/> FAIL <input type="checkbox"/> NA <input type="checkbox"/> NP (Limited Program)
FCC § 95.633(e) & RSS-243 § 5.1 – Emission bandwidth	<input checked="" type="checkbox"/> PASS <input type="checkbox"/> FAIL <input type="checkbox"/> NA <input type="checkbox"/> NP (Limited Program)
RSS-Gen § 6.6 – Occupied bandwidth	<input checked="" type="checkbox"/> PASS <input type="checkbox"/> FAIL <input type="checkbox"/> NA <input type="checkbox"/> NP (Limited Program)
FCC § 95.639(f) & RSS-243 § 5.4 – Transmitter output power	<input checked="" type="checkbox"/> PASS <input type="checkbox"/> FAIL <input type="checkbox"/> NA <input type="checkbox"/> NP (Limited Program)
FCC § 15.207(d) & RSS-Gen § 8.8 – AC conducted emissions	<input type="checkbox"/> PASS <input type="checkbox"/> FAIL <input checked="" type="checkbox"/> NA <input type="checkbox"/> NP (Limited Program)
FCC § 95.635(d) & RSS-243 § 5.5 – Transmitter unwanted emission	<input checked="" type="checkbox"/> PASS <input type="checkbox"/> FAIL <input type="checkbox"/> NA <input type="checkbox"/> NP (Limited Program)
FCC 15.109 & RSS-243 § 5.6 – Receiver spurious emissions	<input checked="" type="checkbox"/> PASS <input type="checkbox"/> FAIL <input type="checkbox"/> NA <input type="checkbox"/> NP (Limited Program)
FCC 95.627 (a)(3) & RSS-243 § 5.7.1 – LBT threshold power level	<input type="checkbox"/> PASS <input type="checkbox"/> FAIL <input checked="" type="checkbox"/> NA (MICS Communication session initiated by ULP-AMI-P only) <input type="checkbox"/> NP (Limited Program)
FCC 95.627 (a)(1) & RSS-243 § 5.7.2 – Monitoring system bandwidth	<input type="checkbox"/> PASS <input type="checkbox"/> FAIL <input checked="" type="checkbox"/> NA (MICS Communication session initiated by ULP-AMI-P only) <input type="checkbox"/> NP (Limited Program)
FCC 95.627 (a)(2) & RSS-243 § 5.7.3 –Monitoring system scan cycle time	<input type="checkbox"/> PASS <input type="checkbox"/> FAIL <input checked="" type="checkbox"/> NA (MICS Communication session initiated by ULP-AMI-P only) <input type="checkbox"/> NP (Limited Program))
FCC 95.627 (a)(2) & RSS-243 § 5.7.4 –Minimum channel monitoring period	<input type="checkbox"/> PASS <input type="checkbox"/> FAIL <input checked="" type="checkbox"/> NA (MICS Communication session initiated by ULP-AMI-P only) <input type="checkbox"/> NP (Limited Program)
FCC 95.627 (a)(4) & RSS-243 § 5.7.5 – Channel access	<input type="checkbox"/> PASS <input type="checkbox"/> FAIL <input checked="" type="checkbox"/> NA (MICS Communication session initiated by ULP-AMI-P only) <input type="checkbox"/> NP (Limited Program)
FCC 95.627 (a)(4) & RSS-243 § 5.7.6 – Discontinuation of MICS session	<input type="checkbox"/> PASS <input type="checkbox"/> FAIL <input checked="" type="checkbox"/> NA (MICS Communication session initiated by ULP-AMI-P only) <input type="checkbox"/> NP (Limited Program)
FCC 95.627 (a)(5) & RSS-243 § 5.7.7 – Use of pre-scanned alternative channel	<input type="checkbox"/> PASS <input type="checkbox"/> FAIL <input checked="" type="checkbox"/> NA (MICS Communication session initiated by ULP-AMI-P only) <input type="checkbox"/> NP (Limited Program)
SAR Evaluation	<input checked="" type="checkbox"/> PASS <input type="checkbox"/> FAIL <input type="checkbox"/> NA
This table is a summary of test report, see conclusion of each clause of this test report for detail.	

The product SORIN Group SonR CRT-D 1811, SN: 128DL02B is Compliant according to FCC part 95l & RSS-243 & RSS-Gen standards.

- PASS: EUT complies with standard's requirement
 FAIL: EUT does not comply with standard's requirement
 NA: Not Applicable
 NP: Not Performed



2. EQUIPMENT DESCRIPTION

2.1. GENERAL DESCRIPTION

The SORIN Group PLATINIUM SonR CRT-D 1811 is an implantable cardioverter defibrillator for the recognition and treatment of ventricular tachycardia and fibrillation, with ventricular resynchronization, in patients with spontaneous or inducible tachyarrhythmias. PLATINIUM SonR CRT-D is equipped with an accelerometer to allow adaptation of pacing to suit the patient's activity.

2.2. HARDWARE & SOFTWARE IDENTIFICATION DECLARED BY THE MANUFACTURER

Equipment under test (EUT):



Leads connection - 1811 model

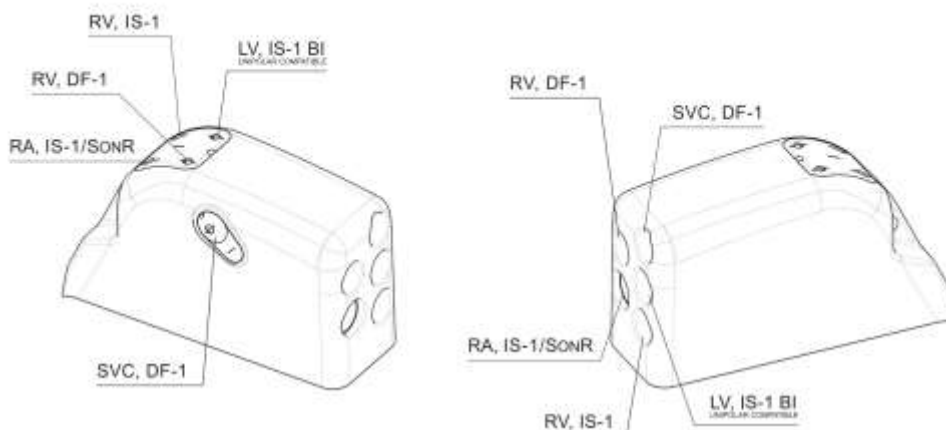

Photograph of EUT



- **Auxiliary equipment (AE) used for testing:**
 - Inductive Head
 - Personal Computer



Photograph of AE



• **Input/output:**

- none

• **Software identification:**

-Software version: ROM V2

• **Equipment information:**

- Modulation: 2FSK

- Transmit operating mode: Multiples antenna
 Single antenna

- Number of transmit chains: 1 2

- Number of receiver chains: 1 2

- Antenna type: Integral External

- Type of the equipment: Stand-alone equipment Plug-in radio device Combined equipment

- Temperature range: Tmin: -20°C 0°C 25°C

Tnom: 37°C

Tmax: +35°C 55°C 45°C

- Test source voltage: Vmin: 207V/50Hz 2.5Vdc
Vnom: 230V/50Hz 2.62Vdc
Vmax: 253V/50Hz 3.24Vdc

- Type of power source: Battery (Alkaline/Lithium-Ion/Lead acid/Other) Internal power supply
 External power supply Car Charger

- Test sequence/test software used: See 2.2. Running Mode

- Duty Cycle: Continuous duty Intermittent duty Continuous operation

- Equipment type: Representative production model Pre-production model



- Operating frequency range:

Frequency Band (MHz)	
2400MHz to 2483,5MHz	<input checked="" type="checkbox"/>
5150MHz to 5350MHz	<input type="checkbox"/>
5470MHz to 5725MHz	<input type="checkbox"/>
402MHz to 405MHz	<input checked="" type="checkbox"/>

-Channel plan:

Channel	Frequency (MHz)
Cmin: 0	402.15
1	402.45
2	402.75
3	403.05
4	403.35
Cnom:5	403.65
6	403.95
7	404.25
8	404.55
Cmax: 9	404.85



2.3. RUNNING MODE

The EUT is set in the following modes during tests:

- Permanent emission with modulation on a fixed channel at the highest power
- Permanent emission without modulation on a fixed channel at the highest power
- Permanent reception

Following commands with the specific test software are used to set the product:

See MISC2723A document

2.4. EQUIPMENT LABELLING



2.5. EQUIPMENT MODIFICATION

- No equipment modification has been necessary during testing.
- Modification applied for following tests:

3. FREQUENCY ERROR

3.1. TEST CONDITIONS

Test performed by : Mathieu CERISIER
Date of test : 2014/11/04
Ambient temperature : 22°C
Relative humidity : 42%

3.2. TEST SETUP

- The Equipment under Test is installed:

- In the climatic chamber
- On a table
- In an anechoic chamber

-Measurement is performed with a spectrum analyzer

- On the EUT conducted access
- With a test fixture

The spectrum analyzer counter and marker peak functions are used to find the frequency error.
Detector peak



Photograph for Frequency Error



Photograph for Frequency Error

3.3. LIMIT

Frequency error for equipment operating in the 402 MHz to 405 MHz band shall not exceed ± 100 ppm under normal, extreme or any intermediate set of conditions.

3.4. TEST EQUIPMENT LIST

DESCRIPTION	MANUFACTURER	MODEL	N° LCIE	Cal_Date	Cal_Due
Climatic Chamber	MPC	F65/350L	D1025035	2013/12	2014/12
EMI receiver	ROHDE & SCHWARZ	FSIQ7	A4060040	2013/11	2014/11
Temperature Sensor	HP	34970A	A6440070	2014/01	2016/01

Note: In our system quality, calibration due is more & less 2 month.

3.5. DIVERGENCE, ADDITION OR SUPPRESSION ON THE TEST SPECIFICATION

None

Divergence:



3.6. GRAPHICS & RESULTS

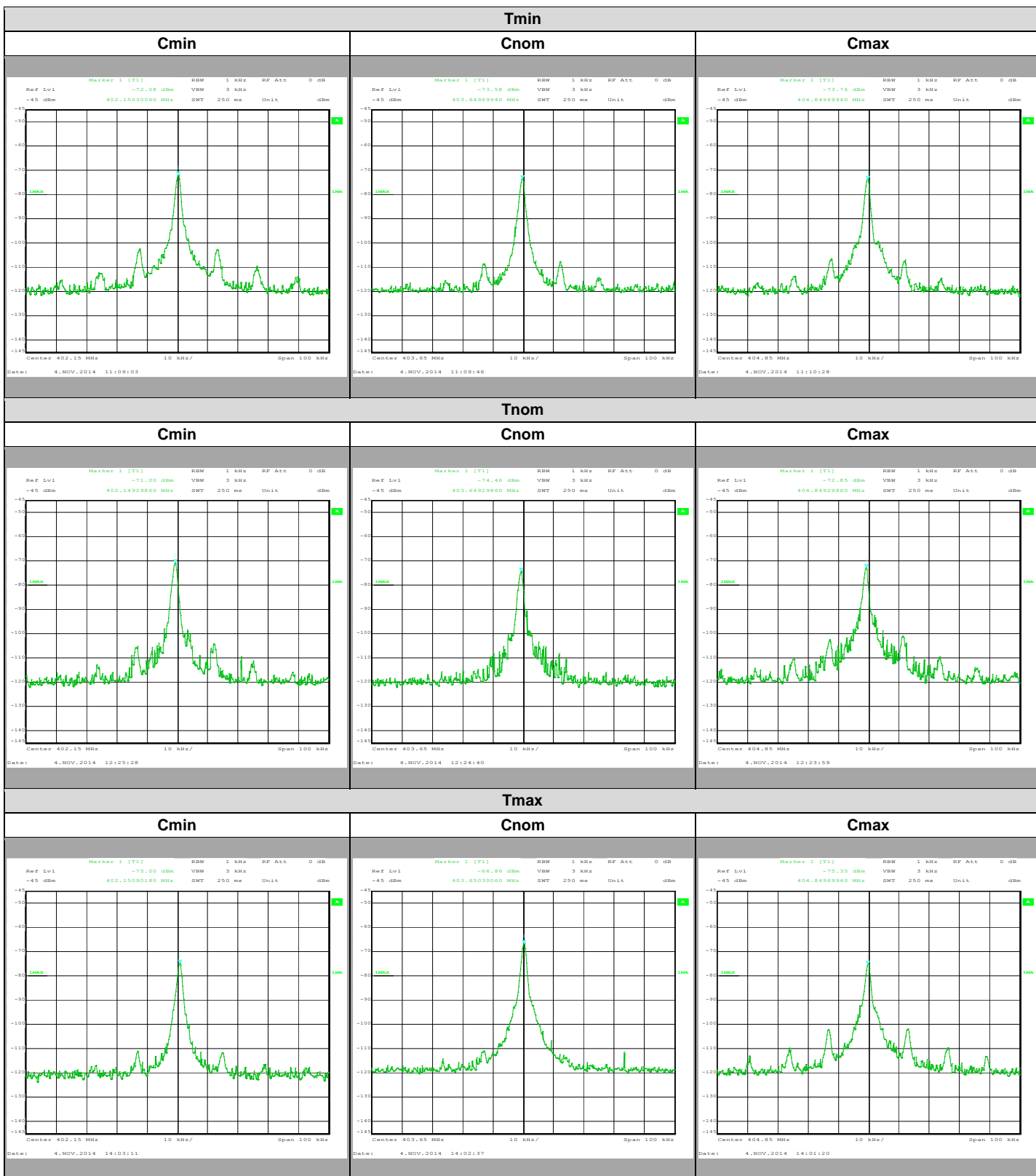



Temperature	Tmin			Tnom			Tmax		
Voltage	Vnom								
Channel	Cmin	Cnom	Cmax	Cmin	Cnom	Cmax	Cmin	Cnom	Cmax
Frequency (MHz)	402.1503	403.6496	404.8496	402.1492	403.6492	404.8492	402.1509	403.6503	404.8496
Frequency error (ppm)	2.7	1.0	1.0	REF	REF	REF	4.2	2.7	1.0

3.7. CONCLUSION

The product SORIN Group SonR CRT-D 1811, SN:128DL02B, in configuration and description presented in this test report, complies with the frequency error measurement of FCC § 95.627(e) & RSS-243 § 5.3.

4. EMISSION BANDWIDTH

4.1. TEST CONDITIONS

Test performed by : Mathieu CERISIER
Date of test : 2014/11/05
Ambient temperature : 22°C
Relative humidity : 42%

4.2. TEST SETUP

- The Equipment under Test is installed:

- In the climatic chamber
- On a table
- In an anechoic chamber

-Measurement is performed with a spectrum analyzer

- On the EUT conducted access
- With a test fixture

The spectrum analyzer is used to find the emission bandwidth.
Detector peak

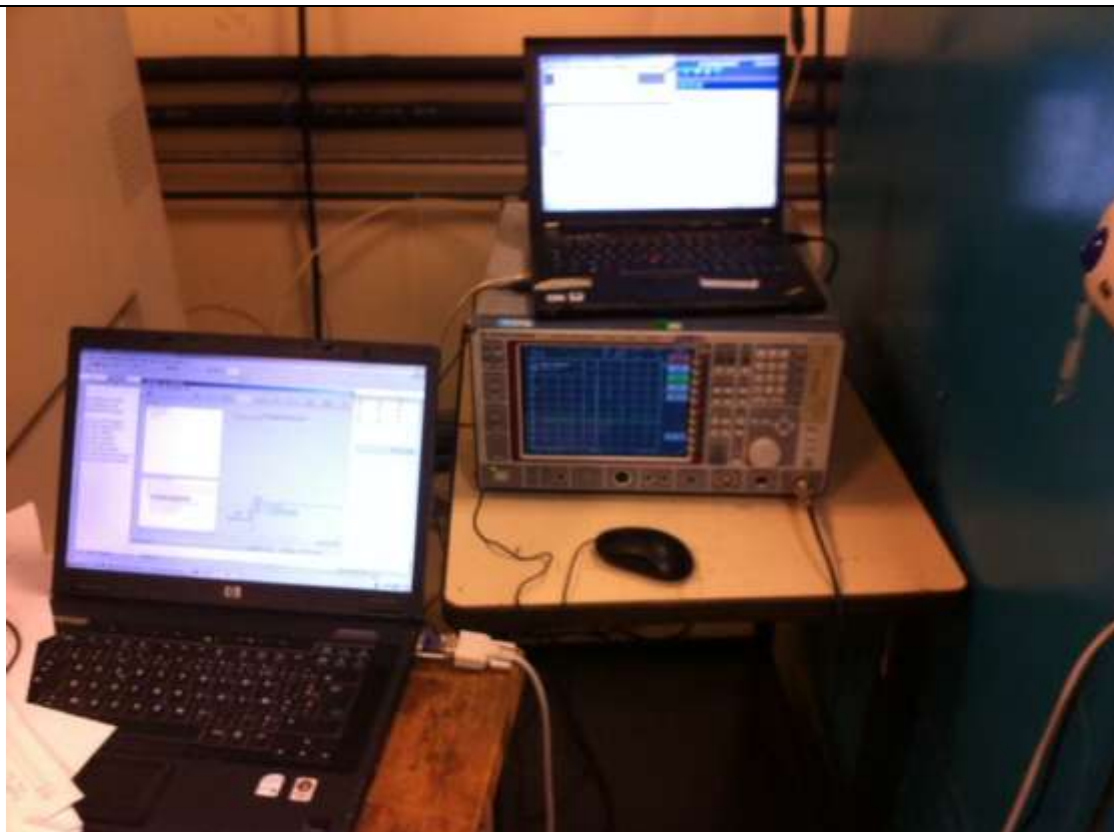

Photograph for Emission Bandwidth

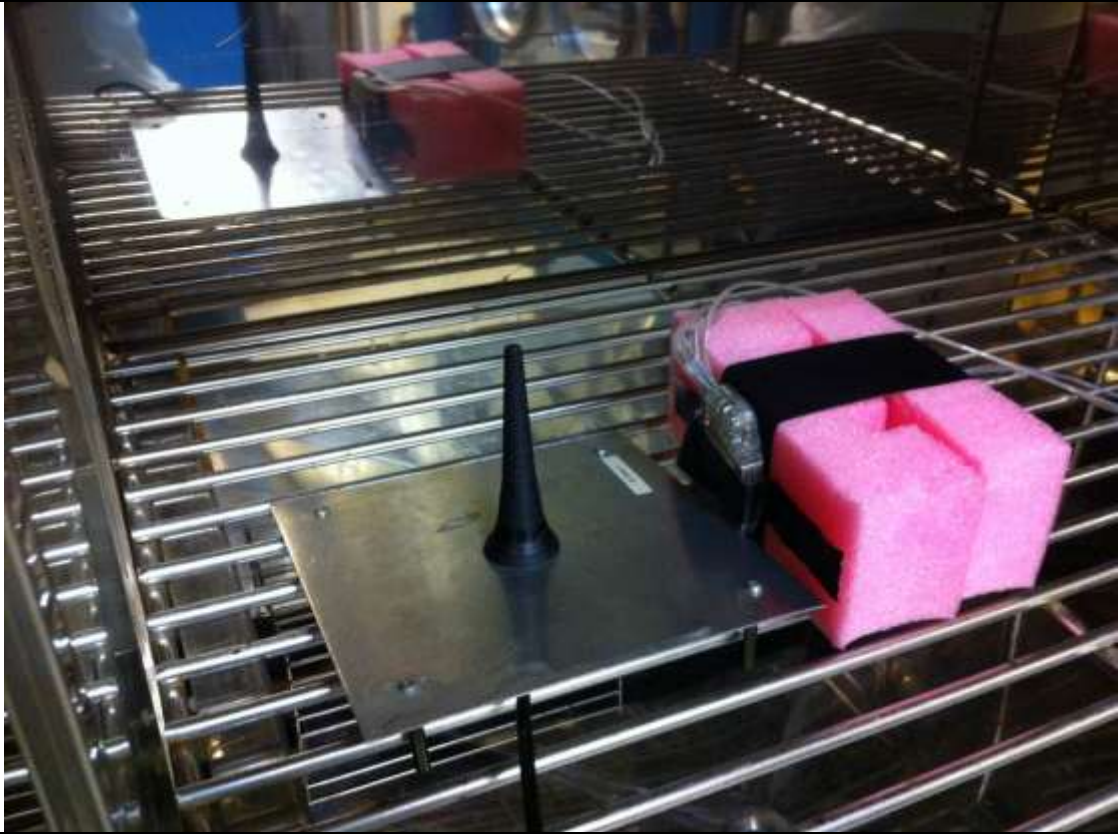

Photograph for Emission Bandwidth

4.3. LIMIT

Emission bandwidth shall not exceed 300 kHz. If two or more devices that operate in a given MICS communications session operate in different portions of the 402 MHz to 405 MHz band, their combined emission bandwidths shall not exceed 300 kHz. This limits spectrum usage to a maximum of 300 kHz in any single MICS communications session. The 300 kHz limitation may be exceeded briefly due to intermittent transmissions that may occur when operating channel acquisitions or changes are required to maintain a communications session.

All emissions from each device that fall outside its emission bandwidth but do fall within the 402 MHz to 405 MHz band shall be attenuated at least 20dB.

In addition, emissions from a device operating in the low duty cycle low power mode in the band 403,5MHz to 403,8MHz must be attenuated at least 20 dB at the band edges, 403,5MHz and 403,8MHz.



4.4. TEST EQUIPMENT LIST

DESCRIPTION	MANUFACTURER	MODEL	N° LCIE	Cal_Date	Cal_Due
Climatic Chamber	MPC	F65/350L	D1025035	2013/12	2014/12
EMI receiver	ROHDE & SCHWARZ	FSIQ7	A4060040	2013/11	2014/11
Temperature Sensor	HP	34970A	A6440070	2014/01	2016/01

Note: In our system quality, calibration due is more & less 2 month.

4.5. DIVERGENCE, ADDITION OR SUPPRESSION ON THE TEST SPECIFICATION

None

Divergence:



Temperature	Tnom		
Voltage	Vnom		
Channel	Cmin	Cnom	Cmax
Emission bandwidth (kHz)	212,423	210,421	210,421

4.7. CONCLUSION

The product SORIN Group SonR CRT-D 1811, SN:128DL02B, in configuration and description presented in this test report, complies with the emission bandwidth measurement of FCC § 95.633(e) & RSS-243 § 5.1.

5. OCCUPIED BANDWIDTH

5.1. TEST CONDITIONS

Test performed by : Mathieu CERISIER
Date of test : 2014/11/05
Ambient temperature : 23°C
Relative humidity : 39%

5.2. TEST SETUP

- The Equipment under Test is installed:

- In the climatic chamber
- On a table
- In an anechoic chamber

-Measurement is performed with a spectrum analyzer

- On the EUT conducted access
- With a test fixture

The product has been tested according to the RSS-GEN § 6.6 reference method.
Detector peak

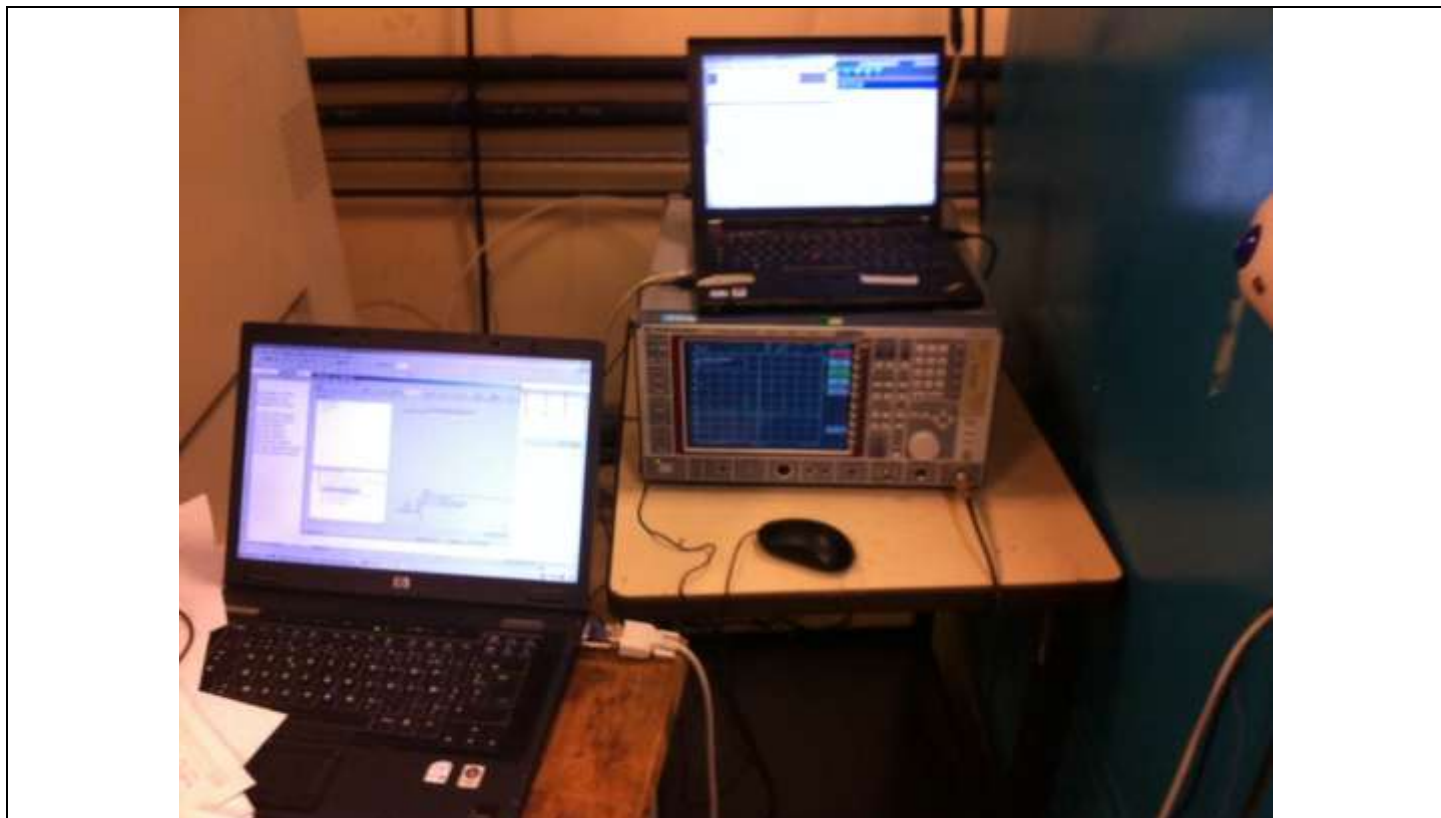

Photograph for Occupied Bandwidth



Photograph for Occupied Bandwidth

5.3. LIMIT

No Limit

5.4. TEST EQUIPMENT LIST

DESCRIPTION	MANUFACTURER	MODEL	N° LCIE	Cal_Date	Cal_Due
Climatic Chamber	MPC	F65/350L	D1025035	2013/12	2014/12
EMI receiver	ROHDE & SCHWARZ	FSIQ7	A4060040	2013/11	2014/11
Temperature Sensor	HP	34970A	A6440070	2014/01	2016/01

Note: In our system quality, calibration due is more & less 2 month.

5.5. DIVERGENCE, ADDITION OR SUPPRESSION ON THE TEST SPECIFICATION

None Divergence:



5.6. GRAPHICS & RESULTS

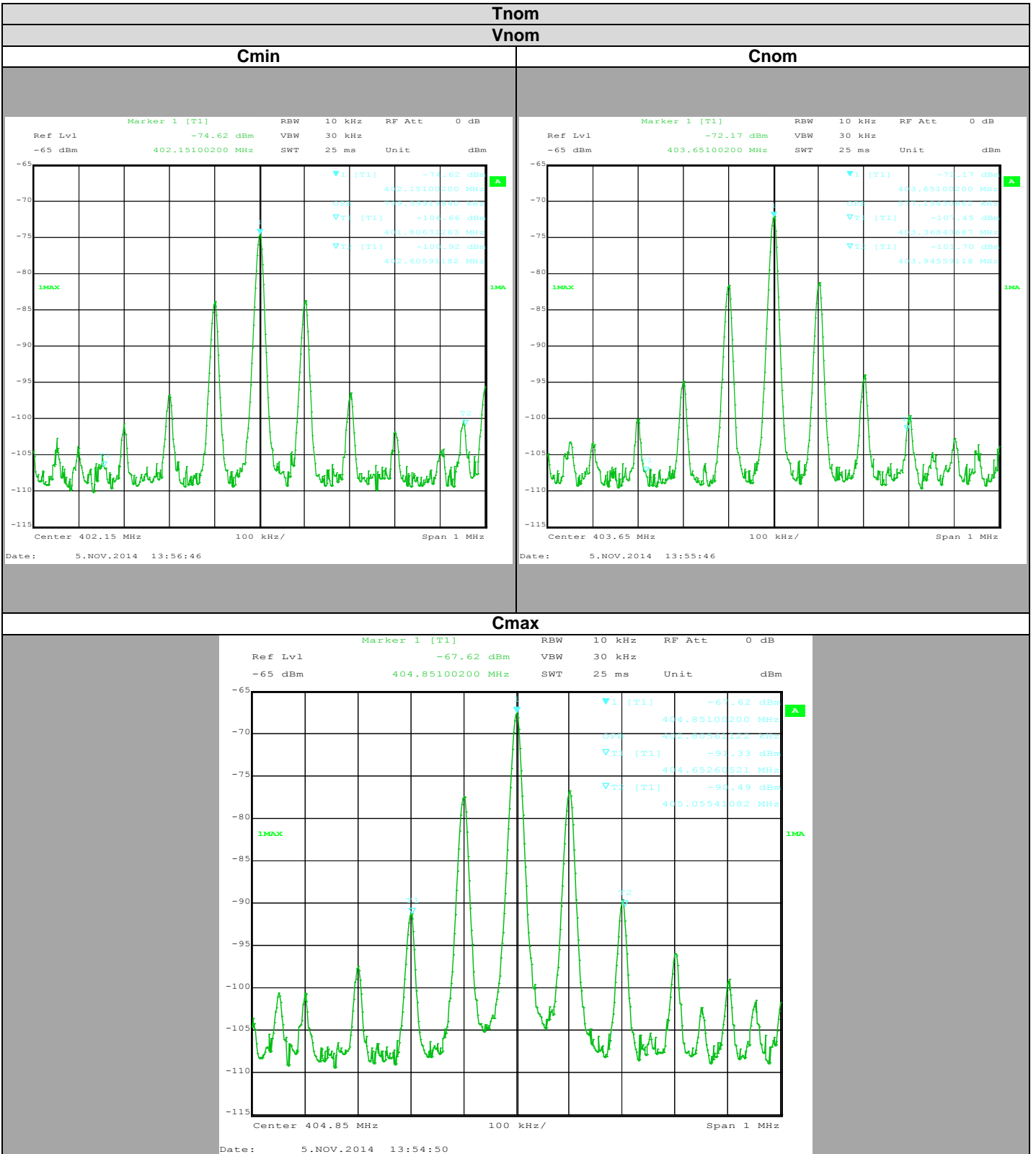



Temperature	Tnom		
Voltage	Vnom		
Channel	Cmin	Cnom	Cmax
Occupied Bandwidth (kHz)	799,599	577,154	402,805

5.7. CONCLUSION

The product SORIN Group SonR CRT-D 1811, SN:128DL02B, in configuration and description presented in this test report, complies with the occupied bandwidth measurement of RSS-Gen § 6.6.



6. TRANSMITTER OUTPUT POWER

6.1. TEST CONDITIONS

Test performed by : Laurent DENEUX
Date of test : 2014/11/20
Ambient temperature : 18°C
Relative humidity : 47%

6.2. TEST SETUP

- The Equipment Under Test is installed:

- FAR
- SAR
- OATS

- Distance between EUT and the measuring antenna is:

- 3m
- 10m

- The setup is 1.5 m above the ground reference plane on an isolating table and the maximum emitted power value from the EUT is found by the rotation of the 360° turntable and:

- With measurement antenna height at 1.5m from the ground reference plane
- By variation of measurement antenna height between 1m and 4m from the ground reference plane

The measuring antenna is in vertical and then in horizontal polarization. The substitution antenna replaces the equipment under test. The substitution antenna is powered by signal generator through RF cables. The input signal on the substitution antenna is adjusted in order to obtain the same value found in the maximum emitted power search. Mean power at the output of the transmitter and product antenna gain (A+G) are deduced after correction due to the gain of the substitution antenna and the RF cables loss between the signal generator and the substitution antenna

The Equivalent Isotropic Radiated Power (EIRP in dBm) is defined with the following formula:

$$EIRP = A+G$$

A (dBm): peak power at the output of the transmitter

G (dBi): product antenna gain

A+G: Measured in radiated by substitution method

Detector peak

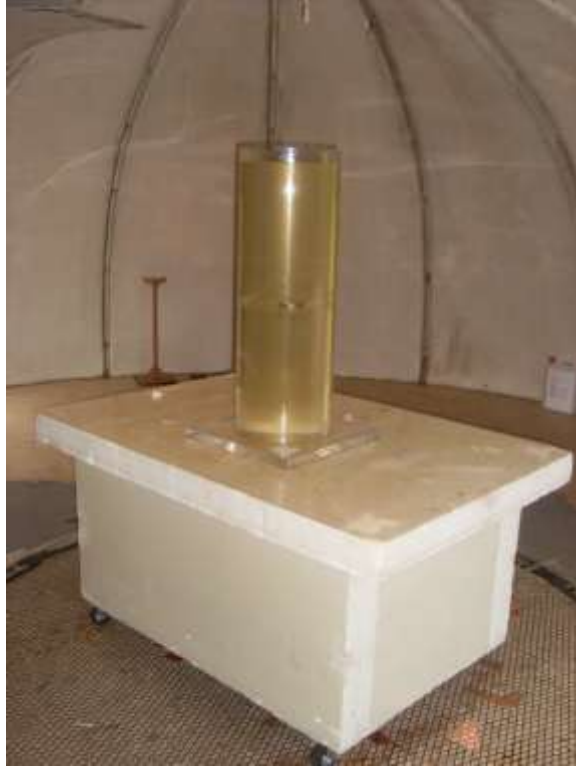

Photograph for Transmitter output power

6.3. LIMIT

The EIRP of ULP-AMI and/or ULP-AMI-P equipment that operates as part of system that incorporates a monitoring system to select the frequency of operation using LBT and AFA shall not exceed 25 μ W.

The EIRP of ULP-AMI transmitters operating on any frequency in the band 403,5 MHz to 403,8 MHz shall not exceed 100nW unless the frequency of operation in this band has been selected by a monitoring system using LBT and AFA. The duty cycle for any transmitter operating in the LDC mode is limited to 0,01%.



6.4. TEST EQUIPMENT LIST

Apparatus	Trade Mark	Type	Registration number	Cal_Date	Cal_Due
EMI receiver	ROHDE & SCHWARZ	ESI40 1088 740K40	A2642010	2014/02	2015/02
Bilog antenna	CHASE	CBL 6112A	C2040040	2014/04	2015/04
Logperiodic antenna	ROHDE & SCHWARZ	HL 023 A2	C2040001	2014/05	2015/05
Signal Generator	ROHDE & SCHWARZ	SMY02	A5442014	2014/04	2015/04
Cable	-	-	A5329449	2014/09	2015/09
Cable	-	-	A5329368	2014/04	2015/04
cable	-	-	A5329444	2014/09	2015/09
Cable	-	-	A5329362	2014/03	2015/03
Cable	-	-	A5329442	2014/09	2015/09
OATS	L.C.I.E.	-	F2000400	2014/06	2015/06

6.5. DIVERGENCE, ADDITION OR SUPPRESSION ON THE TEST SPECIFICATION

None Divergence:

6.6. RESULTS

Tnom					
Vnom					
Frequency	Generator level (dBm)	Loss (dB)	Antenna gain (dBi)	EIRP (dBm)	EIRP(μW)
402.15MHz	-45	2,4	5,1	-42,3	0,059
403.66MHz	-47	2,4	5,2	-44,2	0,038
404.85MHz	-44	2,4	5,2	-41,2	0,076

6.7. CONCLUSION

The product SORIN Group SonR CRT-D 1811, SN:128DL02B, in configuration and description presented in this test report, complies with the transmitter output power measurement of FCC § 95.639(f) & RSS-243 § 5.4.

7. TRANSMITTER UNWANTED EMISSIONS

7.1. TEST CONDITIONS

Test performed by : Laurent DENEUX & Mathieu CERISIER
Date of test : 2014/11/20 & 2014/11/05
Ambient temperature : 18°C & 22°C
Relative humidity : 47% & 42%

7.2. TEST SETUP

- The Equipment under Test is installed:

SAR OATS

- Distance between EUT and the measuring antenna is:

3m 10m

- Choice of measuring antenna below 1GHz:

Bilog Log periodic Biconic Dipole antenna

- Choice of measuring antenna above 1GHz:

Horn

The product has been tested according to ANSI C63.10 (2009). Test is performed in horizontal (H) and vertical (V) polarization. Measurement bandwidth was 120kHz below 1GHz and 1MHz above 1GHz. The level has been maximised by the turntable rotation of 360 degrees range on the 3 axis of EUT. Antenna height search was performed from 1 to 4m.



Photograph for Transmitter unwanted emissions



7.3. LIMIT

Transmitter unwanted emissions from MICS devices more than 250kHz outside of the 402-405 MHz band shall not exceed the field strength limits specified below:

Frequencies	Limit at 10m (μV/m)	Limit at 3m (μV/m)	Limit at 3m (μV/m)
30MHz to 88MHz	29.55dBμV/m QPeak	40dBμV/m QPeak	100μV/m QPeak
88MHz to 216MHz	33.05dBμV/m QPeak	43.5dBμV/m QPeak	150μV/m QPeak
216MHz to 960MHz	35.55dBμV/m QPeak	46dBμV/m QPeak	200μV/m QPeak
960MHz to 1000MHz	43.45dBμV/m QPeak	53.9dBμV/m QPeak	500μV/m QPeak
Above 1000MHz	63.45dBμV/m Peak	73.9dBμV/m Peak	5000μV/m Peak
	43.45dBμV/m Average	53.9dBμV/m Average	500μV/m Average

Transmitter unwanted emissions within the 402-405MHz MICS band which are more than 150kHz away from the centre frequency of the spectrum, and the transmissions that occupy up to 250kHz above and below the band shall be attenuated at least 20dB below the maximum transmitter output power.



7.4. TEST EQUIPMENT LIST

Apparatus	Trade Mark	Type	Registration number	Cal_Date	Cal_Due
EMI receiver	ROHDE & SCHWARZ	ESI40 1088 740K40	A2642010	2014/02	2015/02
Bilog antenna	CHASE	CBL 6112A	C2040040	2014-04	2015-04
Cable	-	-	A5329449	2014-09	2015-09
Cable	-	-	A5329368	2014-03	2015-03
Cable	-	-	A5329444	2014-09	2015-09
Cable	-	-	A5329542	2014-01	2015-01
OATS	L.C.I.E.	-	F2000400	2014-06	2015-06
Horn Antenna	EMCO	3115	C2042016	2014-04	2015-04
Preampli	HEWLETT PACKARD	8449B	A4069002	2014-04	2015-04
Climatic Chamber	MPC	F65/350L	D1025035	2013/12	2014/12
EMI receiver	ROHDE & SCHWARZ	FSIQ7	A4060040	2013/11	2014/11
Temperature Sensor	HP	34970A	A6440070	2014/01	2016/01

Note: In our system quality, calibration due is more & less 2 month.

7.5. DIVERGENCE, ADDITION OR SUPPRESSION ON THE TEST SPECIFICATION

None Divergence:



7.6. GRAPHICS & RESULTS

Out of band transmitter unwanted emissions (below 1GHz)

400 Tx mode

Quasi peak measurement

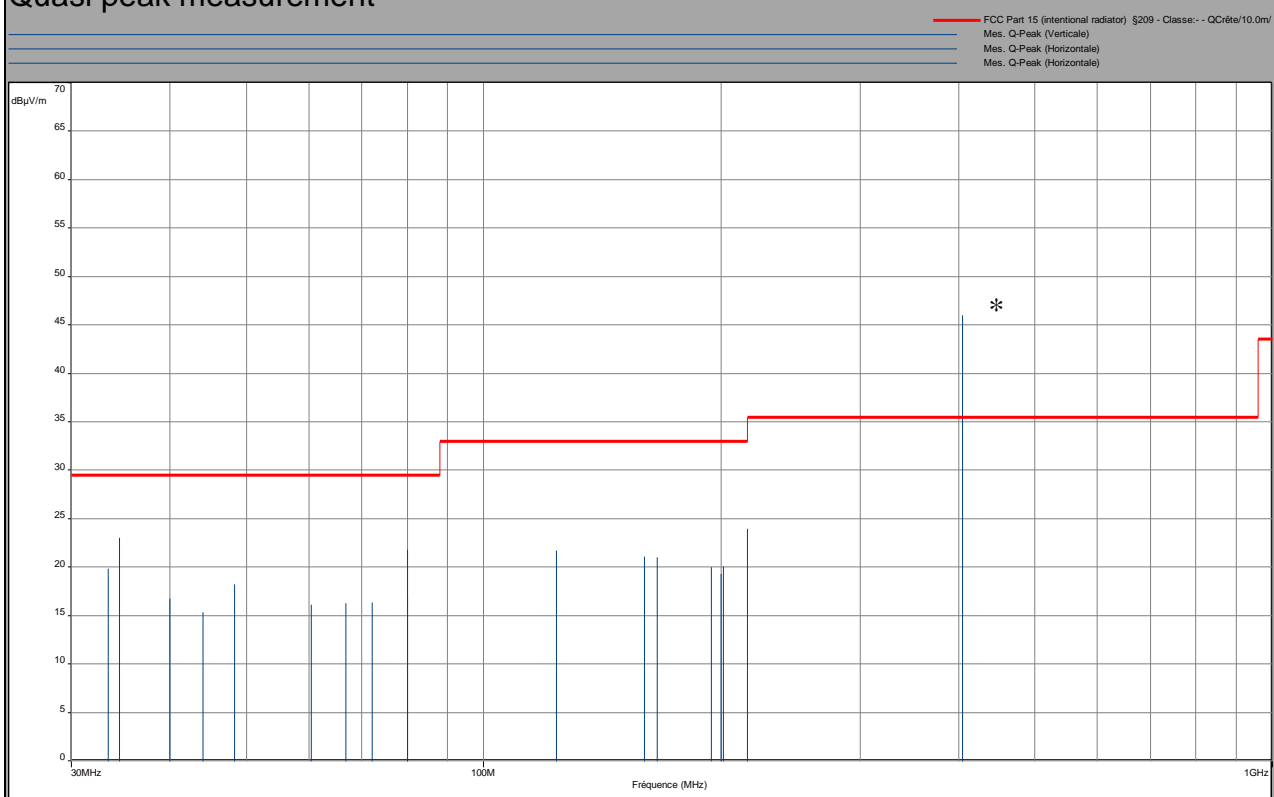

* Transmitter frequency

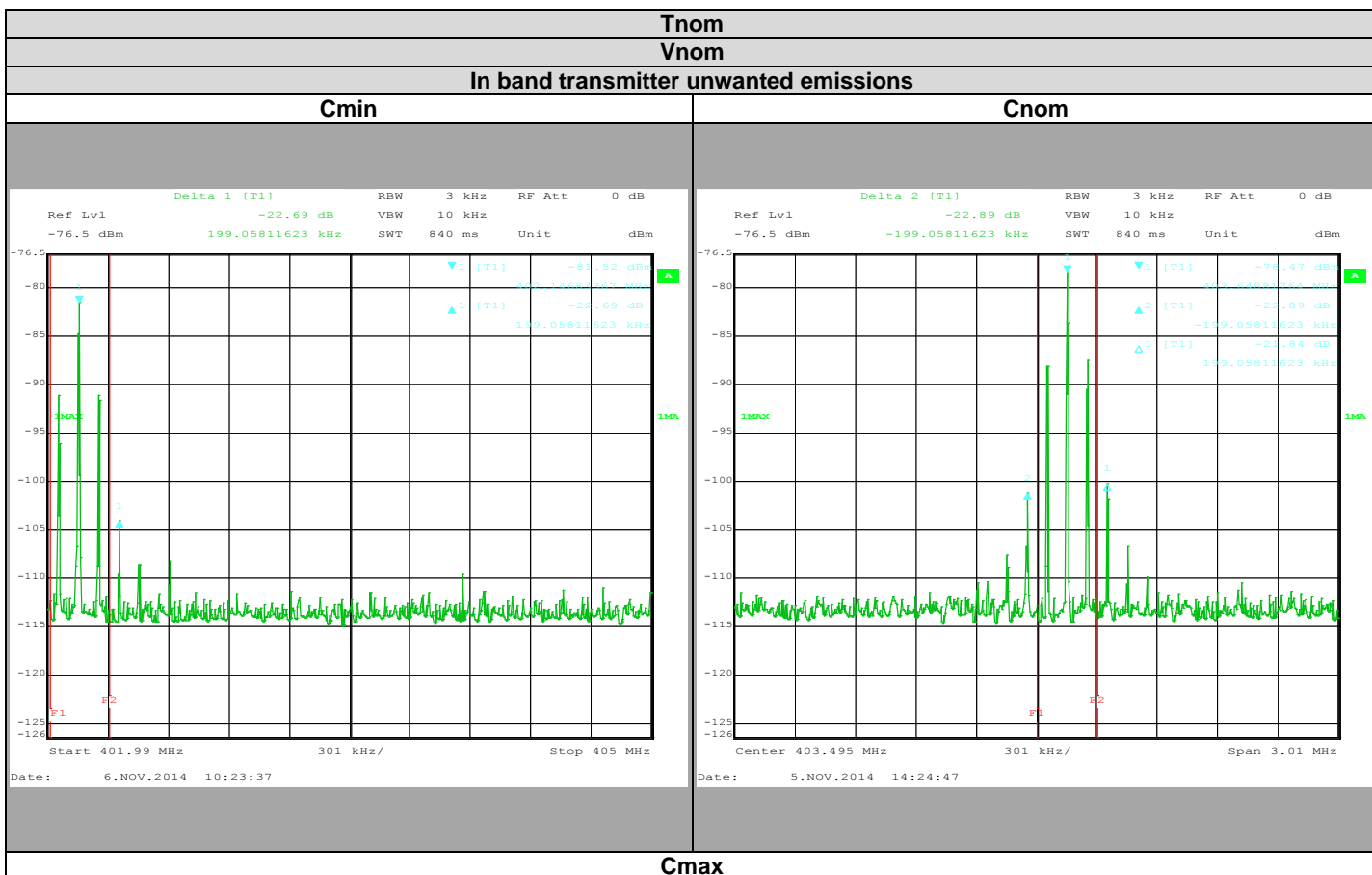

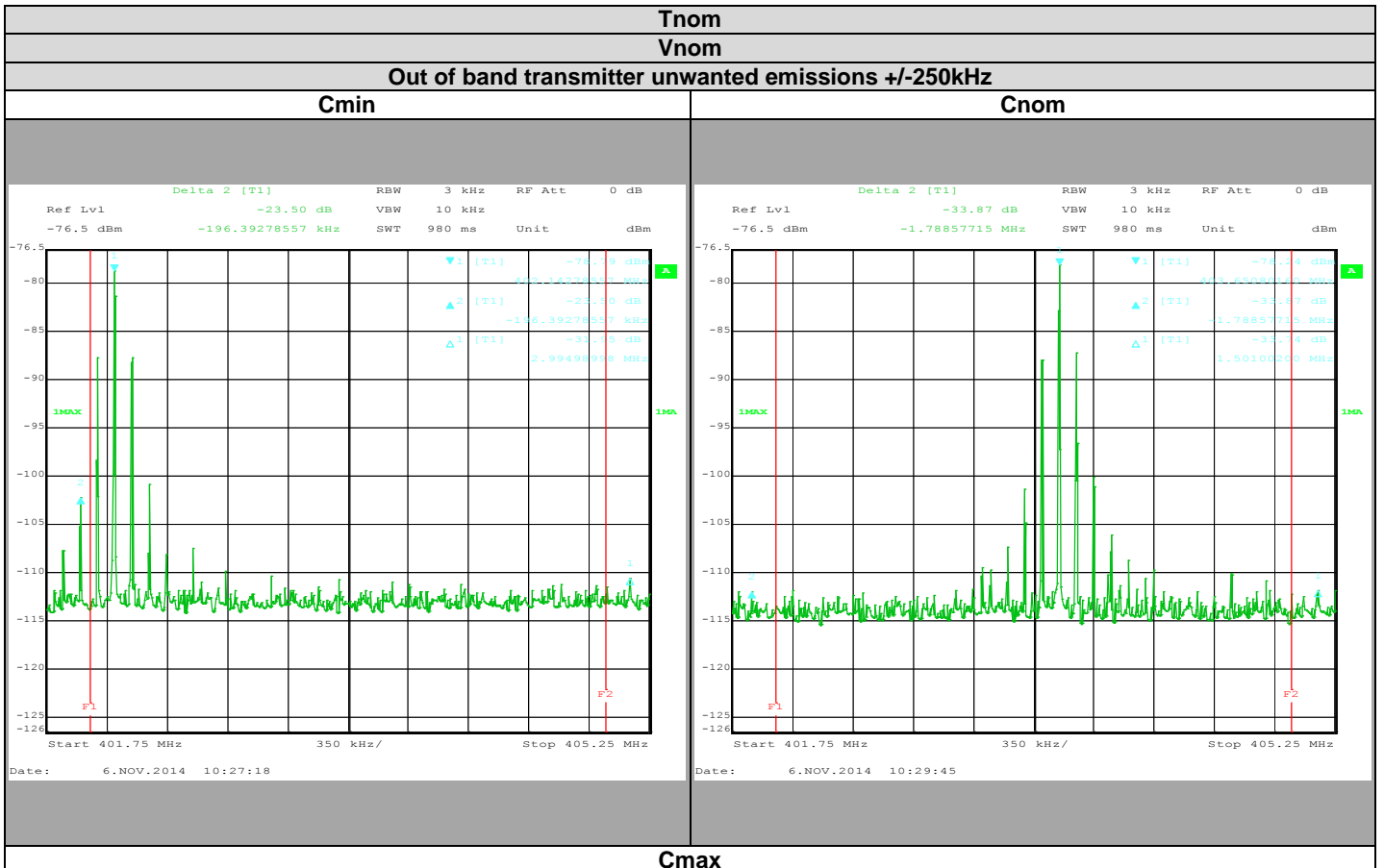
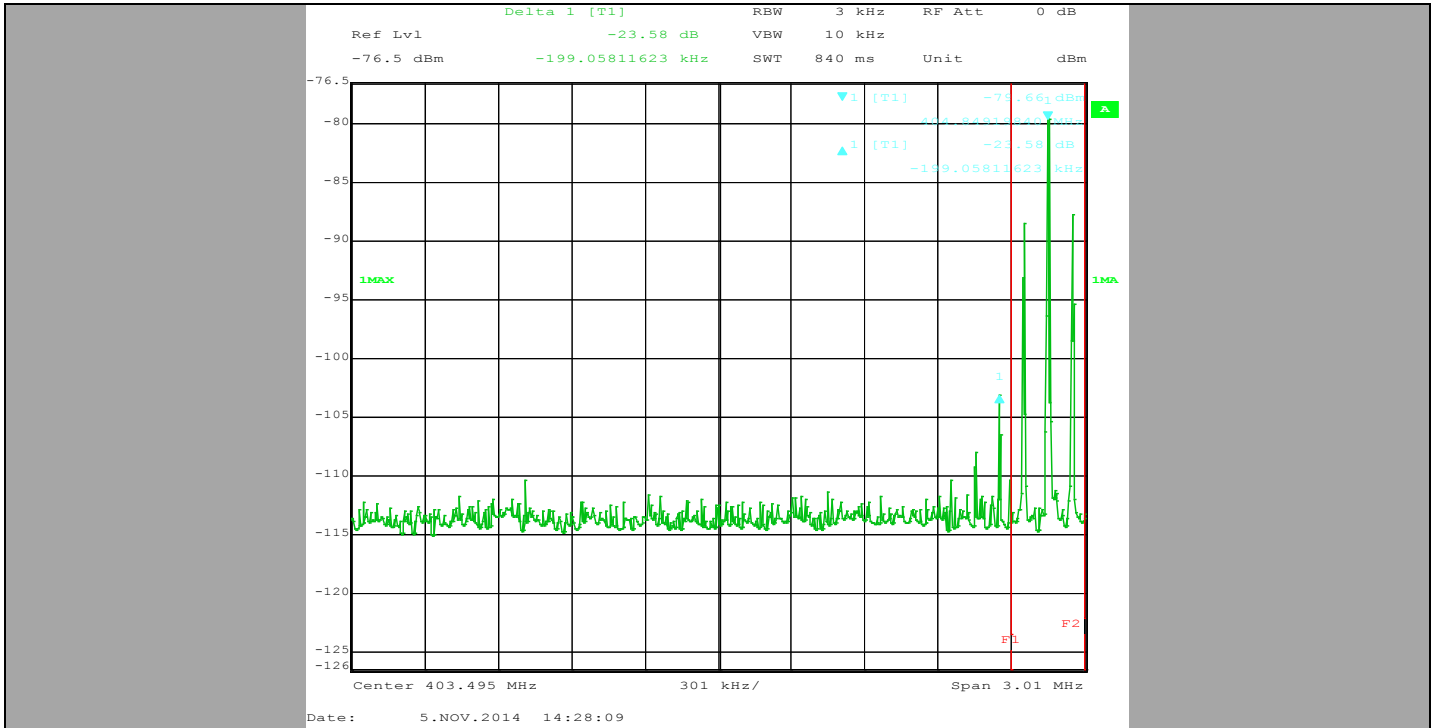

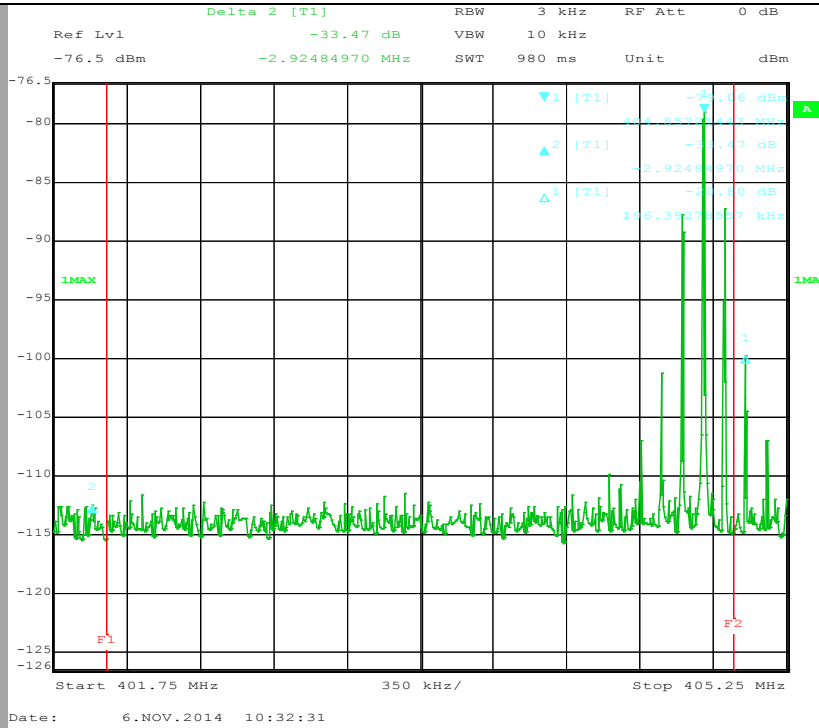



Out of band transmitter unwanted emissions			
Below 1GHz			
Polarization	Frequencies (MHz)	Quasi-Peak Level (dBµV/m)	Quasi-Peak Limit (dBµV/m)
Vertical	33.4	19.86	29.5
Vertical	34.5	23.08	29.5
Vertical	40	16.76	29.5
Vertical	44.1	15.33	29.5
Vertical	48.3	18.21	29.5
Vertical	60.4	16.12	29.5
Vertical	66.8	16.3	29.5
Vertical	72.2	16.34	29.5
Vertical	80	16.93	29.5
Vertical	123.7	21.74	33
Vertical	166	21.04	33
Vertical	200	19.32	33
Vertical	216	23.96	33
Horizontal	80	21.77	33
Horizontal	160	21.1	33
Horizontal	194.3	20.02	33
Horizontal	201.3	20.06	33



Detector peak

Out of band +/-250kHz transmitter unwanted emissions			
Channel	Level (dB) at Fmin	Level (dB) at Fmax	Limit (dB)
Cmin	23,50	31,95	At least 20
Cnom	33,87	32,74	At least 20
Cmax	33,47	20,80	At least 20

Detector peak

In band transmitter unwanted emissions			
Channel	Level (dB) at Fmin	Level (dB) at Fmax	Limit (dB)
Cmin	31,80	22,69	At least 20
Cnom	22,89	21,84	At least 20
Cmax	23,58	32,79	At least 20

7.7. CONCLUSION

The product SORIN Group SonR CRT-D 1811, SN:128DL02B, in configuration and description presented in this test report, complies with the Unwanted Emission into Restricted Bands measurement of FCC § 95.635(d) & RSS-243 § 5.5.

8. RECEIVER SPURIOUS EMISSIONS

8.1. TEST CONDITIONS

Test performed by : Laurent DENEUX
Date of test : 2014/11/20
Ambient temperature : 18°C
Relative humidity : 47%

8.2. TEST SETUP

- The Equipment under Test is installed:

SAR OATS

- Distance between EUT and the measuring antenna is:

3m 10m

- Choice of measuring antenna below 1GHz:

Bilog Log periodic Biconic Dipole antenna

- Choice of measuring antenna above 1GHz:

Horn

The product has been tested according to ANSI C63.10 (2009). Test is performed in horizontal (H) and vertical (V) polarization. Measurement bandwidth was 120kHz below 1GHz and 1MHz above 1GHz. The level has been maximised by the turntable rotation of 360 degrees range on the 3 axis of EUT. Antenna height search was performed from 1 to 4m.

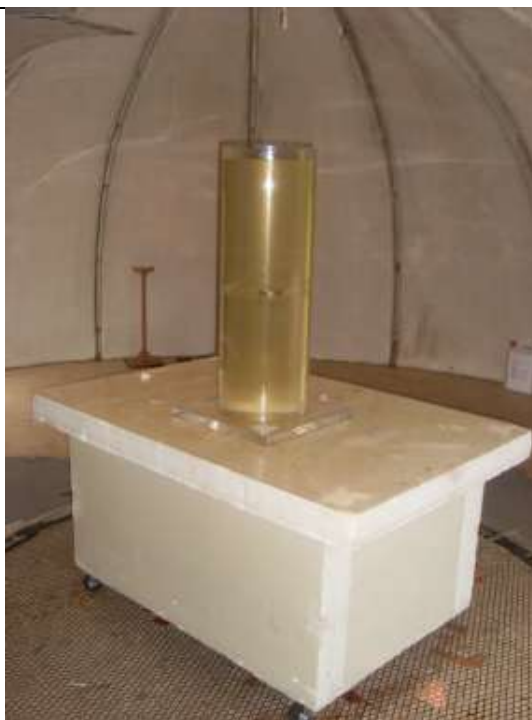

Photograph for Receiver spurious emissions



8.3. LIMIT

Receiver spurious emissions shall not exceed value below:

30MHz to 88MHz: 29.5dB μ V/m QPeak
 88MHz to 216MHz: 33dB μ V/m QPeak
 216MHz to 960MHz: 35.5dB μ V/m QPeak
 960MHz to 1000MHz: 43.5dB μ V/m QPeak
 Above 1000MHz: 63.5dB μ V/m Peak
 43.5dB μ V/m Average

8.4. TEST EQUIPMENT LIST

Apparatus	Trade Mark	Type	Registration number	Cal_Date	Cal_Due
EMI receiver	ROHDE & SCHWARZ	ESI40 1088 740K40	A2642010	2014/02	2015/02
Bilog antenna	CHASE	CBL 6112A	C2040040	2014-04	2015-04
Cable	-	-	A5329449	2014-09	2015-09
Cable	-	-	A5329368	2014-03	2015-03
Cable	-	-	A5329444	2014-09	2015-09
Cable	-	-	A5329542	2014-01	2015-01
OATS	L.C.I.E.	-	F2000400	2014-06	2015-06
Horn Antenna	EMCO	3115	C2042016	2014-04	2015-04
Preampli	HEWLETT PACKARD	8449B	A4069002	2014-04	2015-04
Climatic Chamber	MPC	F65/350L	D1025035	2013/12	2014/12
EMI receiver	ROHDE & SCHWARZ	FSIQ7	A4060040	2013/11	2014/11
Temperature Sensor	HP	34970A	A6440070	2014/01	2016/01

Note: In our system quality, calibration due is more & less 2 month.

8.5. DIVERGENCE, ADDITION OR SUPPRESSION ON THE TEST SPECIFICATION

None

Divergence:



8.6. GRAPHICS & RESULTS

Out of band transmitter unwanted emissions (below 1GHz)

400 Rx and 2.4 Rx mode

Quasi peak measurement

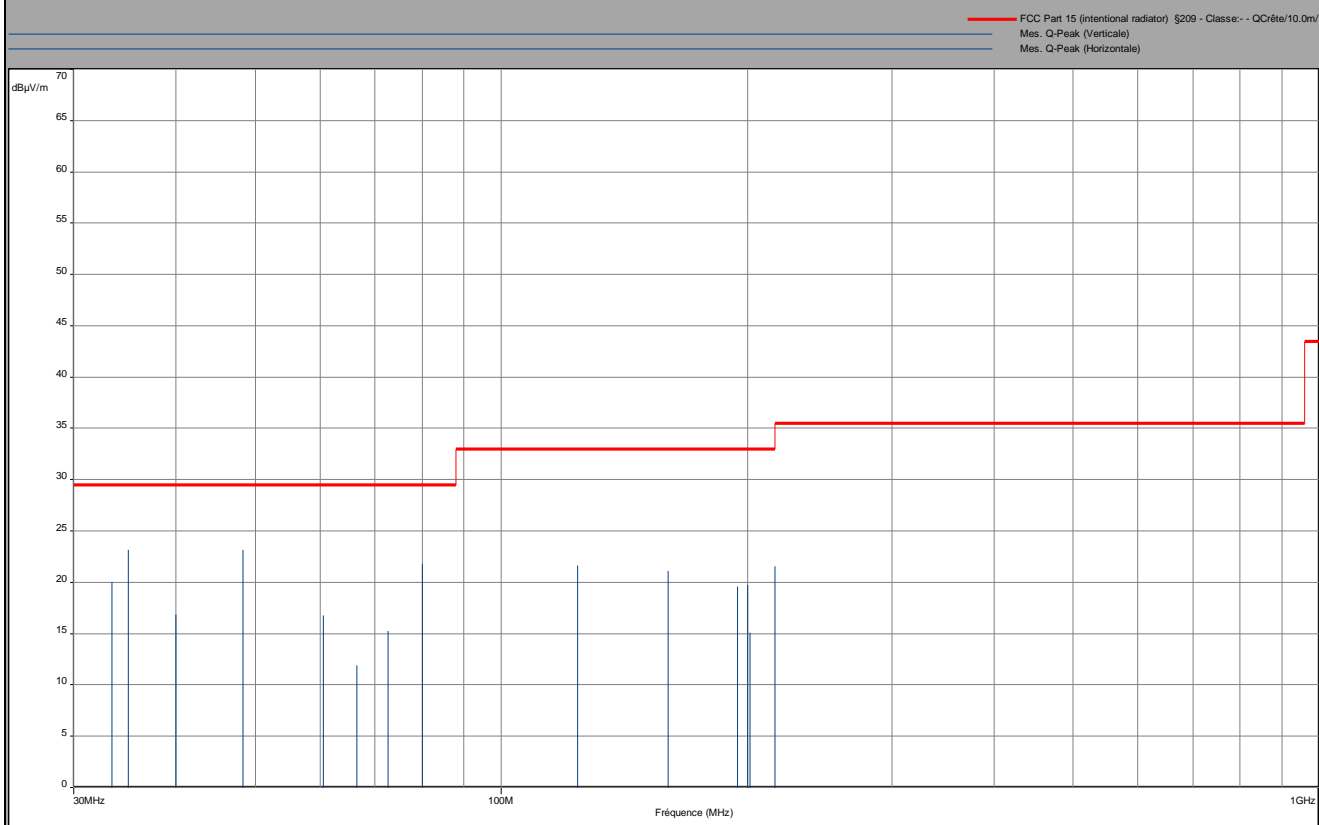



Out of band transmitter unwanted emissions			
Below 1GHz			
Polarization	Frequencies (MHz)	Quasi-Peak Level (dBµV/m)	Quasi-Peak Limit (dBµV/m)
Vertical	33.4	20.07	29.5
Vertical	35	23.18	29.5
Vertical	40	16.85	29.5
Vertical	48.3	23.22	29.5
Vertical	60.6	16.78	29.5
Vertical	66.5	11.92	29.5
Vertical	72.7	15.24	29.5
Vertical	123.8	21.67	33
Vertical	201.3	15.09	33
Vertical	216	21.61	33
Horizontal	80	21.84	33
Horizontal	160	21.11	33
Horizontal	194.4	19.61	33
Horizontal	200	19.76	33

8.7. CONCLUSION

The product SORIN Group SonR CRT-D 1811, SN:128DL02B, in configuration and description presented in this test report, complies with the receiver spurious emissions measurement of FCC 15.109 & RSS-243 5.6.



9. SAR EVALUATION

9.1. TEST CONDITIONS

Test performed by : Stéphane PHOUDIAH
Date of test : 2015/07/31
Ambient temperature : 26
Relative humidity : 32%

9.2. TEST SETUP

- The Equipment under Test is installed:

- In the climatic chamber
- On a table
- In an anechoic chamber

-Measurement is performed with a spectrum analyzer

- On the EUT conducted access
- With a test fixture

The spectrum analyzer marker peak functions is used to find the maximum rf conducted output power
Detector peak



Photograph for RF conducted output power



9.3. LIMIT

RSS-102 Issue 5 March 2015:

2.5.1 Exemption Limits for Routine Evaluation – SAR Evaluation

For medical implants devices, the exemption limit for routine evaluation is set at 1 mW. The output power of a medical implants device is defined as the higher of the conducted or e.i.r.p to determine whether the device is exempt from the SAR evaluation.

FCC:

KDB 447498 section 4.2.4:

4.2.4. Transmitters implanted in the body of a user

When the aggregate of the maximum power available at the antenna port and radiating structures of an implanted transmitter, under all operating circumstances, is ≤ 1.0 mW, SAR test exclusion may be applied. The maximum available output power requirement and worst case operating conditions must be supported by power measurement results and fully justified in a SAR analysis report, in lieu of the SAR measurement or numerical simulation, according to design and implementation requirements of the device.

9.4. TEST EQUIPMENT LIST

DESCRIPTION	MANUFACTURER	MODEL	N° LCIE	Cal_Date	Cal_Due
EMI test receiver	R&S	ESR	A2642023	03/2015	03/2016
RF cable & Attenuator	Télédyne & MINI CIRCUITS	920-0202-024 & FW-20+	A5329674	10/2014	10/2015

9.5. DIVERGENCE, ADDITION OR SUPPRESSION ON THE TEST SPECIFICATION

None Divergence:

9.6. GRAPHICS & RESULTS

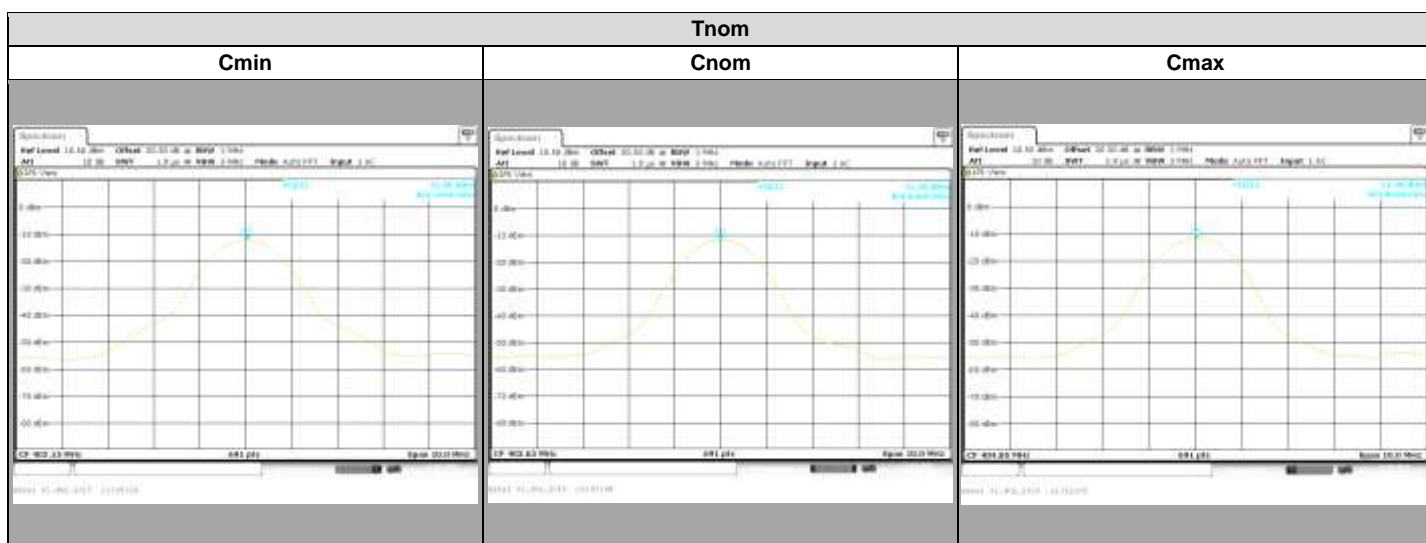



Temperature	Tnom		
Voltage	Vnom		
Channel	Cmin	Cnom	Cmax
RF conducted output power (dBm)	-11,98	-11,59	-11,4
RF conducted output power (mW)	0,063	0,069	0,072
EIRP (dBm)	-42,3	-44,2	-41,2
EIRP (mW)	0.000059	0.000038	0.000076

9.7. CONCLUSION

The product SORIN Group SonR CRT-D 1811, in configuration and description presented in this test report, is excluded of SAR evaluation.



10. UNCERTAINTIES CHART

Kind of test	Measurement uncertainties (k=2) $\pm x(\text{dB}) / (\text{Hz})$	Limit for uncertainties $\pm y(\text{dB})$
REQUIREMENTS		
RF output power, conducted	$\pm 0.6 \text{ dB}$	$\pm 1,5 \text{ dB}$
Power Spectral Density, conducted	$\pm 0.6 \text{ dB}$	$\pm 1,5 \text{ dB}$
Unwanted Emissions, conducted	$\pm 0.6 \text{ dB}$	$\pm 1,5 \text{ dB}$
Radiated emissions <ul style="list-style-type: none"> • Frequency < 1000 MHz • Frequency > 1000 MHz 	$\pm 3.9 \text{ dB}$ $\pm 3.1 \text{ dB}$	$\pm 6 \text{ dB}$
Temperature	$\pm 0.5^\circ\text{C}$	$\pm 1^\circ\text{C}$
Humidity	$\pm 2.5 \%$	$\pm 5 \%$