



L C I E

FCC SAR report analysis for SORIN Platinum Implantable Medical Devices

Reference: 131328-664446-AR-SAR

Version: E

Status: Approved

Date: 06/Oct/2015

Customer: SORIN CRM
Parc d'Affaires NOVEO
4 avenue Réaumur
92143 Clamart cedex

Products: SORIN Platinum cardioverter defibrillator

Author: Zorica COROLLEUR

Technical Manager: Marc CANCOUET

P.O. D. PRADON

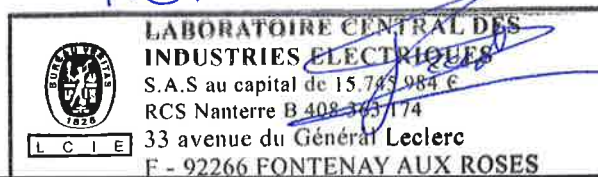

This document shall not be reproduced, except in full, without the written approval of the LCIE.

This document contains results related only to the items tested. It does not imply the conformity of the whole production to the items tested.



PUBLICATION HISTORY

VERSION	DATE	AUTHOR	MODIFICATION
A	25-Aug-15	Z.COROLLEUR	Creation of document
B	15-Sep-15	Z.COROLLEUR	Corrected FCC ID and Adding information on RF conducted output power
C	23-Sep-15	Z.COROLLEUR	Adding information about conducted power measurement
D	29-Sep-15	Z.COROLLEUR	Adding some internal photos
E	06-Oct-15	Z.COROLLEUR	Modification of document



CONTENTS

1.	INTRODUCTION.....	4
2.	RELATED DOCUMENTS	5
2.1.	APPLICABLE STANDARDS	5
2.2.	REFERENCE DOCUMENTS	5
3.	SORIN PLATINIUM IMD.....	6
3.1.	GENERAL DESCRIPTION OF SYSTEM.....	6
3.2.	GENERAL DESCRIPTION OF IMPLANTABLE MEDICAL DEVICE	7
3.3.	SCHEMATIC OF IMD.....	9
3.4.	ANTENNA CHARACTERISTIC OF IMD	10
3.5.	CHARACTERISTICS OF IMD.....	11
4.	TESTS RESULTS	12
4.1.	RESULTS OF RADIATED OUTPUT POWER.....	12
4.2.	RF CONDUCTED OUTPUT POWER	12
4.2.1	RUNNING MODE	12
4.2.2	TEST CONDITIONS.....	12
4.2.3	TEST SETUP	13
4.2.4	The access point for these RF measurements.....	14
4.2.5	TEST EQUIPMENT LIST	16
4.2.6	GRAPHICS & RESULTS	16
5.	CONCLUSION	18

1. INTRODUCTION

This document presents the results of tests performed on 8 SORIN PLATINIUM Implantable Medical Devices (IMD) to prove that all models are excluded of SAR evaluation.

The SORIN PLATINIUM Implantable Medical Devices (IMD) is Compliant according to FCC part 95I standards.

Hereafter is the list of models name and FCC ID:

Models	FCC ID
DR 1540	FCC ID YSGDR1540
VR 1240	FCC ID YSGVR1240
CRT-D 1741	FCC ID YSGCRTD1741
SonR CRT-D 1841	FCC ID YSGCRTDSOR1841
DR 1510	FCC ID YSGDR1510
VR 1210	FCC ID YSGVR1210
CRT-D 1711	FCC ID YSGCRTD1711
SonR CRT-D 1811	FCC ID YSGCRTDSOR1811





2. RELATED DOCUMENTS

2.1. APPLICABLE STANDARDS

[A1]	KDB 865664 D02	RF Exposure Compliance Reporting and Documentation Considerations
[A2]	47 CFR Part95I	Medical Device Radiocommunication Service (MedRadio)
[A3]	47 CFR PART15	Radio frequency devices

2.2. REFERENCE DOCUMENTS

[R1]	131328-664446E	Radio Test report of DR 1540
[R2]	131328-664446F	Radio Test report of VR 1240
[R3]	131328-664446G	Radio Test report of CRT-D 1741
[R4]	131328-664446H	Radio Test report of SonR CRT-D 1841
[R5]	131328-664445E	Radio Test report of DR 510
[R6]	131328-664445F	Radio Test report of VR 1210
[R7]	131328-664445G	Radio Test report of CRT-D 1711
[R8]	131328-664445H	Radio Test report of SonR CRT-D 1811
[R9]	MISC2583B	Tune up procedure

3. SORIN PLATINIUM IMD

3.1. GENERAL DESCRIPTION OF SYSTEM

The purpose of the paragraph is to provide a high-level description of the structure and operation of the following sub-systems of Sorin Remote Monitoring System: the Smartview Monitor and the Implantable Medical Device.

The Smartview Monitor (SM) is intended to collect patient's clinical data from an Implantable Medical Device (IMD) and transfer them to data management system (Back Office server).

The IMD is implanted into the patient's body. The Smartview Monitor is installed at patient home and is intended to collect data from the IMD remotely in absence of physician according to scheduled operation.



The Implantable Medical Device uses two wireless RF bands:

- ISM band (2.45 GHz) for communication initialization (implant wake-up) receiver only
- MedRadio (402-405 MHz) band for data transfer Implantable Medical Device (IMD) and transfer them to data management system (Back Office server).



3.2. GENERAL DESCRIPTION OF IMPLANTABLE MEDICAL DEVICE

PLATINIUM IMD is declined in 8 models:

Models
DR 1540
VR 1240
CRT-D 1741
SonR CRT-D 1841
DR 1510
VR 1210
CRT-D 1711
SonR CRT-D 1811

All models are an implantable cardioverter defibrillator for the recognition and treatment of ventricular tachycardia and fibrillation, with ventricular resynchronization, in patients with spontaneous or inducible tachyarrhythmias.

Each IMD is equipped with an accelerometer to allow adaptation of pacing to suit the patient's activity, and provide high energy shocks (42 J) for enhanced safety, as well as automatic lead measurements to monitor system integrity.

PLATINIUM IMD is protected against high-frequency signals emitted by cellular telephones.

Device and lead connections:

PLATINIUM CRT-D 1711	3*IS-1 bipolar (LV unipolar compatible), 2*DF-1
PLATINIUM CRT-D 1741	2*IS-1 bipolar (LV unipolar compatible), 1*DF4
PLATINIUM SonR CRT-D 1811	2*IS-1 bipolar (LV unipolar compatible), 2*DF-1, 1*SonR (IS-1bipolar compatible)
PLATINIUM SonR CRT-D 1841	1*IS-1 bipolar (unipolar compatible), 1*DF4, 1*SonR (IS-1 bipolar compatible)
PLATINIUM DR 1510	2*IS-1 bipolar, 2*DF-1
PLATINIUM DR 1540	1*IS-1 bipolar, 1*DF4
PLATINIUM VR 1210	1*IS-1 bipolar, 2*DF-1
PLATINIUM VR 1240	1*DF4

Type	Model	FCC Number	Implantable cardioverter defibrillator	Implantable cardioverter defibrillator with cardiac resynchronization	photos	Leads connection
DF1	DR 1510	FCC ID YSGDR1510	X			
	CRT-D1711	FCC ID YSGCRTD1711		X		
	VR 1210	FCC ID YSGVR1210	X			
	SonR CRT-D 1811	FCC ID YSGCRTDSOR1811			X	
DF4	DR 1540	FCC ID YSGDR1540	X			
	CRT-D1741	FCC ID YSGCRTD1741		X		
	VR 1240	FCC ID YSGVR1240	X			

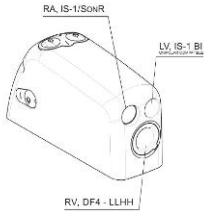
	SonR CRT-D 1841	FCC ID YSGCRTDSOR184 1		X		
--	--------------------	------------------------------	--	---	---	---

DF-1 refers to the international standard for defibrillation lead connectors (ISO 11318:2002).

DF4 refers to the international standard for defibrillation lead connectors (ISO 27186:2010).

3.3. SCHEMATIC OF IMD

All models are using the same architecture: Battery, Capacitor and RF hardware. The only difference is the dimension of antenna and the numbers of leads.

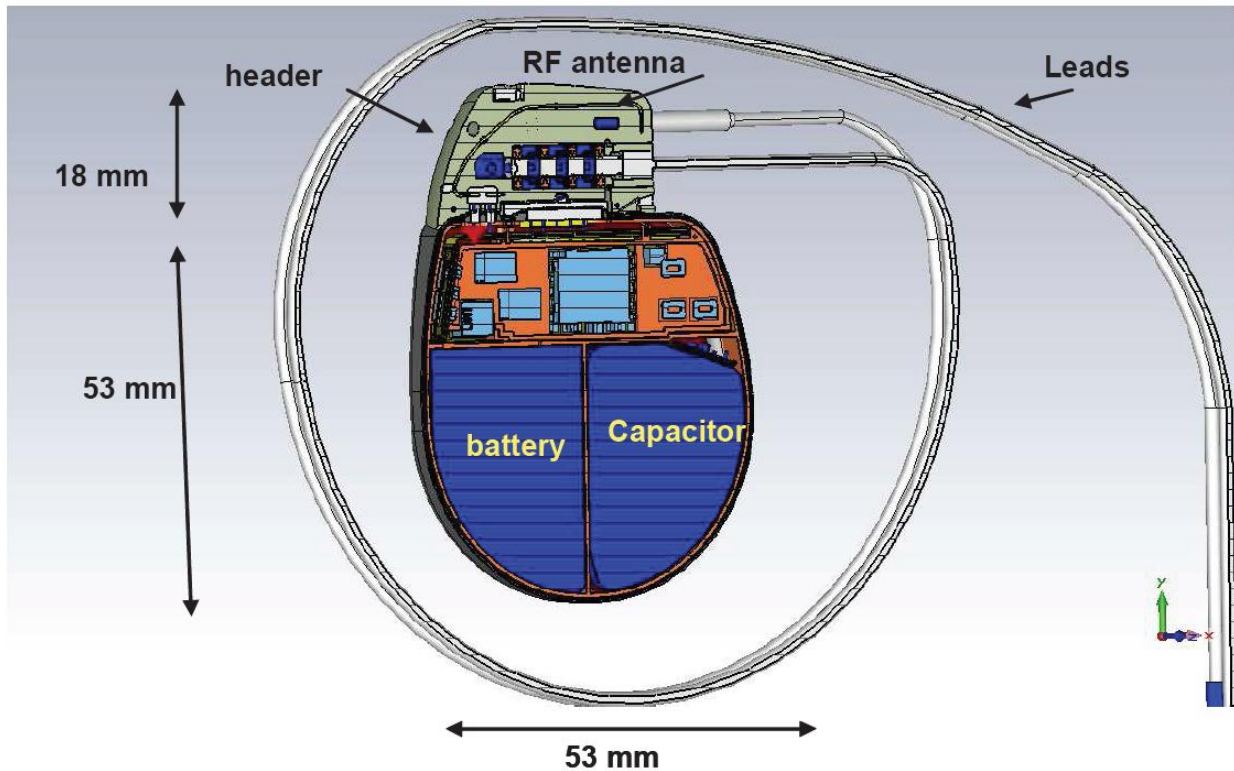

3.4. ANTENNA CHARACTERISTIC OF IMD

The RF antenna consists in a gold wire loop of 0.4 mm diameter. It is the same for the SonR CRT-D, the CRT-D, the DR and the VR header of the DF1 family. The dimensions of antennas are illustrated in the following figures.

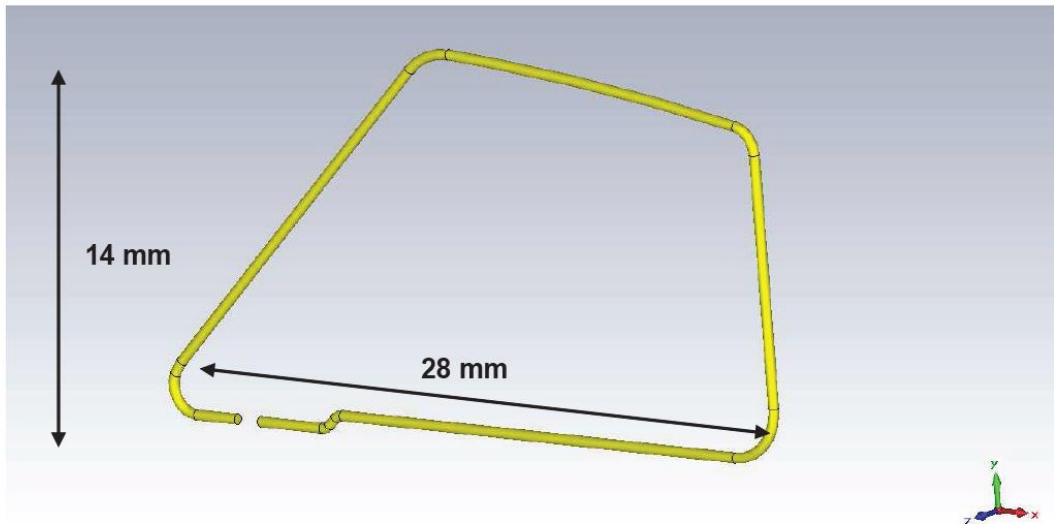

RF antenna of the DF1 SonR, Crt-d, Dr and Vr headers

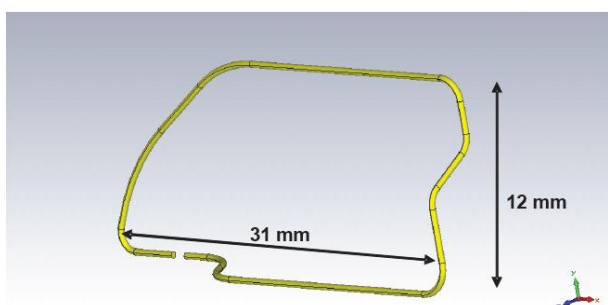

SonR, Crt-d, Dr

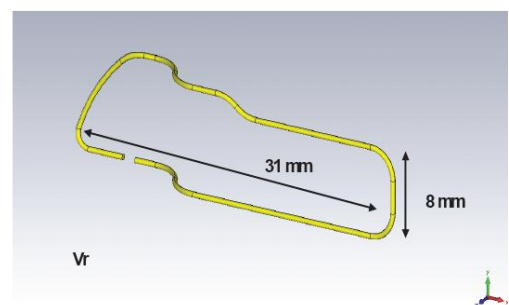

Vr

RF antenna of the DF4 SonR, Crt-d, Dr and Vr headers



3.5. CHARACTERISTICS OF IMD

• **Software identification:**

-Software version: ROM V2

• **Equipment information:**

- Modulation: 2FSK

- Transmit operating mode: Multiples antenna
 Single antenna

- Number of transmit chains: 1 2

- Number of receiver chains: 1 2

- Antenna type: Integral External

- Type of the equipment: Stand-alone equipment Plug-in radio device Combined equipment

- Temperature range: Tmin: -20°C 0°C 25°C
Tnom: 37°C
Tmax: +35°C 55°C 45°C

- Test source voltage: Vmin: 207V/50Hz 2.5Vdc
Vnom: 230V/50Hz 2.62Vdc
Vmax: 253V/50Hz 3.24Vdc

- Type of power source: Battery (Lithium-Ion) Internal power supply
 External power supply Car Charger

- Test sequence/test software used:

- Duty Cycle: Continuous duty Intermittent duty Continuous operation

- Equipment type: Representative production model Pre-production model

Operating frequency range:

Frequency Band (MHz)	
2400MHz to 2483,5MHz	<input checked="" type="checkbox"/>
5150MHz to 5350MHz	<input type="checkbox"/>
5470MHz to 5725MHz	<input type="checkbox"/>
402MHz to 405MHz	<input checked="" type="checkbox"/>

-Channel plan:

Channel	Frequency (MHz)
Cmin: 0	402.15
1	402.45
2	402.75
3	403.05
4	403.35
Cnom:5	403.65
6	403.95
7	404.25
8	404.55
Cmax: 9	404.85



4. TESTS RESULTS

4.1. RESULTS OF RADIATED OUTPUT POWER

Below are the measured Radiated EIRP Powers, for details please refer to EMC test report.

Models	FCC ID	Reference to test Report	Max measured EIRP(μ W)	EIRP Limit (μ W)
DR 1540	FCC ID YSGDR1540	131328-664446E	0,047	25
VR 1240	FCC ID YSGVR1240	131328-664446F	0,075	25
CRT-D 1741	FCC ID YSGCRTD1741	131328-664446G	0,047	25
SonR CRT-D 1841	FCC ID YSGCRTDSOR1841	131328-664446H	0,059	25
DR 1510	FCC ID YSGDR1510	131328-664445E	0,047	25
VR 1210	FCC ID YSGVR1210	131328-664445F	0,059	25
CRT-D 1711	FCC ID YSGCRTD1711	131328-664445G	0,076	25
SonR CRT-D 1811	FCC ID YSGCRTDSOR1811	131328-664445H	0,076	25

4.2. RF CONDUCTED OUTPUT POWER

4.2.1 RUNNING MODE

The EUT is set in the following mode during tests:

- Continued transmission with modulation on an assigned channel at the highest power

4.2.2 TEST CONDITIONS

Test performed by : Mathieu CERISIER
Date of test : 2015/07/31
Ambient temperature : 26
Relative humidity : 32%

4.2.3 TEST SETUP

- The Equipment under Test is installed:

- In the climatic chamber
- On a table
- In an anechoic chamber

-Measurement is performed with a spectrum analyzer

- On the EUT 50 ohms conducted access
- With a test fixture

-Spectrum analyzer setup detail:

RBW: 1 MHz

VBW: 3 MHz

Detector type: peak

Sweep time: 1.9 μ s

The spectrum analyzer marker peak function is used to find the maximum RF conducted output power.

Since all 8 models use the same RF circuit and have identical RF characteristics (such as output power, Tx frequencies and modulations...etc) the tests were performed directly on one identical representative RF circuits mounted on SORIN workbench (note: SORIN workbench is a special test fixture provided by SORIN for controlling the testing mode and access to the EUT RF port for SORIN Implantable Medical Devices series and as shown below in the picture)

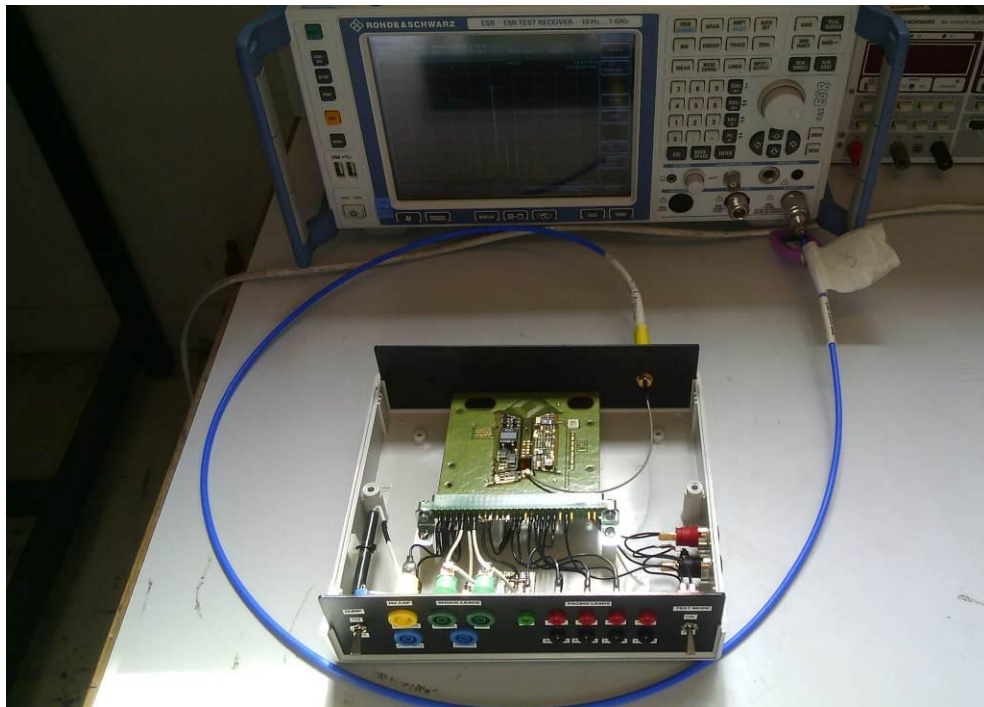

Photograph for RF conducted output power

4.2.4 THE ACCESS POINT FOR THESE RF MEASUREMENTS

All 8 models are using the same architecture: Battery, Capacitor and RF hardware. The only difference is the dimension of the antenna and the numbers of leads.

The hardware components are soldered on flex PCB. The flex PCB is folded and integrated in the IMD. Therefore testing one representative RF circuit is enough to cover all 8 modules' RF conducted characteristics.

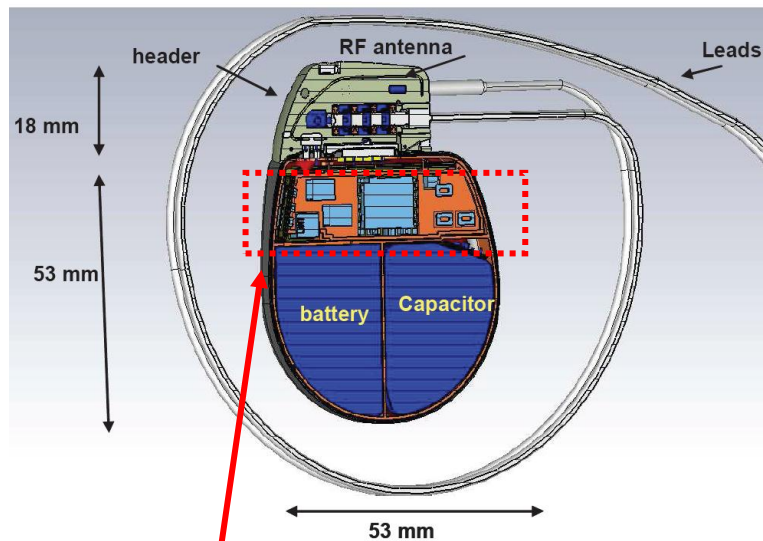

The flex PCB is folded and integrated in IMD.

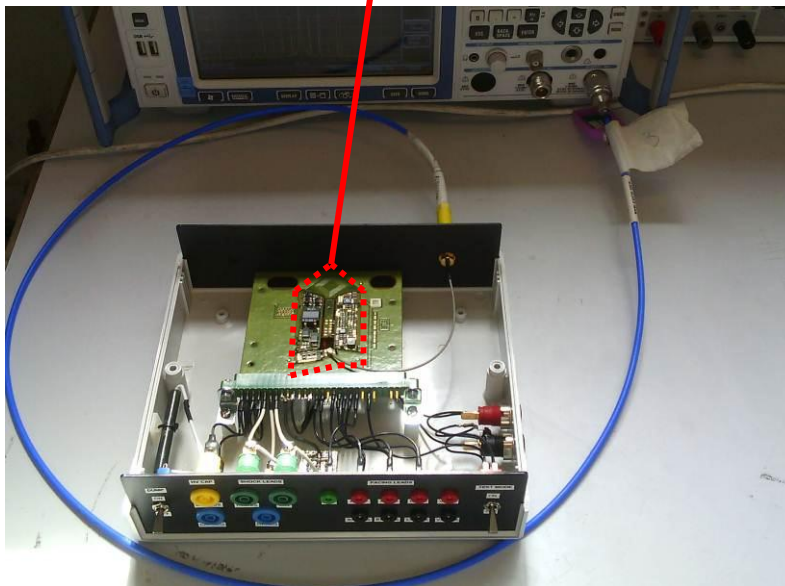

The access point for these RF measurements is illustrated above.

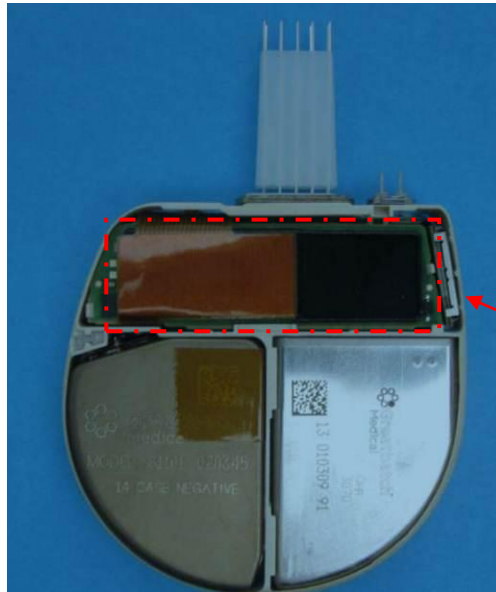

The flex PCB is folded and integrated in IMD.

Internal photo of EUT

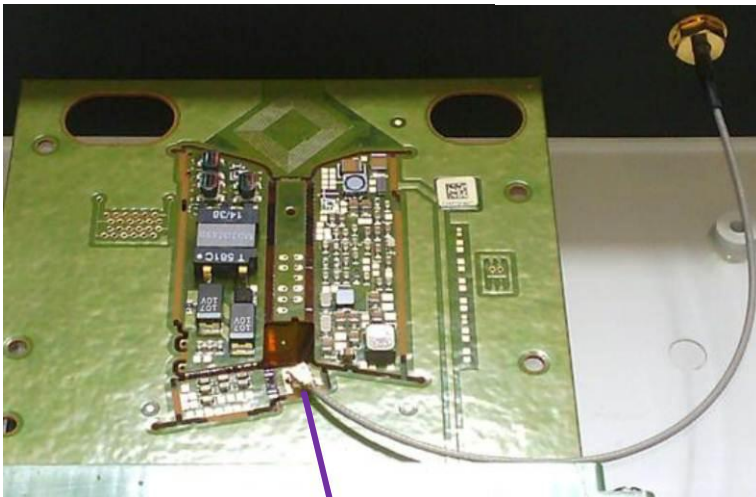

BOTTOM VIEW of Flex PCB

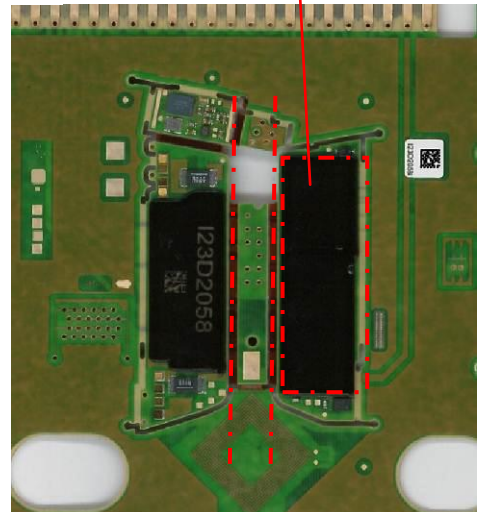

TOP VIEW of Flex PCB



Zoom on UFL connector

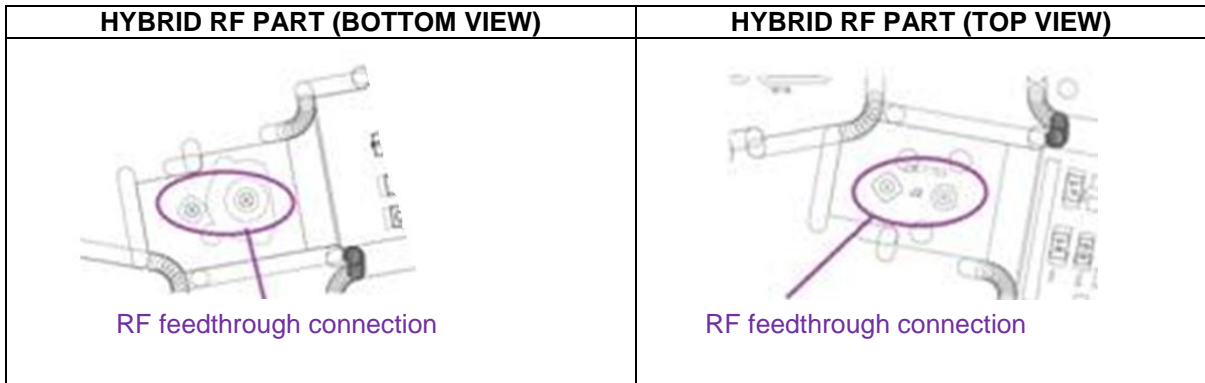

Above figures show RF feedthrough pads on PCB for antenna connection and all RF traces on the PCB were designed for standard 50 ohm system. For reliable RF measurements, SORIN has installed a UFL connector directly on the antenna contact point for us to verify the actual RF output power to the antenna. The above setup pictures also show that the measurement system uses 50 ohm coaxial cable for connecting the EUT to spectrum analyzer. Therefore, the load impedance seen by the EUT (Equipment Under Test) is at optimum 50 ohm for max power output and cable loss has been considered and added back to the reading.

4.2.5 TEST EQUIPMENT LIST

DESCRIPTION	MANUFACTURER	MODEL	N° LCIE	Cal_Date	Cal_Due
EMI test receiver	R&S	ESR	A2642023	03/2015	03/2016
RF cable & Attenuator	Teledyne & MINI CIRCUITS	920-0202-024 & FW-20+	A5329674	10/2014	10/2015

4.2.6 GRAPHICS & RESULTS

Since all 8 models share the same RF circuit and have identical RF characteristics, the following conducted power measurement result is applicable to all 8 models.

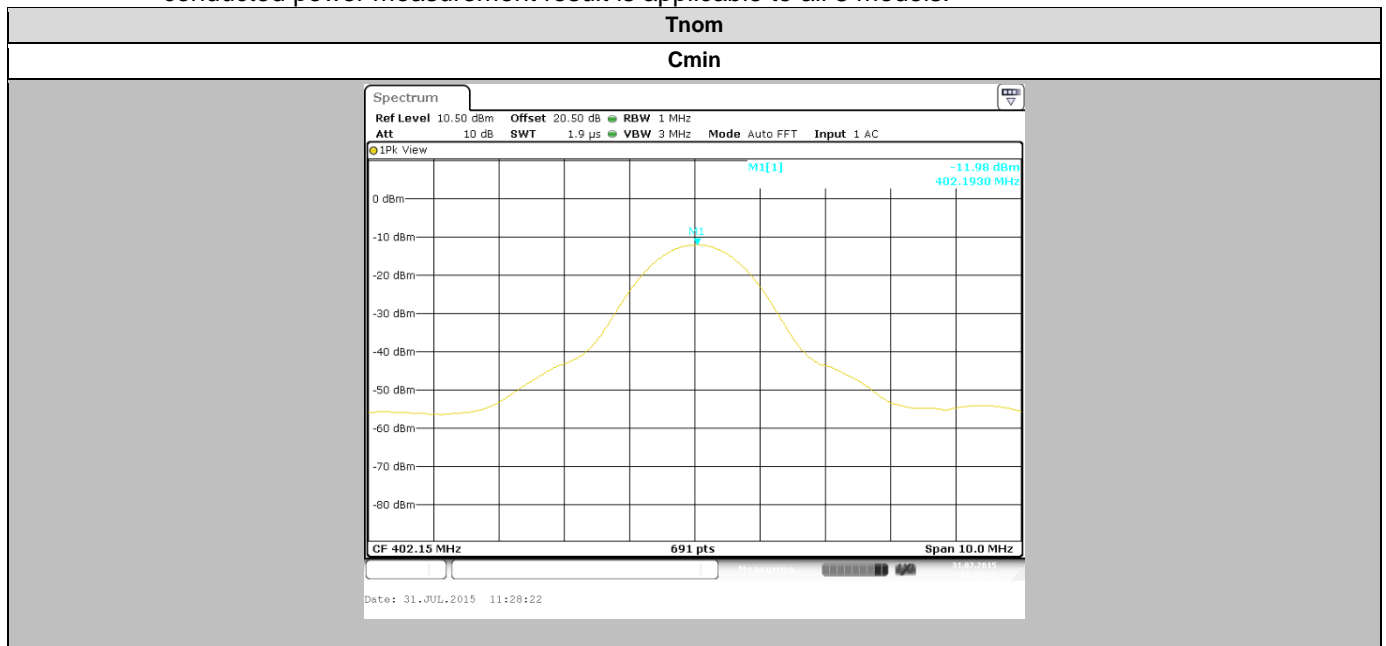

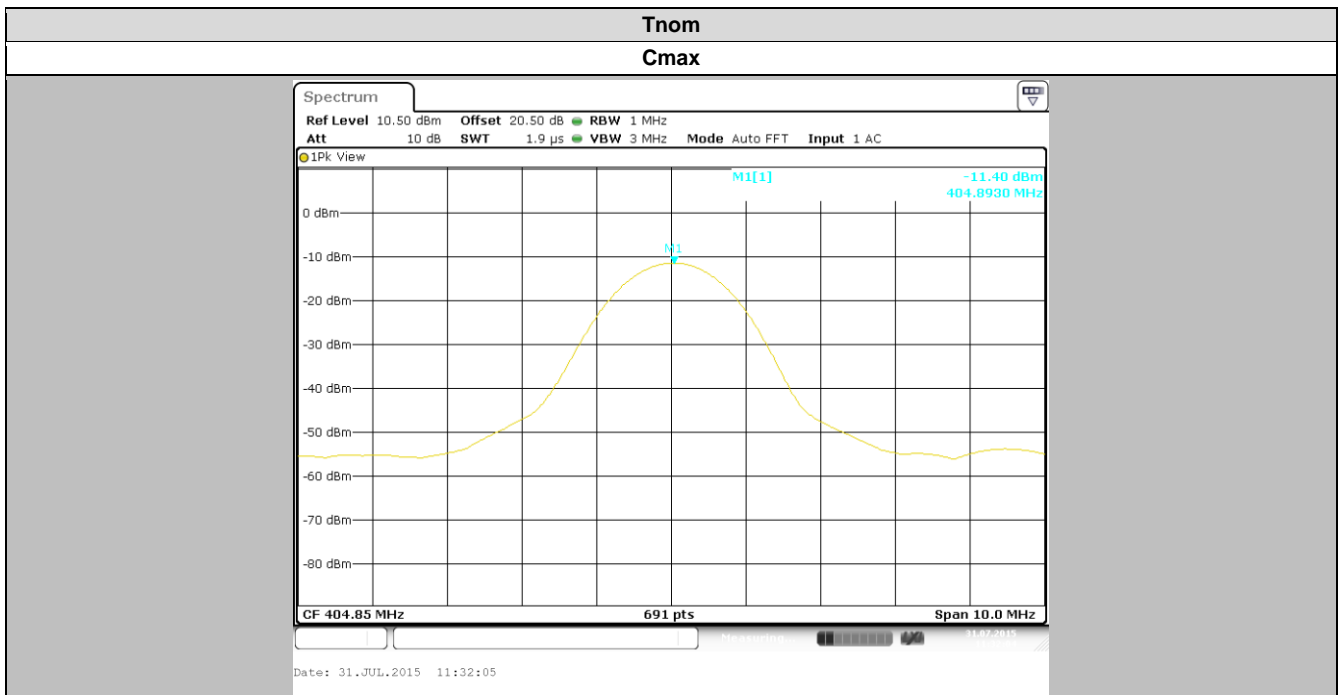
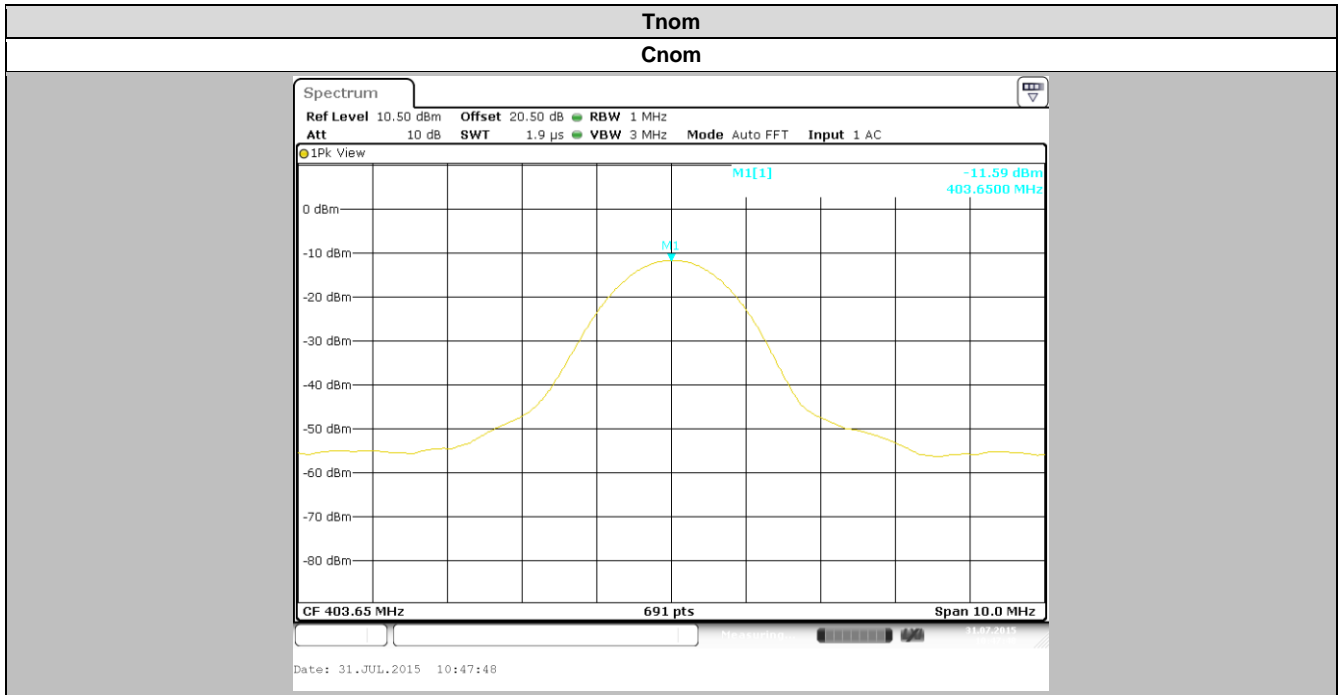

Temperature	Tnom		
Voltage	Vnom		
Channel	Cmin	Cnom	Cmax
RF conducted output power (dBm)	-11,98	-11,59	-11,4
RF conducted output power (mW)	0,063	0,069	0,072

All measurements are recorded in test reports listed in 4.1.



5. CONCLUSION

Since the test results, as reported in the previous section, demonstrate that both conducted and EIRP power plus 0.5dB tuneup tolerance are less than 1 mW, we would like to request FCC to grant SAR test exemption to all 8 of these applications according to FCC KDB 447498 section 4.2.4, as reprinted below. Thank you.

FCC:

KDB 447498 section 4.2.4:

4.2.4. Transmitters implanted in the body of a user

When the aggregate of the maximum power available at the antenna port and radiating structures of an implanted transmitter, under all operating circumstances, is ≤ 1.0 mW, SAR test exclusion may be applied. The maximum available output power requirement and worst case operating conditions must be supported by power measurement results and fully justified in a SAR analysis report, in lieu of the SAR measurement or numerical simulation, according to design and implementation requirements of the device.

☞END OF DOCUMENT☞