



IMPLANTABLE CARDIOVERTER DEFIBRILLATOR WITH CARDIAC RESYNCHRONIZATION THERAPY CRT-D MODELS

IMPLANT MANUAL

SORIN PLATINIUM CRT-D

Reminder

Battery depletion

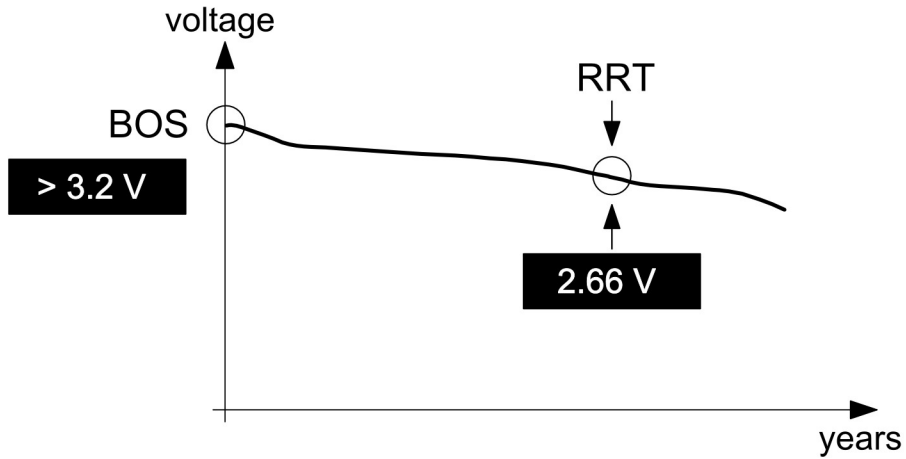

Leads connection - 1741 model

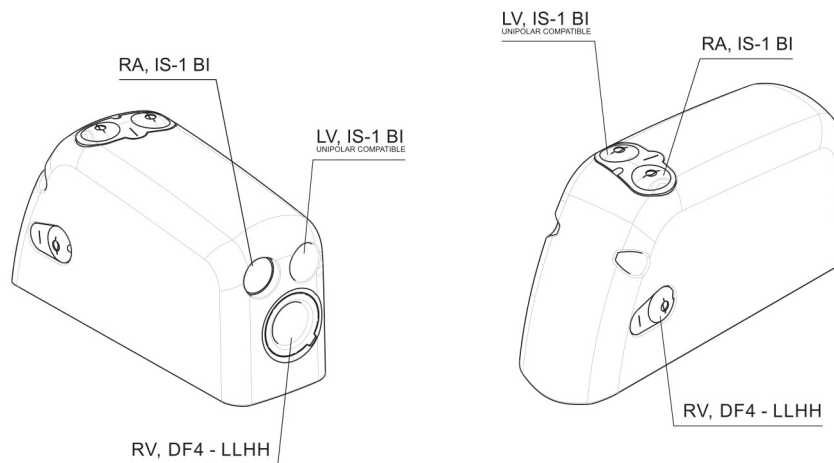

Leads connection - 1711 model

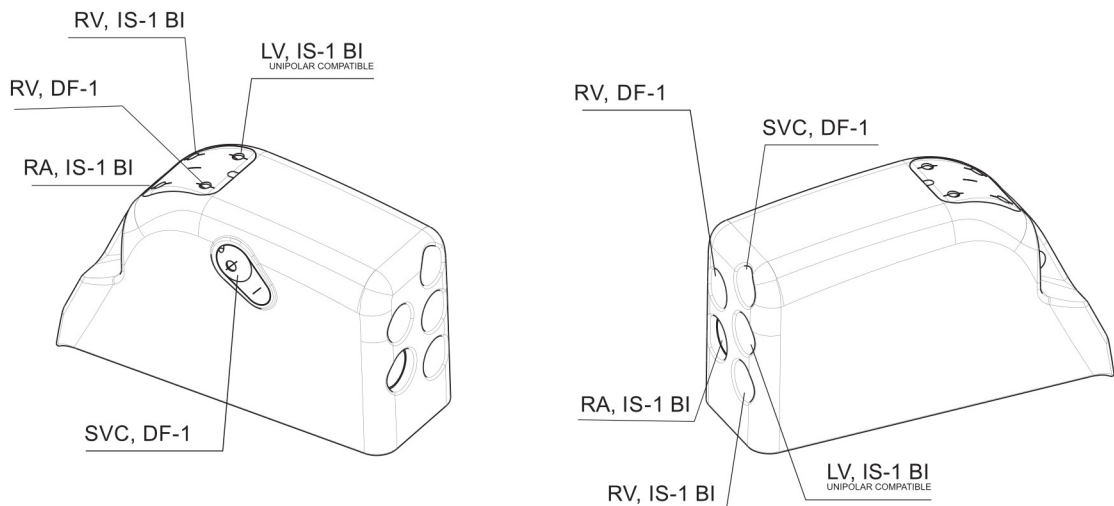

TABLE OF CONTENTS

| | |
|---|-----------|
| 1. General description..... | 5 |
| 2. Indications..... | 6 |
| 3. Contraindications..... | 7 |
| 4. Warnings and precautions..... | 8 |
| 4.1. Risks related to medical environment..... | 9 |
| 4.2. Sterilization, storage and handling..... | 10 |
| 4.3. Implantation and device programming..... | 10 |
| 4.4. Lead evaluation and lead connection..... | 11 |
| 4.5. Generator explant and disposal..... | 12 |
| 5. Adverse events..... | 13 |
| 5.1. MSP study..... | 13 |
| 5.2. Potential adverse events..... | 14 |
| 6. Clinical studies..... | 16 |
| 6.1. MSP clinical study..... | 16 |
| 7. Patient selection and treatment..... | 20 |
| 7.1. Individualization of treatment..... | 20 |
| 7.2. Specific patient populations..... | 21 |
| 8. Patient counselling information..... | 22 |
| 9. Declaration of conformity..... | 23 |
| 10. Physician guidelines..... | 25 |
| 10.1. Physician training..... | 25 |
| 10.2. Directions for use..... | 25 |
| 10.3. Maintaining device quality..... | 25 |
| 11. Patient information..... | 27 |
| 12. How supplied..... | 28 |
| 12.1. Sterility..... | 28 |
| 12.2. Warranty and replacement policy..... | 28 |
| 13. Device description..... | 29 |
| 14. Implant procedure..... | 31 |
| 14.1. Necessary equipment..... | 31 |
| 14.2. Packaging..... | 31 |
| 14.3. Optional equipment..... | 31 |
| 14.4. Before opening the package..... | 32 |
| 14.5. Prior to implantation..... | 32 |
| 14.6. Device placement..... | 32 |
| 14.7. Choosing the type of lead..... | 32 |
| 14.8. Shock configuration (+ -> -)..... | 33 |
| 14.9. Measurement of thresholds at implant..... | 34 |
| 14.10. Leads connection..... | 34 |
| 14.11. Device implantation..... | 35 |
| 14.12. Tests and programming..... | 36 |
| 15. Special modes..... | 37 |
| 15.1. Safety mode (nominal values)..... | 37 |
| 15.2. Magnet mode..... | 37 |

| | |
|--|-----------|
| 15.3. Response in the presence of disturbance..... | 37 |
| 15.4. Detection characteristics in the presence of electromagnetic fields..... | 37 |
| 15.5. Protection against short-circuits..... | 39 |
| 16. Main functions..... | 40 |
| 16.1. Automatic lead measurements..... | 40 |
| 16.2. Atrial tachyarrhythmia management..... | 40 |
| 16.3. Ventricular tachyarrhythmia management..... | 40 |
| 16.4. Pacing..... | 41 |
| 16.5. Sensing..... | 41 |
| 16.6. Follow-up function..... | 42 |
| 16.7. Remote Monitoring function..... | 42 |
| 17. Patient follow-up..... | 45 |
| 17.1. Follow-up recommendations..... | 45 |
| 17.2. Holter Function..... | 45 |
| 17.3. Recommended Replacement Time (RRT)..... | 46 |
| 17.4. Explantation..... | 46 |
| 17.5. Defibrillator identification..... | 47 |
| 18. Supplemental Information..... | 48 |
| 18.1. Adverse events in the SafeR (AAI <> DDD) study..... | 48 |
| 18.2. SafeR (AAI <> DDD) clinical study..... | 49 |
| 19. Physical characteristics..... | 51 |
| 19.1. Materials used..... | 51 |
| 20. Electrical characteristics..... | 52 |
| 20.1. Table of delivered shock energy and voltage..... | 52 |
| 20.2. Battery..... | 52 |
| 20.3. Longevity..... | 53 |
| 21. Programmable parameters..... | 55 |
| 21.1. Antibradycardia pacing..... | 55 |
| 21.2. Ventricular tachyarrhythmia detection..... | 60 |
| 21.3. Ventricular tachyarrhythmia therapies..... | 61 |
| 21.4. Remote alerts and warnings..... | 64 |
| 22. Non programmable parameters..... | 66 |
| 23. Limited warranty..... | 67 |
| 24. Patents..... | 68 |
| 25. Explanation of symbols..... | 69 |

1. GENERAL DESCRIPTION

PLATINIUM CRT-D is an implantable cardioverter defibrillator for the recognition and treatment of ventricular tachycardia and fibrillation, with ventricular resynchronization, in patients with spontaneous or inducible tachyarrhythmias.

PLATINIUM CRT-D is equipped with an accelerometer to allow adaptation of pacing to suit the patient's activity.

PLATINIUM CRT-D is also equipped with the RF wireless technology which enables:

- Remote monitoring of patients who have the Sorin SMARTVIEW Monitor installed at home,
- wireless interrogation and device programming by Orchestra Plus programmer equipped with ORCHESTRA PLUS LINK accessory.

PLATINIUM CRT-D provides high energy shocks (42 J) for enhanced safety, as well as automatic lead measurements to monitor system integrity.

PLATINIUM CRT-D is protected against high-frequency signals emitted by cellular telephones.

Device and lead connections:

| | |
|-----------------------------|---|
| PLATINIUM CRT-D 1711 | 3*IS-1 bipolar (LV unipolar compatible), 2*DF-1 |
| PLATINIUM CRT-D 1741 | 2*IS-1 bipolar (LV unipolar compatible), 1*DF4 |

2. INDICATIONS

PLATINIUM CRT-D is indicated for ventricular antitachycardia pacing and ventricular defibrillation for automated treatment of life threatening arrhythmias.

The device is also indicated for the reduction of heart failure symptoms in medically optimized NYHA Functional Class III and IV patients with left ventricular ejection fraction of 35% or less, and a QRS duration of 150 ms or longer.

3. CONTRAINDICATIONS

Implantation of PLATINIUM CRT-D is contraindicated in patients:

- whose ventricular tachyarrhythmias may have transient or reversible causes such as: acute myocardial infarction, digitalis intoxication, drowning, electrocution, electrolyte imbalance, hypoxia, sepsis, or unstable ischemic episodes,
- who present incessant tachyarrhythmia,
- who have an internal pacemaker,
- whose primary disorder is bradyarrhythmias, or atrial tachyarrhythmias.

The use of the dual-chamber pacing mode is contraindicated in patients with chronic refractory atrial tachyarrhythmias.

4. WARNINGS AND PRECAUTIONS

The patient should be warned of the potential risks of defibrillator malfunction if he is exposed to external magnetic, electrical, or electromagnetic signals.

These potential interference sources may cause conversion to inhibited mode (because of noise detection), erratic delivery of VT or VF therapies, nominal programming, or much more rarely, irreversible damage to the device's circuits.

The main sources of high magnitude disturbance are: powerful radiofrequency equipment (radar), industrial motors and transformers, induction furnaces, resistance, arc-welding equipment and high power loudspeakers.

Electrical Isolation:

Do not permit the patient to contact grounded equipment that could produce hazardous leakage current. Ensuing arrhythmia induction could result in the patient's death.

Antitheft gates:

Since antitheft devices at the entrance to stores are not subject to any safety standards, it is advisable to spend as little time as possible in their vicinity.

Airport detection systems:

Since airport detection systems are not subject to any safety standards, it is advisable to spend as little time as possible in their vicinity.

Work environment:

The patient's work environment may be an important source of disturbance. In that case, specific recommendations may be required.

High voltage power transmission lines:

High voltage power transmission lines may generate enough disturbance to interfere with defibrillator operation if approached too closely.

Communication equipment:

Communication equipment such as microwave transmitters, linear power amplifiers, or high-power amateur transmitters may generate enough disturbance to interfere with defibrillator operation if approached too closely.

Home appliances:

Home appliances that are in good working order and properly grounded do not usually produce enough disturbance to interfere with defibrillator operation. However, there are reports of device interferences caused by electric hand tools or electric razors used directly over the device implant site. Patient should also avoid using induction ovens and cookers.



CAUTION: Do not tap sharply on the ICD can after implant, because the ICD's sensing circuits can detect this as P-waves or R-waves, and such oversensing could result in inappropriate pacing, inhibition, or therapy. Normal activities after implant do not result in such oversensing.

4.1. RISKS RELATED TO MEDICAL ENVIRONMENT

It is advisable to carefully monitor defibrillator operation prior to and after any medical treatment during which an electrical current from an external source passes through the patient's body.

Magnetic Resonance Imaging:

MRI is strictly contraindicated in cardiac defibrillator patients.

Radiofrequency ablation:

A radiofrequency ablation procedure in a patient with a generator may cause device malfunction or damage. RF ablation risks may be minimized by:

1. Programming Shock Therapy and ATP to OFF.
2. Avoiding direct contact between the ablation catheter and the implanted lead or generator.
3. Positioning the ground, placing it so that the current pathway does not pass through or near the device, i.e. place the ground plate under the patient's buttocks or legs.
4. Having external defibrillation equipment available.

Electrocautery or diathermy device:

Diathermy and electrocautery equipment should not be used. If such devices must be used:

1. Keep the current path and ground plate as far away from the device and the leads as possible (a minimum of 15 cm [six inches]).
2. Before procedure, deactivate ATP and shock therapies.
3. During the procedure, keep the electrocautery device as far as possible from the cardiac defibrillator. Set it at minimum intensity. Use it briefly.
4. After the procedure, check for proper implant function. The device should never be exposed directly to the diathermy source.

External defibrillation:

PLATINIUM CRT-D is protected from external defibrillation shocks.

1. Before external defibrillation, deactivate ATP and shock therapies.
2. During external defibrillation, it is advisable to avoid placing the defibrillating paddles directly over the casing or over the leads. The defibrillating paddles should preferably be placed in an anteroposterior position.
3. Avoid any direct contact between the defibrillation paddles and the conductive parts of the implanted leads or casing of the implanted device.
4. After external defibrillation, check for proper device function.

Radiation therapy:

Avoid exposure to ionizing radiation. Betatrons are contraindicated. If high doses of radiation therapy cannot be avoided, the defibrillator should be protected from direct exposure with a protection shield. ATP and shock therapies should be disabled during exposure and proper device function should be checked regularly afterwards. Resulting damage may not be immediately detectable. If irradiation of tissues close to the implantation site is necessary, it is recommended that the cardiac defibrillator be moved. As a safety measure, an external defibrillator should be immediately available.

Lithotripsy:

Lithotripsy may permanently damage the device if it is at the focal point of the lithotripsy beam. If lithotripsy must be used, keep the defibrillator at least 2.5 to 5 cm (1-2 inches) away from the focal point of the lithotripsy beam.

Diagnostic ultrasound (echography):

The defibrillator is not affected by ultrasound imaging devices.

Scales with body fat monitors and electronic muscle stimulators:

A patient with an implanted PLATINIUM CRT-D should not use these devices.

4.2. STERILIZATION, STORAGE AND HANDLING

Resterilization:

Do not resterilize and re-implant explanted ICDs.

"Use Before" Date:

A "Use Before" date is printed on the outer storage package and on the sterile package. Do not implant the device after this date because the battery may have reduced longevity and sterility may be affected. It should be returned to Sorin.

If Package is damaged:

Do not use the device or accessories if the packaging is wet, punctured, opened or damaged because the integrity of the sterile packaging may be compromised. Return the device to the manufacturer.

Device Storage:

Store the device in a clean area, away from magnets, kits containing magnets, and sources of electromagnetic disturbance to avoid device damage. Store the device between 0 - 50 °C (32 - 122 °F). Temperatures outside the specified range may damage the device.

Equilibration:

Allow the device to reach room temperature before programming or implanting the device because rapid temperature changes may affect initial device function.

4.3. IMPLANTATION AND DEVICE PROGRAMMING

Use only a Sorin programmer to communicate with the device.

Do not inadvertently position any magnet over the ICD; this suspends tachyarrhythmia detection and treatment.

Replace the device when the RRT (Recommended Replacement Time*) point (defined by a battery voltage of 2.66 ± 0.01 V or a magnet rate lower than or equal to 80 bpm) is reached.

Program device parameters such as sensitivity threshold and VT and VF detection intervals as specified in the device manuals.

Lead System:

Do not use a lead system other than those with demonstrated compatibility because undersensing cardiac activity and failure to deliver necessary therapy may result.

In situations where an ICD and a pacemaker are implanted in the same patient, interaction testing should be completed. If the interaction between the ICD and the pacemaker cannot be resolved through repositioning of the leads or reprogramming of either the pacemaker or the ICD, the pacemaker should not be implanted (or should be explanted if previously implanted).

Failure to properly insert the torque screwdriver into the perforation at an angle perpendicular to the connector receptacle may result in damage to the sealing system and its self-sealing properties.

In the event of a warning on a low shock impedance, and after lead replacement or reconnection: it is recommended to check the system integrity (sensing and pacing thresholds and the impedance of the shock electrodes)

It is recommended that a security margin of at least 10 J be demonstrated between the effective shock energy and maximum programmable energy. Carefully confirm that true ventricular fibrillation has been induced because the DFT for ventricular tachycardia or flutter may be lower.

The defibrillator should be implanted with the engraved side facing outwards in order to facilitate telemetric communication with the programming head and to display the radiographic identification correctly.

*: corresponds to ERI (Elective Replacement Indicator) previously used.

4.4. LEAD EVALUATION AND LEAD CONNECTION

PLATINIUM CRT-D 1711 has two DF-1 and three IS-1 connector ports.

PLATINIUM CRT-D 1741 has two IS-1, and one DF4 connector ports.

IS-1 refers to the international standard whereby leads and generators from different manufacturers are assured a basic fit (ISO 5841-3:2013).

DF-1 refers to the international standard for defibrillation lead connectors (ISO 11318:2002).

DF4 refers to the international standard for defibrillation lead connectors (ISO 27186:2010).

Use only DF4-LLHH or DF4-LLHO standard lead connector types according to ISO 27186:2010.

Do not tie a ligature directly to the lead body, tie it too tightly, or otherwise create excessive strain at the insertion site as this may damage the lead. Use the lead stabilizer to secure the lead lateral to the venous entry site.

Do not immerse the leads in mineral oil, silicone oil, or any other liquid.

Do not grip the lead with surgical instruments.

Do not use excessive force or surgical instruments to insert a stylet into a lead.

Use ventricular transvenous leads with caution in patients with either a mechanical or bioprosthetic tricuspid valvular prosthesis.

Use the correct suture sleeve (when needed) for each lead, to immobilize the lead and protect it against damage from ligatures.

Never implant the system with a lead system that has a measured shock impedance of less than 30 ohms. A protection circuit in the defibrillator prevents shock delivery when impedance is too low. If the shock impedance is less than 30 ohms, reposition the lead system to allow a greater distance between the electrodes.

Do not kink leads. Kinking leads may cause additional stress on the leads, possibly resulting in lead fracture.

Do not insert a lead connector pin into the connector block without first visually verifying that the setscrews are sufficiently retracted. Do not tighten the setscrews unless a lead connector pin is inserted because it could damage the connector block.

Lead electrodes in contact during a cardioversion or defibrillation therapy will cause current to bypass the heart, possibly damaging the ICD and the leads. While the ICD is connected to the leads, make sure that the metal portions of any electrodes do not touch each other.

If a pacing lead is abandoned rather than removed, it must be capped to ensure that it is not a pathway for currents to or from the heart.

If a thoracotomy is required to place epicardial patches, it should be done during a separate procedure to reduce the risk of morbidity and mortality.

Do not place the patch lead over nerve tissue as this may cause nerve damage.

Place the patch lead with the conducting coil side facing the heart to ensure delivery of energy to the heart.

Place the sutures well outside the coil of the patch lead or in the area between the coils to avoid possible coil fracture.

If countershock is unsuccessful using external paddles, adjust the external paddle position (e.g., anterior-lateral to anterior-posterior) and be sure that the external paddle is not positioned over the patch.

Do not fold, alter, or remove any portion of the patch as it may compromise electrode function or longevity.

If a header port is unused on the generator, the port must be plugged to protect the generator.

4.5. GENERATOR EXPLANT AND DISPOSAL

Interrogate the device, and program shock therapy off prior to explanting, cleaning or shipping the device to prevent unwanted shocks.

Return all explanted generators and leads to the manufacturer.

Never incinerate the device due to the potential for explosion. The device must be explanted before cremation.

5. ADVERSE EVENTS

Clinical data presented in this section are from the MSP clinical study. PLATINIUM CRT-D is similar in design and function to the ALTO 2 MSP and OVATIO CRT-D devices. The data provided are applicable to PLATINIUM CRT-D.

5.1. MSP STUDY

CorMedica conducted an international, multi-center, randomized clinical trial of its cardiac resynchronization therapy system. Investigators attempted to implant study devices in 190 patients. A total of 182 patients received study devices and had an exposure of over 165 device years. Of those patients, 19 received OVATIO CRT-D, 160 received ALTO 2 MSP, and 3 received ALTO MSP. The clinical data collected on ALTO MSP, ALTO 2 MSP and OVATIO CRT-D are applicable to PLATINIUM CRT-D. The table below summarizes the adverse events observed for the CRT-D system. No deaths were related to the system.

| Event | # of Patients | % of Patients | # of Events | Events/100 Device-Years |
|---|---------------|---------------|-------------|-------------------------|
| Deaths not related to the system | 16 | 8.4 | 16 | 0.8 |
| Cardiac arrest | 5 | 2.6 | 5 | 0.3 |
| Worsening CHF / CHF decompensation | 3 | 1.6 | 3 | 0.2 |
| Multi-organ dysfunction | 2 | 1.1 | 2 | 0.1 |
| Complications related to the system | 28 | 14.7 | 35 | 2.1 |
| Dislodgment or migration | 9 | 4.7 | 11 | 0.6 |
| Extracardiac stimulation (e.g., phrenic stim) | 9 | 4.7 | 9 | 0.5 |
| Complications related to the implant procedure | 18 | 9.5 | 21 | 1.3 |
| Dislodgment or migration | 4 | 2.1 | 4 | 0.2 |
| Observations related to the system | 23 | 12.1 | 27 | 1.7 |
| Extracardiac stimulation (e.g., phrenic stim) | 12 | 7.9 | 15 | 0.8 |
| Observations related to the implant procedure | 24 | 12.6 | 28 | 1.7 |
| Heart block | 6 | 3.2 | 6 | 0.3 |
| Extracardiac stimulation (e.g., phrenic stim) | 3 | 1.5 | 5 | 0.3 |
| Serious adverse events not related to the system | 85 | 44.7 | 176 | 10.8 |

| | | | | |
|---|-----------|-------------|------------|------------|
| Worsening CHF/CHF decompensation | 24 | 12.6 | 42 | 2.1 |
| Atrial fibrillation/flutter | 14 | 7.4 | 14 | 0.7 |
| Not Serious events not related to the system | 58 | 30.5 | 121 | 7.4 |
| Pain (in back, arms, chest, shoulder, groin, head, other) | 10 | 5.3 | 13 | 0.7 |
| Worsening CHF/CHF decompensation | 13 | 6.8 | 16 | 0.8 |
| Atrial fibrillation/flutter | 7 | 3.7 | 8 | 0.4 |
| Ventricular tachycardia | 7 | 3.7 | 7 | 0.4 |

5.2. POTENTIAL ADVERSE EVENTS

Adverse events (in alphabetical order), including those reported in the previous tables, associated with ICD systems include:

- Acceleration of arrhythmias (caused by device),
- Air embolism,
- Bleeding,
- Chronic nerve damage,
- Erosion,
- Excessive fibrotic tissue growth,
- Extrusion,
- Fluid accumulation,
- Formation of hematomas or cysts,
- Inappropriate shocks,
- Infection,
- Keloid formation,
- Lead abrasion and fracture,
- Lead migration/dislodgment,
- Myocardial damage,
- Pneumothorax,
- Shunting current or insulating myocardium during defibrillation with internal or external paddles,
- Potential mortality due to inability to defibrillate or pace,
- Thromboemboli,
- Venous occlusion,
- Venous or cardiac perforation.

Patients susceptible to frequent shocks despite antiarrhythmic medical management may develop psychological intolerance to an ICD system that may include the following:

- Dependency,
- Depression,
- Fear of premature battery depletion,
- Fear of shocking while conscious,

- Fear that shocking capability may be lost,
- Imagined shocking (phantom shock).

6. CLINICAL STUDIES

Clinical data presented in this section are from the MSP clinical study. PLATINIUM CRT-D is similar in design and function to the ALTO 2 MSP and OVATIO CRT-D devices. The data provided are applicable to PLATINIUM CRT-D.

6.1. MSP CLINICAL STUDY

OVATIO CRT-D and earlier models were evaluated clinically in an international, multi-center, randomized clinical trial of Sorin's cardiac resynchronization therapy (CRT-D) system. Investigators attempted to implant study devices in 190 patients. A total of 182 patients received study devices and had an exposure of over 165 device years. Of those patients, 19 received OVATIO CRT-D, 160 received ALTO 2 MSP, and 3 received ALTO MSP.

6.1.1. Objectives

The primary objectives of the study were to demonstrate:

- Greater improvement in a composite endpoint (percent improvement in peak VO₂ percent improvement in quality of life) for CRT-D patients than for control patients.
- System complication-free rate ≥ 67 % at six months.

6.1.2. Methods

Patients were New York Heart Association class III or IV and had one or more indications for an implantable cardioverter defibrillator (ICD). Patients performed cardiopulmonary exercise testing at baseline and six-months after randomization. Patients were implanted with a Sorin ICD with CRT-D, a Situs UW28D left ventricular lead, and commercially available right atrial and ventricular leads. Routine follow-ups were at pre-discharge, randomization (3-14 days post-implant), one month, three months, and six months post randomization.

6.1.3. Results

Improvement in composite endpoint

Patients were included in the analysis if complete (peak VO₂ and quality of life) baseline and six-month data were available.

| Number of patients contributing to analysis | Mean percent improvement in composite endpoint for control group | Mean percent improvement in composite endpoint for CRT-D group | Percent greater improvement for CRT-D group | p-value |
|---|--|--|---|---------|
| 132 | 15.5 % | 24.9 % | 9.4 % | 0.046 |

Six-month system complication-free rate

| Number of patients contributing to analysis | Kaplan-Meier six-month complication-free estimate | One-sided lower 95% confidence bound for six-month complication-free estimate |
|---|---|---|
| 190 | 89.5 % | 84.1 % |

6.1.4. Absolute Differences in Peak VO₂ and QOL

The tables below show the absolute differences between the control and test groups' peak VO₂ and QOL over the 6 month follow-up period in the clinical trial.

Absolute difference between test and control groups' change in peak VO₂ over 6 months

| | | Baseline Mean ± SD (range) | 6-month Mean ± SD (range) | Difference within group | Difference between groups |
|--|----------------------|----------------------------|----------------------------|-------------------------|---------------------------|
| Change in Peak VO ₂ (mL/min/Kg) | Control group (n=41) | 13.39 ± 4.58 (5.02, 24.10) | 13.12 ± 3.99 (3.30, 20.70) | - 0.28 | 1.85 |
| | Test group (n=91) | 11.84 ± 3.90 (3.50, 26.3) | 13.41 ± 4.28 (6.18, 27.67) | 1.57 | |

Absolute difference between test and control groups' change in QOL score over 6 months

| | | Baseline Mean ± SD (range) | 6-month Mean ± SD (range) | Difference within group | Difference between groups |
|---------------|----------------------|----------------------------|---------------------------|-------------------------|---------------------------|
| Change in QOL | Control group (n=41) | 47.5 ± 19.29 (9, 90.3) | 31.21 ± 23.96 (0, 95) | 16.29 | 1.28 |
| | Test group (n=91) | 52.81 ± 21.84 (9, 92) | 35.24 ± 23.73 (0, 93) | 17.57 | |

The table below presents the percentage of patients in each group who improved, worsened, or remained unchanged in each element of the composite score and the composite score itself.

| | QOL score | | VO ₂ Score | | Composite Score | |
|-------------|---------------|------------|-----------------------|------------|-----------------|------------|
| | Control GROUP | Test GROUP | Control GROUP | Test GROUP | Control GROUP | Test GROUP |
| % Improved | 75.6 | 74.7 | 48.8 | 67.0 | 62.2 | 70.9 |
| % Worsened | 24.4 | 25.3 | 51.2 | 31.9 | 37.8 | 28.6 |
| % Unchanged | 0.0 | 0.0 | 0.0 | 1.1 | 0.0 | 0.0 |

Histograms for Respiratory Exchange Rate (RER) at peak VO₂ at baseline and 6 month follow-up are provided below:

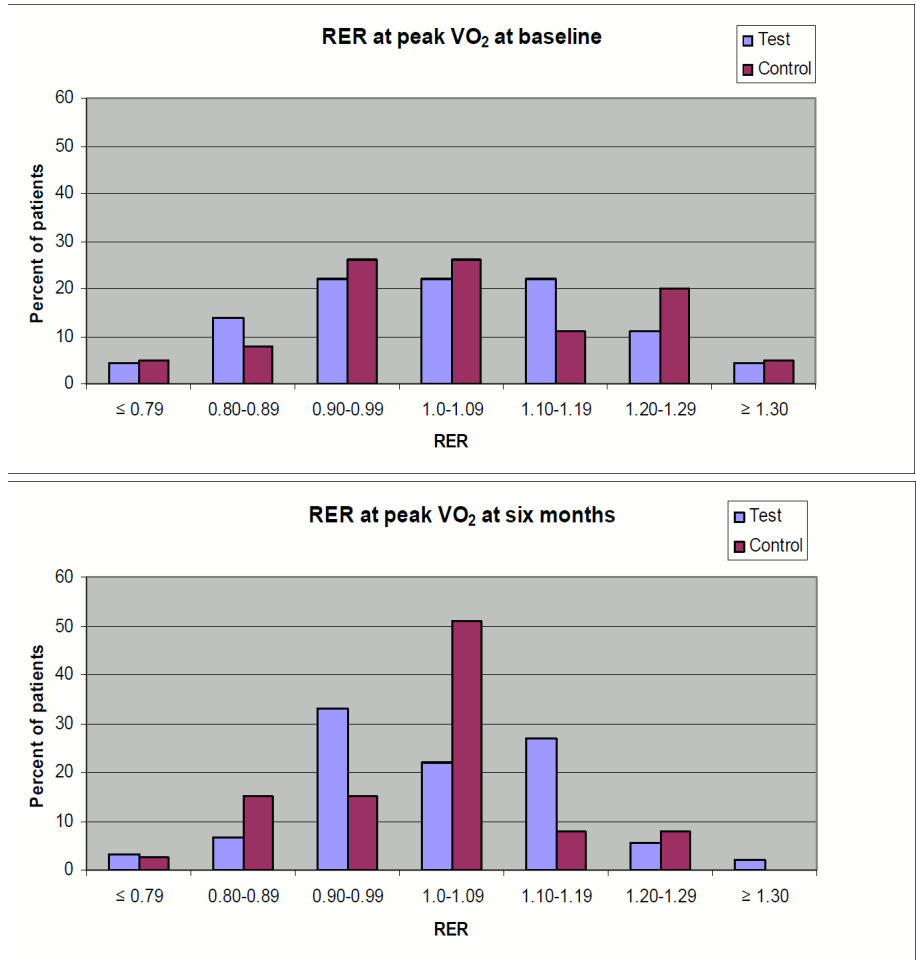

6.1.5. Clinical Results V-V timing

V-V programmable settings were available for the clinical study devices as follows: ALTO MSP model 617 (not programmable for V-V delay), ALTO 2 MSP model 627 values (0, 31, 39, 47, 55 and 63 ms) and OVATIO CRT-D 6750 values (0 to 63 ms in steps of 8 ms).

The graph below shows the programmed V-V settings at randomization by percentage of patients programmed to each combination of Synchronous BiV pacing and V-V delay.

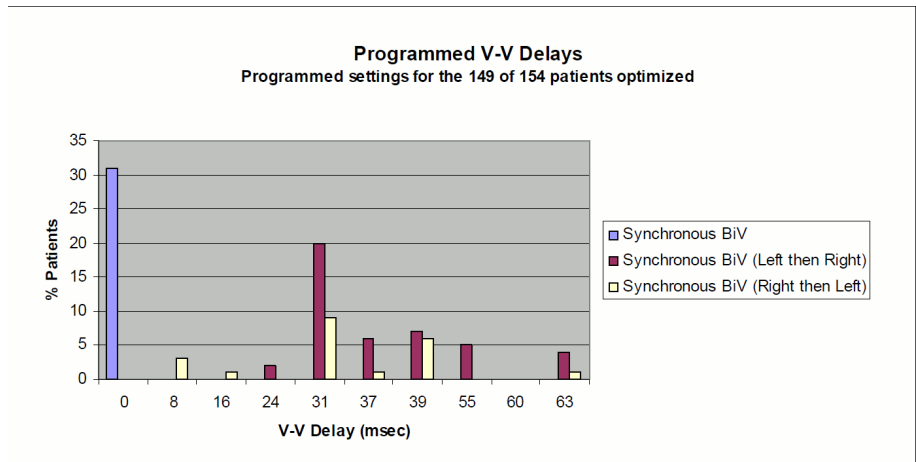

The optimization protocol in the clinical study specified that each patient randomized should undergo echo guided V-V optimization. Per the investigational plan for the MSP Clinical

Trial, a uniform protocol was used for V-V programming. This protocol required all patients to undergo echo-guided V-V delay optimization before randomization (2 to 14 days post-implant). The optimal V-V delay was determined by finding the programmable V-V delay and ventricular chamber pacing order (RV then LV, or LV then RV) providing the maximum time velocity integral (TVI or VTI) across the left ventricular outflow tract (LVOT).

Only those patients randomized to the Test arm were required to be programmed per the optimization protocol for the V-V delay.

Of the 177 patients that presented at randomization, 3 had Model 617 which does not have V-V programmability hence the inability to optimize. Of the remaining 174 patients, 154 (89%) were tested per the V-V optimization protocol. One hundred forty-nine (149) of the 154 patients who were tested per the V-V optimization protocol were programmed per the recommended or randomized V-V delay (97%). Thirty-one (31) patients were programmed to BiV synchronous (V-V delay 0ms), 46 were programmed to Sequential BiV (LV then RV), 22 were programmed to Sequential (RV then LV), and the remaining 50 patients were randomized to RV only.

A sub-analysis of the composite endpoint comparing the subset of CRT-D patients with optimized V-V delays vs. the subset of patients that did not undergo V-V delay optimization demonstrated similar results in both groups. The CRT-D patients who did not undergo V-V delay optimization showed a smaller improvement in the composite endpoint, although the sample size did not permit conclusions based on data from this subset.

7. PATIENT SELECTION AND TREATMENT

7.1. INDIVIDUALIZATION OF TREATMENT

Exercise stress testing:

If the patient's condition permits, use exercise stress testing to:

- Determine the maximum rate of the patient's normal rhythm,
- Identify any supraventricular tachyarrhythmias,
- Identify exercise-induced tachyarrhythmias.

The maximum exercise rate or the presence of supraventricular tachyarrhythmias may influence selection of programmable parameters. Holter monitoring or other extended ECG monitoring also may be helpful.



CAUTION: To avoid inappropriate therapy during an exercise stress test, do not reprogram any parameter during the test. When a parameter is reprogrammed, algorithm forces acceleration to "ventricular". During conducted sinus tachycardia within the programmed Tachy zone, the device detects a 1:1 fast rhythm. Assuming that acceleration was set to ventricular by reprogramming, the device may identify this as a VT, and may immediately apply the corresponding therapy.

Electrophysiologic (EP) testing:

EP testing may be useful for ICD candidates.

EP testing may identify the classifications and rates of all the ventricular and atrial arrhythmias, whether spontaneous or during EP testing.

Drug resistant supraventricular tachyarrhythmias (SVTs):

Drug resistant supraventricular tachyarrhythmias (SVTs) may initiate frequent unwanted device therapy.

A careful choice of programming options is necessary for such patients.

Antiarrhythmic drug therapy:

If the patient is being treated with antiarrhythmic or cardiac drugs, the patient should be on a maintenance drug dose rather than a loading dose at the time of ICD implantation. If changes to drug therapy are made, repeated arrhythmia inductions are recommended to verify ICD detection and conversion. The ICD also may need to be reprogrammed.

Changes in a patient's antiarrhythmic drug or any other medication that affects the patient's normal cardiac rate or conduction can affect the rate of tachyarrhythmias and/or efficacy of therapy.

Direct any questions regarding the individualization of patient therapy to Sorin's representative.

7.2. SPECIFIC PATIENT POPULATIONS

Pregnancy:

If there is a need to image the device, care should be taken to minimize radiation exposure to the foetus and the mother.

Nursing Mothers:

Although appropriate biocompatibility testing has been conducted for this implant device, there has been no quantitative assessment of the presence of leachables in breast milk.

Pediatric Patients:

This device has not been studied in patients younger than 18 years of age.

Geriatric Patients:

Most of the patients receiving this device in clinical studies were over the age of 60 years.

Handicapped and Disabled Patients:

Special care is needed in using this device for patients using an electrical wheel chair or other electrical (external or implanted) devices.

8. PATIENT COUNSELLING INFORMATION

The physician should consider the following points in counselling the patient about this device:

- Persons administering CPR may experience tingling on the patient's body surface when the patient's ICD system delivers a shock.
- Advise patients to carry Sorin ID cards and/or ID bracelets documenting their ICD system.

9. DECLARATION OF CONFORMITY

Sorin declares that this device is in conformity with the essential requirements of Directive 1999/5/EC on Radio and Telecommunications Terminal Equipment, with the mutual recognition of their conformity (R&TTE).

Federal Communication Commission Interference Statement 47 CFR Section 15.19 and 15.105(b)

The FCC product ID is :

- **PLATINIUM CRT-D 1711: YSGCRTD1711**
- **PLATINIUM CRT-D 1741: YSGCRTD1741**

This equipment has been tested and found to comply with the limits for a Class B digital device, pursuant to Part 15 of the FCC Rules. These limits are designed to provide reasonable protection against harmful interference in a residential installation. This equipment generates uses and can radiate radio frequency energy and, if not installed and used in accordance with the instructions, may cause harmful interference to radio communications. However, there is no guarantee that interference will not occur in a particular installation.

This device complies with Part 15 of the FCC Rules. Operation is subject to the following two conditions: (1) This device may not cause harmful interference, and (2) this device must accept any interference received, including interference that may cause undesired operation.

FCC Interference Statement 47 CFR Section 15.21 - No Unauthorized Modifications



CAUTION: This equipment may not be modified, altered, or changed in any way without signed written permission from SORIN. Unauthorized modification may void the equipment authorization from the FCC and will void the SORIN warranty.

Identification of the equipment according Section 95.1217(a)

This transmitter is authorized by rule under the Medical Device Radiocommunication Service (in part 95 of the FCC Rules) and must not cause harmful interference to stations operating in the 400.150-406.00 MHz band in the Meteorological Aids (i.e., transmitters and receivers used to communicate weather data), the Meteorological Satellite, or the Earth Exploration Satellite Services and must accept interference that may be caused by such stations, including interference that may cause undesired operation. This transmitter shall be used only in accordance with the FCC Rules governing the Medical Device Radiocommunication Service. Analog and digital voice communications are prohibited. Although this transmitter has been approved by the Federal Communications Commission, there is no guarantee that it will not receive interference or that any particular transmission from this transmitter will be free from interference.

IC Requirements for Canada

The FCC product ID is :

- **PLATINIUM CRT-D 1711: 10270A-CRTD1711**
- **PLATINIUM CRT-D 1741: 10270A-CRTD1741**

This class B digital apparatus meets all requirements of the Canadian Interference- causing equipment regulations.

This device complies with Industry Canada licence-exempt RSS standard(s). Operation is subject to the following two conditions: (1) this device may not cause interference, and (2) this device must accept any interference, including interference that may cause undesired operation of the device.

Under Industry Canada regulations, this radio transmitter may only operate using an antenna of a type and maximum (or lesser) gain approved for the transmitter by Industry Canada. To reduce potential radio interference to other users, the antenna type and its gain should be so chosen that the equivalent isotropically radiated power (e.i.r.p.) is not more than that necessary for successful communication.

This device may not interfere with stations operating in the 400.150–406.000 MHz band in the Meteorological Aids, Meteorological Satellite, and Earth Exploration Satellite Services and must accept any interference received, including interference that may cause undesired operation.

Cet appareil numérique de la classe B respecte toutes les exigences du règlement sur le matériel brouilleur du Canada.

Le présent appareil est conforme aux CNR d'Industrie Canada applicables aux appareils radio exempts de licence. L'exploitation est autorisée aux deux conditions suivantes: (1) il ne doit pas produire de brouillage, et (2) l'utilisateur du dispositif doit être prêt à accepter tout brouillage radioélectrique reçu, même si ce brouillage est susceptible de compromettre le fonctionnement du dispositif.

Conformément à la réglementation d'Industrie Canada, le présent émetteur radio peut fonctionner avec une antenne d'un type et d'un gain maximal (ou inférieur) approuvé pour l'émetteur par Industrie Canada. Dans le but de réduire les risques de brouillage radioélectrique à l'intention d'autres utilisateurs, il faut choisir le type d'antenne et son gain de sorte que la puissance isotrope rayonnée équivalente (p.i.r.e.) ne dépasse pas l'intensité nécessaire à l'établissement d'une communication satisfaisante.

Le présent dispositif ne doit pas causer de brouillage aux stations du service des auxiliaires de la météorologie, des satellites météorologiques, du service d'exploration de la terre par satellite, exploitées dans la bande 400,150-406,000 MHz, et il doit accepter tout brouillage reçu, y compris le brouillage pouvant entraîner un mauvais fonctionnement du dispositif.

10. PHYSICIAN GUIDELINES

10.1. PHYSICIAN TRAINING

Physicians should be familiar with sterile pulse generator and left ventricular pacing lead implant procedures. They must apply these procedures according to professional medical training and experience.

Physicians should be familiar with follow-up evaluation and management of patients with an implantable defibrillator (or referral to such a physician).

This training guideline for implantation and follow-up of ICD and CRT-D devices comes from the Heart Rhythm Society to provide standards for hospital credentialing bodies to help ensure appropriate patient care and lead to improved patient outcomes. The following is a summary of requirements for an alternate training pathway for ICD and CRT-D implantations⁽¹⁾:

- Documentation of current experience: 35 pacemaker implantations per year and 100 implantations over the prior 3 years
- Proctored ICD implantation experience: 10 Implantations, 5 Revisions
- Proctored CRT-D implantation experience: 5 implantations
- Completion of didactic course and/or IBHRE® ExAM
- Monitoring of patient outcomes and complication rates
- Established patient follow-up
- Maintenance of competence: 10 ICD and CRT-D procedures per year, 20 patients per year in follow-up

⁽¹⁾ Please consult full text of both publications for details. 2004 Heart Rhythm Society Clinical Competency Statement and the 2005 Addendum on Training Pathways for Implantation of Cardioverter Defibrillators and Cardiac Resynchronization Devices. *Heart Rhythm* (2004) 3, 371-375; *Heart Rhythm*.

10.2. DIRECTIONS FOR USE

ICD operating characteristics should be verified at the time of implantation and recorded in the patient file. Complete the *Patient Registration Form* and return it to Sorin, as it provides necessary information for warranty purposes and patient tracking.

Additional programming instructions can be found by accessing Online Help (click the “?” on the screen) on the Sorin dedicated programmer. Paper copies of Online Help can be obtained by contacting your Sorin representative.

10.3. MAINTAINING DEVICE QUALITY

This device is **FOR SINGLE USE ONLY**. Do not resterilize and reimplant explanted ICDs.

Do not implant the device when:

- It has been dropped on a hard surface because this could have damaged pulse generator components.
- Its sterility indicator within the inner package is not green, because it might not have been sterilized.

- Its storage package has been pierced or altered, because this could have rendered it non-sterile.
- It has been stored or transported outside the environmental temperature limits: 32 °F (0 °C) to 122 °F (50 °C) as an electrical reset condition may occur.
- "Use Before" date has expired, because this can adversely affect pulse generator longevity or sterility.

11. PATIENT INFORMATION

Information for the patient is available in the patient booklet, contained in the outer storage package. Additional copies can be obtained by contacting your Sorin representative.

This information should be given to each patient with their first ICD and offered to the patient on each return visit or as deemed appropriate.

12. HOW SUPPLIED

12.1. STERILITY

The PLATINIUM defibrillators are supplied one per package in a sterile package.

12.2. WARRANTY AND REPLACEMENT POLICY

Sorin warrants its defibrillators. Refer to the section "Warranty" for additional information. Please see the following labelling sections for information concerning the performance of this device: Indications, Contraindications, Warnings and Precautions, and Adverse Events.

13. DEVICE DESCRIPTION

The PLATINIUM CRT-D ICD device and programming system. The programming system includes the Sorin dedicated programmer with the SMARTVIEW programming software connected to a CPR3 programming head. The programming system is configured and furnished by Sorin.

The PLATINIUM CRT-D can serve as a defibrillation electrode (active housing) with a total surface area of 63 cm².

The PLATINIUM CRT-D is designed to recognize and treat slow or fast VT and VF by continuously monitoring atrial and ventricular activity to identify persistent ventricular arrhythmias and to deliver appropriate therapies. PLATINIUM CRT-D features the PARAD/PARAD+ algorithm, which is specifically designed to differentiate ventricular tachycardias from fast rhythms of supraventricular origin. PARAD/PARAD+ continuously monitors R-R interval stability, searches for long cycles, assesses the degree of P-R association, evaluates sudden onset and determines the chamber of arrhythmia acceleration.

In addition to the advanced detection scheme, PLATINIUM CRT-D offers programmable single, dual or triple-chamber pacing therapy (DDD, DDI, VVI or SafeR (AAI <> DDD) modes) with or without rate-responsive capabilities (DDDR, DDIR, VVIR, DDD/DDIR and SafeR-R (AAIR <> DDDR) modes) using an acceleration sensor. An automatic AV delay algorithm as well as a mode switching function are available.

PLATINIUM CRT-D enables an adjustment of the interventricular delay, and provides the possibility of adapting pacing to each ventricle. The ICD is intended to resynchronize uncoordinated contraction of the heart by simultaneously or sequentially pacing both ventricles.

PLATINIUM CRT-D offers tiered therapy. Therapies can be programmed independently in each zone:

- in the Slow VT and VT zones: two ATP programs, up to two shocks with programmable energy and up to four shocks with maximum energy can be programmed;
- in the VF zone: one ATP program, up to two shocks with programmable energy and up to four shocks with maximum energy can be programmed.

The ATP can be applied in RV, LV or RV and LV pacing with a VV delay equal to 0 ms. ATP pacing configuration is independent of ventricular pacing configuration.

When the rhythm changes from one zone to another, the device delivers the therapy programmed in this zone, starting with the same or more aggressive program for the area. The ATP program in the VF zone will only be applied if the VT coupling interval is longer than the programmed fast VT cycle length.

The PLATINIUM CRT-D offers biphasic shocks with a maximum stored energy of 42 J. The shock configuration (electrodes used to apply the shock) can be chosen by programming one of the following combinations: can and one coil, can and two coils, two coils only.

Other features are as follows:

- Automatic ventricular sensitivity control
- Non-committed shocks
- Electrophysiological studies (EPS) with real-time markers or electrograms:
 - Programmer-controlled VT induction sequences,

- Programmer-controlled VF inductions (30 Hz rapid pacing or shock on T),
- Programmable electrogram vectors (A / RV coil-CAN / SVC coil-CAN /RV coil-SVC coil / LV bip / LV tip-RV ring / A ring-CAN / RV tip-CAN / RV ring-CAN / LV tip-CAN / LV ring-CAN) and RV EGM,
- Real-time annotations displayed with the markers and indicating the majority rhythm,
- Manual ATP sequences,
- Manual shocks.
- Rescue shock
- Follow-up tests:
 - Pacing lead impedance,
 - Coil impedance,
 - Capacitor charge time,
 - Sensitivity test,
 - Pacing threshold tests.
- Data storage:
 - Therapy History Report,
 - Statistics (pace/sense, therapy, shocks, and battery voltage),
 - Up to 16 complete Holter records with event logs, marker channel notation, and electrogram records.

The PLATINIUM CRT-D 1711 connector has five ports:

- atrial bipolar pace/sense,
- right ventricular bipolar pace/sense,
- left ventricular pace
- two ports for RV and SVC defibrillation coils.

The PLATINIUM CRT-D 1741 connector head has three ports:

- Atrial “IS-1” port: performs atrial bipolar pace/sense,
- LV “IS-1” port: performs left ventricular pace,
- RV “DF4” port: performs right ventricular bipolar pace/sense, port for RV/SVC defibrillation coils.

For PLATINIUM CRT-D 1711, both pace/sense ports and the pace port are compatible with the IS-1 standard and both defibrillation ports are compatible with the DF-1 standard.

For PLATINIUM CRT-D 1741, both pace/sense ports are compatible with the IS-1 standard and defibrillation ports is compatible with the DF4 standard.

Distal lead terminal connections are secured with set-screws accessed via self-sealing silicone plugs. All lead connections pass through the header into the device via feedthroughs.

Programming System:

The Sorin programmer is used in conjunction with specific programmer software to interrogate and program the implanted device at implant and during patient follow-up procedures.

Remote Monitoring:

PLATINIUM CRT-D is also equipped with the RF wireless technology which enables to remotely monitor the patients who have the Sorin SMARTVIEW Monitor installed at home.

14. IMPLANT PROCEDURE

14.1. NECESSARY EQUIPMENT

Implantation of PLATINIUM CRT-D requires the following equipment:

- Sorin ORCHESTRA programmer, equipped with the SMARTVIEW software interface and inductive telemetry head,
- Sorin ORCHESTRA PLUS programmer, equipped with the SMARTVIEW software interface, inductive telemetry head and optionally ORCHESTRA PLUS LINK,
- pacing system analyzer, as well as its sterile connecting cables, to evaluate the pacing and sensing thresholds,
- a complete set of leads with corresponding introducers,
- physiological signal monitor capable of displaying simultaneously the surface ECG and arterial pressure,
- an external defibrillator with sterile external paddles,
- sterile cover for the telemetry head.



NOTE: In case you're implanting a DF4 lead, please verify its compatibility with standard alligators pin; please refer to the lead user's manual for more details.

14.2. PACKAGING

14.2.1. Contents

PLATINIUM CRT-D and its accessories are ethylene oxide sterilized and hermetically sealed in two-ply clear packaging meeting international requirements.

The sterile packaging contains:

- the defibrillator
- a ratcheting screwdriver
- a DF-1 defibrillating connector insulating plug for 1711 model

Once delivered, PLATINIUM CRT-D is programmed to as-shipped values that are different from nominal values (see Chapter "Programmable Parameters" for details).

14.3. OPTIONAL EQUIPMENT

The following equipment may be required during implantation of PLATINIUM CRT-D:

- an IS-1 insulating plug to close the atrial port
- a DF4/DF-1 adaptor in case of replacement and use of DF-1 lead in a DF4 connector
- sterile water to clean traces of blood. Any parts cleaned with sterile water must be thoroughly dried.
- mineral oil to lubricate if necessary
- a lead cap to isolate a lead which is not used

14.4. BEFORE OPENING THE PACKAGE

Before opening the package, check the "Use Before" date printed on the labels on the box and on the sterile package. Defibrillators that have not been implanted before that date should be returned to Sorin.

Interrogate the device:

- if a warning is displayed, do not implant the device and contact your Sorin representative.
- if battery voltage is below 3V, and if the last reforming/charge occurred more than one week ago, do not implant the device. Otherwise wait for one more week before checking the voltage.

NOTE : The battery voltage can decrease before the expiration date is reached. However, the battery voltage should be equal to or higher than 3V at the time of implant.

Devices **MUST NOT** be interrogated and programmed within the vicinity of other devices.

Also check the integrity of the sterile package. The sterility of the contents is no longer guaranteed if the package has been pierced or altered. If the defibrillator is no longer sterile, it should be returned in its packaging to Sorin. Any re-sterilization of the unit is at the discretion of Sorin.

14.5. PRIOR TO IMPLANTATION

Use the programmer to verify the defibrillator can be interrogated before implantation.

Verify all shock therapies are disabled in order to avoid accidental discharge during implantation.

It is not advisable to program the Smoothing function before implantation, since the defibrillator may detect noise and pace at a rate higher than the programmed basic rate.

CAUTION:



Do not shake or tap sharply on the ICD package with the ICD inside, because the ICD's sensing circuits can interpret this as P-waves or R-waves and record these as an arrhythmia episode.

High voltage capacitors charge performed on ICD without connected leads using wireless telemetry can generate false P-waves or R-waves detection.

It is recommended to reset the memory data and statistics before implanting the ICD.

14.6. DEVICE PLACEMENT

The pocket should be prepared in the left pectoral position, either subcutaneously or submuscularly. Subcutaneous device implantation is recommended for optimal RF communication efficacy.

Implantation in an abdominal position is not advisable.

In its final position, the defibrillator should be no more than 4 cm below the skin surface.

14.7. CHOOSING THE TYPE OF LEAD

The defibrillator should be connected to:

- one bipolar atrial sensing/pacing lead
- one right ventricular lead with bipolar sensing/pacing electrodes and one or two

defibrillation coils

- one unipolar or bipolar left ventricular pacing lead

The choice of leads and their configuration is left to the implanting physician's judgment.

NOTE1: Please note that DF-1 standard compliant lead is not compatible with DF4 connector. In the reverse, DF4 standard compliant lead is not compatible with DF-1 connector. In case of defibrillator replacement, choose the appropriate device compatible with DF-1 or DF4 leads. For any other lead type that requires an adaptor for this device, please contact your Sorin representative for any information on lead / connector compatibility question.



NOTE2: In the event that no atrial lead is implanted, the atrial port should be plugged with IS-1 insulating plug and a single chamber mode (VVI-VVIR) should be programmed. PARAD and PARAD+ should not be used.

NOTE3: In the event of a warning on a low shock impedance, and after lead replacement or reconnection: it is recommended to check the system integrity (sensing and pacing thresholds and the impedance of the shock electrodes).

Connectors:

PLATINIUM CRT-D 1711:

The pacing/sensing connectors are compatible with the IS-1 standard and the right ventricular defibrillation connectors are compatible with DF-1 standard.

PLATINIUM CRT-D 1741:

The atrial and left ventricular connectors are compatible with the IS-1 standard and the quadripolar right ventricular connector is compatible with the DF4 standard

14.8. SHOCK CONFIGURATION (+ -> -)

The shock configuration is the energy pathway between the defibrillation electrodes. If an atrial coil is present, the shock configuration can be programmed for bi-directional shocks.

Programming:

When active case and SVC are both programmed to Yes, the shock configuration can be programmed to:

- RV to Case (or Case to RV),
- or RV to SVC (or SVC to RV),
- or RV to Case+SVC (or Case+SVC to RV).

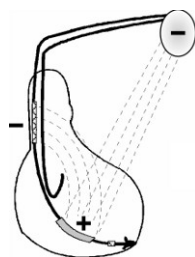

RV to Case+SVC

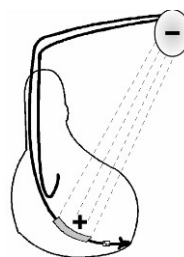

RV to Case

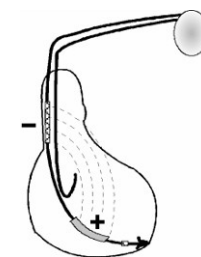

RV to SVC

The polarity of shock is determined by the parameter itself.

14.9. MEASUREMENT OF THRESHOLDS AT IMPLANT

Pacing and sensing thresholds should be measured at implant.

Pacing thresholds:

Acute thresholds should be lower than 1 V (or 2 mA) for a 0.35 ms pulse width, in both ventricles and in the atrium.

Sensing thresholds:

For appropriate right ventricular sensing, the amplitude of the R-wave should be greater than 5 mV.

For appropriate atrial sensing, the amplitude of the P-wave should be greater than 2 mV.

Pacing impedance measurements:

Right ventricular, left ventricular and atrial pacing impedances should range from 200 to 3000 ohms (refer to the lead characteristics, especially if high impedance leads are used).

Please refer to the leads user manuals for more details on the expected electrical performances of the leads.

14.10. LEADS CONNECTION

Implant the ventricular leads, then the atrial lead.

Each lead must be connected to the corresponding connector port. The position of each connector is indicated on the casing.



CAUTION:

Tighten only the distal inserts.

To connect each lead, proceed as follows:

1. Clean the lead terminal pins thoroughly, if necessary (device replacement).
2. Lubricate the lead terminal pins with sterile water, if necessary.
3. Do not insert a lead connector pin into the connector block without first visually verifying that the lead port is not filled with any obstacle.
4. Insert the screwdriver into the pre-inserted screw socket of the appropriate port (in order to allow excess air to bleed out and to make the insertion of the lead pin easier).
5. Insert the lead pin all the way into the port (check that the pin protrudes beyond the distal insert).
6. Tighten, check the tightness and ensure the lead pin still protrudes beyond the distal insert, and has not move.



CAUTION:

1. Do not tighten the pre-inserted screws when there is no lead (this could damage the connector).
2. Do not loosen the screws before inserting the connector (subsequent risk of being unable to reinsert the screw).
3. When mineral oil or sterile water is used to make lead insertion easier, the screwdriver should remain inserted into the pre-inserted screw socket when checking the tightness.

As a matter of fact, when the lead port is filled with a liquid, the physics piston effect can give the feeling the lead is properly tightened.

4. One single set screw is located on the side of the connection header.
5. Use only the screwdriver provided with the defibrillator. Keep the screwdriver's shaft perpendicular to the plane of the defibrillator (see figure below).
6. Removing the screwdriver: to avoid all risk of loosening screws during removal, hold the screwdriver by its metal part and not by the handle.

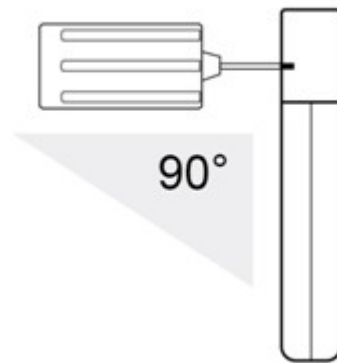

WARNING: Ensure that the screwdriver's tip is fully inserted in the setscrew; otherwise the screwdriver can damage the setscrew and prevent connection with or disconnection from the lead.

To ensure full insertion, push the screwdriver's hex tip smoothly into the setscrew until it reaches the bottom of the hex chamber in the screw, which can be felt as a solid metallic contact. Do not implant the defibrillator if there is no feeling of solid metallic contact. Do not implant the defibrillator if the wrench does not click when attempting to tighten the setscrew on the lead pin.



NOTE: To optimize cardioversion/defibrillation shocks, electrodes must be positioned so that the electric field between anode(s) and cathode covers the largest myocardial mass. In normal conditions, the anode and cathode are adequately separated. In case of a short-circuit, the shock may be aborted to prevent damaging the defibrillator.

In the case of an external defibrillation shock delivered to the patient, always check the programming and functioning of the device, in particular its capacity to deliver shocks.

14.11. DEVICE IMPLANTATION

PLATINIUM CRT-D should be implanted with the device identification engraved side facing outwards for optimal communication with the programming head and radiographic identification.

Carefully wind excess lead and place in a separate pocket to the side of the defibrillator.

It is recommended not to place any excess wire between the can and the heart.

Suture the casing connector to the muscle using the hole provided for this purpose, in order to avoid potential migration of the device into the pectoral muscle.

14.12. TESTS AND PROGRAMMING

During the implant testing procedure:

It is recommended that a security margin of at least 10 J be demonstrated between the effective shock energy and maximum programmable energy.

Enable shock therapies, then program the defibrillator.

Verify that the defibrillation lead impedance for each shock delivered is within the range of 30 to 150 ohms. Check the lead connection if the values are outside these boundaries.

Save the programming data on the programmer's hard disk and on an external storage device (if desired).

Resuscitation Availability:

Do not perform device testing unless an external defibrillator is available and medical personnel skilled in cardiopulmonary resuscitation (CPR) are present.

Disable the ICD During Handling:

Program Shock Therapy to OFF during surgical implant and explant or post mortem procedures. The device can deliver a serious high energy shock should accidental contact be made with the defibrillation electrodes, the device can deliver a very high energy shock.

15. SPECIAL MODES

15.1. SAFETY MODE (NOMINAL VALUES)

Nominal values may be rapidly restored by pressing the following button on the programming head or programmer keyboard:



or via the Emergency button on the SMARTVIEW screen.

In safety mode, the defibrillator operates with the parameters underlined in the table of programmable parameters.

15.2. MAGNET MODE

When the magnet is applied:

- antiarrhythmia functions are inhibited (detection of rhythm disturbances, charging, and therapy),
- hysteresis, VV delay and AVD paced/sensed offset are set to 0,
- pacing amplitude is set to 6 V,
- pulse width is set to maximum,
- the following functions are disabled: ventricular arrhythmia prevention, Mode Switch, Anti-PMT, Smoothing, Rate Response.

When the magnet is removed:

- arrhythmia detection algorithms and sequential therapies are reinitialized,
- therapies start with the least aggressive program for each area.

The antiarrhythmia functions inhibition is extended after magnet removal if a charge occurred just before the application of the magnet in order to ease the communication between the device and the programmer.

The other parameters remain at their programmed value, including the ventricular paced chamber parameter.

15.3. RESPONSE IN THE PRESENCE OF DISTURBANCE

If the defibrillator senses electrical noise at a frequency above 16 Hz, it switches to an asynchronous mode at the basic rate. The programmed mode is restored as soon as the noise is no longer detected.

Ventricular pacing may also be inhibited by ventricular noise. It can be restored by setting the parameter *V pacing on noise* to *Yes*.

15.4. DETECTION CHARACTERISTICS IN THE PRESENCE OF ELECTROMAGNETIC FIELDS

Per Clause 27.4 of Standard EN 45502-2-2, detection in the presence of electromagnetic fields is characterized as follows:

- Differential mode:

For DF-1 models:

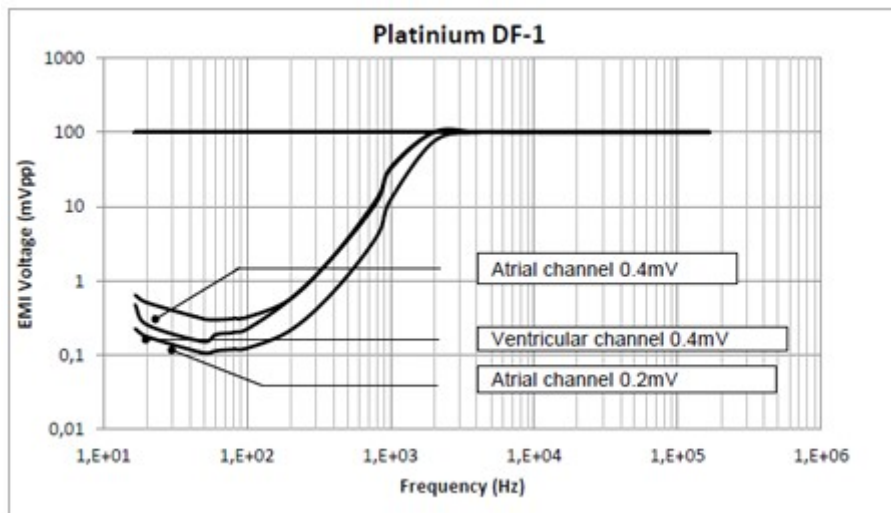

For DF4 models:

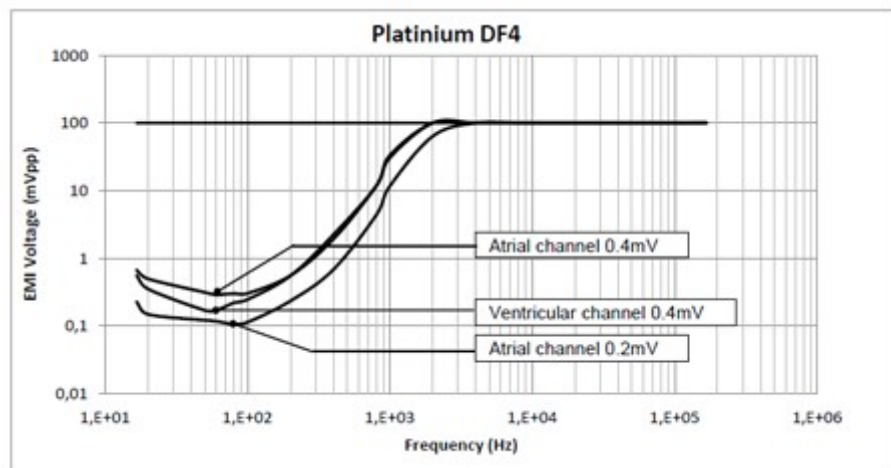

— Common mode rejection ratio:

For DF-1 Models:

| | 16.6 Hz | 50 Hz | 60 Hz |
|---------------------|---------|--------|--------|
| Atrial channel | ≥74 dB | ≥74 dB | ≥74 dB |
| Ventricular channel | ≥68 dB | ≥68 dB | ≥68 dB |

For DF4 Models:

| | 16.6 Hz | 50 Hz | 60 Hz |
|---------------------|---------|--------|-------|
| Atrial channel | ≥74 dB | ≥74 dB | ≥74dB |
| Ventricular channel | ≥68 dB | ≥68 dB | ≥68dB |

For atrial sensitivity settings below **0.4mV**, the ICD may detect noise lower than the level specified in clause 27.5.1 of standard EN 45502-2-2 for frequencies below 200 Hz.

For ventricular sensitivity settings below **0.6mV**, the ICD may detect noise lower than the level specified in clause 27.5.1 of standard EN 45502-2-2 for frequencies below 200 Hz.

15.5. PROTECTION AGAINST SHORT-CIRCUITS

The defibrillator can undergo a short-circuit if the anode and cathode are not adequately separated.

In this case, the shock is aborted to prevent damaging the defibrillator and a warning will indicate that a short circuit (shock impedance < 20 ohms) was detected during the last shock.

16. MAIN FUNCTIONS

16.1. AUTOMATIC LEAD MEASUREMENTS

Automatic pacing lead impedance measurement:

A lead impedance measurement is automatically performed on atrial and ventricular leads every 6 hours. The daily mean impedance is stored for each chamber.

Automatic coil impedance measurement:

A continuity measurement is automatically performed on defibrillation coil(s) once per day. The continuity is stored for each coil.

Automatic sensing measurement:

The amplitude of P and R waves are automatically measured at each cycle. Every 8.5 minutes, the amplitude of the last 8 P and R detections are averaged and stored.

16.2. ATRIAL TACHYARRHYTHMIA MANAGEMENT

Mode Switch:

This function is designed to limit the acceleration and variation of ventricular rate in the presence of atrial arrhythmia.

16.3. VENTRICULAR TACHYARRHYTHMIA MANAGEMENT

Ventricular tachyarrhythmia prevention:

Set of algorithms that can be used to avoid the circumstances of ventricular tachyarrhythmia onset.

Arrhythmia discrimination algorithm PARAD and PARAD+ (P And R based Arrhythmia Detection):

PARAD is the algorithm used to discriminate sinus tachycardias (ST) and supraventricular tachycardias (SVT) from ventricular tachycardias (VT).

PARAD+ is based on the PARAD algorithm but additionally takes into account the "AFdetect" discrimination criteria: the occurrence of a "long ventricular cycle" characteristic for AF patients which is an additional arrhythmia classification criterion to improve identification of atrial fibrillation and avoid inappropriate shocks.

Fast VT treatment:

Applies detection criteria on fast ventricular tachycardia that are different from those of the VT zone, as well as different therapies. The fast VT zone is included in the VF zone: its lower limit is determined by the programmed value for the VF zone and its upper limit by the programmed value for the fast VT zone.

Polarity alternation on Max shock:

Reverses the programmed polarity of every second shock set at maximum energy. The number, type, and energy of shocks is independently programmable by detection zone.

Defibrillation threshold (DFT):

Be aware that the changes in the patient's condition, drug regimen, and other factors may change the defibrillation threshold (DFT) which may result in non-conversion of the arrhythmia post-operatively. Successful conversion of ventricular fibrillation or ventricular tachycardia during arrhythmia conversion testing is no assurance that conversion will occur post-operatively.

16.4. PACING**BTO (Brady Tachy Overlap):**

Enables cardiac resynchronization therapy within the slow VT zone to preserve patient exercise capacity, without affecting detection or treatment of slow VTs.

Post-shock mode:

After any automatic shock therapy, the post-shock mode makes it possible to apply a pacing mode other than the standard antibradycardia pacing mode and/or with different pacing parameters.

SafeR (AAI <> DDD) mode:

Is intended to minimize deleterious effects of ventricular pacing. The defibrillator functions in AAI mode, and temporarily switches to DDD mode upon the occurrence of AVB III, AVB II, AVB I and ventricular pause.

Anti-PMT protection:

Is intended to protect the patient from Pacemaker-Mediated Tachycardia (PMT) without reducing atrial sensing capability of the device.

16.5. SENSING**Automatic Refractory Periods:**

Optimize sensing and make the implant programming easier. These periods are composed of a minimal Refractory Period and a triggerable Refractory Period. The duration of the refractory periods lengthens automatically as needed.

Committed period:

In DDI or DDD modes, the committed period is a non-programmable 95 ms ventricular relative refractory period that starts with atrial pacing. If a ventricular event is sensed during the committed period, but outside the blanking period, the ventricle is paced at the end of the committed period. The committed period prevents inappropriate ventricular inhibition if crosstalk occurs.

Protection against noise:

Allows the distinction between ventricular noise and ventricular fibrillation. If the device senses ventricular noise, the ventricular sensitivity is decreased until noise is no longer detected. Ventricular pacing can be inhibited to avoid a potential paced T-wave.

Automatic sensitivity control:

Optimizes arrhythmia detection and avoids late detection of T-waves and over-detection of wide QRS waves. The device automatically adjusts the sensitivities based on the ventricular sensing amplitude. In case of arrhythmia suspicion or after a paced event, the programmed ventricular sensitivity will be applied. The minimum ventricular sensitivity threshold is 0.4 mV (minimum programmable value).

16.6. FOLLOW-UP FUNCTION

Storage of memory data:

AIDA+ (Automatic Interpretation for Diagnosis Assistance) software provides access up to 6 months of patient follow-up with day by day data collection, or up to 24 hours with hourly data collection. Episodes of ventricular tachyarrhythmia are recorded with one programmable EGM channel which can be selected, in addition to RV EGM.

Alerts / Warnings:

The device routinely performs security self-checks and technical measurements to ensure system integrity. When system integrity is found to be at risk outside a follow-up, alerts are stored in the device memory. When system integrity is found to be at risk during a follow-up, the information is managed by a warning (pop-up message) to immediately notify the user. For example, the following types of event can trigger a warning or an alert: technical problem during a shock, lead impedance or shock continuity measurements out-of-range, battery depletion, ...

16.7. REMOTE MONITORING FUNCTION

Remote monitoring enables the automatic remote transmission of implant data to the physician thanks to the wireless Radio Frequency (RF) communication ability of the implant in order to provide a comprehensive report to the physician about device functioning and patient cardiac status without having the patient physically in the clinic.

The data is transmitted from the implant to the SMARTVIEW monitor, a small transmitter placed in the patient's home.

Implant data are first transmitted to the SMARTVIEW monitor via RF. Data are then routed through the phone line or via GPRS to an internet website. This website is responsible for transforming the implant data into a comprehensive report that can be consulted by the physician.

16.7.1. SMARTVIEW Monitor

The SMARTVIEW monitor is a small device equipped with an RF transmission module to communicate with the implant and a modem to export data through the internet.

The SMARTVIEW monitor is delivered to the patient who has to install it at home. Preferably the SMARTVIEW monitor will be placed on the nightstand of the patient, as close as possible to the side of the bed where the patient usually sleeps. The SMARTVIEW monitor connects to the phone line of the patient and the power plug. Regular transmissions are done during the night when the patient is asleep next to the SMARTVIEW monitor without any intervention from the patient.

16.7.2. Transmission trigger

There are 3 different triggers for a remote transmission:

- the **remote follow-up transmission** is scheduled by the physician to occur regularly (according to the programming).
- the **alert transmission** will take place when the implant has recorded an abnormal event. The list of abnormal event is available in a following paragraph. Alert conditions are checked daily.
- the **on-demand follow-up transmission** is triggered by the patient himself through the use of a specific button on the SMARTVIEW monitor.

16.7.3. Data transmitted

The data transmitted are identical to the data available during a standard interrogation with the dedicated programmer. All counters, histograms, IEGMs and diagnosis available in the device are transmitted containing (not exhaustive list):

- programmed parameters
- information on patient and system implanted
- battery status
- lead status (brady leads and defibrillation coils)
- pacing counters and mean heart rate (brady)
- atrial and ventricular arrhythmia counters and episodes
- ventricular therapy counters

Data are presented in the form of 2 reports to the physician: the first one contains a summary of major counters, histograms, warnings and diagnosis. The second one presents the most important IEGM episodes automatically selected based on the degree of severity for the patient.

16.7.4. User website

On the website, the physician is able to:

- consult and schedule the remote follow-ups of their patient
- configure additional ways of being notified of alerts (for instance by SMS, fax or e-mail)
- consult, print and export patient reports

16.7.5. Alert system

The following set of alert trigger can be independently programmed ON/OFF by the physician using the dedicated programmer and can trigger an alert transmission:

- Low or high impedance (A, RV, LV)
- Abnormal coil impedance (shock lead)
- Low or High shock impedance
- Inefficient high energy shock
- All shocks programmed OFF
- Shock treated VT/VF
- ATP treated VT/VF
- Lack of V pacing in CRT device
- Suspicion of noise on the V lead
- AT/AF occurrence
- Fast V rate during AT/AF

The following set of alert trigger (system alerts) cannot be deactivated when the Alerts are programmed "On" and can trigger an alert transmission:

- Battery depletion – RRT
- Device reset
- Excessive charge time (>25s)
- System integrity



WARNING: The use of remote monitoring does not replace regular follow-up. Therefore, when using remote monitoring, the time period between follow-ups visits may not be extended.

17. PATIENT FOLLOW-UP

17.1. FOLLOW-UP RECOMMENDATIONS

Before the patient is discharged and at each subsequent follow-up visit, it is advisable to:

- check the occurrence of system warnings
- check the battery status,

NOTES:



If the last reforming, charge or shock occurred during the week preceding the interrogation, the last battery value may be still impacted by the event. One week post event, the battery will recover its steady state value.

Automatic capacitor charging may affect communication between the device and the programmer.

- check the integrity of the pacing and defibrillation leads,
- check for proper sensing (sensitivity, crosstalk) and pacing ; set the pacing amplitude to twice the pacing threshold,
- interrogate the implant memories (AIDA+),
- check the efficacy of the therapies delivered,
- keep a printout of programmed parameters, test results, and memory data,
- reset the memory data and statistics.

These operations should be performed by medical personnel in an appropriate care unit, with resuscitation equipment present.

It is recommended that a routine follow-up examination be done one month after discharge, and then every three months until the device nears the replacement date.

Refer to the online help for a description of displayed warning, and the necessity to contact Sorin for an evaluation.

Implant software upgrade:

In case a new implant software is downloaded in the device memory through the programmer, a warning message could be displayed by the programmer to inform the user and give the correct instructions to follow.

17.2. HOLTER FUNCTION

The Holter records markers and EGM on RV and on 1 programmable channel: A / RV coil – Can / SVC coil – Can / RV coil - SVC coil / LV bip / LV tip – RV ring / RA ring – Can / RV tip – Can / RV ring – Can / LV tip – Can / LV ring – Can:

- Up to 10 episodes and 5 min EGM on significant events: AV block switch, lead impedance out of range.
- Up to 16 tachyarrhythmia episodes as well as the therapy history.

Stored Tachyarrhythmia Episodes:

PLATINIUM CRT-D stores up to 16 episodes (VF, VT, Slow VT, SVT/ST, non-sustained) with a total of 25.6 min of high resolution EGM.

For each episode four levels of details are presented:

- Tachogram (to visualize PP and PR intervals)
- Event log for the entire episode:
 - PARAD/PARAD+ analysis for each majority,
 - Delivered therapies,
- Markers: Atrial, ventricular and biventricular markers, sensed, paced and in relative refractory periods,
- EGM: onset and detection of the arrhythmia, on two therapies, and the return to slow rhythm by recording electrogram.

Therapy history

For each arrhythmia detection, each therapy delivered (either automatically or during an electrophysiological study) and at the end of each arrhythmia, PLATINIUM CRT-D records the type of majority rhythm, the number of ATP sequences delivered, the energy and the number of shocks delivered.

17.3. RECOMMENDED REPLACEMENT TIME (RRT)

Recommended Replacement Time (RRT)⁽¹⁾ is controlled by: battery voltage equal to 2.62 V \pm 0.01 V



CAUTION: The defibrillator should be replaced as soon as the Recommended Replacement Time (RRT) point is reached.

Between the RRT and the EOS (End of Service)⁽²⁾, PLATINIUM CRT-D can still function for:

- 10.8 months (100% atrial and biventricular pacing in DDD mode, 500 ohms, with as-shipped settings), and deliver 11 shocks at 34 J or
- 10,4 months (0% pacing, sensors OFF, one shock every 2 weeks) and deliver 21 shocks at 34 J.

Once the Recommended Replacement Time (RRT) point has been reached, the device operates normally, except that the charge time increases. Under normal conditions (and without programmer use) the charge times are as follows:

| | Shock energy | Charge time (sec) |
|--------------------|--------------|-------------------|
| BOS ⁽³⁾ | 42 J | 10 (\pm 2) |
| RRT | 42 J | 13 (\pm 3) |

(1) Recommended Replacement Time (RRT) corresponds to Elective Replacement Indicators (ERI) previously used.

(2) End of Service (EOS) corresponds to End of Life (EOL) previously used.

(3) Beginning of Service (BOS) corresponds to Beginning of Life (BOL) previously used.

17.4. EXPLANTATION

The defibrillator should be explanted in the following cases:

- The Recommended Replacement Time (RRT) point is reached
- Confirmed malfunction
- Burial of the patient (for environmental reasons, the local regulation may require the explantation of the devices containing a battery supply)
- Cremation of the patient (the defibrillator may explode if placed in an incinerator)

The explanted defibrillator should not be reused in another patient.

All explanted defibrillators should be returned to Sorin, carefully cleaned of all traces of contamination. Cleaning may be done by immersing them in an aqueous sodium hypochlorite containing at least 1% chlorine, followed by rinsing copiously with water.

The defibrillator should be protected against mechanical impact and the temperature variations that may occur during shipping.

Before explantation, it is advisable to:

- Print out all programmed parameters, statistics and Holter function report,
- Save Patient data on floppy disk or hard disk,
- Disable shock therapies (VT and VF) to avoid any risk of untimely shock.

17.5. DEFIBRILLATOR IDENTIFICATION

The defibrillator can be interrogated and programmed via telemetry, using the programming head interfaced with the Sorin dedicated programmer.

Position the programming head over the telemetry antenna located in the upper part of the device, in order to communicate effectively via telemetry (see diagram below).

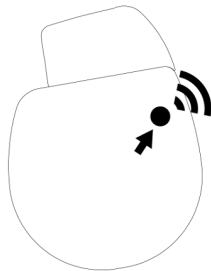

The device can be non-invasively identified as follows:

1. Take an x-ray to identify the name of the manufacturer and model, printed on the device (X-ray ID is SEA for PLATINIUM range).

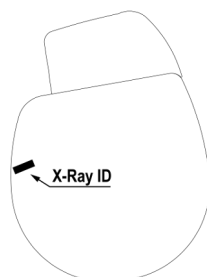

2. Interrogate the device using the Sorin dedicated programmer. The model and serial number of the device are automatically displayed. The first figure in the serial number corresponds to the last figure in the year of manufacture.

18. SUPPLEMENTAL INFORMATION

Clinical data presented in this section are from the SafeR (AAI <> DDD) clinical study. SafeR (AAI <> DDD) operation in PLATINIUM is similar to that in the Symphony pacemaker. The data provided are applicable to PLATINIUM CRT-D.

18.1. ADVERSE EVENTS IN THE SAFER (AAI <> DDD) STUDY

Clinical study of the SafeR (AAI <> DDD) included 45 Symphony 2550 devices implanted in 45 patients. No serious adverse events were device- or feature-related. There were no deaths in the study.

Table 1: Summary of Symphony safety data during study

| | Patients | | Number of events | |
|--|--------------------|---------------|------------------|---------------------------------------|
| | Number of patients | % of patients | Number of events | Events per device year ^(a) |
| Deaths | 0 | 0 | 0 | 0 |
| Explants | 0 | 0 | 0 | 0 |
| Serious pacemaker related events outside the use of SafeR (AAI <> DDD) | 0 | 0 | 0 | 0 |
| Non-serious pacemaker related events outside the use of SafeR (AAI <> DDD) | 0 | 0 | 0 | 0 |
| Serious events due to the use of SafeR (AAI <> DDD) | 0 | 0 | 0 | 0 |
| Non-serious events related due to the use of SafeR (AAI <> DDD) | 13 | 28.9 | 15 | 3.2 |
| Serious non-pacemaker related events | 6 | 13.3 | 9 | 1.9 |
| Non-serious non-pacemaker related events | 8 | 17.8 | 8 | 1.7 |

^(a) 4.74 device years

Non-serious events due to the use of SafeR 2 (AAI <> DDD) included: delay in switching on 2nd degree AV block, inappropriate classification of a PAC, disagreement between markers and recorded EGM, atrial pacing above the maximum rate, recycling on an R-wave in a

refractory period, and disagreement in the statistics for switches to DDD. No patient symptoms were associated with these events.

18.2. SAFER (AAI <> DDD) CLINICAL STUDY

SafeR (AAI <> DDD) mode in PLATINIUM is similar to that in Symphony.

The differences in SafeR (AAI <> DDD) mode between the two devices are:

- To prevent long RR intervals during VT/VF, SafeR (AAI <> DDD) has no effect during VT/VF therapy, electrophysiologic studies, and post-shock recovery.
- The maximum acceptable AV delay for first degree AV block varies as a function of pacing rate.
- PLATINIUM requires a ventricular sensed event to atrial paced event (RA) interval of at least 100 ms. Therefore, the device lengthens the atrial escape interval so that it ends at least 102 ms after the ventricular event.
- During atrial fibrillation episode, pause criterion is fixed to 2s to avoid long bradycardia episodes in switching to DDD mode.

Despite these differences, the data collected on Symphony devices are applicable to PLATINIUM because the principles of SafeR (AAI <> DDD) operation did not change. The criteria for switching from AAI to DDD (or vice versa) did not change. The device's method for evaluating the presence of AV conduction did not change.

Methods:

All patients were implanted with a Symphony Model 2550 dual-chamber rate-responsive pacemaker with SafeR (AAI <> DDD) mode. A variety of marketed atrial and ventricular pacing leads were used. The pacemaker was programmed and interrogated via bi-directional telemetry using a Sorin dedicated programmer and a CPR3 programming head.

The study's routine evaluation consisted of enrollment, pre-discharge evaluation, and a scheduled follow-up visit at one month. At pre-discharge, a 24-hour Holter recording was performed and pacemaker memory was read. At one month, pacemaker memory was read. Investigators also documented adverse events.

Patients studied:

A total of 45 patients from 12 centers had Symphony 2550 pacemakers with SafeR (AAI <> DDD). Of these, 14 (31 %) were female and 31 (69 %) were male. Mean patient age (\pm SD) was 74 ± 9 years.

Primary indications for implant were: 1st degree AV block (11.1 %), 2nd degree AV block (6.7 %), 3rd degree AV block (22.2 %), sinus node dysfunction (62.2 %) or other (6.7 %).

Effectiveness results:

To determine the effectiveness of SafeR (AAI <> DDD) mode, the percentage of ventricular pacing provided over one month was recorded from pacemaker memory.

Thirty-five patients contributed data to evaluate the percentage of ventricular pacing provided with SafeR (AAI <> DDD). Twenty-nine patients had 1 % or less ventricular pacing and six patients had a range of 28-97 % ventricular pacing. The graph below shows the distribution of ventricular pacing observed in patients with and without AV block as a primary indication for implant.

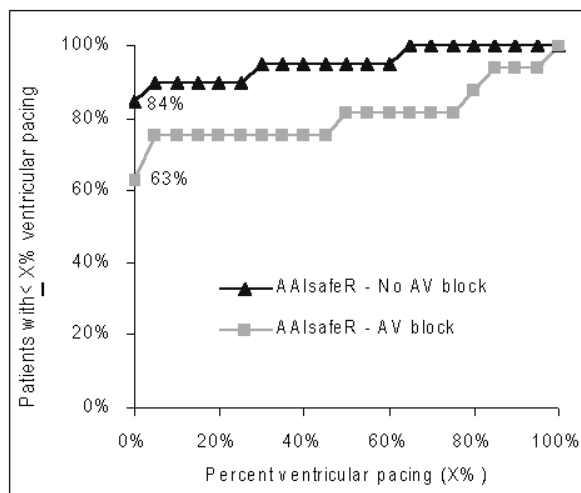

The graph shows that many patients programmed to SafeR (AAI <> DDD) had less than 1% ventricular pacing:

- 84 % of patients without AV block at implant.
- 63 % of patients with AV block at implant.

In a representative reference group⁽¹⁾ of patients programmed to DDD, none had less than 1 % ventricular pacing and only 10 % had less than 90 % ventricular pacing regardless of AV block indication at implant.

The actual reduction of ventricular pacing that SafeR (AAI <> DDD) provides in an individual will depend on the amount of time that the patient spends in AV block. SafeR (AAI <> DDD) cannot and should not provide any decrease in ventricular pacing while the patient is in AV block.

⁽¹⁾ Pioger G, Jauvert G, Nitzsché R, Pozzan J, Laure H, Zigelman M, Leny G, Vandrell M, Ritter P, and Cazeau S. Incidence and predictive factors of atrial fibrillation in paced patients. *PACE*, 28, Supp 1: S137-141; January 2005. This was a prospective observational study of 377 patients with a functionally similar device programmed to DDD. The primary indications for implant were: AV block (49 %), sinus node disease (16 %), brady-tachy syndrome (5 %), AV block + sinus node disease (19 %), AV block + brady-tachy syndrome (6 %), and brady-tachy syndrome + sinus node disease (5 %).

19. PHYSICAL CHARACTERISTICS

1711 MODEL:

| | |
|-------------------------------|--|
| Dimensions | 73 x 54.3 x 11.1 mm |
| Weight | 86 g |
| Volume | 33 cm ³ |
| Active surface area of casing | 62.7cm ² |
| Connector | Atrium: IS-1 bipolar. Right ventricle: IS-1 bipolar, 2*DF-1. Left ventricle: IS-1 bipolar (unipolar compatible). |

1741 MODEL:



| | |
|-------------------------------|---|
| Dimensions | 72.3 x 54.3 x 11.1 mm |
| Weight | 87 g |
| Volume | 33 cm ³ |
| Active surface area of casing | 62.8cm ² |
| Connector | Atrium: IS-1 bipolar. Right ventricle: DF4. Left ventricle: IS-1 bipolar (unipolar compatible). |

19.1. MATERIALS USED

| | |
|--------------------------------------|---------------------------------------|
| Active surface area of casing | 99% pure titanium |
| Connectors | Polyurethane* and silicone elastomer* |

*Medical-grade materials that have undergone "in vitro" and "in vivo" qualifications.

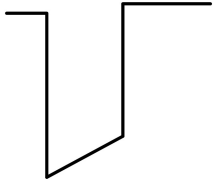
20. ELECTRICAL CHARACTERISTICS

| | |
|-----------------------------|---|
| Atrial input impedance | 80 kilohms \pm 30 % |
| Ventricular input impedance | 80 kilohms \pm 30 % |
| D.C. capacitance | 149 μ F \pm 8 % |
| Capacitor reformation | No reformation required |
| Rate limit | 192 ppm \pm 10 ppm |
| Pacing waveform |  |
| Defibrillation waveform |  |

20.1. TABLE OF DELIVERED SHOCK ENERGY AND VOLTAGE

The relationship between stored energies, maximum voltages and delivered energies (at 37 °C, 50 ohm load) for the minimum, low, mean and maximum programmed energy values is as follows:

| | | | | | |
|--------------------------|------|------|------|------|------|
| Stored energy (J) | 0.5 | 10 | 20 | 34 | 42 |
| V1 (Volt) | 71 | 332 | 471 | 617 | 686 |
| V2 (Volt) | 35 | 167 | 235 | 309 | 342 |
| Delivered E: Phase 1 (J) | 0.32 | 6.94 | 14.0 | 23.8 | 29.6 |
| Delivered E: Phase 2 (J) | 0.08 | 1.75 | 3.4 | 6.0 | 7.4 |
| Delivered E: Total (J) | 0.4 | 8.7 | 17.4 | 30 | 37 |

Tolerances are 12% for voltage (25% at 0.5 J) and 30% for energy.

20.2. BATTERY

| | |
|---------------------|------------------------|
| Manufacturer | Greatbatch |
| Type | Quasar High Rate (QHR) |
| Model | GB 3070 |
| Number of batteries | 1 |

| | |
|-----------------|---|
| Total capacity | 2192 mAh |
| Usable capacity | Between BOS and RRT: 1530 mAh. Between BOS and EOS: 1910 mAh. |
| Voltage | BOS: 3.24 V. RRT: 2.62 V. EOS: 2.5 V. |

20.3. LONGEVITY

The longevities are calculated by taking into account 6 months storage with the following conditions:

- Mode: DDD
- Basic rate: 60 ppm
- Pulse width (A, RV, LV): 0.35 ms
- EGM: ON
- 2 battery reformings per year (at 34J), replaced by shocks if any
- Remote monitoring: ON, daily check, 4 follow-ups and 5 full alert reports per year
- RF telemetry: ON, 120min at implantation + 15min at discharge + 15min for in-clinic quarterly follow-ups

Longevity projection at 500 Ω pacing impedance:

| | | | | | | | |
|----------------------------|-----|-----|-----|-----|------|------|------|
| A pacing (%) | 100 | 100 | 1 | 15 | 1 | 30 | 0 |
| BiV pacing (%) | 100 | 100 | 100 | 100 | 100 | 100 | 0 |
| A, RV Pacing amplitude (V) | 3.5 | 3.5 | 3.5 | 4.5 | 2.5 | 2.5 | - |
| LV Pacing amplitude (V) | 3.5 | 3.5 | 3.5 | 4.5 | 2.5 | 3.0 | - |
| Sensor | OFF | ON | ON | ON | OFF | OFF | OFF |
| Max shocks (42J) per year | 4 | 4 | 4 | 4 | 0 | 3 | 4 |
| Longevity (years) | 7.2 | 7.1 | 8.4 | 6.6 | 12.4 | 10.4 | 13.6 |

Longevity projection at 600 Ω pacing impedance:

| | | | | | | | |
|----------------------------|-----|-----|-----|-----|------|------|------|
| A pacing (%) | 100 | 100 | 1 | 15 | 1 | 30 | 0 |
| BiV pacing (%) | 100 | 100 | 100 | 100 | 100 | 100 | 0 |
| A, RV Pacing amplitude (V) | 3.5 | 3.5 | 3.5 | 4.5 | 2.5 | 2.5 | - |
| LV Pacing amplitude (V) | 3.5 | 3.5 | 3.5 | 4.5 | 2.5 | 3.0 | - |
| Sensor | OFF | ON | ON | ON | OFF | OFF | OFF |
| Max shocks (42J) per year | 4 | 4 | 4 | 4 | 0 | 3 | 4 |
| Longevity (years) | 7.7 | 7.6 | 8.8 | 7.1 | 12.9 | 10.9 | 13.6 |

Longevity projection at 700 Ω pacing impedance:

20. ELECTRICAL CHARACTERISTICS

| | | | | | | | |
|----------------------------|-----|-----|-----|-----|------|------|------|
| A pacing (%) | 100 | 100 | 1 | 15 | 1 | 30 | 0 |
| BiV pacing (%) | 100 | 100 | 100 | 100 | 100 | 100 | 0 |
| A, RV Pacing amplitude (V) | 3.5 | 3.5 | 3.5 | 4.5 | 2.5 | 2.5 | - |
| LV Pacing amplitude (V) | 3.5 | 3.5 | 3.5 | 4.5 | 2.5 | 3.0 | - |
| Sensor | OFF | ON | ON | ON | OFF | OFF | OFF |
| Max shocks (42J) per year | 4 | 4 | 4 | 4 | 0 | 3 | 4 |
| Longevity (years) | 8.2 | 8.0 | 9.2 | 7.6 | 13.3 | 11.3 | 13.6 |

1h of additional RF programming session reduces the device longevity from 1 to 2 weeks depending on the device functioning mode (no pacing, 100% pacing). The mean longevity as a function of shocks delivered at maximum energy, with and without pacing, is as follows:

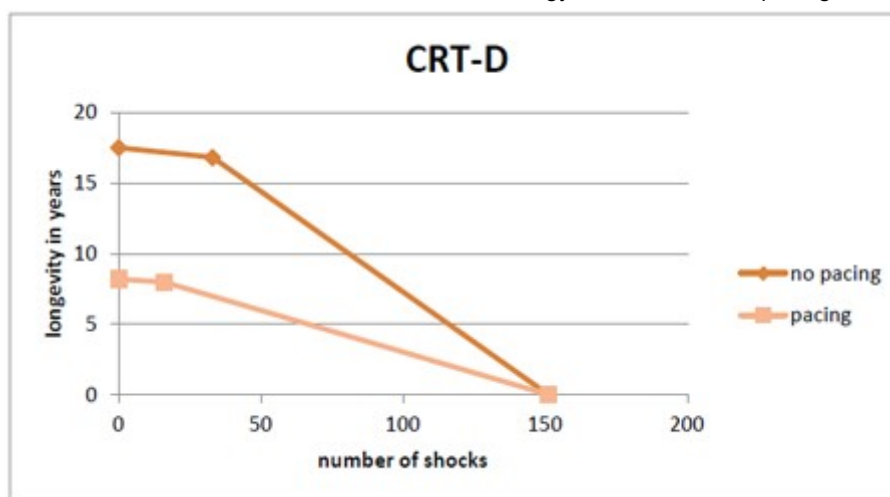

The mean longevity as a function of yearly remote follow-ups¹, with and without pacing, is as follows:

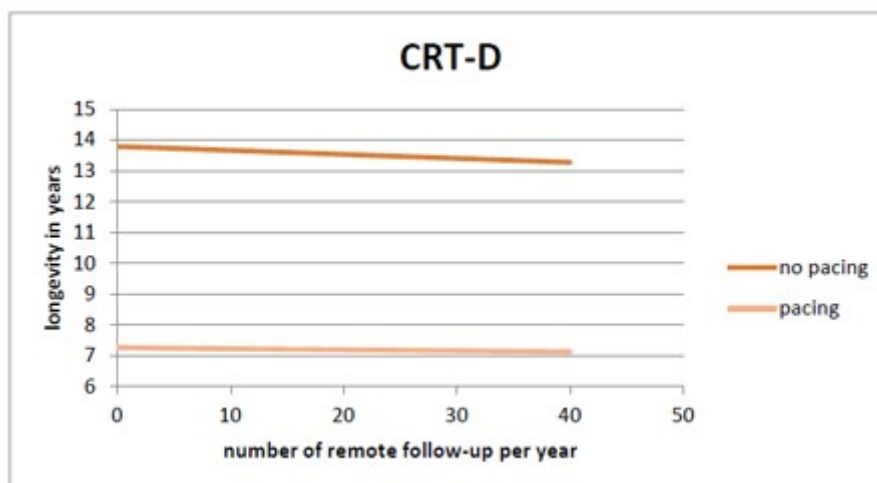

1. An excessive number of remote follow-ups can have a non-negligible impact on device longevity.

21. PROGRAMMABLE PARAMETERS

Measured at 37 °C under a 500 ohm load

Legend:

Value in bold: "as shipped" value

Underlined value: nominal value

21.1. ANTIBRADYCARDIA PACING

| Basic parameters | Values |
|---------------------------------|---|
| Mode | <u>VVI</u> -VVIR- DDD -DDDR- <u>DDD</u> /DDIR-DDI-DDIR-SafeR (AAI <=> DDD)-SafeR-R (AAIR <=> DDDR) |
| Basic rate (ppm) ⁽¹⁾ | From 30 to 90 by steps of 5 ; 60 (± 4 %) |
| Maximum rate (ppm) | From 100 to 145 by steps of 5 ; 120 (± 6 %) |
| Rate hysteresis (%) | <u>0</u> -5-10-20-35 (± 18 ms) |
| Rest AV delay (ms) | 30-40-45-55-65-70-80-85-95-100-110-115- 125 -135-140-150-155-165-170-180-190-195-205-210-220-225-235-250 (± 19 ms) |
| Exercise AV delay (ms) | 30-40-45-55-65-70- 80 -85-95-100-110-115-125-135-140-150-155-165-170-180-190-195-205-210-220-225-235-250 (± 19 ms) |
| AVD Paced/Sensed Offset (ms) | 0-10-15-25-30-40-45-55- 65 -70-80-85-95-100-110-115-125 (± 1 ms) |

(1) The corresponding periods are (in ms): 2000-1714-1500-1333-1200-1091-1000-923-857-800-750-706-667 ms.

| Special features | Values |
|-------------------|---|
| Rate smoothing | OFF -Very slow-Slow-Medium-Fast |
| Mode Switch | ON -OFF |
| Physical activity | Very low-Low- Medium -High-Very high |

| Pacing/Sensing | Values |
|---|--|
| Atrial sensitivity (mV) ⁽¹⁾ | From 0.2 to 4 by steps of 0.2 ; 0.4 (± 50 %) |
| Atrial amplitude (V) ⁽²⁾ | 1-1.5-2-2.5-3- 3.5 -4-4.5-5-6 (± 20 %) |
| Atrial pulse width (ms) | 0.12-0.25- 0.35 -0.5-0.6-0.75-0.85-1 (± 10 %) |
| Ventricular sensitivity (mV) ⁽¹⁾ | From 0.4 to 4 by steps of 0.2 ; 0.4 (± 50 %) |
| RV amplitude (V) ⁽²⁾ | 1-1.5-2-2.5-3- 3.5 -4-4.5-5-6 (± 20 %) |
| RV pulse width (ms) | 0.12-0.25- 0.35 -0.5-0.6-0.75-0.85-1 (± 10 %) |
| LV amplitude (V) ⁽²⁾ | 0.10-0.25-0.35 (± 50 %) 0.50-0.60-0.75-0.85 (± 30 %) 1.00-1.10-1.25-1.35-1.50-1.60-1.75-1.85-2.00-2.10-2.25- 2.35-2.50-2.60-2.75-2.85-3.00-3.10-3.25-3.35- 3.50 -3.60- 3.75-3.85-4.00-4.10-4.25-4.35-4.50-4.60-4.75-4.85-5.00- 5.10-5.25-5.35-5.50-5.60-5.75-5.85-6.00-6.10-6.25-6.35- 6.50-6.60-6.75-6.85-7.00- (± 20 %) |
| LV pulse width (ms) | 0.12-0.25- 0.35 -0.50-0.60-0.75-0.85-1.00-1.10-1.25-1.35- 1.50-1.60-1.75-1.85-2.00 (± 10 %) |
| LV pacing polarity | LV bipolar-LV tip to RV ring-LV ring to RV coil- LV tip to RV coil -LV ring to CAN-LV tip to CAN |
| V chambers | Right- R+L -L+R |
| VV delay (ms) | 0 -16-24-32-40-48-56-64- (± 3 ms) |

(1) Values are measured using a positive and negative triangular signal of 2/13 ms.

(2) The correlation between the programmed amplitudes, the stored amplitudes and the mid-pulse delivered amplitudes under a 500 ohm load are given in the following table:

| Programmed amplitude (V) | Stored amplitude (V) | Mid-pulse delivered amplitude (V) |
|--------------------------|----------------------|-----------------------------------|
| 0,10* | 0,20 | 0,19 |
| 0,25* | 0,26 | 0,22 |
| 0,35* | 0,39 | 0,33 |
| 0,50* | 0,52 | 0,44 |
| 0,60* | 0,72 | 0,61 |
| 0,75* | 0,85 | 0,72 |
| 0,85* | 0,98 | 0,83 |
| 1,00 | 1,11 | 0,94 |
| 1,10* | 1,24 | 1,05 |
| 1,25* | 1,37 | 1,16 |
| 1,35* | 1,50 | 1,27 |
| 1,50 | 1,63 | 1,38 |
| 1,60* | 1,76 | 1,49 |

| | | |
|-------|------|------|
| 1,75* | 1,89 | 1,60 |
| 1,85* | 2,02 | 1,71 |
| 2,00 | 2,10 | 1,78 |
| 2,10* | 2,21 | 1,87 |
| 2,25* | 2,34 | 1,98 |
| 2,35* | 2,47 | 2,09 |
| 2,50 | 2,60 | 2,20 |
| 2,60* | 2,73 | 2,31 |
| 2,75* | 2,87 | 2,42 |
| 2,85* | 3,00 | 2,53 |
| 3,00 | 3,15 | 2,67 |
| 3,10* | 3,26 | 2,76 |
| 3,25* | 3,39 | 2,87 |
| 3,35* | 3,52 | 2,98 |
| 3,50 | 3,65 | 3,09 |
| 3,60* | 3,78 | 3,20 |
| 3,75* | 3,91 | 3,31 |
| 3,85* | 4,04 | 3,42 |
| 4,00 | 4,20 | 3,55 |
| 4,10* | 4,30 | 3,64 |
| 4,25* | 4,43 | 3,75 |
| 4,35* | 4,56 | 3,86 |
| 4,50 | 4,69 | 3,97 |
| 4,60* | 4,82 | 4,08 |
| 4,75* | 4,95 | 4,19 |
| 4,85* | 5,08 | 4,30 |
| 5,00 | 5,25 | 4,44 |
| 5,10* | 5,34 | 4,52 |
| 5,25* | 5,47 | 4,63 |
| 5,35* | 5,60 | 4,74 |
| 5,50* | 5,73 | 4,85 |

21. PROGRAMMABLE PARAMETERS

| | | |
|-------|------|------|
| 5,60* | 5,86 | 4,96 |
| 5,75* | 5,99 | 5,07 |
| 5,85* | 6,12 | 5,18 |
| 6,00 | 6,30 | 5,33 |
| 6,10* | 6,38 | 5,40 |
| 6,25* | 6,51 | 5,51 |
| 6,35* | 6,64 | 5,62 |
| 6,50* | 6,77 | 5,73 |
| 6,60* | 6,90 | 5,84 |
| 6,75* | 7,03 | 5,95 |
| 6,85* | 7,16 | 6,06 |
| 7,00 | 7,35 | 6,22 |

* For left ventricular amplitude only.

| Ventricular arrhythmia algorithms | Values |
|--------------------------------------|---|
| Atrial pacing on PVC | Yes- No |
| Post extrasystolic pause suppression | Yes- No |
| Acceleration on PVC | Yes- No |
| Max acceleration rate (ppm) | From 60 to 145 by steps of 5 ; 100 |

| Post-shock mode | Values |
|--|--|
| Mode | OFF -VVI-DDI-DDD |
| Duration | 10s- 20s -30s-1min-2min-3min-4min-5min |
| Basic rate (ppm) | From 50 to 90 by steps of 5 ; 60 (± 4 %) |
| Rest AV delay (ms) | 30-40-45-55-65-70-80-85-95-100-110-115- 125 -135-140-150-155-165-170-180-190-195-205-210-220-225-235-250 (± 19 ms) |
| Exercise AV delay (ms) | 30-40-45-55-65-70- 80 -85-95-100-110-115-125-135-140-150-155-165-170-180-190-195-205-210-220-225-235-250 (± 19 ms) |
| AVD Paced/Sensed Offset (ms) | 0-10-15-25-30-40-45-55- 65 -70-80-85-95-100-110-115-125 (± 1 ms) |
| A amplitude (V) | 1-1.5-2-2.5-3- 3.5 -4-4.5-5-6 (± 20 %) |
| A pulse width (ms) | 0.12-0.25- 0.35 -0.5-0.6-0.75-0.85-1 (± 10 %) |
| RV amplitude (V) | 1-1.5-2-2.5-3- 3.5 -4-4.5-5-6 (± 20 %) |
| RV pulse width (ms) | 0.12-0.25- 0.35 -0.5-0.6-0.75-0.85-1 (± 10 %) |
| LV amplitude (V) | 0.1-0.25-0.35 (± 50 %) 0.5-0.6-0.75-0.85 (± 30 %) 1.00-1.10-1.25-1.35-1.50-1.60-1.75-1.85-2.00-2.10-2.25-2.35-2.50-2.60-2.75-2.85-3.00-3.10-3.25-3.35-3.50-3.60-3.75-3.85-4.00-4.10-4.25-4.35-4.50-4.60-4.75-4.85-5.00-5.10-5.25-5.35-5.50-5.60-5.75-5.85-6.00-6.10-6.25-6.35-6.50-6.60-6.75-6.85-7.00- (± 20 %) |
| LV pulse width (ms) | 0.12-0.25- 0.35 -0.5-0.6-0.75-0.85-1 (± 10 %) 1.10-1.25-1.35-1.50-1.60-1.75-1.85-2.00 (± 1 %) |
| Refractory periods | Values |
| Atrial refractory period post ventricular sensing (ms) | 45 -65-80-95-110-125-140-155 (± 16 ms) |
| Atrial refractory period post ventricular pacing (ms) | 80 -95-110-125-140-155 (± 4 ms) |
| Sensitivity margins | Values |
| Atrial post pacing/sensing margin (mV) | From 0 to 1 by steps of 0.2 ; 0.4 |
| Ventricular post pacing margin (mV) | From 0 to 2 by steps of 0.2 ; 0.8 |
| Response to noise | Values |
| Automatic sensitivity on noise | ON -OFF |
| V pacing on noise | ON -OFF |

| SafeR parameters | Values |
|-------------------|---|
| AVB I switch | Rest+Exercise-Exercise |
| Long PR: max (ms) | From 200 to 500 by steps of 50 ; 450 |
| Long PR: min (ms) | From 200 to 500 by steps of 50 ; 250 |
| Max. pause (s) | 2-3-4 |

21.2. VENTRICULAR TACHYARRHYTHMIA DETECTION

| Therapy zones | Values |
|----------------------------------|--|
| Slow VT detection zone | Slow VT ON- Slow VT OFF |
| VT detection zone | VT ON- VT OFF |
| Fast VT / VF detection zone | Fast VT+VF ON- VF ON |
| Slow VT rate (lower limit) (ppm) | From 100 to 200 by steps of 5 ; 190 |
| VT rate (lower limit) (ppm) | 130-135-140-145-150-155-160-165-170-175-180-185- 190 -195-200-210-220-230 |
| VF rate (lower limit) (ppm) | 150-155-160-165-170-175-180-185- 190 -195-200-210-220-230-240 |
| Fast VT rate (upper limit) (ppm) | 155-160-165-170-175-180-185- 190 -195-200-210-220-230-240-255 |
| Slow VT persistence (cycles) | 4-6-8- 12 -16-20-30-50-100-200 |
| VT persistence (cycles) | 4-6-8- 12 -16-20-30-50-100-200 |
| VF persistence (cycles) | From 4 to 20 by steps of 1 ; 6 |

| Detection criteria | Values |
|--|---|
| Slow VT and VT detection criteria | Rate Only-Stability-Stability+-Stability/Acc-Stability+/Acc- PARAD -PARAD+ |
| Fast VT detection criteria | Rate+Stability -Rate Only |
| Majority: (X/Y), Y (cycles) | 8 -12-16 |
| Majority: (X/Y), X (%) | 65-70- 75 -80-90-95-100 |
| Window of RR stability for Slow VT and VT (ms) | 30-45- 65 -80-95-110-125 |
| Window of RR stability for fast VT (ms) | 30 -45-65 |
| Acceleration (%) | 6-13-19- 25 -31-38-44-50 |
| Long cycle persistence extension (cycles) | From 0 to 16 by steps of 1 ; 10 |
| Long cycle gap (ms) | 15-30-45-65-80-95-110-125-140-155- 170 -190-205 |
| Atrial monitoring | Yes -No |

21.3. VENTRICULAR TACHYARRHYTHMIA THERAPIES

| Common parameters | Values |
|-------------------------------|---|
| Enable ATP therapy | Yes- No |
| Enable shock therapy | Yes -No |
| ATP pacing chamber | Right -Left-R+L |
| Polarity alternation (42J) | Yes- No |
| Atrial coil (SVC) present | Yes -No |
| Active case | Yes -No |
| Shock configuration (+ --> -) | Case to RV-SVC to RV-Case + SVC to RV-RV to Case-RV to SVC- RV to Case + SVC |
| SVC exclusion (shock < 15J) | Yes- No |

21.3.1. Therapy parameters in slow VT zone

| ATP 1 program | Values |
|------------------------------------|---|
| ATP program | OFF -Burst-Burst+Scan-Ramp-Ramp+Scan |
| Number of sequences | 1-2- 3 -4-5-6-7-8-9-10-11-12-13-14-15 |
| Cycles in first sequence | 1-2-3-4-5-6-7- 8 -9-10-11-12-13-14-15 |
| Cycles added per sequence | 0 -1-2-3-4-5-6-7-8-9-10-11-12-13-14-15 |
| Coupling interval (%) | 50-55-60-65-70-75- 80 -85-90-95 |
| Ramp decrement (per cycle) (ms) | 0 -4-8-12-16-20-30-40-50-60 |
| Scan decrement (per sequence) (ms) | 0-4- 8 -12-16-20-30-40-50-60 |
| Time limit (min) | 0.5 -1-1.5- 2 -2.5-3-3.5-4 |
| Minimum cycle length (ms) | 95-110-125-140-155-170-190-205- 220 -235-250-265-280-295-310 |

| ATP 2 program | Values |
|------------------------------------|---|
| ATP program | OFF -Burst-Burst+Scan-Ramp-Ramp+Scan |
| Number of sequences | 1-2- 3 -4-5-6-7-8-9-10-11-12-13-14-15 |
| Cycles in first sequence | 1-2-3-4-5- 6 -7-8-9-10-11-12-13-14-15 |
| Cycles added per sequence | 0- 1 -2-3-4-5-6-7-8-9-10-11-12-13-14-15 |
| Coupling interval (%) | 50-55-60-65-70-75-80- 85 -90-95 |
| Ramp decrement (per cycle) (ms) | 0-4- 8 -12-16-20-30-40-50-60 |
| Scan decrement (per sequence) (ms) | 0 -4-8-12-16-20-30-40-50-60 |
| Time limit (min) | 0.5 -1-1.5- 2 -2.5-3-3.5-4 |
| Minimum cycle length (ms) | 95-110-125-140-155-170-190-205- 220 -235-250-265-280-295-310 |

| Shock program | Values |
|-----------------------------|---|
| Shock 1 (J) | OFF -0.5-0.8-1-1.3-1.5-2-2.5-3-3.5-4-5-6-7-8-9-10-12-14-16-18-20-22-24-26-28-30-32-34-42 |
| Shock 2 (J) | OFF -0.5-0.8-1-1.3-1.5-2-2.5-3-3.5-4-5-6-7-8-9-10-12-14-16-18-20-22-24-26-28-30-32-34-42 |
| Number of Max. Shock (42 J) | OFF -1-2-3-4 |

21.3.2. Therapy parameters in VT zone

| ATP 1 program | Values |
|------------------------------------|---|
| ATP program | OFF-Burst- Burst+Scan -Ramp-Ramp+Scan |
| Number of sequences | 1-2- 3 -4-5-6-7-8-9-10-11-12-13-14-15 |
| Cycles in first sequence | 1-2-3-4-5-6-7- 8 -9-10-11-12-13-14-15 |
| Cycles added per sequence | 0 -1-2-3-4-5-6-7-8-9-10-11-12-13-14-15 |
| Coupling interval (%) | 50-55-60-65-70-75- 80 -85-90-95 |
| Ramp decrement (per cycle) (ms) | 0 -4-8-12-16-20-30-40-50-60 |
| Scan decrement (per sequence) (ms) | 0-4- 8 -12-16-20-30-40-50-60 |
| Time limit (min) | 0.5 -1-1.5- 2 -2.5-3-3.5-4 |
| Minimum cycle length (ms) | 95-110-125-140-155-170-190-205- 220 -235-250-265-280-295-310 |

| ATP 2 program | Values |
|------------------------------------|---|
| ATP program | OFF-Burst-Burst+Scan- Ramp -Ramp+Scan |
| Number of sequences | 1-2- 3 -4-5-6-7-8-9-10-11-12-13-14-15 |
| Cycles in first sequence | 1-2-3-4-5- 6 -7-8-9-10-11-12-13-14-15 |
| Cycles added per sequence | 0- 1 -2-3-4-5-6-7-8-9-10-11-12-13-14-15 |
| Coupling interval (%) | 50-55-60-65-70-75-80- 85 -90-95 |
| Ramp decrement (per cycle) (ms) | 0-4- 8 -12-16-20-30-40-50-60 |
| Scan decrement (per sequence) (ms) | 0 -4-8-12-16-20-30-40-50-60 |
| Time limit (min) | 0.5 -1-1.5- 2 -2.5-3-3.5-4 |
| Minimum cycle length (ms) | 95-110-125-140-155-170-190-205- 220 -235-250-265-280-295-310 |

| Shock program | Values |
|-----------------------------|---|
| Shock 1 (J) | OFF -0.5-0.8-1-1.3-1.5-2-2.5-3-3.5-4-5-6-7-8-9-10-12-14-16-18-20-22-24-26-28-30-32-34-42 |
| Shock 2 (J) | OFF -0.5-0.8-1-1.3-1.5-2-2.5-3-3.5-4-5-6-7-8-9-10-12-14-16-18-20-22-24-26-28-30-32-34-42 |
| Number of Max. Shock (42 J) | OFF-1-2-3- 4 |

21.3.3. Therapy parameters in fast VT / VF zone

| ATP 1 program | Values |
|------------------------------------|---|
| ATP program | OFF- Burst -Burst+Scan-Ramp-Ramp+Scan |
| Number of sequences | <u>1</u> -2-3-4-5-6-7-8-9-10-11-12-13-14-15 |
| Cycles in first sequence | 1-2-3-4-5-6-7- 8 -9-10-11-12-13-14-15 |
| Cycles added per sequence | <u>0</u> -1-2-3-4-5-6-7-8-9-10-11-12-13-14-15 |
| Coupling interval (%) | 50-55-60-65-70-75- 80 -85-90-95 |
| Ramp decrement (per cycle) (ms) | <u>0</u> -4-8-12-16-20-30-40-50-60 |
| Scan decrement (per sequence) (ms) | <u>0</u> -4-8-12-16-20-30-40-50-60 |
| Time limit | 10s-20s- 30s -1min-1.5min-2min |
| Minimum cycle length (ms) | 95-110-125-140-155-170-190- 205 -220-235-250-265-280-295-310 |

| Shock program | Values |
|-----------------------------|---|
| Shock 1 (J) | OFF -0.5-0.8-1-1.3-1.5-2-2.5-3-3.5-4-5-6-7-8-9-10-12-14-16-18-20-22-24-26-28-30-32-34-42 |
| Shock 2 (J) | OFF -0.5-0.8-1-1.3-1.5-2-2.5-3-3.5-4-5-6-7-8-9-10-12-14-16-18-20-22-24-26-28-30-32-34-42 |
| Number of Max. Shock (42 J) | 1-2-3- 4 |

21.4. REMOTE ALERTS AND WARNINGS

The device routinely performs security self-checks and technical measurements to ensure system integrity. When system integrity is found to be at risk outside a follow-up, alerts are stored in the device memory. When system integrity is found to be at risk during a follow-up, the information is managed by a warning (pop-up message) to immediately notify the user. For example, the following types of event can trigger a warning or an alert: technical problem during a shock, pacing lead impedance or coil impedance measurements out-of-range, battery depletion, etc. The Remote tab presents an overview of all the alerts managed by the device.

| General parameters | Values |
|---------------------------------|----------------|
| RF communication ⁽¹⁾ | <u>ON</u> -OFF |
| Alerts ⁽¹⁾ | <u>ON</u> -OFF |

(1) RF and Remote alerts are turned on automatically if Shocks are programmed ON.

When Alerts are programmed "On", the following System Alerts are automatically activated:

- Battery depletion – RRT
- Device reset
- Excessive charge time (>25s)

– System integrity

| Lead Alerts | Values |
|---|-------------------------------------|
| Abnormal A lead impedance | ON-OFF |
| Abnormal A lead low limit (Ohm) | 200 -250-300-350-400-450-500 |
| Abnormal A lead high limit (Ohm) | 1500-1750-2000-2500- 3000 |
| Abnormal RV lead impedance | ON-OFF |
| Abnormal RV lead low limit (Ohm) | 200 -250-300-350-400-450-500 |
| Abnormal RV lead high limit (Ohm) | 1500-1750-2000-2500- 3000 |
| Abnormal LV lead impedance | ON-OFF |
| Abnormal LV lead low limit (Ohm) | 200 -250-300-350-400-450-500 |
| Abnormal LV lead high limit (Ohm) | 1500-1750-2000-2500- 3000 |
| Abnormal RV coil impedance | ON-OFF |
| Abnormal SVC coil impedance | ON-OFF |
| Abnormal Shock impedance ⁽¹⁾ | ON-OFF |

(1) Normal impedance range [20 Ohm-200 Ohm]

| Clinical status | Values |
|------------------------------|----------------------------|
| V oversensing | ON-OFF |
| High AT/AF burden | ON-OFF |
| AT/AF limit (on 24h) (h) | 0.5-1-3- 6 -12-24 |
| Fast V Rate during AT/AF | ON-OFF |
| Fast V Rate limit (ppm) | 80-90- 100 -110-120 |
| Fast V Duration limit (h) | 0.5- 1 -3-6-12-24 |
| Limited % of V pacing in CRT | ON-OFF |
| Limited % of V pacing (%) | 50-70- 80 -85-90-95 |

| Therapy information | Values |
|---------------------|--|
| Shock disabled | ON-OFF |
| Shocks delivered | OFF-All shocks-Inefficient shock- Inefficient max shock |
| ATP delivered | ON-OFF |

22. NON PROGRAMMABLE PARAMETERS

| Interval | Values |
|------------------|---------------------|
| Committed period | 95 ms (\pm 5 ms) |

| Atrial refractory periods | Values |
|---------------------------|----------------------|
| Post atrial sensing | 47 ms (\pm 16 ms) |
| Post atrial pacing | 109 ms (\pm 4 ms) |

| Ventricular refractory periods | Values |
|--------------------------------|----------------------|
| Post ventricular sensing | 95 ms (\pm 16 ms) |
| Post ventricular pacing | 220 ms (\pm 4 ms) |
| Post atrial pacing (blanking) | 16 ms (\pm 3 ms) |

| Tachycardia criteria | Values |
|--------------------------|---------------------|
| Window of PR association | 63 ms (\pm 1 ms) |

| Therapies | Values |
|---------------------------------------|--------------------------------------|
| Waveform ⁽¹⁾ | Constant tilt (50% - 50%) |
| Stored energy for the Max. shock | 42 J |
| Pacing amplitude during ATP therapies | 7 V (Actual value at 300 ms: 5.3 V) |
| Anti-PMT protection | Termin |

(1) The device has 50% tilt in each phase thus delivers 94% of stored energy. Each phase is limited to 10 ms duration.

23. LIMITED WARRANTY

The PLATINIUM implantable cardioverter defibrillator is the result of highly advanced research and all components have been selected after exhaustive testing.

The terms of the limited warranty are available upon request from your Sorin representative or on the CD-ROM of the package content.













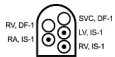







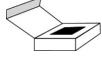

24. PATENTS

The PLATINIUM model described in this manual is covered by the following US patents:

5 713 928, 5 741 315, 5 776 164, 5 776 165, 5 818 703, 5 836 980, 5 868 793, 5 891 170, 5 891 184, 5 899 931, 5 931 856, 5 935 153, 5 954 660, 5 978 708, 6 181 968, 6 230 058, 6 236 111, 6 251 703, 6 256 206, 6 307 261, 6 337 996, 6 397 105, 6 408 209, 6 487 451, 6 487 452, 6 505 068, 6 532 238, 6 556 866, 6 604 002, 6 622 039, 6 625 491, 6 711 441, 6 738 665, 6 830 548, 6 889 080, 6 898 845, 6 912 421, 6 937 898, 6 975 905, 7 065 402, 7 072 716, 7 076 297, 7 113 826, 7 142 924, 7 164 946, 7 251 526, 7 366 566, 7 400 921, 7 400 922, 7 953 483, US8064992, US8043225, US7792582, US8798748, US7890168, US8195293, US7966068, US8768464, US8874209, US8554313, US8214036, US8233981, US8554319, US7966065, US8253279, US8874210, US8219193, US8391976, US8855764, US8359096, US8494629, US8359091, US8489188, US8712526, US8862230, US8641436, US8718765, US8798771, US8868170, US8678843 , US8694098, US8938286, US8874212.

25. EXPLANATION OF SYMBOLS

The symbols on product labelling have the following meaning:

| General symbols | Explanation of symbols | Defibrillator symbols | Explanation of symbols |
|---|--------------------------------------|--|---|
|  | Use by |  | CRT-D, RA, RV, LV |
|  | Date of manufacture |  | CRT-D DF-1 connectors |
|  | Manufacturer |  | CRT-D DF4 connectors |
|  | Catalogue number |  | Shocks |
|  | Serial number |  | ATP Anti-tachycardia pacing, RV, LV |
|  | Implantable device uncoated | DDD | As shipped mode |
|  | Package content |  | Basic rate |
|  | Sterile package content |  | High voltage |
|  | Open here |  | Ready for wireless interrogation and programming by Orchestra Plus programmer equipped with ORCHESTRA PLUS LINK accessory |
|  | Do not use if the package is damaged |  | DF-1 defibrillating connector insulating plug |
|  | Do not reuse | | |
|  | Do not resterilize | | |
|  | Sterilised using ethylene oxide | | |
|  | Non sterile | | |

25. EXPLANATION OF SYMBOLS



Temperature limitation



Torque wrench



Consult instructions for use



Instructions for use in the
CD-ROM



This icon is used to call your
attention to a particularly
important point.



This icon alerts you to a
hazard that may result in
equipment damage or
personal injury. Carefully
read the instructions provided
with this icon.



Eucomed / Advanced Code of
Ethical Business Practice

Last revision date of this implant manual: 2015-03

CAUTION: FEDERAL LAW RESTRICTS THIS DEVICE TO SALE BY OR ON THE ORDER OF A PHYSICIAN



2015-03

U459A

 MANUFACTURED IN ITALY BY
Sorin Group Italia S.r.l.
Via Crescentino s.n.
13040 Saluggia (VC) - Italy
Tel: +39 0161 487095
Fax: +39 0161 487524

DISTRIBUTED BY
Sorin CRM USA, Inc.
14401 West 65th Way
Arvada, CO 80004 - USA
Tel: 877.663.7674

 **SORIN GROUP**
AT THE HEART OF MEDICAL TECHNOLOGY

www.sorin.com