

# CERTIFICATE OF CALIBRATION

ISSUED BY **UL VS LTD**

DATE OF ISSUE: 30/Nov/2017      CERTIFICATE NUMBER : 11903932JD01A



5248

UL VS LTD  
PAVILION A  
ASHWOOD PARK, ASHWOOD WAY  
BASINGSTOKE, HAMPSHIRE  
RG23 8BG, UK  
TEL: +44 (0) 1256 312000  
FAX: +44 (0) 1256 312001  
Email: LST.UK.Calibration@ul.com



Page 1 of 10

APPROVED SIGNATORY

A handwritten signature in black ink, appearing to read 'M. Naseer'.

.....  
Naseer Mirza

## Customer :

UL VS Inc  
47173 Benicia Street  
Fremont, CA 94538, USA

## Equipment Details:

Description:	Dipole Validation Kit	Date of Receipt:	20/Nov/2017
Manufacturer:	Speag		
Type/Model Number:	D750V3		
Serial Number:	1071		
Calibration Date:	21/Nov/2017		
Calibrated By:	Chanthu Thevarajah Laboratory Engineer		

Signature:

A handwritten signature in black ink, appearing to read 'Chanthu Thevarajah'.

.....

All Calibration have been conducted in the closed laboratory facility: Lab Temperature (22±3) °C and humidity < 70%

This certificate is issued in accordance with the laboratory accreditation requirements of the United Kingdom Accreditation Service. It provides traceability of measurement to the SI system of units and/or to units of measurement realised at the National Physical Laboratory or other recognised national metrology institutes. This certificate may not be reproduced other than in full, except with the prior written approval of the issuing laboratory.

Use of the UKAS mark demonstrates that compliance with the requirements of BS/EN/ISO/IEC 17025 has been independently assessed.

# CERTIFICATE OF CALIBRATION

## ISSUED BY UL VS LTD

CERTIFICATE  
NUMBER :  
11903932JD01A

UKAS Accredited Calibration Laboratory No. 5248

Page 2 of 10

The calibration methods and procedures used were as detailed in:

1. **IEC 62209-1:2005**: Procedure to determine the specific absorption rate (SAR) for hand-held devices used in close proximity to the ear (frequency range of 300 MHz to 3 GHz)
2. **IEC 62209-2:2010**: Procedure to determine the specific absorption rate (SAR) for wireless communication devices used in close proximity to the human body (frequency range of 30 MHz to 6 GHz)
3. **IEEE 1528: 2013**: IEEE Recommended Practice for Determining the Peak Spatial-Average Specific Absorption Rate (SAR) in the Human Head from Wireless Communication Devices: Measurement Techniques
4. FCC KDB Publication Number: **"KDB865664 D01 SAR Measurement 100 MHz to 6 GHz"**
5. **SPEAG DASY4/ DASY5 System Handbook**

The measuring equipment used to perform the calibration, documented in this certificate has been calibrated in accordance with the manufacturers' recommendations, and is traceable to recognized national standards.

UL No.	Instrument	Manufacturer	Type No.	Serial No.	Date Last Calibrated	Cal. Interval (Months)
A2546	Data Acquisition Electronics	SPEAG	DAE4	1435	10 Feb 2017	12
A2545	Probe	SPEAG	ES3DV4	3395	04 May 2017	12
A2765	Dipole	SPEAG	D750V3	1147	21 Sep 2017	12
PRE0151451	Power Monitoring Kit	Art-Fi	ART 100850-01	0001	Cal as part of System	12
M1855	Power Sensor	Rhode & Schwarz	NRP-Z51	103246	08 Nov 2017	12
M1015	Network Analyser	Agilent Technologies	8753ES	US39172406	10 Oct 2017	12
PRE0151154	Network Analyser	Rhode & Schwarz	ZND8	100151	22 Nov 2016	24
PRE0151877	Calibration Kit	Rhode & Schwarz	Z135	102947-Bt	02 Dec 2016	12
M1838	Signal Generator	Rhode & Schwarz	SME06	831377/005	30 Mars 2017	12

# CERTIFICATE OF CALIBRATION

## ISSUED BY UL VS LTD

CERTIFICATE  
NUMBER :  
11903932JD01A

UKAS Accredited Calibration Laboratory No. 5248

Page 3 of 10

### SAR System Specification

Robot System Positioner:	Stäubli Unimation Corp. Robot Model: TX60L
Robot Serial Number:	F14/5T5ZA1/A/01
DASY Version:	DASY 52 (v52.8.8.1258)
Phantom:	Flat section of SAM Twin Phantom
Distance Dipole Centre:	15 mm (with spacer)
Frequency:	750 MHz

### Dielectric Property Measurements – Head Simulating Liquid (HSL)

Simulant Liquid	Frequency (MHz)	Room Temp		Liquid Temp		Parameters	Target Value	Measured Value	Uncertainty (%)
		Start	End	Start	End				
Head	750	21.0 °C	21.0 °C	20.5°C	21.0°C	$\epsilon_r$	41.96	41.94	± 5%
						$\sigma$	0.89	0.91	± 5%

### SAR Results – Head Simulating Liquid (HSL)

Simulant Liquid	SAR Measured	250 mW input Power	Normalised to 1.00 W	Uncertainty (%)
Head	SAR averaged over 1g	2.16 W/Kg	8.59 W/Kg	± 17.57%
	SAR averaged over 10g	1.44 W/Kg	5.73 W/Kg	± 17.32%

### Antenna Parameters – Head Simulating Liquid (HSL)

Simulant Liquid	Parameter	Measured Level	Uncertainty (%)
Head	Impedance	46.312 $\Omega$ 2.22 j $\Omega$	± 0.28 $\Omega$ ± 0.044 j $\Omega$
	Return Loss	26.76	± 2.03 dB

# CERTIFICATE OF CALIBRATION

## ISSUED BY UL VS LTD

UKAS Accredited Calibration Laboratory No. 5248

CERTIFICATE  
NUMBER :  
11903932JD01A

Page 4 of 10

### Dielectric Property Measurements – Body Simulating Liquid (MSL)

Simulant Liquid	Frequency (MHz)	Room Temp		Liquid Temp		Parameters	Target Value	Measured Value	Uncertainty (%)
		Start	End	Start	End				
Body	750	21.0 °C	21.0 °C	21.0°C	21.0°C	$\epsilon_r$	55.55	54.53	± 5%
						$\sigma$	0.96	0.96	± 5%

### SAR Results – Body Simulating Liquid (MSL)

Simulant Liquid	SAR Measured	250 mW input Power	Normalised to 1.00 W	Uncertainty (%)
Body	SAR averaged over 1g	2.14 W/Kg	<b>8.52 W/Kg</b>	± 18.06%
	SAR averaged over 10g	1.43 W/Kg	<b>5.69 W/Kg</b>	± 17.44%

### Antenna Parameters – Body Simulating Liquid (MSL)

Simulant Liquid	Parameter	Measured Level	Uncertainty (%)
Body	Impedance	52.11 $\Omega$ 4.88 j $\Omega$	± 0.28 $\Omega$ ± 0.044 j $\Omega$
	Return Loss	26.35	± 2.03 dB

# CERTIFICATE OF CALIBRATION

## ISSUED BY UL VS LTD

CERTIFICATE  
NUMBER :  
11903932JD01A

UKAS Accredited Calibration Laboratory No. 5248

Page 5 of 10

### DASY Validation Scan for Head Stimulating Liquid (HSL)

DUT: Dipole 750 MHz SN:1047; Type: D750V3; Serial: D750V3 - SN:1071

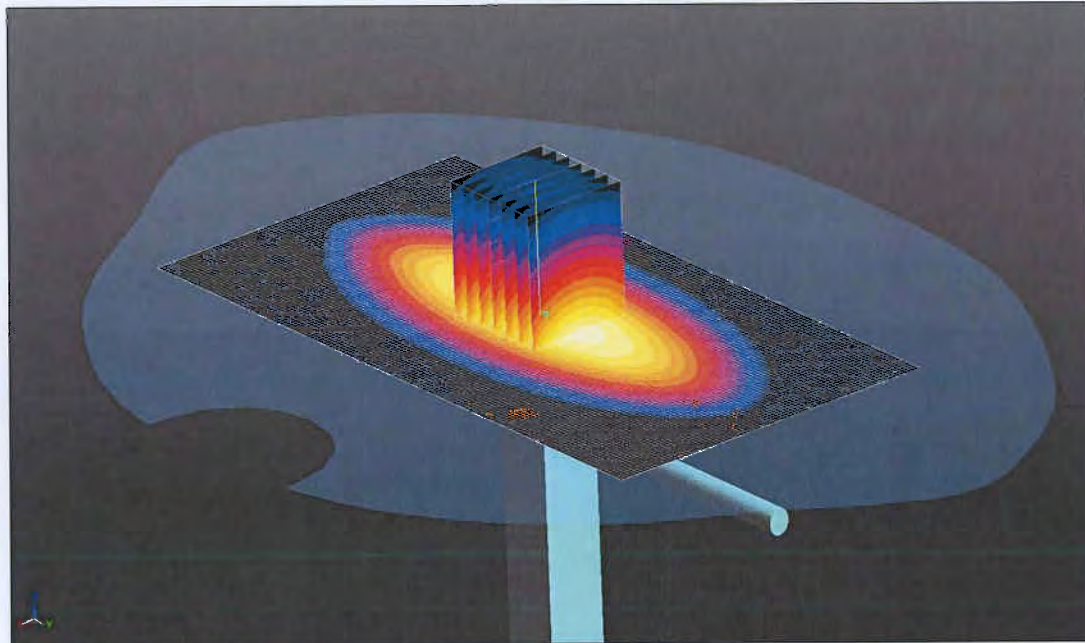

0 dB = 2.50 W/kg = 3.98 dBW/kg

Communication System: UID 0, CW; Frequency: 750 MHz; Duty Cycle: 1:1

Medium: 750,835,900,1800,1900 MHz HSL Medium parameters used:  $f = 750$  MHz;  $\sigma = 0.914$  S/m;  $\epsilon_r = 41.936$ ;  $\rho = 1000$  kg/m<sup>3</sup>

Phantom section: Flat Section

DASY5 Configuration:

- Probe: EX3DV4 - SN3995; ConvF(10.57, 10.57, 10.57); Calibrated: 04/05/2017;

- Sensor-Surface: 3mm (Mechanical Surface Detection)

- Electronics: DAE4 Sn1435; Calibrated: 10/02/2017

- Phantom: SAM (30deg probe tilt) with CRP v5.0; Type: QD000P40CD; Serial: TP:xxxx

- ; SEMCAD X Version 14.6.10 (7372)

**Configuration/d=15mm, Pin=250mW 2 2 2 2 2/Area Scan (81x151x1):** Interpolated grid: dx=1.200 mm, dy=1.200 mm

Maximum value of SAR (interpolated) = 2.50 W/kg

**Configuration/d=15mm, Pin=250mW 2 2 2 2 2/Zoom Scan (5x5x7) (7x7x7)/Cube 0:** Measurement grid: dx=5mm, dy=5mm, dz=5mm

Reference Value = 50.49 V/m; Power Drift = -0.01 dB

Peak SAR (extrapolated) = 3.18 W/kg

**SAR(1 g) = 2.16 W/kg; SAR(10 g) = 1.44 W/kg**

Maximum value of SAR (measured) = 2.50 W/kg

# CERTIFICATE OF CALIBRATION ISSUED BY UL VS LTD

UKAS Accredited Calibration Laboratory No. 5248

CERTIFICATE  
NUMBER :  
11903932JD01A

Page 6 of 10

## Impedance Measurement Plot for Head Stimulating Liquid (HSL)



11/28/2017 3:29:06 PM  
1326.5170K92-100151-MV

Trc1 — S11 Smith 200 mU/ Ref 1 U Cal Smo

1

M1 750.000000 MHz 46.312  $\Omega$   
j2.224  $\Omega$   
472.041 pF

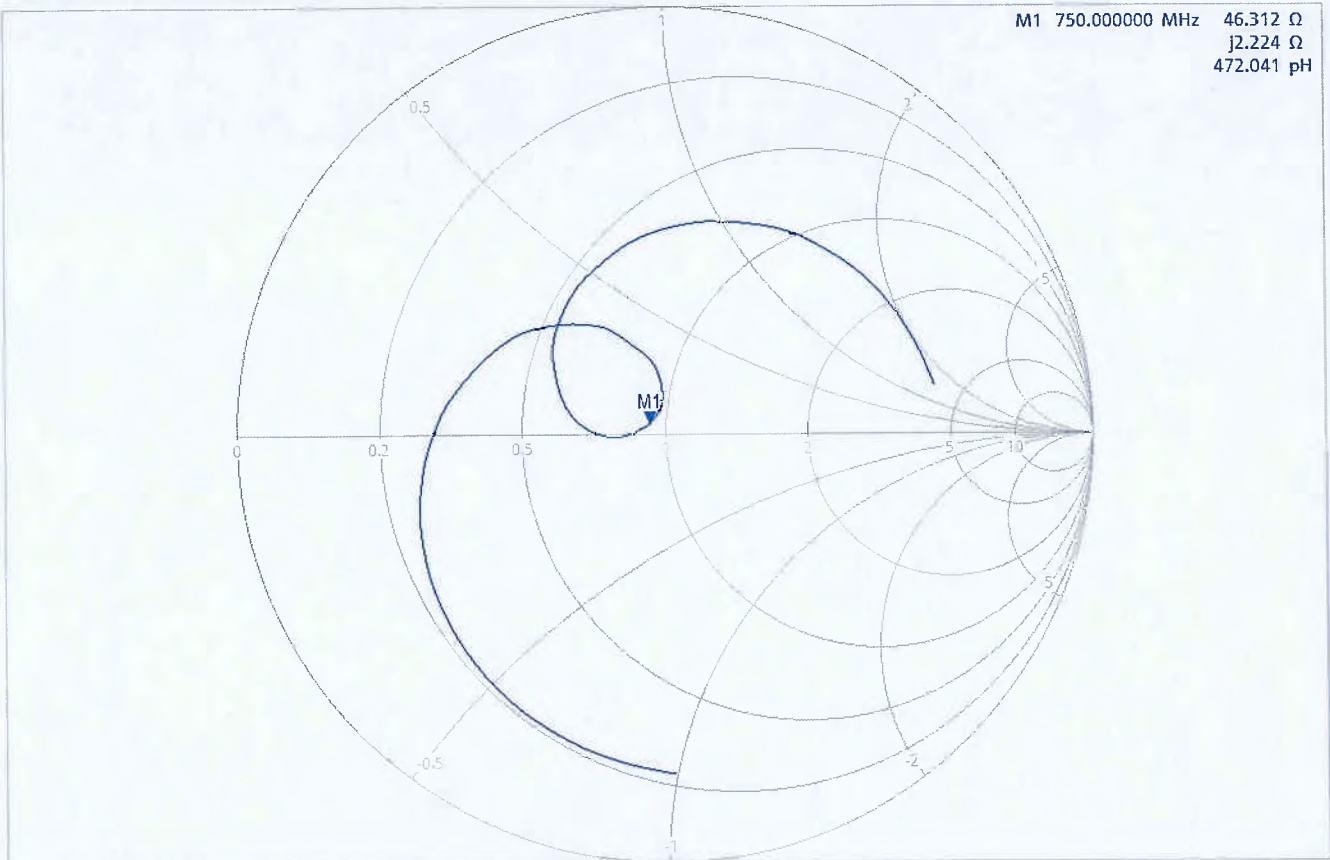

Ch1 Start 550 MHz

Pwr -10 dBm Bw 10 kHz

Stop 950 MHz

# CERTIFICATE OF CALIBRATION

## ISSUED BY UL VS LTD

UKAS Accredited Calibration Laboratory No. 5248

CERTIFICATE  
NUMBER :  
11903932JD01A

Page 7 of 10

### Return Loss Measurement Plot for Head Stimulating Liquid (HSL)

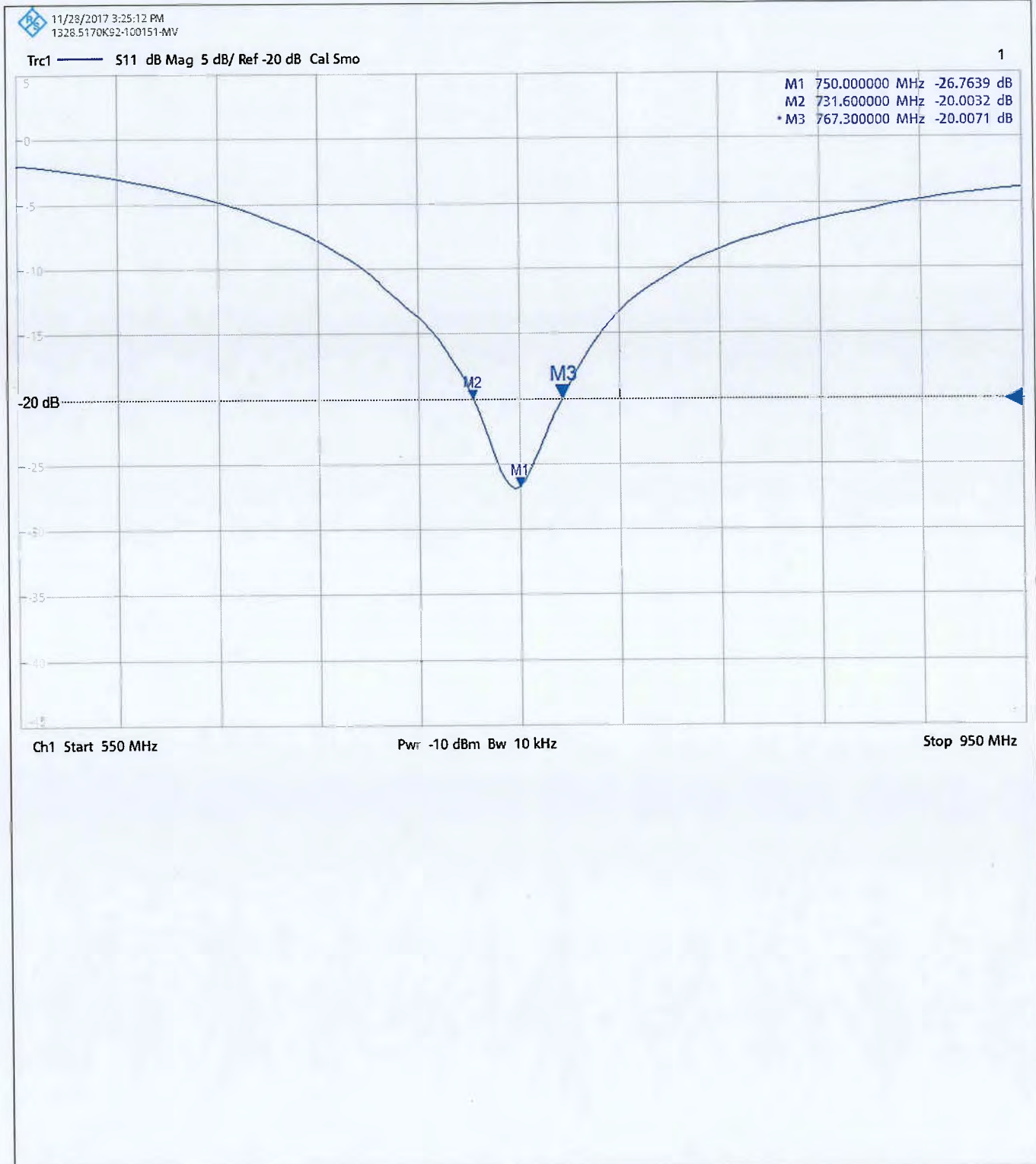

# CERTIFICATE OF CALIBRATION ISSUED BY UL VS LTD

CERTIFICATE  
NUMBER :  
11903932JD01A

UKAS Accredited Calibration Laboratory No. 5248

Page 8 of 10

## DASY Validation Scan for Body Stimulating Liquid (MSL)

DUT: Dipole 750 MHz; Type: D750V3; Serial: D750V3 - SN:1011

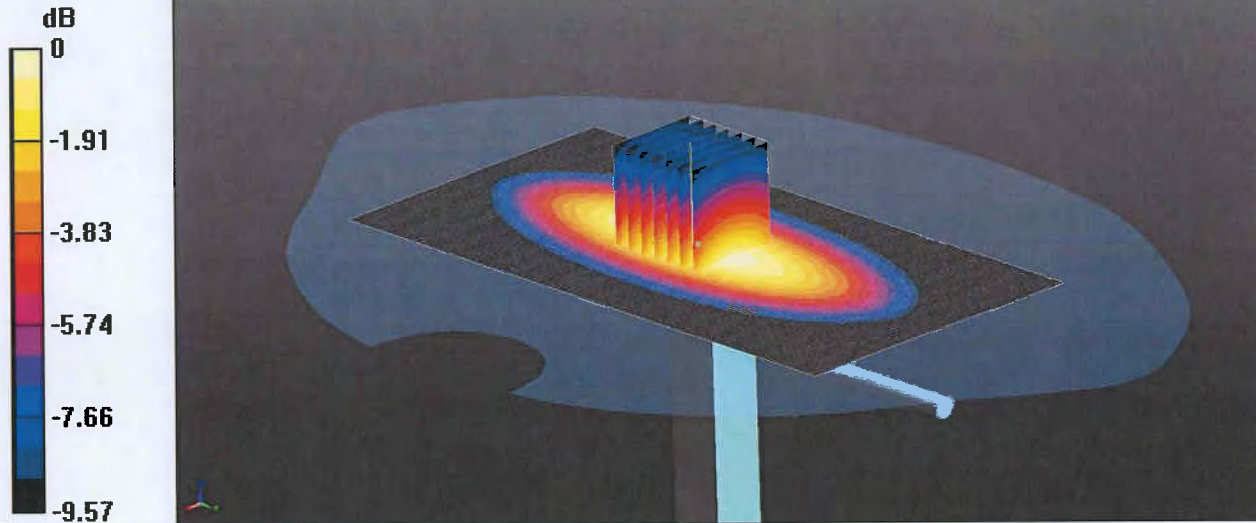

0 dB = 2.29 W/kg = 3.60 dBW/kg

Communication System: UID 0, CW; Frequency: 750 MHz; Duty Cycle: 1:1

Medium: MSL(750,835,900,1800,1900,5G) Medium parameters used:  $f = 750$  MHz;  $\sigma = 0.96$  S/m;  $\epsilon_r = 54.527$ ;  $\rho = 1000$  kg/m<sup>3</sup>

Phantom section: Flat Section

DASY5 Configuration:

- Probe: EX3DV4 - SN3995; ConvF(10.33, 10.33, 10.33); Calibrated: 04/05/2017;
- Sensor-Surface: 4mm (Mechanical Surface Detection)
- Electronics: DAE4 Sn1435; Calibrated: 10/02/2017
- Phantom: SAM (20deg probe tilt) with CRP v4.0; Type: QD000P40CC; Serial: TP:xxxx
- ; SEMCAD X Version 14.6.10 (7372)

**Configuration/d=15mm, Pin=250mW 2/Area Scan (81x151x1):** Interpolated grid: dx=1.200 mm, dy=1.200 mm

Maximum value of SAR (interpolated) = 2.29 W/kg

**Configuration/d=15mm, Pin=250mW 2/Zoom Scan (5x5x7) (7x7x7)/Cube 0:** Measurement grid: dx=5mm, dy=5mm, dz=5mm

Reference Value = 48.67 V/m; Power Drift = 0.02 dB

Peak SAR (extrapolated) = 3.12 W/kg

**SAR(1 g) = 2.14 W/kg; SAR(10 g) = 1.43 W/kg**

Maximum value of SAR (measured) = 2.29 W/kg



# CERTIFICATE OF CALIBRATION

## ISSUED BY UL VS LTD

UKAS Accredited Calibration Laboratory No. 5248

CERTIFICATE  
NUMBER :  
11903932JD01A

Page 9 of 10

### Impedance Measurement Plot for Body Stimulating Liquid (MSL)

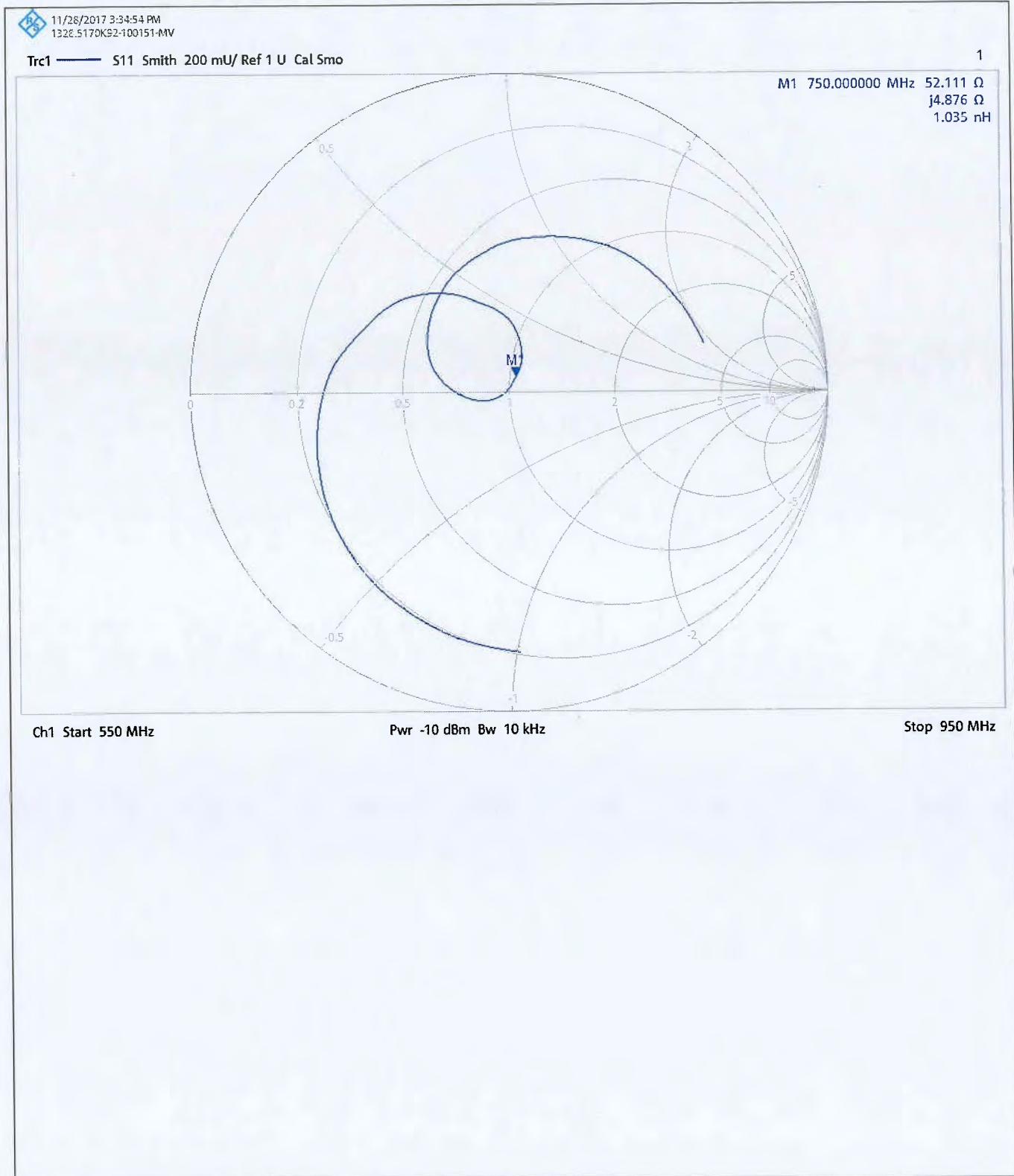

# CERTIFICATE OF CALIBRATION

## ISSUED BY UL VS LTD

UKAS Accredited Calibration Laboratory No. 5248

CERTIFICATE  
NUMBER :  
11903932JD01A

Page 10 of 10

### Return Loss Measurement Plot for Body Stimulating Liquid (MSL)



**Calibration Certificate Label:**

 5248	<b>UL VS LTD - Tel: +44 (0) 1256312000</b>
	Certificate Number: 11903932JD01A
	Instrument ID: 1071
	Calibration Date: 21/Nov/2017
	Calibration Due Date:

 5248	<b>UL VS LTD - Tel: +44 (0) 1256312000</b>
	Certificate Number: 11903932JD01A
	Instrument ID: 1071
	Calibration Date: 21/Nov/2017
	Calibration Due Date:

 5248	<b>UL VS LTD - Tel: +44 (0) 1256312000</b>
	Certificate Number: 11903932JD01A
	Instrument ID: 1071
	Calibration Date: 21/Nov/2017
	Calibration Due Date:

# CERTIFICATE OF CALIBRATION

ISSUED BY **UL VS LTD**

DATE OF ISSUE: 28/Nov/2018      CERTIFICATE NUMBER : 12134289JD01A



**5248**

UL VS LTD  
UNIT 1 HORIZON  
KINGSLAND PARK, WADE ROAD  
BASINGSTOKE, HAMPSHIRE  
RG24 8AH, UK  
TEL: +44 (0) 1256 312000  
FAX: +44 (0) 1256 312001  
Email: LST.UK.Calibration@ul.com



Page 1 of 10

**APPROVED SIGNATORY**

.....  
Naseer Mirza

**Customer :**

UL VS Inc  
47173 Benicia Street  
Fremont, CA 94538, USA

**Equipment Details:**

Description:	Dipole Validation Kit	Date of Receipt:	20/Nov/2017
Manufacturer:	Speag		
Type/Model Number:	D750V3		
Serial Number:	1071		
Calibration Date:	28/Nov/2018		
Calibrated By:	Chanthu Thevarajah Senior Engineer		

Signature:

.....

All Calibration have been conducted in the closed laboratory facility: Lab Temperature (22±3) °C and humidity < 70%

This certificate is issued in accordance with the laboratory accreditation requirements of the United Kingdom Accreditation Service. It provides traceability of measurement to the SI system of units and/or to units of measurement realised at the National Physical Laboratory or other recognised national metrology institutes. This certificate may not be reproduced other than in full, except with the prior written approval of the issuing laboratory.

Use of the UKAS mark demonstrates that compliance with the requirements of BS/EN/ISO/IEC 17025 has been independently assessed.

# CERTIFICATE OF CALIBRATION

## ISSUED BY UL VS LTD

UKAS Accredited Calibration Laboratory No. 5248

CERTIFICATE  
NUMBER :  
12134289JD01A

Page 2 of 10

The calibration methods and procedures used were as detailed in:

1. **IEC 62209-1:2016**: Procedure to determine the specific absorption rate (SAR) for hand-held devices used in close proximity to the ear (frequency range of 300 MHz to 3 GHz)
2. **IEC 62209-2:2010**: Procedure to determine the specific absorption rate (SAR) for wireless communication devices used in close proximity to the human body (frequency range of 30 MHz to 6 GHz)
3. **IEEE 1528: 2013**: IEEE Recommended Practice for Determining the Peak Spatial-Average Specific Absorption Rate (SAR) in the Human Head from Wireless Communication Devices: Measurement Techniques
4. FCC KDB Publication Number: “**KDB865664 D01 SAR Measurement 100 MHz to 6 GHz**”
5. **SPEAG DASY4/ DASY5 System Handbook**

The measuring equipment used to perform the calibration, documented in this certificate has been calibrated in accordance with the manufacturers' recommendations, and is traceable to recognized national standards.

UL No.	Instrument	Manufacturer	Type No.	Serial No.	Date Last Calibrated	Cal. Interval (Months)
PRE0178318	Data Acquisition Electronics	SPEAG	DAE4	1543	08 Mar 2018	12
PRE0178315	Probe	SPEAG	ES3DV3	3360	17 Aug 2018	12
A1985	Dipole	SPEAG	D750V3	1011	07 Feb 2018	12
PRE0151451	Power Monitoring Kit	Art-Fi	ART 100850-01	0001	Cal as part of System	12
PRE0151441	Power Sensor	Rhode & Schwarz	NRP8S	102481	05 Feb 2018	12
PRE0151154	Network Analyser	Rhode & Schwarz	ZND8	100151	14 Dec 2017	12
PRE0151877	Calibration Kit	Rhode & Schwarz	ZV-Z135	102947-Bt	27 Apr 2018	12
PRE0178154	Signal Generator	Rhode & Schwarz	SMB 100A	175325	09 Apr 2018	12

# CERTIFICATE OF CALIBRATION

## ISSUED BY **UL VS LTD**

UKAS Accredited Calibration Laboratory No. 5248

CERTIFICATE  
NUMBER :  
12134289JD01A

Page 3 of 10

### SAR System Specification

<b>Robot System Positioner:</b>	Stäubli Unimation Corp. Robot Model: TX60L
<b>Robot Serial Number:</b>	F17/5ENYG1/A/01
<b>DASY Version:</b>	DASY 52 (v52.8.8.1258)
<b>Phantom:</b>	Flat section of SAM Twin Phantom
<b>Distance Dipole Centre:</b>	15 mm (with spacer)
<b>Frequency:</b>	750 MHz

### Dielectric Property Measurements – Head Simulating Liquid (HSL)

Simulant Liquid	Frequency (MHz)	Room Temp		Liquid Temp		Parameters	Target Value	Measured Value	Uncertainty (%)
		Start	End	Start	End				
Head	750	20.0 °C	20.5 °C	20.5°C	20.5°C	$\epsilon_r$	41.96	41.83	± 5%
						$\sigma$	0.89	0.90	± 5%

### SAR Results – Head Simulating Liquid (HSL)

Simulant Liquid	SAR Measured	250 mW input Power	Normalised to 1.00 W	Uncertainty (%)
Head	SAR averaged over 1g	2.09 W/Kg	<b>8.32 W/Kg</b>	± 17.57%
	SAR averaged over 10g	1.37 W/Kg	<b>5.45 W/Kg</b>	± 17.32%

### Antenna Parameters – Head Simulating Liquid (HSL)

Simulant Liquid	Parameter	Measured Level	Uncertainty (%)
Head	Impedance	47.158 $\Omega$ 3.05 $j\Omega$	± 0.28 $\Omega$ ± 0.044 $j\Omega$
	Return Loss	-26.81	± 2.03 dB

# CERTIFICATE OF CALIBRATION

## ISSUED BY **UL VS LTD**

UKAS Accredited Calibration Laboratory No. 5248

CERTIFICATE  
NUMBER :  
12134289JD01A

Page 4 of 10

### Dielectric Property Measurements – Body Simulating Liquid (MSL)

Simulant Liquid	Frequency (MHz)	Room Temp		Liquid Temp		Parameters	Target Value	Measured Value	Uncertainty (%)
		Start	End	Start	End				
Body	750	20.0 °C	20.0 °C	19.3°C	20.0°C	<b>ε<sub>r</sub></b>	55.55	54.19	± 5%
						<b>σ</b>	0.96	0.96	± 5%

### SAR Results – Body Simulating Liquid (MSL)

Simulant Liquid	SAR Measured	250 mW input Power	Normalised to 1.00 W	Uncertainty (%)
Body	SAR averaged over 1g	2.17 W/Kg	<b>8.63 W/Kg</b>	± 18.06%
	SAR averaged over 10g	1.42 W/Kg	<b>5.65 W/Kg</b>	± 17.44%

### Antenna Parameters – Body Simulating Liquid (MSL)

Simulant Liquid	Parameter	Measured Level	Uncertainty (%)
Body	Impedance	52.66 Ω 4.35 jΩ	± 0.28 Ω ± 0.044 jΩ
	Return Loss	-26.59	± 2.03 dB

# CERTIFICATE OF CALIBRATION

## ISSUED BY UL VS LTD

CERTIFICATE  
NUMBER :  
12134289JD01A

UKAS Accredited Calibration Laboratory No. 5248

Page 5 of 10

### DASY Validation Scan for Head Stimulating Liquid (HSL)

DUT: D750V3 - SN1071; Type: D750V3; Serial: SN1071

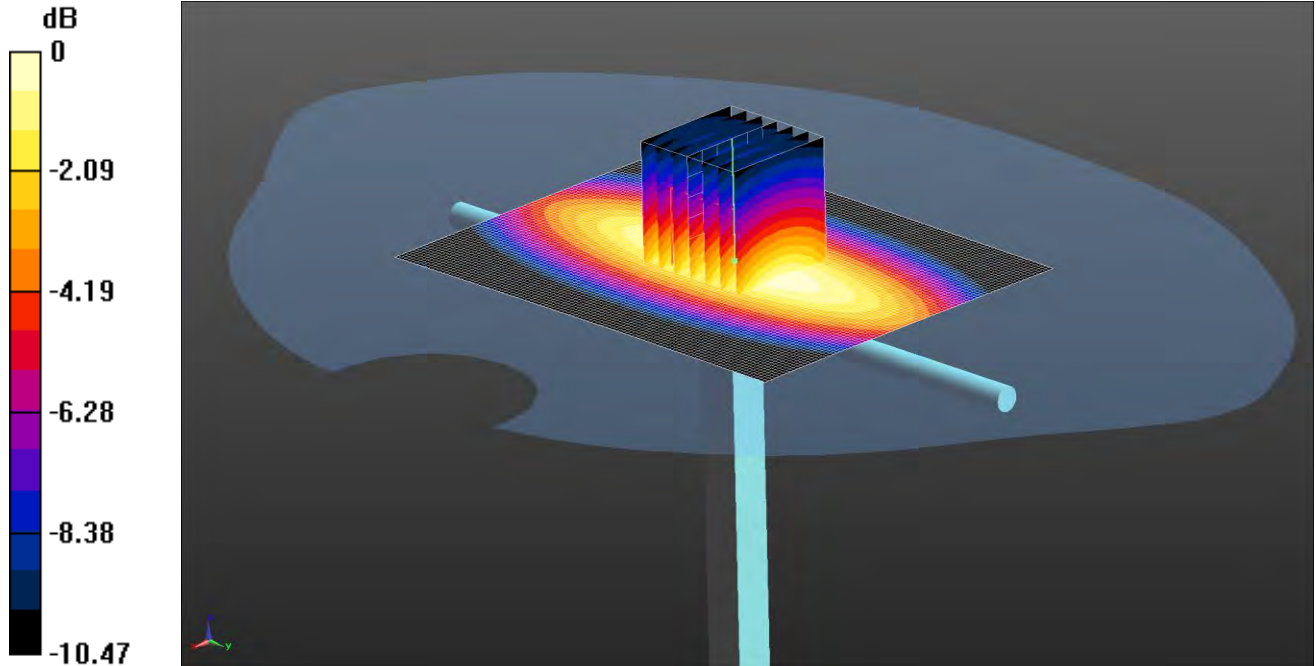

0 dB = 2.45 W/kg = 3.89 dBW/kg

Communication System: UID 0, CW (0); Frequency: 750 MHz; Duty Cycle: 1:1

Medium: 750 835 900 1800 1900 MHz HSL Medium parameters used:  $f = 750$  MHz;  $\sigma = 0.899$  S/m;  $\epsilon_r = 41.829$ ;  $\rho = 1000$  kg/m<sup>3</sup>

Phantom section: Flat Section

DASY4 Configuration:

- Probe: ES3DV3 - SN3360; ConvF(6.48, 6.48, 6.48); Calibrated: 17/08/2018;

- Sensor-Surface: 3mm (Mechanical Surface Detection)

- Electronics: DAE4 Sn1543; Calibrated: 08/03/2018

- Phantom: Twin SAM A (Site 65); Type: SAM 8.0; Serial: TP:1945

- ; SEMCAD X Version 14.6.10 (7417)

**Configuration/d=10mm, Pin=250mW 2/Area Scan (81x101x1):** Interpolated grid: dx=1.200 mm, dy=1.200 mm

Maximum value of SAR (interpolated) = 2.45 W/kg

**Configuration/d=10mm, Pin=250mW 2/Zoom Scan 2 (7x7x7)/Cube 0:** Measurement grid: dx=5mm, dy=5mm, dz=5mm

Reference Value = 53.77 V/m; Power Drift = -0.03 dB

Peak SAR (extrapolated) = 3.13 W/kg

**SAR(1 g) = 2.09 W/kg; SAR(10 g) = 1.37 W/kg**

Maximum value of SAR (measured) = 2.45 W/kg



# CERTIFICATE OF CALIBRATION

## ISSUED BY UL VS LTD

CERTIFICATE  
NUMBER :  
12134289JD01A

UKAS Accredited Calibration Laboratory No. 5248

Page 6 of 10

### Impedance Measurement Plot for Head Stimulating Liquid (HSL)

11/23/2018 12:00:16 PM  
1328.5170K92-100151-MV

Trc1 — S11 Smith 200 mU/ Ref 1 U Cal Smo

1

• M1 750.000000 MHz 47.158 Ω  
j3.048 Ω  
646.882 pF

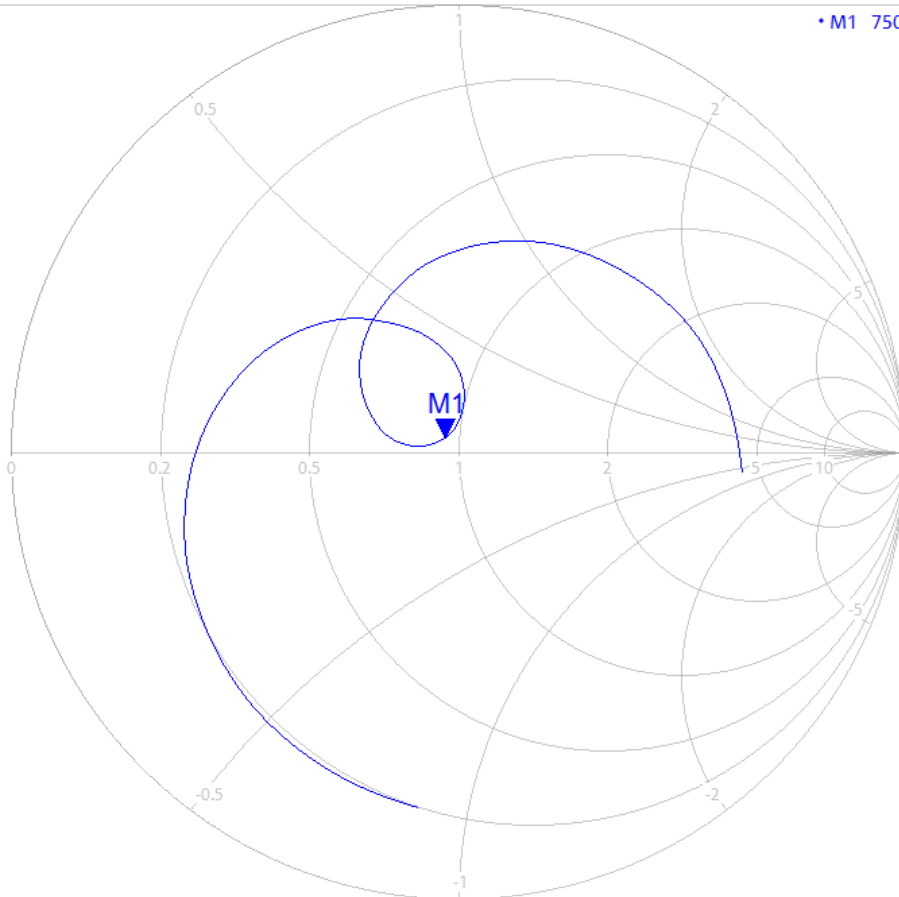

Ch1 Center 750 MHz

Pwr -10 dBm Bw 10 kHz

Span 400 MHz

# CERTIFICATE OF CALIBRATION

## ISSUED BY UL VS LTD

UKAS Accredited Calibration Laboratory No. 5248

CERTIFICATE  
NUMBER :  
12134289JD01A

Page 7 of 10

### Return Loss Measurement Plot for Head Stimulating Liquid (HSL)

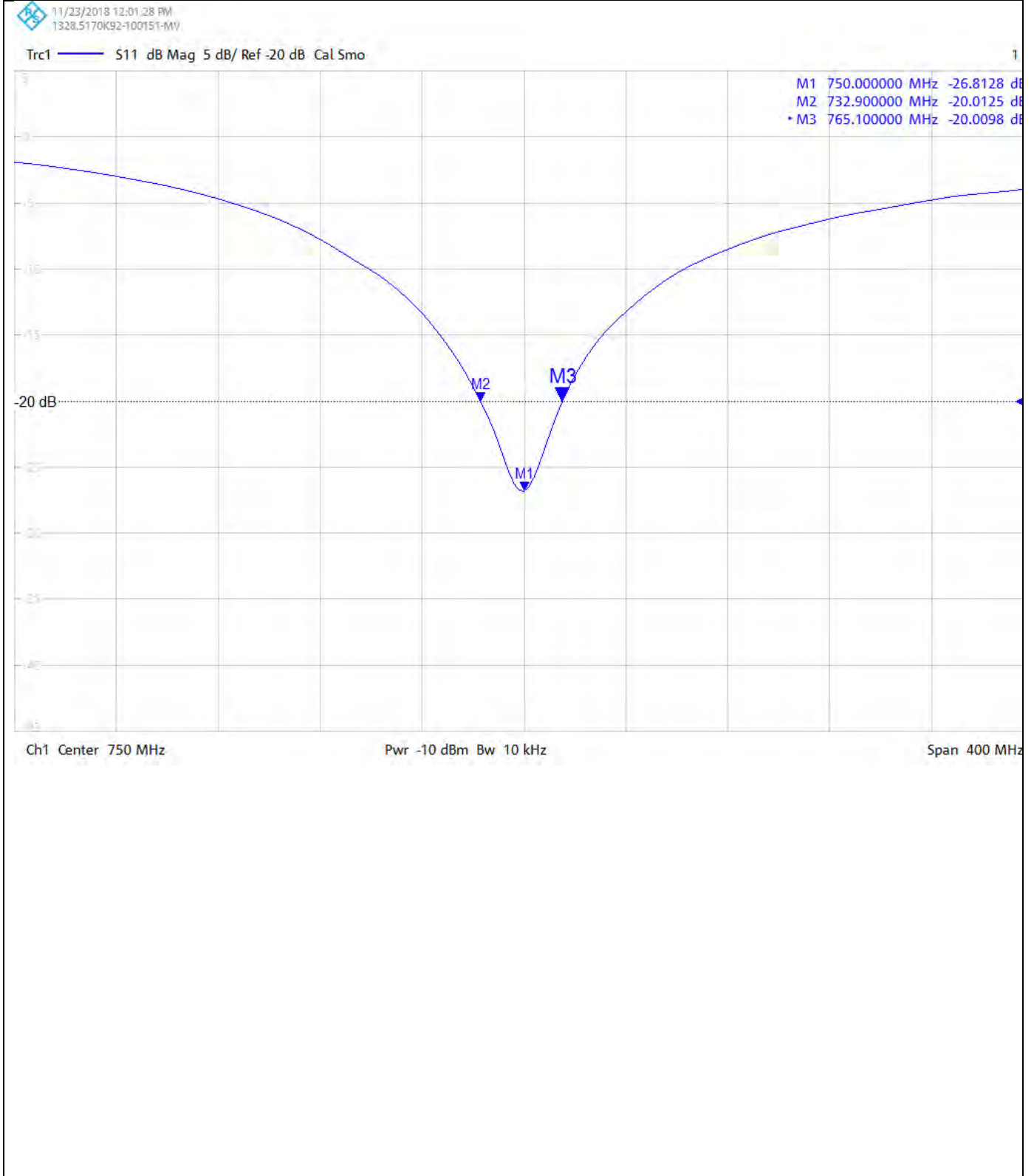

# CERTIFICATE OF CALIBRATION

## ISSUED BY UL VS LTD

CERTIFICATE  
NUMBER :  
12134289JD01A

UKAS Accredited Calibration Laboratory No. 5248

Page 8 of 10

### DASY Validation Scan for Body Stimulating Liquid (MSL)

DUT: D750V3 - SN1071; Type: D750V3; Serial: SN1071

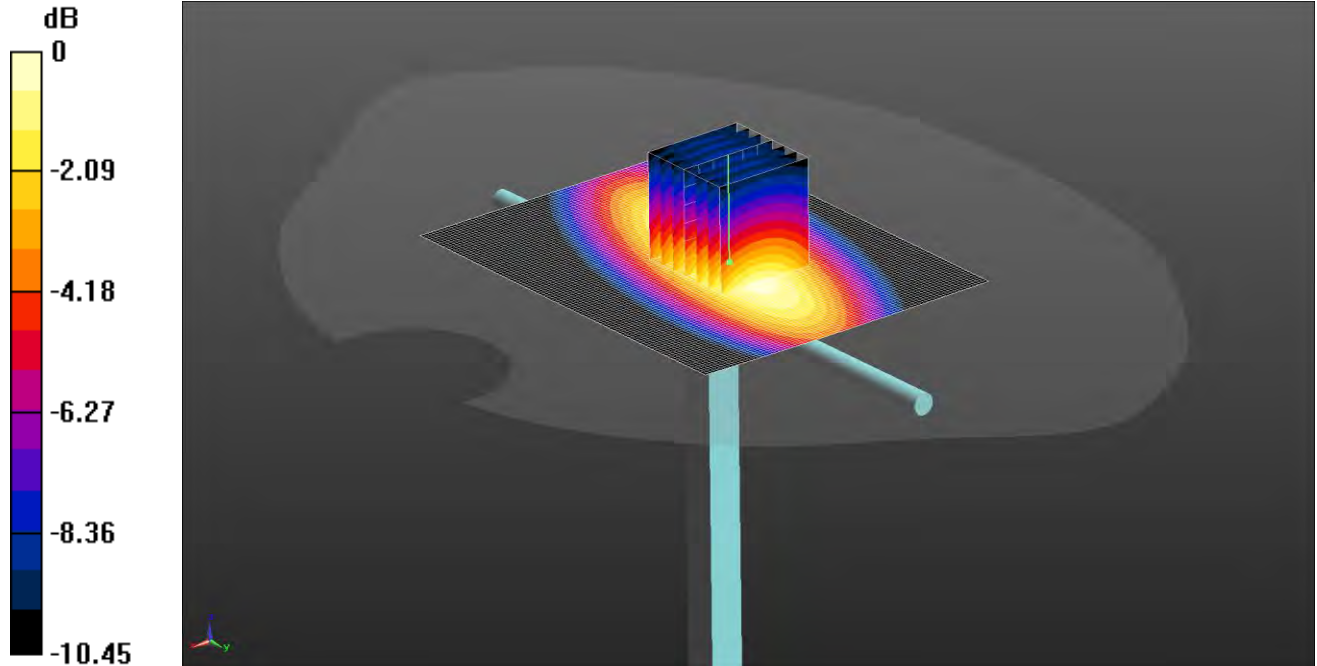

0 dB = 2.54 W/kg = 4.05 dBW/kg

Communication System: UID 0, CW (0); Frequency: 750 MHz; Duty Cycle: 1:1

Medium: 750 835 900 1800 MHz MSL Medium parameters used:  $f = 750$  MHz;  $\sigma = 0.959$  S/m;  $\epsilon_r = 54.189$ ;  $\rho = 1000$  kg/m<sup>3</sup>

Phantom section: Flat Section

DASY4 Configuration:

- Probe: ES3DV3 - SN3360; ConvF(6.55, 6.55, 6.55); Calibrated: 17/08/2018;

- Sensor-Surface: 3mm (Mechanical Surface Detection)

- Electronics: DAE4 Sn1543; Calibrated: 08/03/2018

- Phantom: Twin SAM B (Site 65); Type: SAM 5.0; Serial: TP:1836

- ; SEMCAD X Version 14.6.10 (7417)

**Configuration/d=10mm, Pin=250mW 2/Area Scan (81x101x1):** Interpolated grid: dx=1.200 mm, dy=1.200 mm

Maximum value of SAR (interpolated) = 2.53 W/kg

**Configuration/d=10mm, Pin=250mW 2/Zoom Scan 2 (7x7x7)/Cube 0:** Measurement grid: dx=5mm, dy=5mm, dz=5mm

Reference Value = 51.97 V/m; Power Drift = 0.06 dB

Peak SAR (extrapolated) = 3.28 W/kg

**SAR(1 g) = 2.17 W/kg; SAR(10 g) = 1.42 W/kg**

Maximum value of SAR (measured) = 2.54 W/kg

# CERTIFICATE OF CALIBRATION

## ISSUED BY UL VS LTD

CERTIFICATE  
NUMBER :  
12134289JD01A

UKAS Accredited Calibration Laboratory No. 5248

Page 9 of 10

### Impedance Measurement Plot for Body Stimulating Liquid (MSL)

11/23/2018 3:34:36 PM  
1328.5170K92-100151-MV

Trc1 — S11 Smith 200 mU/ Ref 1 U Cal Smo

1

• M1 750.000000 MHz 52.661  $\Omega$   
j4.355  $\Omega$   
924.067 pF

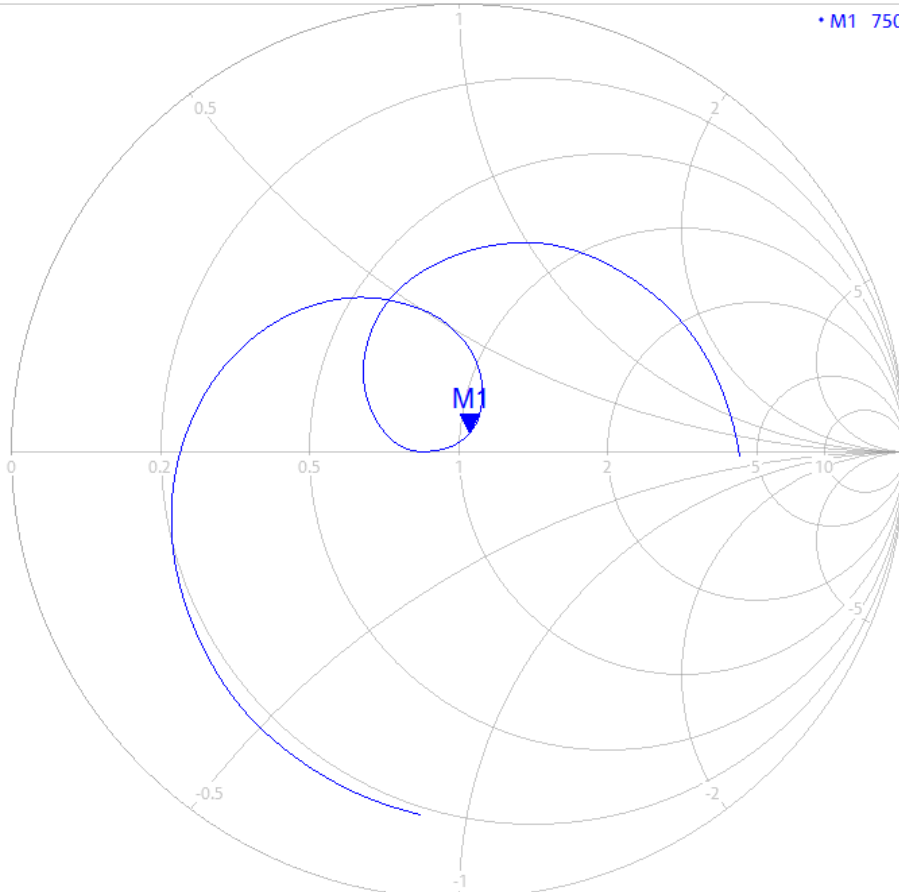

Ch1 Center 750 MHz

Pwr -10 dBm Bw 10 kHz

Span 400 MHz

# CERTIFICATE OF CALIBRATION

## ISSUED BY UL VS LTD

UKAS Accredited Calibration Laboratory No. 5248

CERTIFICATE  
NUMBER :  
12134289JD01A

Page 10 of 10

### Return Loss Measurement Plot for Body Stimulating Liquid (MSL)

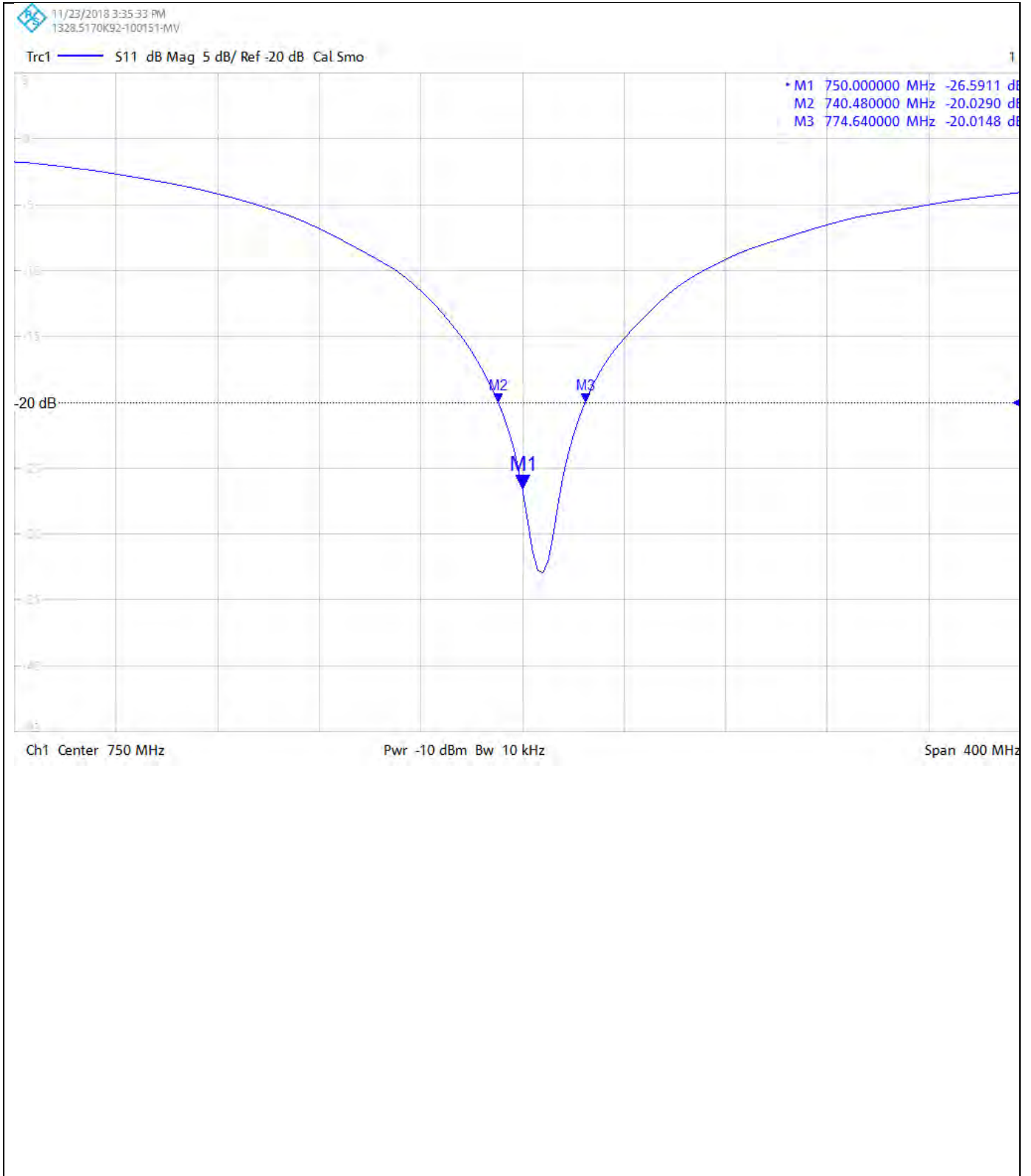

**Calibration Certificate Label:**

 <p>UKAS CALIBRATION 5248</p>	<p><b>UL VS LTD - Tel: +44 (0) 1256312000</b></p> <p>Certificate Number: 12134289JD01A</p> <p>Instrument ID: 1071</p> <p>Calibration Date: 28/Nov/2018</p> <p>Calibration Due Date:</p>
--	---

 <p>UKAS CALIBRATION 5248</p>	<p><b>UL VS LTD - Tel: +44 (0) 1256312000</b></p> <p>Certificate Number: 12134289JD01A</p> <p>Instrument ID: 1071</p> <p>Calibration Date: 28/Nov/2018</p> <p>Calibration Due Date:</p>
--	---

 <p>UKAS CALIBRATION 5248</p>	<p><b>UL VS LTD - Tel: +44 (0) 1256312000</b></p> <p>Certificate Number: 12134289JD01A</p> <p>Instrument ID: 1071</p> <p>Calibration Date: 28/Nov/2018</p> <p>Calibration Due Date:</p>
--	---



Accredited by the Swiss Accreditation Service (SAS)  
**The Swiss Accreditation Service is one of the signatories to the EA  
Multilateral Agreement for the recognition of calibration certificates**

**Accreditation No.: SCS 0108**

**Client** **UL CCS USA**

**Certificate No:** **D835V2-4d142\_Oct17**

## CALIBRATION CERTIFICATE

**Object** **D835V2 - SN:4d142**

**Calibration procedure(s)** **QA CAL-05.v9  
Calibration procedure for dipole validation kits above 700 MHz**

**Calibration date:** **October 12, 2017**

This calibration certificate documents the traceability to national standards, which realize the physical units of measurements (SI).  
The measurements and the uncertainties with confidence probability are given on the following pages and are part of the certificate.

All calibrations have been conducted in the closed laboratory facility: environment temperature (22 ± 3)°C and humidity < 70%.

Calibration Equipment used (M&TE critical for calibration)

Primary Standards	ID #	Cal Date (Certificate No.)	Scheduled Calibration
Power meter NRP	SN: 104778	04-Apr-17 (No. 217-02521/02522)	Apr-18
Power sensor NRP-Z91	SN: 103244	04-Apr-17 (No. 217-02521)	Apr-18
Power sensor NRP-Z91	SN: 103245	04-Apr-17 (No. 217-02522)	Apr-18
Reference 20 dB Attenuator	SN: 5058 (20k)	07-Apr-17 (No. 217-02528)	Apr-18
Type-N mismatch combination	SN: 5047.2 / 06327	07-Apr-17 (No. 217-02529)	Apr-18
Reference Probe EX3DV4	SN: 7349	31-May-17 (No. EX3-7349_May17)	May-18
DAE4	SN: 601	28-Mar-17 (No. DAE4-601_Mar17)	Mar-18

Secondary Standards	ID #	Check Date (in house)	Scheduled Check
Power meter EPM-442A	SN: GB37480704	07-Oct-15 (in house check Oct-16)	In house check: Oct-18
Power sensor HP 8481A	SN: US37292783	07-Oct-15 (in house check Oct-16)	In house check: Oct-18
Power sensor HP 8481A	SN: MY41092317	07-Oct-15 (in house check Oct-16)	In house check: Oct-18
RF generator R&S SMT-06	SN: 100972	15-Jun-15 (in house check Oct-16)	In house check: Oct-18
Network Analyzer HP 8753E	SN: US37390585	18-Oct-01 (in house check Oct-17)	In house check: Oct-18

	Name	Function	Signature
Calibrated by:	Leif Klysner	Laboratory Technician	
Approved by:	Katja Pokovic	Technical Manager	

Issued: October 13, 2017

This calibration certificate shall not be reproduced except in full without written approval of the laboratory.



Accredited by the Swiss Accreditation Service (SAS)

The Swiss Accreditation Service is one of the signatories to the EA Multilateral Agreement for the recognition of calibration certificates

### Glossary:

TSL	tissue simulating liquid
ConvF	sensitivity in TSL / NORM x,y,z
N/A	not applicable or not measured

### Calibration is Performed According to the Following Standards:

- IEEE Std 1528-2013, "IEEE Recommended Practice for Determining the Peak Spatial-Averaged Specific Absorption Rate (SAR) in the Human Head from Wireless Communications Devices: Measurement Techniques", June 2013
- IEC 62209-1, "Measurement procedure for the assessment of Specific Absorption Rate (SAR) from hand-held and body-mounted devices used next to the ear (frequency range of 300 MHz to 6 GHz)", July 2016
- IEC 62209-2, "Procedure to determine the Specific Absorption Rate (SAR) for wireless communication devices used in close proximity to the human body (frequency range of 30 MHz to 6 GHz)", March 2010
- KDB 865664, "SAR Measurement Requirements for 100 MHz to 6 GHz"

### Additional Documentation:

- DASY4/5 System Handbook

### Methods Applied and Interpretation of Parameters:

- Measurement Conditions:* Further details are available from the Validation Report at the end of the certificate. All figures stated in the certificate are valid at the frequency indicated.
- Antenna Parameters with TSL:* The dipole is mounted with the spacer to position its feed point exactly below the center marking of the flat phantom section, with the arms oriented parallel to the body axis.
- Feed Point Impedance and Return Loss:* These parameters are measured with the dipole positioned under the liquid filled phantom. The impedance stated is transformed from the measurement at the SMA connector to the feed point. The Return Loss ensures low reflected power. No uncertainty required.
- Electrical Delay:* One-way delay between the SMA connector and the antenna feed point. No uncertainty required.
- SAR measured:* SAR measured at the stated antenna input power.
- SAR normalized:* SAR as measured, normalized to an input power of 1 W at the antenna connector.
- SAR for nominal TSL parameters:* The measured TSL parameters are used to calculate the nominal SAR result.

The reported uncertainty of measurement is stated as the standard uncertainty of measurement multiplied by the coverage factor  $k=2$ , which for a normal distribution corresponds to a coverage probability of approximately 95%.



## Measurement Conditions

DASY system configuration, as far as not given on page 1.

DASY Version	DASY5	V52.10.0
Extrapolation	Advanced Extrapolation	
Phantom	Modular Flat Phantom	
Distance Dipole Center - TSL	15 mm	with Spacer
Zoom Scan Resolution	dx, dy, dz = 5 mm	
Frequency	835 MHz $\pm$ 1 MHz	

## Head TSL parameters

The following parameters and calculations were applied.

	Temperature	Permittivity	Conductivity
Nominal Head TSL parameters	22.0 °C	41.5	0.90 mho/m
Measured Head TSL parameters	(22.0 $\pm$ 0.2) °C	40.7 $\pm$ 6 %	0.92 mho/m $\pm$ 6 %
Head TSL temperature change during test	< 0.5 °C	----	----

## SAR result with Head TSL

SAR averaged over 1 cm <sup>3</sup> (1 g) of Head TSL	Condition	
SAR measured	250 mW input power	2.46 W/kg
SAR for nominal Head TSL parameters	normalized to 1W	<b>9.64 W/kg <math>\pm</math> 17.0 % (k=2)</b>

SAR averaged over 10 cm <sup>3</sup> (10 g) of Head TSL	condition	
SAR measured	250 mW input power	1.58 W/kg
SAR for nominal Head TSL parameters	normalized to 1W	<b>6.22 W/kg <math>\pm</math> 16.5 % (k=2)</b>

## Body TSL parameters

The following parameters and calculations were applied.

	Temperature	Permittivity	Conductivity
Nominal Body TSL parameters	22.0 °C	55.2	0.97 mho/m
Measured Body TSL parameters	(22.0 $\pm$ 0.2) °C	54.4 $\pm$ 6 %	1.01 mho/m $\pm$ 6 %
Body TSL temperature change during test	< 0.5 °C	----	----

## SAR result with Body TSL

SAR averaged over 1 cm <sup>3</sup> (1 g) of Body TSL	Condition	
SAR measured	250 mW input power	2.49 W/kg
SAR for nominal Body TSL parameters	normalized to 1W	<b>9.63 W/kg <math>\pm</math> 17.0 % (k=2)</b>

SAR averaged over 10 cm <sup>3</sup> (10 g) of Body TSL	condition	
SAR measured	250 mW input power	1.61 W/kg
SAR for nominal Body TSL parameters	normalized to 1W	<b>6.27 W/kg <math>\pm</math> 16.5 % (k=2)</b>

## Appendix (Additional assessments outside the scope of SCS 0108)

### Antenna Parameters with Head TSL

Impedance, transformed to feed point	50.8 $\Omega$ - 3.4 $j\Omega$
Return Loss	- 29.3 dB

### Antenna Parameters with Body TSL

Impedance, transformed to feed point	47.1 $\Omega$ - 6.0 $j\Omega$
Return Loss	- 23.3 dB

### General Antenna Parameters and Design

Electrical Delay (one direction)	1.392 ns
----------------------------------	----------

After long term use with 100W radiated power, only a slight warming of the dipole near the feedpoint can be measured.

The dipole is made of standard semirigid coaxial cable. The center conductor of the feeding line is directly connected to the second arm of the dipole. The antenna is therefore short-circuited for DC-signals. On some of the dipoles, small end caps are added to the dipole arms in order to improve matching when loaded according to the position as explained in the "Measurement Conditions" paragraph. The SAR data are not affected by this change. The overall dipole length is still according to the Standard.

No excessive force must be applied to the dipole arms, because they might bend or the soldered connections near the feedpoint may be damaged.

### Additional EUT Data

Manufactured by	SPEAG
Manufactured on	March 27, 2012

# DASY5 Validation Report for Head TSL

Date: 12.10.2017

Test Laboratory: SPEAG, Zurich, Switzerland

**DUT: Dipole 835 MHz; Type: D835V2; Serial: D835V2 - SN:4d142**

Communication System: UID 0 - CW; Frequency: 835 MHz

Medium parameters used:  $f = 835 \text{ MHz}$ ;  $\sigma = 0.92 \text{ S/m}$ ;  $\epsilon_r = 40.7$ ;  $\rho = 1000 \text{ kg/m}^3$

Phantom section: Flat Section

Measurement Standard: DASY5 (IEEE/IEC/ANSI C63.19-2011)

DASY52 Configuration:

- Probe: EX3DV4 - SN7349; ConvF(10.07, 10.07, 10.07); Calibrated: 31.05.2017;
- Sensor-Surface: 1.4mm (Mechanical Surface Detection)
- Electronics: DAE4 Sn601; Calibrated: 28.03.2017
- Phantom: Flat Phantom 4.9 (front); Type: QD 00L P49 AA; Serial: 1001
- DASY52 52.10.0(1446); SEMCAD X 14.6.10(7417)

**Dipole Calibration for Head Tissue/Pin=250 mW, d=15mm/Zoom Scan (7x7x7)/Cube 0:**

Measurement grid:  $dx=5\text{mm}$ ,  $dy=5\text{mm}$ ,  $dz=5\text{mm}$

Reference Value = 63.04 V/m; Power Drift = 0.00 dB

Peak SAR (extrapolated) = 3.87 W/kg

**SAR(1 g) = 2.46 W/kg; SAR(10 g) = 1.58 W/kg**

Maximum value of SAR (measured) = 3.37 W/kg

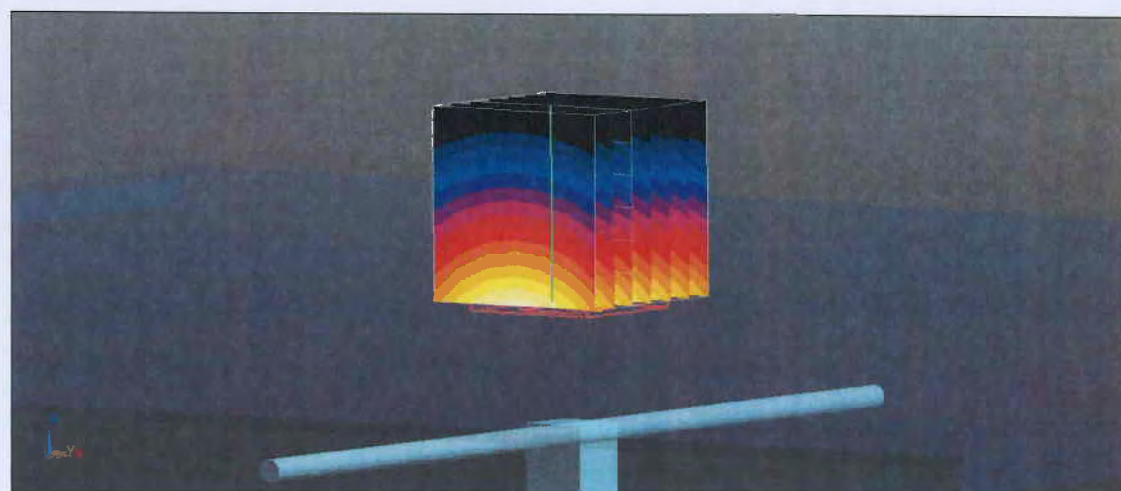
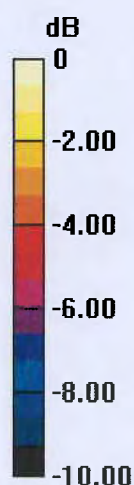

0 dB = 3.37 W/kg = 5.28 dBW/kg

# Impedance Measurement Plot for Head TSL

12 Oct 2017 14:25:42

CH1 S11 1 U FS 1: 50.820  $\Omega$  -3.3574  $\Omega$  56.771 pF 835.000 000 MHz

\*  
Del  
CA

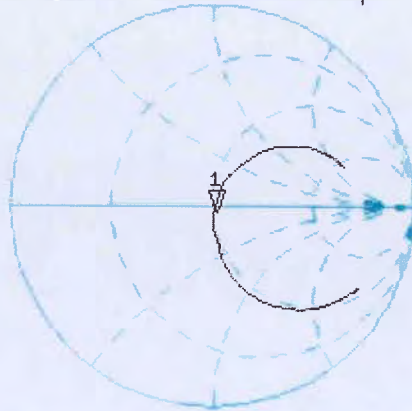

Avg  
16

H1d

CH2 S11 LOG 5 dB/REF -20 dB 1: -29.311 dB 835.000 000 MHz

CA

Avg  
16

H1d

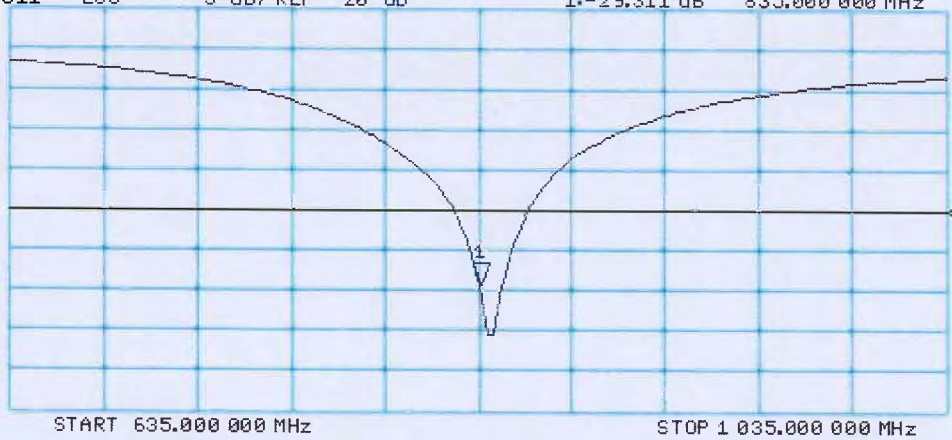

# DASY5 Validation Report for Body TSL

Date: 12.10.2017

Test Laboratory: SPEAG, Zurich, Switzerland

**DUT: Dipole 835 MHz; Type: D835V2; Serial: D835V2 - SN:4d142**

Communication System: UID 0 - CW; Frequency: 835 MHz

Medium parameters used:  $f = 835$  MHz;  $\sigma = 1.01$  S/m;  $\epsilon_r = 54.4$ ;  $\rho = 1000$  kg/m<sup>3</sup>

Phantom section: Flat Section

Measurement Standard: DASY5 (IEEE/IEC/ANSI C63.19-2011)

DASY52 Configuration:

- Probe: EX3DV4 - SN7349; ConvF(10.2, 10.2, 10.2); Calibrated: 31.05.2017;
- Sensor-Surface: 1.4mm (Mechanical Surface Detection)
- Electronics: DAE4 Sn601; Calibrated: 28.03.2017
- Phantom: Flat Phantom 4.9 (Back); Type: QD 00R P49 AA; Serial: 1005
- DASY52 52.10.0(1446); SEMCAD X 14.6.10(7417)

## Dipole Calibration for Body Tissue/Pin=250 mW, d=15mm/Zoom Scan (7x7x7)/Cube 0:

Measurement grid: dx=5mm, dy=5mm, dz=5mm

Reference Value = 60.44 V/m; Power Drift = -0.02 dB

Peak SAR (extrapolated) = 3.83 W/kg

**SAR(1 g) = 2.49 W/kg; SAR(10 g) = 1.61 W/kg**

Maximum value of SAR (measured) = 3.33 W/kg

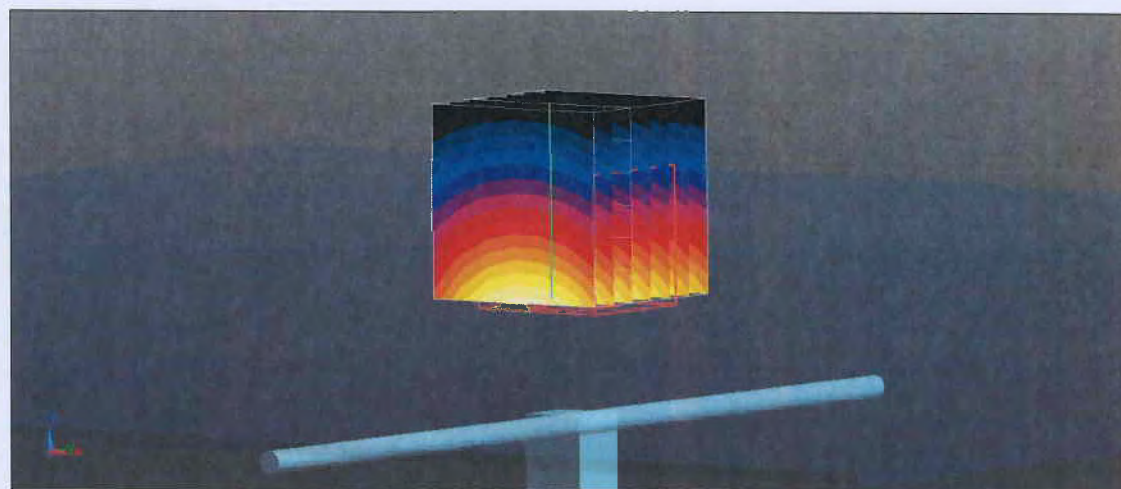
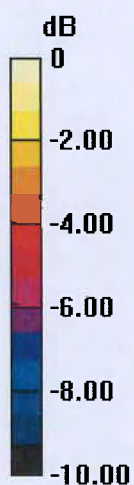

0 dB = 3.33 W/kg = 5.22 dBW/kg

# Impedance Measurement Plot for Body TSL

12 Oct 2017 13:06:15

CH1 S11 1 U FS 1: 47.109  $\Omega$  -5.9531  $\Omega$  32.018  $\mu\text{F}$  835.000 000 MHz

\*  
Del

CΔ

Avg  
16

H1d

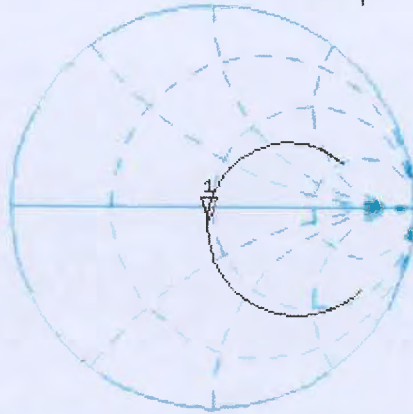

CH2 S11 LOG 5 dB/REF -20 dB 1: -23.344 dB 835.000 000 MHz

CΔ

Avg  
16

H1d

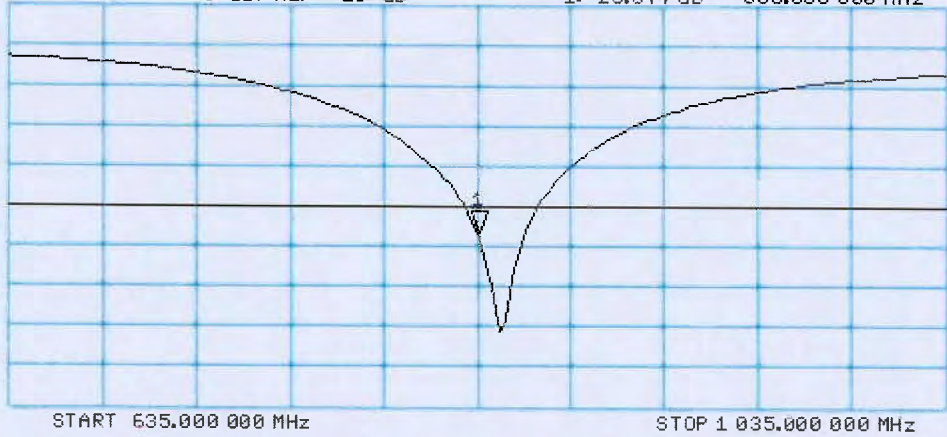

## Appendix (Additional assessments outside the scope of SCS 0108)

### Evaluation Condition

Phantom	SAM Head Phantom	For usage with cSAR3DV2-R/L
---------	------------------	-----------------------------

### SAR result with SAM Head (Top)

SAR averaged over 1 cm <sup>3</sup> (1 g) of Head TSL	Condition	
SAR (average measured)	250 mW input power	2.34 W/kg
SAR for nominal Head TSL parameters	normalized to 1W	<b>9.05 W/kg ± 17.5 % (k=2)</b>

SAR averaged over 10 cm <sup>3</sup> (10 g) of Head TSL	condition	
SAR measured	250 mW input power	1.53 W/kg
SAR for nominal Head TSL parameters	normalized to 1W	<b>5.97 W/kg ± 16.9 % (k=2)</b>

### SAR result with SAM Head (Mouth)

SAR averaged over 1 cm <sup>3</sup> (1 g) of Head TSL	Condition	
SAR (average measured)	250 mW input power	2.45 W/kg
SAR for nominal Head TSL parameters	normalized to 1W	<b>9.50 W/kg ± 17.5 % (k=2)</b>

SAR averaged over 10 cm <sup>3</sup> (10 g) of Head TSL	condition	
SAR (average measured)	250 mW input power	1.63 W/kg
SAR for nominal Head TSL parameters	normalized to 1W	<b>6.36 W/kg ± 16.9 % (k=2)</b>

### SAR result with SAM Head (Neck)

SAR averaged over 1 cm <sup>3</sup> (1 g) of Head TSL	Condition	
SAR (average measured)	250 mW input power	2.32 W/kg
SAR for nominal Head TSL parameters	normalized to 1W	<b>9.03 W/kg ± 17.5 % (k=2)</b>

SAR averaged over 10 cm <sup>3</sup> (10 g) of Head TSL	condition	
SAR (average measured)	250 mW input power	1.55 W/kg
SAR for nominal Head TSL parameters	normalized to 1W	<b>6.08 W/kg ± 16.9 % (k=2)</b>

### SAR result with SAM Head (Ear)

SAR averaged over 1 cm <sup>3</sup> (1 g) of Head TSL	Condition	
SAR (average measured)	250 mW input power	1.99 W/kg
SAR for nominal Head TSL parameters	normalized to 1W	<b>7.73 W/kg ± 17.5 % (k=2)</b>

SAR averaged over 10 cm <sup>3</sup> (10 g) of Head TSL	condition	
SAR (average measured)	250 mW input power	1.33 W/kg
SAR for nominal Head TSL parameters	normalized to 1W	<b>5.18 W/kg ± 16.9 % (k=2)</b>



Accredited by the Swiss Accreditation Service (SAS)

Accreditation No.: **SCS 0108**

The Swiss Accreditation Service is one of the signatories to the EA  
Multilateral Agreement for the recognition of calibration certificates

Client **UL CCS USA**

Certificate No: **D835V2-4d142\_Aug18**

## CALIBRATION CERTIFICATE

Object **D835V2 - SN:4d142**

Calibration procedure(s) **QA CAL-05.v10  
Calibration procedure for dipole validation kits above 700 MHz**

Calibration date: **August 23, 2018**

This calibration certificate documents the traceability to national standards, which realize the physical units of measurements (SI).  
The measurements and the uncertainties with confidence probability are given on the following pages and are part of the certificate.

All calibrations have been conducted in the closed laboratory facility: environment temperature ( $22 \pm 3$ )°C and humidity < 70%.

Calibration Equipment used (M&TE critical for calibration)

Primary Standards	ID #	Cal Date (Certificate No.)	Scheduled Calibration
Power meter NRP	SN: 104778	04-Apr-18 (No. 217-02672/02673)	Apr-19
Power sensor NRP-Z91	SN: 103244	04-Apr-18 (No. 217-02672)	Apr-19
Power sensor NRP-Z91	SN: 103245	04-Apr-18 (No. 217-02673)	Apr-19
Reference 20 dB Attenuator	SN: 5058 (20k)	04-Apr-18 (No. 217-02682)	Apr-19
Type-N mismatch combination	SN: 5047.2 / 06327	04-Apr-18 (No. 217-02683)	Apr-19
Reference Probe EX3DV4	SN: 7349	30-Dec-17 (No. EX3-7349_Dec17)	Dec-18
DAE4	SN: 601	26-Oct-17 (No. DAE4-601_Oct17)	Oct-18

Secondary Standards	ID #	Check Date (in house)	Scheduled Check
Power meter EPM-442A	SN: GB37480704	07-Oct-15 (in house check Oct-16)	In house check: Oct-18
Power sensor HP 8481A	SN: US37292783	07-Oct-15 (in house check Oct-16)	In house check: Oct-18
Power sensor HP 8481A	SN: MY41092317	07-Oct-15 (in house check Oct-16)	In house check: Oct-18
RF generator R&S SMT-06	SN: 100972	15-Jun-15 (in house check Oct-16)	In house check: Oct-18
Network Analyzer Agilent E8358A	SN: US41080477	31-Mar-14 (in house check Oct-17)	In house check: Oct-18

Calibrated by: **Michael Weber**      Name: Michael Weber      Function: Laboratory Technician

Signature

Approved by: **Katja Pokovic**      Name: Katja Pokovic      Function: Technical Manager

Issued: August 24, 2018

This calibration certificate shall not be reproduced except in full without written approval of the laboratory.





Accredited by the Swiss Accreditation Service (SAS)  
The Swiss Accreditation Service is one of the signatories to the EA  
Multilateral Agreement for the recognition of calibration certificates

Accreditation No.: **SCS 0108**

**Glossary:**

TSL	tissue simulating liquid
ConvF	sensitivity in TSL / NORM x,y,z
N/A	not applicable or not measured

**Calibration is Performed According to the Following Standards:**

- a) IEEE Std 1528-2013, "IEEE Recommended Practice for Determining the Peak Spatial-Averaged Specific Absorption Rate (SAR) in the Human Head from Wireless Communications Devices: Measurement Techniques", June 2013
- b) IEC 62209-1, "Measurement procedure for the assessment of Specific Absorption Rate (SAR) from hand-held and body-mounted devices used next to the ear (frequency range of 300 MHz to 6 GHz)", July 2016
- c) IEC 62209-2, "Procedure to determine the Specific Absorption Rate (SAR) for wireless communication devices used in close proximity to the human body (frequency range of 30 MHz to 6 GHz)", March 2010
- d) KDB 865664, "SAR Measurement Requirements for 100 MHz to 6 GHz"

**Additional Documentation:**

- e) DASY4/5 System Handbook

**Methods Applied and Interpretation of Parameters:**

- *Measurement Conditions:* Further details are available from the Validation Report at the end of the certificate. All figures stated in the certificate are valid at the frequency indicated.
- *Antenna Parameters with TSL:* The dipole is mounted with the spacer to position its feed point exactly below the center marking of the flat phantom section, with the arms oriented parallel to the body axis.
- *Feed Point Impedance and Return Loss:* These parameters are measured with the dipole positioned under the liquid filled phantom. The impedance stated is transformed from the measurement at the SMA connector to the feed point. The Return Loss ensures low reflected power. No uncertainty required.
- *Electrical Delay:* One-way delay between the SMA connector and the antenna feed point. No uncertainty required.
- *SAR measured:* SAR measured at the stated antenna input power.
- *SAR normalized:* SAR as measured, normalized to an input power of 1 W at the antenna connector.
- *SAR for nominal TSL parameters:* The measured TSL parameters are used to calculate the nominal SAR result.

The reported uncertainty of measurement is stated as the standard uncertainty of measurement multiplied by the coverage factor  $k=2$ , which for a normal distribution corresponds to a coverage probability of approximately 95%.

## Measurement Conditions

DASY system configuration, as far as not given on page 1.

<b>DASY Version</b>	DASY5	V52.10.1
<b>Extrapolation</b>	Advanced Extrapolation	
<b>Phantom</b>	Modular Flat Phantom	
<b>Distance Dipole Center - TSL</b>	15 mm	with Spacer
<b>Zoom Scan Resolution</b>	dx, dy, dz = 5 mm	
<b>Frequency</b>	835 MHz $\pm$ 1 MHz	

## Head TSL parameters

The following parameters and calculations were applied.

	Temperature	Permittivity	Conductivity
<b>Nominal Head TSL parameters</b>	22.0 °C	41.5	0.90 mho/m
<b>Measured Head TSL parameters</b>	(22.0 $\pm$ 0.2) °C	40.7 $\pm$ 6 %	0.92 mho/m $\pm$ 6 %
<b>Head TSL temperature change during test</b>	< 0.5 °C	----	----

## SAR result with Head TSL

<b>SAR averaged over 1 cm<sup>3</sup> (1 g) of Head TSL</b>	Condition	
SAR measured	250 mW input power	2.42 W/kg
SAR for nominal Head TSL parameters	normalized to 1W	<b>9.48 W/kg <math>\pm</math> 17.0 % (k=2)</b>

<b>SAR averaged over 10 cm<sup>3</sup> (10 g) of Head TSL</b>	condition	
SAR measured	250 mW input power	1.55 W/kg
SAR for nominal Head TSL parameters	normalized to 1W	<b>6.10 W/kg <math>\pm</math> 16.5 % (k=2)</b>

## Body TSL parameters

The following parameters and calculations were applied.

	Temperature	Permittivity	Conductivity
<b>Nominal Body TSL parameters</b>	22.0 °C	55.2	0.97 mho/m
<b>Measured Body TSL parameters</b>	(22.0 $\pm$ 0.2) °C	54.9 $\pm$ 6 %	0.99 mho/m $\pm$ 6 %
<b>Body TSL temperature change during test</b>	< 0.5 °C	----	----

## SAR result with Body TSL

<b>SAR averaged over 1 cm<sup>3</sup> (1 g) of Body TSL</b>	Condition	
SAR measured	250 mW input power	2.46 W/kg
SAR for nominal Body TSL parameters	normalized to 1W	<b>9.68 W/kg <math>\pm</math> 17.0 % (k=2)</b>

<b>SAR averaged over 10 cm<sup>3</sup> (10 g) of Body TSL</b>	condition	
SAR measured	250 mW input power	1.61 W/kg
SAR for nominal Body TSL parameters	normalized to 1W	<b>6.36 W/kg <math>\pm</math> 16.5 % (k=2)</b>

## Appendix (Additional assessments outside the scope of SCS 0108)

### Antenna Parameters with Head TSL

Impedance, transformed to feed point	51.5 $\Omega$ - 2.2 j $\Omega$
Return Loss	- 31.6 dB

### Antenna Parameters with Body TSL

Impedance, transformed to feed point	47.9 $\Omega$ - 4.9 j $\Omega$
Return Loss	- 25.3 dB

### General Antenna Parameters and Design

Electrical Delay (one direction)	1.392 ns
----------------------------------	----------

After long term use with 100W radiated power, only a slight warming of the dipole near the feedpoint can be measured.

The dipole is made of standard semirigid coaxial cable. The center conductor of the feeding line is directly connected to the second arm of the dipole. The antenna is therefore short-circuited for DC-signals. On some of the dipoles, small end caps are added to the dipole arms in order to improve matching when loaded according to the position as explained in the "Measurement Conditions" paragraph. The SAR data are not affected by this change. The overall dipole length is still according to the Standard.

No excessive force must be applied to the dipole arms, because they might bend or the soldered connections near the feedpoint may be damaged.

### Additional EUT Data

Manufactured by	SPEAG
Manufactured on	March 27, 2012

# DASY5 Validation Report for Head TSL

Date: 22.08.2018

Test Laboratory: SPEAG, Zurich, Switzerland

**DUT: Dipole 835 MHz; Type: D835V2; Serial: D835V2 - SN:4d142**

Communication System: UID 0 - CW; Frequency: 835 MHz

Medium parameters used:  $f = 835 \text{ MHz}$ ;  $\sigma = 0.92 \text{ S/m}$ ;  $\epsilon_r = 40.7$ ;  $\rho = 1000 \text{ kg/m}^3$

Phantom section: Flat Section

Measurement Standard: DASY5 (IEEE/IEC/ANSI C63.19-2011)

DASY52 Configuration:

- Probe: EX3DV4 - SN7349; ConvF(9.9, 9.9, 9.9) @ 835 MHz; Calibrated: 30.12.2017
- Sensor-Surface: 1.4mm (Mechanical Surface Detection)
- Electronics: DAE4 Sn601; Calibrated: 26.10.2017
- Phantom: Flat Phantom 4.9 (front); Type: QD 00L P49 AA; Serial: 1001
- DASY52 52.10.1(1476); SEMCAD X 14.6.11(7439)

## Dipole Calibration for Head Tissue/Pin=250 mW, d=15mm/Zoom Scan (7x7x7)/Cube 0:

Measurement grid:  $dx=5\text{mm}$ ,  $dy=5\text{mm}$ ,  $dz=5\text{mm}$

Reference Value = 62.69 V/m; Power Drift = -0.01 dB

Peak SAR (extrapolated) = 3.71 W/kg

**SAR(1 g) = 2.42 W/kg; SAR(10 g) = 1.55 W/kg**

Maximum value of SAR (measured) = 3.26 W/kg

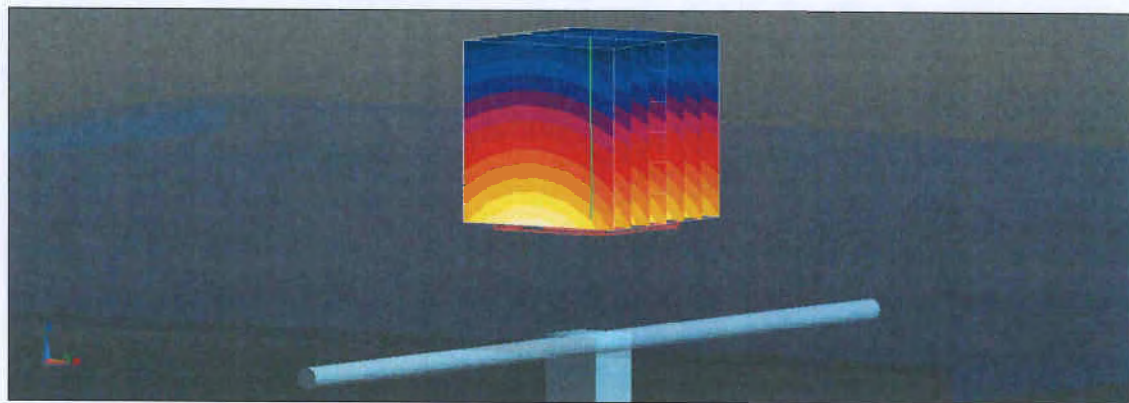
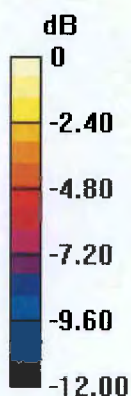

0 dB = 3.26 W/kg = 5.13 dBW/kg

# Impedance Measurement Plot for Head TSL

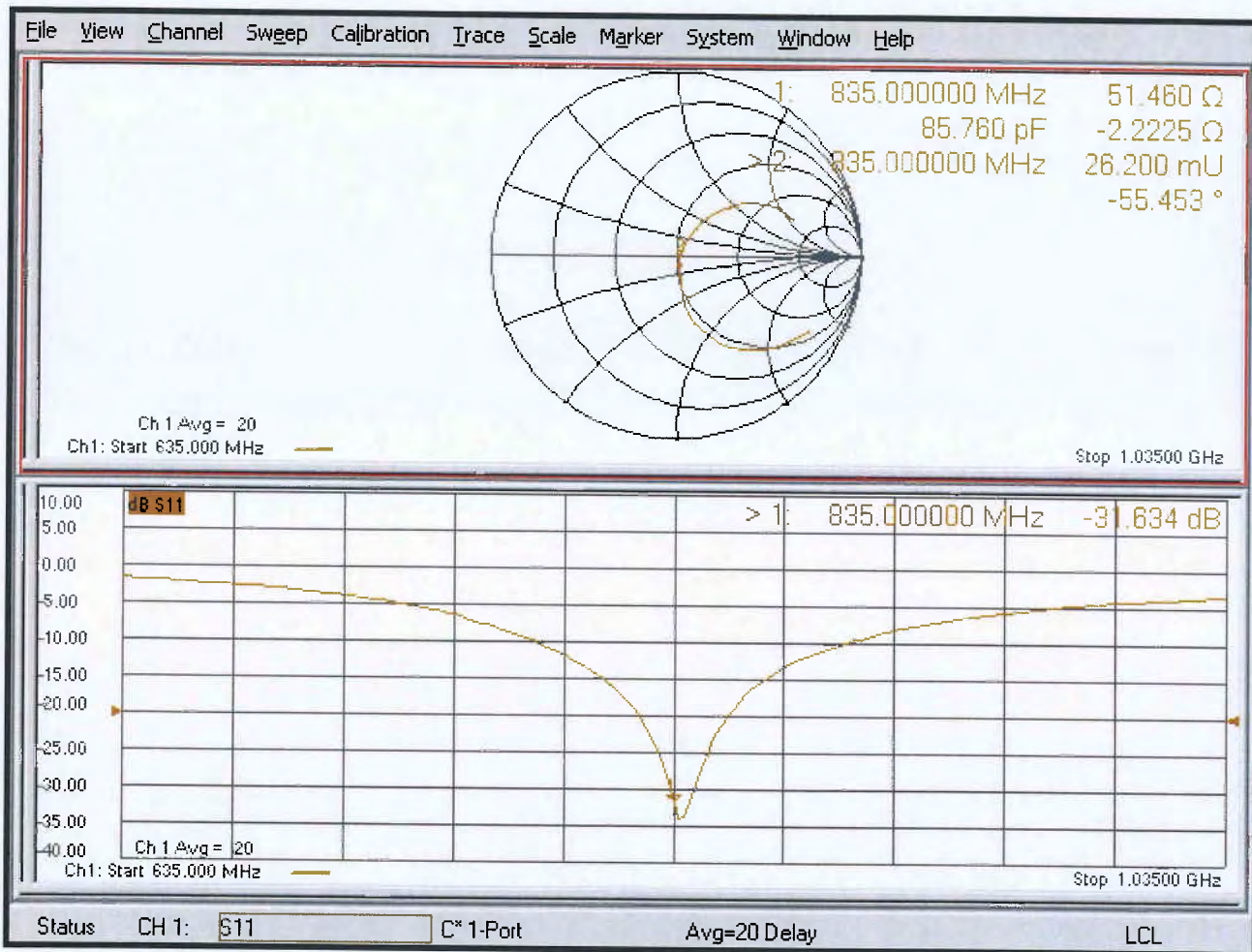

# DASY5 Validation Report for Body TSL

Date: 23.08.2018

Test Laboratory: SPEAG, Zurich, Switzerland

**DUT: Dipole 835 MHz; Type: D835V2; Serial: D835V2 - SN:4d142**

Communication System: UID 0 - CW; Frequency: 835 MHz

Medium parameters used:  $f = 835$  MHz;  $\sigma = 0.99$  S/m;  $\epsilon_r = 54.9$ ;  $\rho = 1000$  kg/m<sup>3</sup>

Phantom section: Flat Section

Measurement Standard: DASY5 (IEEE/IEC/ANSI C63.19-2011)

DASY52 Configuration:

- Probe: EX3DV4 - SN7349; ConvF(10.05, 10.05, 10.05) @ 835 MHz; Calibrated: 30.12.2017
- Sensor-Surface: 1.4mm (Mechanical Surface Detection)
- Electronics: DAE4 Sn601; Calibrated: 26.10.2017
- Phantom: Flat Phantom 4.9 (Back); Type: QD 00R P49 AA; Serial: 1005
- DASY52 52.10.1(1476); SEMCAD X 14.6.11(7439)

## Dipole Calibration for Body Tissue/Pin=250 mW, d=15mm/Zoom Scan (7x7x7)/Cube 0:

Measurement grid: dx=5mm, dy=5mm, dz=5mm

Reference Value = 61.04 V/m; Power Drift = -0.01 dB

Peak SAR (extrapolated) = 3.64 W/kg

**SAR(1 g) = 2.46 W/kg; SAR(10 g) = 1.61 W/kg**

Maximum value of SAR (measured) = 3.26 W/kg

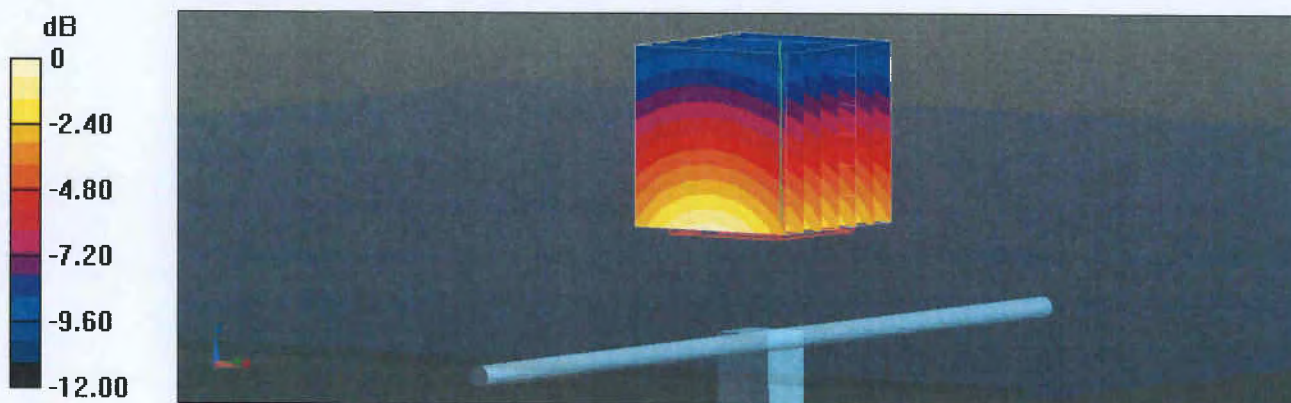

0 dB = 3.26 W/kg = 5.13 dBW/kg

# Impedance Measurement Plot for Body TSL

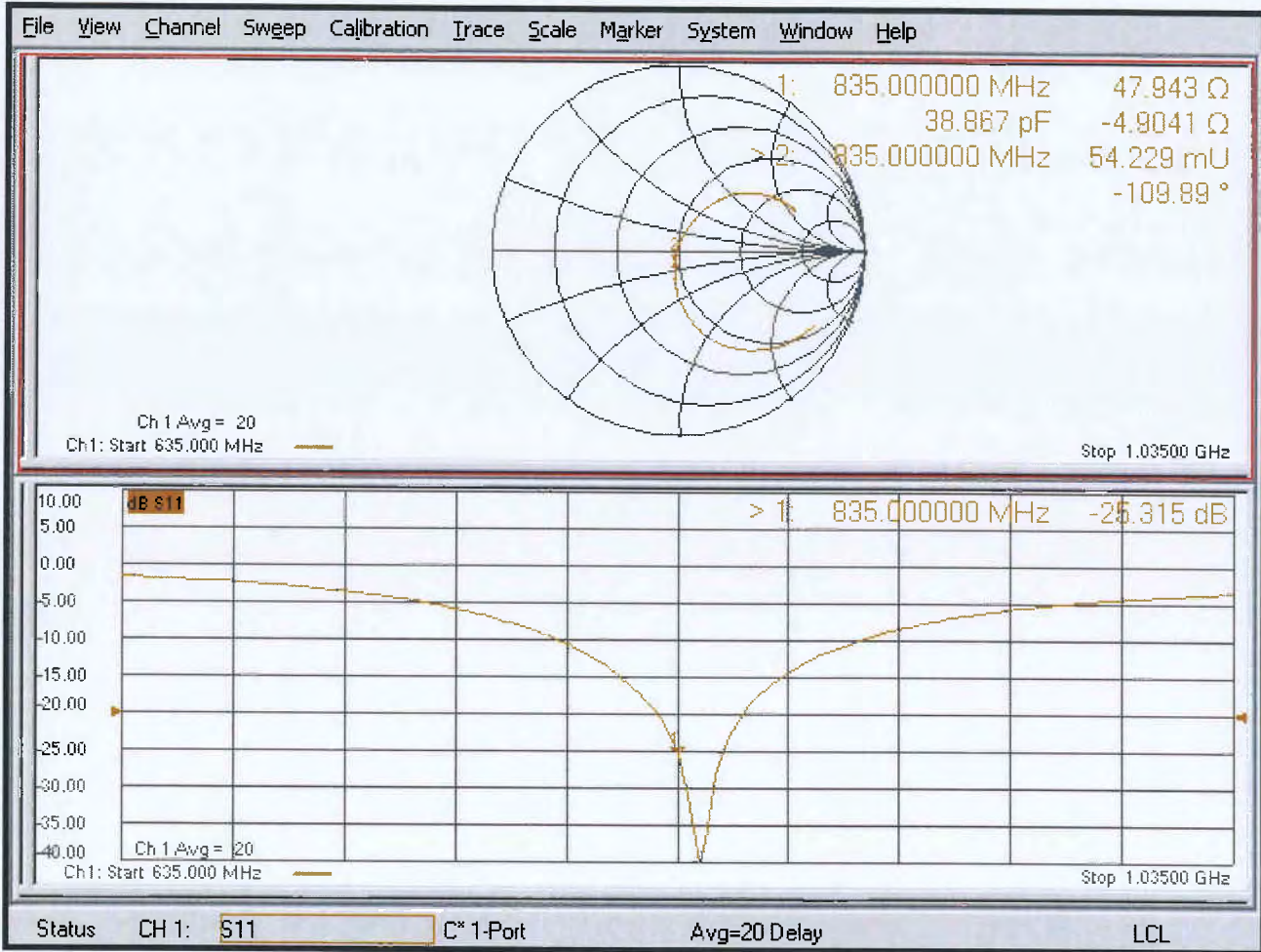

## Appendix (Additional assessments outside the scope of SCS 0108)

### Evaluation Condition

Phantom	SAM Head Phantom	For usage with cSAR3DV2-R/L
---------	------------------	-----------------------------

### SAR result with SAM Head (Top)

SAR averaged over 1 cm <sup>3</sup> (1 g) of Head TSL	Condition	
SAR (average measured)	250 mW input power	2.34 W/kg
SAR for nominal Head TSL parameters	normalized to 1W	<b>9.05 W/kg ± 17.5 % (k=2)</b>

SAR averaged over 10 cm <sup>3</sup> (10 g) of Head TSL	condition	
SAR measured	250 mW input power	1.53 W/kg
SAR for nominal Head TSL parameters	normalized to 1W	<b>5.97 W/kg ± 16.9 % (k=2)</b>

### SAR result with SAM Head (Mouth)

SAR averaged over 1 cm <sup>3</sup> (1 g) of Head TSL	Condition	
SAR (average measured)	250 mW input power	2.45 W/kg
SAR for nominal Head TSL parameters	normalized to 1W	<b>9.50 W/kg ± 17.5 % (k=2)</b>

SAR averaged over 10 cm <sup>3</sup> (10 g) of Head TSL	condition	
SAR (average measured)	250 mW input power	1.63 W/kg
SAR for nominal Head TSL parameters	normalized to 1W	<b>6.36 W/kg ± 16.9 % (k=2)</b>

### SAR result with SAM Head (Neck)

SAR averaged over 1 cm <sup>3</sup> (1 g) of Head TSL	Condition	
SAR (average measured)	250 mW input power	2.32 W/kg
SAR for nominal Head TSL parameters	normalized to 1W	<b>9.03 W/kg ± 17.5 % (k=2)</b>

SAR averaged over 10 cm <sup>3</sup> (10 g) of Head TSL	condition	
SAR (average measured)	250 mW input power	1.55 W/kg
SAR for nominal Head TSL parameters	normalized to 1W	<b>6.08 W/kg ± 16.9 % (k=2)</b>

### SAR result with SAM Head (Ear)

SAR averaged over 1 cm <sup>3</sup> (1 g) of Head TSL	Condition	
SAR (average measured)	250 mW input power	1.99 W/kg
SAR for nominal Head TSL parameters	normalized to 1W	<b>7.73 W/kg ± 17.5 % (k=2)</b>

SAR averaged over 10 cm <sup>3</sup> (10 g) of Head TSL	condition	
SAR (average measured)	250 mW input power	1.33 W/kg
SAR for nominal Head TSL parameters	normalized to 1W	<b>5.18 W/kg ± 16.9 % (k=2)</b>



# CERTIFICATE OF CALIBRATION

ISSUED BY **UL VS LTD**

DATE OF ISSUE: 28/Nov/2018      CERTIFICATE NUMBER : 12134289JD01B



**5248**

UL VS LTD  
UNIT 1 HORIZON  
KINGSLAND PARK, WADE ROAD  
BASINGSTOKE, HAMPSHIRE  
RG24 8AH, UK  
TEL: +44 (0) 1256 312000  
FAX: +44 (0) 1256 312001  
Email: LST.UK.Calibration@ul.com



Page 1 of 10

**APPROVED SIGNATORY**

.....  
Naseer Mirza

**Customer :**

UL VS Inc  
47173 Benicia Street  
Fremont, CA 94538, USA

**Equipment Details:**

Description:	Dipole Validation Kit	Date of Receipt:	20/Nov/2017
Manufacturer:	Speag		
Type/Model Number:	D835V2		
Serial Number:	4d002		
Calibration Date:	28/Nov/2018		
Calibrated By:	Chanthu Thevarajah Senior Engineer		

Signature:

.....

All Calibration have been conducted in the closed laboratory facility: Lab Temperature (22±3) °C and humidity < 70%

This certificate is issued in accordance with the laboratory accreditation requirements of the United Kingdom Accreditation Service. It provides traceability of measurement to the SI system of units and/or to units of measurement recognised at the National Physical Laboratory or other recognised national metrology institutes. This certificate may not be reproduced other than in full, except with the prior written approval of the issuing laboratory.

Use of the UKAS mark demonstrates that compliance with the requirements of BS/EN/ISO/IEC 17025 has been independently assessed.

# CERTIFICATE OF CALIBRATION

## ISSUED BY UL VS LTD

UKAS Accredited Calibration Laboratory No. 5248

CERTIFICATE  
NUMBER :  
12134289JD01B

Page 2 of 10

The calibration methods and procedures used were as detailed in:

1. **IEC 62209-1:2016:** Procedure to determine the specific absorption rate (SAR) for hand-held devices used in close proximity to the ear (frequency range of 300 MHz to 3 GHz)
2. **IEC 62209-2:2010:** Procedure to determine the specific absorption rate (SAR) for wireless communication devices used in close proximity to the human body (frequency range of 30 MHz to 6 GHz)
3. **IEEE 1528: 2013:** IEEE Recommended Practice for Determining the Peak Spatial-Average Specific Absorption Rate (SAR) in the Human Head from Wireless Communication Devices: Measurement Techniques
4. FCC KDB Publication Number: “**KDB865664 D01 SAR Measurement 100 MHz to 6 GHz**”
5. **SPEAG DASY4/ DASY5 System Handbook**

The measuring equipment used to perform the calibration, documented in this certificate has been calibrated in accordance with the manufacturers' recommendations, and is traceable to recognized national standards.

UL No.	Instrument	Manufacturer	Type No.	Serial No.	Date Last Calibrated	Cal. Interval (Months)
PRE0178318	Data Acquisition Electronics	SPEAG	DAE4	1543	08 Mar 2018	12
PRE0178315	Probe	SPEAG	ES3DV3	3360	17 Aug 2018	12
A2588	Dipole	SPEAG	D900V2	1d168	18 Sep 2018	12
PRE0151451	Power Monitoring Kit	Art-Fi	ART 100850-01	0001	Cal as part of System	12
PRE0151441	Power Sensor	Rhode & Schwarz	NRP8S	102481	05 Feb 2018	12
PRE0151154	Network Analyser	Rhode & Schwarz	ZND8	100151	14 Dec 2017	12
PRE0151877	Calibration Kit	Rhode & Schwarz	ZV-Z135	102947-Bt	27 Apr 2018	12
PRE0178154	Signal Generator	Rhode & Schwarz	SMB 100A	175325	09 Apr 2018	12

# CERTIFICATE OF CALIBRATION

## ISSUED BY **UL VS LTD**

UKAS Accredited Calibration Laboratory No. 5248

CERTIFICATE  
NUMBER :  
12134289JD01B

Page 3 of 10

### SAR System Specification

<b>Robot System Positioner:</b>	Stäubli Unimation Corp. Robot Model: TX60L
<b>Robot Serial Number:</b>	F17/5ENYG1/A/01
<b>DASY Version:</b>	DASY 52 (v52.8.8.1258)
<b>Phantom:</b>	Flat section of SAM Twin Phantom
<b>Distance Dipole Centre:</b>	15 mm (with spacer)
<b>Frequency:</b>	835 MHz

### Dielectric Property Measurements – Head Simulating Liquid (HSL)

Simulant Liquid	Frequency (MHz)	Room Temp		Liquid Temp		Parameters	Target Value	Measured Value	Uncertainty (%)
		Start	End	Start	End				
Head	835	20.0 °C	20.0 °C	20.5°C	20.0°C	$\epsilon_r$	41.50	41.57	± 5%
						$\sigma$	0.90	0.93	± 5%

### SAR Results – Head Simulating Liquid (HSL)

Simulant Liquid	SAR Measured	250 mW input Power	Normalised to 1.00 W	Uncertainty (%)
Head	SAR averaged over 1g	2.48 W/Kg	<b>9.87 W/Kg</b>	± 17.57%
	SAR averaged over 10g	1.60 W/Kg	<b>6.36 W/Kg</b>	± 17.32%

### Antenna Parameters – Head Simulating Liquid (HSL)

Simulant Liquid	Parameter	Measured Level	Uncertainty (%)
Head	Impedance	47.85 $\Omega$ 0.47 j $\Omega$	± 0.28 $\Omega$ ± 0.044 j $\Omega$
	Return Loss	-31.95	± 2.03 dB

# CERTIFICATE OF CALIBRATION

## ISSUED BY UL VS LTD

UKAS Accredited Calibration Laboratory No. 5248

CERTIFICATE  
NUMBER :  
12134289JD01B

Page 4 of 10

### Dielectric Property Measurements – Body Simulating Liquid (MSL)

Simulant Liquid	Frequency (MHz)	Room Temp		Liquid Temp		Parameters	Target Value	Measured Value	Uncertainty (%)
		Start	End	Start	End				
Body	835	20.0 °C	20.0 °C	19.3°C	20.0°C	$\epsilon_r$	55.20	54.10	± 5%
						$\sigma$	0.97	0.99	± 5%

### SAR Results – Body Simulating Liquid (MSL)

Simulant Liquid	SAR Measured	250 mW input Power	Normalised to 1.00 W	Uncertainty (%)
Body	SAR averaged over 1g	2.53 W/Kg	<b>10.07 W/Kg</b>	± 18.06%
	SAR averaged over 10g	1.65 W/Kg	<b>6.56 W/Kg</b>	± 17.44%

### Antenna Parameters – Body Simulating Liquid (MSL)

Simulant Liquid	Parameter	Measured Level	Uncertainty (%)
Body	Impedance	46.49 $\Omega$ 5.59 j $\Omega$	± 0.28 $\Omega$ ± 0.044 j $\Omega$
	Return Loss	-23.73	± 2.03 dB

# CERTIFICATE OF CALIBRATION

## ISSUED BY UL VS LTD

CERTIFICATE  
NUMBER :  
12134289JD01B

UKAS Accredited Calibration Laboratory No. 5248

Page 5 of 10

### DASY Validation Scan for Head Stimulating Liquid (HSL)

DUT: D835V2 - SN4d002; Type: D835V2; Serial: SN4d002

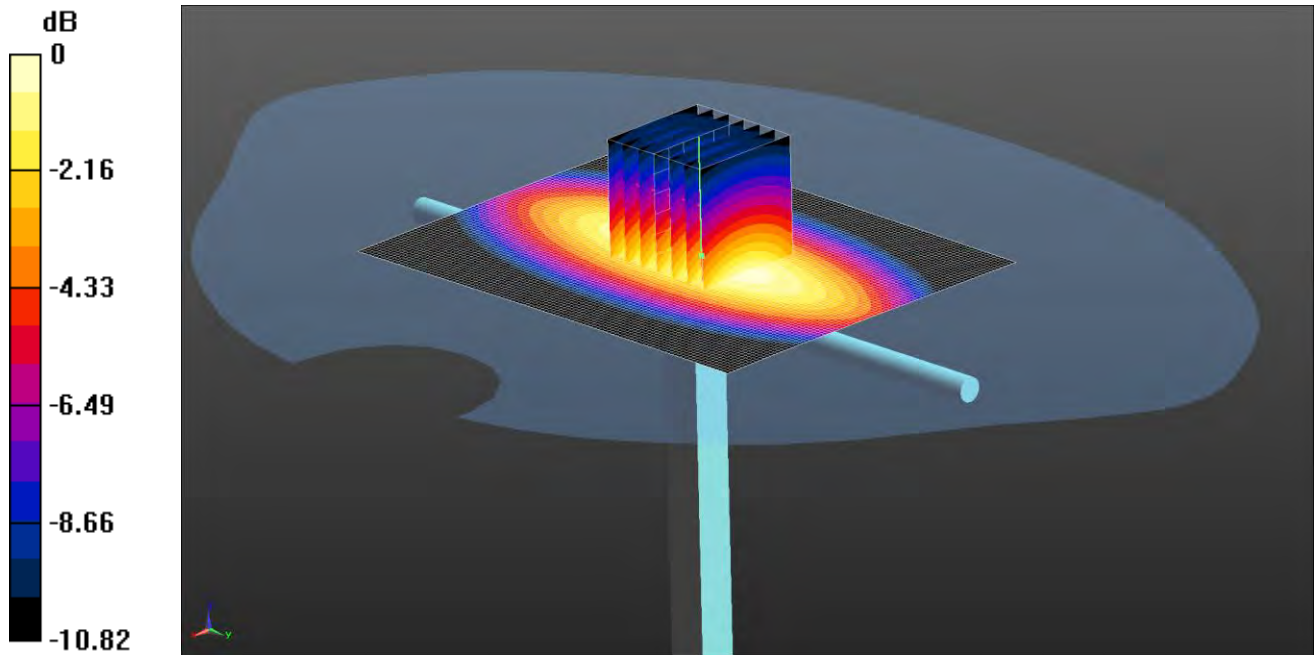

0 dB = 2.91 W/kg = 4.64 dBW/kg

Communication System: UID 0, CW (0); Frequency: 835 MHz; Duty Cycle: 1:1  
Medium: 750 835 900 1800 1900 MHz HSL Medium parameters used (interpolated):  $f = 835$  MHz;  $\sigma = 0.931$  S/m;  $\epsilon_r = 41.573$ ;  
 $\rho = 1000$  kg/m<sup>3</sup>

Phantom section: Flat Section

DASY4 Configuration:

- Probe: ES3DV3 - SN3360; ConvF(6.23, 6.23, 6.23); Calibrated: 17/08/2018;
- Sensor-Surface: 3mm (Mechanical Surface Detection)
- Electronics: DAE4 Sn1543; Calibrated: 08/03/2018
- Phantom: Twin SAM A (Site 65); Type: SAM 8.0; Serial: TP:1945
- ; SEMCAD X Version 14.6.10 (7417)

**Configuration/d=10mm, Pin=250mW 2/Area Scan (81x101x1):** Interpolated grid: dx=1.200 mm, dy=1.200 mm

Maximum value of SAR (interpolated) = 2.90 W/kg

**Configuration/d=10mm, Pin=250mW 2/Zoom Scan 2 (7x7x7)/Cube 0:** Measurement grid: dx=5mm, dy=5mm, dz=5mm

Reference Value = 57.40 V/m; Power Drift = -0.04 dB

Peak SAR (extrapolated) = 3.75 W/kg

**SAR(1 g) = 2.48 W/kg; SAR(10 g) = 1.6 W/kg**

Maximum value of SAR (measured) = 2.91 W/kg

# CERTIFICATE OF CALIBRATION ISSUED BY UL VS LTD

CERTIFICATE  
NUMBER :  
12134289JD01B

UKAS Accredited Calibration Laboratory No. 5248

Page 6 of 10

## Impedance Measurement Plot for Head Stimulating Liquid (HSL)

11/23/2018 10:38:03 AM  
1328.5170K92-100151-MV

Trc1 — S11 Smith 200 mU/ Ref 1 U Cal

1

• M1 835.000000 MHz 47.850  $\Omega$   
j473.047 m $\Omega$   
90.165 pH

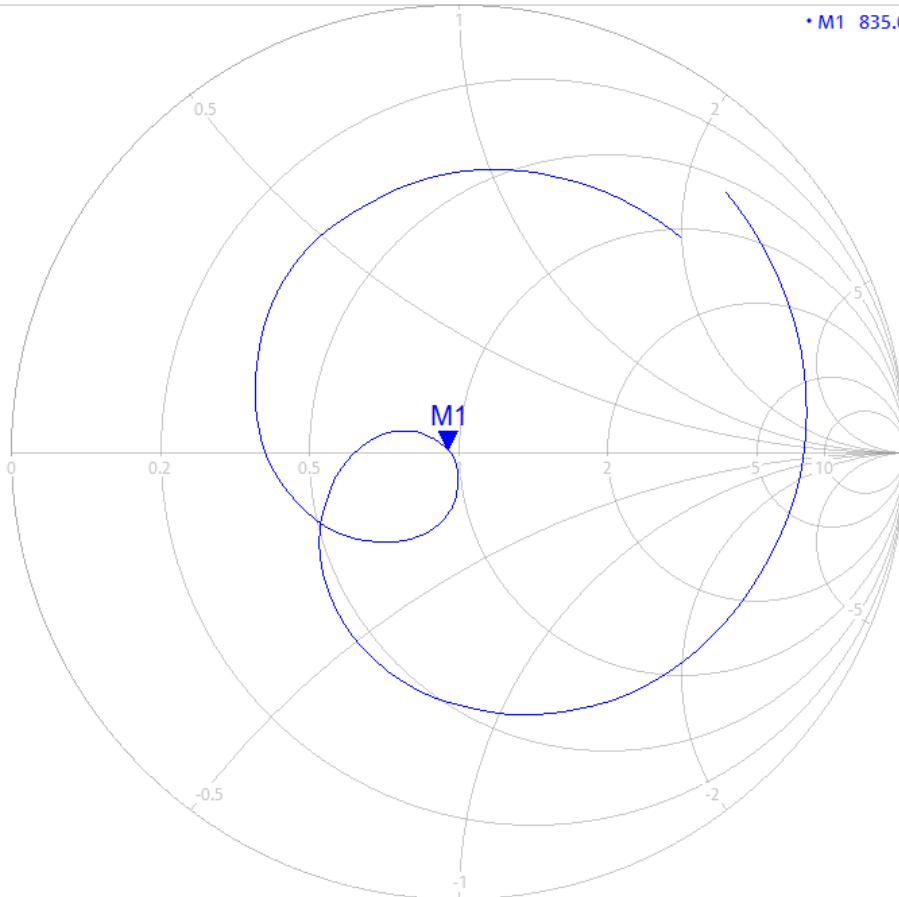

Ch1 Center 835 MHz

Pwr -10 dBm Bw 10 kHz

Span 400 MHz

# CERTIFICATE OF CALIBRATION ISSUED BY UL VS LTD

UKAS Accredited Calibration Laboratory No. 5248

CERTIFICATE  
NUMBER :  
12134289JD01B

Page 7 of 10

## Return Loss Measurement Plot for Head Stimulating Liquid (HSL)

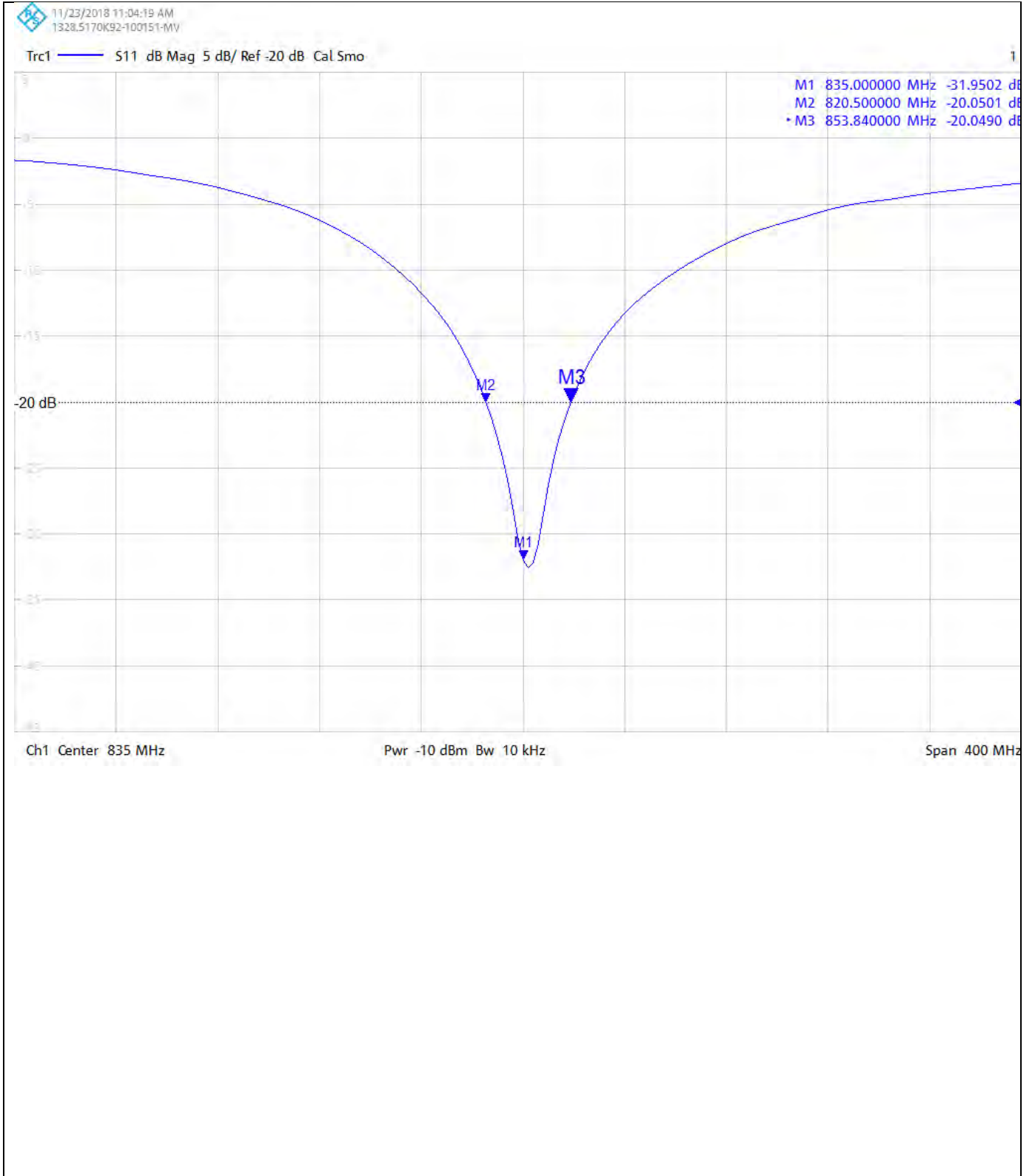

# CERTIFICATE OF CALIBRATION

## ISSUED BY UL VS LTD

CERTIFICATE  
NUMBER :  
12134289JD01B

UKAS Accredited Calibration Laboratory No. 5248

Page 8 of 10

### DASY Validation Scan for Body Stimulating Liquid (MSL)

DUT: D835V2 - SN4d002; Type: D900V2; Serial: SN4d002

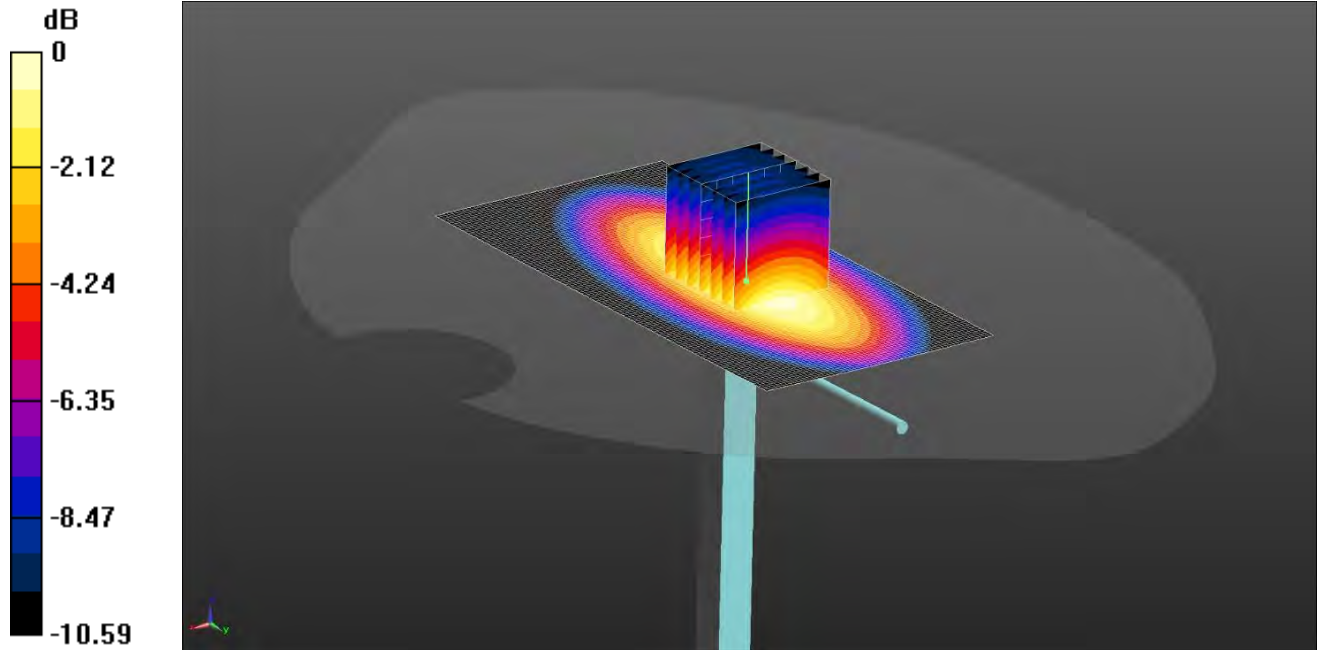

0 dB = 2.97 W/kg = 4.73 dBW/kg

Communication System: UID 0, CW (0); Frequency: 835 MHz; Duty Cycle: 1:1

Medium: 750,835,900,1800 5%MHz MSL Medium parameters used (interpolated):  $f = 835$  MHz;  $\sigma = 0.992$  S/m;  $\epsilon_r = 54.099$ ;  $\rho = 1000$  kg/m<sup>3</sup>

Phantom section: Flat Section

DASY4 Configuration:

- Probe: ES3DV3 - SN3360; ConvF(6.31, 6.31, 6.31); Calibrated: 17/08/2018;
- Sensor-Surface: 3mm (Mechanical Surface Detection)
- Electronics: DAE4 Sn1543; Calibrated: 08/03/2018
- Phantom: Twin SAM B (Site 65); Type: SAM 5.0; Serial: TP:1836
- ; SEMCAD X Version 14.6.10 (7417)

**SAR/d=10mm, Pin=50 mW/Area Scan (61x121x1):** Interpolated grid: dx=1.200 mm, dy=1.200 mm

Maximum value of SAR (interpolated) = 2.96 W/kg

**SAR/d=10mm, Pin=50 mW/Zoom Scan 2 2 (7x7x7)/Cube 0:** Measurement grid: dx=5mm, dy=5mm, dz=5mm

Reference Value = 56.17 V/m; Power Drift = -0.00 dB

Peak SAR (extrapolated) = 3.82 W/kg

**SAR(1 g) = 2.53 W/kg; SAR(10 g) = 1.65 W/kg**

Maximum value of SAR (measured) = 2.97 W/kg



# CERTIFICATE OF CALIBRATION

## ISSUED BY UL VS LTD

CERTIFICATE  
NUMBER :  
12134289JD01B

UKAS Accredited Calibration Laboratory No. 5248

Page 9 of 10

### Impedance Measurement Plot for Body Stimulating Liquid (MSL)

11/23/2018 3:30:40 PM  
1328.5170K92-100151-MV

Trc1 — S11 Smith 200 mU/ Ref 1 U Cal Smo

1

• M1 835.000000 MHz 46.486  $\Omega$   
j5.588  $\Omega$   
1.065 nH

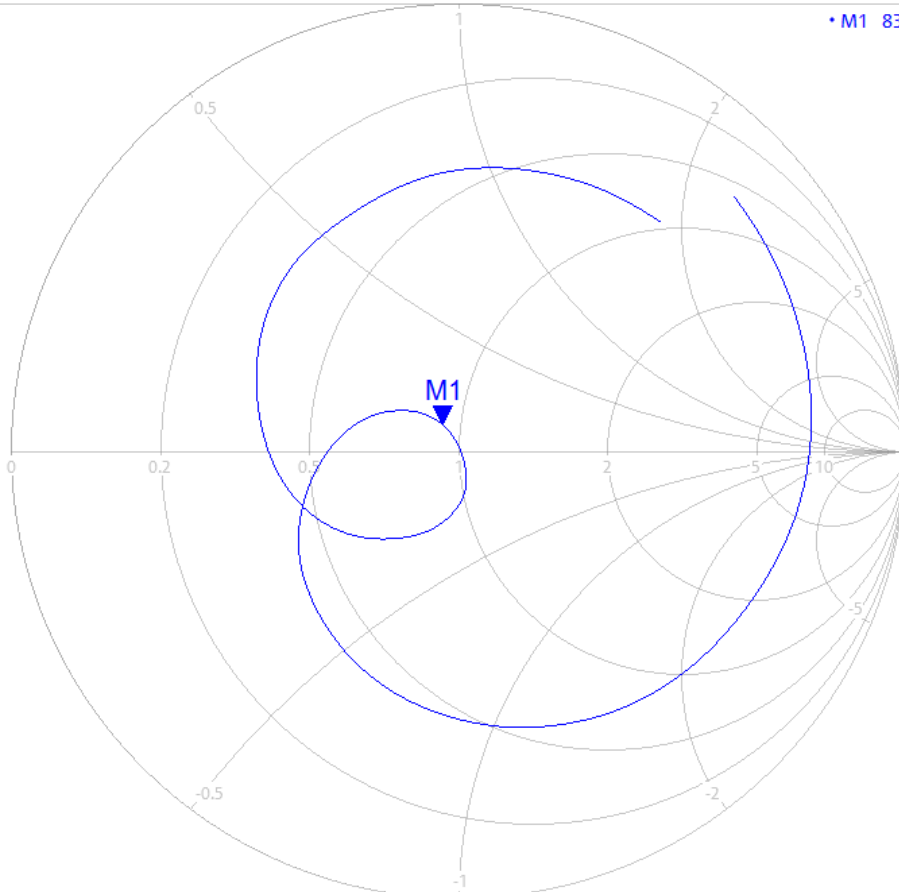

Ch1 Center 835 MHz

Pwr -10 dBm Bw 10 kHz

Span 400 MHz

# CERTIFICATE OF CALIBRATION

## ISSUED BY UL VS LTD

UKAS Accredited Calibration Laboratory No. 5248

CERTIFICATE  
NUMBER :  
12134289JD01B

Page 10 of 10

### Return Loss Measurement Plot for Body Stimulating Liquid (MSL)

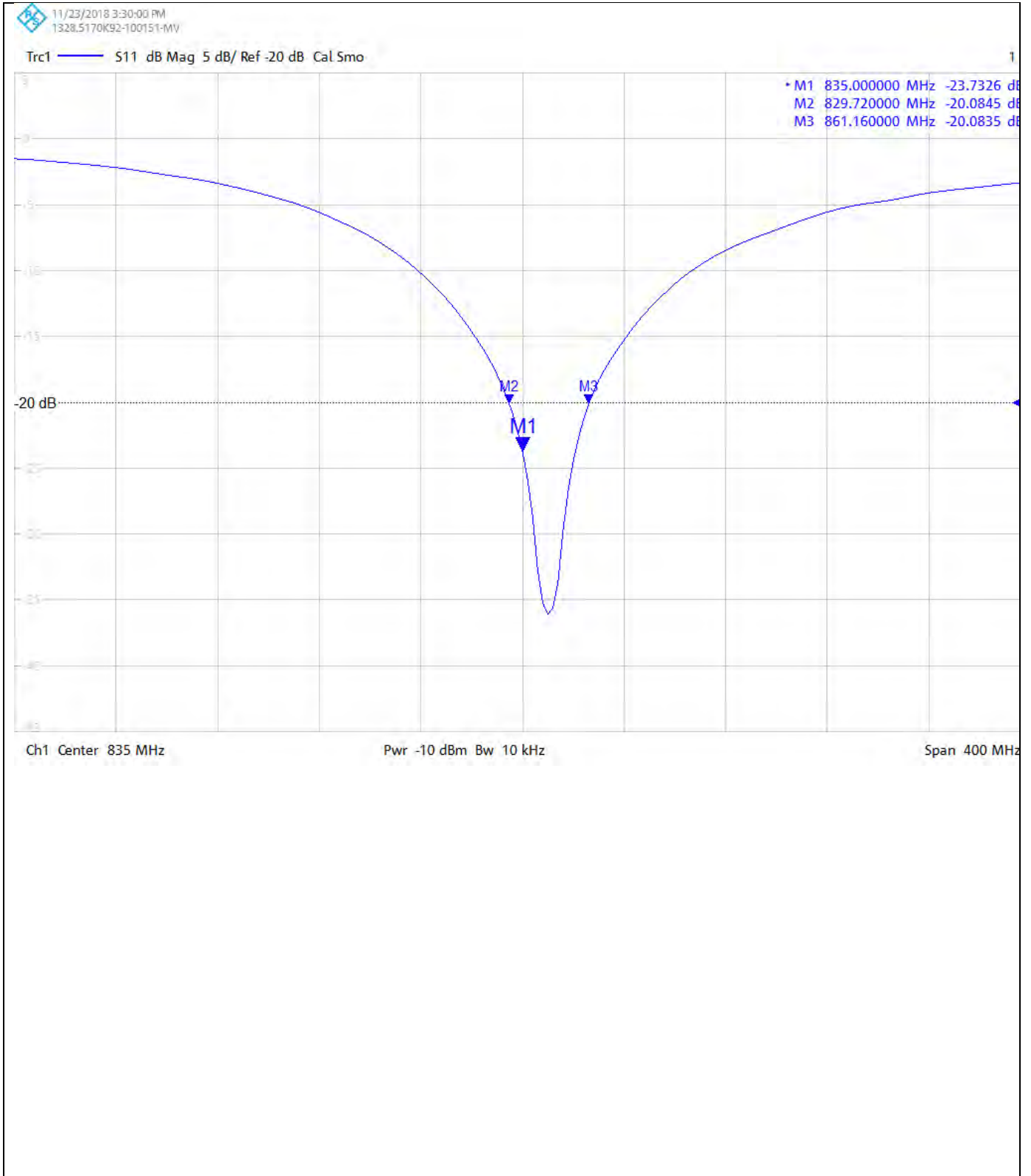

**Calibration Certificate Label:**

	<p><b>UL VS LTD - Tel: +44 (0) 1256312000</b></p> <p>Certificate Number: 12134289JD01B</p> <p>Instrument ID: 4d002</p> <p>Calibration Date: 28/Nov/2018</p> <p>Calibration Due Date:</p>
---	--

	<p><b>UL VS LTD - Tel: +44 (0) 1256312000</b></p> <p>Certificate Number: 12134289JD01B</p> <p>Instrument ID: 4d002</p> <p>Calibration Date: 28/Nov/2018</p> <p>Calibration Due Date:</p>
---	--

	<p><b>UL VS LTD - Tel: +44 (0) 1256312000</b></p> <p>Certificate Number: 12134289JD01B</p> <p>Instrument ID: 4d002</p> <p>Calibration Date: 28/Nov/2018</p> <p>Calibration Due Date:</p>
---	--

# CERTIFICATE OF CALIBRATION

ISSUED BY **UL VS LTD**

DATE OF ISSUE: 08/Jun/2018

CERTIFICATE NUMBER : 12134282JD01B



5248

UL VS LTD  
UNIT 1 HORIZON  
KINGSLAND PARK, WADE ROAD  
BASINGSTOKE, HAMPSHIRE  
RG24 8AH, UK  
TEL: +44 (0) 1256 312000  
FAX: +44 (0) 1256 312001  
Email: LST.UK.Calibration@ul.com



Page 1 of 10

**APPROVED SIGNATORY**

A handwritten signature in black ink, appearing to read 'M. Naseer'.

.....  
Naseer Mirza

## Customer :

UL VS Inc  
47173 Benicia Street  
Fremont, CA 94538, USA

## Equipment Details:

Description:	Dipole Validation Kit	Date of Receipt:	14/May/2018
Manufacturer:	Speag		
Type/Model Number:	D835V2		
Serial Number:	4d117		
Calibration Date:	16/May/2018		
Calibrated By:	Chanthu Thevarajah Senior Engineer		

Signature:

A handwritten signature in black ink, appearing to be a stylized 'C' followed by 'T'.

.....

All Calibration have been conducted in the closed laboratory facility: Lab Temperature (22±3) °C and humidity < 70%

This certificate is issued in accordance with the laboratory accreditation requirements of the United Kingdom Accreditation Service. It provides traceability of measurement to the SI system of units and/or to units of measurement realised at the National Physical Laboratory or other recognised national metrology institutes. This certificate may not be reproduced other than in full, except with the prior written approval of the issuing laboratory.

Use of the UKAS mark demonstrates that compliance with the requirements of BS/EN/ISO/IEC 17025 has been independently assessed.

# CERTIFICATE OF CALIBRATION

## ISSUED BY UL VS LTD

UKAS Accredited Calibration Laboratory No. 5248

CERTIFICATE  
NUMBER :  
12134282JD01B

Page 2 of 10

The calibration methods and procedures used were as detailed in:

1. **IEC 62209-1:2016:** Procedure to determine the specific absorption rate (SAR) for hand-held devices used in close proximity to the ear (frequency range of 300 MHz to 3 GHz)
2. **IEC 62209-2:2010:** Procedure to determine the specific absorption rate (SAR) for wireless communication devices used in close proximity to the human body (frequency range of 30 MHz to 6 GHz)
3. **IEEE 1528: 2013:** IEEE Recommended Practice for Determining the Peak Spatial-Average Specific Absorption Rate (SAR) in the Human Head from Wireless Communication Devices: Measurement Techniques
4. FCC KDB Publication Number: **“KDB865664 D01 SAR Measurement 100 MHz to 6 GHz”**
5. **SPEAG DASY4/ DASY5 System Handbook**

The measuring equipment used to perform the calibration, documented in this certificate has been calibrated in accordance with the manufacturers' recommendations, and is traceable to recognized national standards.

UL No.	Instrument	Manufacturer	Type No.	Serial No.	Date Last Calibrated	Cal. Interval (Months)
PRE0178316	Data Acquisition Electronics	SPEAG	DAE4	1542	06 Mar 2018	12
A2544	Probe	SPEAG	EX3DV4	3994	19 Mar 2018	12
A2545	Probe	SPEAG	EX3DV4	3995	24 Apr 2018	12
A2115	Dipole	SPEAG	D835V2	438	28 Apr 2018	12
PRE0151451	Power Monitoring Kit	Art-Fi	ART 100850-01	0001	Cal as part of System	12
M1855	Power Sensor	Rhode & Schwarz	NRP-Z51	103246	08 Nov 2017	12
M1015	Network Analyser	Agilent Technologies	8753ES	US39172406	10 Oct 2017	12
PRE0151154	Network Analyser	Rhode & Schwarz	ZND8	100151	14 Dec 2017	12
PRE0151877	Calibration Kit	Rhode & Schwarz	Z135	102947	27 April 2018	12
M1838	Signal Generator	Rhode & Schwarz	SME06	831377/005	22 Mar 2018	12

# CERTIFICATE OF CALIBRATION

## ISSUED BY UL VS LTD

UKAS Accredited Calibration Laboratory No. 5248

CERTIFICATE  
NUMBER :  
12134282JD01B

Page 3 of 10

### SAR System Specification

<b>Robot System Positioner:</b>	Stäubli Unimation Corp. Robot Model: TX60L
<b>Robot Serial Number:</b>	F17/5ENYG1/C/01
<b>DASY Version:</b>	DASY 52 (v52.8.8.1258)
<b>Phantom:</b>	Flat section of SAM Twin Phantom
<b>Distance Dipole Centre:</b>	15 mm (with spacer)
<b>Frequency:</b>	835 MHz

### Dielectric Property Measurements – Head Simulating Liquid (HSL)

Simulant Liquid	Frequency (MHz)	Room Temp		Liquid Temp		Parameters	Target Value	Measured Value	Uncertainty (%)
		Start	End	Start	End				
Head	835	21.4 °C	21.0 °C	20.9°C	21.0°C	$\epsilon_r$	41.50	39.89	± 5%
						$\sigma$	0.90	0.94	± 5%

### SAR Results – Head Simulating Liquid (HSL)

Simulant Liquid	SAR Measured	250 mW input Power	Normalised to 1.00 W	Uncertainty (%)
Head	SAR averaged over 1g	2.48 W/Kg	<b>9.87 W/Kg</b>	± 17.57%
	SAR averaged over 10g	1.61 W/Kg	<b>6.40 W/Kg</b>	± 17.32%

### Antenna Parameters – Head Simulating Liquid (HSL)

Simulant Liquid	Parameter	Measured Level	Uncertainty (%)
Head	Impedance	46.016 $\Omega$ .98 j $\Omega$	± 0.28 $\Omega$ ± 0.044 j $\Omega$
	Return Loss	27.61	± 2.03 dB

# CERTIFICATE OF CALIBRATION

## ISSUED BY UL VS LTD

UKAS Accredited Calibration Laboratory No. 5248

CERTIFICATE  
NUMBER :  
12134282JD01B

Page 4 of 10

### Dielectric Property Measurements – Body Simulating Liquid (MSL)

Simulant Liquid	Frequency (MHz)	Room Temp		Liquid Temp		Parameters	Target Value	Measured Value	Uncertainty (%)
		Start	End	Start	End				
Body	835	22.0 °C	21.0 °C	21.2°C	21.0°C	$\epsilon_r$	55.20	55.65	± 5%
						$\sigma$	0.97	0.98	± 5%

### SAR Results – Body Simulating Liquid (MSL)

Simulant Liquid	SAR Measured	250 mW input Power	Normalised to 1.00 W	Uncertainty (%)
Body	SAR averaged over 1g	2.59 W/Kg	<b>10.31 W/Kg</b>	± 18.06%
	SAR averaged over 10g	1.72 W/Kg	<b>6.84 W/Kg</b>	± 17.44%

### Antenna Parameters – Body Simulating Liquid (MSL)

Simulant Liquid	Parameter	Measured Level	Uncertainty (%)
Body	Impedance	45.10 $\Omega$ 5.69 j $\Omega$	± 0.28 $\Omega$ ± 0.044 j $\Omega$
	Return Loss	23.07	± 2.03 dB

# CERTIFICATE OF CALIBRATION

## ISSUED BY UL VS LTD

UKAS Accredited Calibration Laboratory No. 5248

CERTIFICATE  
NUMBER :  
12134282JD01B

Page 5 of 10

### DASY Validation Scan for Head Stimulating Liquid (HSL)

DUT: D835V2 - SN4d117; Type: D835V2; Serial: SN4d117

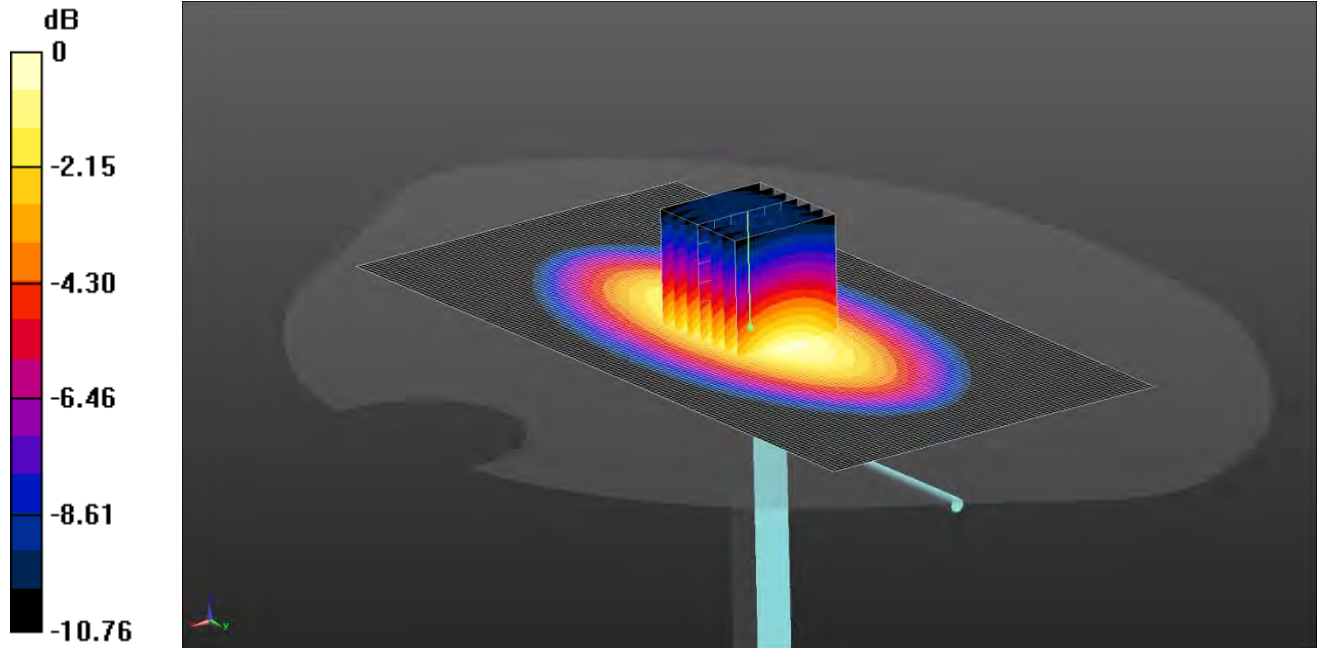

0 dB = 2.92 W/kg = 4.65 dBW/kg

Communication System: UID 0, CW (0); Frequency: 835 MHz; Duty Cycle: 1:1

Medium: 750 835 900 MHz HSL Medium parameters used (interpolated):  $f = 835$  MHz;  $\sigma = 0.941$  S/m;  $\epsilon_r = 39.893$ ;  $\rho = 1000$  kg/m<sup>3</sup>

Phantom section: Flat Section

DASY4 Configuration:

- Probe: EX3DV4 - SN3994; ConvF(10.05, 10.05, 10.05); Calibrated: 19/03/2018;

- Sensor-Surface: 3mm (Mechanical Surface Detection)

- Electronics: DAE4 Sn1542; Calibrated: 06/03/2018

- Phantom: Twin-SAM V8.0 (20deg probe tilt); Type: QD 000 P41 Ax; Serial: xxxx

- ; SEMCAD X Version 14.6.10 (7417)

**Configuration/d=15mm, Pin=250mW/Area Scan (81x161x1):** Interpolated grid: dx=1.200 mm, dy=1.200 mm

Maximum value of SAR (interpolated) = 2.91 W/kg

**Configuration/d=15mm, Pin=250mW/Zoom Scan (5x5x7) (7x7x7)/Cube 0:** Measurement grid: dx=5mm, dy=5mm, dz=5mm

Reference Value = 56.09 V/m; Power Drift = 0.00 dB

Peak SAR (extrapolated) = 3.76 W/kg

**SAR(1 g) = 2.48 W/kg; SAR(10 g) = 1.61 W/kg**

Maximum value of SAR (measured) = 2.92 W/kg



# CERTIFICATE OF CALIBRATION

## ISSUED BY UL VS LTD

CERTIFICATE  
NUMBER :  
12134282JD01B

UKAS Accredited Calibration Laboratory No. 5248

Page 6 of 10

### Impedance Measurement Plot for Head Stimulating Liquid (HSL)

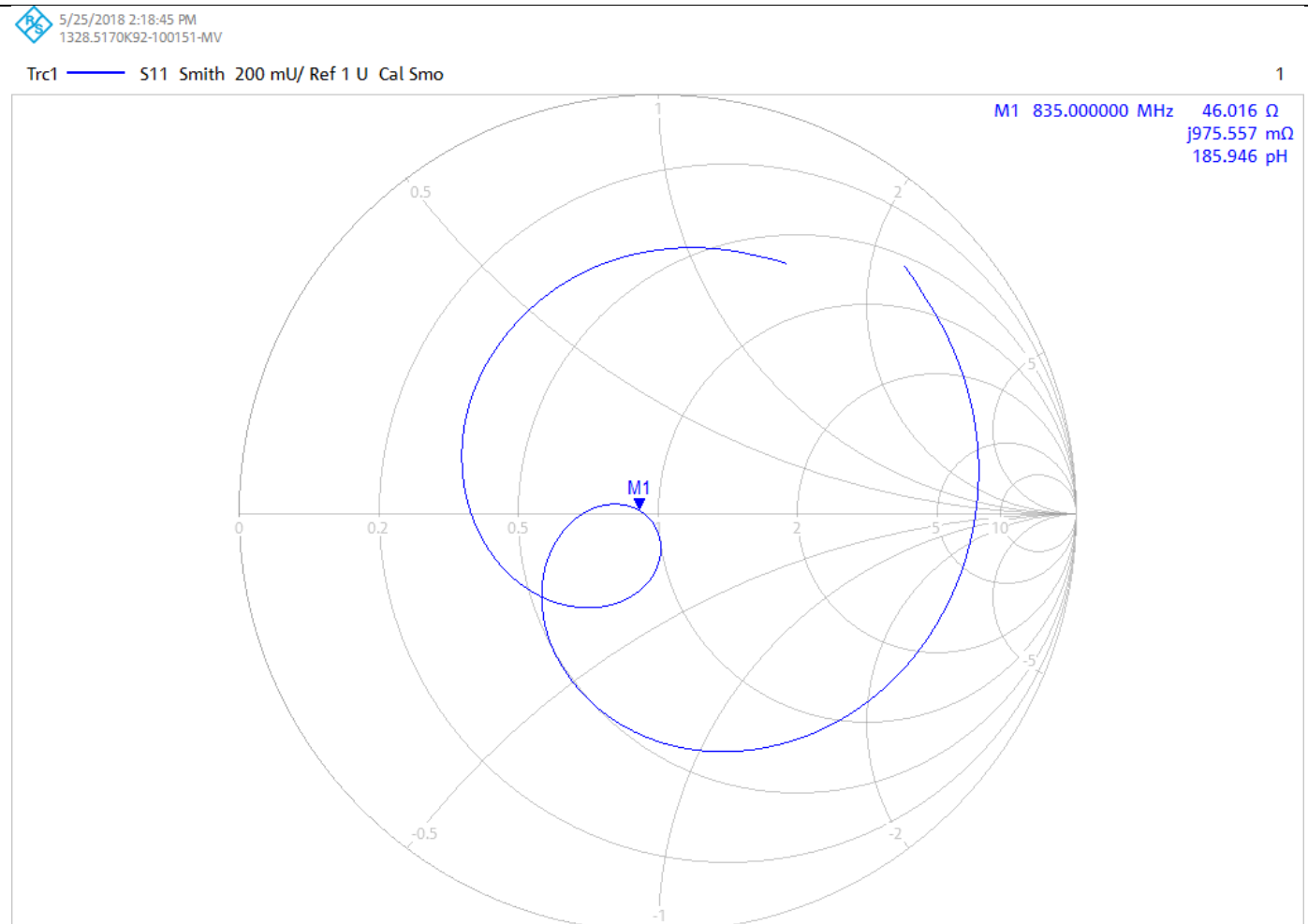

Ch1 Start 635 MHz

Pwr -10 dBm Bw 10 kHz

Stop 1.035 GHz

# CERTIFICATE OF CALIBRATION

## ISSUED BY UL VS LTD

UKAS Accredited Calibration Laboratory No. 5248

CERTIFICATE  
NUMBER :  
12134282JD01B

Page 7 of 10

### Return Loss Measurement Plot for Head Stimulating Liquid (HSL)

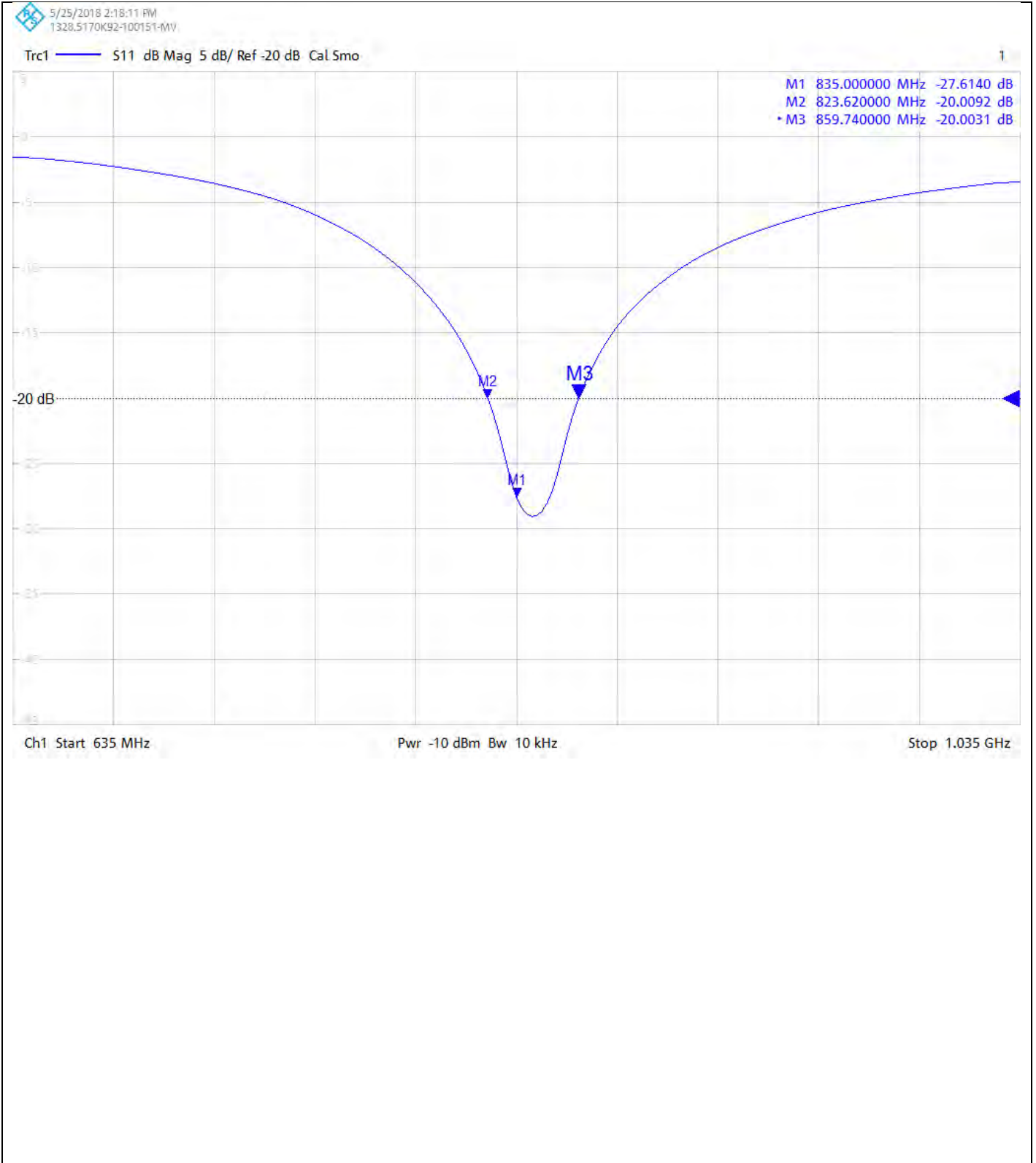

# CERTIFICATE OF CALIBRATION

## ISSUED BY UL VS LTD

CERTIFICATE  
NUMBER :  
12134282JD01B

UKAS Accredited Calibration Laboratory No. 5248

Page 8 of 10

### DASY Validation Scan for Body Stimulating Liquid (MSL)

DUT: D835V2 - SN4d117; Type: D835V2; Serial: SN4d117

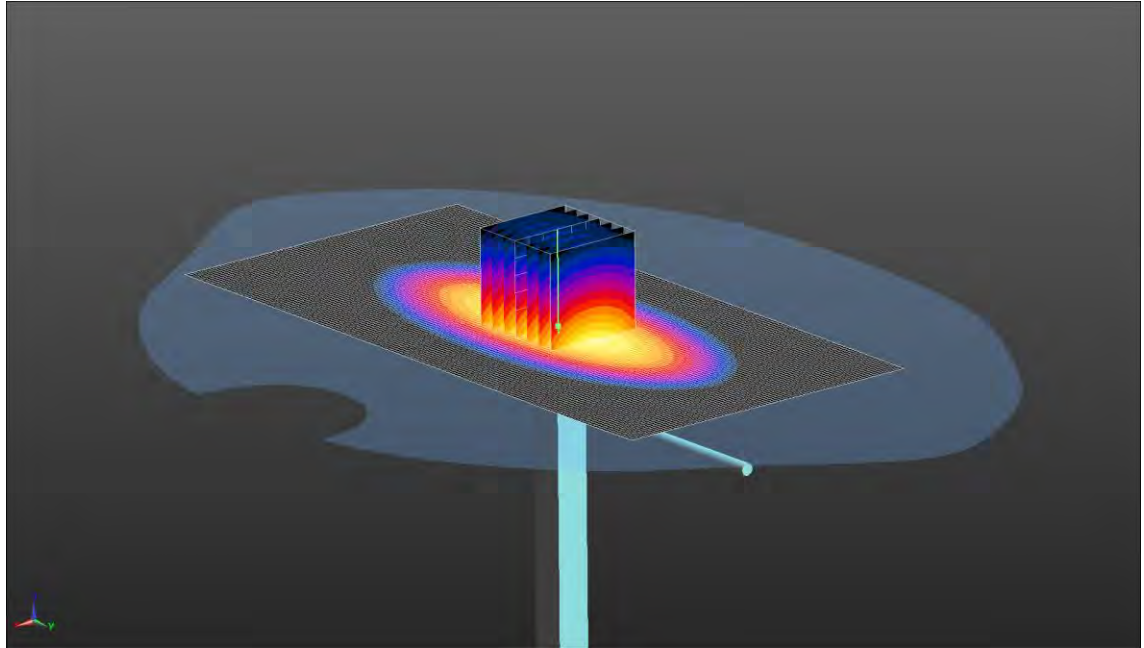
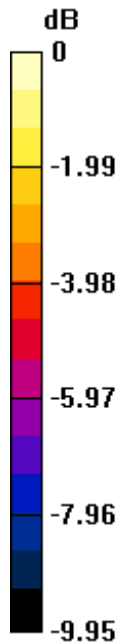

0 dB = 3.27 W/kg = 5.15 dBW/kg

Communication System: UID 0, CW (0); Frequency: 835 MHz; Duty Cycle: 1:1

Medium: 835 MHz MSL Medium parameters used (interpolated):  $f = 835$  MHz;  $\sigma = 0.985$  S/m;  $\epsilon_r = 55.65$ ;  $\rho = 1000$  kg/m<sup>3</sup>

Phantom section: Flat Section

DASY4 Configuration:

- Probe: EX3DV4 - SN3995; ConvF(10.04, 10.04, 10.04); Calibrated: 24/04/2018;
- Sensor-Surface: 4mm (Mechanical Surface Detection), Sensor-Surface: 2mm (Mechanical Surface Detection)
- Electronics: DAE4 Sn1542; Calibrated: 06/03/2018
- Phantom: Twin SAM A (Site 65); Type: SAM 4.0; Serial: TP:1020
- ; SEMCAD X Version 14.6.10 (7417)

**Configuration/d=15mm, Pin=250mW/Area Scan (81x161x1):** Interpolated grid: dx=1.200 mm, dy=1.200 mm

Maximum value of SAR (interpolated) = 2.79 W/kg

**Configuration/d=15mm, Pin=250mW/Zoom Scan (7x7x7) (7x7x7)/Cube 0:** Measurement grid: dx=5mm, dy=5mm, dz=5mm

Reference Value = 52.96 V/m; Power Drift = -0.02 dB

Peak SAR (extrapolated) = 3.84 W/kg

**SAR(1 g) = 2.59 W/kg; SAR(10 g) = 1.72 W/kg**

Maximum value of SAR (measured) = 3.27 W/kg

# CERTIFICATE OF CALIBRATION

## ISSUED BY UL VS LTD

UKAS Accredited Calibration Laboratory No. 5248

CERTIFICATE  
NUMBER :  
12134282JD01B

Page 9 of 10

### Impedance Measurement Plot for Body Stimulating Liquid (MSL)

5/22/2018 1:40:50 PM  
1328.5170K92-100151-MV

Trc1 — S11 Smith 200 mU/ Ref 1 U Cal Smo

1

M1 835.000000 MHz 45.096  $\Omega$   
j5.689  $\Omega$   
1.084 nH

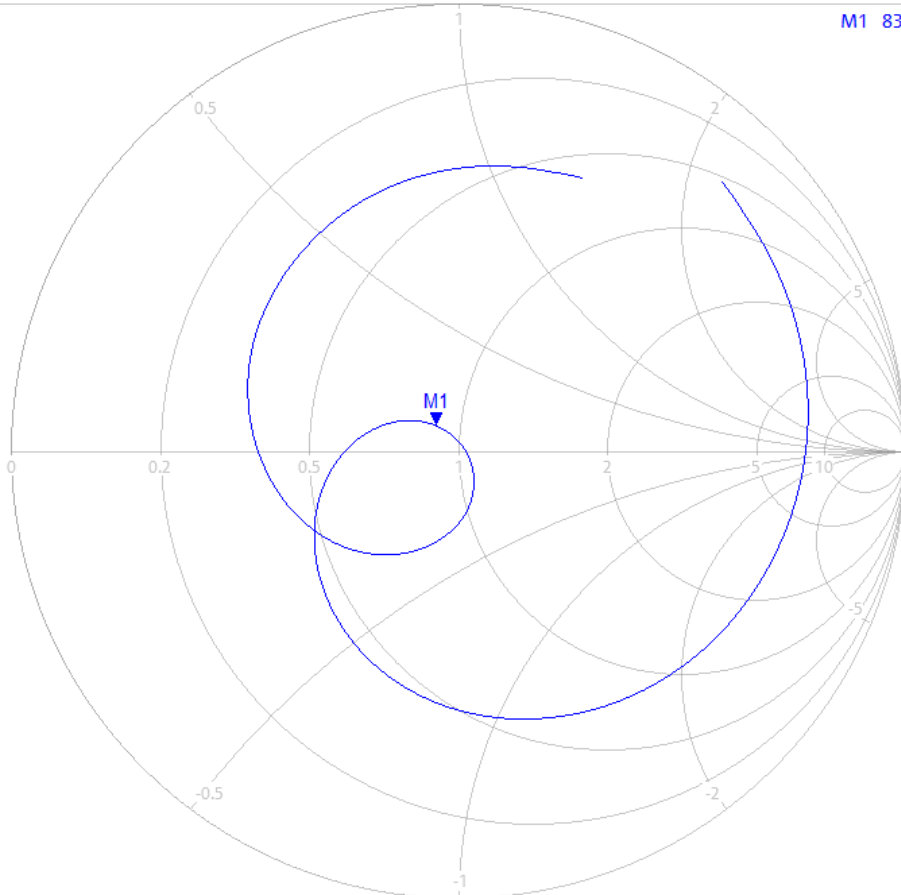

Ch1 Start 635 MHz

Pwr -10 dBm Bw 10 kHz

Stop 1.035 GHz

# CERTIFICATE OF CALIBRATION

## ISSUED BY UL VS LTD

UKAS Accredited Calibration Laboratory No. 5248

CERTIFICATE  
NUMBER :  
12134282JD01B

Page 10 of 10

### Return Loss Measurement Plot for Body Stimulating Liquid (MSL)

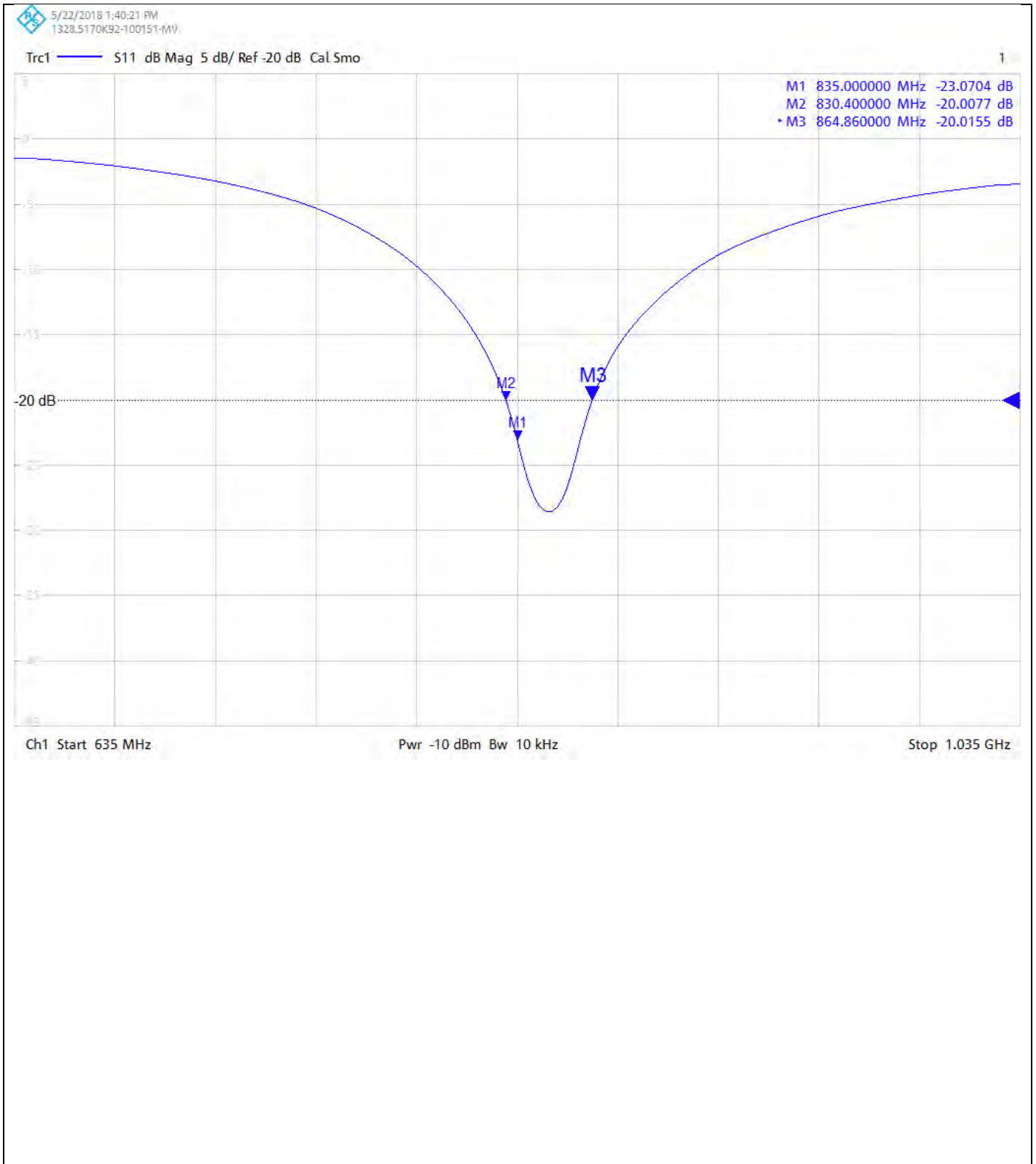

**Calibration Certificate Label:**

 <p>UKAS CALIBRATION 5248</p>	<p><b>UL VS LTD - Tel: +44 (0) 1256312000</b></p> <p>Certificate Number: 12134282JD01B</p> <p>Instrument ID: 4d117</p> <p>Calibration Date: 08/Jun/2018</p> <p>Calibration Due Date:</p>
--	--

 <p>UKAS CALIBRATION 5248</p>	<p><b>UL VS LTD - Tel: +44 (0) 1256312000</b></p> <p>Certificate Number: 12134282JD01B</p> <p>Instrument ID: 4d117</p> <p>Calibration Date: 08/Jun/2018</p> <p>Calibration Due Date:</p>
--	--

 <p>UKAS CALIBRATION 5248</p>	<p><b>UL VS LTD - Tel: +44 (0) 1256312000</b></p> <p>Certificate Number: 12134282JD01B</p> <p>Instrument ID: 4d117</p> <p>Calibration Date: 08/Jun/2018</p> <p>Calibration Due Date:</p>
--	--

# CERTIFICATE OF CALIBRATION

ISSUED BY **UL VS LTD**

DATE OF ISSUE: 12/Apr/2018

CERTIFICATE NUMBER : 12134278JD01A



5248

UL VS LTD  
PAVILION A  
ASHWOOD PARK, ASHWOOD WAY  
BASINGSTOKE, HAMPSHIRE  
RG23 8BG, UK  
TEL: +44 (0) 1256 312000  
FAX: +44 (0) 1256 312001  
Email: LST.UK.Calibration@ul.com



Page 1 of 10

**APPROVED SIGNATORY**

A handwritten signature in black ink, appearing to read 'M. Naseer'.

.....  
Naseer Mirza

## Customer :

UL VS Inc  
47173 Benicia Street  
Fremont, CA 94538, USA

## Equipment Details:

Description:	Dipole Validation Kit	Date of Receipt:	10/Apr/2018
Manufacturer:	Speag		
Type/Model Number:	D1750V2		
Serial Number:	1050		
Calibration Date:	10/Apr/2018		
Calibrated By:	Chanthu Thevarajah Senior Engineer		

Signature:

A handwritten signature in black ink, appearing to be a stylized 'C' followed by 'T'.

.....  
All Calibration have been conducted in the closed laboratory facility: Lab Temperature (22±3) °C and humidity < 70%

This certificate is issued in accordance with the laboratory accreditation requirements of the United Kingdom Accreditation Service. It provides traceability of measurement to the SI system of units and/or to units of measurement realised at the National Physical Laboratory or other recognised national metrology institutes. This certificate may not be reproduced other than in full, except with the prior written approval of the issuing laboratory.

Use of the UKAS mark demonstrates that compliance with the requirements of BS/EN/ISO/IEC 17025 has been independently assessed.

# CERTIFICATE OF CALIBRATION

## ISSUED BY UL VS LTD

UKAS Accredited Calibration Laboratory No. 5248

CERTIFICATE  
NUMBER :  
12134278JD01A

Page 2 of 10

The calibration methods and procedures used were as detailed in:

1. **IEC 62209-1:2016:** Procedure to determine the specific absorption rate (SAR) for hand-held devices used in close proximity to the ear (frequency range of 300 MHz to 3 GHz)
2. **IEC 62209-2:2010:** Procedure to determine the specific absorption rate (SAR) for wireless communication devices used in close proximity to the human body (frequency range of 30 MHz to 6 GHz)
3. **IEEE 1528: 2013:** IEEE Recommended Practice for Determining the Peak Spatial-Average Specific Absorption Rate (SAR) in the Human Head from Wireless Communication Devices: Measurement Techniques
4. FCC KDB Publication Number: “**KDB865664 D01 SAR Measurement 100 MHz to 6 GHz**”
5. **SPEAG DASY4/ DASY5 System Handbook**

The measuring equipment used to perform the calibration, documented in this certificate has been calibrated in accordance with the manufacturers' recommendations, and is traceable to recognized national standards.

UL No.	Instrument	Manufacturer	Type No.	Serial No.	Date Last Calibrated	Cal. Interval (Months)
A2110	Data Acquisition Electronics	SPEAG	DAE4	431	08 Nov 2017	12
A2077	Probe	SPEAG	EX3DV4	3814	28 Sep 2017	12
A1236	Dipole	SPEAG	D1800V2	2d009	06 Feb 2018	12
PRE0151451	Power Monitoring Kit	Art-Fi SAS	ART 100850-01	0001	Cal as part of System	12
PRE0151441	Power Sensor	Rhode & Schwarz	NRP8S	102481	05 Feb 2018	12
M1015	Network Analyser	Agilent Technologies	8753ES	US39172406	12 Oct 2017	12
PRE0151154	Network Analyser	Rhode & Schwarz	ZND8	100151	14 Dec 2017	12
PRE0151877	Calibration Kit	Rhode & Schwarz	Z135	102947-Bt	09 May 2017	12
M1838	Signal Generator	Rhode & Schwarz	SME06	831377/005	22 Mar 2018	12



# CERTIFICATE OF CALIBRATION

## ISSUED BY UL VS LTD

UKAS Accredited Calibration Laboratory No. 5248

CERTIFICATE  
NUMBER :  
12134278JD01A

Page 3 of 10

### SAR System Specification

<b>Robot System Positioner:</b>	Stäubli Unimation Corp. Robot Model: TX60L
<b>Robot Serial Number:</b>	F14/5T5ZA1/A/01
<b>DASY Version:</b>	DASY 52 (v52.8.8.1258)
<b>Phantom:</b>	Flat section of SAM Twin Phantom
<b>Distance Dipole Centre:</b>	10 mm (with spacer)
<b>Frequency:</b>	1750 MHz

### Dielectric Property Measurements – Head Simulating Liquid (HSL)

Simulant Liquid	Frequency (MHz)	Room Temp		Liquid Temp		Parameters	Target Value	Measured Value	Uncertainty (%)
		Start	End	Start	End				
Head	1750	21.0 °C	22.0 °C	21.0°C	21.0°C	$\epsilon_r$	40.10	40.34	± 5%
						$\sigma$	1.37	1.36	± 5%

### SAR Results – Head Simulating Liquid (HSL)

Simulant Liquid	SAR Measured	250 mW input Power	Normalised to 1.00 W	Uncertainty (%)
Head	SAR averaged over 1g	9.17 W/Kg	<b>36.50 W/Kg</b>	± 17.57%
	SAR averaged over 10g	4.88 W/Kg	<b>19.42 W/Kg</b>	± 17.32%

### Antenna Parameters – Head Simulating Liquid (HSL)

Simulant Liquid	Parameter	Measured Level	Uncertainty (%)
Head	Impedance	50.755 $\Omega$ 1.33 j $\Omega$	± 0.28 $\Omega$ ± 0.044 j $\Omega$
	Return Loss	34.43	± 2.03 dB

# CERTIFICATE OF CALIBRATION

## ISSUED BY UL VS LTD

UKAS Accredited Calibration Laboratory No. 5248

CERTIFICATE  
NUMBER :  
12134278JD01A

Page 4 of 10

### Dielectric Property Measurements – Body Simulating Liquid (MSL)

Simulant Liquid	Frequency (MHz)	Room Temp		Liquid Temp		Parameters	Target Value	Measured Value	Uncertainty (%)
		Start	End	Start	End				
Body	1750	22.0 °C	22.0 °C	21.4°C	21.5°C	$\epsilon_r$	53.40	53.92	± 5%
						$\sigma$	1.49	1.49	± 5%

### SAR Results – Body Simulating Liquid (MSL)

Simulant Liquid	SAR Measured	250 mW input Power	Normalised to 1.00 W	Uncertainty (%)
Body	SAR averaged over 1g	9.34 W/Kg	<b>37.18 W/Kg</b>	± 18.06%
	SAR averaged over 10g	4.96 W/Kg	<b>19.74 W/Kg</b>	± 17.44%

### Antenna Parameters – Body Simulating Liquid (MSL)

Simulant Liquid	Parameter	Measured Level	Uncertainty (%)
Body	Impedance	51.45 $\Omega$ 4.19 $j\Omega$	± 0.28 $\Omega$ ± 0.044 $j\Omega$
	Return Loss	26.60	± 2.03 dB

# CERTIFICATE OF CALIBRATION

## ISSUED BY UL VS LTD

CERTIFICATE  
NUMBER :  
12134278JD01A

UKAS Accredited Calibration Laboratory No. 5248

Page 5 of 10

### DASY Validation Scan for Head Stimulating Liquid (HSL)

DUT: D1750V2 - SN1050; Type: D1750V2; Serial: SN1050

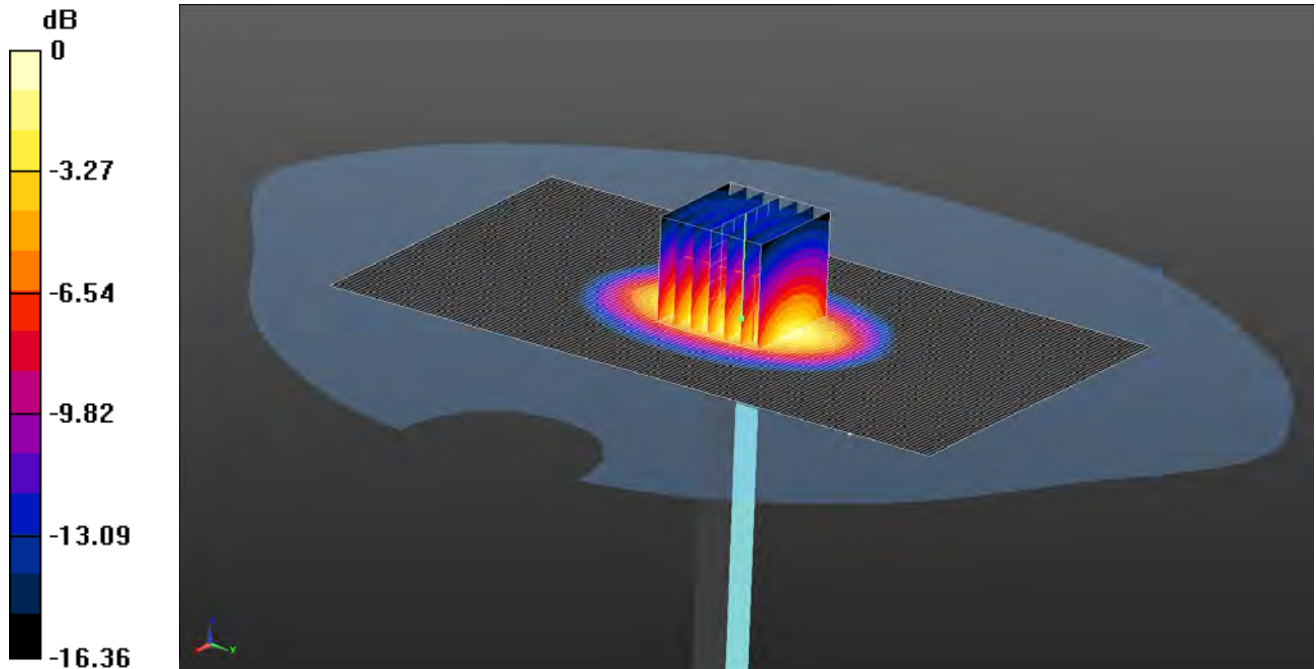

0 dB = 11.6 W/kg = 10.64 dBW/kg

Communication System: UID 0, CW (0); Frequency: 1750 MHz; Duty Cycle: 1:1  
Medium: 1800 MHz HSL Medium parameters used:  $f = 1750$  MHz;  $\sigma = 1.365$  S/m;  $\epsilon_r = 40.338$ ;  $\rho = 1000$  kg/m<sup>3</sup>  
Phantom section: Flat Section  
DASY4 Configuration:  
- Probe: EX3DV4 - SN3814; ConvF(8.11, 8.11, 8.11); Calibrated: 28/09/2017;  
- Sensor-Surface: 3mm (Mechanical Surface Detection)  
- Electronics: DAE4 Sn431; Calibrated: 08/11/2017  
- Phantom: SAM (20deg probe tilt) with CRP v5.0; Type: QD000P40CC; Serial: TP:1832  
- ; SEMCAD X Version 14.6.10 (7372)

**Configuration/d=10mm, Pin=250mW/Area Scan (81x151x1):** Interpolated grid: dx=1.200 mm, dy=1.200 mm

Maximum value of SAR (interpolated) = 11.8 W/kg

**Configuration/d=10mm, Pin=250mW/Zoom Scan (7x7x7)/Cube 0:** Measurement grid: dx=5mm, dy=5mm, dz=5mm

Reference Value = 91.06 V/m; Power Drift = 0.05 dB

Peak SAR (extrapolated) = 16.7 W/kg

**SAR(1 g) = 9.17 W/kg; SAR(10 g) = 4.88 W/kg**

Maximum value of SAR (measured) = 11.6 W/kg

# CERTIFICATE OF CALIBRATION

## ISSUED BY UL VS LTD

UKAS Accredited Calibration Laboratory No. 5248

CERTIFICATE  
NUMBER :  
12134278JD01A

Page 6 of 10

### Impedance Measurement Plot for Head Stimulating Liquid (HSL)

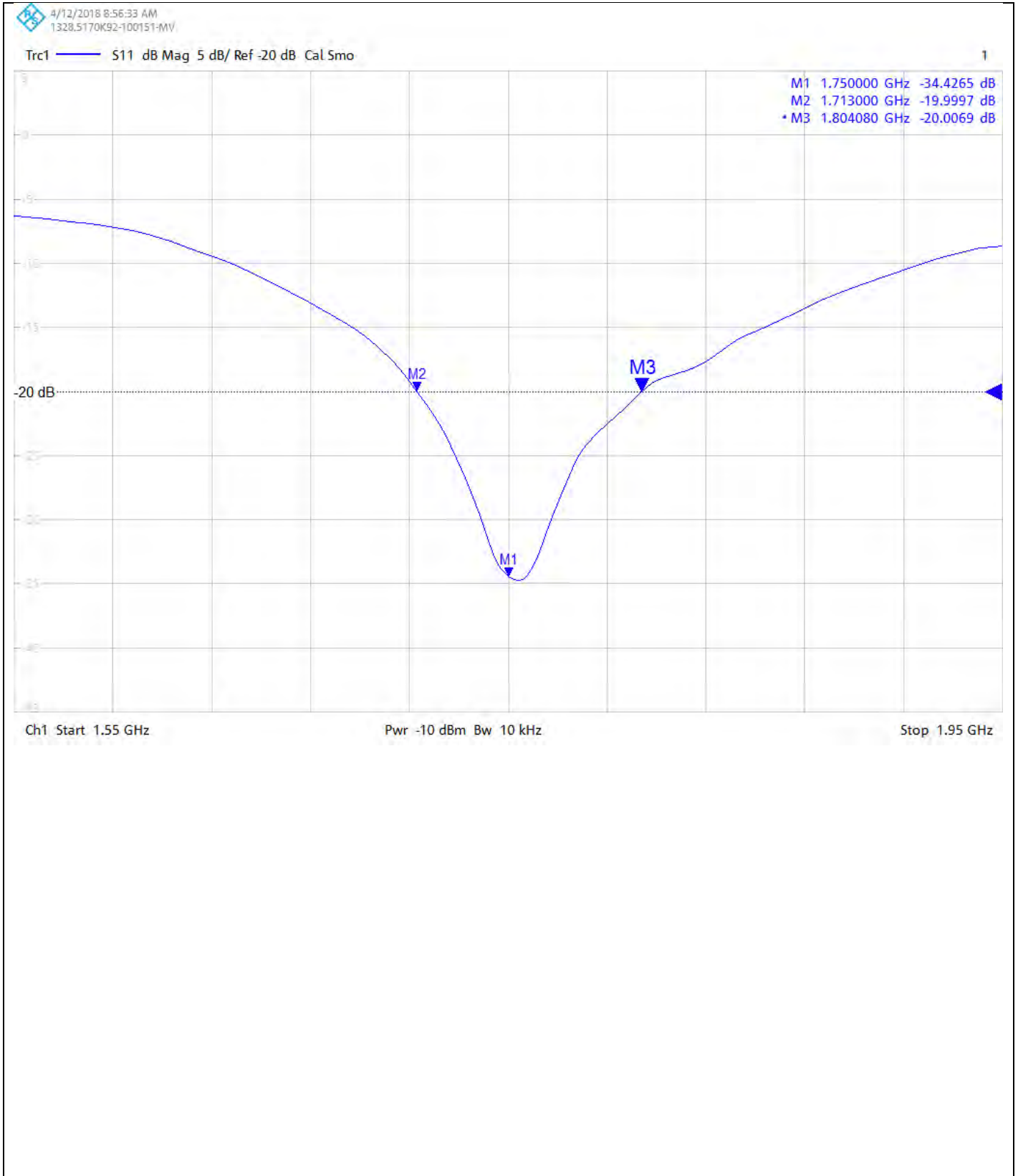

# CERTIFICATE OF CALIBRATION

## ISSUED BY UL VS LTD

UKAS Accredited Calibration Laboratory No. 5248

CERTIFICATE  
NUMBER :  
12134278JD01A

Page 7 of 10

### Return Loss Measurement Plot for Head Stimulating Liquid (HSL)

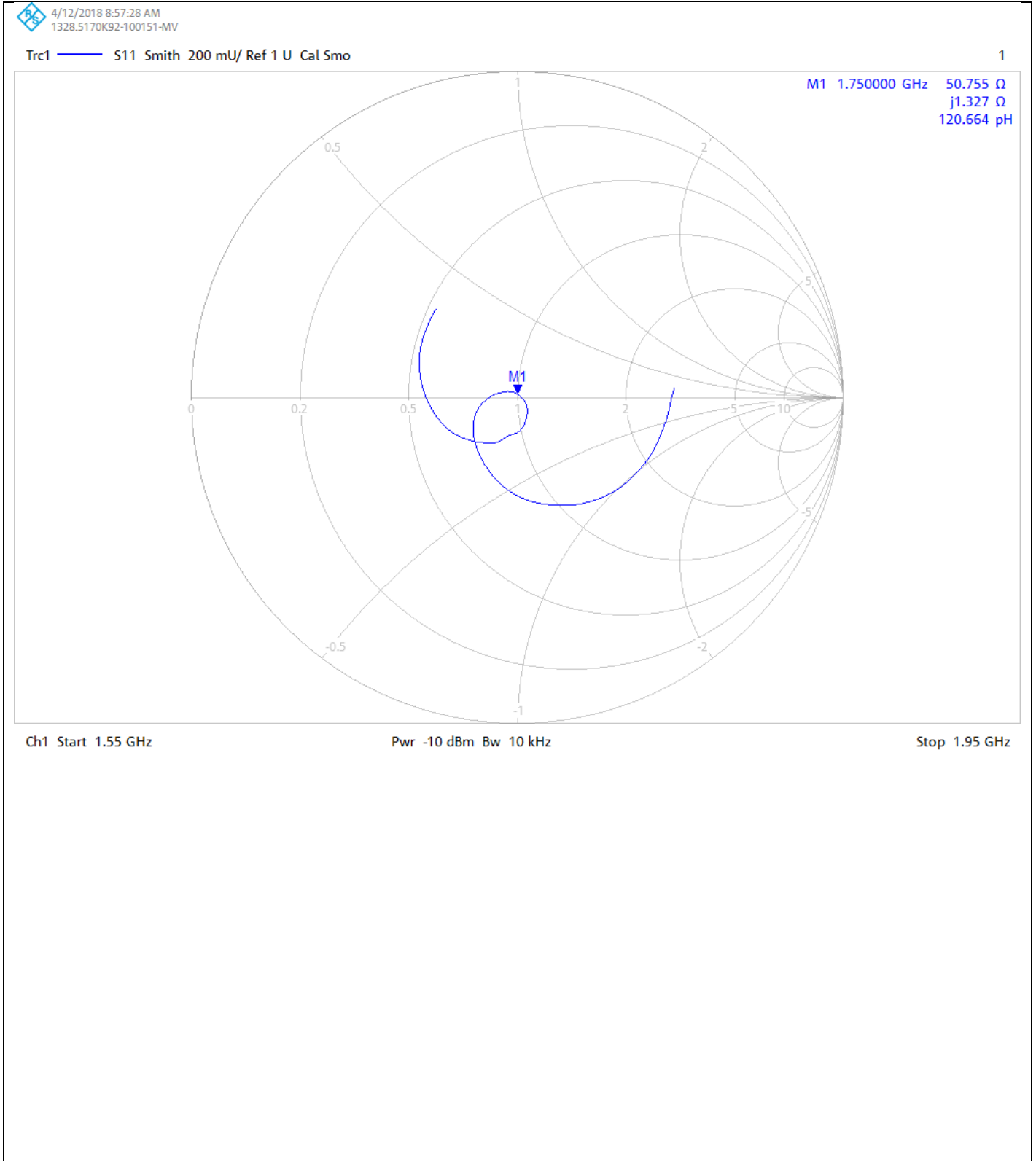

# CERTIFICATE OF CALIBRATION

## ISSUED BY UL VS LTD

UKAS Accredited Calibration Laboratory No. 5248

CERTIFICATE  
NUMBER :  
12134278JD01A

Page 8 of 10

### DASY Validation Scan for Body Stimulating Liquid (MSL)

DUT: D1750V2 - SN1050; Type: D1750V2; Serial: SN1050

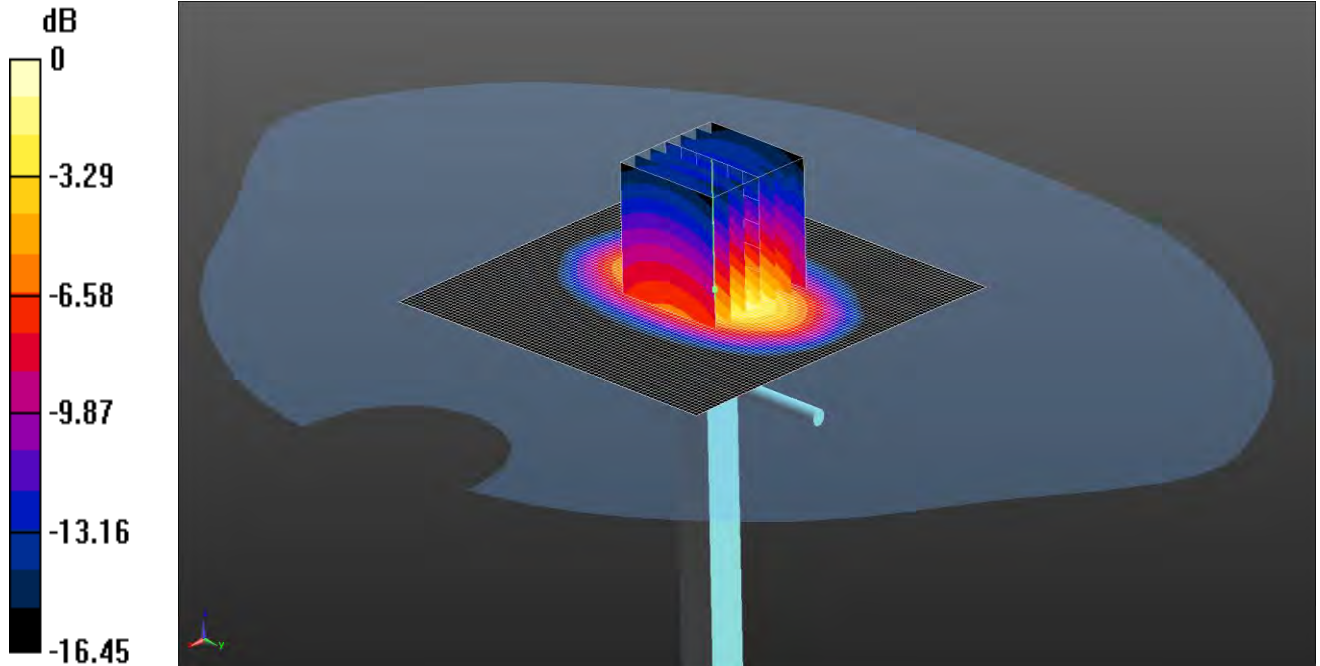

0 dB = 13.3 W/kg = 11.24 dBW/kg

Communication System: UID 0, CW (0); Frequency: 1750 MHz; Duty Cycle: 1:1  
Medium: 1800 MHz MSL Medium parameters used:  $f = 1750$  MHz;  $\sigma = 1.491$  S/m;  $\epsilon_r = 53.919$ ;  $\rho = 1000$  kg/m<sup>3</sup>  
Phantom section: Flat Section  
DASY4 Configuration:  
- Probe: EX3DV4 - SN3814; ConvF(7.83, 7.83, 7.83); Calibrated: 28/09/2017;  
- Sensor-Surface: 4mm (Mechanical Surface Detection), Sensor-Surface: 2mm (Mechanical Surface Detection)  
- Electronics: DAE4 Sn431; Calibrated: 08/11/2017  
- Phantom: SAM (20deg probe tilt) with CRP v5.0; Type: QD000P40CC; Serial: TP:1832  
- ; SEMCAD X Version 14.6.10 (7372)

**Configuration/d=10mm, Pin=250mW/Area Scan (81x81x1):** Interpolated grid: dx=1.200 mm, dy=1.200 mm

Maximum value of SAR (interpolated) = 10.7 W/kg

**Configuration/d=10mm, Pin=250mW/Zoom Scan (7x7x7)/Cube 0:** Measurement grid: dx=5mm, dy=5mm, dz=5mm

Reference Value = 83.86 V/m; Power Drift = 0.03 dB

Peak SAR (extrapolated) = 16.8 W/kg

**SAR(1 g) = 9.34 W/kg; SAR(10 g) = 4.96 W/kg**

Maximum value of SAR (measured) = 13.3 W/kg

# CERTIFICATE OF CALIBRATION

## ISSUED BY UL VS LTD

UKAS Accredited Calibration Laboratory No. 5248

CERTIFICATE  
NUMBER :  
12134278JD01A

Page 9 of 10

### Impedance Measurement Plot for Body Stimulating Liquid (MSL)

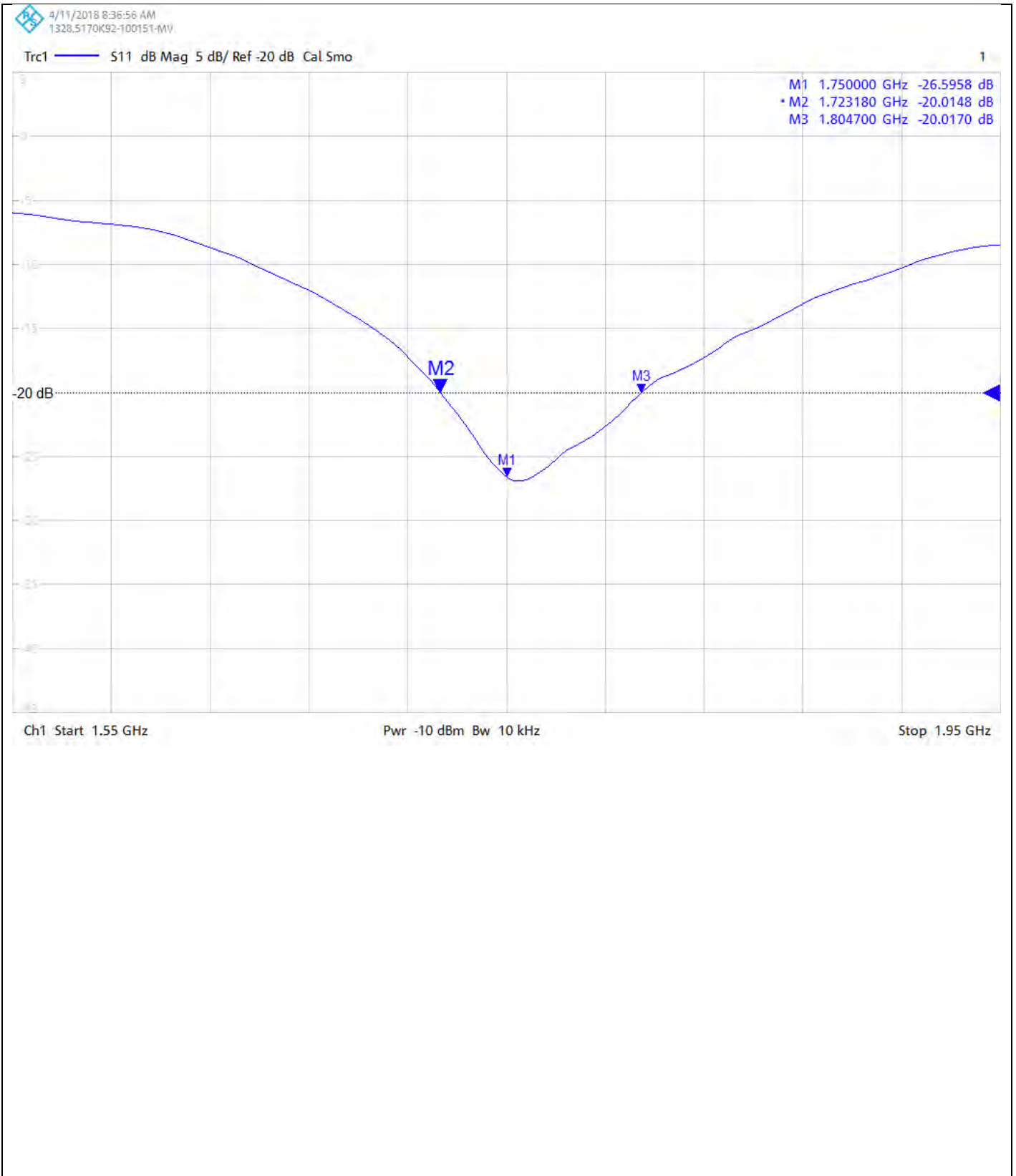

# CERTIFICATE OF CALIBRATION

## ISSUED BY UL VS LTD

UKAS Accredited Calibration Laboratory No. 5248

CERTIFICATE  
NUMBER :  
12134278JD01A

Page 10 of 10

### Return Loss Measurement Plot for Body Stimulating Liquid (MSL)

4/11/2018 8:37:44 AM  
1328.5170K92-100151-MV

Trc1 — S11 Smith 200 mU/ Ref 1 U Cal Smo

1

M1 1.750000 GHz 51.449  $\Omega$   
j4.185  $\Omega$   
380.564 pH

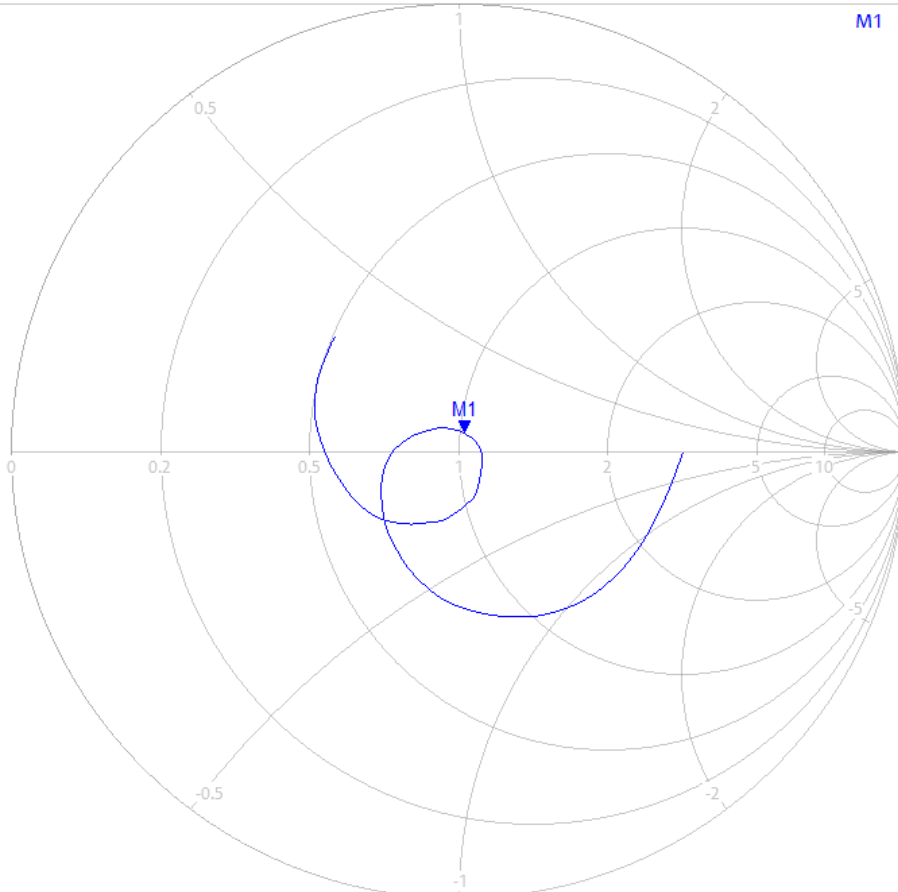

Ch1 Start 1.55 GHz

Pwr -10 dBm Bw 10 kHz

Stop 1.95 GHz



**Calibration Certificate Label:**

 <p>UKAS CALIBRATION 5248</p>	<p><b>UL VS LTD - Tel: +44 (0) 1256312000</b></p> <p>Certificate Number: 12134278JD01A</p> <p>Instrument ID: 1050</p> <p>Calibration Date: 10/Apr/2018</p> <p>Calibration Due Date:</p>
--	---

 <p>UKAS CALIBRATION 5248</p>	<p><b>UL VS LTD - Tel: +44 (0) 1256312000</b></p> <p>Certificate Number: 12134278JD01A</p> <p>Instrument ID: 1050</p> <p>Calibration Date: 10/Apr/2018</p> <p>Calibration Due Date:</p>
--	---

 <p>UKAS CALIBRATION 5248</p>	<p><b>UL VS LTD - Tel: +44 (0) 1256312000</b></p> <p>Certificate Number: 12134278JD01A</p> <p>Instrument ID: 1050</p> <p>Calibration Date: 10/Apr/2018</p> <p>Calibration Due Date:</p>
--	---



Accredited by the Swiss Accreditation Service (SAS)  
**The Swiss Accreditation Service is one of the signatories to the EA  
Multilateral Agreement for the recognition of calibration certificates**

Accreditation No.: **SCS 0108**

Client **UL CCS USA**

Certificate No: **D1750V2-1050\_Apr19**

## CALIBRATION CERTIFICATE

Object **D1750V2 - SN:1050**

Calibration procedure(s) **QA CAL-05.v11  
Calibration Procedure for SAR Validation Sources between 0.7-3 GHz**

Calibration date: **April 17, 2019**

This calibration certificate documents the traceability to national standards, which realize the physical units of measurements (SI).  
The measurements and the uncertainties with confidence probability are given on the following pages and are part of the certificate.

All calibrations have been conducted in the closed laboratory facility: environment temperature ( $22 \pm 3$ )°C and humidity < 70%.

Calibration Equipment used (M&TE critical for calibration)

Primary Standards	ID #	Cal Date (Certificate No.)	Scheduled Calibration
Power meter NRP	SN: 104778	03-Apr-19 (No. 217-02892/02893)	Apr-20
Power sensor NRP-Z91	SN: 103244	03-Apr-19 (No. 217-02892)	Apr-20
Power sensor NRP-Z91	SN: 103245	03-Apr-19 (No. 217-02893)	Apr-20
Reference 20 dB Attenuator	SN: 5058 (20k)	04-Apr-19 (No. 217-02894)	Apr-20
Type-N mismatch combination	SN: 5047.2 / 06327	04-Apr-19 (No. 217-02895)	Apr-20
Reference Probe EX3DV4	SN: 7349	31-Dec-18 (No. EX3-7349_Dec18)	Dec-19
DAE4	SN: 601	04-Oct-18 (No. DAE4-601_Oct18)	Oct-19

Secondary Standards	ID #	Check Date (in house)	Scheduled Check
Power meter E4419B	SN: GB39512475	07-Oct-15 (in house check Feb-19)	In house check: Oct-20
Power sensor HP 8481A	SN: US37292783	07-Oct-15 (in house check Oct-18)	In house check: Oct-20
Power sensor HP 8481A	SN: MY41092317	07-Oct-15 (in house check Oct-18)	In house check: Oct-20
RF generator R&S SMT-06	SN: 100972	15-Jun-15 (in house check Oct-18)	In house check: Oct-20
Network Analyzer Agilent E8358A	SN: US41080477	31-Mar-14 (in house check Oct-18)	In house check: Oct-19

Calibrated by:	Name <b>Michael Weber</b>	Function <b>Laboratory Technician</b>	Signature 
Approved by:	Name <b>Katja Pokovic</b>	Function <b>Technical Manager</b>	Signature 

Issued: April 18, 2019

This calibration certificate shall not be reproduced except in full without written approval of the laboratory.



Accredited by the Swiss Accreditation Service (SAS)  
The Swiss Accreditation Service is one of the signatories to the EA  
Multilateral Agreement for the recognition of calibration certificates

### Glossary:

TSL	tissue simulating liquid
ConvF	sensitivity in TSL / NORM x,y,z
N/A	not applicable or not measured

### Calibration is Performed According to the Following Standards:

- IEEE Std 1528-2013, "IEEE Recommended Practice for Determining the Peak Spatial-Averaged Specific Absorption Rate (SAR) in the Human Head from Wireless Communications Devices: Measurement Techniques", June 2013
- IEC 62209-1, "Measurement procedure for the assessment of Specific Absorption Rate (SAR) from hand-held and body-mounted devices used next to the ear (frequency range of 300 MHz to 6 GHz)", July 2016
- IEC 62209-2, "Procedure to determine the Specific Absorption Rate (SAR) for wireless communication devices used in close proximity to the human body (frequency range of 30 MHz to 6 GHz)", March 2010
- KDB 865664, "SAR Measurement Requirements for 100 MHz to 6 GHz"

### Additional Documentation:

- DASY4/5 System Handbook

### Methods Applied and Interpretation of Parameters:

- Measurement Conditions:** Further details are available from the Validation Report at the end of the certificate. All figures stated in the certificate are valid at the frequency indicated.
- Antenna Parameters with TSL:** The dipole is mounted with the spacer to position its feed point exactly below the center marking of the flat phantom section, with the arms oriented parallel to the body axis.
- Feed Point Impedance and Return Loss:** These parameters are measured with the dipole positioned under the liquid filled phantom. The impedance stated is transformed from the measurement at the SMA connector to the feed point. The Return Loss ensures low reflected power. No uncertainty required.
- Electrical Delay:** One-way delay between the SMA connector and the antenna feed point. No uncertainty required.
- SAR measured:** SAR measured at the stated antenna input power.
- SAR normalized:** SAR as measured, normalized to an input power of 1 W at the antenna connector.
- SAR for nominal TSL parameters:** The measured TSL parameters are used to calculate the nominal SAR result.

The reported uncertainty of measurement is stated as the standard uncertainty of measurement multiplied by the coverage factor  $k=2$ , which for a normal distribution corresponds to a coverage probability of approximately 95%.

## Measurement Conditions

DASY system configuration, as far as not given on page 1.

<b>DASY Version</b>	DASY5	V52.10.2
<b>Extrapolation</b>	Advanced Extrapolation	
<b>Phantom</b>	Modular Flat Phantom	
<b>Distance Dipole Center - TSL</b>	10 mm	with Spacer
<b>Zoom Scan Resolution</b>	dx, dy, dz = 5 mm	
<b>Frequency</b>	1750 MHz $\pm$ 1 MHz	

## Head TSL parameters

The following parameters and calculations were applied.

	Temperature	Permittivity	Conductivity
<b>Nominal Head TSL parameters</b>	22.0 °C	40.1	1.37 mho/m
<b>Measured Head TSL parameters</b>	(22.0 $\pm$ 0.2) °C	40.0 $\pm$ 6 %	1.34 mho/m $\pm$ 6 %
<b>Head TSL temperature change during test</b>	< 0.5 °C	----	----

## SAR result with Head TSL

<b>SAR averaged over 1 cm<sup>3</sup> (1 g) of Head TSL</b>	Condition	
SAR measured	250 mW input power	8.74 W/kg
SAR for nominal Head TSL parameters	normalized to 1W	<b>35.4 W/kg <math>\pm</math> 17.0 % (k=2)</b>

<b>SAR averaged over 10 cm<sup>3</sup> (10 g) of Head TSL</b>	condition	
SAR measured	250 mW input power	4.61 W/kg
SAR for nominal Head TSL parameters	normalized to 1W	<b>18.6 W/kg <math>\pm</math> 16.5 % (k=2)</b>

## Body TSL parameters

The following parameters and calculations were applied.

	Temperature	Permittivity	Conductivity
<b>Nominal Body TSL parameters</b>	22.0 °C	53.4	1.49 mho/m
<b>Measured Body TSL parameters</b>	(22.0 $\pm$ 0.2) °C	52.3 $\pm$ 6 %	1.48 mho/m $\pm$ 6 %
<b>Body TSL temperature change during test</b>	< 0.5 °C	----	----

## SAR result with Body TSL

<b>SAR averaged over 1 cm<sup>3</sup> (1 g) of Body TSL</b>	Condition	
SAR measured	250 mW input power	9.10 W/kg
SAR for nominal Body TSL parameters	normalized to 1W	<b>36.4 W/kg <math>\pm</math> 17.0 % (k=2)</b>

<b>SAR averaged over 10 cm<sup>3</sup> (10 g) of Body TSL</b>	condition	
SAR measured	250 mW input power	4.79 W/kg
SAR for nominal Body TSL parameters	normalized to 1W	<b>19.2 W/kg <math>\pm</math> 16.5 % (k=2)</b>

## Appendix (Additional assessments outside the scope of SCS 0108)

### Antenna Parameters with Head TSL

Impedance, transformed to feed point	50.3 $\Omega$ - 1.8 j $\Omega$
Return Loss	- 34.8 dB

### Antenna Parameters with Body TSL

Impedance, transformed to feed point	47.5 $\Omega$ - 2.1 j $\Omega$
Return Loss	- 29.6 dB

### General Antenna Parameters and Design

Electrical Delay (one direction)	1.224 ns
----------------------------------	----------

After long term use with 100W radiated power, only a slight warming of the dipole near the feedpoint can be measured.

The dipole is made of standard semirigid coaxial cable. The center conductor of the feeding line is directly connected to the second arm of the dipole. The antenna is therefore short-circuited for DC-signals. On some of the dipoles, small end caps are added to the dipole arms in order to improve matching when loaded according to the position as explained in the "Measurement Conditions" paragraph. The SAR data are not affected by this change. The overall dipole length is still according to the Standard.

No excessive force must be applied to the dipole arms, because they might bend or the soldered connections near the feedpoint may be damaged.

### Additional EUT Data

Manufactured by	SPEAG
-----------------	-------

# DASY5 Validation Report for Head TSL

Date: 17.04.2019

Test Laboratory: SPEAG, Zurich, Switzerland

**DUT: Dipole 1750 MHz; Type: D1750V2; Serial: D1750V2 - SN:1050**

Communication System: UID 0 - CW; Frequency: 1750 MHz

Medium parameters used:  $f = 1750$  MHz;  $\sigma = 1.34$  S/m;  $\epsilon_r = 40$ ;  $\rho = 1000$  kg/m<sup>3</sup>

Phantom section: Flat Section

Measurement Standard: DASY5 (IEEE/IEC/ANSI C63.19-2011)

DASY52 Configuration:

- Probe: EX3DV4 - SN7349; ConvF(8.59, 8.59, 8.59) @ 1750 MHz; Calibrated: 31.12.2018
- Sensor-Surface: 1.4mm (Mechanical Surface Detection)
- Electronics: DAE4 Sn601; Calibrated: 04.10.2018
- Phantom: Flat Phantom 5.0 (front); Type: QD 000 P50 AA; Serial: 1001
- DASY52 52.10.2(1495); SEMCAD X 14.6.12(7450)

## Dipole Calibration for Head Tissue/Pin=250 mW, d=10mm/Zoom Scan (7x7x7)/Cube 0:

Measurement grid: dx=5mm, dy=5mm, dz=5mm

Reference Value = 105.8 V/m; Power Drift = 0.01 dB

Peak SAR (extrapolated) = 15.9 W/kg

**SAR(1 g) = 8.74 W/kg; SAR(10 g) = 4.61 W/kg**

Maximum value of SAR (measured) = 13.5 W/kg



0 dB = 13.5 W/kg = 11.30 dBW/kg

# Impedance Measurement Plot for Head TSL

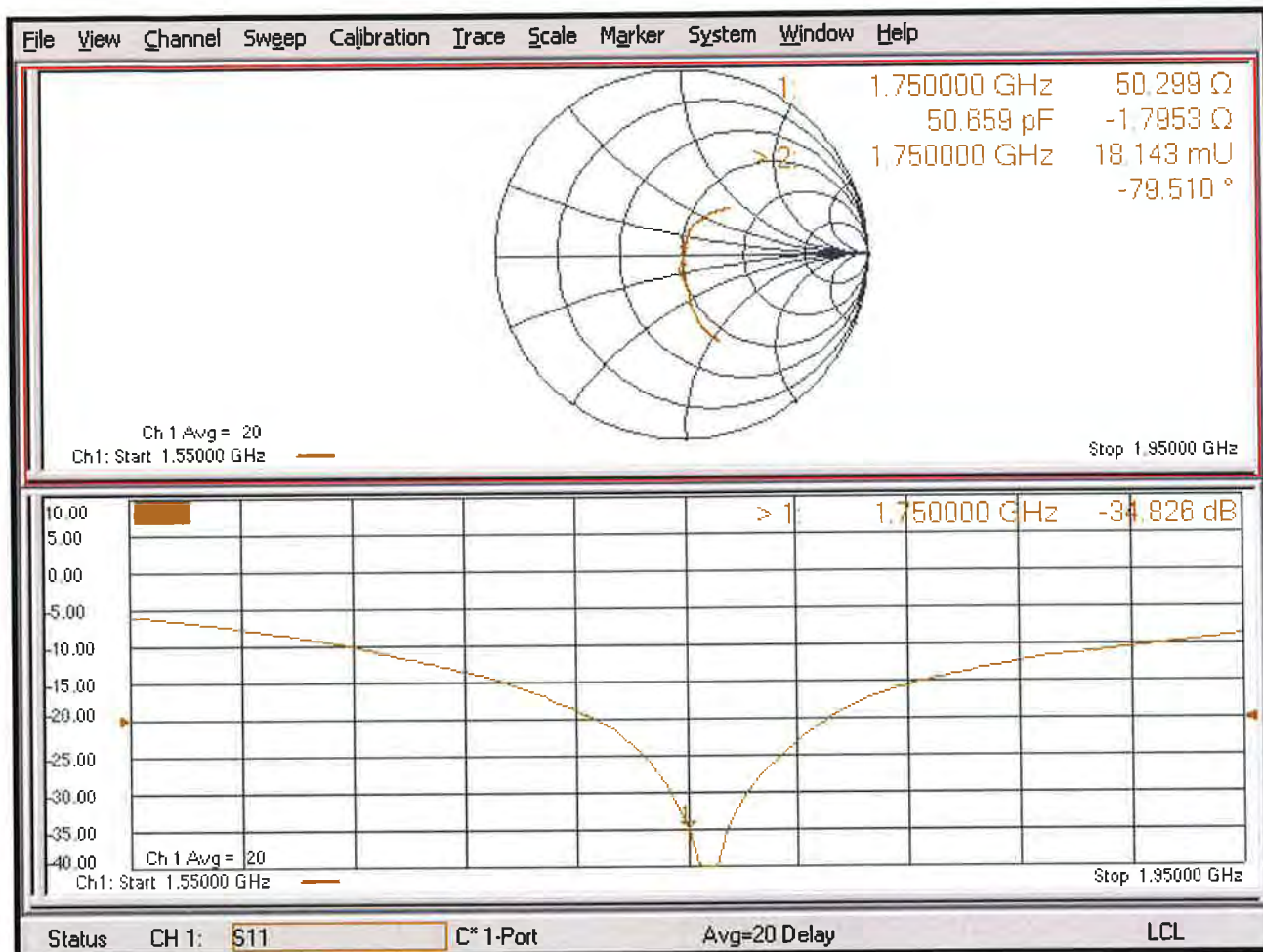

# DASY5 Validation Report for Body TSL

Date: 17.04.2019

Test Laboratory: SPEAG, Zurich, Switzerland

**DUT: Dipole 1750 MHz; Type: D1750V2; Serial: D1750V2 - SN:1050**

Communication System: UID 0 - CW; Frequency: 1750 MHz

Medium parameters used:  $f = 1750$  MHz;  $\sigma = 1.48$  S/m;  $\epsilon_r = 52.3$ ;  $\rho = 1000$  kg/m<sup>3</sup>

Phantom section: Flat Section

Measurement Standard: DASY5 (IEEE/IEC/ANSI C63.19-2011)

DASY52 Configuration:

- Probe: EX3DV4 - SN7349; ConvF(8.43, 8.43, 8.43) @ 1750 MHz; Calibrated: 31.12.2018
- Sensor-Surface: 1.4mm (Mechanical Surface Detection)
- Electronics: DAE4 Sn601; Calibrated: 04.10.2018
- Phantom: Flat Phantom 5.0 (back); Type: QD 000 P50 AA; Serial: 1002
- DASY52 52.10.2(1495); SEMCAD X 14.6.12(7450)

## Dipole Calibration for Body Tissue/Pin=250 mW, d=10mm/Zoom Scan (7x7x7)/Cube 0:

Measurement grid: dx=5mm, dy=5mm, dz=5mm

Reference Value = 101.0 V/m; Power Drift = -0.04 dB

Peak SAR (extrapolated) = 16.7 W/kg

**SAR(1 g) = 9.1 W/kg; SAR(10 g) = 4.79 W/kg**

Maximum value of SAR (measured) = 13.8 W/kg

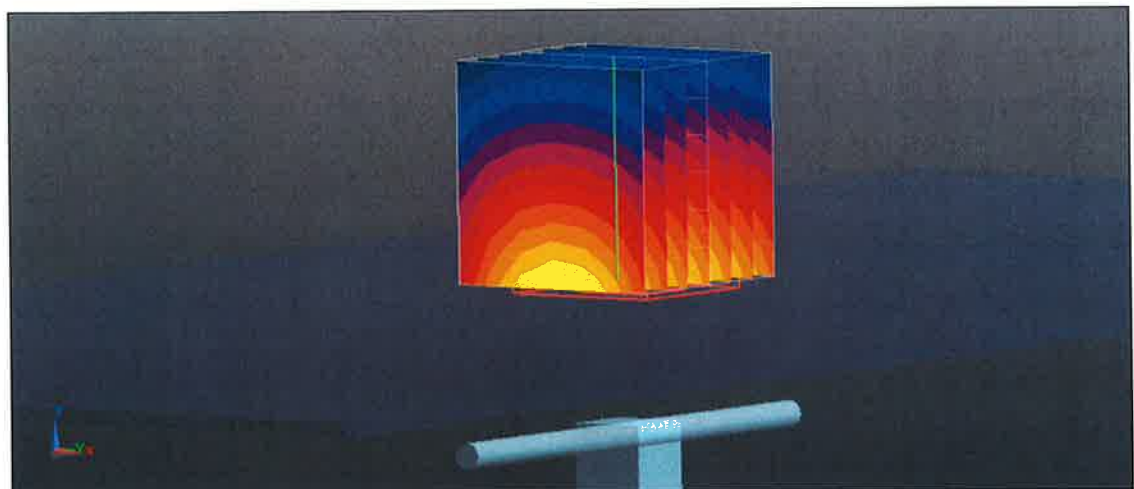
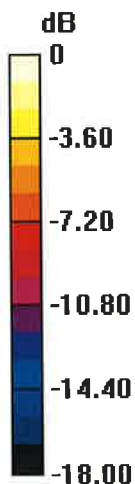

0 dB = 13.8 W/kg = 11.40 dBW/kg



# Impedance Measurement Plot for Body TSL

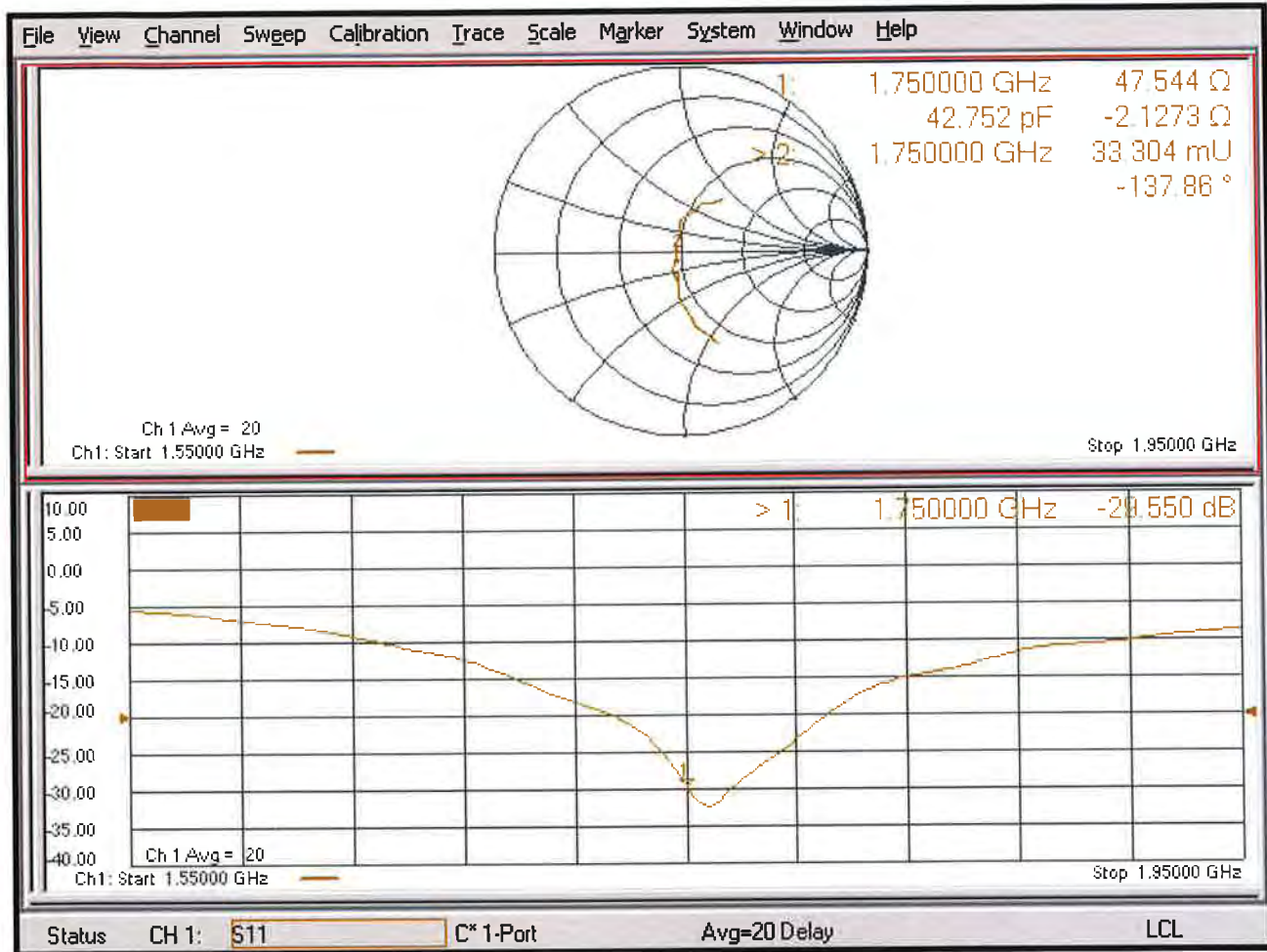

# CERTIFICATE OF CALIBRATION

ISSUED BY **UL VS LTD**

DATE OF ISSUE: 10/Oct/2017

CERTIFICATE NUMBER : 11903941JD01B



5248

UL VS LTD  
PAVILION A  
ASHWOOD PARK, ASHWOOD WAY  
BASINGSTOKE, HAMPSHIRE  
RG23 8BG, UK  
TEL: +44 (0) 1256 312000  
FAX: +44 (0) 1256 312001  
Email: LST.UK.Calibration@ul.com



Page 1 of 10

**APPROVED SIGNATORY**

.....  
Naseer Mirza

**Customer :**

UL VS Ltd  
Pavilion A, Ashwood Park, Ashwood Way  
Basingstoke, RG23 8BG, England

**Equipment Details:**

Description:	Dipole Validation Kit	Date of Receipt:	29/Sep/2017
Manufacturer:	Speag		
Type/Model Number:	D1750V2		
Serial Number:	1077		
Calibration Date:	05/Oct/2017		
Calibrated By:	Chanthu Thevarajah Laboratory Engineer		

Signature:

.....  
All Calibration have been conducted in the closed laboratory facility: Lab Temperature (22±3) °C and humidity < 70%

This certificate is issued in accordance with the laboratory accreditation requirements of the United Kingdom Accreditation Service. It provides traceability of measurement to the SI system of units and/or to units of measurement realised at the National Physical Laboratory or other recognised national metrology institutes. This certificate may not be reproduced other than in full, except with the prior written approval of the issuing laboratory.

Use of the UKAS mark demonstrates that compliance with the requirements of BS/EN/ISO/IEC 17025 has been independently assessed.

# CERTIFICATE OF CALIBRATION

## ISSUED BY UL VS LTD

UKAS Accredited Calibration Laboratory No. 5248

CERTIFICATE  
NUMBER :  
11903941JD01B

Page 2 of 10

The calibration methods and procedures used were as detailed in:

1. **IEC 62209-1:2005**: Procedure to determine the specific absorption rate (SAR) for hand-held devices used in close proximity to the ear (frequency range of 300 MHz to 3 GHz)
2. **IEC 62209-2:2010**: Procedure to determine the specific absorption rate (SAR) for wireless communication devices used in close proximity to the human body (frequency range of 30 MHz to 6 GHz)
3. **IEEE 1528: 2013**: IEEE Recommended Practice for Determining the Peak Spatial-Average Specific Absorption Rate (SAR) in the Human Head from Wireless Communication Devices: Measurement Techniques
4. FCC KDB Publication Number: "KDB865664 D01 SAR Measurement 100 MHz to 6 GHz"
5. **SPEAG DASY4/ DASY5 System Handbook**

The measuring equipment used to perform the calibration, documented in this certificate has been calibrated in accordance with the manufacturers' recommendations, and is traceable to recognized national standards.

UL No.	Instrument	Manufacturer	Type No.	Serial No.	Date Last Calibrated	Cal. Interval (Months)
A2546	Data Acquisition Electronics	SPEAG	DAE4	1435	10 Feb 2017	12
A2587	Probe	SPEAG	ES3DV3	3341	14 Aug 2017	12
A1236	Dipole	SPEAG	D1800V2	2d009	09 Feb 2017	12
PRE0151451	Power Monitoring Kit	Art-Fi	ART 100850-01	0001	Cal as part of System	12
PRE0151441	Power Sensor	Rhode & Schwarz	NRP8S	102481	16 Nov 2016	12
M1015	Network Analyser	Agilent Technologies	8753ES	US39172406	26 Sept 2016	12
PRE0151154	Network Analyser	Rhode & Schwarz	ZND8	100151	22 Nov 2016	12
PRE0151877	Calibration Kit	Rhode & Schwarz	Z135	102947-Bt	02 Dec 2016	12
M1908	Signal Generator	Rhode & Schwarz	SMIQ 03B	1125.555.03	08 Nov 2016	12

# CERTIFICATE OF CALIBRATION

## ISSUED BY UL VS LTD

CERTIFICATE  
NUMBER :  
11903941JD01B

UKAS Accredited Calibration Laboratory No. 5248

Page 3 of 10

### SAR System Specification

Robot System Positioner:	Stäubli Unimation Corp. Robot Model: TX60L
Robot Serial Number:	F14/5T5ZA1/A/01
DASY Version:	DASY 52 (v52.8.8.1258)
Phantom:	Flat section of SAM Twin Phantom
Distance Dipole Centre:	10 mm (with spacer)
Frequency:	1750 MHz

### Dielectric Property Measurements – Head Simulating Liquid (HSL)

Simulant Liquid	Frequency (MHz)	Room Temp		Liquid Temp		Parameters	Target Value	Measured Value	Uncertainty (%)
		Start	End	Start	End				
Head	1750	23.0 °C	23.0 °C	20.0°C	20.0°C	$\epsilon_r$	40.10	40.38	± 5%
						$\sigma$	1.37	1.39	± 5%

### SAR Results – Head Simulating Liquid (HSL)

Simulant Liquid	SAR Measured	250 mW input Power	Normalised to 1.00 W	Uncertainty (%)
Head	SAR averaged over 1g	9.11 W/Kg	<b>36.26 W/Kg</b>	± 17.57%
	SAR averaged over 10g	4.86 W/Kg	<b>19.34 W/Kg</b>	± 17.32%

### Antenna Parameters – Head Simulating Liquid (HSL)

Simulant Liquid	Parameter	Measured Level	Uncertainty (%)
Head	Impedance	49.21 $\Omega$ -0.63 j $\Omega$	± 0.28 $\Omega$ ± 0.044 j $\Omega$
	Return Loss	-36.48	± dB

# CERTIFICATE OF CALIBRATION

## ISSUED BY UL VS LTD

CERTIFICATE  
NUMBER :  
11903941JD01B

UKAS Accredited Calibration Laboratory No. 5248

Page 4 of 10

### Dielectric Property Measurements – Body Simulating Liquid (MSL)

Simulant Liquid	Frequency (MHz)	Room Temp		Liquid Temp		Parameters	Target Value	Measured Value	Uncertainty (%)
		Start	End	Start	End				
Body	1750	22.0 °C	22.0 °C	22.0°C	22.0°C	$\epsilon_r$	53.40	52.41	± 5%
						$\sigma$	1.49	1.47	± 5%

### SAR Results – Body Simulating Liquid (MSL)

Simulant Liquid	SAR Measured	250 mW input Power	Normalised to 1.00 W	Uncertainty (%)
Body	SAR averaged over 1g	9.38 W/Kg	<b>37.34 W/Kg</b>	± 18.06%
	SAR averaged over 10g	5.02 W/Kg	<b>19.98 W/Kg</b>	± 17.44%

### Antenna Parameters – Body Simulating Liquid (MSL)

Simulant Liquid	Parameter	Measured Level	Uncertainty (%)
Body	Impedance	49.29 $\Omega$ 3.26 $j\Omega$	± 0.28 $\Omega$ ± 0.044 $j\Omega$
	Return Loss	-29.63	± 2.03 dB

# CERTIFICATE OF CALIBRATION

## ISSUED BY UL VS LTD

CERTIFICATE  
NUMBER :  
11903941JD01B

UKAS Accredited Calibration Laboratory No. 5248

Page 5 of 10

### DASY Validation Scan for Head Stimulating Liquid (HSL)

DUT: D1750V2 - SN1077; Type: D1750V2; Serial: SN1077

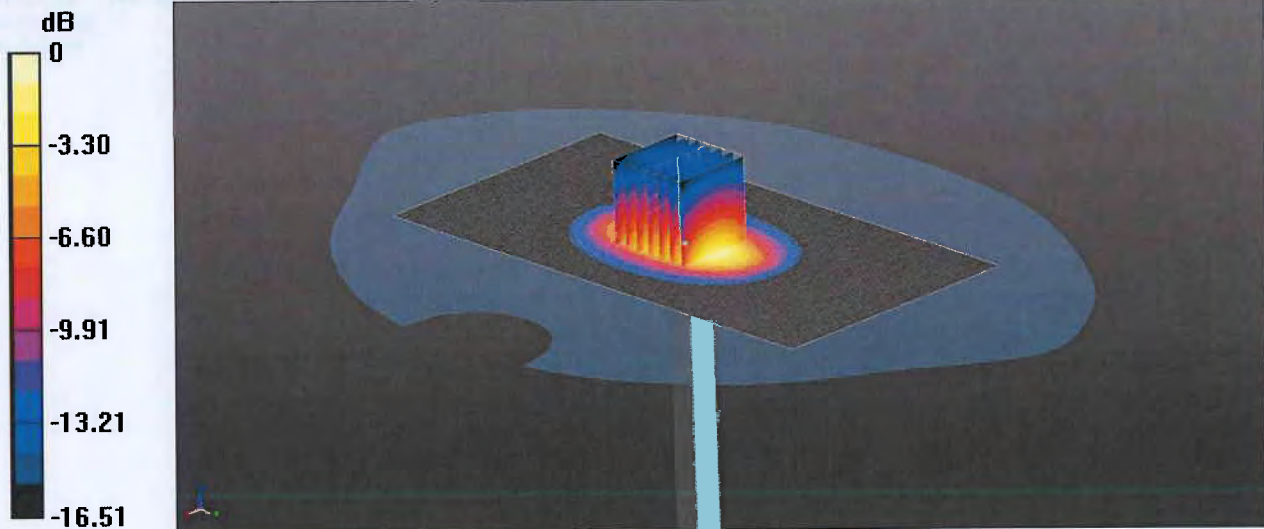

0 dB = 11.4 W/kg = 10.57 dBW/kg

Communication System: UID 0, CW (0); Frequency: 1750 MHz; Duty Cycle: 1:1

Medium: 1750 1800 MHz HSL Medium parameters used:  $f = 1750$  MHz;  $\sigma = 1.393$  S/m;  $\epsilon_r = 40.378$ ;  $\rho = 1000$  kg/m<sup>3</sup>

Phantom section: Flat Section

DASY4 Configuration:

- Probe: ES3DV3 - SN3341; ConvF(5.47, 5.47, 5.47); Calibrated: 14/08/2017;

- Sensor-Surface: 3mm (Mechanical Surface Detection)

- Electronics: DAE4 Sn1435; Calibrated: 10/02/2017

- Phantom: SAM (30deg probe tilt) with CRP v5.0; Type: QD000P40CD; Serial: TP:xxxx

-; SEMCAD X Version 14.6.10 (7372)

**Configuration/d=10mm, Pin=250mW 2/Area Scan (81x151x1):** Interpolated grid: dx=1.200 mm, dy=1.200 mm

Maximum value of SAR (interpolated) = 11.7 W/kg

**Configuration/d=10mm, Pin=250mW 2/Zoom Scan (5x5x7) (7x7x7)/Cube 0:** Measurement grid: dx=5mm, dy=5mm, dz=5mm

Reference Value = 93.81 V/m; Power Drift = -0.04 dB

Peak SAR (extrapolated) = 16.3 W/kg

**SAR(1 g) = 9.11 W/kg; SAR(10 g) = 4.86 W/kg**

Maximum value of SAR (measured) = 11.4 W/kg

# CERTIFICATE OF CALIBRATION

## ISSUED BY UL VS LTD

UKAS Accredited Calibration Laboratory No. 5248

CERTIFICATE  
NUMBER :  
11903941JD01B

Page 6 of 10

### Impedance Measurement Plot for Head Stimulating Liquid (HSL)

10/10/2017 9:09:15 AM  
1326.5170K92-100151-MV

Trc1 — S11 Smith 200 mU/ Ref 1 U Cal Smo

1

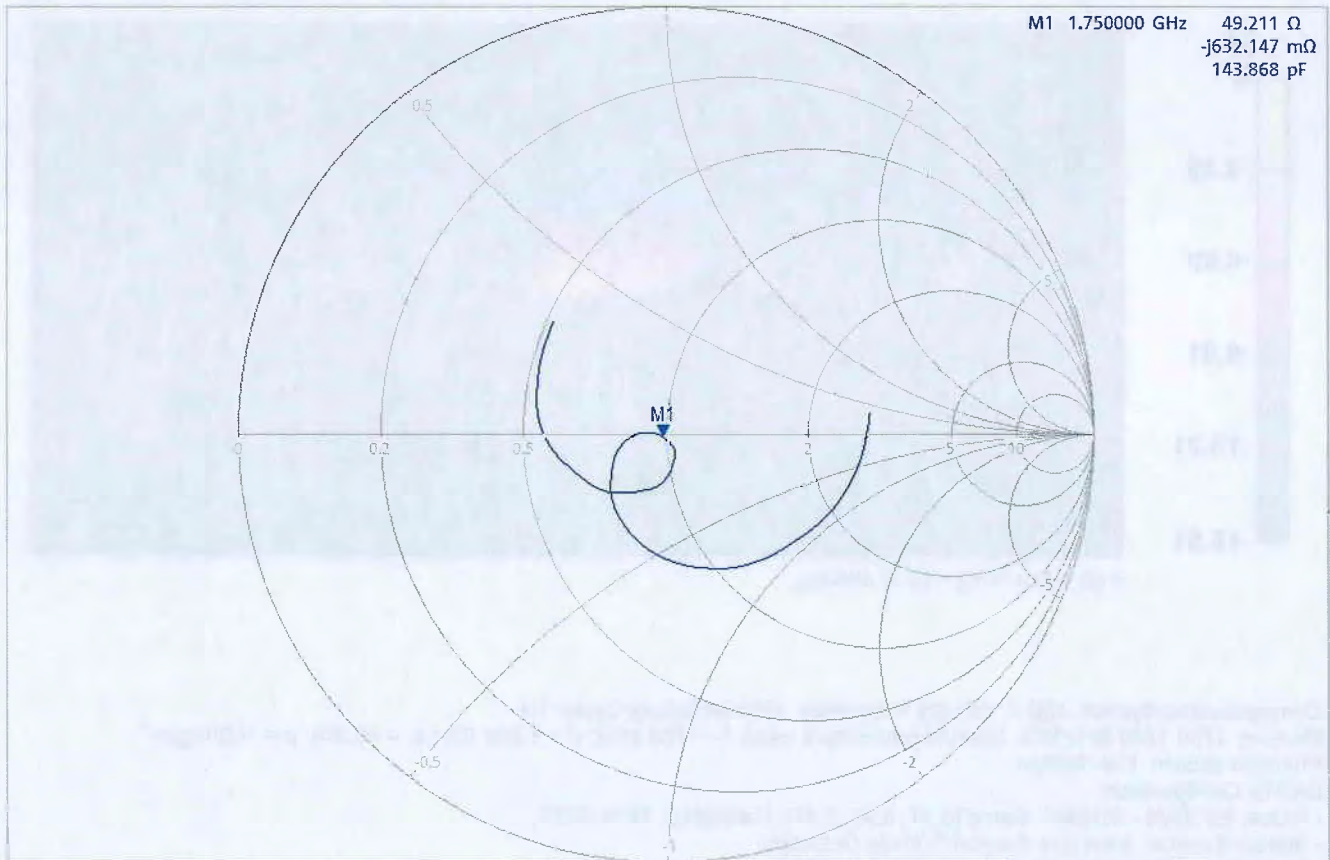

Ch1 Start 1.55 GHz

Pwr -10 dBm Bw 10 kHz

Stop 1.95 GHz

# CERTIFICATE OF CALIBRATION

## ISSUED BY UL VS LTD

UKAS Accredited Calibration Laboratory No. 5248

CERTIFICATE  
NUMBER :  
11903941JD01B

Page 7 of 10

### Return Loss Measurement Plot for Head Stimulating Liquid (HSL)

10/10/2017 9:08:41 AM  
1326.5170K92-100151-MV

Trc1 — 511 dB Mag 5 dB/ Ref -20 dB Cal Smo

1

M1 1.750000 GHz -36.4801 dB  
M2 1.712060 GHz -20.0036 dB  
• M3 1.807880 GHz -20.0071 dB

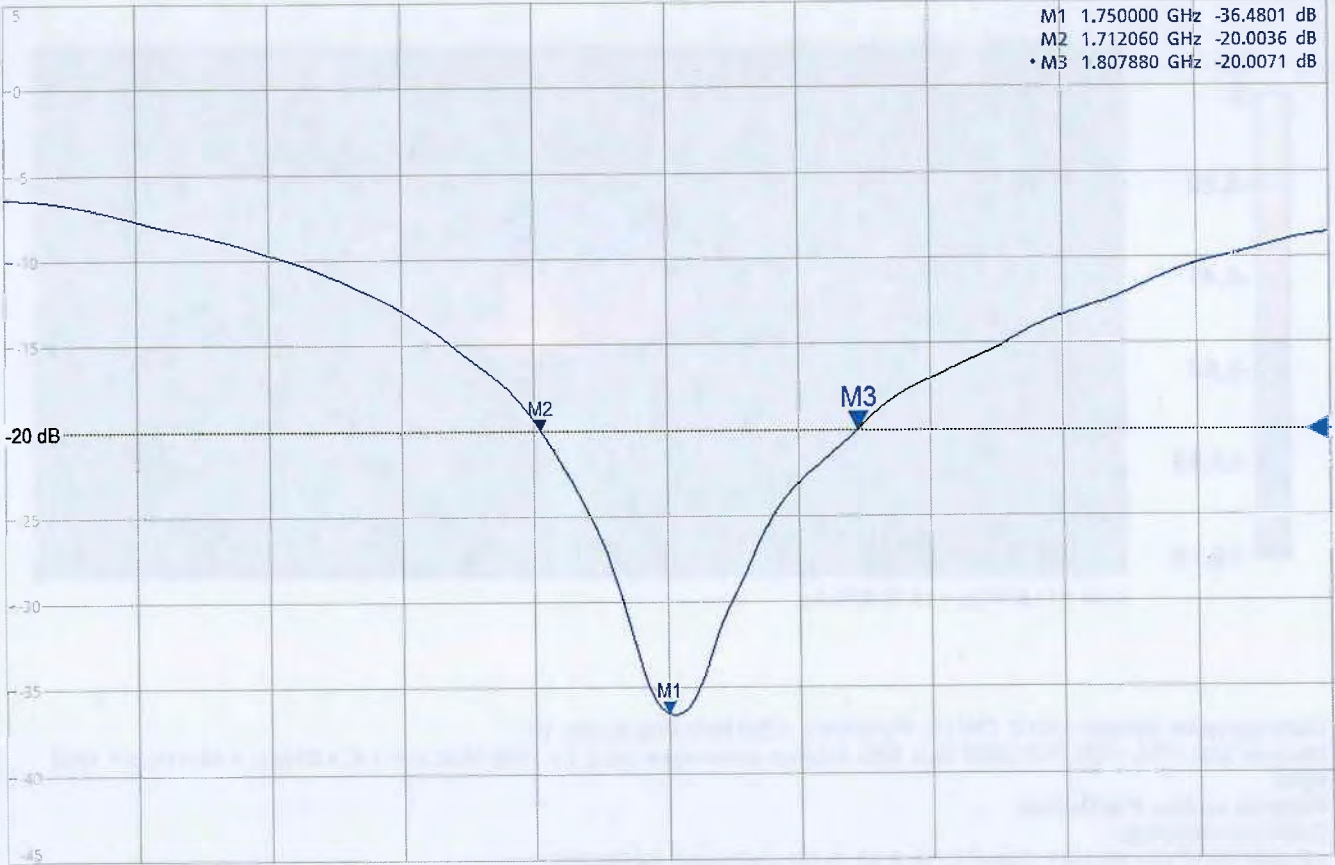

Ch1 Start 1.55 GHz

Pwr -10 dBm Bw 10 kHz

Stop 1.95 GHz



# CERTIFICATE OF CALIBRATION

## ISSUED BY UL VS LTD

CERTIFICATE  
NUMBER :  
11903941JD01B

UKAS Accredited Calibration Laboratory No. 5248

Page 8 of 10

### DASY Validation Scan for Body Stimulating Liquid (MSL)

DUT: D1750V2 - SN1077; Type: D1750V2; Serial: SN1077

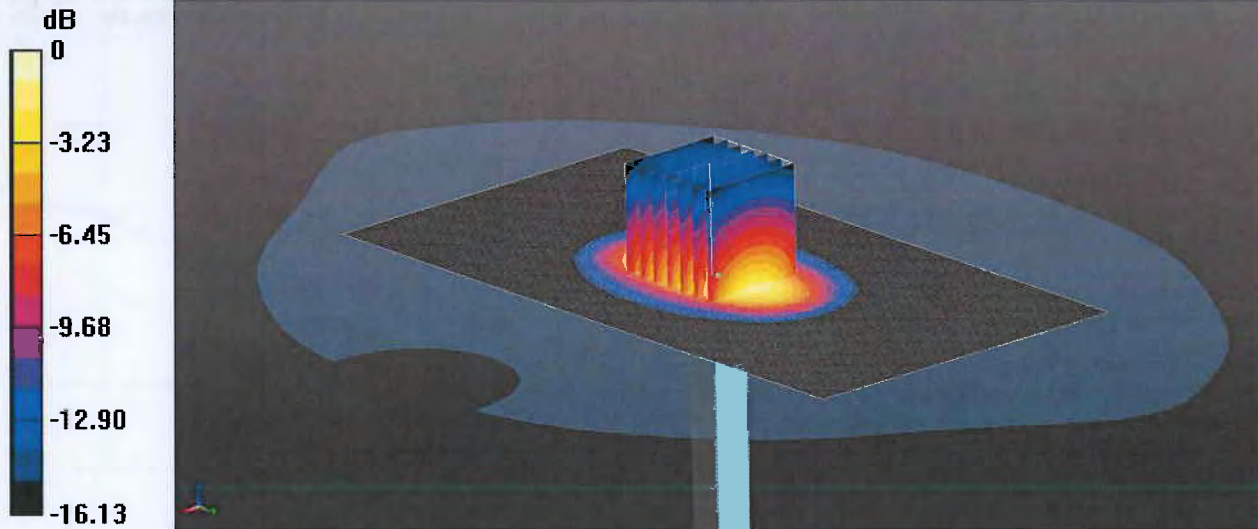

0 dB = 11.8 W/kg = 10.72 dBW/kg

Communication System: UID 0, CW (0); Frequency: 1750 MHz; Duty Cycle: 1:1

Medium: 900,1750,1800,1900,2600 MHz MSL Medium parameters used:  $f = 1750$  MHz;  $\sigma = 1.474$  S/m;  $\epsilon_r = 52.411$ ;  $\rho = 1000$  kg/m<sup>3</sup>

Phantom section: Flat Section

DASY4 Configuration:

- Probe: ES3DV3 - SN3341; ConvF(5.12, 5.12, 5.12); Calibrated: 14/08/2017;
- Sensor-Surface: 3mm (Mechanical Surface Detection)
- Electronics: DAE4 Sn1435; Calibrated: 10/02/2017
- Phantom: SAM (30deg probe tilt) with CRP v5.0; Type: QD000P40CD; Serial: TP:xxxx
- ; SEMCAD X Version 14.6.10 (7372)

**Configuration/d=10mm, Pin=250mW 2 2 2 /Area Scan (81x151x1):** Interpolated grid: dx=1.200 mm, dy=1.200 mm

Maximum value of SAR (interpolated) = 12.1 W/kg

**Configuration/d=10mm, Pin=250mW 2 2 2 /Zoom Scan (5x5x7) (7x7x7)/Cube 0:** Measurement grid: dx=5mm, dy=5mm, dz=5mm

Reference Value = 92.81 V/m; Power Drift = 0.01 dB

Peak SAR (extrapolated) = 16.5 W/kg

**SAR(1 g) = 9.38 W/kg; SAR(10 g) = 5.02 W/kg**

Maximum value of SAR (measured) = 11.8 W/kg

# CERTIFICATE OF CALIBRATION

## ISSUED BY UL VS LTD

CERTIFICATE  
NUMBER :  
11903941JD01B

UKAS Accredited Calibration Laboratory No. 5248

Page 9 of 10

### Impedance Measurement Plot for Body Stimulating Liquid (MSL)

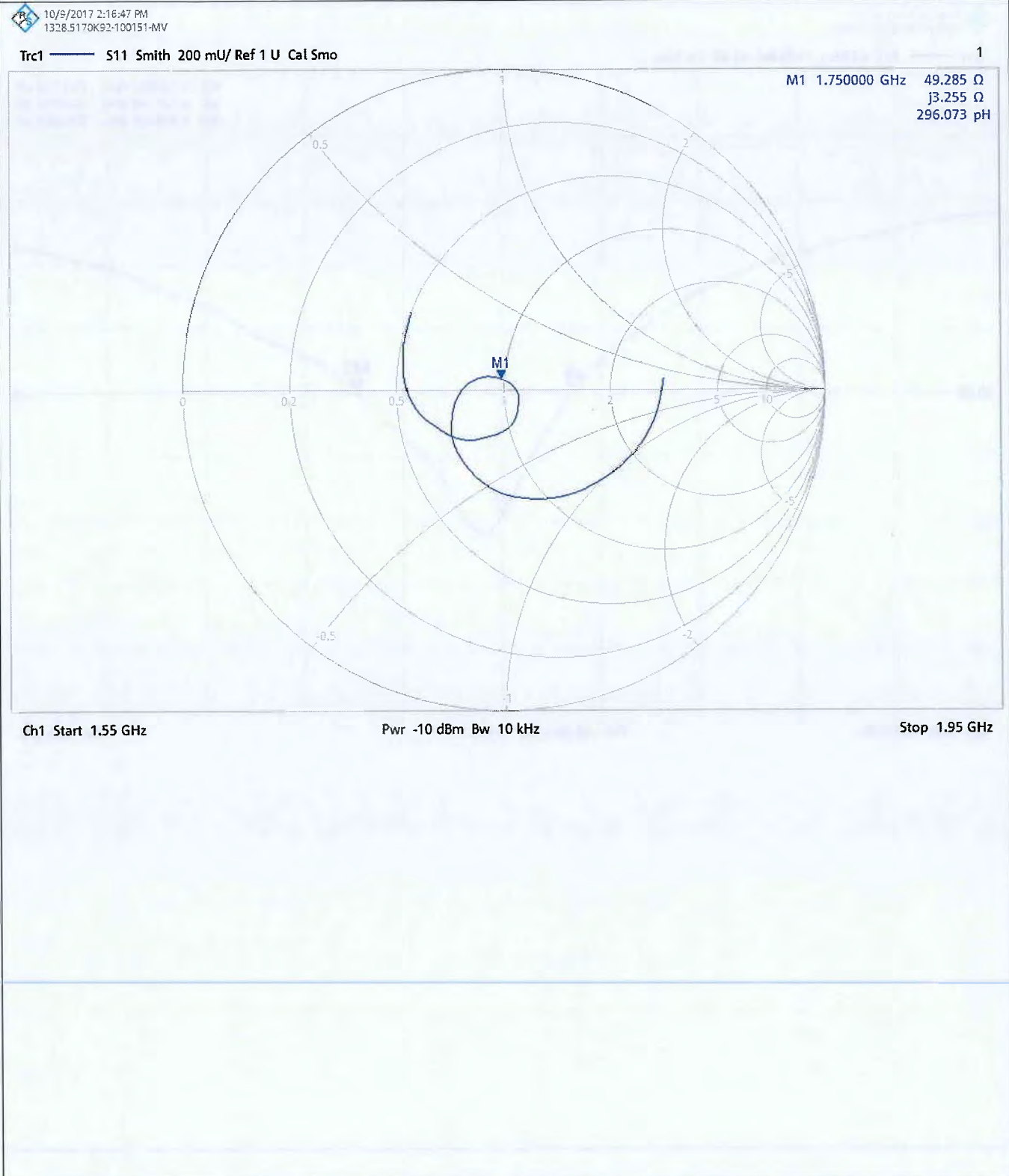

# CERTIFICATE OF CALIBRATION

## ISSUED BY UL VS LTD

UKAS Accredited Calibration Laboratory No. 5248

CERTIFICATE  
NUMBER :  
11903941JD01B

Page 10 of 10

### Return Loss Measurement Plot for Body Stimulating Liquid (MSL)



10/9/2017 2:15:13 PM  
1326.5170K92-100151-MV

Trc1 — S11 dB Mag 5 dB/Ref -20 dB Cal Smo

1

M1 1.750000 GHz -29.6316 dB  
M2 1.721140 GHz -20.0051 dB  
• M3 1.808980 GHz -20.0057 dB

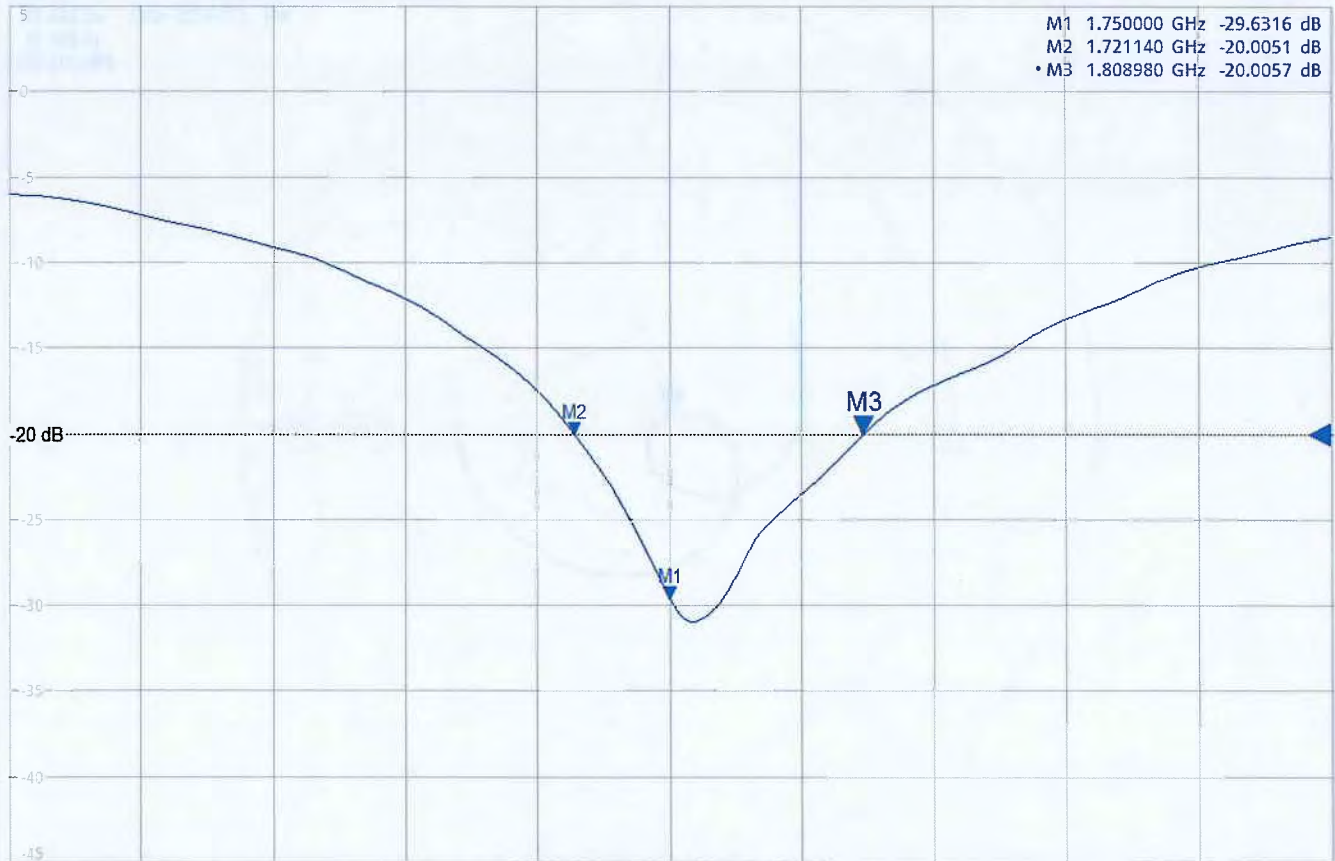

Ch1 Start 1.55 GHz

Pwr -10 dBm Bw 10 kHz

Stop 1.95 GHz

**Calibration Certificate Label:**

	<p><b>UL VS LTD - Tel: +44 (0) 1256312000</b></p> <p>Certificate Number: 11903941JD01B</p> <p>Instrument ID: 1077</p> <p>Calibration Date: 05/Oct/2017</p> <p>Calibration Due Date:</p>
---	---

	<p><b>UL VS LTD - Tel: +44 (0) 1256312000</b></p> <p>Certificate Number: 11903941JD01B</p> <p>Instrument ID: 1077</p> <p>Calibration Date: 05/Oct/2017</p> <p>Calibration Due Date:</p>
---	---

	<p><b>UL VS LTD - Tel: +44 (0) 1256312000</b></p> <p>Certificate Number: 11903941JD01B</p> <p>Instrument ID: 1077</p> <p>Calibration Date: 05/Oct/2017</p> <p>Calibration Due Date:</p>
--	---



# CERTIFICATE OF CALIBRATION

ISSUED BY **UL VS LTD**

DATE OF ISSUE: 16/Oct/2018

CERTIFICATE NUMBER : 12134285JD01B



**5248**

UL VS LTD  
UNIT 1 HORIZON  
KINGSLAND PARK, WADE ROAD  
BASINGSTOKE, HAMPSHIRE  
RG24 8AH, UK  
TEL: +44 (0) 1256 312000  
FAX: +44 (0) 1256 312001  
Email: LST.UK.Calibration@ul.com



Page 1 of 10

**APPROVED SIGNATORY**

.....  
Naseer Mirza

**Customer :**

UL VS Inc  
47173 Benicia Street  
Fremont, CA 94538, USA

**Equipment Details:**

Description:	Dipole Validation Kit	Date of Receipt:	08/Oct/2018
Manufacturer:	SPEAG		
Type/Model Number:	D1750V2		
Serial Number:	1077		
Calibration Date:	16/Oct/2018		
Calibrated By:	Chanthu Thevarajah Senior Engineer		

Signature:

.....

All Calibration have been conducted in the closed laboratory facility: Lab Temperature (22±3) °C and humidity < 70%

This certificate is issued in accordance with the laboratory accreditation requirements of the United Kingdom Accreditation Service. It provides traceability of measurement to the SI system of units and/or to units of measurement realised at the National Physical Laboratory or other recognised national metrology institutes. This certificate may not be reproduced other than in full, except with the prior written approval of the issuing laboratory.

Use of the UKAS mark demonstrates that compliance with the requirements of BS/EN/ISO/IEC 17025 has been independently assessed.

# CERTIFICATE OF CALIBRATION

## ISSUED BY UL VS LTD

UKAS Accredited Calibration Laboratory No. 5248

CERTIFICATE  
NUMBER :  
12134285JD01B

Page 2 of 10

The calibration methods and procedures used were as detailed in:

1. **IEC 62209-1:2016:** Procedure to determine the specific absorption rate (SAR) for hand-held devices used in close proximity to the ear (frequency range of 300 MHz to 3 GHz)
2. **IEC 62209-2:2010:** Procedure to determine the specific absorption rate (SAR) for wireless communication devices used in close proximity to the human body (frequency range of 30 MHz to 6 GHz)
3. **IEEE 1528: 2013:** IEEE Recommended Practice for Determining the Peak Spatial-Average Specific Absorption Rate (SAR) in the Human Head from Wireless Communication Devices: Measurement Techniques
4. FCC KDB Publication Number: “**KDB865664 D01 SAR Measurement 100 MHz to 6 GHz**”
5. **SPEAG DASY4/ DASY5 System Handbook**

The measuring equipment used to perform the calibration, documented in this certificate has been calibrated in accordance with the manufacturers' recommendations, and is traceable to recognized national standards.

UL No.	Instrument	Manufacturer	Type No.	Serial No.	Date Last Calibrated	Cal. Interval (Months)
PRE0178318	Data Acquisition Electronics	SPEAG	DAE4	1543	08 Mar 2018	12
PRE0178315	Probe	SPEAG	ES3DV3	3360	17 Aug 2018	12
A1236	Dipole	SPEAG	D1800V2	2d009	06 Feb 2018	12
PRE0151451	Power Monitoring Kit	Art-Fi	ART 100850-01	0001	Cal as part of System	12
PRE0151441	Power Sensor	Rhode & Schwarz	NRP8S	102481	05 Feb 2018	12
PRE0151154	Network Analyser	Rhode & Schwarz	ZND8	100151	14 Dec 2017	12
PRE0151877	Calibration Kit	Rhode & Schwarz	ZV-Z135	102947-Bt	27 Apr 2018	12
PRE0178154	Signal Generator	Rhode & Schwarz	SMB 100A	175325	09 Apr 2018	12

# CERTIFICATE OF CALIBRATION ISSUED BY **UL VS LTD**

UKAS Accredited Calibration Laboratory No. 5248

CERTIFICATE  
NUMBER :  
12134285JD01B

Page 3 of 10

## SAR System Specification

<b>Robot System Positioner:</b>	Stäubli Unimation Corp. Robot Model: TX60L
<b>Robot Serial Number:</b>	F17/5ENYG1/A/01
<b>DASY Version:</b>	DASY 52 (v52.8.8.1258)
<b>Phantom:</b>	Flat section of SAM Twin Phantom
<b>Distance Dipole Centre:</b>	10 mm (with spacer)
<b>Frequency:</b>	1750 MHz

## Dielectric Property Measurements – Head Simulating Liquid (HSL)

Simulant Liquid	Frequency (MHz)	Room Temp		Liquid Temp		Parameters	Target Value	Measured Value	Uncertainty (%)
		Start	End	Start	End				
Head	1750	22.2 °C	22.5 °C	22.0°C	22.0°C	$\epsilon_r$	40.10	39.65	± 5%
						$\sigma$	1.37	1.40	± 5%

## SAR Results – Head Simulating Liquid (HSL)

Simulant Liquid	SAR Measured	250 mW input Power	Normalised to 1.00 W	Uncertainty (%)
Head	SAR averaged over 1g	9.72 W/Kg	<b>38.69 W/Kg</b>	± 17.57%
	SAR averaged over 10g	5.14 W/Kg	<b>20.46 W/Kg</b>	± 17.32%

## Antenna Parameters – Head Simulating Liquid (HSL)

Simulant Liquid	Parameter	Measured Level	Uncertainty (%)
Head	Impedance	50.453 $\Omega$ -1.52 $j\Omega$	± 0.28 $\Omega$ ± 0.044 $j\Omega$
	Return Loss	36.26	± 2.03 dB



# CERTIFICATE OF CALIBRATION

## ISSUED BY UL VS LTD

UKAS Accredited Calibration Laboratory No. 5248

CERTIFICATE  
NUMBER :  
12134285JD01B

Page 4 of 10

### Dielectric Property Measurements – Body Simulating Liquid (MSL)

Simulant Liquid	Frequency (MHz)	Room Temp		Liquid Temp		Parameters	Target Value	Measured Value	Uncertainty (%)
		Start	End	Start	End				
Body	1750	20.0 °C	21.0 °C	19.9°C	20.2°C	$\epsilon_r$	53.40	53.30	± 5%
						$\sigma$	1.49	1.47	± 5%

### SAR Results – Body Simulating Liquid (MSL)

Simulant Liquid	SAR Measured	250 mW input Power	Normalised to 1.00 W	Uncertainty (%)
Body	SAR averaged over 1g	9.87 W/Kg	<b>39.29 W/Kg</b>	± 18.06%
	SAR averaged over 10g	5.29 W/Kg	<b>21.05 W/Kg</b>	± 17.44%

### Antenna Parameters – Body Simulating Liquid (MSL)

Simulant Liquid	Parameter	Measured Level	Uncertainty (%)
Body	Impedance	49.46 $\Omega$ 4.07 j $\Omega$	± 0.28 $\Omega$ ± 0.044 j $\Omega$
	Return Loss	27.66	± 2.03 dB

# CERTIFICATE OF CALIBRATION

## ISSUED BY UL VS LTD

UKAS Accredited Calibration Laboratory No. 5248

CERTIFICATE  
NUMBER :  
12134285JD01B

Page 5 of 10

### DASY Validation Scan for Head Stimulating Liquid (HSL)

DUT: D1750V2 - SN1077; Type: D1750V2; Serial: SN1077

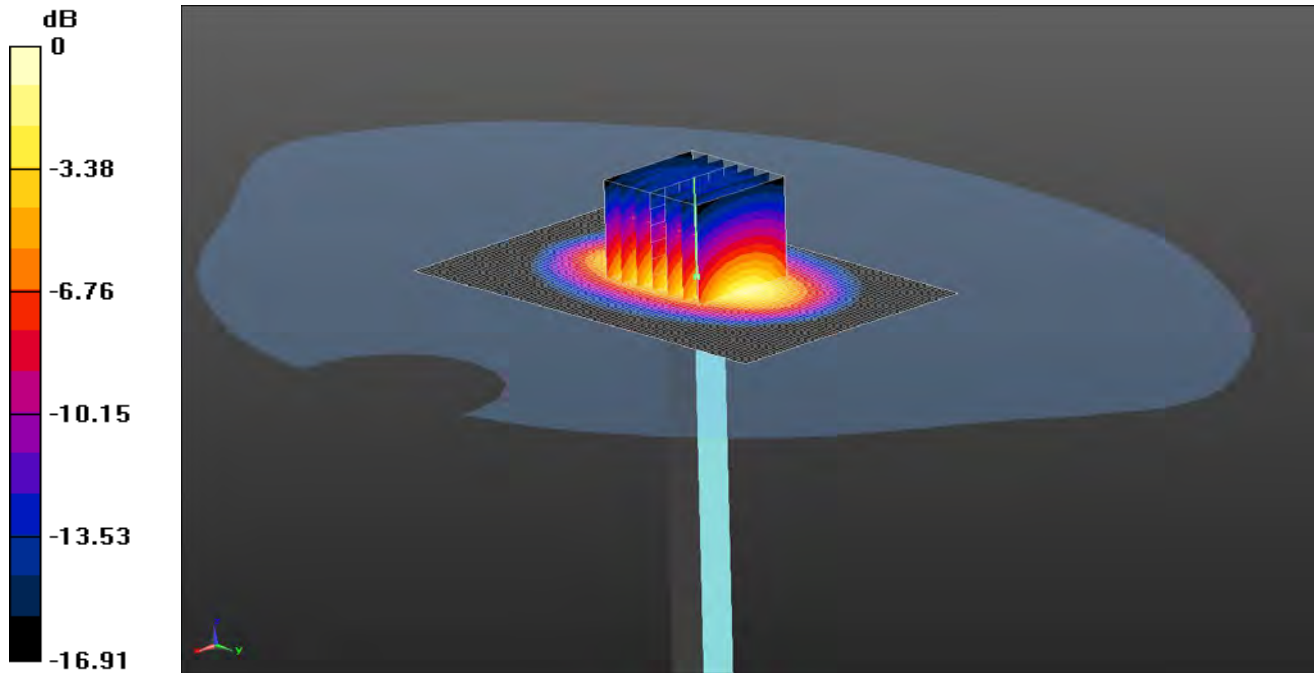

0 dB = 12.4 W/kg = 10.93 dBW/kg

Communication System: UID 0, CW (0); Frequency: 1750 MHz; Duty Cycle: 1:1

Medium: 900, 1750, 1800, 2600 5% MHz HSL Medium parameters used:  $f = 1750$  MHz;  $\sigma = 1.399$  S/m;  $\epsilon_r = 39.653$ ;  $\rho = 1000$  kg/m<sup>3</sup>

Phantom section: Flat Section

DASY4 Configuration:

- Probe: ES3DV3 - SN3360; ConvF(5.27, 5.27, 5.27); Calibrated: 17/08/2018;

- Sensor-Surface: 3mm (Mechanical Surface Detection)

- Electronics: DAE4 Sn1543; Calibrated: 08/03/2018

- Phantom: Twin SAM A (Site 65); Type: SAM 8.0; Serial: TP:1945

- ; SEMCAD X Version 14.6.10 (7417)

**SAR/d=10mm, Pin=50 mW 2/Area Scan (61x91x1):** Interpolated grid: dx=1.200 mm, dy=1.200 mm

Maximum value of SAR (interpolated) = 12.4 W/kg

**SAR/d=10mm, Pin=50 mW 2/Zoom Scan 2 2 (7x7x7)/Cube 0:** Measurement grid: dx=5mm, dy=5mm, dz=5mm

Reference Value = 97.18 V/m; Power Drift = -0.00 dB

Peak SAR (extrapolated) = 17.8 W/kg

**SAR(1 g) = 9.72 W/kg; SAR(10 g) = 5.14 W/kg**

Maximum value of SAR (measured) = 12.4 W/kg

# CERTIFICATE OF CALIBRATION

## ISSUED BY UL VS LTD

CERTIFICATE  
NUMBER :  
12134285JD01B

UKAS Accredited Calibration Laboratory No. 5248

Page 6 of 10

### Impedance Measurement Plot for Head Stimulating Liquid (HSL)

10/12/2018 10:56:31 AM  
1328.5170K92-100151-MV

Trc1 — S11 Smith 200 mU/ Ref 1 U Cal

1

M1 1.750000 GHz 50.453 Ω  
-j1.521 Ω  
59.778 pF

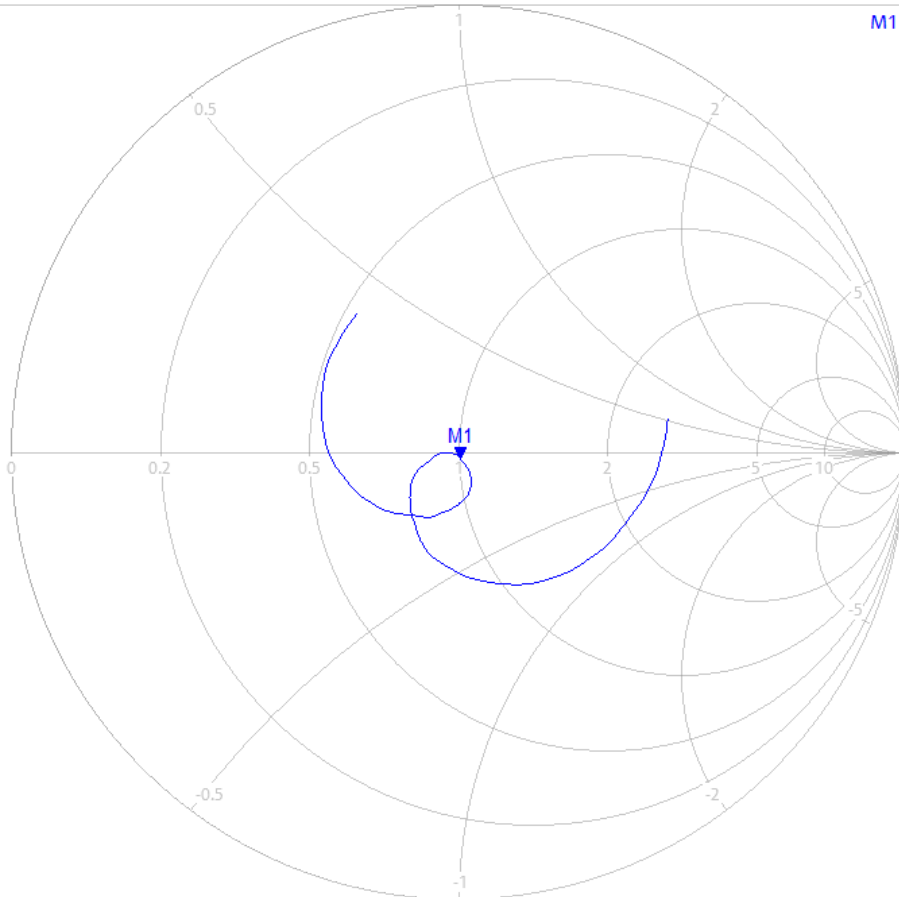

Ch1 Center 1.75 GHz

Pwr -10 dBm Bw 10 kHz

Span 400 MHz

# CERTIFICATE OF CALIBRATION

## ISSUED BY UL VS LTD

UKAS Accredited Calibration Laboratory No. 5248

CERTIFICATE  
NUMBER :  
12134285JD01B

Page 7 of 10

### Return Loss Measurement Plot for Head Stimulating Liquid (HSL)

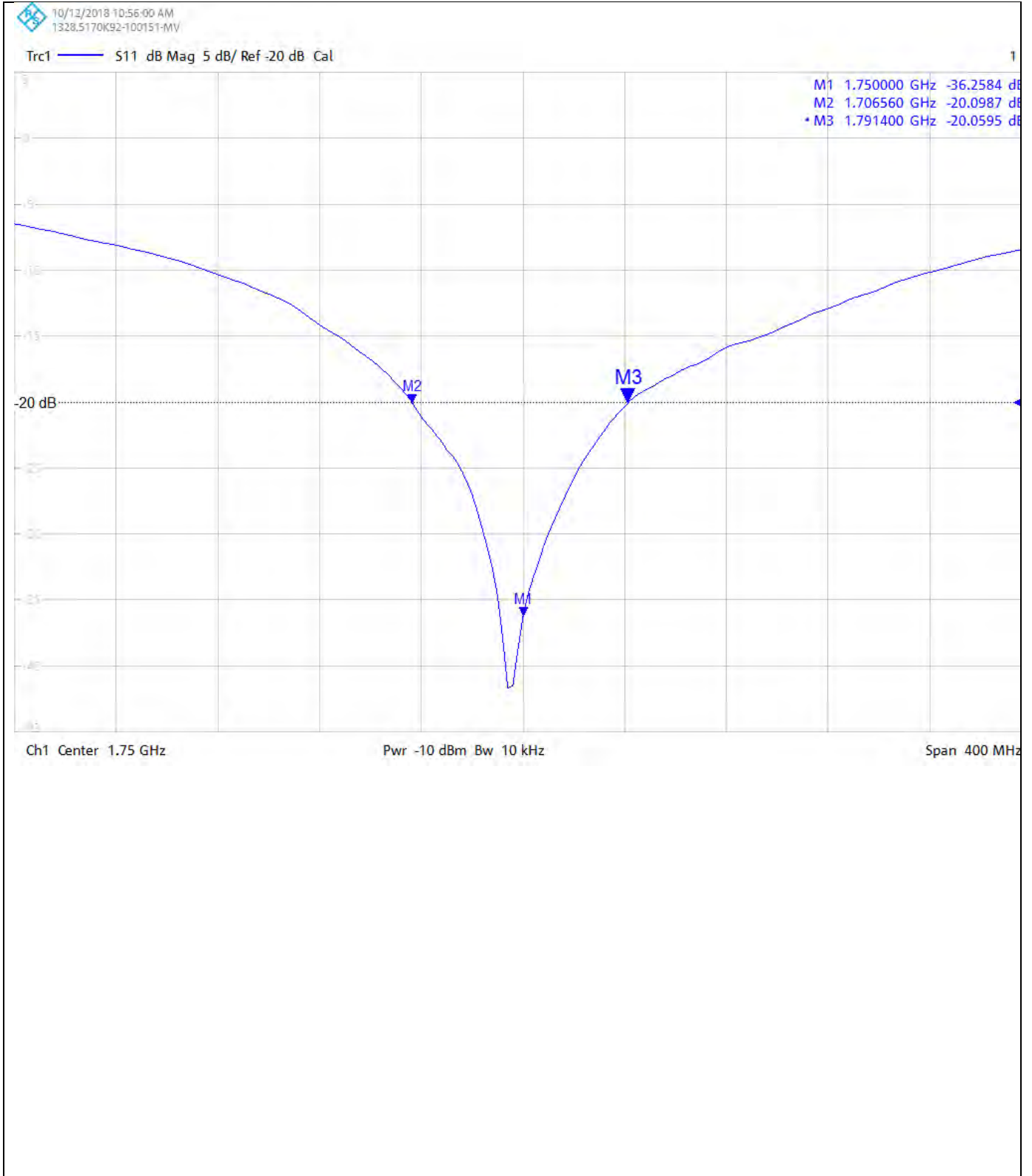

# CERTIFICATE OF CALIBRATION

## ISSUED BY UL VS LTD

CERTIFICATE  
NUMBER :  
12134285JD01B

UKAS Accredited Calibration Laboratory No. 5248

Page 8 of 10

### DASY Validation Scan for Body Stimulating Liquid (MSL)

DUT: D1750V2 - SN1077; Type: D1750V2; Serial: SN1077

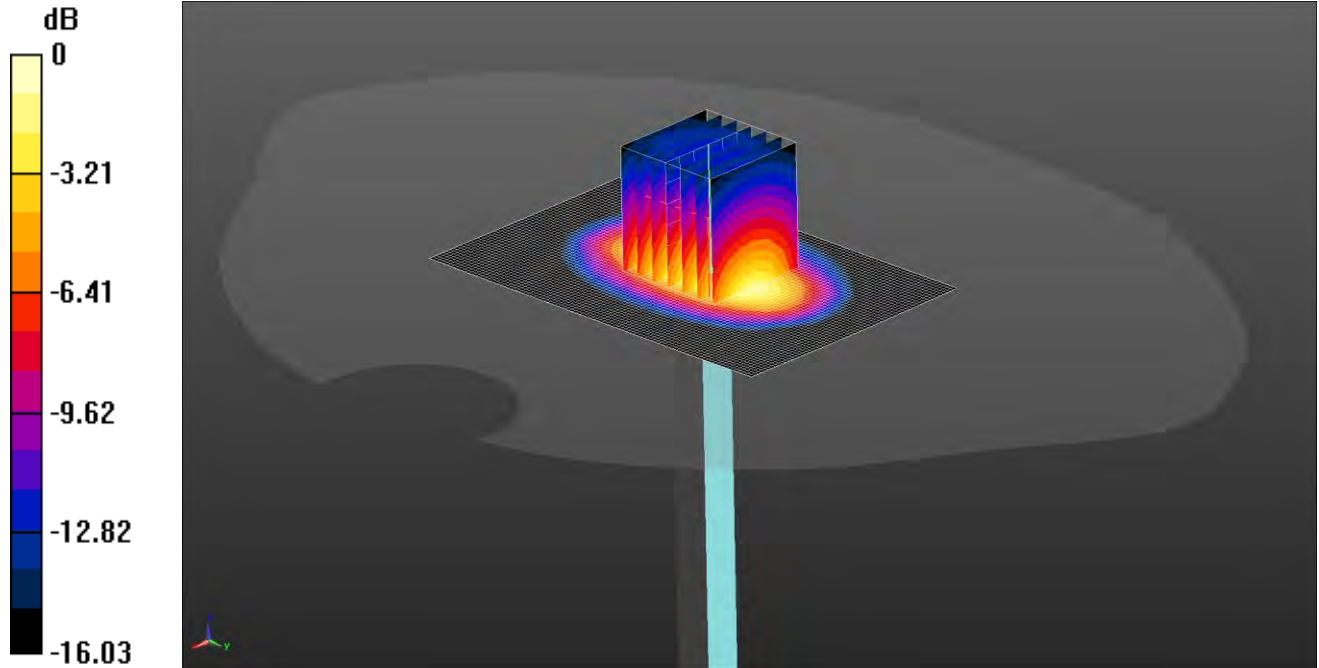

0 dB = 12.5 W/kg = 10.97 dBW/kg

Communication System: UID 0, CW (0); Frequency: 1750 MHz; Duty Cycle: 1:1  
Medium: 900, 1750, 1800, 1900 5% MHz MSL Medium parameters used:  $f = 1750$  MHz;  $\sigma = 1.477$  S/m;  $\epsilon_r = 53.299$ ;  $\rho = 1000$  kg/m<sup>3</sup>

Phantom section: Flat Section

DASY4 Configuration:

- Probe: ES3DV3 - SN3360; ConvF(4.92, 4.92, 4.92); Calibrated: 17/08/2018;
- Sensor-Surface: 3mm (Mechanical Surface Detection)
- Electronics: DAE4 Sn1543; Calibrated: 08/03/2018
- Phantom: Twin SAM A (Site 65); Type: SAM 5.0; Serial: TP:1836
- ; SEMCAD X Version 14.6.10 (7417)

**SAR/d=10mm, Pin=50 mW 2 2 /Area Scan (61x91x1):** Interpolated grid: dx=1.200 mm, dy=1.200 mm

Maximum value of SAR (interpolated) = 13.0 W/kg

**SAR/d=10mm, Pin=50 mW 2 2 /Zoom Scan 2 2 (7x7x7)/Cube 0:** Measurement grid: dx=5mm, dy=5mm, dz=5mm

Reference Value = 94.90 V/m; Power Drift = 0.00 dB

Peak SAR (extrapolated) = 17.5 W/kg

**SAR(1 g) = 9.87 W/kg; SAR(10 g) = 5.29 W/kg**

Maximum value of SAR (measured) = 12.5 W/kg

# CERTIFICATE OF CALIBRATION

## ISSUED BY UL VS LTD

CERTIFICATE  
NUMBER :  
12134285JD01B

UKAS Accredited Calibration Laboratory No. 5248

Page 9 of 10

### Impedance Measurement Plot for Body Stimulating Liquid (MSL)

10/15/2018 2:17:54 PM  
1328.5170K92-100151-MV

Trc1 — S11 Smith 200 mU/ Ref 1 U Cal

1

M1 1.750000 GHz 49.460  $\Omega$   
j4.073  $\Omega$   
370.398 pF

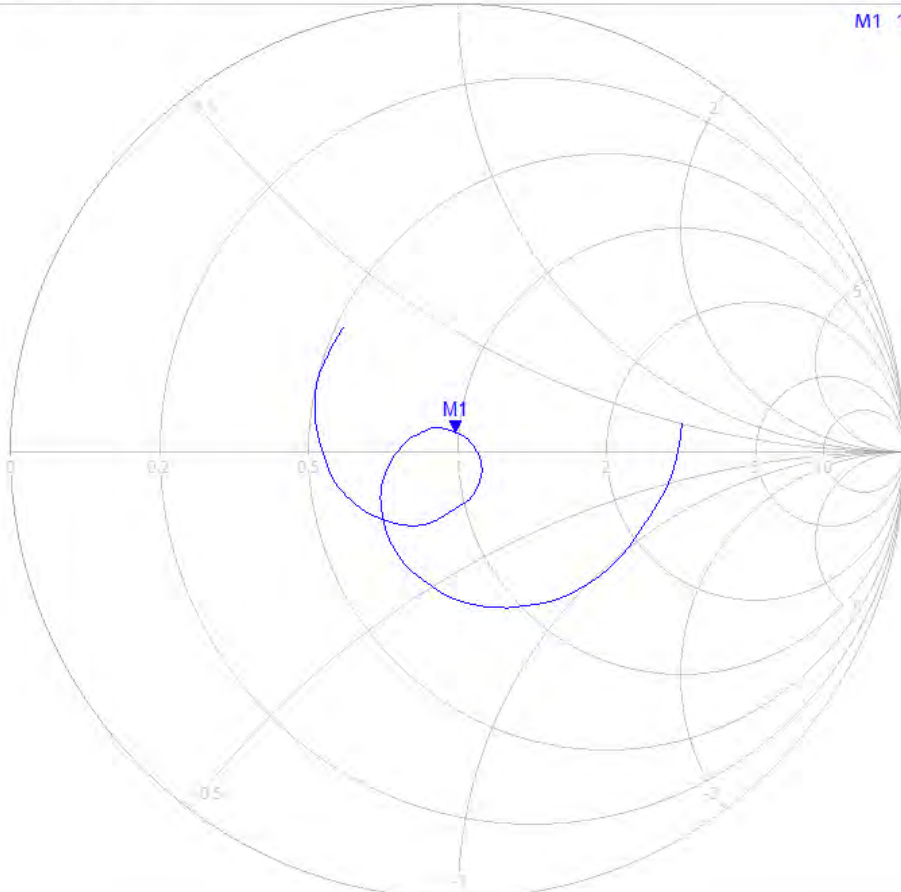

Ch1 Center 1.75 GHz

Pwr -10 dBm Bw 10 kHz

Span 400 MHz

# CERTIFICATE OF CALIBRATION

## ISSUED BY UL VS LTD

UKAS Accredited Calibration Laboratory No. 5248

CERTIFICATE  
NUMBER :  
12134285JD01B

Page 10 of 10

### Return Loss Measurement Plot for Body Stimulating Liquid (MSL)

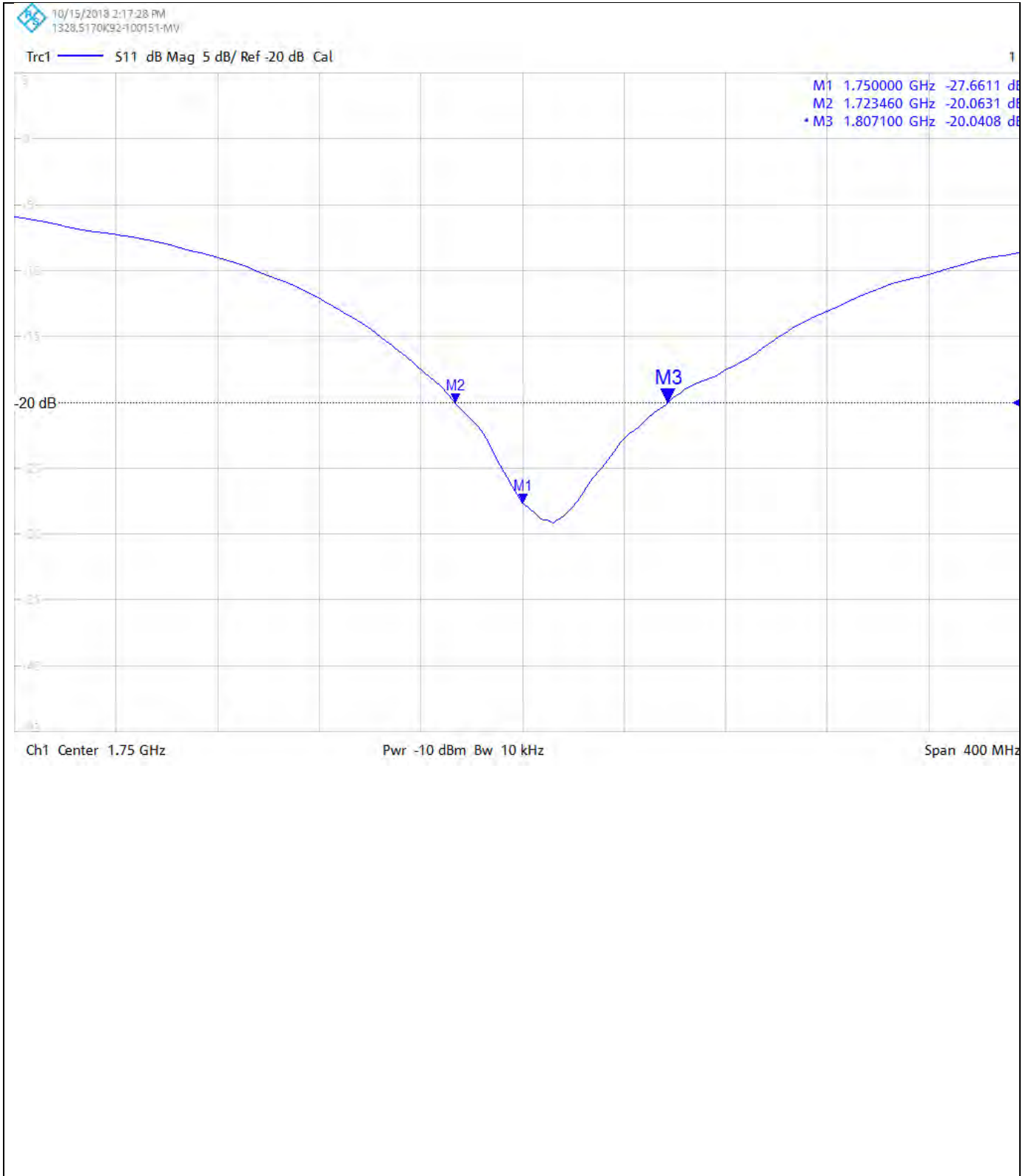

**Calibration Certificate Label:**

 <p>UKAS CALIBRATION 5248</p>	<p><b>UL VS LTD - Tel: +44 (0) 1256312000</b></p> <p>Certificate Number: 12134285JD01B</p> <p>Instrument ID: 1077</p> <p>Calibration Date: 16/Oct/2018</p> <p>Calibration Due Date:</p>
--	---

 <p>UKAS CALIBRATION 5248</p>	<p><b>UL VS LTD - Tel: +44 (0) 1256312000</b></p> <p>Certificate Number: 12134285JD01B</p> <p>Instrument ID: 1077</p> <p>Calibration Date: 16/Oct/2018</p> <p>Calibration Due Date:</p>
--	---

 <p>UKAS CALIBRATION 5248</p>	<p><b>UL VS LTD - Tel: +44 (0) 1256312000</b></p> <p>Certificate Number: 12134285JD01B</p> <p>Instrument ID: 1077</p> <p>Calibration Date: 16/Oct/2018</p> <p>Calibration Due Date:</p>
--	---