



# TEST REPORT

**Test Report No. : UL-RPT-RP11159630JD04A V4.0**

**Manufacturer** : Datecs Ltd  
**Model No.** : LineaTab mini (InfineaTab mini)  
**FCC ID** : YRWITBM  
**Technology** : RFID – 13.56 MHz  
**Test Standard(s)** : FCC Parts 15.207,15.209(a) & 15.225

1. This test report shall not be reproduced in full or partial, without the written approval of UL VS LTD.
2. The results in this report apply only to the sample(s) tested.
3. The sample tested is in compliance with the above standard(s).
4. The test results in this report are traceable to the national or international standards.
5. Version 4.0 supersedes all previous versions.

**Date of Issue:** 22 February 2018

**Checked by:**

Ian Watch  
Senior Engineer, Radio Laboratory

**Company Signatory:**

Sarah Williams  
Senior Engineer, Radio Laboratory  
UL VS LTD



This laboratory is accredited by UKAS.  
The tests reported herein have been  
performed in accordance with its terms  
of accreditation.

---

## UL VS LTD

Pavilion A, Ashwood Park, Ashwood Way, Basingstoke, Hampshire, RG23 8BG, UK  
Telephone: +44 (0)1256 312000  
Facsimile: +44 (0)1256 312001

This page has been left intentionally blank.

**Table of Contents**

<b>1. Customer Information.....</b>	<b>4</b>
<b>2. Summary of Testing.....</b>	<b>5</b>
2.1. General Information	5
2.2. Summary of Test Results	5
2.3. Methods and Procedures	5
2.4. Deviations from the Test Specification	5
<b>3. Equipment Under Test (EUT) .....</b>	<b>6</b>
3.1. Identification of Equipment Under Test (EUT)	6
3.2. Description of EUT	6
3.3. Modifications Incorporated in the EUT	6
3.4. Additional Information Related to Testing	7
3.5. Support Equipment	8
<b>4. Operation and Monitoring of the EUT during Testing .....</b>	<b>9</b>
4.1. Operating Modes	9
4.2. Configuration and Peripherals	9
<b>5. Measurements, Examinations and Derived Results.....</b>	<b>10</b>
5.1. General Comments	10
5.2. Test Results	11
5.2.1. Transmitter AC Conducted Spurious Emissions	11
5.2.2. Transmitter Fundamental Field Strength	18
5.2.3. Transmitter Radiated Spurious Emissions	23
5.2.4. Transmitter Band Edge Radiated Emissions	31
5.2.5. Transmitter Frequency Stability (Temperature & Voltage Variation)	34
<b>6. Measurement Uncertainty .....</b>	<b>36</b>
<b>7. Report Revision History .....</b>	<b>37</b>
<b>8. Appendix 1 .....</b>	<b>38</b>

**1. Customer Information**







<b>Company Name:</b>	Datecs Ltd
<b>Address:</b>	4 Datecs 1592 Sofia Bulgaria

## 2. Summary of Testing

### 2.1. General Information

<b>Specification Reference:</b>	47CFR15.225
<b>Specification Title:</b>	Code of Federal Regulations Volume 47 (Telecommunications): Part 15 Subpart C (Radio Frequency Devices) - Section 15.225
<b>Specification Reference:</b>	47CFR15.207 & 47CFR15.209
<b>Specification Title:</b>	Code of Federal Regulations Volume 47 (Telecommunications): Part 15 Subpart C (Intentional Radiators) – Sections 15.207 & 15.209
<b>Site Registration:</b>	209735
<b>Location of Testing:</b>	UL VS LTD, Unit 3 Horizon, Wade Road, Kingsland Business Park, Basingstoke, Hampshire, RG24 8AH, United Kingdom
<b>Test Dates:</b>	29 November 2016 to 13 February 2018

### 2.2. Summary of Test Results

FCC Reference (47CFR)	Measurement	Result
Part 15.207	Transmitter AC Conducted Emissions	
Part 15.225(a)(b)(c)(d)	Transmitter Fundamental Field Strength	
Part 15.209(a)/15.225(d)	Transmitter Radiated Emissions	
Part 15.209(a)/15.225(c)(d)	Transmitter Band Edge Radiated Emissions	
Part 15.225(e)	Transmitter Frequency Stability (Temperature & Voltage Variation)	
<b>Key to Results</b>		
 = Complied  = Did not comply		

### 2.3. Methods and Procedures

<b>Reference:</b>	ANSI C63.10-2013
<b>Title:</b>	American National Standard of Procedures for Compliance Testing of Unlicensed Wireless Devices
<b>Reference:</b>	FCC KDB Publication Number 414788 Date: 18/04/2017
<b>Title:</b>	TEST SITES FOR RADIATED EMISSION MEASUREMENTS
<b>Reference:</b>	FCC KDB Publication Number 174176 Date: June 3, 2015
<b>Title:</b>	AC POWER-LINE CONDUCTED EMISSIONS FREQUENTLY ASKED QUESTIONS

### 2.4. Deviations from the Test Specification

For the measurements contained within this test report, there were no deviations from, additions to, or exclusions from the test specification identified above.

### **3. Equipment Under Test (EUT)**

#### **3.1. Identification of Equipment Under Test (EUT)**

<b>Brand Name:</b>	Datecs Ltd
<b>Model Name or Number:</b>	LineaTab mini (InfineaTab mini)
<b>Test Sample Serial Number:</b>	NTK000001UN0216 ( <i>Radiated sample</i> )
<b>Hardware Version:</b>	C016902
<b>Software Version:</b>	01.05.66.12
<b>FCC ID:</b>	YRWITBM

<b>Brand Name:</b>	Datecs Ltd
<b>Model Name or Number:</b>	LineaTab mini
<b>Test Sample Serial Number:</b>	NTK000002UN0216 ( <i>Unit with external power cables</i> )
<b>Hardware Version:</b>	C016902
<b>Software Version:</b>	01.05.66.12
<b>FCC ID:</b>	YRWITBM

<b>Brand Name:</b>	Datecs Ltd
<b>Model Name or Number:</b>	LineaTab mini
<b>Test Sample Serial Number:</b>	NTK000001UN0118 ( <i>Unit with internal antenna terminated</i> )
<b>Hardware Version:</b>	C016902
<b>Software Version:</b>	01.05.66.12
<b>FCC ID:</b>	YRWITBM

#### **3.2. Description of EUT**

The Equipment Under Test was a mobile payment terminal with barcode reader, magnetic card reader, contactless card reader and Bluetooth connectivity provided by an FCC certified BT Module (FCC ID: YRWDATECSBT301). The RFID enabled barcode reader operates at 13.56 MHz and the device is powered from a 3.7 Volt battery.

#### **3.3. Modifications Incorporated in the EUT**

No modifications were applied to the EUT during testing.

**3.4. Additional Information Related to Testing**

<b>Tested Technology:</b>	RFID	
<b>Category of Equipment:</b>	Transceiver	
<b>Channel Spacing:</b>	Single channel device	
<b>Transmit Frequency Range:</b>	13.56 MHz	
<b>Power Supply Requirement:</b>	Nominal	3.7 V
	Minimum	3.3 V
	Maximum	4.2 V
<b>Tested Temperature Range:</b>	Minimum	-10°C
	Maximum	40°C

**3.5. Support Equipment**

The following support equipment was used to exercise the EUT during testing:

<b>Description:</b>	iPad
<b>Brand Name:</b>	Apple
<b>Model Name or Number:</b>	A1489
<b>Serial Number:</b>	DLXMTT7GFCM8

<b>Description:</b>	Programming cable. Length 1.6 metres
<b>Brand Name:</b>	ME5005-0017
<b>Model Name or Number:</b>	Not marked or stated
<b>Serial Number:</b>	Not marked or stated

<b>Description:</b>	Laptop PC
<b>Brand Name:</b>	Lenovo
<b>Model Name or Number:</b>	L440
<b>Serial Number:</b>	R9-019EA4

<b>Description:</b>	iPad
<b>Brand Name:</b>	Apple
<b>Model Name or Number:</b>	A1584
<b>Serial Number:</b>	DLXQMCT8GMLF

<b>Description:</b>	USB Power Adaptor
<b>Brand Name:</b>	Apple
<b>Model Name or Number:</b>	A1401
<b>Serial Number:</b>	Not marker or stated



## **4. Operation and Monitoring of the EUT during Testing**

### **4.1. Operating Modes**

The EUT was tested in the following operating mode:

- Constantly transmitting at full power with a modulated carrier in RFID test mode.

### **4.2. Configuration and Peripherals**

The EUT was tested in the following configurations:

- An Apple iPad was fitted to the EUT during all tests apart from frequency stability. The iPad was turned off.
- The RFID transmitter test mode was enabled by means of a test application (LineaRFControl\_new\_v2 Date:15/11/2016) provided by the customer and installed on a laptop PC.
- The EUT was connected to the laptop PC via a programming cable. The programming cable was disconnected from the laptop PC and EUT once the EUT was set to transmit in test mode.
- Testing at voltage extremes was performed with the EUT powered by an external DC power supply. The EUT's battery was disconnected and a bench power supply was connected to the EUT's battery terminals. Extreme temperature and voltages used were as stated by the customer and as shown in the user manual.
- During AC conducted emissions test, the EUT was connected to a LISN via USB cable and USB power adaptor. The EUT is powered from an internal battery, the battery is charged from a USB power adaptor and RFID transmission is possible during charging.
- Refer to Appendix 1 of this test report for details of radiated tests on an open field test site.

## **5. Measurements, Examinations and Derived Results**

### **5.1. General Comments**

Measurement uncertainties are evaluated in accordance with current best practice. Our reported expanded uncertainties are based on standard uncertainties, which are multiplied by an appropriate coverage factor to provide a statistical confidence level of approximately 95%. Please refer to *Section 6: Measurement Uncertainties* for details.

In accordance with UKAS requirements all the measurement equipment is on a calibration schedule. All equipment was within the calibration period on the date of testing.

## **5.2. Test Results**

### **5.2.1. Transmitter AC Conducted Spurious Emissions**

#### **Test Summary:**

<b>Test Engineer:</b>	Doug Freegard	<b>Test Dates:</b>	23 November 2017 to 13 February 2018
<b>Test Sample Serial Numbers:</b>	NTK000001UN0216 & NTK000001UN0118		

<b>FCC Reference:</b>	Part 15.207
<b>Test Method Used:</b>	ANSI C63.10 Section 6.2 / FCC KDB 174176 and Notes below

#### **Environmental Conditions:**

<b>Temperature (°C):</b>	19 to 25
<b>Relative Humidity (%):</b>	32 to 40

#### **Notes:**

1. AC conducted emissions tests were performed with the EUT connected to a USB power adaptor output via a USB cable. The USB power adaptor input was connected to a 120 VAC 60 Hz / 240 VAC 60 Hz single phase supply via a LISN.
2. A pulse limiter was fitted between the LISN and the test receiver.
3. Pre-scans were performed and markers placed on the highest live and neutral measured levels. Final measurements were performed on the marker frequencies and the results entered into the tables below.
4. In accordance with FCC KDB 174176 Q4, tests were also performed with a 240 VAC 60 Hz single phase supply as this was within the voltage range marked on the EUT.
5. The EUT was initially tested on 23 November 2017 with the standard antenna connected (Test sample serial number NTK000001UN0216) and using a 120 VAC 60 Hz single phase supply.
6. An emission at the approximate carrier frequency of 13.56 MHz was found to be non-compliant as it exceeded the limit. The customer supplied a second, modified sample (test sample serial number NTK000001UN0118). The standard antenna on this sample was disconnected and a dummy load fitted in accordance with FCC KDB 174176 Q5. The test was repeated during February 2018 and the EUT was found to be compliant.
7. \* Test results with standard EUT sample (standard antenna).
8. \*\* Test results with EUT sample incorporating antenna dummy load.

**Transmitter AC Conducted Spurious Emissions (continued)**

**Test setup:**

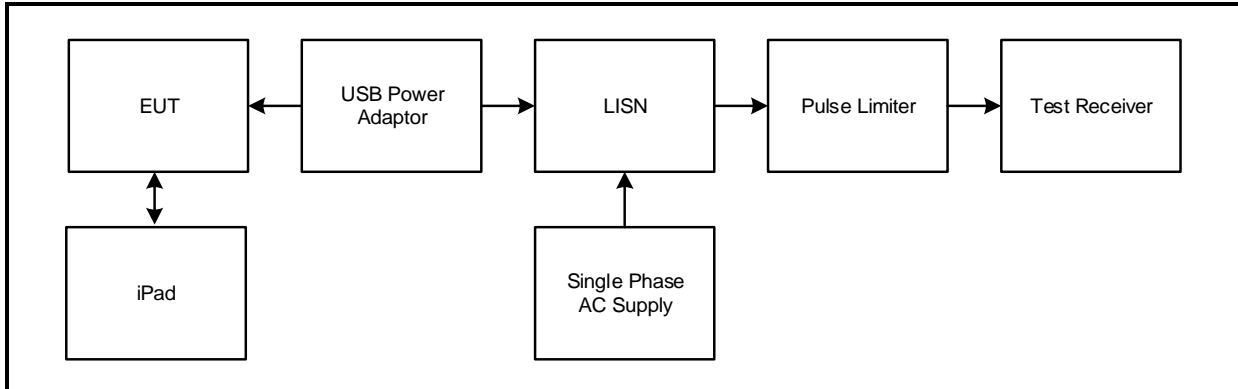

**Transmitter AC Conducted Spurious Emissions (continued)****Results: Live / Quasi Peak / 120 VAC 60 Hz**

Frequency (MHz)	Line	Level (dB $\mu$ V)	Limit (dB $\mu$ V)	Margin (dB)	Result
0.276	Live	58.3*	60.9	2.6	Complied
0.411	Live	55.2*	57.6	2.4	Complied
0.546	Live	50.0*	56.0	6.0	Complied
0.695	Live	50.9*	56.0	5.1	Complied
1.568	Live	38.5*	56.0	17.5	Complied
13.560	Live	43.1**	60.0	16.9	Complied

**Results: Live / Average / 120 VAC 60 Hz**

Frequency (MHz)	Line	Level (dB $\mu$ V)	Limit (dB $\mu$ V)	Margin (dB)	Result
0.411	Live	43.1*	47.6	4.5	Complied
0.546	Live	38.7*	46.0	7.3	Complied
0.695	Live	42.0*	46.0	4.0	Complied
0.956	Live	38.8*	46.0	7.2	Complied
3.080	Live	30.4*	46.0	15.6	Complied
13.560	Live	37.3**	50.0	12.7	Complied

**Results: Neutral / Quasi Peak / 120 VAC 60 Hz**

Frequency (MHz)	Line	Level (dB $\mu$ V)	Limit (dB $\mu$ V)	Margin (dB)	Result
0.276	Neutral	59.2*	60.9	1.7	Complied
0.402	Neutral	54.5*	57.8	3.3	Complied
0.546	Neutral	50.8*	56.0	5.2	Complied
0.695	Neutral	52.3*	56.0	3.7	Complied
1.424	Neutral	33.2*	56.0	22.8	Complied
13.560	Neutral	21.3**	60.0	38.7	Complied

**Results: Neutral / Average / 120 VAC 60 Hz**

Frequency (MHz)	Line	Level (dB $\mu$ V)	Limit (dB $\mu$ V)	Margin (dB)	Result
0.276	Neutral	45.9*	50.9	5.0	Complied
0.411	Neutral	45.2*	47.6	2.4	Complied
0.546	Neutral	41.8*	46.0	4.2	Complied
0.695	Neutral	39.7*	46.0	6.3	Complied
0.960	Neutral	36.0*	46.0	10.0	Complied
13.560	Neutral	14.7**	50.0	35.3	Complied

**Transmitter AC Conducted Spurious Emissions (continued)**

**Results: 120 VAC 60 Hz with unmodified sample (antenna present)**

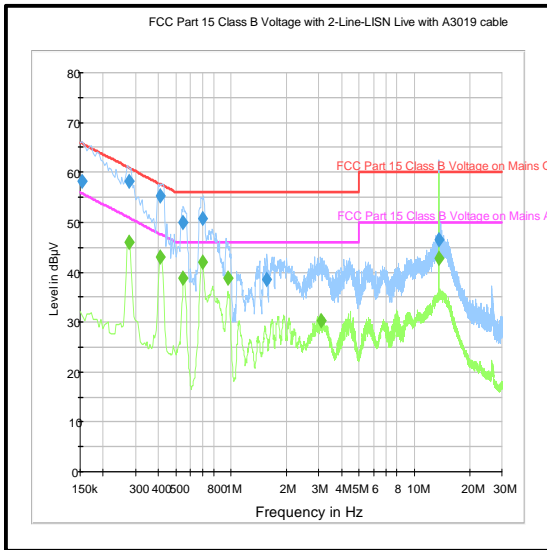

**Live**

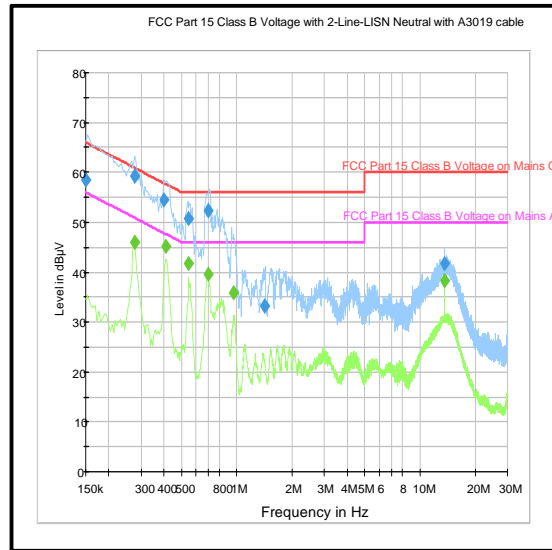

**Neutral**

**Results: 120 VAC 60 Hz with modified sample (transmitter terminated into a dummy load)**

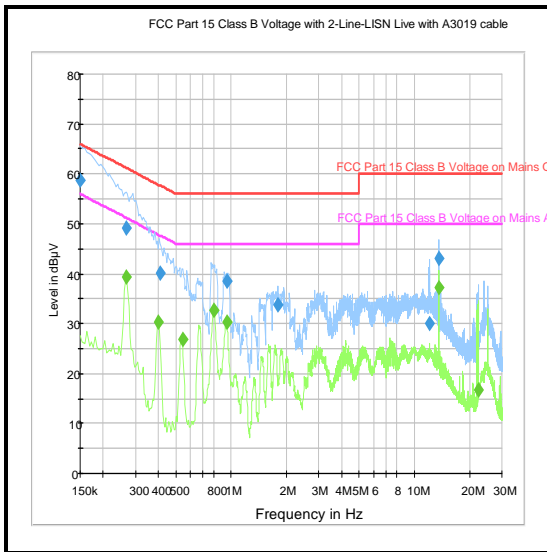

**Live**

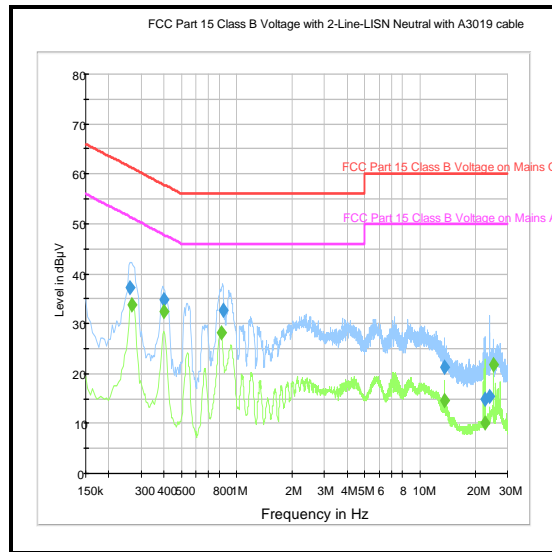

**Neutral**

*Note: These plots are pre-scans and for indication purposes only. For final measurements, see accompanying tables.*

**Transmitter AC Conducted Spurious Emissions (continued)****Results: Live / Quasi Peak / 240 VAC 60 Hz**

Frequency (MHz)	Line	Level (dB $\mu$ V)	Limit (dB $\mu$ V)	Margin (dB)	Result
0.546	Live	49.4*	56.0	6.6	Complied
0.686	Live	49.5*	56.0	6.5	Complied
0.938	Live	43.0*	56.0	13.0	Complied
1.217	Live	43.1*	56.0	12.9	Complied
3.206	Live	41.4*	56.0	14.6	Complied
13.560	Live	41.0**	60.0	19.0	Complied

**Results: Live / Average / 240 VAC 60 Hz**

Frequency (MHz)	Line	Level (dB $\mu$ V)	Limit (dB $\mu$ V)	Margin (dB)	Result
0.416	Live	40.7*	47.5	6.8	Complied
0.555	Live	41.1*	46.0	4.9	Complied
0.834	Live	44.8*	46.0	1.2	Complied
1.230	Live	36.8*	46.0	9.2	Complied
1.244	Live	36.6*	46.0	9.4	Complied
13.560	Live	35.8**	50.0	14.2	Complied

**Results: Neutral / Quasi Peak / 240 VAC 60 Hz**

Frequency (MHz)	Line	Level (dB $\mu$ V)	Limit (dB $\mu$ V)	Margin (dB)	Result
0.402	Neutral	49.7*	57.8	8.1	Complied
0.555	Neutral	50.0*	56.0	6.0	Complied
0.681	Neutral	51.3*	56.0	4.7	Complied
0.938	Neutral	43.2*	56.0	12.8	Complied
1.226	Neutral	41.0*	56.0	15.0	Complied
13.560	Neutral	19.6**	60.0	40.4	Complied

**Results: Neutral / Average / 240 VAC 60 Hz**

Frequency (MHz)	Line	Level (dB $\mu$ V)	Limit (dB $\mu$ V)	Margin (dB)	Result
0.416	Neutral	36.7*	47.5	10.8	Complied
0.555	Neutral	36.7*	46.0	9.3	Complied
0.834	Neutral	38.5*	46.0	7.5	Complied
0.956	Neutral	30.5*	46.0	15.5	Complied
1.230	Neutral	29.7*	46.0	16.3	Complied
13.560	Neutral	17.0**	50.0	33.0	Complied

**Transmitter AC Conducted Spurious Emissions (continued)**

**Results: 240 VAC 60 Hz with unmodified sample (antenna present)**

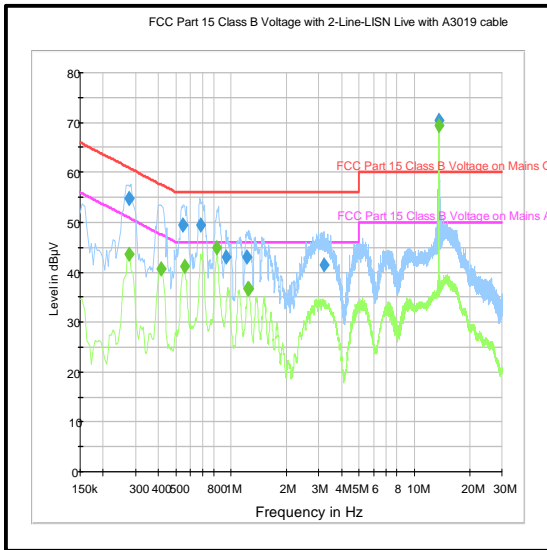

Live

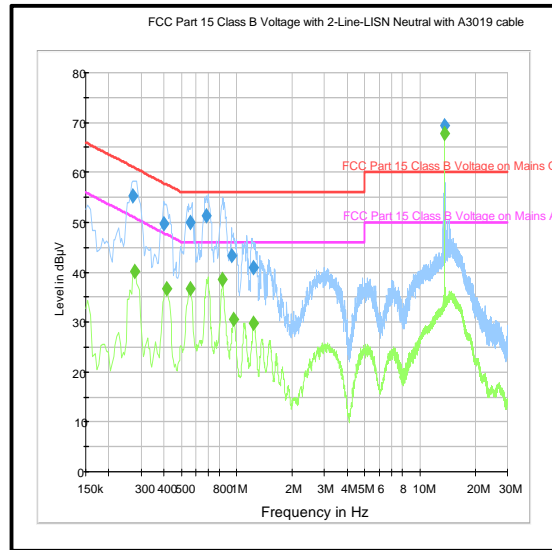

Neutral

**Results: 240 VAC 60 Hz with modified sample (transmitter terminated into a dummy load)**

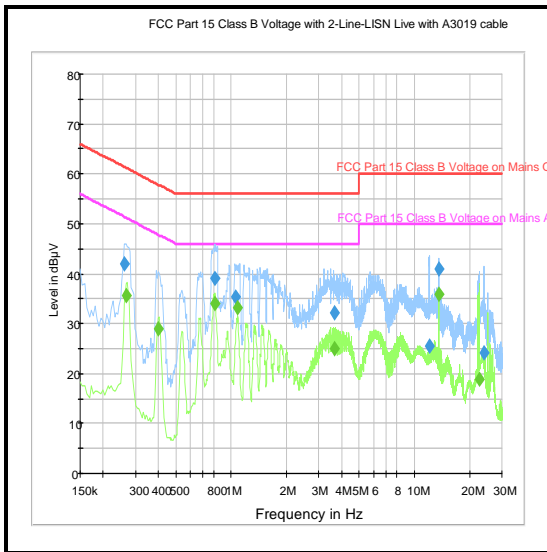

Live

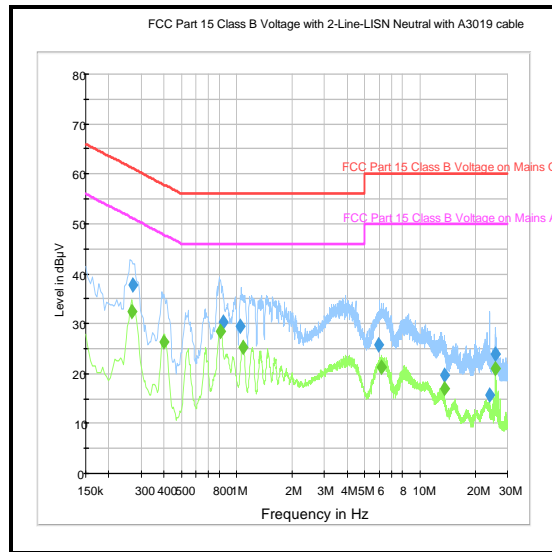

Neutral

Note: These plots are pre-scans and for indication purposes only. For final measurements, see accompanying tables.



**Transmitter AC Conducted Spurious Emissions (continued)****Test Equipment Used:**

<b>Asset No.</b>	<b>Instrument</b>	<b>Manufacturer</b>	<b>Type No.</b>	<b>Serial No.</b>	<b>Date Calibration Due</b>	<b>Cal. Interval (Months)</b>
M2013	Thermohygrometer	Testo	608-H1	45046424	20 Jun 2018	12
A649	LISN	Rohde & Schwarz	ESH3-Z5	825562/008	09 Aug 2018	12
A1830	Pulse Limiter	Rohde & Schwarz	ESH3-Z2	100668	09 May 2018	12
M1379	Test Receiver	Rohde & Schwarz	ESIB7	100330	08 Dec 2017	12
M1263	Test Receiver	Rohde & Schwarz	ESIB7	100265	13 Nov 2018	12
M1229	Multimeter	Fluke	179	87640015	12 May 2018	12

NOTE: Asset No. M1379 was used for testing on 23 November 2017. Asset No. M1263 was used during February 2018.

**5.2.2. Transmitter Fundamental Field Strength****Test Summary:**

<b>Test Engineers:</b>	Ian Watch & Stefan Ho	<b>Test Dates:</b>	29 November 2016 & 01 December 2016
<b>Test Sample Serial Number:</b>	NTK000001UN0216		

<b>FCC Reference:</b>	Part 15.225(a)(b)(c)(d)
<b>Test Method Used:</b>	ANSI C63.10 Section 6.4 and Notes below

**Environmental Conditions:**

<b>Temperature (°C):</b>	6 to 25
<b>Relative Humidity (%):</b>	21 to 66

**Note(s):**

1. The limit is specified at a test distance of 30 metres. However, as specified by FCC Section 15.31(f)(2), measurements may be performed at a closer distance and the measured level corrected to the specified measurement distance by using the square of an inverse linear distance extrapolation factor (40dB/decade).
2. A *bona fide* attempt was made to perform measurements at the distances specified in Part 15.209(a). It was not possible to determine the emission value at the test distances specified below 30 MHz on an open field test site, therefore in accordance with 47 CFR 15.31(f), measurements were made at closer distances. Attempts were made to measure the fundamental at 30 metres on an open field test site on 29 November 2016. Unfortunately the fundamental could not be seen above the ambient emissions or the noise floor of the measurement system at a distance of 30 metres. Background scans of the open field test site and further information are shown in Appendix 1 of this test report.
3. The fundamental field strength level measured on the open field site at a distance of 3 metres was maximised by rotating the measurement antenna and EUT. A peak level of 61.9 dB $\mu$ V/m in a 10 kHz measurement bandwidth, at a measurement distance of 3 metres was recorded and shown on the pre-scan plot '*Fundamental field strength / EUT operating / measured at 3 metres / measured on an open field test site*' below.
4. The measurement was repeated in a semi-anechoic chamber at 3 metres on 01 December 2016. An RF level offset on the test receiver was used to correlate the field strength measurement made in the semi-anechoic chamber to the same measurement level (61.9 dB $\mu$ V/m) performed at 3 metres on the open field test site.
5. Further measurements were performed in the semi-anechoic chamber using a test receiver with a peak detector and measurement bandwidth of 10 kHz. The RF level offset includes a -2.3 dB offset as explained in Note 4 above and a further -40 dB to extrapolate the level measured at 3 metres to the required distance of 30 metres (one decade). An RF level offset of -42.3 dB was used. The fundamental field strength was maximized by rotating the measurement antenna and EUT. A peak level of 21.9 dB $\mu$ V/m at a measurement distance of 3 metres was recorded in spectrum analyser mode and shown on the pre-scan plot below. The spectrum analyser was then switched to test receiver mode and the final measurement on the maximized level was performed. In accordance with ANSI C63.10 Clause 4.1.4.2.1 and CISPR 16-1-1, a quasi-peak detector was used in conjunction with a measurement bandwidth of 9 kHz and 0.2 second sweep time. A quasi-peak level of 21.9 dB $\mu$ V/m was recorded.

**Transmitter Fundamental Field Strength (continued)****Note(s):**

6. Due to the ambient emissions present on the open field test site, compliance with the spectrum mask is

shown by measurements performed in a semi-anechoic chamber. For the field strength measurements in a semi-anechoic chamber, a transducer factor on the measuring instrument was used to extrapolate the results at 3 metres to a distance of 30 metres. A distance extrapolation factor of 40 dB was used.

7. A transducer factor was used on the spectrum analyser during open field tests. This factor includes correction between the fixed gain of the magnetic loop antenna and the calibration values. It also includes the insertion loss of the RF cable used to connect the antenna to the spectrum analyser which was incorporated into the annual calibration of the magnetic loop antenna.

**Transmitter Fundamental Field Strength (continued)**

**Test setup for fundamental field strength measurements:**

**Measurements on an Open Field Test Site**

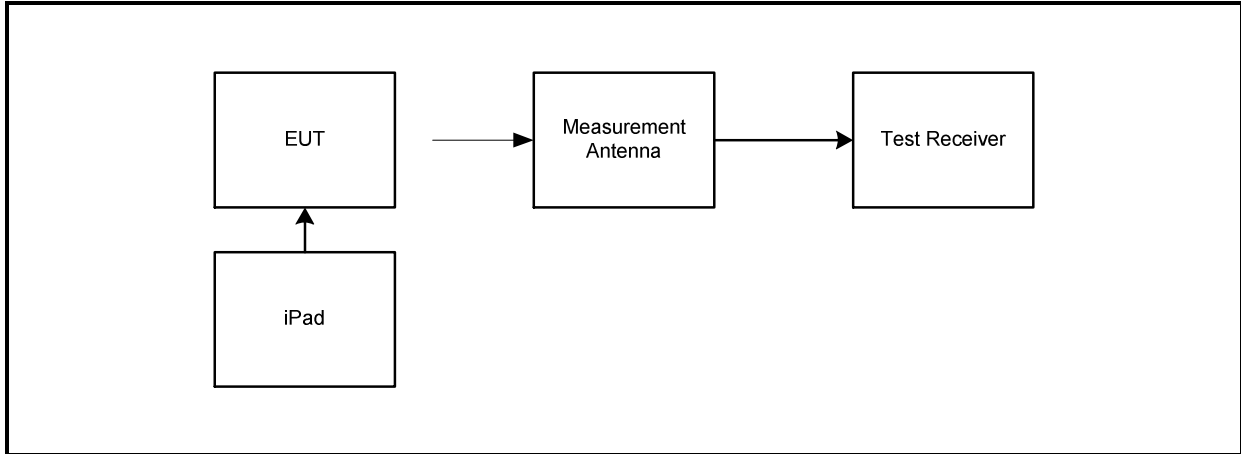

**Measurements in a semi-anechoic chamber**

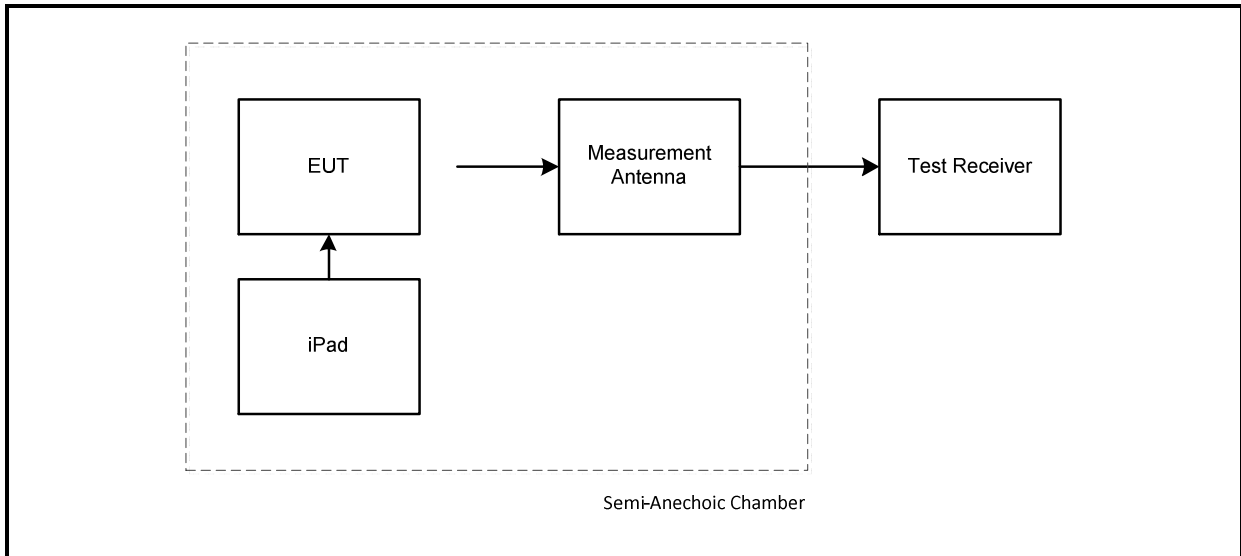

**Transmitter Fundamental Field Strength (continued)**

**Results: Quasi Peak**

Frequency (MHz)	Antenna Orientation	Level (dB $\mu$ V/m)	Limit at 30 m (dB $\mu$ V/m)	Margin (dB)	Result
13.56	Tip 90° to EUT	21.9	84.0	62.1	Complied

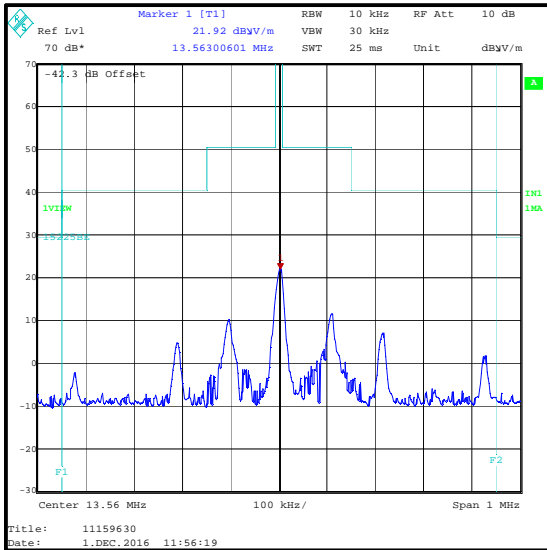

Fundamental field strength and spectrum mask / measured at 3 metres extrapolated to 30 metres / measured in a semi-anechoic chamber

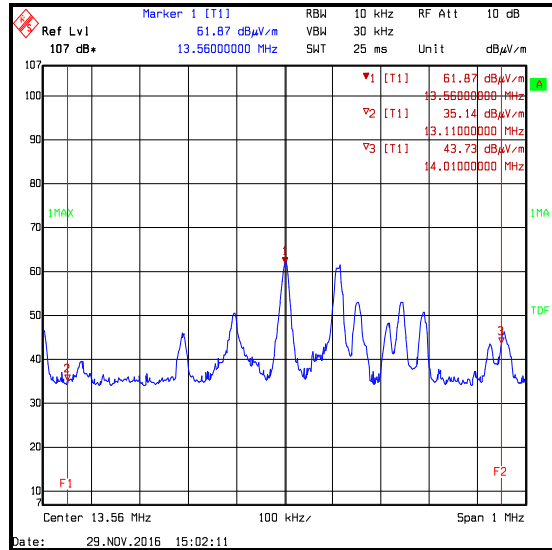

Fundamental field strength / EUT operating / measured at 3 metres / measured on an open field test site

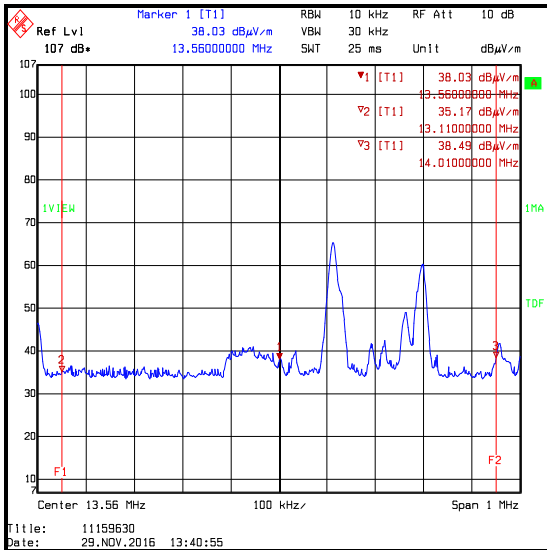

Fundamental field strength / EUT operating / measured at 30 metres / measured on an open field test site

**Transmitter Fundamental Field Strength (continued)****Test Equipment Used:**

<b>Asset No.</b>	<b>Instrument</b>	<b>Manufacturer</b>	<b>Type No.</b>	<b>Serial No.</b>	<b>Date Calibration Due</b>	<b>Cal. Interval (Months)</b>
M2002	Thermohygrometer	Testo	608-H1	45041825	02 Apr 2017	12
K0001	5m RSE Chamber	Rainford EMC	N/A	N/A	12 Jan 2017	12
M127	Spectrum Analyser	Rohde & Schwarz	FSEB	842659/016	08 Sep 2017	12
M1568	Magnetic Loop Antenna	Rohde & Schwarz	HFH2-Z2	879284/2	23 May 2017	12
M1273	Test Receiver	Rohde & Schwarz	ESIB 26	100275	11 Apr 2017	12
M2014	Thermohygrometer	Testo	608-H1	45046246	10 Jun 2017	12

**5.2.3. Transmitter Radiated Spurious Emissions****Test Summary:**

<b>Test Engineers:</b>	Ian Watch & Stefan Ho	<b>Test Dates:</b>	29 November 2016 & 01 December 2016
<b>Test Sample Serial Number:</b>	NTK000001UN0216		

<b>FCC Reference:</b>	Parts 15.225(d) & 15.209(a)
<b>Test Method Used:</b>	ANSI C63.10 Sections 6.3, 6.4 and 6.5 and Notes below
<b>Frequency Range:</b>	9 kHz to 1000 MHz

**Environmental Conditions:**

<b>Temperature (°C):</b>	0 to 6
<b>Relative Humidity (%):</b>	66 to 72

**Note(s):**

1. A *bona fide* attempt was made to perform measurements at the distances specified in Part 15.209(a) on an open field test site. It was not possible to determine the spurious emission values at the test distances specified below 30 MHz on an open field test site, therefore in accordance with 47 CFR 15.31(f), measurements were made at closer distances. Attempts were made to measure spurious emissions at 3, 30 and 300 metres on an open field test site on 29 November 2016. Unfortunately, spurious emissions from the EUT could not be seen above the ambient emissions present at the open field test site or the noise floor of the measurement system. Final measurement results from the semi-anechoic chamber tests on 01 December 2016 are shown in this section. In addition, the open field test result plots for measurements between 9 kHz and 30 MHz are also shown. These measurement plots are identical to background scan plots of the open field test site. Background scans of the open field test site and further information are shown in Appendix 1 of this test report.
2. The final measured value, for the given emissions, in the table below incorporates the calibrated antenna factor and cable loss. Only spurious emissions in the range 30 MHz to 1 GHz were recorded. Markers were placed on the peaks of the pre-scan plot and final measurements were performed using a quasi-peak detector.
3. All other emissions were greater than 20 dB below the applicable limit, below the noise floor of the measurement system or ambient.
4. Measurements on 01 December 2016 were performed in a semi-anechoic chamber (UL VS LTD Asset Number K0001) at a distance of 3 metres. The EUT was placed at a height of 80 cm above the reference ground plane in the centre of the chamber turntable. Between 30 MHz and 1 GHz, maximum emission levels were determined by height searching the measurement antenna over the range 1 metre to 4 metres.
5. Measurement plots in this section for tests between 9 kHz and 30 MHz on an open field test site have markers placed on the highest level ambient emissions. This is for information only.
6. Limit lines shown on open field test site plots from 9 kHz to 490 kHz have been extrapolated using a factor of 40 dB/decade to a test distance of 30 metres and are for indication only.
7. A transducer factor was used on the spectrum analyser during open field tests. This factor includes correction between the fixed gain of the magnetic loop antenna and the calibration values. It also includes the value of the RF cable used to connect the antenna to the spectrum analyser which was incorporated into the annual calibration of the magnetic loop antenna.

**Transmitter Radiated Spurious Emissions (continued)**

**Test setup for radiated measurements:**

**Measurements below 30 MHz on an Open Field Test Site**

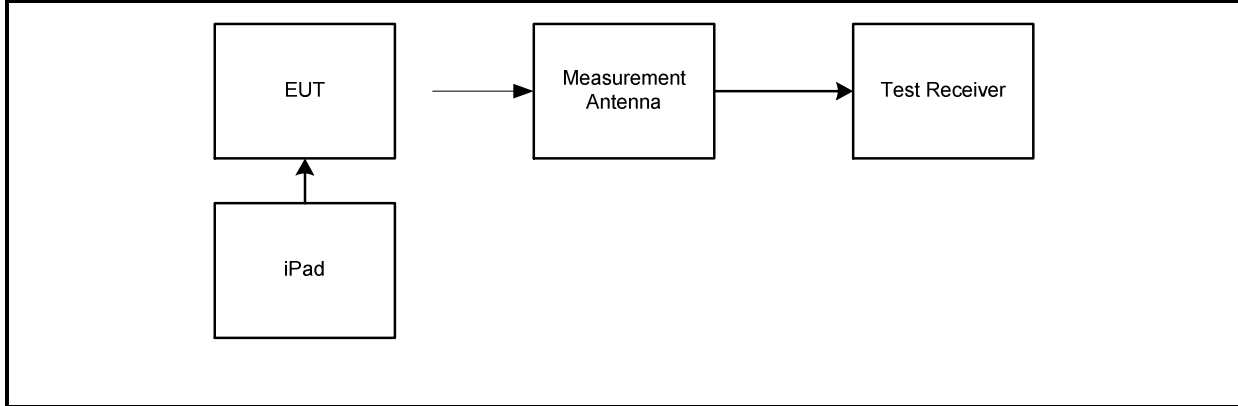

**Measurements below 30 MHz in a semi-anechoic chamber**

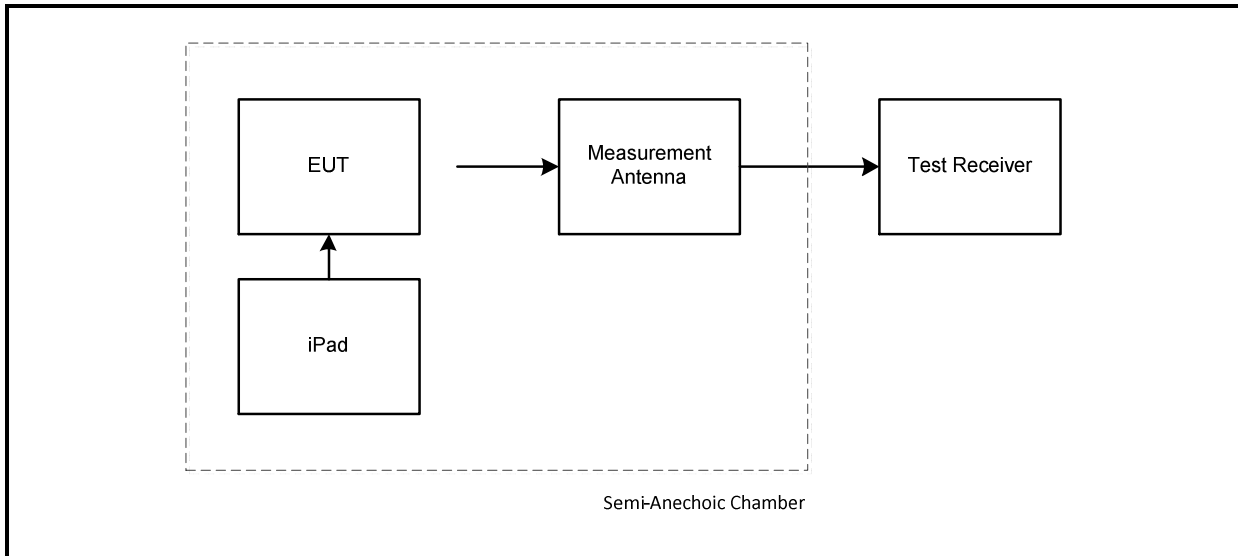



**Transmitter Radiated Spurious Emissions (continued)**

**Measurements above 30 MHz in a semi-anechoic chamber**

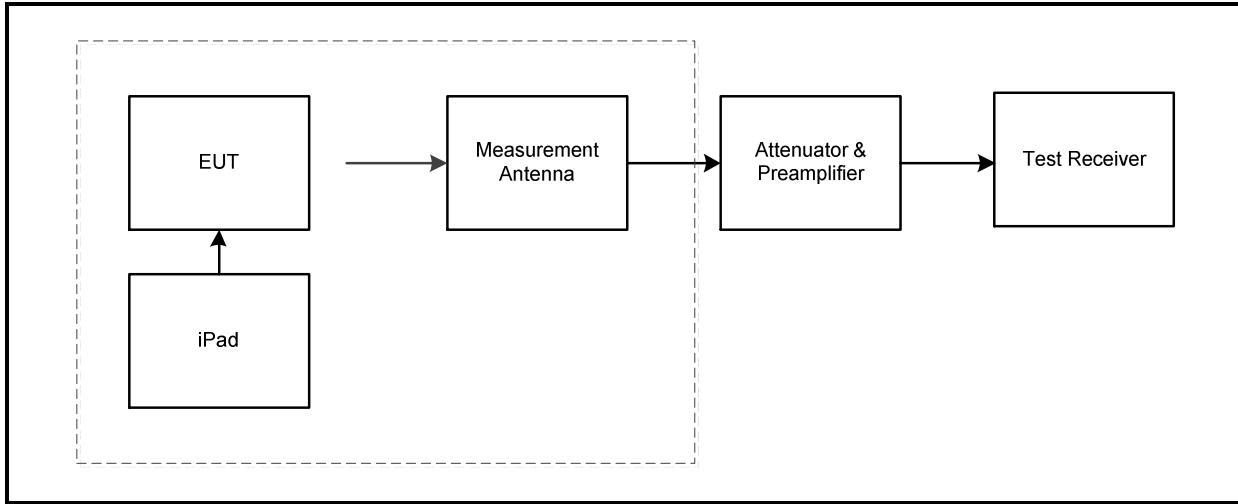

**Transmitter Radiated Spurious Emissions (continued)****Results: Quasi Peak**

Frequency (MHz)	Antenna Polarity	Level (dB $\mu$ V/m)	Limit (dB $\mu$ V/m)	Margin (dB)	Result
135.599	Horizontal	33.2	43.5	10.3	Complied
162.719	Horizontal	6.2	43.5	37.3	Complied
189.837	Vertical	7.0	43.5	36.5	Complied
216.954	Horizontal	8.1	46.0	37.9	Complied
796.944	Horizontal	19.6	46.0	26.4	Complied
958.679	Horizontal	22.5	46.0	23.5	Complied

**Transmitter Radiated Spurious Emissions (continued)**

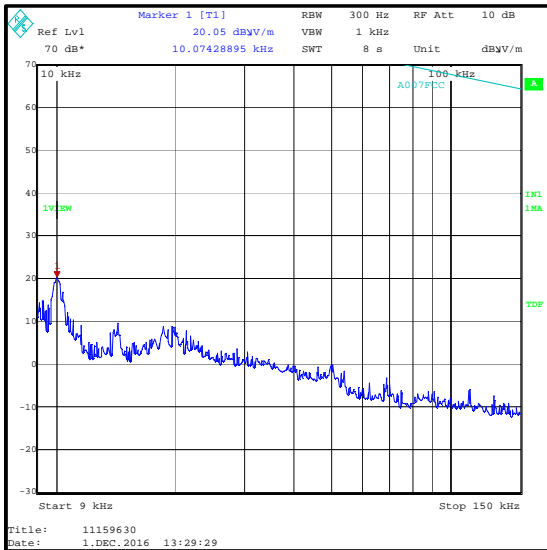

**9 kHz to 150 kHz / peak detector / measured at 3 metres extrapolated to 30 metres / measured in a semi-anechoic chamber**

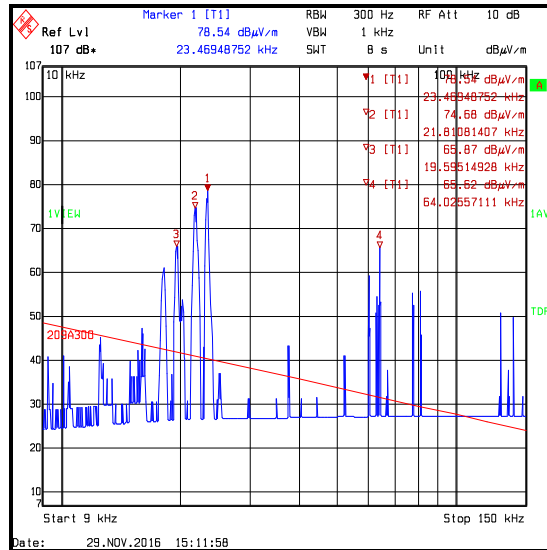

**9 kHz to 150 kHz / average detector / EUT operating / measured at 3 metres on an open field test site**

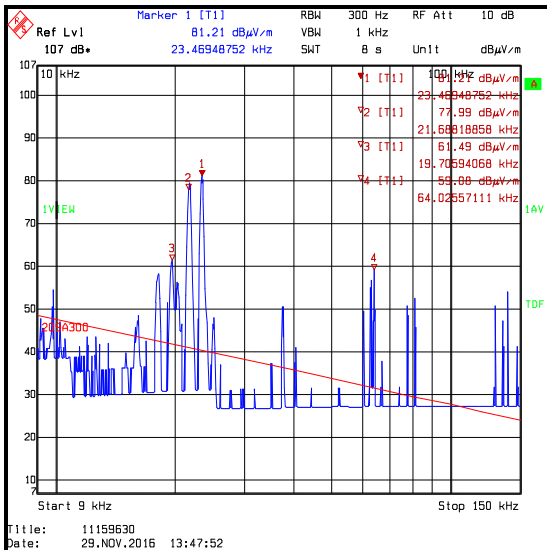

**9 kHz to 150 kHz / average detector / EUT operating / measured at 30 metres on an open field test site**

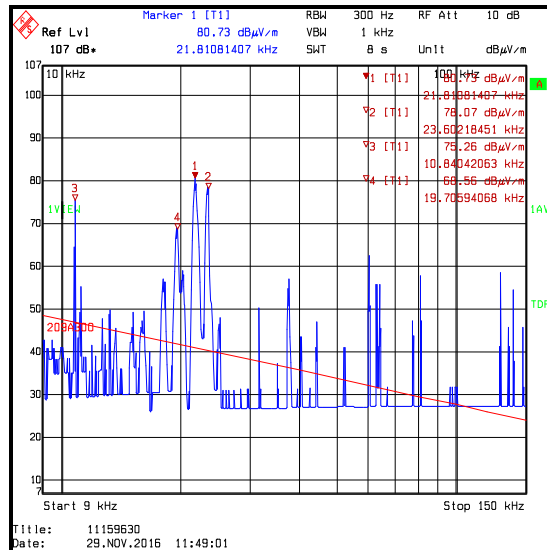

**9 kHz to 150 kHz / average detector / EUT operating / measured at 300 metres on an open field test site**

*Note: These plots are pre-scans and for indication purposes only. For final measurements, see accompanying table.*

**Transmitter Radiated Spurious Emissions (continued)**

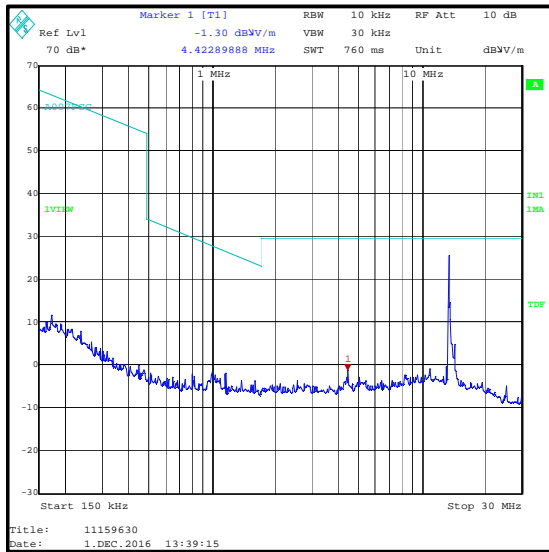

150 kHz to 30 MHz / peak detector (worst case) / EUT operating / measured at 3 metres extrapolated to 30 metres / measured in a semi-anechoic chamber

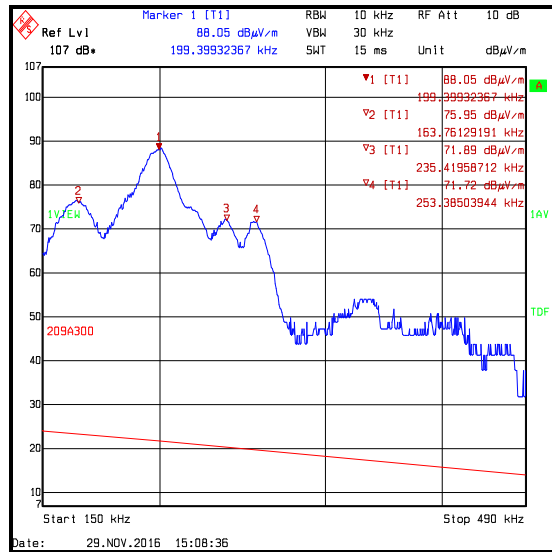

150 kHz to 490 kHz / average detector / EUT operating / measured at 3 metres on an open field test site



150 kHz to 490 kHz / average detector / EUT operating / measured at 30 metres on an open field test site

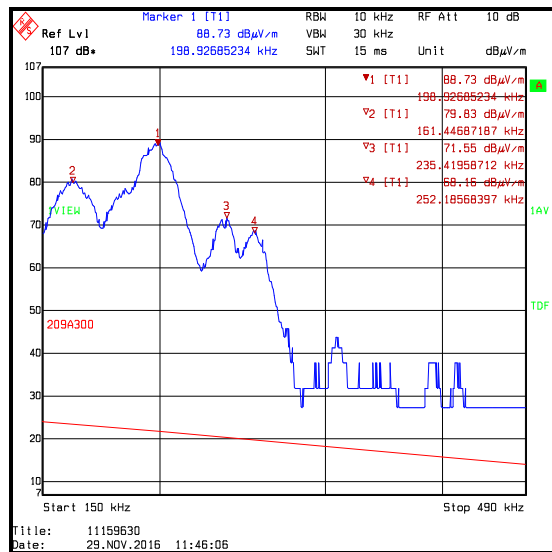

150 kHz to 490 kHz / average detector / EUT operating / measured at 300 metres on an open field test site

Note: These plots are pre-scans and for indication purposes only. For final measurements, see accompanying table.

**Transmitter Radiated Spurious Emissions (continued)**

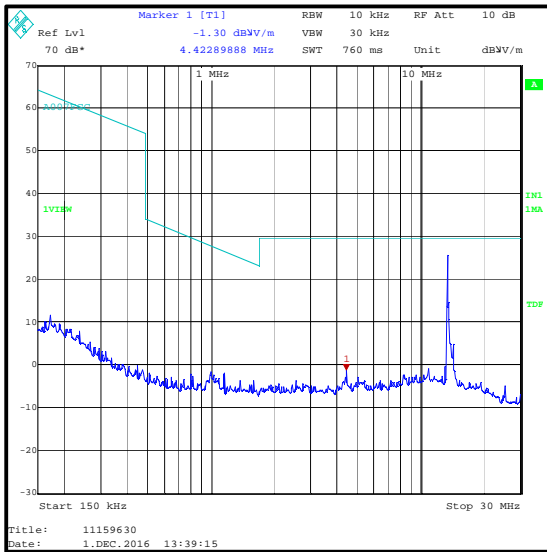

**150 kHz to 30 MHz / peak detector / measured at 3 metres extrapolated to 30 metres / measured in a semi-anechoic chamber**

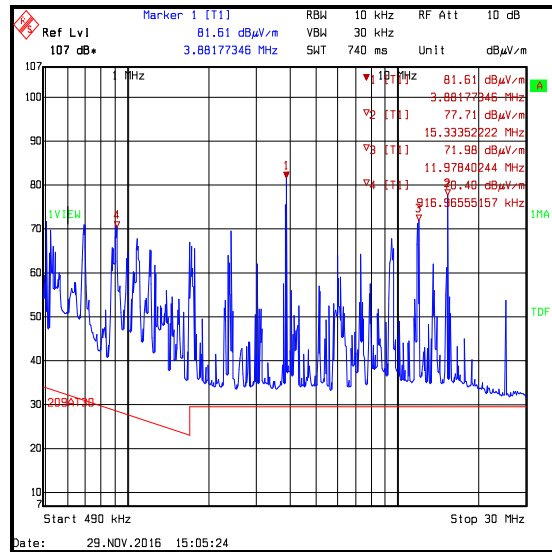

**490 kHz to 30 MHz / peak detector / EUT operating / measured at 3 metres on an open field test site**

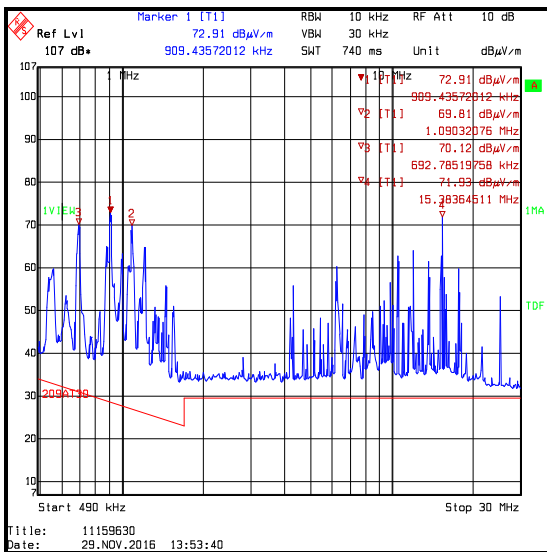

**490 kHz to 30 MHz / peak detector / EUT operating / measured at 30 metres on an open field test site**

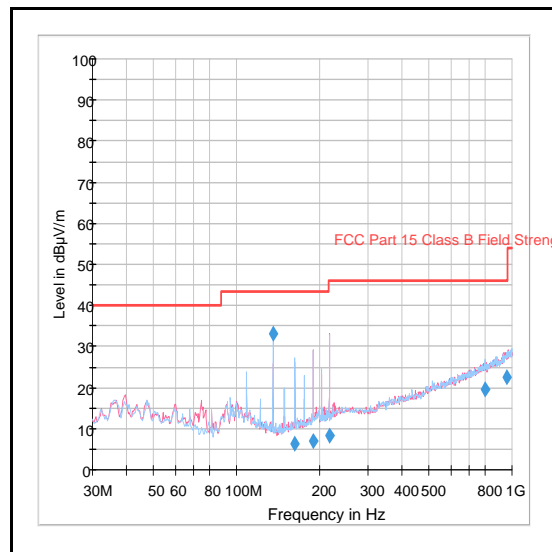

**30 MHz to 1 GHz / peak detector (worst case) / measured at 3 metres in a semi-anechoic chamber**

*Note: These plots are pre-scans and for indication purposes only. For final measurements, see accompanying table.*

**Transmitter Radiated Spurious Emissions (continued)****Test Equipment Used:**

<b>Asset No.</b>	<b>Instrument</b>	<b>Manufacturer</b>	<b>Type No.</b>	<b>Serial No.</b>	<b>Date Calibration Due</b>	<b>Cal. Interval (Months)</b>
M2002	Thermohygrometer	Testo	608-H1	45041825	02 Apr 2017	12
K0001	5m RSE Chamber	Rainford EMC	N/A	N/A	12 Jan 2017	12
M127	Spectrum Analyser	Rohde & Schwarz	FSEB	842659/016	08 Sep 2017	12
M1568	Magnetic Loop Antenna	Rohde & Schwarz	HFH2-Z2	879284/2	23 May 2017	12
M1273	Test Receiver	Rohde & Schwarz	ESIB 26	100275	11 Apr 2017	12
M2014	Thermohygrometer	Testo	608-H1	45046246	10 Jun 2017	12
G0543	Preamplifier	Sonama	310N	230801	09 Jun 2017	6
A1834	Attenuator	HP	8491B	10444	30 Mar 2017	12
M127	Spectrum Analyser	Rohde & Schwarz	FSEB	842659/016	08 Sep 2017	12

**5.2.4. Transmitter Band Edge Radiated Emissions****Test Summary:**

<b>Test Engineers:</b>	Ian Watch & Stefan Ho	<b>Test Dates:</b>	29 November 2016 & 01 December 2016
<b>Test Sample Serial Number:</b>	NTK000001UN0216		

<b>FCC Reference:</b>	Parts 15.225(c)(d) & 15.209(a)
<b>Test Method Used:</b>	ANSI C63.10 Section 6.10.4 and Notes below

**Environmental Conditions:**

<b>Temperature (°C):</b>	0 to 6
<b>Relative Humidity (%):</b>	66 to 72

**Note(s):**

1. A *bona fide* attempt was made to perform measurements at the distances specified in Part 15.209(a). It was not possible to determine the band edge emission values at the test distances specified below 30 MHz on an open field test site due to the presence of ambient emissions, therefore in accordance with 47 CFR 15.31(f), measurements were made at closer distances. Attempts were made to measure the fundamental and band edges at 3 metres on an open field test site on 29 November 2016. Unfortunately the emission could not be seen above the ambient emissions or the noise floor of the measurement system. Therefore the results from the semi-anechoic chamber tests on 01 December 2016 are shown in this section of the test report. Background scans of the open field test site are shown in Appendix 1 of this test report.
2. For the field strength measurements in a semi-anechoic chamber, an offset of -42.3 dB was used to extrapolate the results at 3 metres to a distance of 30 metres and correlate measurements in a semi-anechoic chamber with measurements on an open field test site. For details on the calculations see Notes 3 and 4 in Section 5.2.2 of this test report.
3. A transducer factor on the measuring instrument was used to extrapolate the results at 3 metres to a distance of 30 metres where required. A distance extrapolation factor of 40 dB was used.
4. The spectrum analyser resolution bandwidth was set to 10 kHz and video bandwidth 30 kHz. A peak detector was used, sweep time was set to auto and the trace mode was Max Hold. The span was set to 1 MHz. Markers were placed at the lower and upper band edges. The results are given in the tables below.

**Transmitter Band Edge Radiated Emissions (continued)**

**Test setup:**

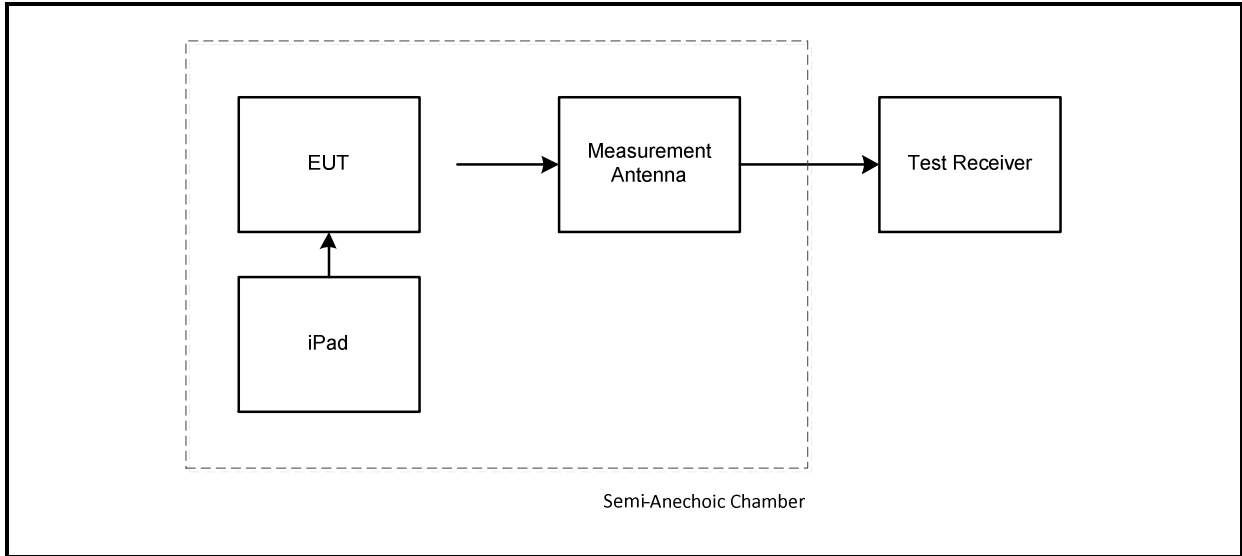



**Transmitter Band Edge Radiated Emissions (continued)**

**Results: Quasi Peak / Lower Band Edge**

Frequency (MHz)	Level (dB $\mu$ V/m)	Limit (dB $\mu$ V/m)	Margin (dB)	Result
13.11	-8.8	29.5	38.3	Complied

**Results: Quasi Peak / Upper Band Edge**

Frequency (MHz)	Level (dB $\mu$ V/m)	Limit (dB $\mu$ V/m)	Margin (dB)	Result
14.01	-8.1	29.5	37.6	Complied

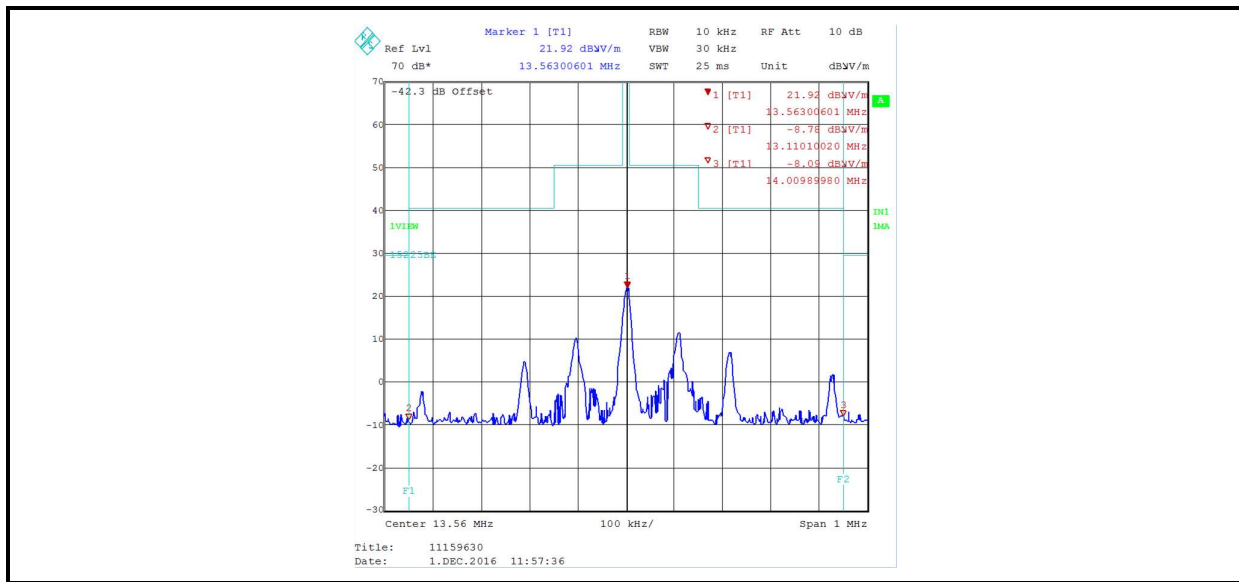

**Test Equipment Used:**

Asset No.	Instrument	Manufacturer	Type No.	Serial No.	Date Calibration Due	Cal. Interval (Months)
K0001	5m RSE Chamber	Rainford EMC	N/A	N/A	12 Jan 2017	12
M127	Spectrum Analyser	Rohde & Schwarz	FSEB	842659/016	08 Sep 2017	12
M1568	Magnetic Loop Antenna	Rohde & Schwarz	HFH2-Z2	879284/2	23 May 2017	12
M1273	Test Receiver	Rohde & Schwarz	ESIB 26	100275	11 Apr 2017	12
M2014	Thermohygrometer	Testo	608-H1	45046246	10 Jun 2017	12

**5.2.5. Transmitter Frequency Stability (Temperature & Voltage Variation)****Test Summary:**

<b>Test Engineer:</b>	Stefan Ho	<b>Test Date:</b>	05 December 2016
<b>Test Sample Serial Number:</b>	NTK000002UN0216		

<b>FCC Reference:</b>	Part 15.225(e)
<b>Test Method Used:</b>	ANSI C63.10 Sections 6.8.1 and 6.8.2

**Environmental Conditions:**

<b>Ambient Temperature (°C):</b>	23
<b>Ambient Relative Humidity (%):</b>	32

**Note(s):**

1. Testing at voltage extremes was performed with the EUT powered by a variable DC power supply. The EUT's battery was removed and the power supply was connected to the battery terminals. Temperature range tested was as stated in the User Manual, -10 °C to 40 °C. The manufacturer declared the minimum and maximum primary supply voltages as 3.3 and 4.2.
2. Frequency stability measurements were performed with a modulated carrier. The measurements were performed using the spectrum analyser marker counter function. The marker counter function was set to 1 Hz before any measurements were performed.
3. Temperature was monitored throughout the test with a calibrated digital thermometer.
4. Voltage was monitored throughout the test with a calibrated digital voltmeter.

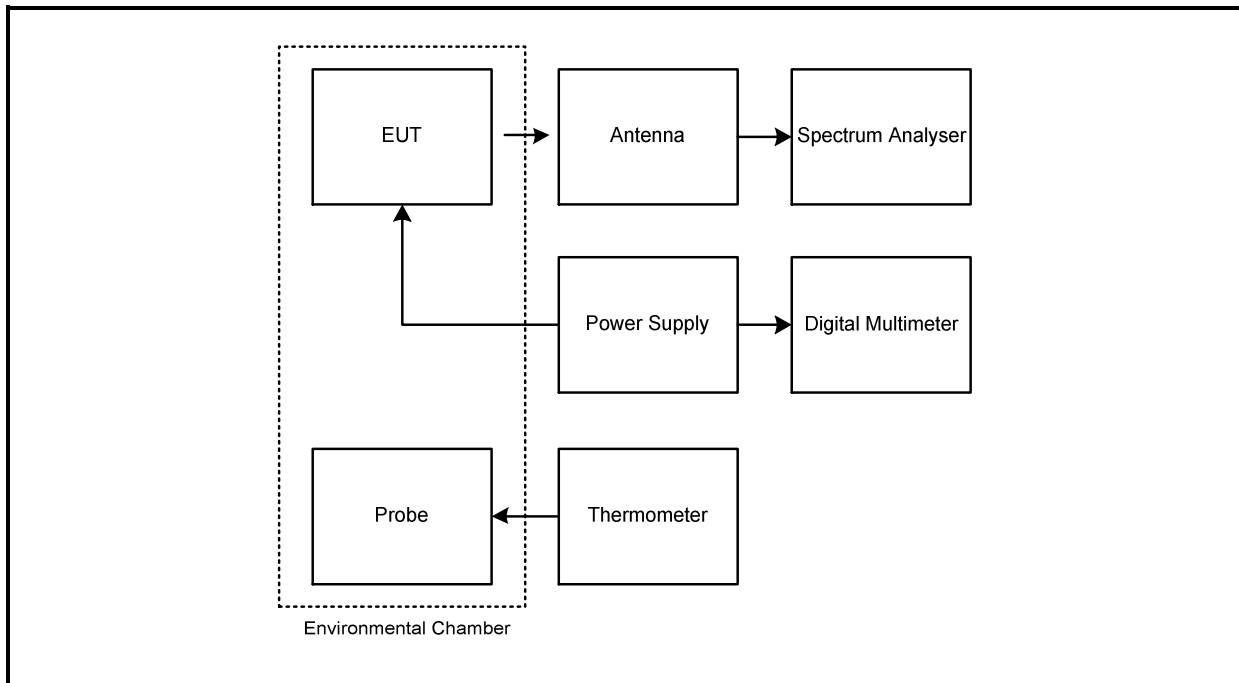
**Test setup:**

**Transmitter Frequency Stability (Temperature & Voltage Variation) (continued)****Results: Maximum frequency error of the EUT with variations in ambient temperature**

Temperature (°C)	Time after Start-up			
	0 minutes	2 minutes	5 minutes	10 minutes
-10	13.560048 MHz	13.560050 MHz	13.560050 MHz	13.560050 MHz
23	13.560000 MHz	13.559998 MHz	13.559995 MHz	13.559993 MHz
40	13.560007 MHz	13.559993 MHz	13.559993 MHz	13.559998 MHz

Frequency with Worst Case Deviation (MHz)	Frequency Error (Hz)	Frequency Error (%)	Limit (%)	Margin (%)	Result
13.560050	50	0.0004	0.01	0.0096	Complied

**Results: Maximum frequency error of the EUT with variations in nominal operating voltage at an ambient temperature of 20°C**

Supply Voltage (V)	Nominal Frequency (MHz)	Measured Frequency (MHz)	Frequency Error (Hz)	Frequency Error (%)	Limit (%)	Margin (%)	Result
3.3	13.56	13.559998	2	0.0001	0.01	0.0099	Complied
3.7	13.56	13.560000	0	0	0.01	0.01	Complied
4.2	13.56	13.559998	2	0.0001	0.01	0.0099	Complied

**Test Equipment Used:**

Asset No.	Instrument	Manufacturer	Type No.	Serial No.	Date Calibration Due	Cal. Interval (Months)
M127	Spectrum Analyser	Rohde & Schwarz	FSEB30	842659/016	08 Sep 2017	12
M1674	Environmental Chamber	Espec Corporation	SU-241	92013139	Calibrated before use	-
M1643	Thermometer	Fluke	52II	18890136	25 Apr 2017	12
S0536	DC power supply	Thurlby Thandar Instruments	EL302D	249944	Calibrated before use	-
M1269	Multimeter	Fluke	179	90250210	13 May 2017	12
M1659	Thermohygrometer	JM Handelpunkt	30.5015.13	Not stated	02 Apr 2017	12

## **6. Measurement Uncertainty**

No measurement or test can ever be perfect and the imperfections give rise to error of measurement in the results. Consequently the result of a measurement is only an approximation to the value of the measurand (the specific quantity subject to measurement) and is only complete when accompanied by a statement of the uncertainty of the approximation.

The expression of uncertainty of a measurement result allows realistic comparison of results with reference values and limits given in specifications and standards.

The uncertainty of the result may need to be taken into account when interpreting the measurement results.

The reported expanded uncertainties below are based on a standard uncertainty multiplied by an appropriate coverage factor such that a confidence level of approximately 95% is maintained. For the purposes of this document "approximately" is interpreted as meaning "effectively" or "for most practical purposes".

<b>Measurement Type</b>	<b>Range</b>	<b>Confidence Level (%)</b>	<b>Calculated Uncertainty</b>
Frequency Stability	13 MHz to 14 MHz	95%	±1.62 ppm
AC Conducted Spurious Emissions	0.15 MHz to 30 MHz	95%	±4.69 dB
Radiated Spurious Emissions	9 kHz to 30 MHz	95%	±3.73 dB
Radiated Spurious Emissions	30 MHz to 1000 MHz	95%	±5.65 dB
Transmitter Fundamental Field Strength	13 MHz to 14 MHz	95%	±3.73 dB

The methods used to calculate the above uncertainties are in line with those recommended within the various measurement specifications. Where measurement specifications do not include guidelines for the evaluation of measurement uncertainty the published guidance of the appropriate accreditation body is followed.

## **7. Report Revision History**

<b>Version Number</b>	<b>Revision Details</b>		
	<b>Page No(s)</b>	<b>Clause</b>	<b>Details</b>
1.0	-	-	Initial Version
2.0	6 8 9 11-17	-	Inserted additional EUT used for AC conducted tests Inserted USB power adaptor details Updated Section 4.2 with AC conducted emissions details Inserted AC conducted emissions results section
3.0	1 & 6 6 38 to 40	-	At the request of the TCB: Changed FCC ID Changed description of EUT Removed EUT photos
4.0	5	-	Changed reference to KDB 937606 to KDB 414788. Inserted reference to KDB 174176

## **8. Appendix 1**

### **GPS coordinates of test location**

Mag loop location (lower marker on photo)

N51° 08.739' W001° 26.328'

30 metre test point (middle marker on photo)

N51° 08.755' W001° 26.325'

300 metre test point (upper marker on photo)

N51° 08.895' W001° 26.289'



**Details of 3 metre and 30 metre open field test site used on 29 November 2016**

Temperature: 0 °C to 6 °C

Relative Humidity: 66% to 72%

Ground conditions: Frost

The test site was free from underground metal objects.

The EUT was powered at its nominal voltage from its internal battery. An unpowered Apple iPad was inserted into the EUT.

The EUT was placed on a plastic table at a height of 0.8 metres above ground level and arranged according to ANSI C63.10-2013 Section 6.12.

The test receiver used for measurements was located in a vehicle 30 metres from the magnetic loop antenna. Power to the test equipment was from a single phase supply.

The test distance was from the centre of the mag loop antenna to the closest periphery of the EUT. This distance was maintained as the EUT was rotated.

Initially, The EUT was rotated through 360 degrees in 60 degree steps at both measurement distances. The mag loop antenna was rotated through 90 degrees in 30 degree steps at every position the EUT was moved to. The EUT and mag loop antenna were then rotated in small increments in order to maximise emission levels.

**Details of 300 metre open field test site used on 29 November 2016**

Temperature: 0 °C to 6 °C

Relative Humidity: 66% to 72%

Ground conditions: Frost

**Measurements at 300 metres**

The test site was free from underground metal objects.

The EUT was powered at its nominal voltage from its internal battery. An unpowered Apple iPad was inserted into the EUT.

The EUT was placed on a plastic table at a height of 0.8 metres above ground level and arranged according to ANSI C63.10-2013 Section 6.12.

The test receiver used for measurements was located in a vehicle 30 metres from the magnetic loop antenna. Power to the test equipment was from a single phase supply.

The test distance was from the centre of the mag loop antenna to the closest periphery of the EUT. This distance was maintained as the EUT was rotated.

Initially, The EUT was rotated through 360 degrees in 60 degree steps at both measurement distances. The mag loop antenna was rotated through 90 degrees in 30 degree steps at every position the EUT was moved to. The EUT and mag loop antenna were then rotated in small increments in order to maximise emission levels.



### **Comparison of open field test site with semi-anechoic chamber measurements at 3 metres**

Radiated measurements were performed on an open field test site and within a 5 metre semi-anechoic chamber.

For the signal source, a modified loop antenna was connected to a signal generator at the transmit side. A standard active magnetic loop antenna was connected to a spectrum analyser at the receive side. The signal generator was set to its maximum supported output power and the signal was transmitted to the spectrum analyser via the two antennas and associated RF cables.

A sweep in small frequency increments was performed from 9 kHz to 30 MHz. The sweep was repeatedly performed with both antennas rotated about the axis in various orientations. Received levels for all orientations were recorded and the maximum levels for the open field test site and the semi-anechoic chamber are shown on the graph below. Full data for both tests are archived on the UL VS LTD IT server and available for inspection on request.

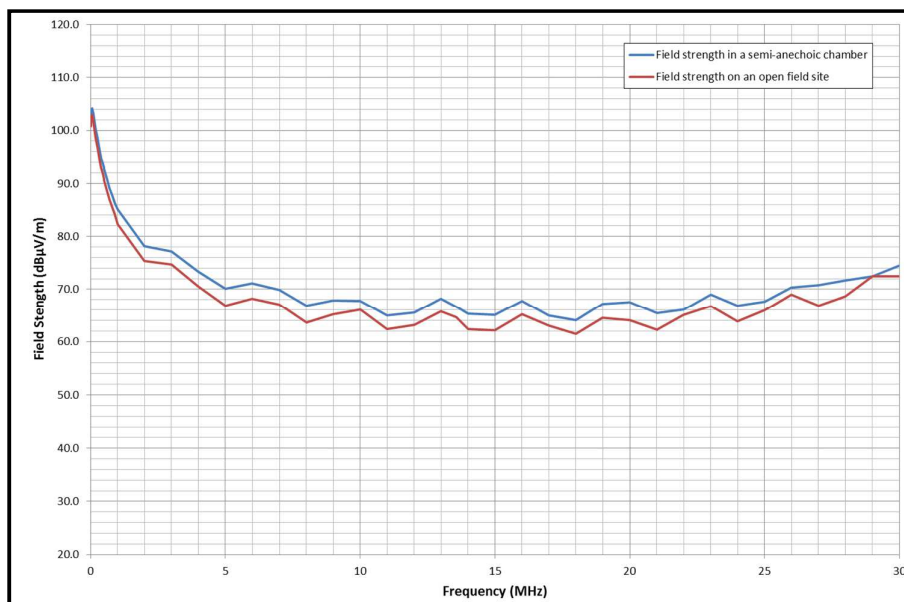

The conclusion was that the open field test site compares well with the semi-anechoic chamber at a measurement distance of 3 metres. If anything, the semi-anechoic chamber results are generally slightly higher. This means that if the measurement passes in the semi-anechoic chamber, it will pass with a higher margin on an open field test site.

The magnetic loop antenna used to perform these measurements is the same antenna or same type of antenna used during measurements contained in this test report.

**Verification of open field test site and semi-anechoic chamber measurements at 3 metres prior to performing measurements**

Two reference units are used for verification of the measurement system before testing commences. Both reference units are door entry systems modified by the manufacturer for test purposes only.

One reference unit transmits a continuous, unmodulated signal at a fixed frequency of 125 kHz when a 12 Volt battery is connected. The output power is fixed and known to be stable.

The second transmits a continuous, unmodulated signal at a fixed frequency of 13.56 MHz when a 12 Volt battery is connected. The output power is fixed and known to be stable.

Both frequencies are commonly used RFID frequencies.

A UL VS LTD internal verification document explains the procedure in detail. A brief description is given below.

The centre of the magnetic loop antenna is placed exactly 3 metres from the reference unit. The reference unit is placed on a plastic table at a height of 0.8 metres above floor level and the centre of the mag loop antenna is 1 metre above the floor level. The mag loop antenna and reference unit are oriented in certain positions to ensure repeatability.

Each reference unit is connected to a 12 Volt battery and once transmitting, the maximum raw received level at each of the two frequencies is read on the spectrum analyser by using the marker peak function. The measured level has to be within certain levels as specified in the UL VS LTD internal test procedure. The plot of the verification measurement is archived on the UL VS LTD IT server. The peak level of each reference unit is recorded on a spreadsheet which is also archived on the UL VS LTD IT server.

The internal verification procedure and verification plots are available for inspection on request.

Radiated measurements below 30 MHz were performed in a semi-anechoic chamber at a distance of 3 metres.

Verification plots of the two reference units at a measurement distance of 3 metres are shown on the following page. Plots were taken on an open field test site (29 November 2016) and in a semi-anechoic chamber (01 December 2016).

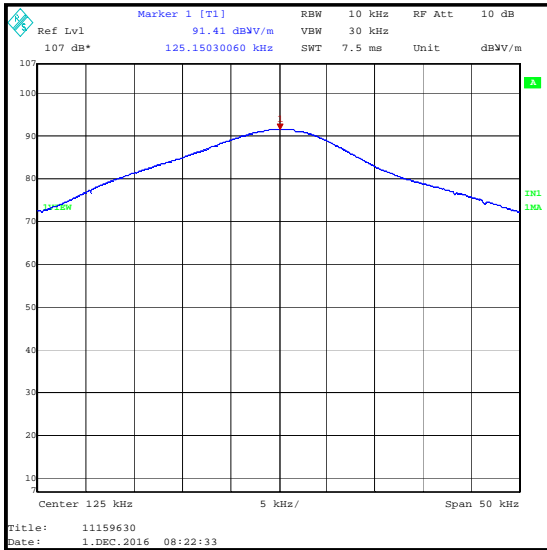

**125 kHz reference unit signal at 3 metres in a semi-anechoic chamber on 01 December 2016**

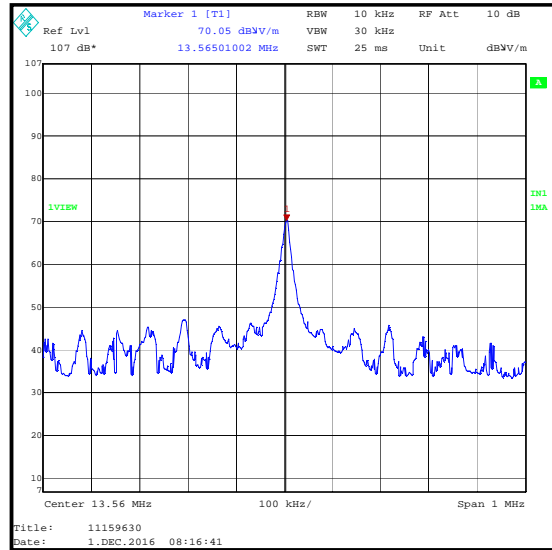

**13.56 MHz reference unit signal at 3 metres in a semi-anechoic chamber on 01 December 2016**

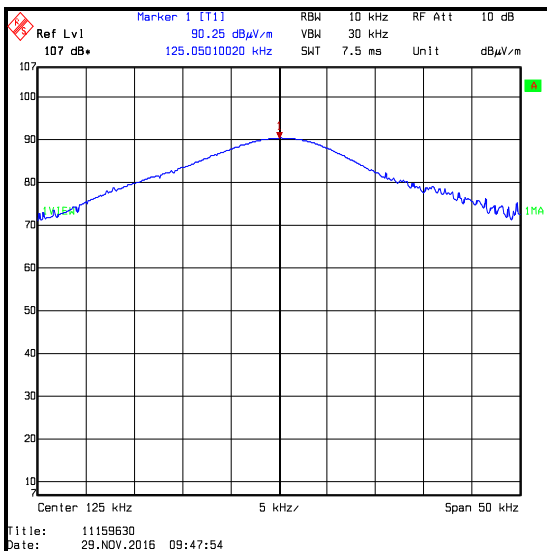

**125 kHz reference unit signal at 3 metres on an open field test site on 29 November 2016**

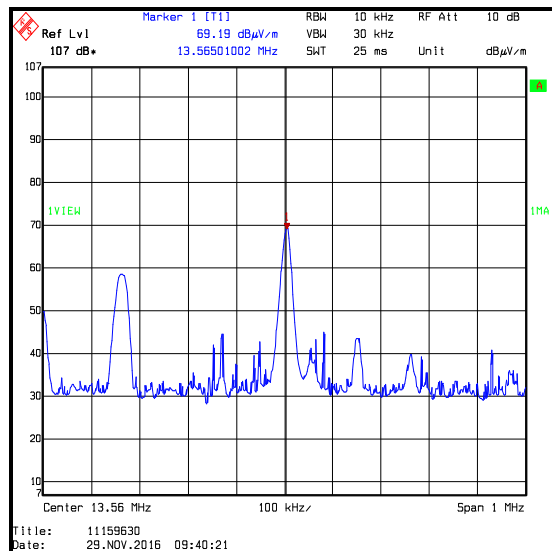

**13.56 MHz reference unit signal at 3 metres on an open field test site on 29 November 2016**

**Note(s):**

1. The above plots show comparable measurements of reference units on an open field test site and in a semi-anechoic chamber at spot frequencies.

**Background scans of the open field test site**

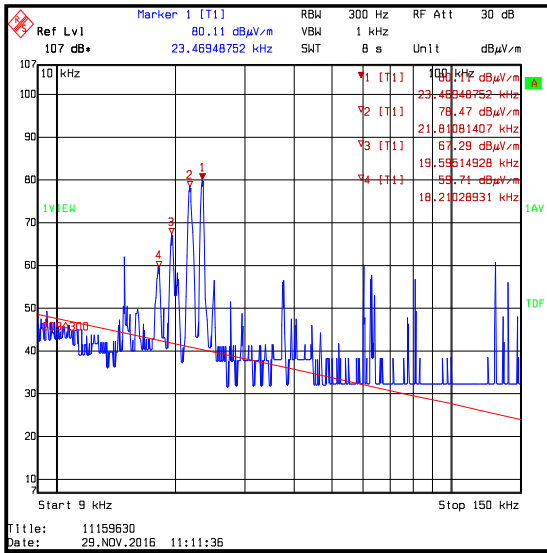

**Frequency range: 9 kHz to 150 kHz  
Average detector / background scan**

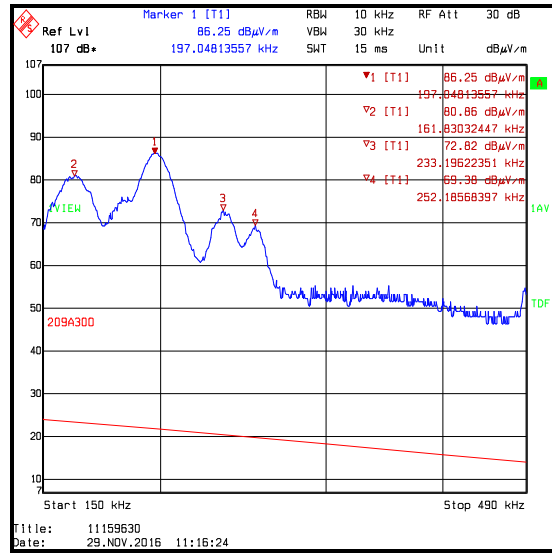

**Frequency range: 150 kHz to 490 kHz  
Average detector / background scan**

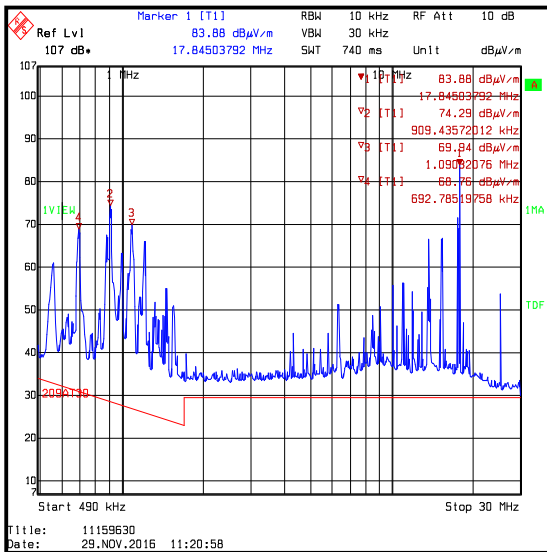

**Frequency range: 490 kHz to 30 MHz  
Peak detector / background scan**

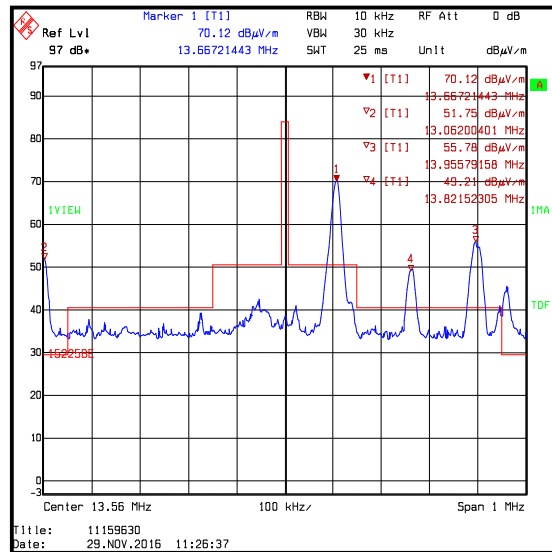

**Frequency range: 13.06 MHz to 14.06 MHz  
/ background scan of the open field test site**

**Note(s):**

1. The above plots are background scans of the open field test site. The EUT was turned off when the background scans were performed.

--- END OF REPORT ---