



Accredited by the Swiss Accreditation Service (SAS)
The Swiss Accreditation Service is one of the signatories to the EA
Multilateral Agreement for the recognition of calibration certificates

Accreditation No.: **SCS 0108**

Client **UL CCS USA**

Certificate No: **D750V3-1019_Mar17**

CALIBRATION CERTIFICATE

Object **D750V3 - SN:1019**

Calibration procedure(s) **QA CAL-05.v9
Calibration procedure for dipole validation kits above 700 MHz**

Calibration date: **March 13, 2017**

This calibration certificate documents the traceability to national standards, which realize the physical units of measurements (SI).
The measurements and the uncertainties with confidence probability are given on the following pages and are part of the certificate.

All calibrations have been conducted in the closed laboratory facility: environment temperature (22 ± 3)°C and humidity < 70%.

Calibration Equipment used (M&TE critical for calibration)

Primary Standards	ID #	Cal Date (Certificate No.)	Scheduled Calibration
Power meter NRP	SN: 104778	06-Apr-16 (No. 217-02288/02289)	Apr-17
Power sensor NRP-Z91	SN: 103244	06-Apr-16 (No. 217-02288)	Apr-17
Power sensor NRP-Z91	SN: 103245	06-Apr-16 (No. 217-02289)	Apr-17
Reference 20 dB Attenuator	SN: 5058 (20k)	05-Apr-16 (No. 217-02292)	Apr-17
Type-N mismatch combination	SN: 5047.2 / 06327	05-Apr-16 (No. 217-02295)	Apr-17
Reference Probe EX3DV4	SN: 7349	31-Dec-16 (No. EX3-7349_Dec16)	Dec-17
DAE4	SN: 601	04-Jan-17 (No. DAE4-601_Jan17)	Jan-18
Secondary Standards	ID #	Check Date (in house)	Scheduled Check
Power meter EPM-442A	SN: GB37480704	07-Oct-15 (in house check Oct-16)	In house check: Oct-18
Power sensor HP 8481A	SN: US37292783	07-Oct-15 (in house check Oct-16)	In house check: Oct-18
Power sensor HP 8481A	SN: MY41092317	07-Oct-15 (in house check Oct-16)	In house check: Oct-18
RF generator R&S SMT-06	SN: 100972	15-Jun-15 (in house check Oct-16)	In house check: Oct-18
Network Analyzer HP 8753E	SN: US37390585	18-Oct-01 (in house check Oct-16)	In house check: Oct-17

	Name	Function	Signature
Calibrated by:	Johannes Kurikka	Laboratory Technician	
Approved by:	Katja Pokovic	Technical Manager	

Issued: March 14, 2017

This calibration certificate shall not be reproduced except in full without written approval of the laboratory.



Accredited by the Swiss Accreditation Service (SAS)
The Swiss Accreditation Service is one of the signatories to the EA
Multilateral Agreement for the recognition of calibration certificates

Accreditation No.: **SCS 0108**

Glossary:

TSL	tissue simulating liquid
ConvF	sensitivity in TSL / NORM x,y,z
N/A	not applicable or not measured

Calibration is Performed According to the Following Standards:

- a) IEEE Std 1528-2013, "IEEE Recommended Practice for Determining the Peak Spatial-Averaged Specific Absorption Rate (SAR) in the Human Head from Wireless Communications Devices: Measurement Techniques", June 2013
- b) IEC 62209-1, "Procedure to measure the Specific Absorption Rate (SAR) for hand-held devices used in close proximity to the ear (frequency range of 300 MHz to 3 GHz)", February 2005
- c) IEC 62209-2, "Procedure to determine the Specific Absorption Rate (SAR) for wireless communication devices used in close proximity to the human body (frequency range of 30 MHz to 6 GHz)", March 2010
- d) KDB 865664, "SAR Measurement Requirements for 100 MHz to 6 GHz"

Additional Documentation:

- e) DASY4/5 System Handbook

Methods Applied and Interpretation of Parameters:

- *Measurement Conditions:* Further details are available from the Validation Report at the end of the certificate. All figures stated in the certificate are valid at the frequency indicated.
- *Antenna Parameters with TSL:* The dipole is mounted with the spacer to position its feed point exactly below the center marking of the flat phantom section, with the arms oriented parallel to the body axis.
- *Feed Point Impedance and Return Loss:* These parameters are measured with the dipole positioned under the liquid filled phantom. The impedance stated is transformed from the measurement at the SMA connector to the feed point. The Return Loss ensures low reflected power. No uncertainty required.
- *Electrical Delay:* One-way delay between the SMA connector and the antenna feed point. No uncertainty required.
- *SAR measured:* SAR measured at the stated antenna input power.
- *SAR normalized:* SAR as measured, normalized to an input power of 1 W at the antenna connector.
- *SAR for nominal TSL parameters:* The measured TSL parameters are used to calculate the nominal SAR result.

The reported uncertainty of measurement is stated as the standard uncertainty of measurement multiplied by the coverage factor $k=2$, which for a normal distribution corresponds to a coverage probability of approximately 95%.

Measurement Conditions

DASY system configuration, as far as not given on page 1.

DASY Version	DASY5	V52.8.8
Extrapolation	Advanced Extrapolation	
Phantom	Modular Flat Phantom	
Distance Dipole Center - TSL	15 mm	with Spacer
Zoom Scan Resolution	dx, dy, dz = 5 mm	
Frequency	750 MHz ± 1 MHz	

Head TSL parameters

The following parameters and calculations were applied.

	Temperature	Permittivity	Conductivity
Nominal Head TSL parameters	22.0 °C	41.9	0.89 mho/m
Measured Head TSL parameters	(22.0 ± 0.2) °C	40.9 ± 6 %	0.91 mho/m ± 6 %
Head TSL temperature change during test	< 0.5 °C	----	----

SAR result with Head TSL

SAR averaged over 1 cm³ (1 g) of Head TSL	Condition	
SAR measured	250 mW input power	2.10 W/kg
SAR for nominal Head TSL parameters	normalized to 1W	8.22 W/kg ± 17.0 % (k=2)

SAR averaged over 10 cm³ (10 g) of Head TSL	condition	
SAR measured	250 mW input power	1.37 W/kg
SAR for nominal Head TSL parameters	normalized to 1W	5.39 W/kg ± 16.5 % (k=2)

Body TSL parameters

The following parameters and calculations were applied.

	Temperature	Permittivity	Conductivity
Nominal Body TSL parameters	22.0 °C	55.5	0.96 mho/m
Measured Body TSL parameters	(22.0 ± 0.2) °C	54.6 ± 6 %	0.99 mho/m ± 6 %
Body TSL temperature change during test	< 0.5 °C	----	----

SAR result with Body TSL

SAR averaged over 1 cm³ (1 g) of Body TSL	Condition	
SAR measured	250 mW input power	2.25 W/kg
SAR for nominal Body TSL parameters	normalized to 1W	8.76 W/kg ± 17.0 % (k=2)

SAR averaged over 10 cm³ (10 g) of Body TSL	condition	
SAR measured	250 mW input power	1.48 W/kg
SAR for nominal Body TSL parameters	normalized to 1W	5.80 W/kg ± 16.5 % (k=2)

Appendix (Additional assessments outside the scope of SCS 0108)

Antenna Parameters with Head TSL

Impedance, transformed to feed point	56.4 Ω + 3.2 j Ω
Return Loss	- 23.4 dB

Antenna Parameters with Body TSL

Impedance, transformed to feed point	51.9 Ω + 0.3 j Ω
Return Loss	- 34.4 dB

General Antenna Parameters and Design

Electrical Delay (one direction)	1.038 ns
----------------------------------	----------

After long term use with 100W radiated power, only a slight warming of the dipole near the feedpoint can be measured.

The dipole is made of standard semirigid coaxial cable. The center conductor of the feeding line is directly connected to the second arm of the dipole. The antenna is therefore short-circuited for DC-signals. On some of the dipoles, small end caps are added to the dipole arms in order to improve matching when loaded according to the position as explained in the "Measurement Conditions" paragraph. The SAR data are not affected by this change. The overall dipole length is still according to the Standard.

No excessive force must be applied to the dipole arms, because they might bend or the soldered connections near the feedpoint may be damaged.

Additional EUT Data

Manufactured by	SPEAG
Manufactured on	November 11, 2010

Test Laboratory: SPEAG, Zurich, Switzerland

DUT: Dipole 750 MHz; Type: D750V3; Serial: D750V3 - SN:1019

Communication System: UID 0 - CW; Frequency: 750 MHz

Medium parameters used: $f = 750 \text{ MHz}$; $\sigma = 0.91 \text{ S/m}$; $\epsilon_r = 40.9$; $\rho = 1000 \text{ kg/m}^3$

Phantom section: Flat Section

Measurement Standard: DASY5 (IEEE/IEC/ANSI C63.19-2011)

DASY52 Configuration:

- Probe: EX3DV4 - SN7349; ConvF(10.17, 10.17, 10.17); Calibrated: 31.12.2016;
- Sensor-Surface: 1.4mm (Mechanical Surface Detection)
- Electronics: DAE4 Sn601; Calibrated: 04.01.2017
- Phantom: Flat Phantom 4.9 (front); Type: QD 00L P49 AA; Serial: 1001
- DASY52 52.8.8(1258); SEMCAD X 14.6.10(7372)

Dipole Calibration for Head Tissue/Pin=250 mW, d=15mm/Zoom Scan (7x7x7)/Cube 0:

Measurement grid: $dx=5\text{mm}$, $dy=5\text{mm}$, $dz=5\text{mm}$

Reference Value = 59.11 V/m; Power Drift = 0.02 dB

Peak SAR (extrapolated) = 3.16 W/kg

SAR(1 g) = 2.1 W/kg; SAR(10 g) = 1.37 W/kg

Maximum value of SAR (measured) = 2.81 W/kg

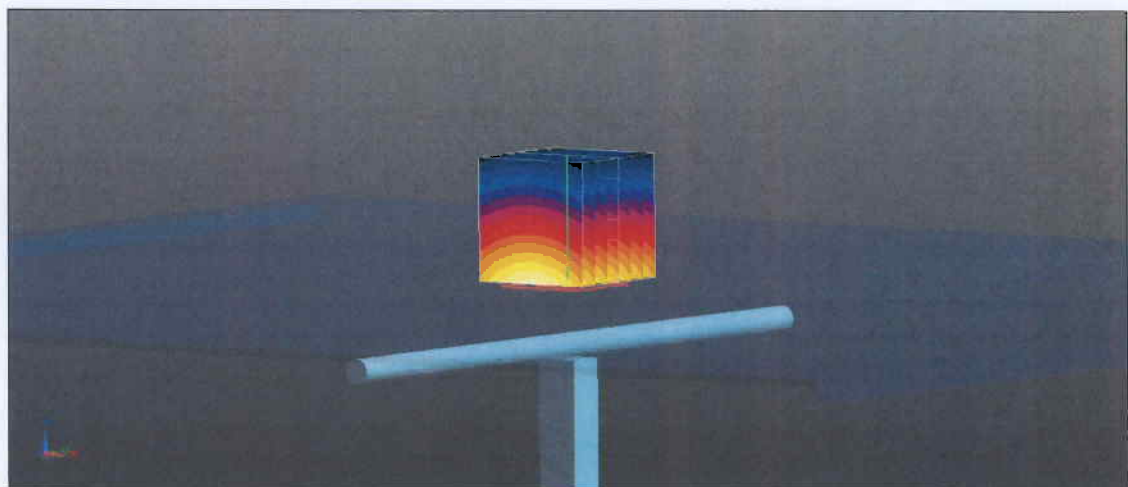
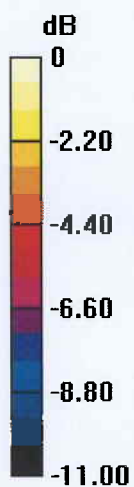

0 dB = 2.81 W/kg = 4.49 dBW/kg

Impedance Measurement Plot for Head TSL

13 Mar 2017 13:33:07

CH1 S11 1 U FS 1: 56.439 Ω 3.2070 Ω 680.55 μ H 750.000 000 MHz

*
De1
CA

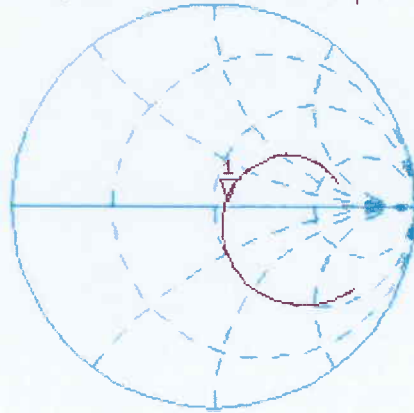

Avg
16

H1d

CH2 S11 LOG 5 dB/REF -20 dB 1: -23.405 dB 750.000 000 MHz

CA

Avg
16

H1d

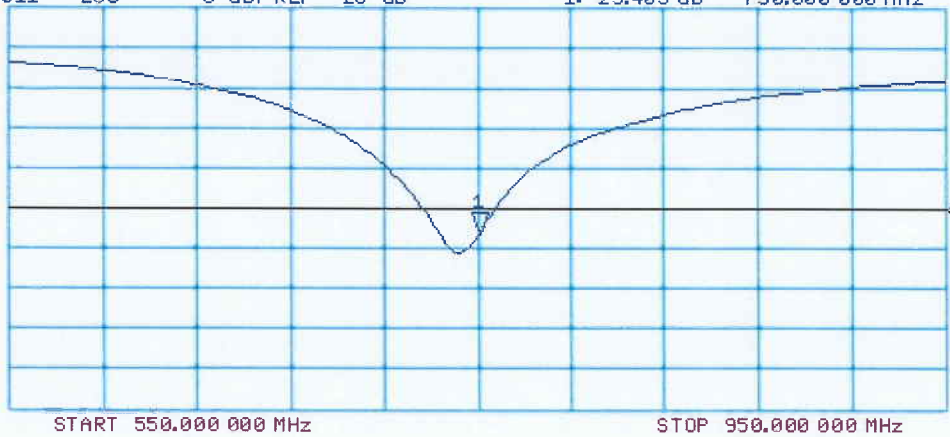

Test Laboratory: SPEAG, Zurich, Switzerland

DUT: Dipole 750 MHz; Type: D750V3; Serial: D750V3 - SN:1019

Communication System: UID 0 - CW; Frequency: 750 MHz

Medium parameters used: $f = 750$ MHz; $\sigma = 0.99$ S/m; $\epsilon_r = 54.6$; $\rho = 1000$ kg/m³

Phantom section: Flat Section

Measurement Standard: DASY5 (IEEE/IEC/ANSI C63.19-2011)

DASY52 Configuration:

- Probe: EX3DV4 - SN7349; ConvF(9.99, 9.99, 9.99); Calibrated: 31.12.2016;
- Sensor-Surface: 1.4mm (Mechanical Surface Detection)
- Electronics: DAE4 Sn601; Calibrated: 04.01.2017
- Phantom: Flat Phantom 4.9 (Back); Type: QD 00R P49 AA; Serial: 1005
- DASY52 52.8.8(1258); SEMCAD X 14.6.10(7372)

Dipole Calibration for Body Tissue/Pin=250 mW, d=15mm/Zoom Scan (7x7x7)/Cube 0:

Measurement grid: dx=5mm, dy=5mm, dz=5mm

Reference Value = 58.25 V/m; Power Drift = -0.02 dB

Peak SAR (extrapolated) = 3.36 W/kg

SAR(1 g) = 2.25 W/kg; SAR(10 g) = 1.48 W/kg

Maximum value of SAR (measured) = 3.00 W/kg

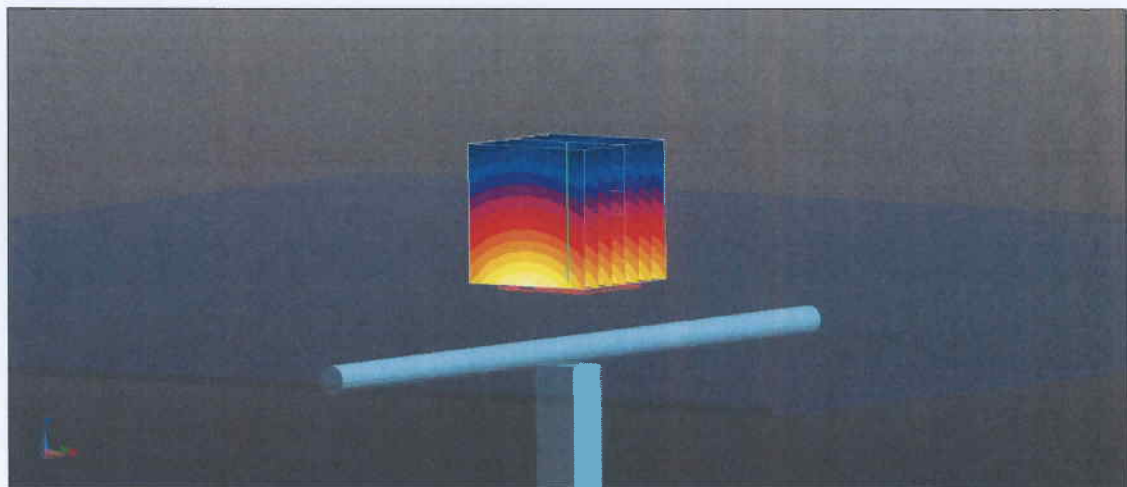
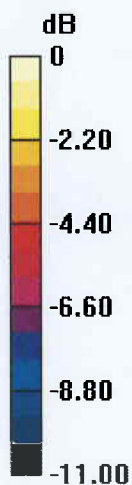

0 dB = 3.00 W/kg = 4.77 dBW/kg

Impedance Measurement Plot for Body TSL

13 Mar 2017 11:56:16

CH1 S11 1 U FS

1: 51.916 Ω 0.3184 Ω 67.558 pF

750.000 000 MHz

*
De1

CA

AVG
16

H1d

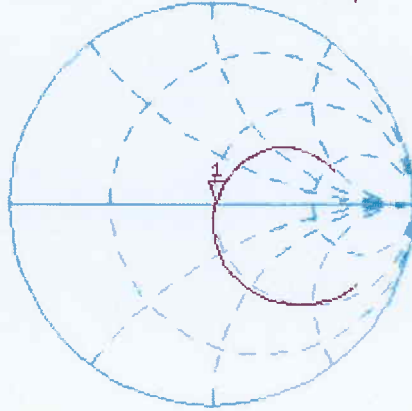

CH2 S11 LOG 5 dB/REF -20 dB 1: -34.399 dB 750.000 000 MHz

CA

AVG
16

H1d

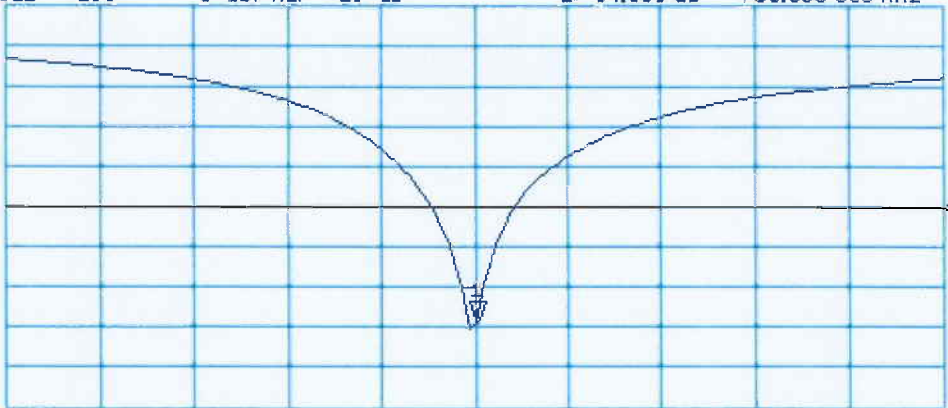

START 550.000 000 MHz

STOP 950.000 000 MHz



Accredited by the Swiss Accreditation Service (SAS)
The Swiss Accreditation Service is one of the signatories to the EA
Multilateral Agreement for the recognition of calibration certificates

Accreditation No.: **SCS 0108**

Client **UL CCS USA**

Certificate No: **D835V2-4d142_Oct17**

CALIBRATION CERTIFICATE

Object **D835V2 - SN:4d142**

Calibration procedure(s) **QA CAL-05.v9
Calibration procedure for dipole validation kits above 700 MHz**

Calibration date: **October 12, 2017**

This calibration certificate documents the traceability to national standards, which realize the physical units of measurements (SI).
The measurements and the uncertainties with confidence probability are given on the following pages and are part of the certificate.

All calibrations have been conducted in the closed laboratory facility: environment temperature (22 ± 3)°C and humidity < 70%.

Calibration Equipment used (M&TE critical for calibration)

Primary Standards	ID #	Cal Date (Certificate No.)	Scheduled Calibration
Power meter NRP	SN: 104778	04-Apr-17 (No. 217-02521/02522)	Apr-18
Power sensor NRP-Z91	SN: 103244	04-Apr-17 (No. 217-02521)	Apr-18
Power sensor NRP-Z91	SN: 103245	04-Apr-17 (No. 217-02522)	Apr-18
Reference 20 dB Attenuator	SN: 5058 (20k)	07-Apr-17 (No. 217-02528)	Apr-18
Type-N mismatch combination	SN: 5047.2 / 06327	07-Apr-17 (No. 217-02529)	Apr-18
Reference Probe EX3DV4	SN: 7349	31-May-17 (No. EX3-7349_May17)	May-18
DAE4	SN: 601	28-Mar-17 (No. DAE4-601_Mar17)	Mar-18

Secondary Standards	ID #	Check Date (in house)	Scheduled Check
Power meter EPM-442A	SN: GB37480704	07-Oct-15 (in house check Oct-16)	In house check: Oct-18
Power sensor HP 8481A	SN: US37292783	07-Oct-15 (in house check Oct-16)	In house check: Oct-18
Power sensor HP 8481A	SN: MY41092317	07-Oct-15 (in house check Oct-16)	In house check: Oct-18
RF generator R&S SMT-06	SN: 100972	15-Jun-15 (in house check Oct-16)	In house check: Oct-18
Network Analyzer HP 8753E	SN: US37390585	18-Oct-01 (in house check Oct-17)	In house check: Oct-18

	Name	Function	Signature
Calibrated by:	Leif Klysner	Laboratory Technician	
Approved by:	Katja Pokovic	Technical Manager	

Issued: October 13, 2017

This calibration certificate shall not be reproduced except in full without written approval of the laboratory.



Accredited by the Swiss Accreditation Service (SAS)

The Swiss Accreditation Service is one of the signatories to the EA
Multilateral Agreement for the recognition of calibration certificates

Glossary:

TSL	tissue simulating liquid
ConvF	sensitivity in TSL / NORM x,y,z
N/A	not applicable or not measured

Calibration is Performed According to the Following Standards:

- IEEE Std 1528-2013, "IEEE Recommended Practice for Determining the Peak Spatial-Averaged Specific Absorption Rate (SAR) in the Human Head from Wireless Communications Devices: Measurement Techniques", June 2013
- IEC 62209-1, "Measurement procedure for the assessment of Specific Absorption Rate (SAR) from hand-held and body-mounted devices used next to the ear (frequency range of 300 MHz to 6 GHz)", July 2016
- IEC 62209-2, "Procedure to determine the Specific Absorption Rate (SAR) for wireless communication devices used in close proximity to the human body (frequency range of 30 MHz to 6 GHz)", March 2010
- KDB 865664, "SAR Measurement Requirements for 100 MHz to 6 GHz"

Additional Documentation:

- DASY4/5 System Handbook

Methods Applied and Interpretation of Parameters:

- Measurement Conditions:* Further details are available from the Validation Report at the end of the certificate. All figures stated in the certificate are valid at the frequency indicated.
- Antenna Parameters with TSL:* The dipole is mounted with the spacer to position its feed point exactly below the center marking of the flat phantom section, with the arms oriented parallel to the body axis.
- Feed Point Impedance and Return Loss:* These parameters are measured with the dipole positioned under the liquid filled phantom. The impedance stated is transformed from the measurement at the SMA connector to the feed point. The Return Loss ensures low reflected power. No uncertainty required.
- Electrical Delay:* One-way delay between the SMA connector and the antenna feed point. No uncertainty required.
- SAR measured:* SAR measured at the stated antenna input power.
- SAR normalized:* SAR as measured, normalized to an input power of 1 W at the antenna connector.
- SAR for nominal TSL parameters:* The measured TSL parameters are used to calculate the nominal SAR result.

The reported uncertainty of measurement is stated as the standard uncertainty of measurement multiplied by the coverage factor $k=2$, which for a normal distribution corresponds to a coverage probability of approximately 95%.

Measurement Conditions

DASY system configuration, as far as not given on page 1.

DASY Version	DASY5	V52.10.0
Extrapolation	Advanced Extrapolation	
Phantom	Modular Flat Phantom	
Distance Dipole Center - TSL	15 mm	with Spacer
Zoom Scan Resolution	dx, dy, dz = 5 mm	
Frequency	835 MHz \pm 1 MHz	

Head TSL parameters

The following parameters and calculations were applied.

	Temperature	Permittivity	Conductivity
Nominal Head TSL parameters	22.0 °C	41.5	0.90 mho/m
Measured Head TSL parameters	(22.0 \pm 0.2) °C	40.7 \pm 6 %	0.92 mho/m \pm 6 %
Head TSL temperature change during test	< 0.5 °C	----	----

SAR result with Head TSL

SAR averaged over 1 cm³ (1 g) of Head TSL	Condition	
SAR measured	250 mW input power	2.46 W/kg
SAR for nominal Head TSL parameters	normalized to 1W	9.64 W/kg \pm 17.0 % (k=2)

SAR averaged over 10 cm³ (10 g) of Head TSL	condition	
SAR measured	250 mW input power	1.58 W/kg
SAR for nominal Head TSL parameters	normalized to 1W	6.22 W/kg \pm 16.5 % (k=2)

Body TSL parameters

The following parameters and calculations were applied.

	Temperature	Permittivity	Conductivity
Nominal Body TSL parameters	22.0 °C	55.2	0.97 mho/m
Measured Body TSL parameters	(22.0 \pm 0.2) °C	54.4 \pm 6 %	1.01 mho/m \pm 6 %
Body TSL temperature change during test	< 0.5 °C	----	----

SAR result with Body TSL

SAR averaged over 1 cm³ (1 g) of Body TSL	Condition	
SAR measured	250 mW input power	2.49 W/kg
SAR for nominal Body TSL parameters	normalized to 1W	9.63 W/kg \pm 17.0 % (k=2)

SAR averaged over 10 cm³ (10 g) of Body TSL	condition	
SAR measured	250 mW input power	1.61 W/kg
SAR for nominal Body TSL parameters	normalized to 1W	6.27 W/kg \pm 16.5 % (k=2)

Appendix (Additional assessments outside the scope of SCS 0108)

Antenna Parameters with Head TSL

Impedance, transformed to feed point	50.8 Ω - 3.4 $j\Omega$
Return Loss	- 29.3 dB

Antenna Parameters with Body TSL

Impedance, transformed to feed point	47.1 Ω - 6.0 $j\Omega$
Return Loss	- 23.3 dB

General Antenna Parameters and Design

Electrical Delay (one direction)	1.392 ns
----------------------------------	----------

After long term use with 100W radiated power, only a slight warming of the dipole near the feedpoint can be measured.

The dipole is made of standard semirigid coaxial cable. The center conductor of the feeding line is directly connected to the second arm of the dipole. The antenna is therefore short-circuited for DC-signals. On some of the dipoles, small end caps are added to the dipole arms in order to improve matching when loaded according to the position as explained in the "Measurement Conditions" paragraph. The SAR data are not affected by this change. The overall dipole length is still according to the Standard.

No excessive force must be applied to the dipole arms, because they might bend or the soldered connections near the feedpoint may be damaged.

Additional EUT Data

Manufactured by	SPEAG
Manufactured on	March 27, 2012

DASY5 Validation Report for Head TSL

Date: 12.10.2017

Test Laboratory: SPEAG, Zurich, Switzerland

DUT: Dipole 835 MHz; Type: D835V2; Serial: D835V2 - SN:4d142

Communication System: UID 0 - CW; Frequency: 835 MHz

Medium parameters used: $f = 835 \text{ MHz}$; $\sigma = 0.92 \text{ S/m}$; $\epsilon_r = 40.7$; $\rho = 1000 \text{ kg/m}^3$

Phantom section: Flat Section

Measurement Standard: DASY5 (IEEE/IEC/ANSI C63.19-2011)

DASY52 Configuration:

- Probe: EX3DV4 - SN7349; ConvF(10.07, 10.07, 10.07); Calibrated: 31.05.2017;
- Sensor-Surface: 1.4mm (Mechanical Surface Detection)
- Electronics: DAE4 Sn601; Calibrated: 28.03.2017
- Phantom: Flat Phantom 4.9 (front); Type: QD 00L P49 AA; Serial: 1001
- DASY52 52.10.0(1446); SEMCAD X 14.6.10(7417)

Dipole Calibration for Head Tissue/Pin=250 mW, d=15mm/Zoom Scan (7x7x7)/Cube 0:

Measurement grid: $dx=5\text{mm}$, $dy=5\text{mm}$, $dz=5\text{mm}$

Reference Value = 63.04 V/m; Power Drift = 0.00 dB

Peak SAR (extrapolated) = 3.87 W/kg

SAR(1 g) = 2.46 W/kg; SAR(10 g) = 1.58 W/kg

Maximum value of SAR (measured) = 3.37 W/kg

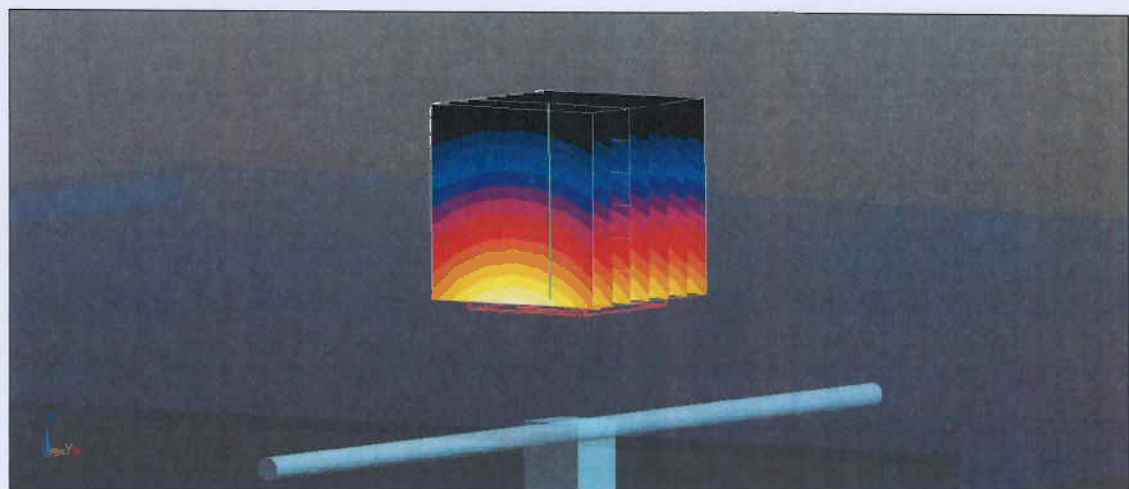
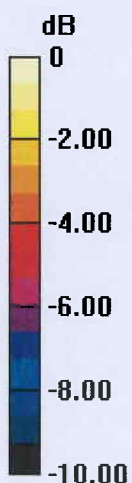

0 dB = 3.37 W/kg = 5.28 dBW/kg

Impedance Measurement Plot for Head TSL

12 Oct 2017 14:25:42

CH1 S11 1 U FS 1: 50.820 Ω -3.3574 Ω 56.771 pF 835.000 000 MHz

*
Del
CA

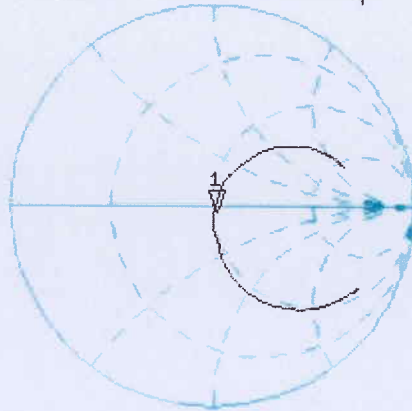

Avg
16

H1d

CH2 S11 LOG 5 dB/REF -20 dB 1: -29.311 dB 835.000 000 MHz

CA

Avg
16

H1d

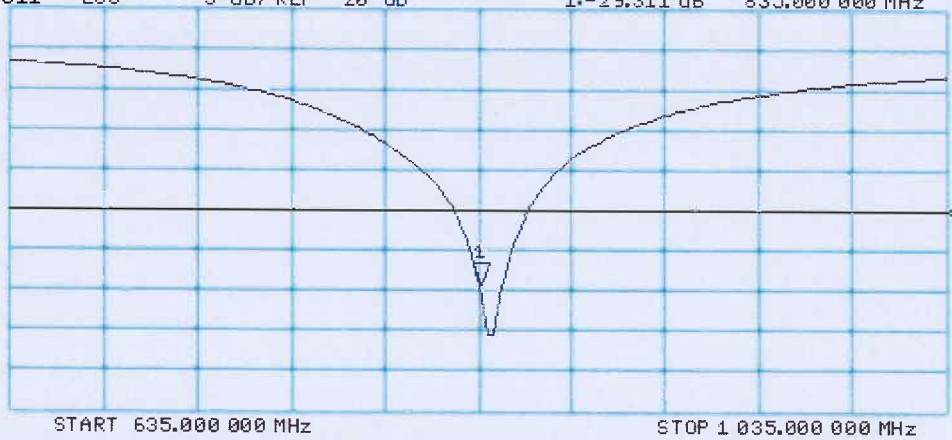

DASY5 Validation Report for Body TSL

Date: 12.10.2017

Test Laboratory: SPEAG, Zurich, Switzerland

DUT: Dipole 835 MHz; Type: D835V2; Serial: D835V2 - SN:4d142

Communication System: UID 0 - CW; Frequency: 835 MHz

Medium parameters used: $f = 835 \text{ MHz}$; $\sigma = 1.01 \text{ S/m}$; $\epsilon_r = 54.4$; $\rho = 1000 \text{ kg/m}^3$

Phantom section: Flat Section

Measurement Standard: DASY5 (IEEE/IEC/ANSI C63.19-2011)

DASY52 Configuration:

- Probe: EX3DV4 - SN7349; ConvF(10.2, 10.2, 10.2); Calibrated: 31.05.2017;
- Sensor-Surface: 1.4mm (Mechanical Surface Detection)
- Electronics: DAE4 Sn601; Calibrated: 28.03.2017
- Phantom: Flat Phantom 4.9 (Back); Type: QD 00R P49 AA; Serial: 1005
- DASY52 52.10.0(1446); SEMCAD X 14.6.10(7417)

Dipole Calibration for Body Tissue/Pin=250 mW, d=15mm/Zoom Scan (7x7x7)/Cube 0:

Measurement grid: $dx=5\text{mm}$, $dy=5\text{mm}$, $dz=5\text{mm}$

Reference Value = 60.44 V/m; Power Drift = -0.02 dB

Peak SAR (extrapolated) = 3.83 W/kg

SAR(1 g) = 2.49 W/kg; SAR(10 g) = 1.61 W/kg

Maximum value of SAR (measured) = 3.33 W/kg

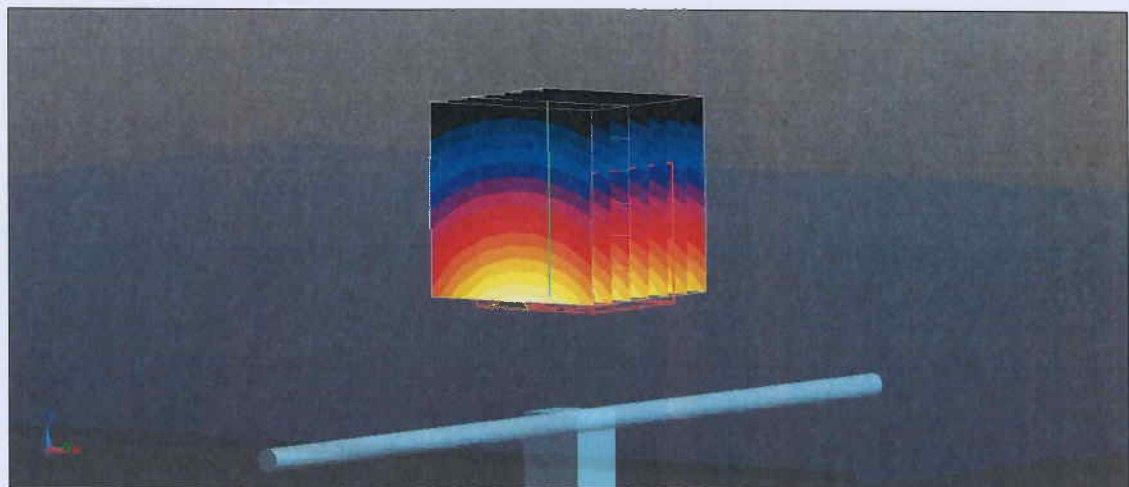
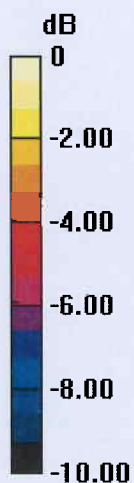

0 dB = 3.33 W/kg = 5.22 dBW/kg

Impedance Measurement Plot for Body TSL

12 Oct 2017 13:06:15
CH1 S11 1 U FS 1: 47.109 Ω -5.9531 Ω 32.018 μ F 835.000 000 MHz

*
Del

CA

Avg
16

H1d

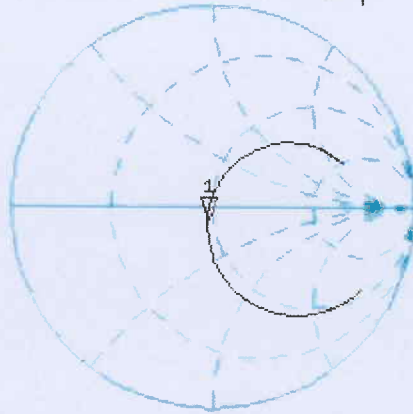

CH2 S11 LOG 5 dB/REF -20 dB 1: -23.344 dB 835.000 000 MHz

CA

Avg
16

H1d

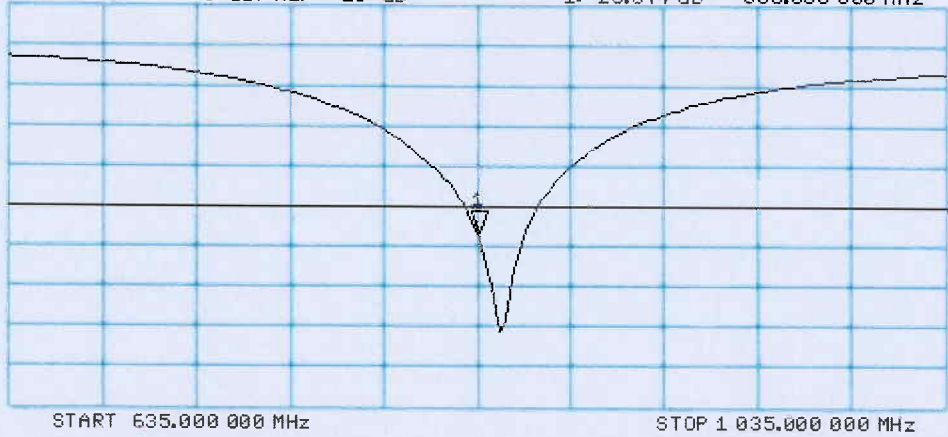

Appendix (Additional assessments outside the scope of SCS 0108)

Evaluation Condition

Phantom	SAM Head Phantom	For usage with cSAR3DV2-R/L
---------	------------------	-----------------------------

SAR result with SAM Head (Top)

SAR averaged over 1 cm ³ (1 g) of Head TSL	Condition	
SAR (average measured)	250 mW input power	2.34 W/kg
SAR for nominal Head TSL parameters	normalized to 1W	9.05 W/kg ± 17.5 % (k=2)

SAR averaged over 10 cm ³ (10 g) of Head TSL	condition	
SAR measured	250 mW input power	1.53 W/kg
SAR for nominal Head TSL parameters	normalized to 1W	5.97 W/kg ± 16.9 % (k=2)

SAR result with SAM Head (Mouth)

SAR averaged over 1 cm ³ (1 g) of Head TSL	Condition	
SAR (average measured)	250 mW input power	2.45 W/kg
SAR for nominal Head TSL parameters	normalized to 1W	9.50 W/kg ± 17.5 % (k=2)

SAR averaged over 10 cm ³ (10 g) of Head TSL	condition	
SAR (average measured)	250 mW input power	1.63 W/kg
SAR for nominal Head TSL parameters	normalized to 1W	6.36 W/kg ± 16.9 % (k=2)

SAR result with SAM Head (Neck)

SAR averaged over 1 cm ³ (1 g) of Head TSL	Condition	
SAR (average measured)	250 mW input power	2.32 W/kg
SAR for nominal Head TSL parameters	normalized to 1W	9.03 W/kg ± 17.5 % (k=2)

SAR averaged over 10 cm ³ (10 g) of Head TSL	condition	
SAR (average measured)	250 mW input power	1.55 W/kg
SAR for nominal Head TSL parameters	normalized to 1W	6.08 W/kg ± 16.9 % (k=2)

SAR result with SAM Head (Ear)

SAR averaged over 1 cm ³ (1 g) of Head TSL	Condition	
SAR (average measured)	250 mW input power	1.99 W/kg
SAR for nominal Head TSL parameters	normalized to 1W	7.73 W/kg ± 17.5 % (k=2)

SAR averaged over 10 cm ³ (10 g) of Head TSL	condition	
SAR (average measured)	250 mW input power	1.33 W/kg
SAR for nominal Head TSL parameters	normalized to 1W	5.18 W/kg ± 16.9 % (k=2)

CERTIFICATE OF CALIBRATION

ISSUED BY **UL VS LTD**

DATE OF ISSUE: 23/May/2017

CERTIFICATE NUMBER : 11762345JD01B



5248

UL VS LTD
PAVILION A
ASHWOOD PARK, ASHWOOD WAY
BASINGSTOKE, HAMPSHIRE
RG23 8BG, UK
TEL: +44 (0) 1256 312000
FAX: +44 (0) 1256 312001
Email: LST.UK.Calibration@ul.com



Page 1 of 10

APPROVED SIGNATORY

.....
Naseer Mirza

Customer :

UL VS Inc
47173 Benicia Street
Fremont, CA 94538, USA

Equipment Details:

Description:	Dipole Validation Kit	Date of Receipt:	09/May/2017
Manufacturer:	Speag		
Type/Model Number:	D835V2		
Serial Number:	4d117		
Calibration Date:	22/May/2017		
Calibrated By:	Chanthu Thevarajah Laboratory Engineer		

Signature:

.....

All Calibration have been conducted in the closed laboratory facility: Lab Temperature (22±3) °C and humidity < 70%

This certificate is issued in accordance with the laboratory accreditation requirements of the United Kingdom Accreditation Service. It provides traceability of measurement to the SI system of units and/or to units of measurement realised at the National Physical Laboratory or other recognised national metrology institutes. This certificate may not be reproduced other than in full, except with the prior written approval of the issuing laboratory.

Use of the UKAS mark demonstrates that compliance with the requirements of BS/EN/ISO/IEC 17025 has been independently assessed.

CERTIFICATE OF CALIBRATION

ISSUED BY UL VS LTD

UKAS Accredited Calibration Laboratory No. 5248

CERTIFICATE
NUMBER :
11762345JD01B

Page 2 of 10

The calibration methods and procedures used were as detailed in:

1. **IEC 62209-1:2005**: Procedure to determine the specific absorption rate (SAR) for hand-held devices used in close proximity to the ear (frequency range of 300 MHz to 3 GHz)
2. **IEC 62209-2:2010**: Procedure to determine the specific absorption rate (SAR) for wireless communication devices used in close proximity to the human body (frequency range of 30 MHz to 6 GHz)
3. **IEEE 1528: 2013**: IEEE Recommended Practice for Determining the Peak Spatial-Average Specific Absorption Rate (SAR) in the Human Head from Wireless Communication Devices: Measurement Techniques
4. FCC KDB Publication Number: **“KDB865664 D01 SAR Measurement 100 MHz to 6 GHz”**
5. **SPEAG DASY4/ DASY5 System Handbook**

The measuring equipment used to perform the calibration, documented in this certificate has been calibrated in accordance with the manufacturers' recommendations, and is traceable to recognized national standards.

UL No.	Instrument	Manufacturer	Type No.	Serial No.	Date Last Calibrated	Cal. Interval (Months)
A2110	Data Acquisition Electronics	SPEAG	DAE4	431	18 Nov 2016	12
A2587	Probe	SPEAG	ES3DV3	3341	29 Aug 2016	12
PRE0159049	Dipole	SPEAG	D835V2	438	28 April 2017	12
PRE0151451	Power Monitoring Kit	Art-Fi	ART 100850-01	0001	Cal as part of System	12
PRE0151441	Power Sensor	Rhode & Schwarz	NRP8S	102481	16 Nov 2016	12
M1015	Network Analyser	Agilent Technologies	8753ES	US39172406	26 Sept 2016	12
PRE0151154	Network Analyser	Rhode & Schwarz	ZND8	100151	22 Nov 2016	12
PRE0151877	Calibration Kit	Rhode & Schwarz	Z135	102947-Bt	09 May 2016	12
M1768	Signal Generator	Rhode & Schwarz	SME06	837633/001	08 Nov 2016	12

CERTIFICATE OF CALIBRATION

ISSUED BY UL VS LTD

UKAS Accredited Calibration Laboratory No. 5248

CERTIFICATE
NUMBER :
11762345JD01B

Page 3 of 10

SAR System Specification

Robot System Positioner:	Stäubli Unimation Corp. Robot Model: RX90L
Robot Serial Number:	F00/SD89A1/A/01
DASY Version:	DASY 4 (v4.7.80)
Phantom:	Flat section of SAM Twin Phantom
Distance Dipole Centre:	15 mm (with spacer)
Frequency:	835 MHz

Dielectric Property Measurements – Head Simulating Liquid (HSL)

Simulant Liquid	Frequency (MHz)	Room Temp		Liquid Temp		Parameters	Target Value	Measured Value	Uncertainty (%)
		Start	End	Start	End				
Head	835	21.0 °C	21.0 °C	21.0°C	21.0°C	ϵ_r	41.50	39.79	± 5%
						σ	0.90	0.91	± 5%

SAR Results – Head Simulating Liquid (HSL)

Simulant Liquid	SAR Measured	250 mW input Power	Normalised to 1.00 W	Uncertainty (%)
Head	SAR averaged over 1g	2.37 W/Kg	9.43 W/Kg	± 17.57%
	SAR averaged over 10g	1.53 W/Kg	6.09 W/Kg	± 17.32%

Antenna Parameters – Head Simulating Liquid (HSL)

Simulant Liquid	Parameter	Measured Level	Uncertainty (%)
Head	Impedance	46.5 Ω 1.37 j Ω	± 0.28 Ω ± 0.044 j Ω
	Return Loss	31.40	± 2.03 dB

CERTIFICATE OF CALIBRATION

ISSUED BY UL VS LTD

UKAS Accredited Calibration Laboratory No. 5248

CERTIFICATE
NUMBER :
11762345JD01B

Page 4 of 10

Dielectric Property Measurements – Body Simulating Liquid (MSL)

Simulant Liquid	Frequency (MHz)	Room Temp		Liquid Temp		Parameters	Target Value	Measured Value	Uncertainty (%)
		Start	End	Start	End				
Body	835	21.0 °C	21.0 °C	21.0°C	21.0°C	ϵ_r	55.20	53.58	± 5%
						σ	0.97	1.00	± 5%

SAR Results – Body Simulating Liquid (MSL)

Simulant Liquid	SAR Measured	250 mW input Power	Normalised to 1.00 W	Uncertainty (%)
Body	SAR averaged over 1g	2.61 W/Kg	10.39 W/Kg	± 18.06%
	SAR averaged over 10g	1.70 W/Kg	6.76 W/Kg	± 17.44%

Antenna Parameters – Body Simulating Liquid (MSL)

Simulant Liquid	Parameter	Measured Level	Uncertainty (%)
Body	Impedance	45.70 Ω 5.83 j Ω	± 0.28 Ω ± 0.044 j Ω
	Return Loss	22.89	± 2.03 dB

CERTIFICATE OF CALIBRATION

ISSUED BY UL VS LTD

CERTIFICATE
NUMBER :
11762345JD01B

UKAS Accredited Calibration Laboratory No. 5248

Page 5 of 10

DASY Validation Scan for Head Stimulating Liquid (HSL)

DUT: Dipole 835 MHz ; Type: D835V3; Serial: D7835V3 - SN:4d117

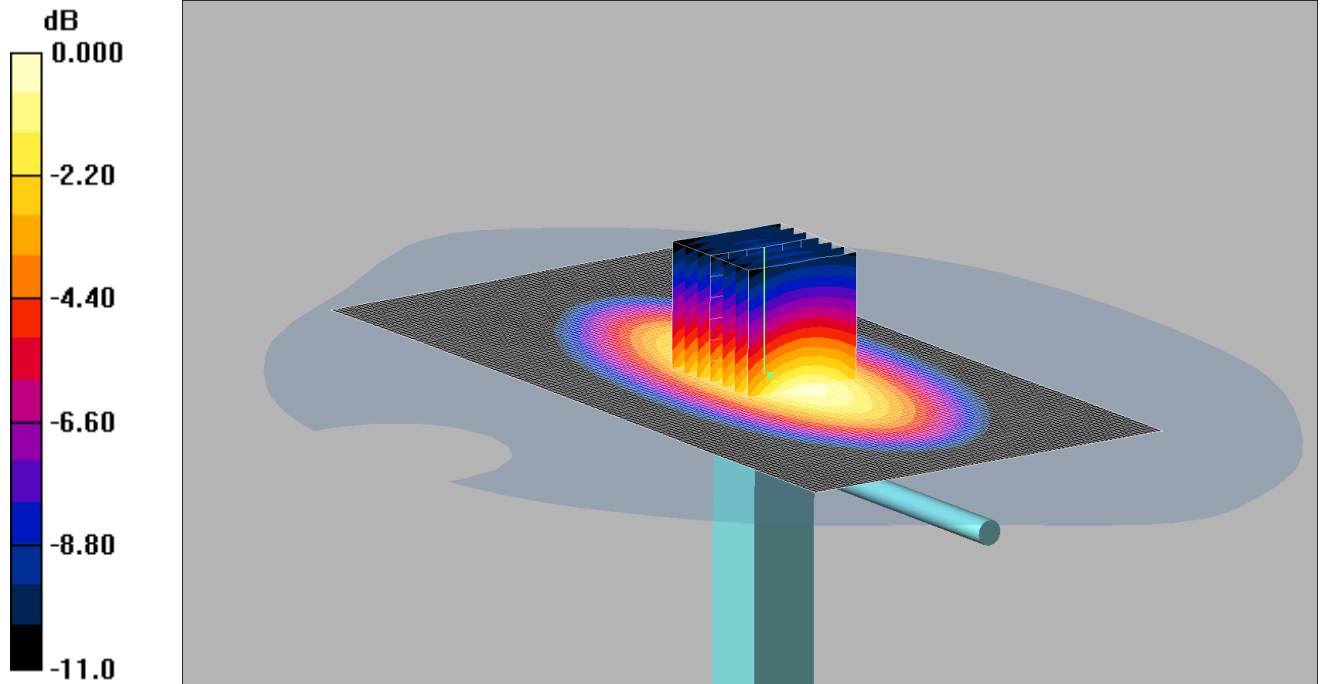

0 dB = 2.78mW/g

Communication System: CW 835; Frequency: 835 MHz; Duty Cycle: 1:1

Medium: 835 MHz HSL Medium parameters used (interpolated): $f = 835$ MHz; $\sigma = 0.913$ mho/m; $\epsilon_r = 39.8$; $\rho = 1000$ kg/m³

Phantom section: Flat Section

DASY4 Configuration:

- Probe: ES3DV3 - SN3341; ConvF(6.42, 6.42, 6.42);

- Sensor-Surface: 3mm (Mechanical Surface Detection)

- Electronics: DAE4 Sn431; Calibrated: 18/11/2016

- Phantom: SAM 12a (Site 57); Type: SAM 4.0; Serial: TP:1020

- Measurement SW: DASY4, V4.7 Build 80; Postprocessing SW: SEMCAD, V1.8 Build 186

d=15mm, Pin=250mW 3 2/Area Scan (81x161x1); Measurement grid: dx=12mm, dy=12mm

Maximum value of SAR (interpolated) = 2.73 mW/g

d=15mm, Pin=250mW 3 2/Zoom Scan (7x7x7) (7x7x7)/Cube 0; Measurement grid: dx=5mm, dy=5mm, dz=5mm

Reference Value = 52.2 V/m; Power Drift = 0.718 dB

Peak SAR (extrapolated) = 3.60 W/kg

SAR(1 g) = 2.37 mW/g; SAR(10 g) = 1.53 mW/g

Maximum value of SAR (measured) = 2.78 mW/g

CERTIFICATE OF CALIBRATION

ISSUED BY UL VS LTD

CERTIFICATE
NUMBER :
11762345JD01B

UKAS Accredited Calibration Laboratory No. 5248

Page 6 of 10

Impedance Measurement Plot for Head Stimulating Liquid (HSL)

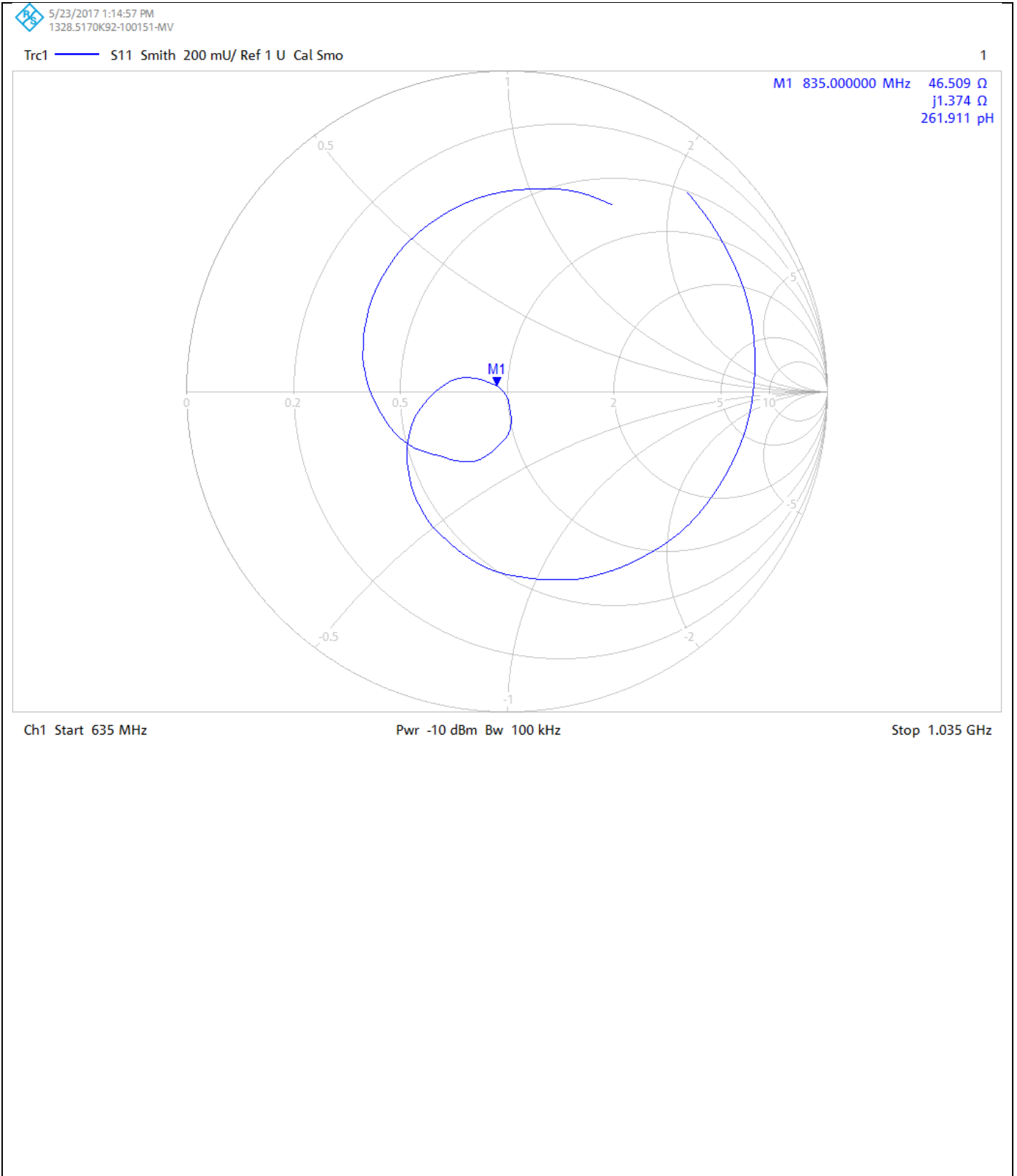

CERTIFICATE OF CALIBRATION

ISSUED BY UL VS LTD

UKAS Accredited Calibration Laboratory No. 5248

CERTIFICATE
NUMBER :
11762345JD01B

Page 7 of 10

Return Loss Measurement Plot for Head Stimulating Liquid (HSL)

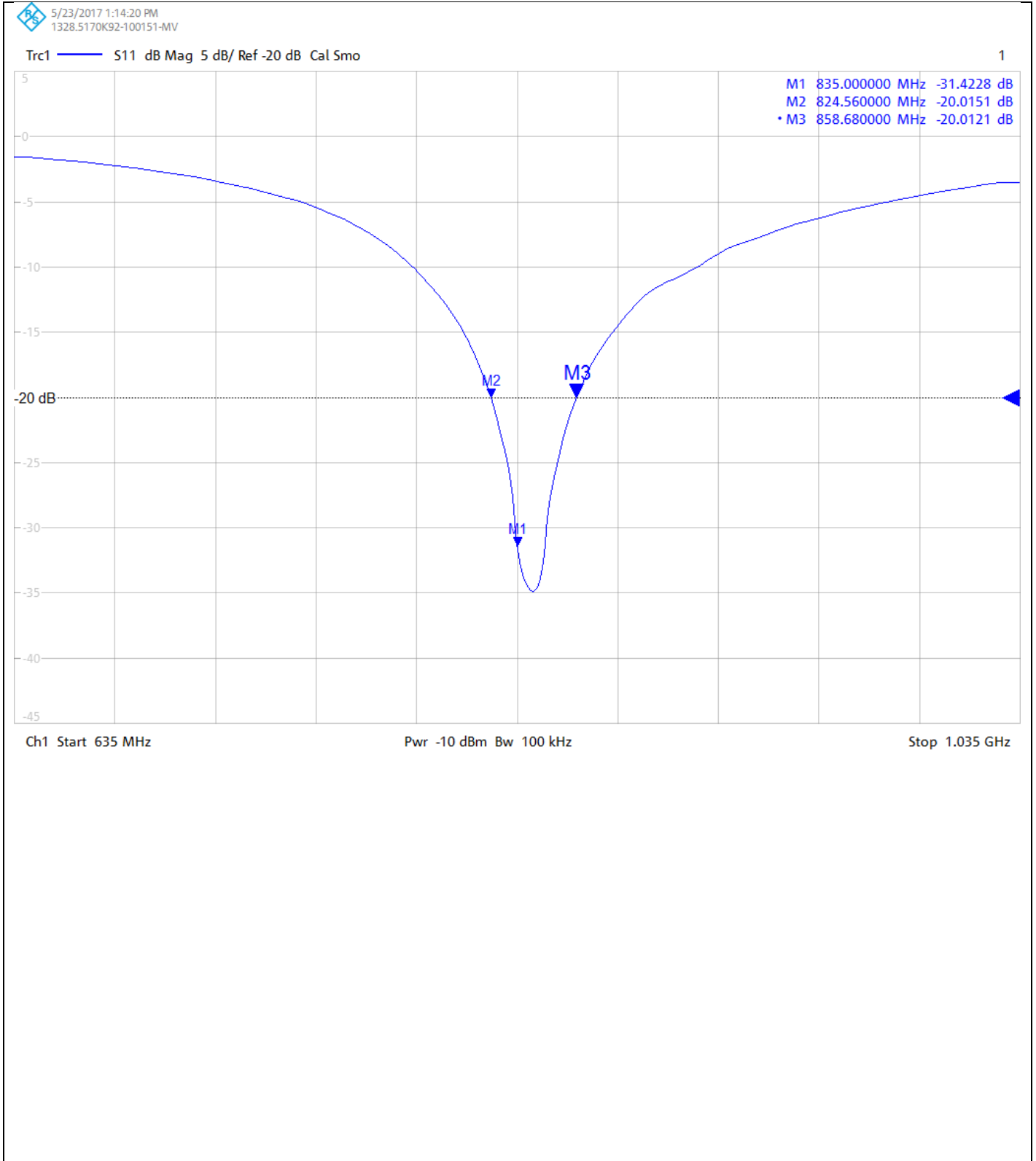

CERTIFICATE OF CALIBRATION

ISSUED BY UL VS LTD

UKAS Accredited Calibration Laboratory No. 5248

CERTIFICATE
NUMBER :
11762345JD01B

Page 8 of 10

DASY Validation Scan for Body Stimulating Liquid (MSL)

DUT: Dipole 835 MHz ; Type: D835V3; Serial: D7835V3 - SN:4d117

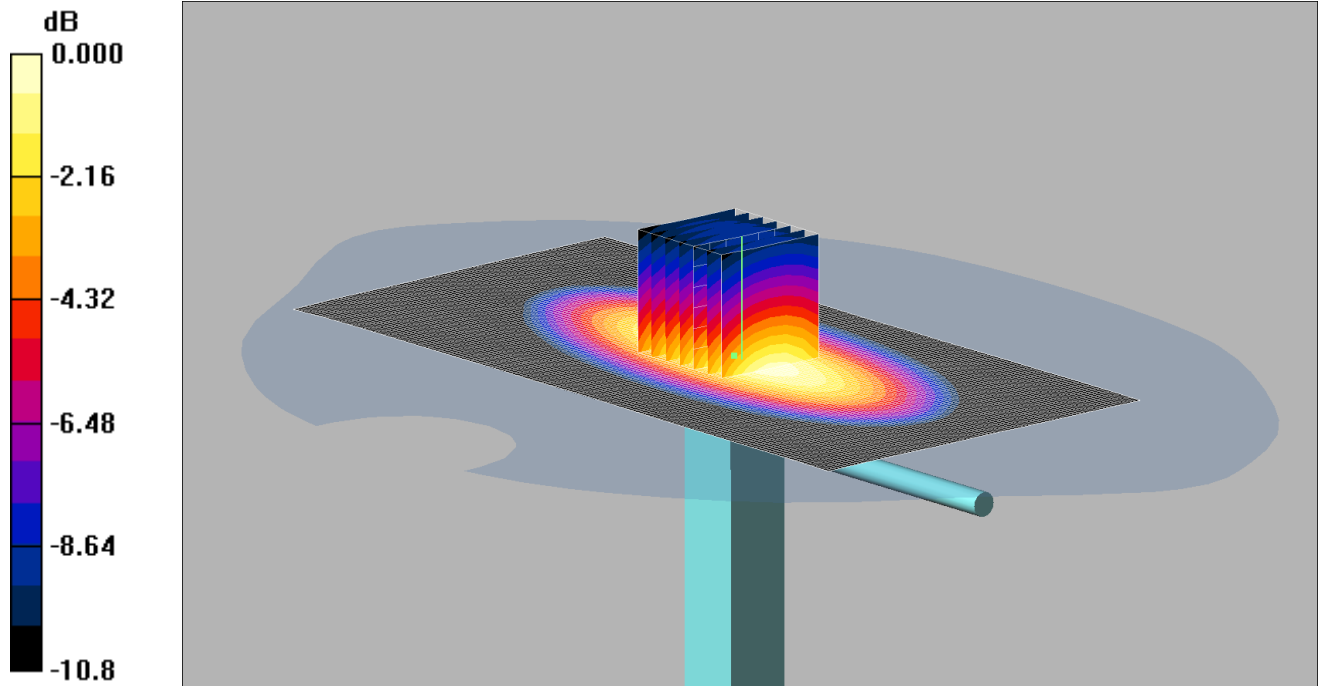

0 dB = 3.02mW/g

Communication System: CW 835; Frequency: 835 MHz; Duty Cycle: 1:1

Medium: 835 MHz MSL Medium parameters used (interpolated): $f = 835$ MHz; $\sigma = 0.999$ mho/m; $\epsilon_r = 53.6$; $\rho = 1000$ kg/m³

Phantom section: Flat Section

DASY4 Configuration:

- Probe: ES3DV3 - SN3341; ConvF(6.47, 6.47, 6.47);

- Sensor-Surface: 3mm (Mechanical Surface Detection)

- Electronics: DAE4 Sn431; Calibrated: 18/11/2016

- Phantom: SAM 12a (Site 57); Type: SAM 4.0; Serial: TP:1020

- Measurement SW: DASY4, V4.7 Build 80; Postprocessing SW: SEMCAD, V1.8 Build 186

d=15mm, Pin=250mW 2 /Area Scan (81x161x1): Measurement grid: dx=12mm, dy=12mm

Maximum value of SAR (interpolated) = 3.03 mW/g

d=15mm, Pin=250mW 2 /Zoom Scan (7x7x7) (7x7x7)/Cube 0: Measurement grid: dx=5mm, dy=5mm, dz=5mm

Reference Value = 57.0 V/m; Power Drift = 0.041 dB

Peak SAR (extrapolated) = 3.87 W/kg

SAR(1 g) = 2.61 mW/g; SAR(10 g) = 1.7 mW/g

Maximum value of SAR (measured) = 3.02 mW/g

CERTIFICATE OF CALIBRATION

ISSUED BY UL VS LTD

UKAS Accredited Calibration Laboratory No. 5248

CERTIFICATE
NUMBER :
11762345JD01B

Page 9 of 10

Impedance Measurement Plot for Body Stimulating Liquid (MSL)

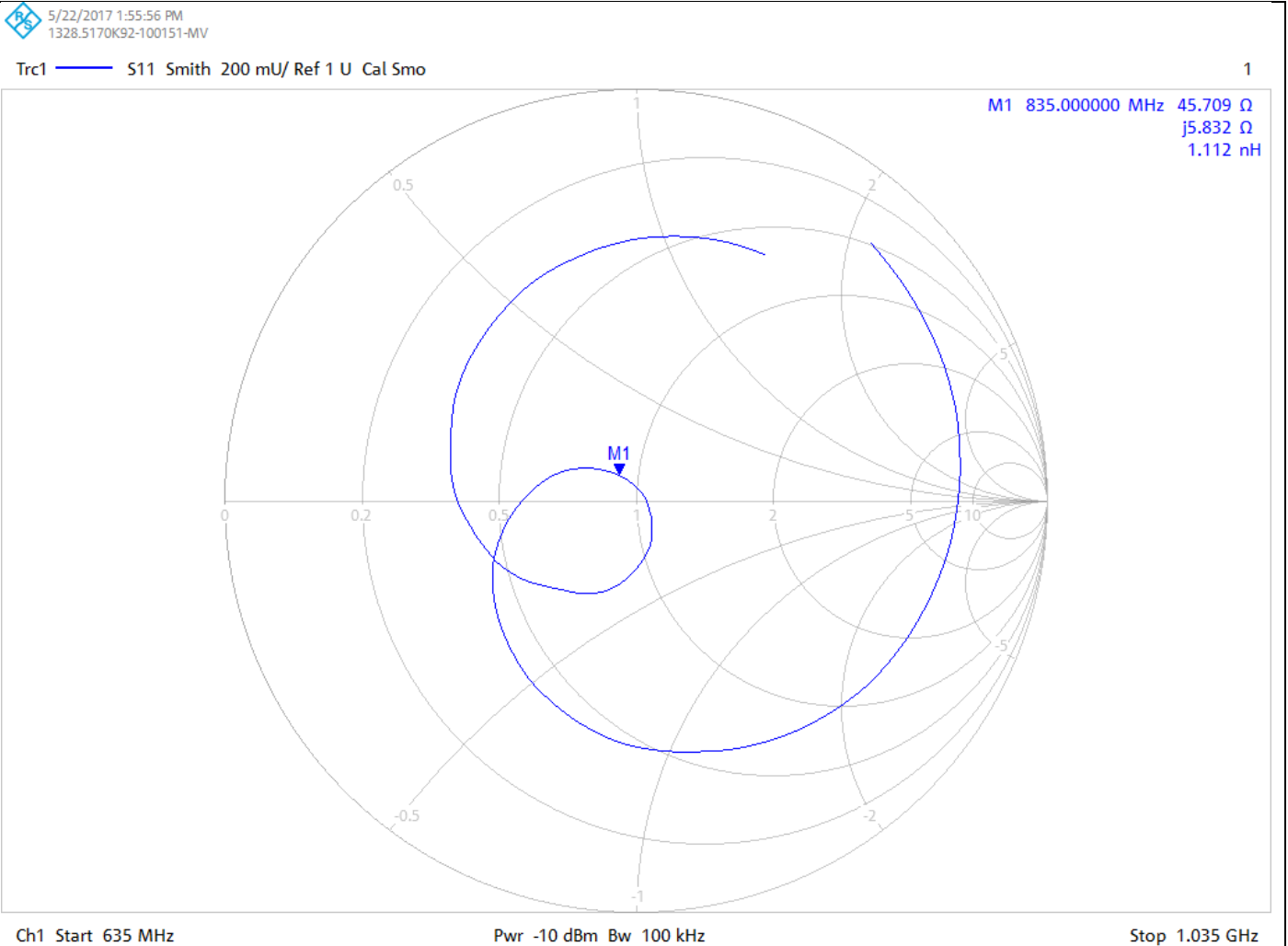

CERTIFICATE OF CALIBRATION

ISSUED BY UL VS LTD

UKAS Accredited Calibration Laboratory No. 5248

CERTIFICATE
NUMBER :
11762345JD01B

Page 10 of 10

Return Loss Measurement Plot for Body Stimulating Liquid (MSL)

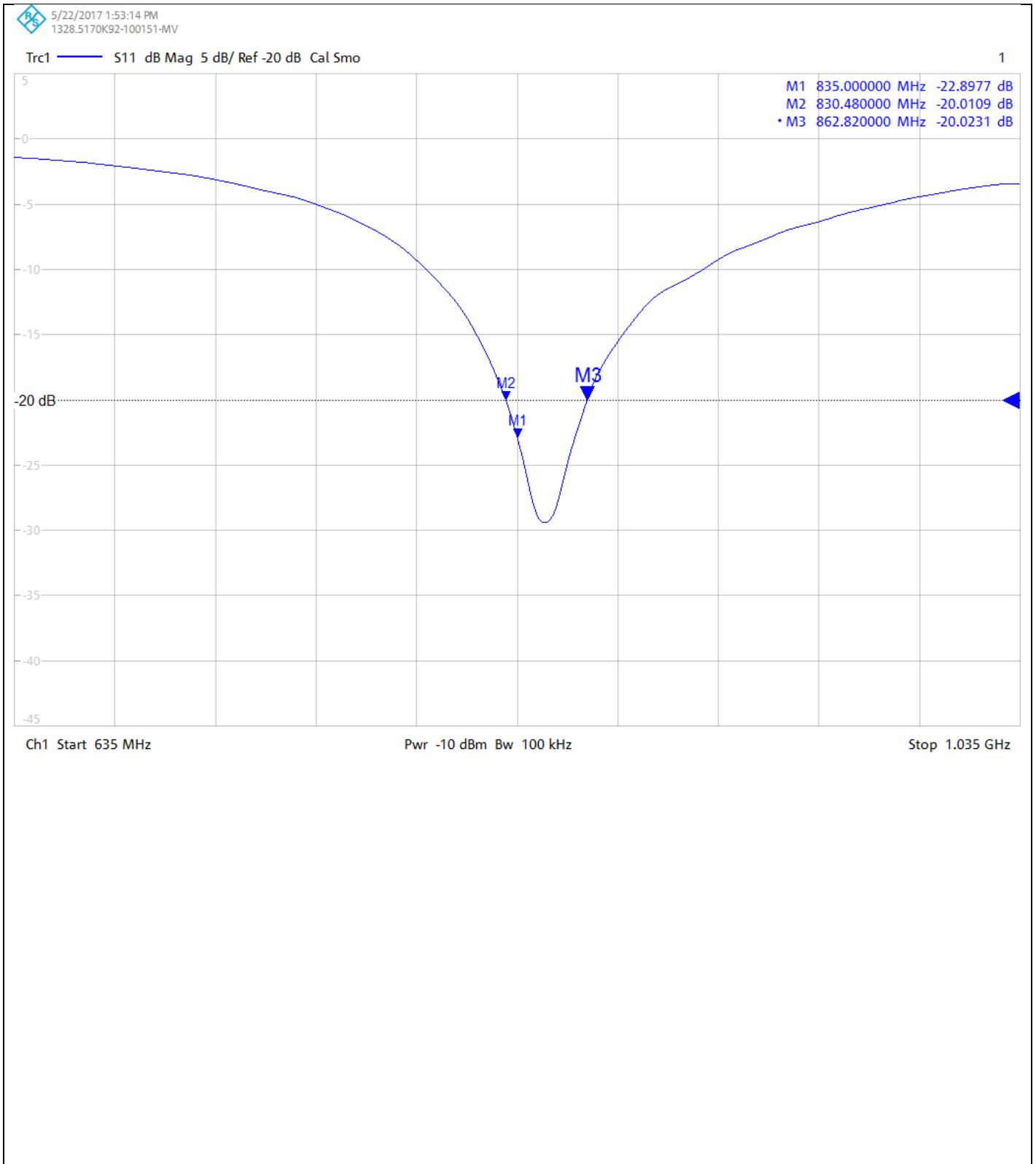

Calibration Certificate Label:

 <p>UKAS CALIBRATION 5248</p>	<p>UL VS LTD - Tel: +44 (0) 1256312000</p> <p>Certificate Number: 11762345JD01B</p> <p>Instrument ID: 4d117</p> <p>Calibration Date: 22/May/2017</p> <p>Calibration Due Date:</p>
--	--

 <p>UKAS CALIBRATION 5248</p>	<p>UL VS LTD - Tel: +44 (0) 1256312000</p> <p>Certificate Number: 11762345JD01B</p> <p>Instrument ID: 4d117</p> <p>Calibration Date: 22/May/2017</p> <p>Calibration Due Date:</p>
--	--

 <p>UKAS CALIBRATION 5248</p>	<p>UL VS LTD - Tel: +44 (0) 1256312000</p> <p>Certificate Number: 11762345JD01B</p> <p>Instrument ID: 4d117</p> <p>Calibration Date: 22/May/2017</p> <p>Calibration Due Date:</p>
--	--

CERTIFICATE OF CALIBRATION

ISSUED BY **UL VS LTD**

DATE OF ISSUE: 10/Oct/2017

CERTIFICATE NUMBER : 11903941JD01B



5248

UL VS LTD
PAVILION A
ASHWOOD PARK, ASHWOOD WAY
BASINGSTOKE, HAMPSHIRE
RG23 8BG, UK
TEL: +44 (0) 1256 312000
FAX: +44 (0) 1256 312001
Email: LST.UK.Calibration@ul.com



Page 1 of 10

APPROVED SIGNATORY

.....
Naseer Mirza

Customer :

UL VS Ltd
Pavilion A, Ashwood Park, Ashwood Way
Basingstoke, RG23 8BG, England

Equipment Details:

Description:	Dipole Validation Kit	Date of Receipt:	29/Sep/2017
Manufacturer:	Speag		
Type/Model Number:	D1750V2		
Serial Number:	1077		
Calibration Date:	05/Oct/2017		
Calibrated By:	Chanthu Thevarajah Laboratory Engineer		

Signature:

.....
All Calibration have been conducted in the closed laboratory facility: Lab Temperature (22±3) °C and humidity < 70%

This certificate is issued in accordance with the laboratory accreditation requirements of the United Kingdom Accreditation Service. It provides traceability of measurement to the SI system of units and/or to units of measurement realised at the National Physical Laboratory or other recognised national metrology institutes. This certificate may not be reproduced other than in full, except with the prior written approval of the issuing laboratory.

Use of the UKAS mark demonstrates that compliance with the requirements of BS/EN/ISO/IEC 17025 has been independently assessed.

CERTIFICATE OF CALIBRATION

ISSUED BY UL VS LTD

UKAS Accredited Calibration Laboratory No. 5248

CERTIFICATE
NUMBER :
11903941JD01B

Page 2 of 10

The calibration methods and procedures used were as detailed in:

1. **IEC 62209-1:2005**: Procedure to determine the specific absorption rate (SAR) for hand-held devices used in close proximity to the ear (frequency range of 300 MHz to 3 GHz)
2. **IEC 62209-2:2010**: Procedure to determine the specific absorption rate (SAR) for wireless communication devices used in close proximity to the human body (frequency range of 30 MHz to 6 GHz)
3. **IEEE 1528: 2013**: IEEE Recommended Practice for Determining the Peak Spatial-Average Specific Absorption Rate (SAR) in the Human Head from Wireless Communication Devices: Measurement Techniques
4. FCC KDB Publication Number: "KDB865664 D01 SAR Measurement 100 MHz to 6 GHz"
5. **SPEAG DASY4/ DASY5 System Handbook**

The measuring equipment used to perform the calibration, documented in this certificate has been calibrated in accordance with the manufacturers' recommendations, and is traceable to recognized national standards.

UL No.	Instrument	Manufacturer	Type No.	Serial No.	Date Last Calibrated	Cal. Interval (Months)
A2546	Data Acquisition Electronics	SPEAG	DAE4	1435	10 Feb 2017	12
A2587	Probe	SPEAG	ES3DV3	3341	14 Aug 2017	12
A1236	Dipole	SPEAG	D1800V2	2d009	09 Feb 2017	12
PRE0151451	Power Monitoring Kit	Art-Fi	ART 100850-01	0001	Cal as part of System	12
PRE0151441	Power Sensor	Rhode & Schwarz	NRP8S	102481	16 Nov 2016	12
M1015	Network Analyser	Agilent Technologies	8753ES	US39172406	26 Sept 2016	12
PRE0151154	Network Analyser	Rhode & Schwarz	ZND8	100151	22 Nov 2016	12
PRE0151877	Calibration Kit	Rhode & Schwarz	Z135	102947-Bt	02 Dec 2016	12
M1908	Signal Generator	Rhode & Schwarz	SMIQ 03B	1125.555.03	08 Nov 2016	12

CERTIFICATE OF CALIBRATION

ISSUED BY UL VS LTD

CERTIFICATE
NUMBER :
11903941JD01B

UKAS Accredited Calibration Laboratory No. 5248

Page 3 of 10

SAR System Specification

Robot System Positioner:	Stäubli Unimation Corp. Robot Model: TX60L
Robot Serial Number:	F14/5T5ZA1/A/01
DASY Version:	DASY 52 (v52.8.8.1258)
Phantom:	Flat section of SAM Twin Phantom
Distance Dipole Centre:	10 mm (with spacer)
Frequency:	1750 MHz

Dielectric Property Measurements – Head Simulating Liquid (HSL)

Simulant Liquid	Frequency (MHz)	Room Temp		Liquid Temp		Parameters	Target Value	Measured Value	Uncertainty (%)
		Start	End	Start	End				
Head	1750	23.0 °C	23.0 °C	20.0°C	20.0°C	ϵ_r	40.10	40.38	± 5%
						σ	1.37	1.39	± 5%

SAR Results – Head Simulating Liquid (HSL)

Simulant Liquid	SAR Measured	250 mW input Power	Normalised to 1.00 W	Uncertainty (%)
Head	SAR averaged over 1g	9.11 W/Kg	36.26 W/Kg	± 17.57%
	SAR averaged over 10g	4.86 W/Kg	19.34 W/Kg	± 17.32%

Antenna Parameters – Head Simulating Liquid (HSL)

Simulant Liquid	Parameter	Measured Level	Uncertainty (%)
Head	Impedance	49.21 Ω -0.63 j Ω	± 0.28 Ω ± 0.044 j Ω
	Return Loss	-36.48	± dB

CERTIFICATE OF CALIBRATION

ISSUED BY UL VS LTD

CERTIFICATE
NUMBER :
11903941JD01B

UKAS Accredited Calibration Laboratory No. 5248

Page 4 of 10

Dielectric Property Measurements – Body Simulating Liquid (MSL)

Simulant Liquid	Frequency (MHz)	Room Temp		Liquid Temp		Parameters	Target Value	Measured Value	Uncertainty (%)
		Start	End	Start	End				
Body	1750	22.0 °C	22.0 °C	22.0°C	22.0°C	ϵ_r	53.40	52.41	± 5%
						σ	1.49	1.47	± 5%

SAR Results – Body Simulating Liquid (MSL)

Simulant Liquid	SAR Measured	250 mW input Power	Normalised to 1.00 W	Uncertainty (%)
Body	SAR averaged over 1g	9.38 W/Kg	37.34 W/Kg	± 18.06%
	SAR averaged over 10g	5.02 W/Kg	19.98 W/Kg	± 17.44%

Antenna Parameters – Body Simulating Liquid (MSL)

Simulant Liquid	Parameter	Measured Level	Uncertainty (%)
Body	Impedance	49.29 Ω 3.26 $j\Omega$	± 0.28 Ω ± 0.044 $j\Omega$
	Return Loss	-29.63	± 2.03 dB

CERTIFICATE OF CALIBRATION

ISSUED BY UL VS LTD

CERTIFICATE
NUMBER :
11903941JD01B

UKAS Accredited Calibration Laboratory No. 5248

Page 5 of 10

DASY Validation Scan for Head Stimulating Liquid (HSL)

DUT: D1750V2 - SN1077; Type: D1750V2; Serial: SN1077

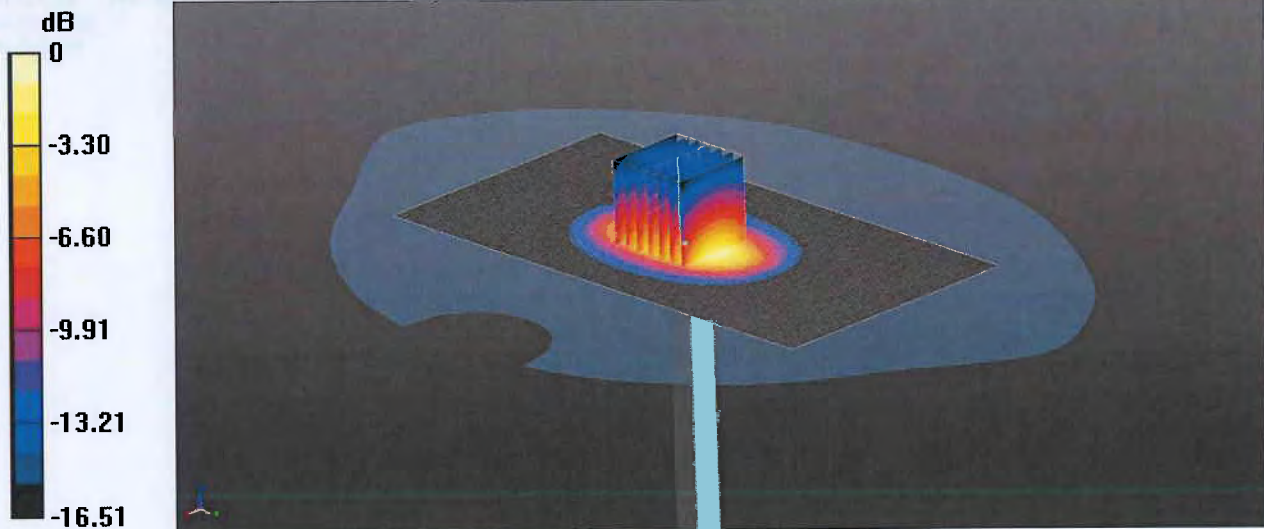

0 dB = 11.4 W/kg = 10.57 dBW/kg

Communication System: UID 0, CW (0); Frequency: 1750 MHz; Duty Cycle: 1:1

Medium: 1750 1800 MHz HSL Medium parameters used: $f = 1750$ MHz; $\sigma = 1.393$ S/m; $\epsilon_r = 40.378$; $\rho = 1000$ kg/m³

Phantom section: Flat Section

DASY4 Configuration:

- Probe: ES3DV3 - SN3341; ConvF(5.47, 5.47, 5.47); Calibrated: 14/08/2017;

- Sensor-Surface: 3mm (Mechanical Surface Detection)

- Electronics: DAE4 Sn1435; Calibrated: 10/02/2017

- Phantom: SAM (30deg probe tilt) with CRP v5.0; Type: QD000P40CD; Serial: TP:xxxx

-; SEMCAD X Version 14.6.10 (7372)

Configuration/d=10mm, Pin=250mW 2/Area Scan (81x151x1): Interpolated grid: dx=1.200 mm, dy=1.200 mm

Maximum value of SAR (interpolated) = 11.7 W/kg

Configuration/d=10mm, Pin=250mW 2/Zoom Scan (5x5x7) (7x7x7)/Cube 0: Measurement grid: dx=5mm, dy=5mm, dz=5mm

Reference Value = 93.81 V/m; Power Drift = -0.04 dB

Peak SAR (extrapolated) = 16.3 W/kg

SAR(1 g) = 9.11 W/kg; SAR(10 g) = 4.86 W/kg

Maximum value of SAR (measured) = 11.4 W/kg

CERTIFICATE OF CALIBRATION

ISSUED BY UL VS LTD

UKAS Accredited Calibration Laboratory No. 5248

CERTIFICATE
NUMBER :
11903941JD01B

Page 6 of 10

Impedance Measurement Plot for Head Stimulating Liquid (HSL)

10/10/2017 9:09:15 AM
1326.5170K92-100151-MV

Trc1 — S11 Smith 200 mU/ Ref 1 U Cal Smo

1

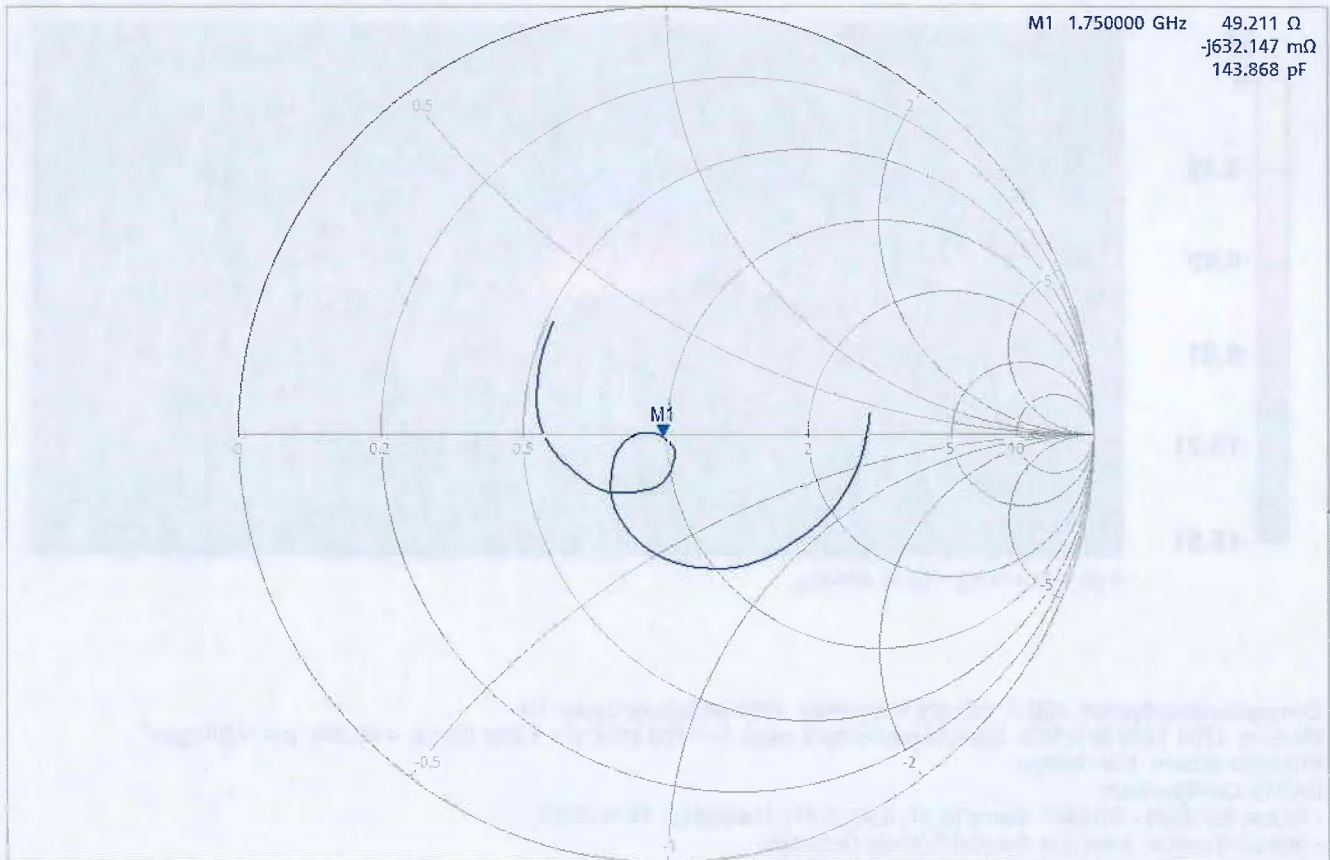

Ch1 Start 1.55 GHz

Pwr -10 dBm Bw 10 kHz

Stop 1.95 GHz

CERTIFICATE OF CALIBRATION

ISSUED BY UL VS LTD

UKAS Accredited Calibration Laboratory No. 5248

CERTIFICATE
NUMBER :
11903941JD01B

Page 7 of 10

Return Loss Measurement Plot for Head Stimulating Liquid (HSL)

10/10/2017 9:08:41 AM
1328.5170K92-100151-MV

Trc1 — 511 dB Mag 5 dB/ Ref -20 dB Cal Smo

1

M1 1.750000 GHz -36.4801 dB
M2 1.712060 GHz -20.0036 dB
• M3 1.807880 GHz -20.0071 dB

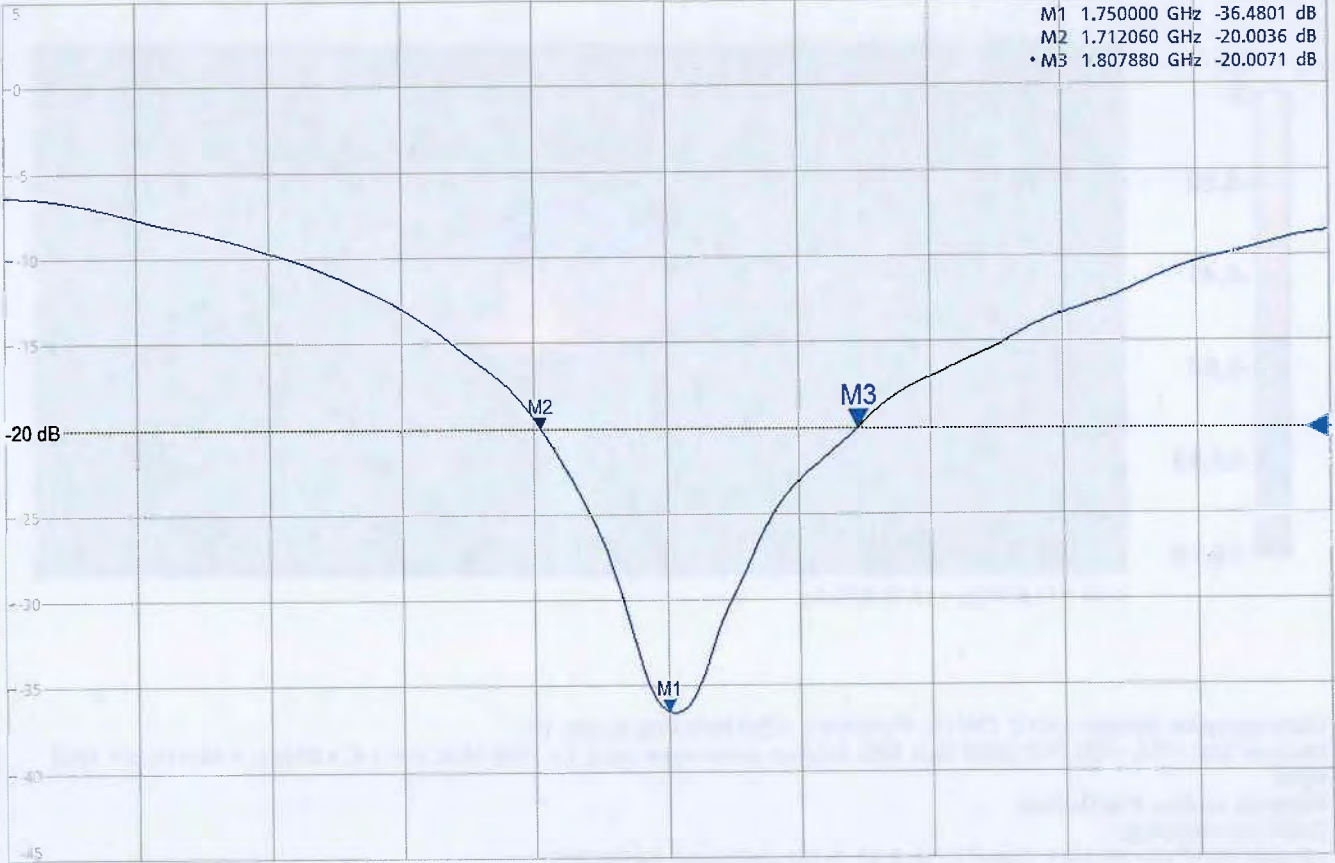

Ch1 Start 1.55 GHz

Pwr -10 dBm Bw 10 kHz

Stop 1.95 GHz

CERTIFICATE OF CALIBRATION

ISSUED BY UL VS LTD

CERTIFICATE
NUMBER :
11903941JD01B

UKAS Accredited Calibration Laboratory No. 5248

Page 8 of 10

DASY Validation Scan for Body Stimulating Liquid (MSL)

DUT: D1750V2 - SN1077; Type: D1750V2; Serial: SN1077

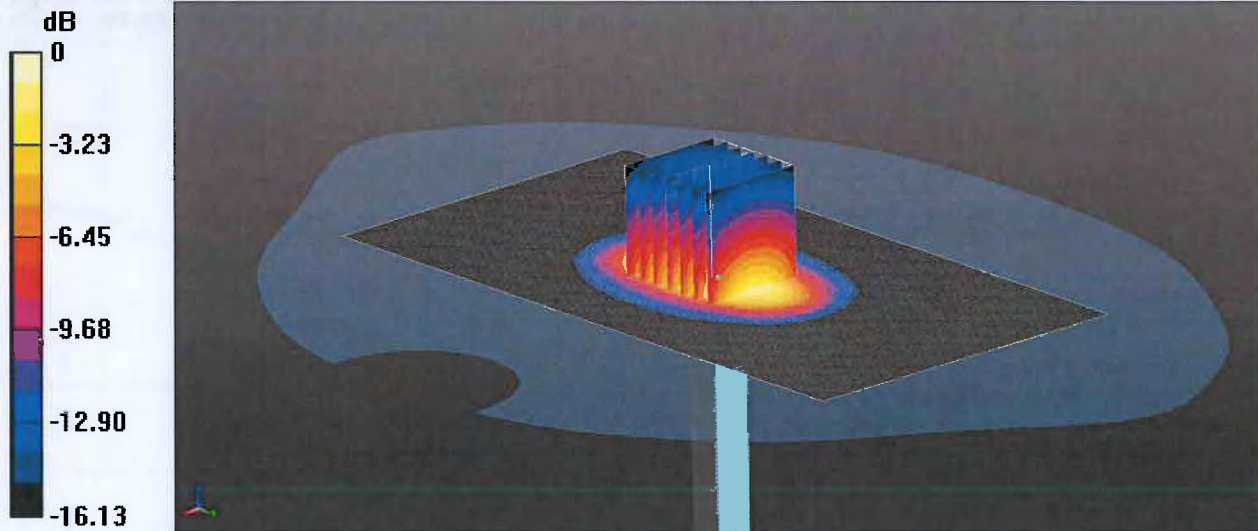

0 dB = 11.8 W/kg = 10.72 dBW/kg

Communication System: UID 0, CW (0); Frequency: 1750 MHz; Duty Cycle: 1:1

Medium: 900,1750,1800,1900,2600 MHz MSL Medium parameters used: $f = 1750$ MHz; $\sigma = 1.474$ S/m; $\epsilon_r = 52.411$; $\rho = 1000$ kg/m³

Phantom section: Flat Section

DASY4 Configuration:

- Probe: ES3DV3 - SN3341; ConvF(5.12, 5.12, 5.12); Calibrated: 14/08/2017;
- Sensor-Surface: 3mm (Mechanical Surface Detection)
- Electronics: DAE4 Sn1435; Calibrated: 10/02/2017
- Phantom: SAM (30deg probe tilt) with CRP v5.0; Type: QD000P40CD; Serial: TP:xxxx
- ; SEMCAD X Version 14.6.10 (7372)

Configuration/d=10mm, Pin=250mW 2 2 2 /Area Scan (81x151x1): Interpolated grid: dx=1.200 mm, dy=1.200 mm

Maximum value of SAR (interpolated) = 12.1 W/kg

Configuration/d=10mm, Pin=250mW 2 2 2 /Zoom Scan (5x5x7) (7x7x7)/Cube 0: Measurement grid: dx=5mm, dy=5mm, dz=5mm

Reference Value = 92.81 V/m; Power Drift = 0.01 dB

Peak SAR (extrapolated) = 16.5 W/kg

SAR(1 g) = 9.38 W/kg; SAR(10 g) = 5.02 W/kg

Maximum value of SAR (measured) = 11.8 W/kg

CERTIFICATE OF CALIBRATION

ISSUED BY UL VS LTD

CERTIFICATE
NUMBER :
11903941JD01B

UKAS Accredited Calibration Laboratory No. 5248

Page 9 of 10

Impedance Measurement Plot for Body Stimulating Liquid (MSL)

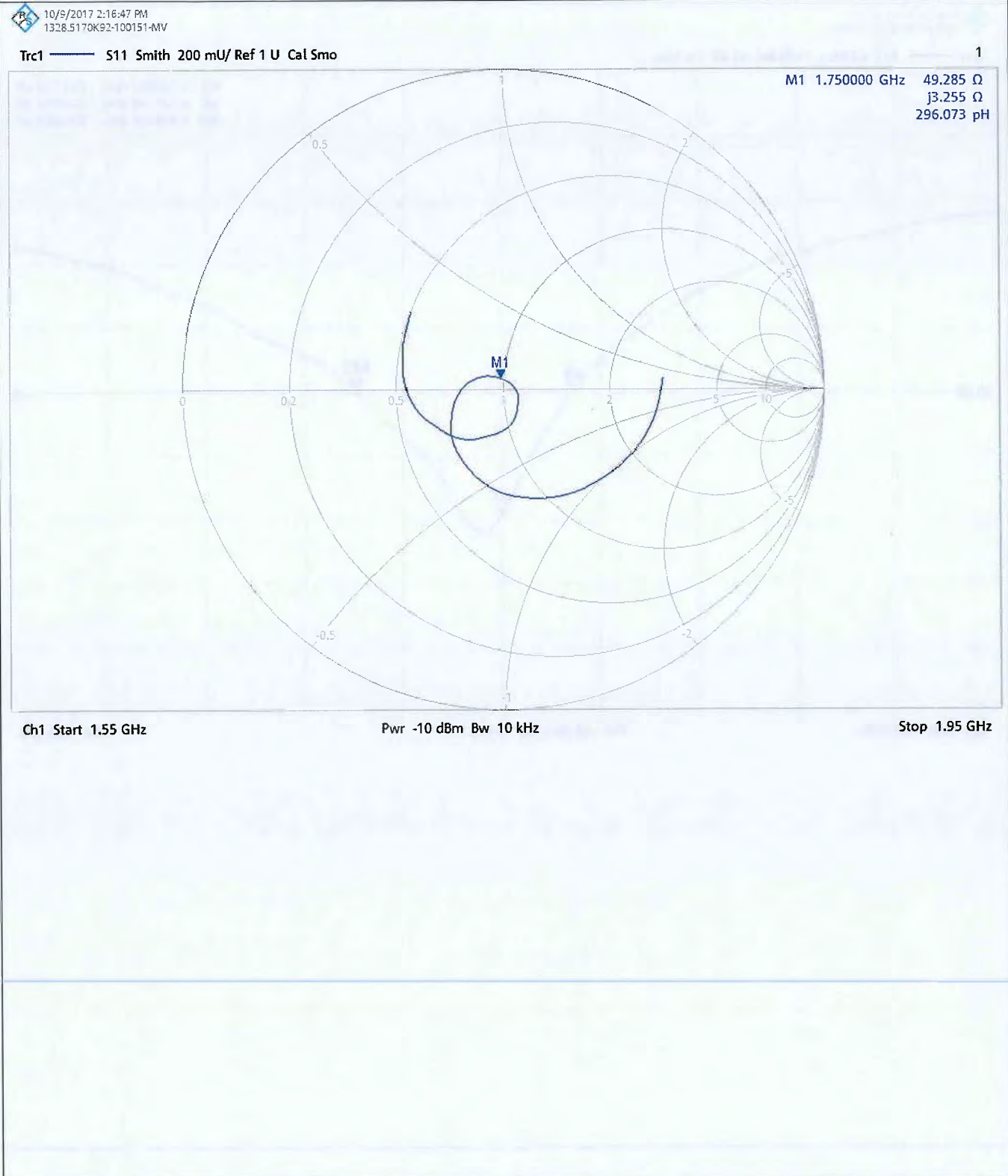

CERTIFICATE OF CALIBRATION

ISSUED BY UL VS LTD

UKAS Accredited Calibration Laboratory No. 5248

CERTIFICATE
NUMBER :
11903941JD01B

Page 10 of 10

Return Loss Measurement Plot for Body Stimulating Liquid (MSL)



10/9/2017 2:15:13 PM
1326.5170K92-100151-MV

Trc1 — S11 dB Mag 5 dB/Ref -20 dB Cal Smo

1

M1 1.750000 GHz -29.6316 dB
M2 1.721140 GHz -20.0051 dB
M3 1.808980 GHz -20.0057 dB

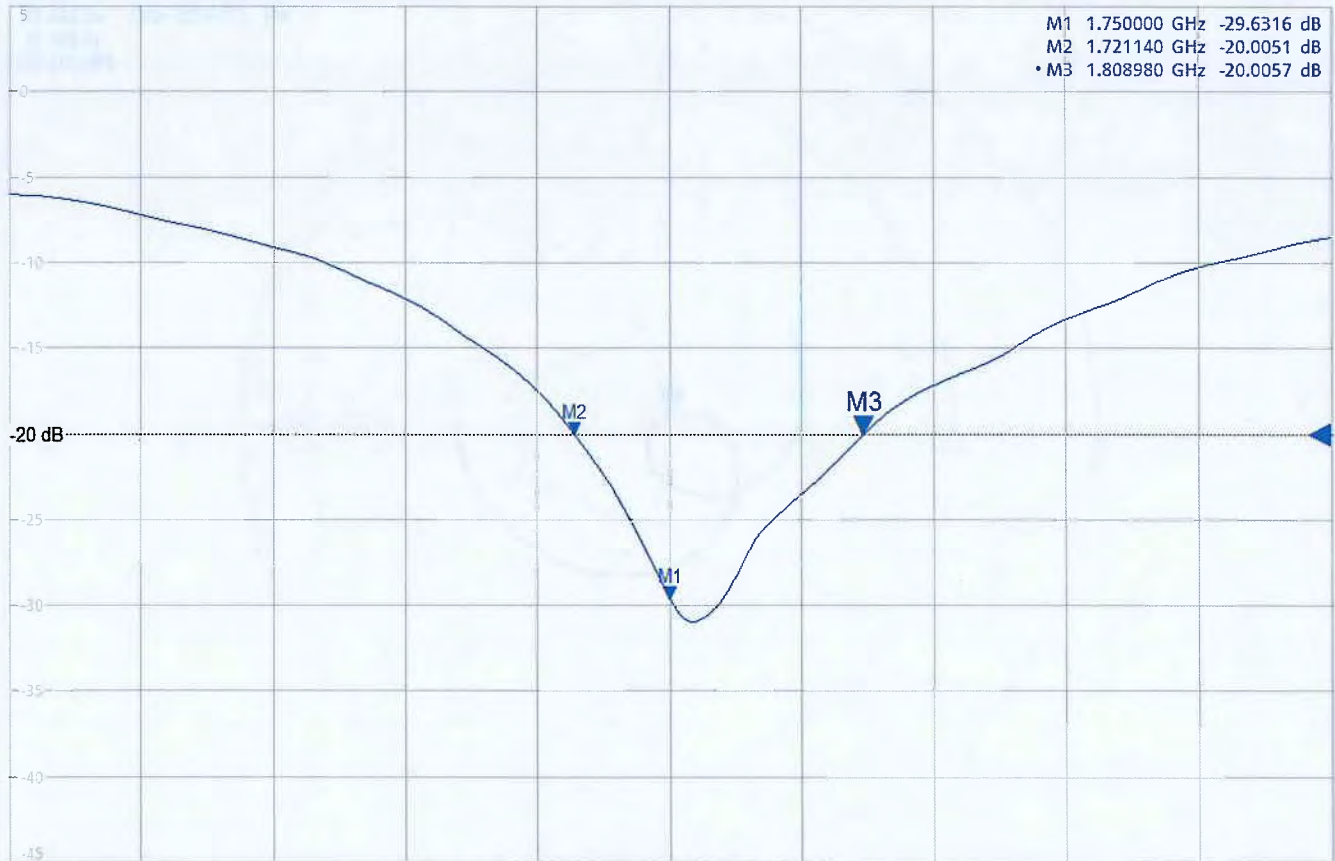



Ch1 Start 1.55 GHz

Pwr -10 dBm Bw 10 kHz

Stop 1.95 GHz

Calibration Certificate Label:

 <p>UKAS CALIBRATION 5248</p>	<p>UL VS LTD - Tel: +44 (0) 1256312000</p> <p>Certificate Number: 11903941JD01B</p> <p>Instrument ID: 1077</p> <p>Calibration Date: 05/Oct/2017</p> <p>Calibration Due Date:</p>
--	---

 <p>UKAS CALIBRATION 5248</p>	<p>UL VS LTD - Tel: +44 (0) 1256312000</p> <p>Certificate Number: 11903941JD01B</p> <p>Instrument ID: 1077</p> <p>Calibration Date: 05/Oct/2017</p> <p>Calibration Due Date:</p>
--	---

 <p>UKAS CALIBRATION 5248</p>	<p>UL VS LTD - Tel: +44 (0) 1256312000</p> <p>Certificate Number: 11903941JD01B</p> <p>Instrument ID: 1077</p> <p>Calibration Date: 05/Oct/2017</p> <p>Calibration Due Date:</p>
---	---

CERTIFICATE OF CALIBRATION

ISSUED BY **UL VS LTD**

DATE OF ISSUE: 18/Sep/2017

CERTIFICATE NUMBER : 11903949JD01B



5248

UL VS LTD
PAVILION A
ASHWOOD PARK, ASHWOOD WAY
BASINGSTOKE, HAMPSHIRE
RG23 8BG, UK
TEL: +44 (0) 1256 312000
FAX: +44 (0) 1256 312001
Email: LST.UK.Calibration@ul.com



Page 1 of 10

APPROVED SIGNATORY

.....
Naseer Mirza

Customer :

UL VS Inc
47173 Benicia Street
Fremont, CA 94538, USA

Equipment Details:

Description:	Dipole Validation Kit	Date of Receipt:	24/Aug/2017
Manufacturer:	SPEAG		
Type/Model Number:	D1750V2		
Serial Number:	1053		
Calibration Date:	24/Aug/2017		
Calibrated By:	Chanthu Thevarajah Laboratory Engineer		

Signature:

.....

All Calibration have been conducted in the closed laboratory facility: Lab Temperature (22±3) °C and humidity < 70%

This certificate is issued in accordance with the laboratory accreditation requirements of the United Kingdom Accreditation Service. It provides traceability of measurement to the SI system of units and/or to units of measurement realised at the National Physical Laboratory or other recognised national metrology institutes. This certificate may not be reproduced other than in full, except with the prior written approval of the issuing laboratory.

Use of the UKAS mark demonstrates that compliance with the requirements of BS/EN/ISO/IEC 17025 has been independently assessed.

CERTIFICATE OF CALIBRATION

ISSUED BY UL VS LTD

UKAS Accredited Calibration Laboratory No. 5248

CERTIFICATE
NUMBER :
11903949JD01B

Page 2 of 10

The calibration methods and procedures used were as detailed in:

1. **IEC 62209-1:2005**: Procedure to determine the specific absorption rate (SAR) for hand-held devices used in close proximity to the ear (frequency range of 300 MHz to 3 GHz)
2. **IEC 62209-2:2010**: Procedure to determine the specific absorption rate (SAR) for wireless communication devices used in close proximity to the human body (frequency range of 30 MHz to 6 GHz)
3. **IEEE 1528: 2013**: IEEE Recommended Practice for Determining the Peak Spatial-Average Specific Absorption Rate (SAR) in the Human Head from Wireless Communication Devices: Measurement Techniques
4. FCC KDB Publication Number: **“KDB865664 D01 SAR Measurement 100 MHz to 6 GHz”**
5. **SPEAG DASY4/ DASY5 System Handbook**

The measuring equipment used to perform the calibration, documented in this certificate has been calibrated in accordance with the manufacturers' recommendations, and is traceable to recognized national standards.

UL No.	Instrument	Manufacturer	Type No.	Serial No.	Date Last Calibrated	Cal. Interval (Months)
A2110	Data Acquisition Electronics	SPEAG	DAE4	431	18 Nov 2016	12
A2436	Probe	SPEAG	ES3DV3	3335	28 July 2017	12
A2077	Probe	SPEAG	EX3DV4	3814	30 Sep 2016	12
A1236	Dipole	SPEAG	1800V2	2d009	09 Feb 2017	12
PRE0151451	Power Monitoring Kit	Art-Fi	ART 100850-01	0001	Cal as part of System	12
PRE0151441	Power Sensor	Rhode & Schwarz	NRP8S	102481	16 Nov 2016	12
M1015	Network Analyser	Agilent Technologies	8753ES	US39172406	26 Sept 2016	12
PRE0151154	Network Analyser	Rhode & Schwarz	ZND8	100151	22 Nov 2016	12
PRE0151877	Calibration Kit	Rhode & Schwarz	Z135	102947-Bt	02 Dec 2016	12
M1768	Signal Generator	Rhode & Schwarz	SME06	837633/001	08 Nov 2016	12

CERTIFICATE OF CALIBRATION

ISSUED BY UL VS LTD

UKAS Accredited Calibration Laboratory No. 5248

CERTIFICATE
NUMBER :
11903949JD01B

Page 3 of 10

SAR System Specification

Robot System Positioner:	Stäubli Unimation Corp. Robot Model: RX90L
Robot Serial Number:	F00/SD89A1/A/01
DASY Version:	DASY 4 (v4.7.80)
Phantom:	Flat section of SAM Twin Phantom
Distance Dipole Centre:	10 mm (with spacer)
Frequency:	1750 MHz

Dielectric Property Measurements – Head Simulating Liquid (HSL)

Simulant Liquid	Frequency (MHz)	Room Temp		Liquid Temp		Parameters	Target Value	Measured Value	Uncertainty (%)
		Start	End	Start	End				
Head	1750	22.6 °C	22.5 °C	22.5°C	22.5°C	ϵ_r	40.10	38.82	± 5%
						σ	1.37	1.36	± 5%

SAR Results – Head Simulating Liquid (HSL)

Simulant Liquid	SAR Measured	250 mW input Power	Normalised to 1.00 W	Uncertainty (%)
Head	SAR averaged over 1g	9.91 W/Kg	39.45 W/Kg	± 17.57%
	SAR averaged over 10g	5.17 W/Kg	20.58 W/Kg	± 17.32%

Antenna Parameters – Head Simulating Liquid (HSL)

Simulant Liquid	Parameter	Measured Level	Uncertainty (%)
Head	Impedance	46.781 Ω -0.22 $j\Omega$	± 0.28 Ω ± 0.044 $j\Omega$
	Return Loss	28.74	± 2.03 dB

CERTIFICATE OF CALIBRATION

ISSUED BY UL VS LTD

UKAS Accredited Calibration Laboratory No. 5248

CERTIFICATE
NUMBER :
11903949JD01B

Page 4 of 10

Dielectric Property Measurements – Body Simulating Liquid (MSL)

Simulant Liquid	Frequency (MHz)	Room Temp		Liquid Temp		Parameters	Target Value	Measured Value	Uncertainty (%)
		Start	End	Start	End				
Body	1750	22.0 °C	22.0 °C	21.5°C	22.0°C	ϵ_r	53.40	51.51	± 5%
						σ	1.49	1.47	± 5%

SAR Results – Body Simulating Liquid (MSL)

Simulant Liquid	SAR Measured	250 mW input Power	Normalised to 1.00 W	Uncertainty (%)
Body	SAR averaged over 1g	8.15 W/Kg	32.44 W/Kg	± 18.06%
	SAR averaged over 10g	4.35 W/Kg	17.31 W/Kg	± 17.44%

Antenna Parameters – Body Simulating Liquid (MSL)

Simulant Liquid	Parameter	Measured Level	Uncertainty (%)
Body	Impedance	45.96 Ω 2.84 j Ω	± 0.28 Ω ± 0.044 j Ω
	Return Loss	24.77	± 2.03 dB

CERTIFICATE OF CALIBRATION

ISSUED BY UL VS LTD

UKAS Accredited Calibration Laboratory No. 5248

CERTIFICATE
NUMBER :
11903949JD01B

Page 5 of 10

DASY Validation Scan for Head Stimulating Liquid (HSL)

DUT: D1750V2 – SN1053; Type: D1750V2; Serial: SN1053

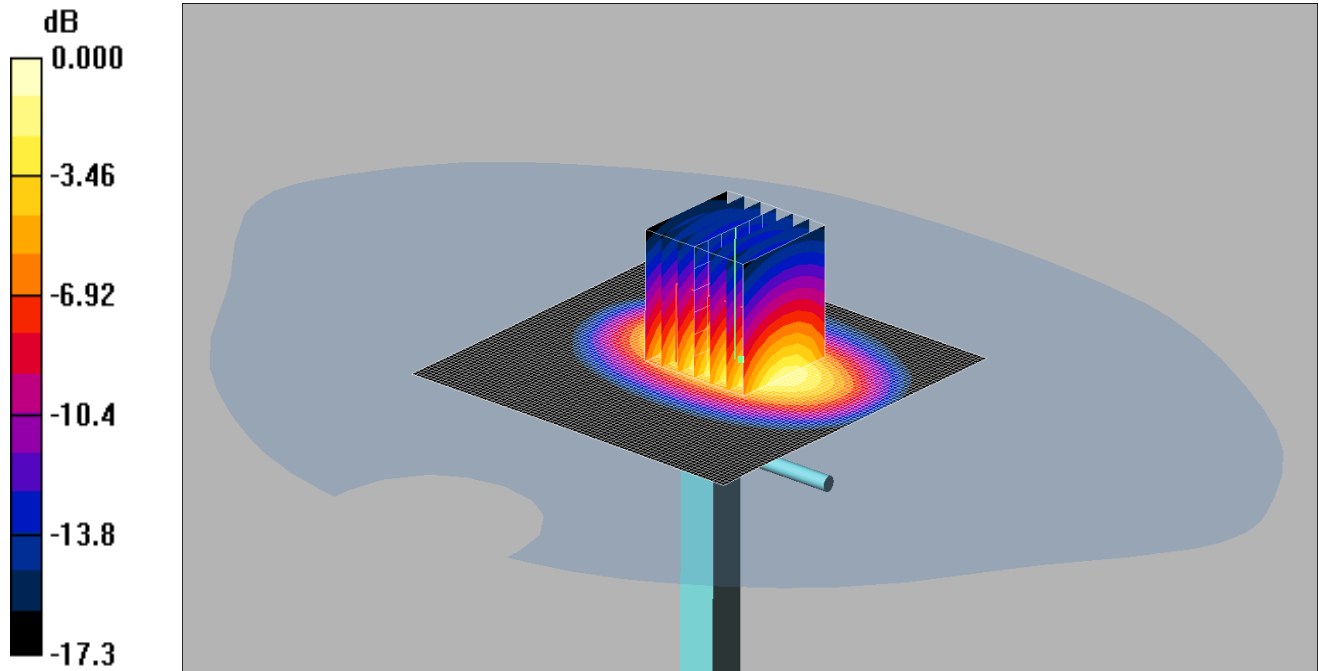

0 dB = 11.2mW/g

Communication System: CW; Frequency: 1750 MHz; Duty Cycle: 1:1

Medium: 1750MHz HSL Medium parameters used: $f = 1750$ MHz; $\sigma = 1.37$ mho/m; $\epsilon_r = 38.8$; $\rho = 1000$ kg/m³

Phantom section: Flat Section

DASY4 Configuration:

- Probe: ES3DV3 - SN3335; ConvF(5.51, 5.51, 5.51);

- Sensor-Surface: 4mm (Mechanical Surface Detection)

- Electronics: DAE4 Sn431; Calibrated: 18/11/2016

- Phantom: SAM 12a (Site 57); Type: SAM 4.0; Serial: TP:1020

- Measurement SW: DASY4, V4.7 Build 80; Postprocessing SW: SEMCAD, V1.8 Build 186

d=10mm, Pin=250mW/Area Scan (81x81x1): Measurement grid: dx=12mm, dy=12mm

Maximum value of SAR (interpolated) = 11.2 mW/g

d=10mm, Pin=250mW/Zoom Scan (7x7x7) (7x7x7)/Cube 0: Measurement grid: dx=5mm, dy=5mm, dz=5mm

Reference Value = 78.3 V/m; Power Drift = 0.078 dB

Peak SAR (extrapolated) = 18.5 W/kg

SAR(1 g) = 9.91 mW/g; SAR(10 g) = 5.17 mW/g

Maximum value of SAR (measured) = 11.2 mW/g

CERTIFICATE OF CALIBRATION

ISSUED BY UL VS LTD

CERTIFICATE
NUMBER :
11903949JD01B

UKAS Accredited Calibration Laboratory No. 5248

Page 6 of 10

Impedance Measurement Plot for Head Stimulating Liquid (HSL)

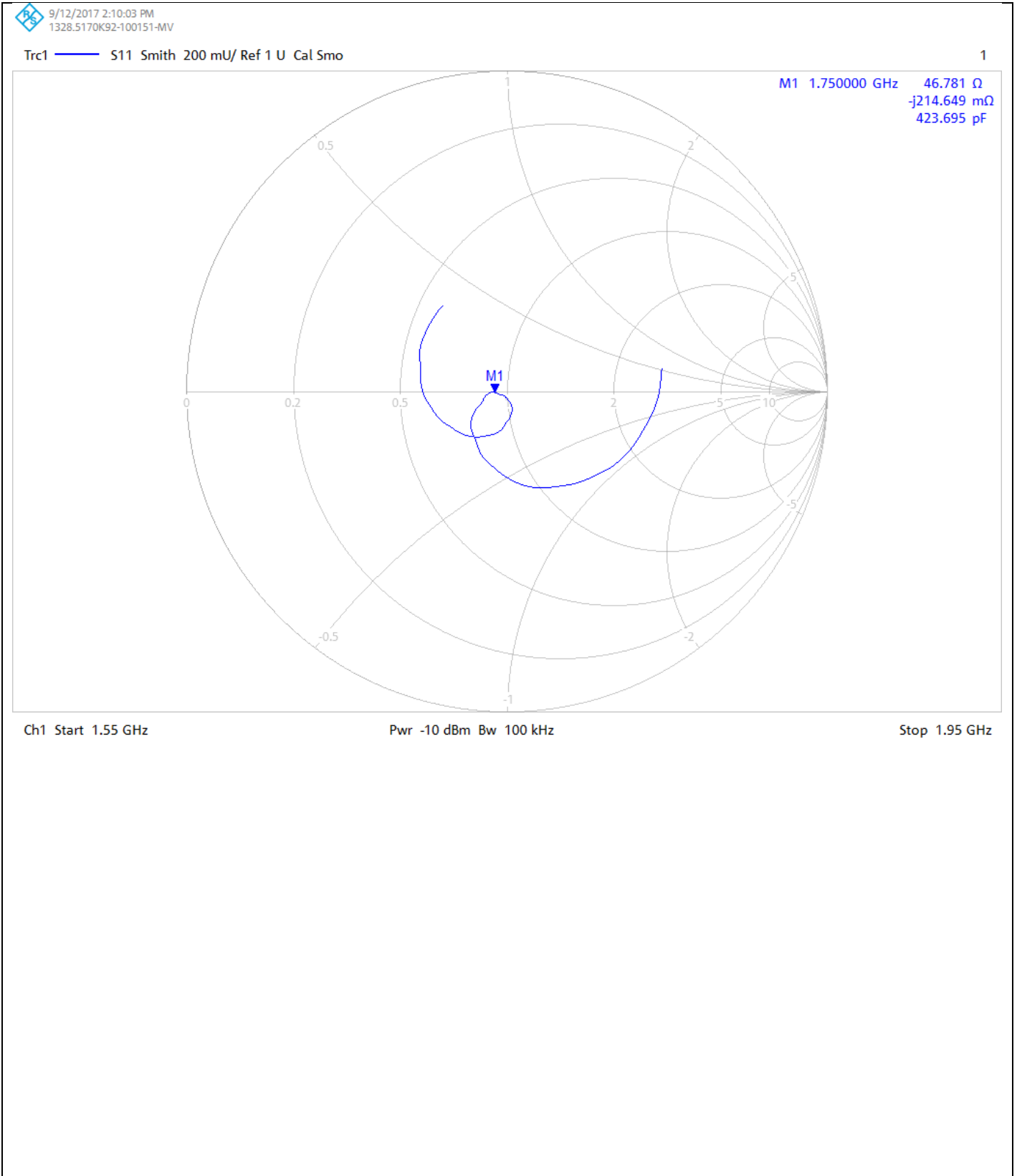

CERTIFICATE OF CALIBRATION

ISSUED BY UL VS LTD

UKAS Accredited Calibration Laboratory No. 5248

CERTIFICATE
NUMBER :
11903949JD01B

Page 7 of 10

Return Loss Measurement Plot for Head Stimulating Liquid (HSL)

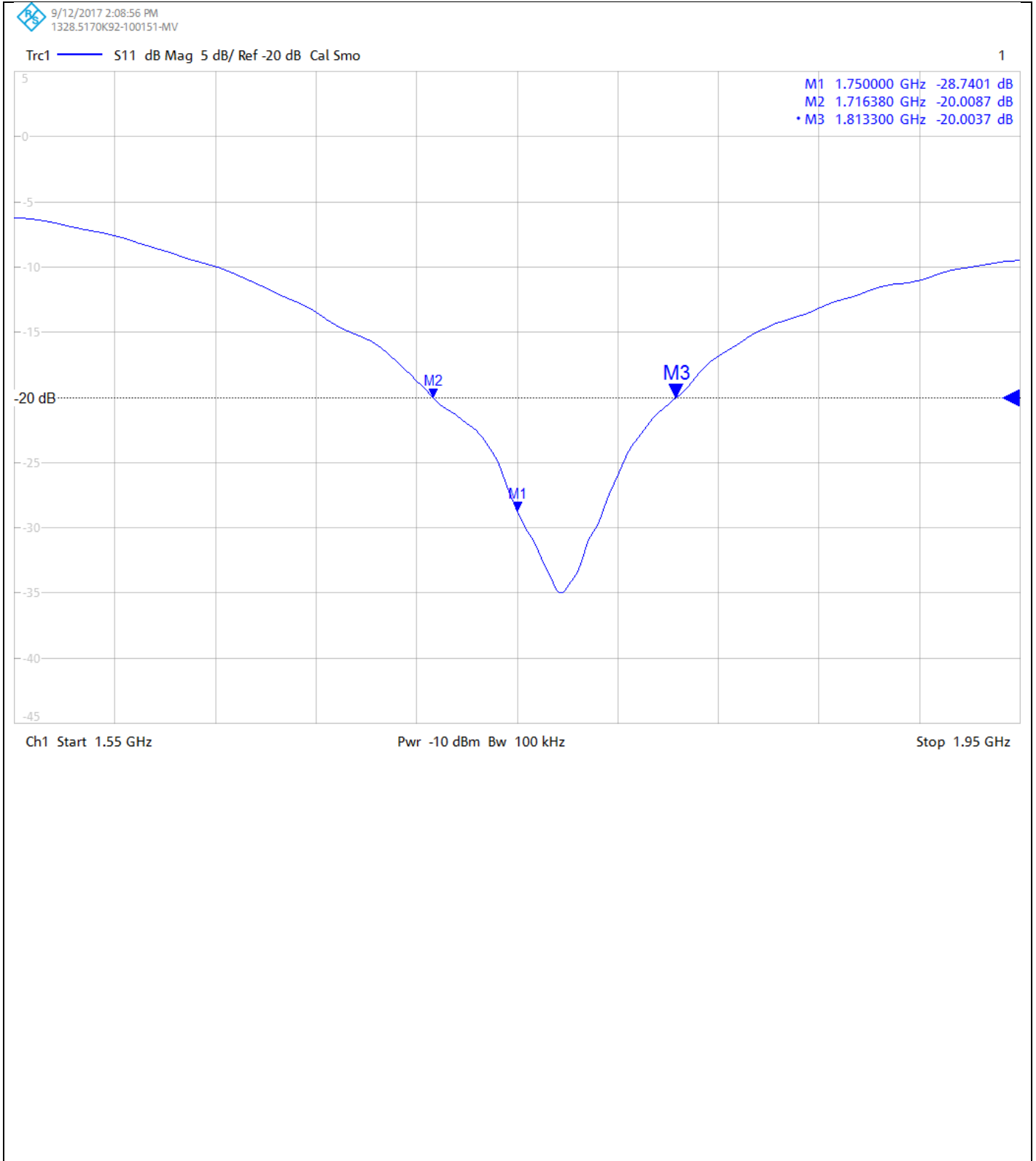

CERTIFICATE OF CALIBRATION

ISSUED BY UL VS LTD

UKAS Accredited Calibration Laboratory No. 5248

CERTIFICATE
NUMBER :
11903949JD01B

Page 8 of 10

DASY Validation Scan for Body Stimulating Liquid (MSL)

DUT: D1750V2 - SN1053; Type: D1750V2; Serial: SN1053

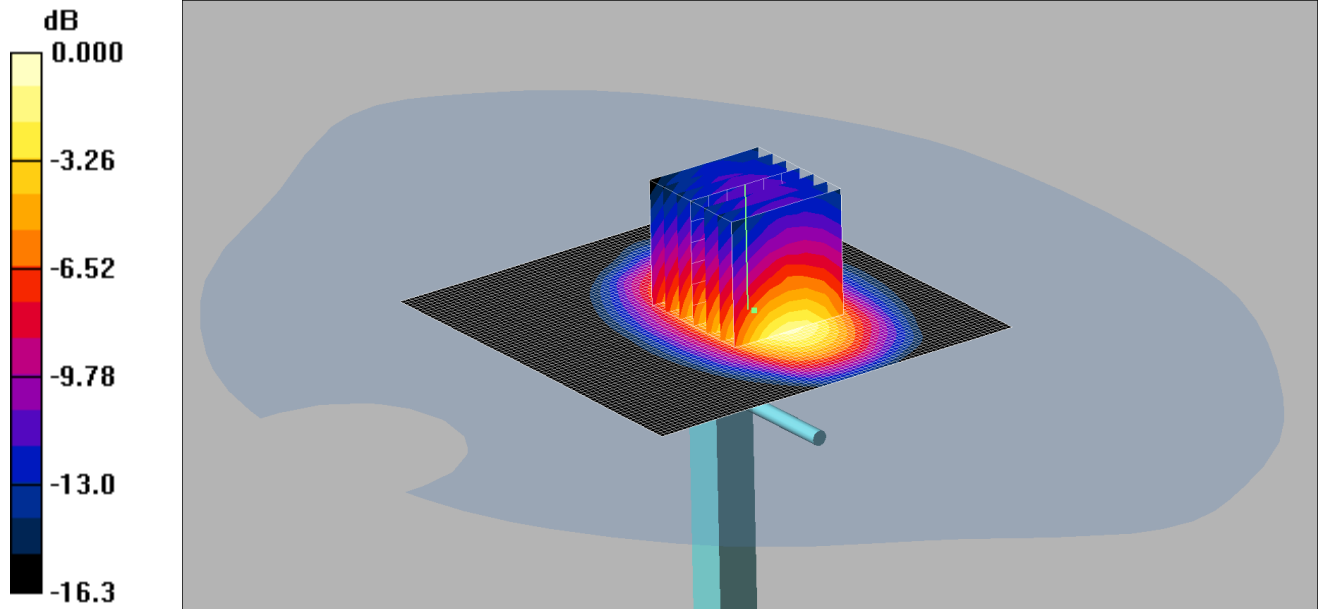

Communication System: CW; Frequency: 1750 MHz; Duty Cycle: 1:1
Medium: 1750 Medium parameters used: $f = 1750$ MHz; $\sigma = 1.47$ mho/m; $\epsilon_r = 51.5$; $\rho = 1000$ kg/m³
Phantom section: Flat Section

DASY4 Configuration:

- Probe: EX3DV4 - SN3814; ConvF(7.8, 7.8, 7.8);

- Sensor-Surface: 4mm (Mechanical Surface Detection)

- Electronics: DAE4 Sn431; Calibrated: 18/11/2016

- Phantom: SAM 12a (Site 57); Type: SAM 4.0; Serial: TP:1020

- Measurement SW: DASY4, V4.7 Build 80; Postprocessing SW: SEMCAD, V1.8 Build 186

d=10mm, Pin=250mW 2 2 2/Area Scan (81x81x1): Measurement grid: dx=12mm, dy=12mm

Maximum value of SAR (interpolated) = 9.60 mW/g

d=10mm, Pin=250mW 2 2 2/Zoom Scan (5x5x7) (7x7x7)/Cube 0: Measurement grid: dx=5mm, dy=5mm, dz=5mm

Reference Value = 65.5 V/m; Power Drift = -0.119 dB

Peak SAR (extrapolated) = 14.7 W/kg

SAR(1 g) = 8.15 mW/g; SAR(10 g) = 4.35 mW/g

Maximum value of SAR (measured) = 9.02 mW/g

CERTIFICATE OF CALIBRATION

ISSUED BY UL VS LTD

UKAS Accredited Calibration Laboratory No. 5248

CERTIFICATE
NUMBER :
11903949JD01B

Page 9 of 10

Impedance Measurement Plot for Body Stimulating Liquid (MSL)

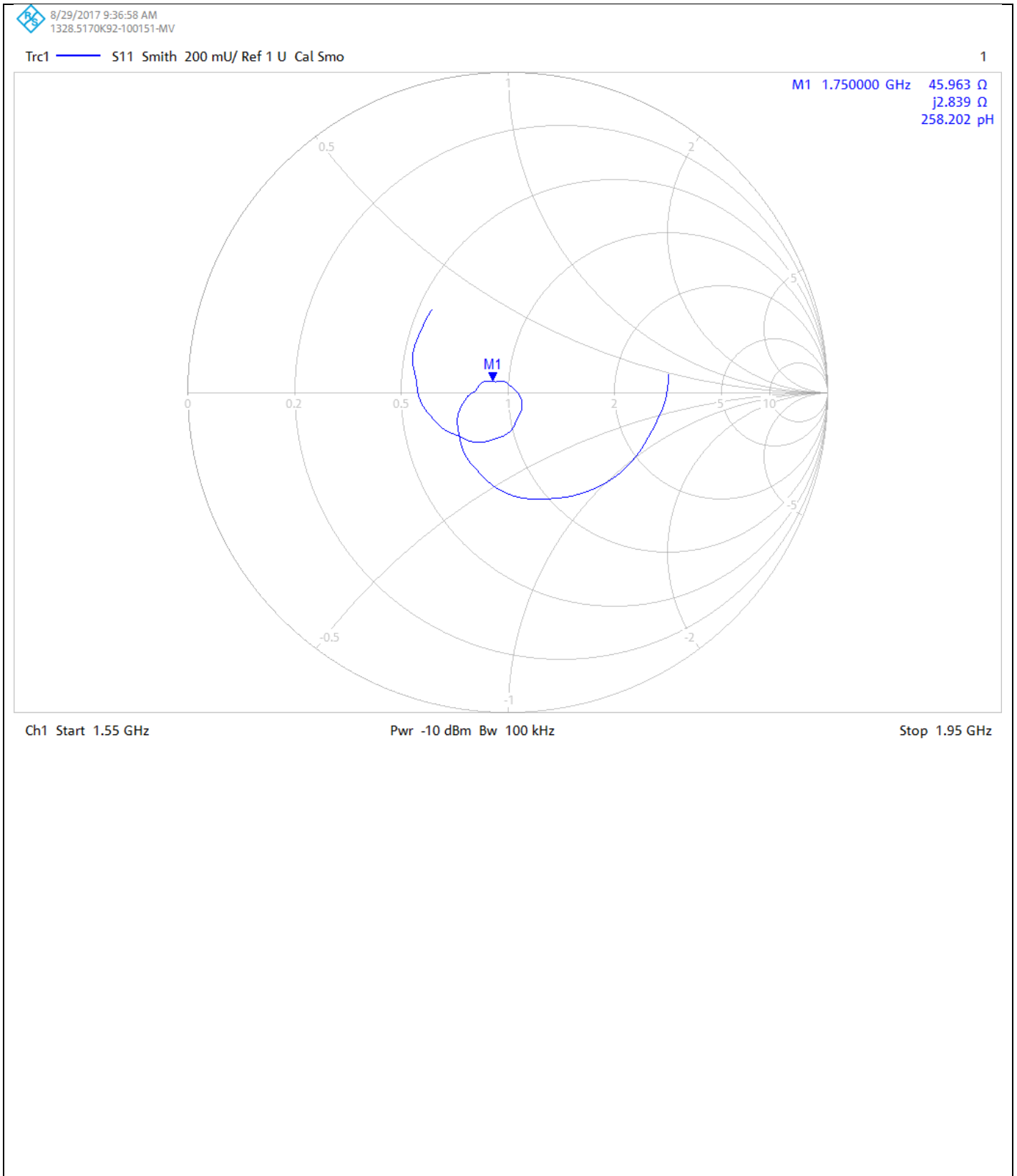

CERTIFICATE OF CALIBRATION

ISSUED BY UL VS LTD

UKAS Accredited Calibration Laboratory No. 5248

CERTIFICATE
NUMBER :
11903949JD01B

Page 10 of 10

Return Loss Measurement Plot for Body Stimulating Liquid (MSL)

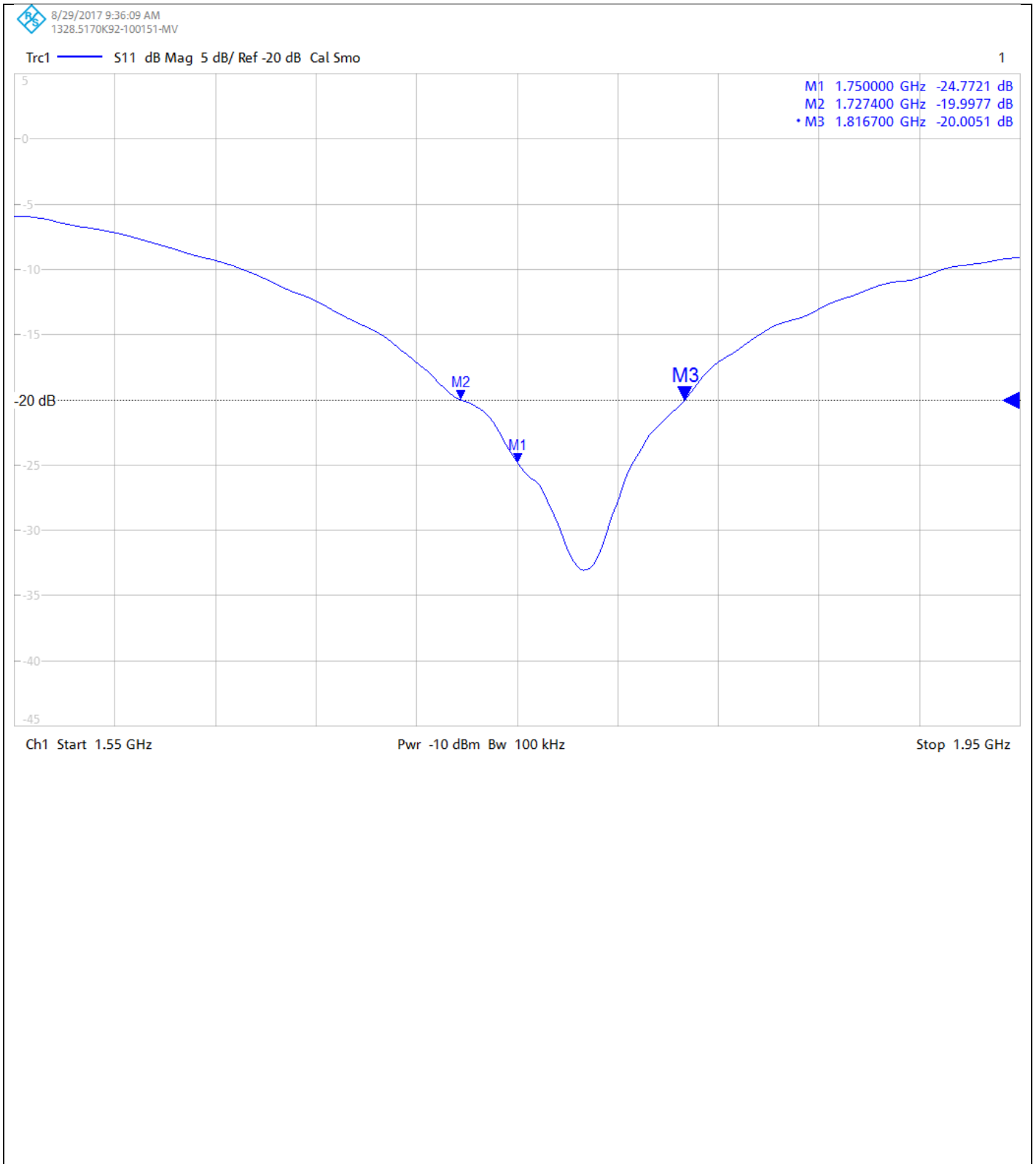

Calibration Certificate Label:

 <p>UKAS CALIBRATION 5248</p>	<p>UL VS LTD - Tel: +44 (0) 1256312000</p> <p>Certificate Number: 11903949JD01B</p> <p>Instrument ID: 1053</p> <p>Calibration Date: 24/Aug/2017</p> <p>Calibration Due Date:</p>
--	---

 <p>UKAS CALIBRATION 5248</p>	<p>UL VS LTD - Tel: +44 (0) 1256312000</p> <p>Certificate Number: 11903949JD01B</p> <p>Instrument ID: 1053</p> <p>Calibration Date: 24/Aug/2017</p> <p>Calibration Due Date:</p>
--	---

 <p>UKAS CALIBRATION 5248</p>	<p>UL VS LTD - Tel: +44 (0) 1256312000</p> <p>Certificate Number: 11903949JD01B</p> <p>Instrument ID: 1053</p> <p>Calibration Date: 24/Aug/2017</p> <p>Calibration Due Date:</p>
--	---

CERTIFICATE OF CALIBRATION

ISSUED BY **UL VS LTD**

DATE OF ISSUE: 21/Apr/2017

CERTIFICATE NUMBER : 11733349JD01C



5248

UL VS LTD
PAVILION A
ASHWOOD PARK, ASHWOOD WAY
BASINGSTOKE, HAMPSHIRE
RG23 8BG, UK
TEL: +44 (0) 1256 312000
FAX: +44 (0) 1256 312001
Email: calibration.uk@ul.com



Page 1 of 10

APPROVED SIGNATORY

.....
Naseer Mirza

Customer :

UL Verification Services Inc
47173 Benicia Street
Fremont, CA 94538, USA

Equipment Details:

Description:	Dipole Validation Kit	Date of Receipt:	13/Apr/2017
Manufacturer:	Schmid & Partner Engineering AG		
Type/Model Number:	D1900V2		
Serial Number:	5d140		
Calibration Date:	19/Apr/2017		
Calibrated By:	Chanthu Thevarajah Laboratory Engineer		

Signature:

.....

All Calibration have been conducted in the closed laboratory facility: Lab Temperature (22±3) °C and humidity < 70%

This certificate is issued in accordance with the laboratory accreditation requirements of the United Kingdom Accreditation Service. It provides traceability of measurement to the SI system of units and/or to units of measurement realised at the National Physical Laboratory or other recognised national metrology institutes. This certificate may not be reproduced other than in full, except with the prior written approval of the issuing laboratory.

Use of the UKAS mark demonstrates that compliance with the requirements of BS/EN/ISO/IEC 17025 has been independently assessed.

CERTIFICATE OF CALIBRATION

ISSUED BY UL VS LTD

UKAS Accredited Calibration Laboratory No. 5248

CERTIFICATE
NUMBER :
11733349JD01C

Page 2 of 10

The calibration methods and procedures used were as detailed in:

1. **IEC 62209-1:2005**: Procedure to determine the specific absorption rate (SAR) for hand-held devices used in close proximity to the ear (frequency range of 300 MHz to 3 GHz)
2. **IEC 62209-2:2010**: Procedure to determine the specific absorption rate (SAR) for wireless communication devices used in close proximity to the human body (frequency range of 30 MHz to 6 GHz)
3. **IEEE 1528: 2013**: IEEE Recommended Practice for Determining the Peak Spatial-Average Specific Absorption Rate (SAR) in the Human Head from Wireless Communication Devices: Measurement Techniques
4. FCC KDB Publication Number: “**KDB865664 D01 SAR Measurement 100 MHz to 6 GHz**”
5. **SPEAG DASY4/ DASY5 System Handbook**

The measuring equipment used to perform the calibration, documented in this certificate has been calibrated in accordance with the manufacturers' recommendations, and is traceable to recognized national standards.

UL No.	Instrument	Manufacturer	Type No.	Serial No.	Date Last Calibrated	Cal. Interval (Months)
A2110	Data Acquisition Electronics	SPEAG	DAE4	431	18 Nov 2016	12
A2587	Probe	SPEAG	ES3DV3	3341	29 Aug 2016	12
A2200	Dipole	SPEAG	D1900V2	537	09 Feb 2017	12
PRE0151451	Power Monitoring Kit	Art-Fi	ART 100850-01	0001	Cal as part of System	12
PRE0151441	Power Sensor	Rhode & Schwarz	NRP8S	102481	16 Nov 2016	12
M1015	Network Analyser	Agilent Technologies	8753ES	US39172406	26 Sept 2016	12
PRE0151154	Network Analyser	Rhode & Schwarz	ZND8	100151	22 Nov 2016	12
PRE0151877	Calibration Kit	Rhode & Schwarz	Z135	102947-Bt	02 Dec 2016	12
M1768	Signal Generator	Rhode & Schwarz	SME06	837633/001	08 Nov 2016	12

CERTIFICATE OF CALIBRATION

ISSUED BY UL VS LTD

UKAS Accredited Calibration Laboratory No. 5248

CERTIFICATE
NUMBER :
11733349JD01C

Page 3 of 10

SAR System Specification

Robot System Positioner:	Stäubli Unimation Corp. Robot Model: RX90L
Robot Serial Number:	F00/SD89A1/A/01
DASY Version:	DASY 4 (v4.7.80)
Phantom:	Flat section of SAM Twin Phantom
Distance Dipole Centre:	10 mm (with spacer)
Frequency:	1900 MHz

Dielectric Property Measurements – Head Simulating Liquid (HSL)

Simulant Liquid	Frequency (MHz)	Room Temp		Liquid Temp		Parameters	Target Value	Measured Value	Uncertainty (%)
		Start	End	Start	End				
Head	1900	22.0 °C	22.0 °C	21.9°C	22.0°C	ϵ_r	40.00	41.30	± 5%
						σ	1.40	1.45	± 5%

SAR Results – Head Simulating Liquid (HSL)

Simulant Liquid	SAR Measured	250 mW input Power	Normalised to 1.00 W	Uncertainty (%)
Head	SAR averaged over 1g	10.20 W/Kg	40.80 W/Kg	± 17.57%
	SAR averaged over 10g	5.29 W/Kg	21.16 W/Kg	± 17.32%

Antenna Parameters – Head Simulating Liquid (HSL)

Simulant Liquid	Parameter	Measured Level	Uncertainty (%)
Head	Impedance	48.94 Ω -2.80 j Ω	± 0.28 Ω ± 0.044 j Ω
	Return Loss	31.55	± 2.03 dB

CERTIFICATE OF CALIBRATION

ISSUED BY UL VS LTD

UKAS Accredited Calibration Laboratory No. 5248

CERTIFICATE
NUMBER :
11733349JD01C

Page 4 of 10

Dielectric Property Measurements – Body Simulating Liquid (MSL)

Simulant Liquid	Frequency (MHz)	Room Temp		Liquid Temp		Parameters	Target Value	Measured Value	Uncertainty (%)
		Start	End	Start	End				
Body	1900	22.0 °C	21.8 °C	22.0°C	22.0°C	ϵ_r	53.30	53.46	± 5%
						σ	1.52	1.59	± 5%

SAR Results – Body Simulating Liquid (MSL)

Simulant Liquid	SAR Measured	250 mW input Power	Normalised to 1.00 W	Uncertainty (%)
Body	SAR averaged over 1g	10.30 W/Kg	41.20 W/Kg	± 18.06%
	SAR averaged over 10g	5.38 W/Kg	21.52 W/Kg	± 17.44%

Antenna Parameters – Body Simulating Liquid (MSL)

Simulant Liquid	Parameter	Measured Level	Uncertainty (%)
Body	Impedance	51.84 Ω -4.61 j Ω	± 0.28 Ω ± 0.044 j Ω
	Return Loss	26.74	± 2.03 dB

CERTIFICATE OF CALIBRATION

ISSUED BY UL VS LTD

CERTIFICATE
NUMBER :
11733349JD01C

UKAS Accredited Calibration Laboratory No. 5248

Page 5 of 10

DASY Validation Scan for Head Stimulating Liquid (HSL)

DUT: Dipole 1900 MHz; SN540; Type: D1900V2; Serial: SN537

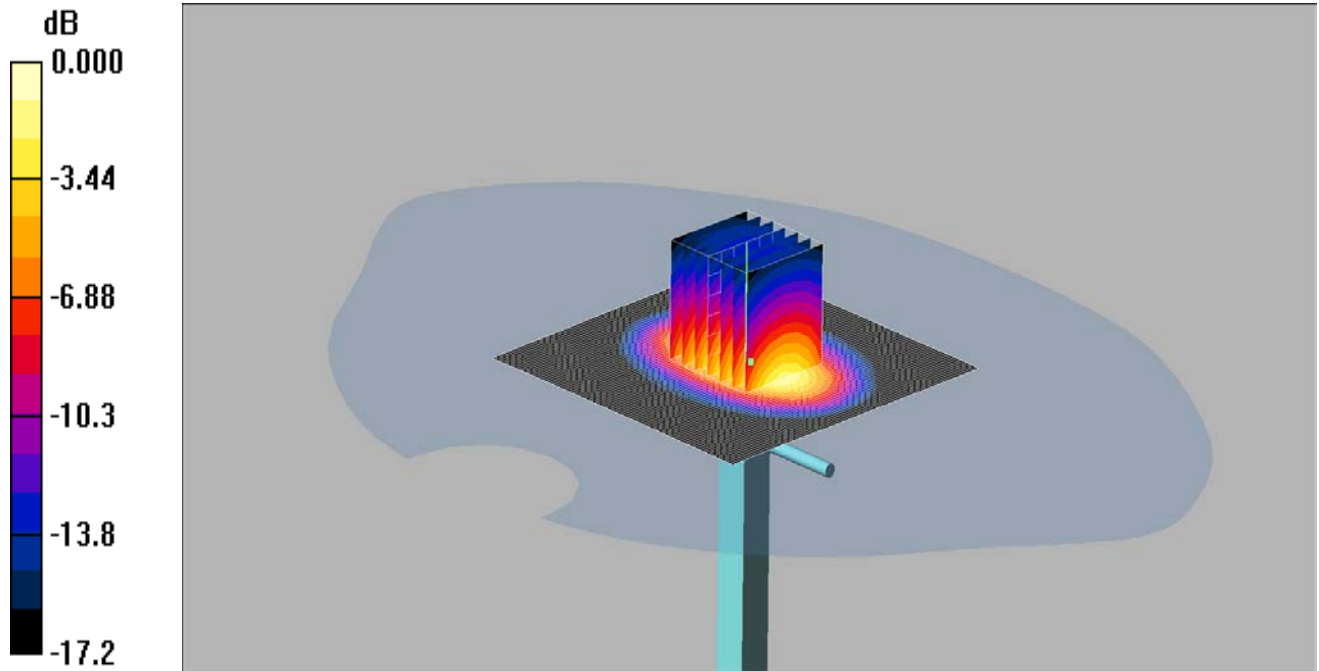

0 dB = 11.5mW/g

Communication System: CW; Frequency: 1900 MHz; Duty Cycle: 1:1

Medium: 1900 MHz HSL Medium parameters used: $f = 1900$ MHz; $\sigma = 1.45$ mho/m; $\epsilon_r = 41.3$; $\rho = 1000$ kg/m³

Phantom section: Flat Section

DASY4 Configuration:

- Probe: ES3DV3 - SN3341; ConvF(5.29, 5.29, 5.29);

- Sensor-Surface: 4mm (Mechanical Surface Detection)

- Electronics: DAE4 Sn431; Calibrated: 18/11/2016

- Phantom: SAM 12a (Site 57); Type: SAM 4.0; Serial: TP:1020

- Measurement SW: DASY4, V4.7 Build 80; Postprocessing SW: SEMCAD, V1.8 Build 186

d=10mm, Pin=250mW 2 2 2/Area Scan (81x81x1): Measurement grid: dx=12mm, dy=12mm

Maximum value of SAR (interpolated) = 11.5 mW/g

d=10mm, Pin=250mW 2 2 2/Zoom Scan (7x7x7) (7x7x7)/Cube 0: Measurement grid: dx=5mm, dy=5mm, dz=5mm

Reference Value = 90.2 V/m; Power Drift = 0.011 dB

Peak SAR (extrapolated) = 19.2 W/kg

SAR(1 g) = 10.2 mW/g; SAR(10 g) = 5.29 mW/g

Maximum value of SAR (measured) = 11.5 mW/g

CERTIFICATE OF CALIBRATION

ISSUED BY UL VS LTD

CERTIFICATE
NUMBER :
11733349JD01C

UKAS Accredited Calibration Laboratory No. 5248

Page 6 of 10

Impedance Measurement Plot for Head Stimulating Liquid (HSL)

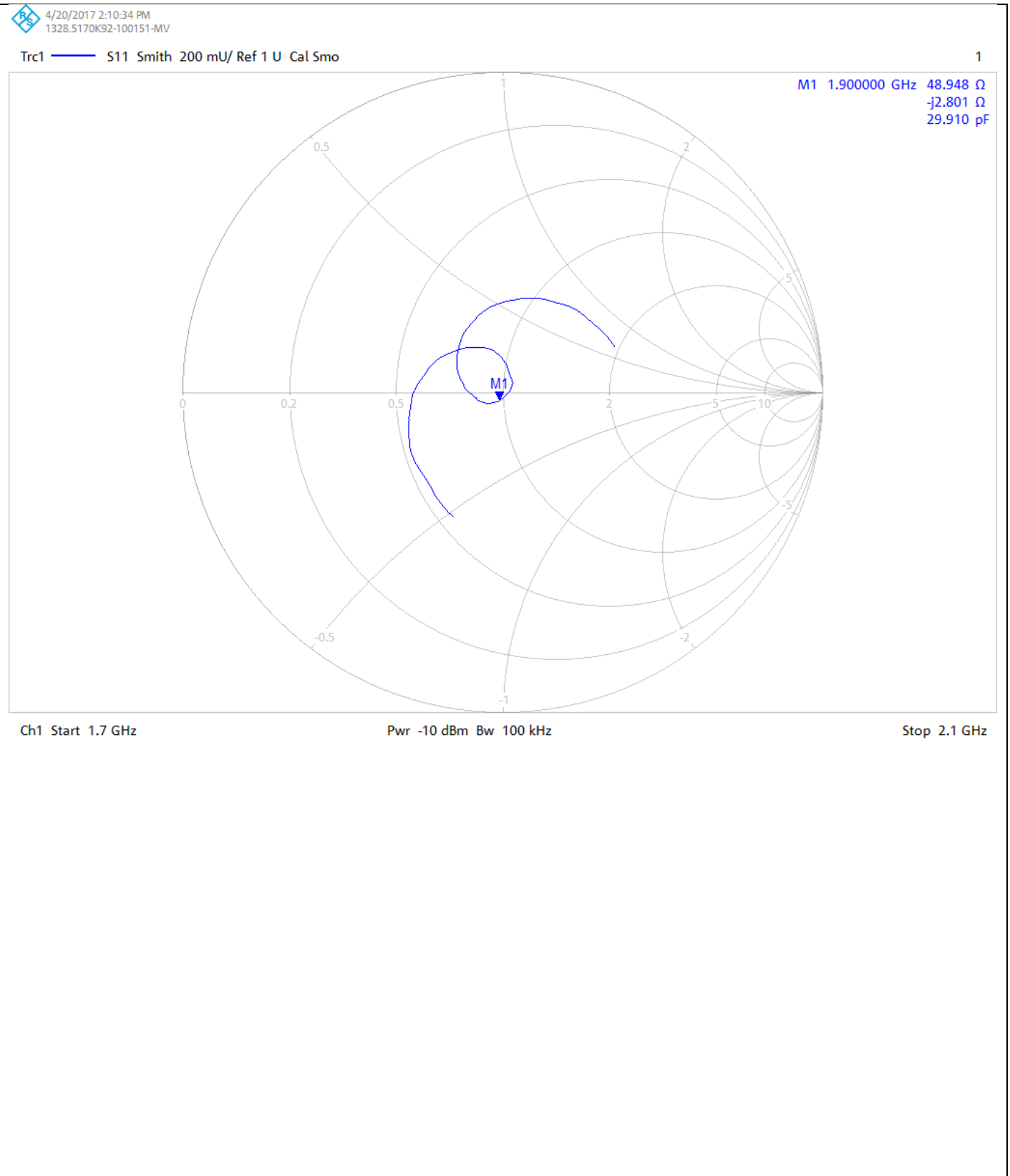

CERTIFICATE OF CALIBRATION

ISSUED BY UL VS LTD

UKAS Accredited Calibration Laboratory No. 5248

CERTIFICATE
NUMBER :
11733349JD01C

Page 7 of 10

Return Loss Measurement Plot for Head Stimulating Liquid (HSL)

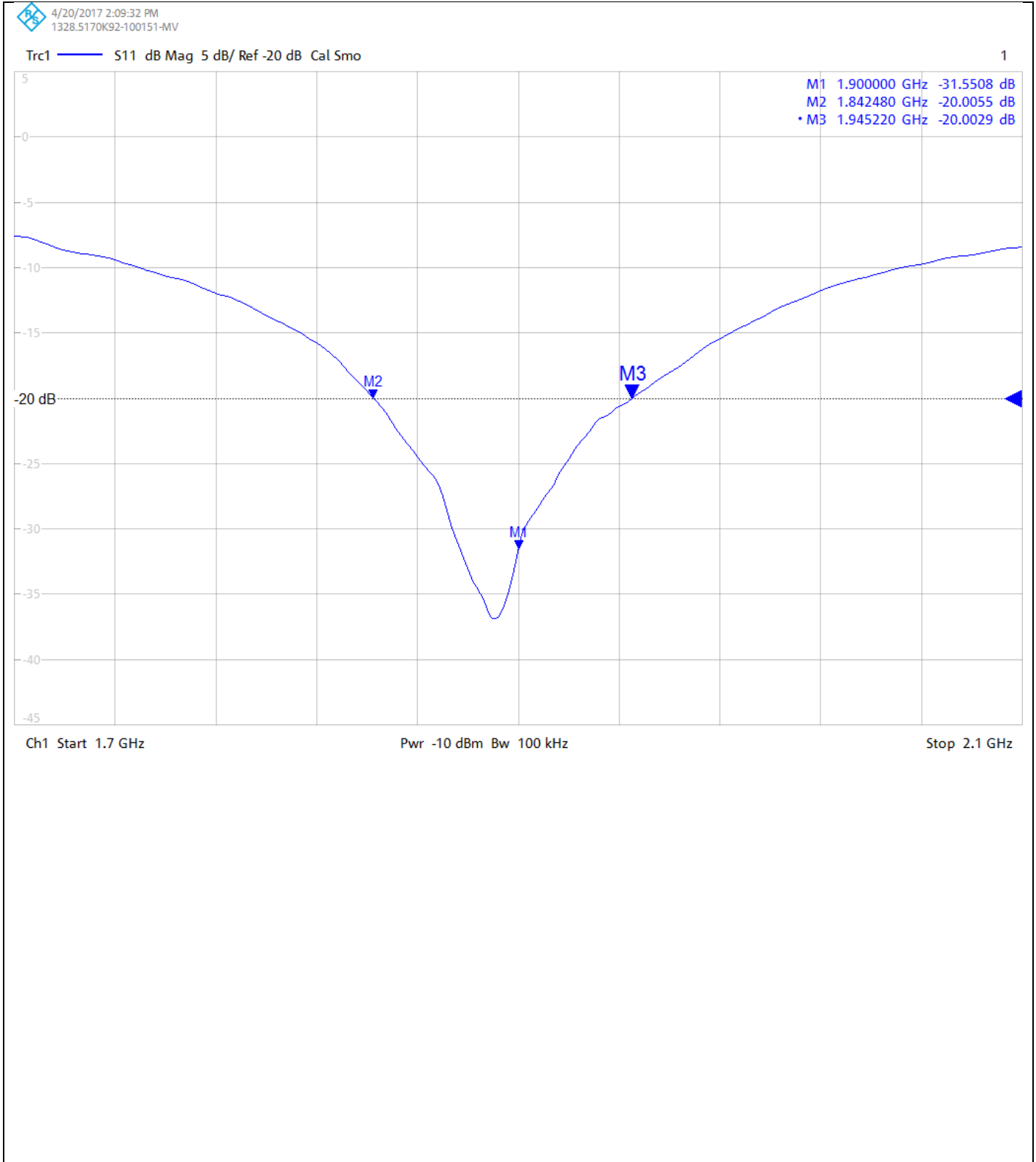

CERTIFICATE OF CALIBRATION

ISSUED BY UL VS LTD

UKAS Accredited Calibration Laboratory No. 5248

CERTIFICATE
NUMBER :
11733349JD01C

Page 8 of 10

DASY Validation Scan for Body Stimulating Liquid (MSL)

DUT: Dipole 1900 MHz; ; Type: D1900V2; Serial: 5d140

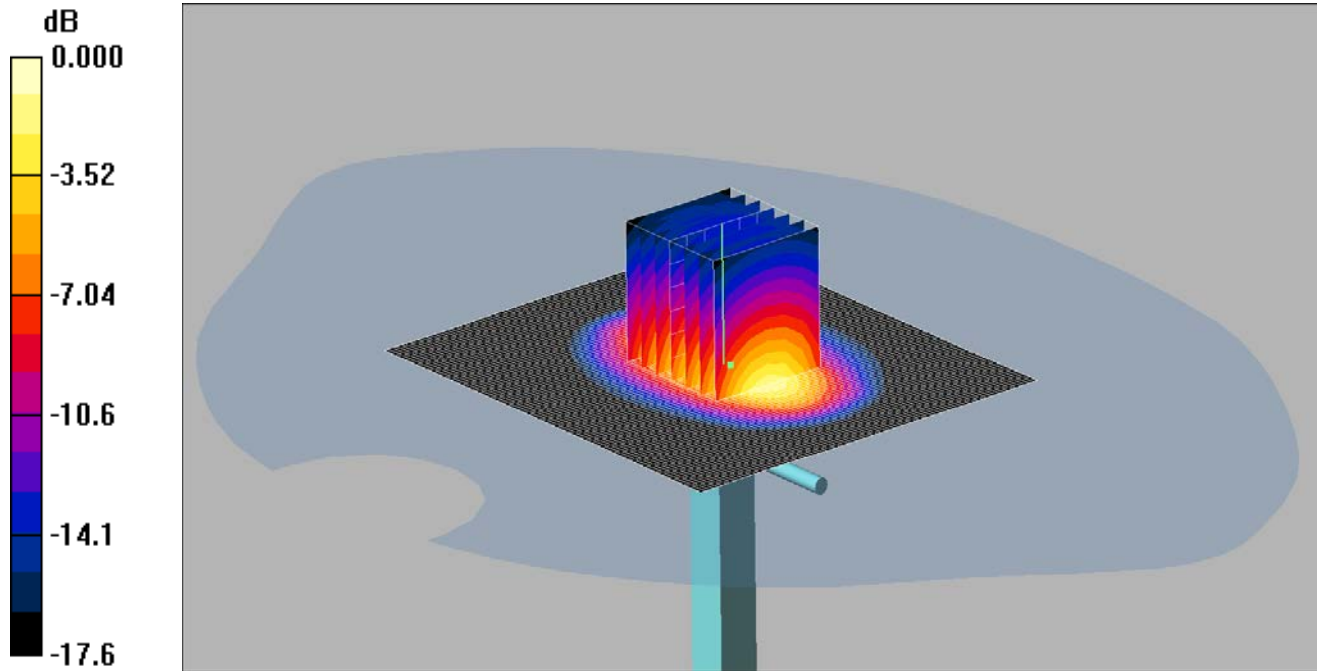

0 dB = 13.1mW/g

Communication System: CW; Frequency: 1900 MHz; Duty Cycle: 1:1

Medium: 1750/1800/1900 MHz MSL Medium parameters used: $f = 1900$ MHz; $\sigma = 1.59$ mho/m; $\epsilon_r = 53.5$; $\rho = 1000$ kg/m³

Phantom section: Flat Section

DASY4 Configuration:

- Probe: ES3DV3 - SN3341; ConvF(4.97, 4.97, 4.97);

- Sensor-Surface: 3mm (Mechanical Surface Detection)

- Electronics: DAE4 Sn431; Calibrated: 18/11/2016

- Phantom: SAM 12a (Site 57); Type: SAM 4.0; Serial: TP:1020

- Measurement SW: DASY4, V4.7 Build 80; Postprocessing SW: SEMCAD, V1.8 Build 186

d=10mm, Pin=250mW 2/Area Scan (81x91x1): Measurement grid: dx=12mm, dy=12mm

Maximum value of SAR (interpolated) = 13.4 mW/g

d=10mm, Pin=250mW 2/Zoom Scan (7x7x7) (7x7x7)/Cube 0: Measurement grid: dx=5mm, dy=5mm, dz=5mm

Reference Value = 94.9 V/m; Power Drift = -0.006 dB

Peak SAR (extrapolated) = 18.3 W/kg

SAR(1 g) = 10.3 mW/g; SAR(10 g) = 5.38 mW/g

Maximum value of SAR (measured) = 13.1 mW/g

CERTIFICATE OF CALIBRATION

ISSUED BY UL VS LTD

UKAS Accredited Calibration Laboratory No. 5248

CERTIFICATE
NUMBER :
11733349JD01C

Page 9 of 10

Impedance Measurement Plot for Body Stimulating Liquid (MSL)

4/19/2017 1:12:15 PM
1328.5170K92-100151-MV

Trc1 — S11 Smith 200 mU/ Ref 1 U Cal Smo

1

M1 1.900000 GHz 51.849 Ω
-j4.616 Ω
18.147 pF

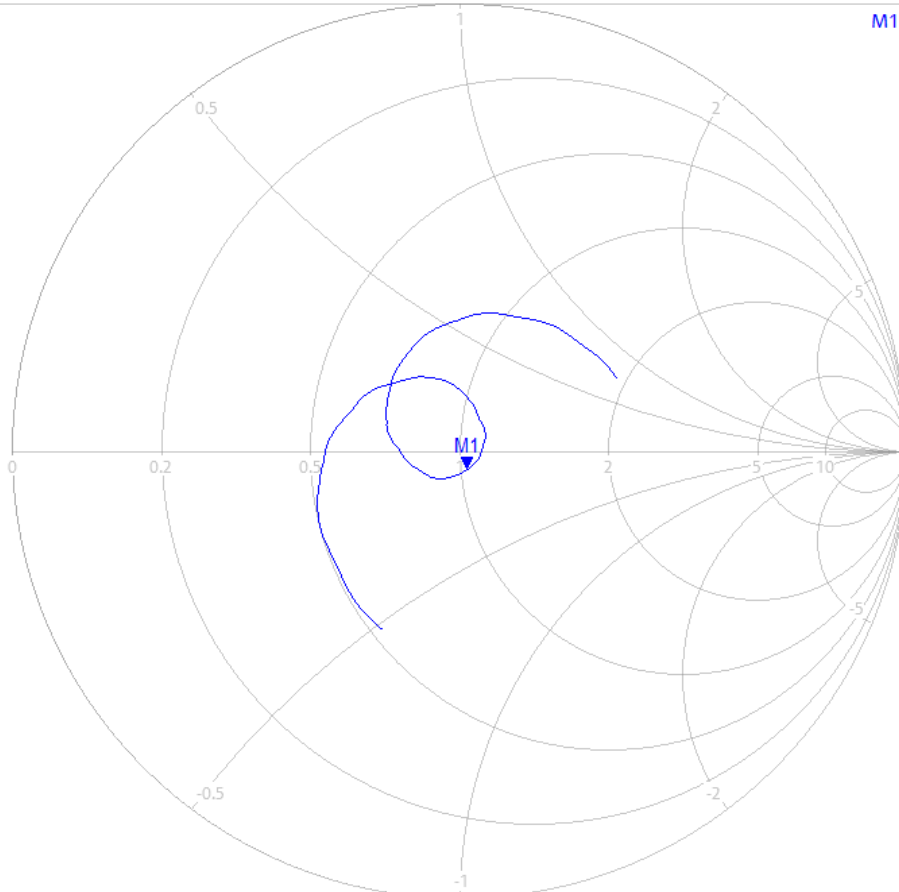

Ch1 Start 1.7 GHz

Pwr -10 dBm Bw 100 kHz

Stop 2.1 GHz

CERTIFICATE OF CALIBRATION

ISSUED BY UL VS LTD

UKAS Accredited Calibration Laboratory No. 5248

CERTIFICATE
NUMBER :
11733349JD01C

Page 10 of 10

Return Loss Measurement Plot for Body Stimulating Liquid (MSL)

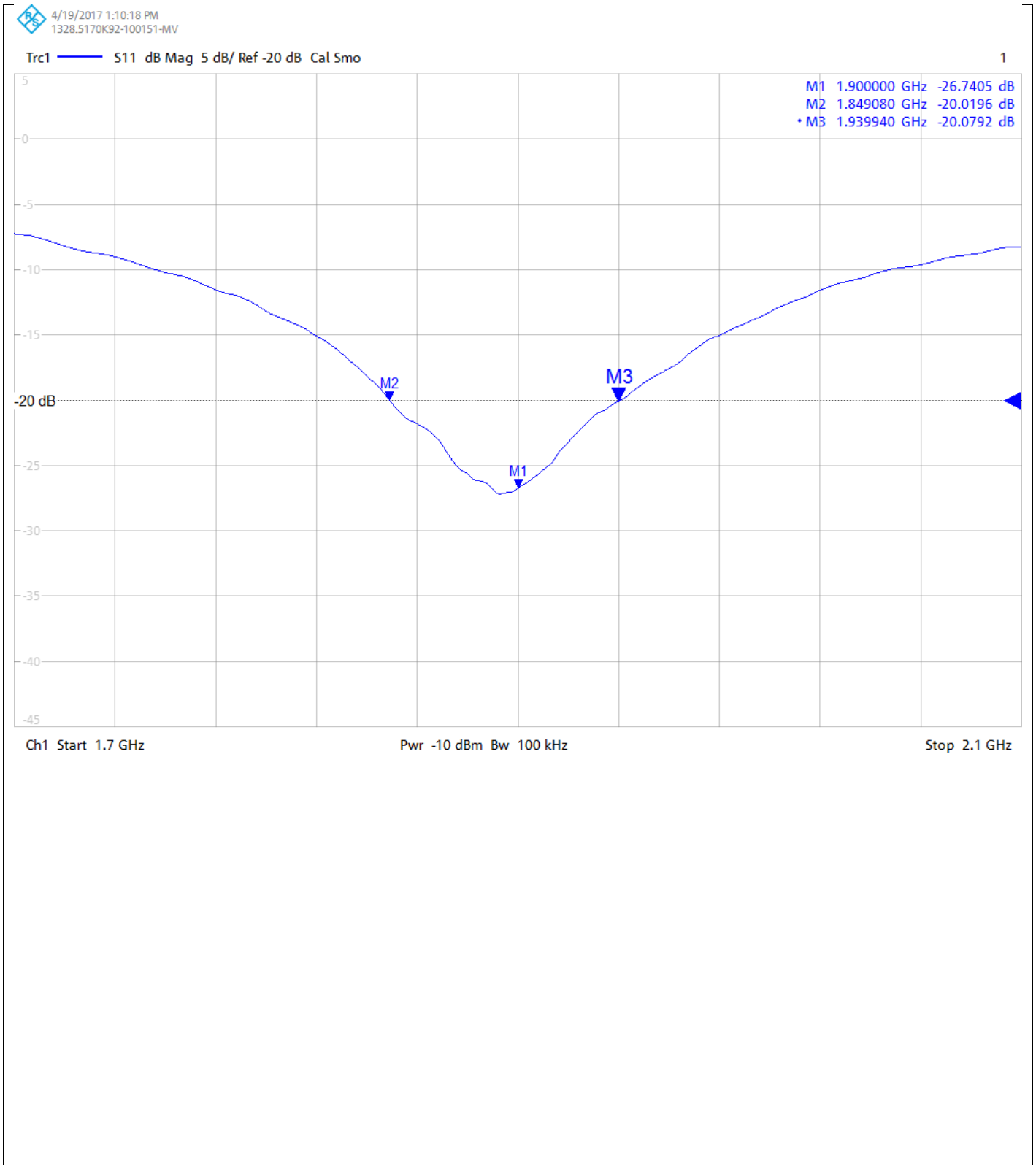

Calibration Certificate Label:

 <p>UKAS CALIBRATION 5248</p>	<p>UL VS LTD - Tel: +44 (0) 1256312000</p> <p>Certificate Number: 11733349JD01C</p> <p>Instrument ID: 5d140</p> <p>Calibration Date: 19/Apr/2017</p> <p>Calibration Due Date:</p>
--	--

 <p>UKAS CALIBRATION 5248</p>	<p>UL VS LTD - Tel: +44 (0) 1256312000</p> <p>Certificate Number: 11733349JD01C</p> <p>Instrument ID: 5d140</p> <p>Calibration Date: 19/Apr/2017</p> <p>Calibration Due Date:</p>
--	--

 <p>UKAS CALIBRATION 5248</p>	<p>UL VS LTD - Tel: +44 (0) 1256312000</p> <p>Certificate Number: 11733349JD01C</p> <p>Instrument ID: 5d140</p> <p>Calibration Date: 19/Apr/2017</p> <p>Calibration Due Date:</p>
--	--

CERTIFICATE OF CALIBRATION

ISSUED BY **UL VS LTD**

DATE OF ISSUE: 29/Nov/2017 CERTIFICATE NUMBER : 11903932JD01E



5248

UL VS LTD
PAVILION A
ASHWOOD PARK, ASHWOOD WAY
BASINGSTOKE, HAMPSHIRE
RG23 8BG, UK
TEL: +44 (0) 1256 312000
FAX: +44 (0) 1256 312001
Email: LST.UK.Calibration@ul.com



Page 1 of 10

APPROVED SIGNATORY

.....
Naseer Mirza

Customer :

UL VS Inc
47173 Benicia Street
Fremont, CA 94538, USA

Equipment Details:

Description:	Dipole Validation Kit	Date of Receipt:	20/Nov/2017
Manufacturer:	Speag		
Type/Model Number:	D1900V2		
Serial Number:	5d043		
Calibration Date:	22/Nov/2017		
Calibrated By:	Chanthu Thevarajah Laboratory Engineer		

Signature:

.....

All Calibration have been conducted in the closed laboratory facility: Lab Temperature (22±3) °C and humidity < 70%

This certificate is issued in accordance with the laboratory accreditation requirements of the United Kingdom Accreditation Service. It provides traceability of measurement to the SI system of units and/or to units of measurement realised at the National Physical Laboratory or other recognised national metrology institutes. This certificate may not be reproduced other than in full, except with the prior written approval of the issuing laboratory.

Use of the UKAS mark demonstrates that compliance with the requirements of BS/EN/ISO/IEC 17025 has been independently assessed.

CERTIFICATE OF CALIBRATION ISSUED BY UL VS LTD

CERTIFICATE
NUMBER :
11903932JD01E

UKAS Accredited Calibration Laboratory No. 5248

Page 2 of 10

The calibration methods and procedures used were as detailed in:

1. **IEC 62209-1:2005**: Procedure to determine the specific absorption rate (SAR) for hand-held devices used in close proximity to the ear (frequency range of 300 MHz to 3 GHz)
2. **IEC 62209-2:2010**: Procedure to determine the specific absorption rate (SAR) for wireless communication devices used in close proximity to the human body (frequency range of 30 MHz to 6 GHz)
3. **IEEE 1528: 2013**: IEEE Recommended Practice for Determining the Peak Spatial-Average Specific Absorption Rate (SAR) in the Human Head from Wireless Communication Devices: Measurement Techniques
4. FCC KDB Publication Number: "KDB865664 D01 SAR Measurement 100 MHz to 6 GHz"
5. **SPEAG DASY4/ DASY5 System Handbook**

The measuring equipment used to perform the calibration, documented in this certificate has been calibrated in accordance with the manufacturers' recommendations, and is traceable to recognized national standards.

UL No.	Instrument	Manufacturer	Type No.	Serial No.	Date Last Calibrated	Cal. Interval (Months)
A2546	Data Acquisition Electronics	SPEAG	DAE4	1435	10 Feb 2017	12
A2545	Probe	SPEAG	ES3DV4	3395	04 May 2017	12
A2200	Dipole	SPEAG	D1900V2	537	09 Feb 2017	12
PRE0151451	Power Monitoring Kit	Art-Fi	ART 100850-01	0001	Cal as part of System	12
M1855	Power Sensor	Rhode & Schwarz	NRP-Z51	103246	08 Nov 2017	12
M1015	Network Analyser	Agilent Technologies	8753ES	US39172406	10 Oct 2017	12
PRE0151154	Network Analyser	Rhode & Schwarz	ZND8	100151	22 Nov 2016	24
PRE0151877	Calibration Kit	Rhode & Schwarz	Z135	102947-Bt	02 Dec 2016	12
M1838	Signal Generator	Rhode & Schwarz	SME06	831377/005	30 Mars 2017	12

CERTIFICATE OF CALIBRATION

ISSUED BY UL VS LTD

CERTIFICATE
NUMBER :
11903932JD01E

UKAS Accredited Calibration Laboratory No. 5248

Page 3 of 10

SAR System Specification

Robot System Positioner:	Stäubli Unimation Corp. Robot Model: TX60L
Robot Serial Number:	F14/5T5ZA1/A/01
DASY Version:	DASY 52 (v52.8.8.1258)
Phantom:	Flat section of SAM Twin Phantom
Distance Dipole Centre:	10 mm (with spacer)
Frequency:	1900 MHz

Dielectric Property Measurements – Head Simulating Liquid (HSL)

Simulant Liquid	Frequency (MHz)	Room Temp		Liquid Temp		Parameters	Target Value	Measured Value	Uncertainty (%)
		Start	End	Start	End				
Head	1900	21.0 °C	21.0 °C	20.5°C	21.0°C	ϵ_r	40.00	39.91	± 5%
						σ	1.40	1.44	± 5%

SAR Results – Head Simulating Liquid (HSL)

Simulant Liquid	SAR Measured	250 mW input Power	Normalised to 1.00 W	Uncertainty (%)
Head	SAR averaged over 1g	10.80 W/Kg	42.99 W/Kg	± 17.57%
	SAR averaged over 10g	5.57 W/Kg	22.17 W/Kg	± 17.32%

Antenna Parameters – Head Simulating Liquid (HSL)

Simulant Liquid	Parameter	Measured Level	Uncertainty (%)
Head	Impedance	52.432 Ω -3.49 j Ω	± 0.28 Ω ± 0.044 j Ω
	Return Loss	27.60	± 2.03 dB

CERTIFICATE OF CALIBRATION

ISSUED BY UL VS LTD

CERTIFICATE
NUMBER :
11903932JD01E

UKAS Accredited Calibration Laboratory No. 5248

Page 4 of 10

Dielectric Property Measurements – Body Simulating Liquid (MSL)

Simulant Liquid	Frequency (MHz)	Room Temp		Liquid Temp		Parameters	Target Value	Measured Value	Uncertainty (%)
		Start	End	Start	End				
Body	1900	21.0 °C	21.0 °C	21.0°C	21.0°C	ϵ_r	53.30	52.87	± 5%
						σ	1.52	1.56	± 5%

SAR Results – Body Simulating Liquid (MSL)

Simulant Liquid	SAR Measured	250 mW input Power	Normalised to 1.00 W	Uncertainty (%)
Body	SAR averaged over 1g	10.30 W/Kg	41.00 W/Kg	± 18.06%
	SAR averaged over 10g	5.25 W/Kg	20.90 W/Kg	± 17.44%

Antenna Parameters – Body Simulating Liquid (MSL)

Simulant Liquid	Parameter	Measured Level	Uncertainty (%)
Body	Impedance	55.43 Ω -4.69 j Ω	± 0.28 Ω ± 0.044 j Ω
	Return Loss	23.18	± 2.03 dB

CERTIFICATE OF CALIBRATION

ISSUED BY UL VS LTD

CERTIFICATE
NUMBER :
11903932JD01E

UKAS Accredited Calibration Laboratory No. 5248

Page 5 of 10

DASY Validation Scan for Head Stimulating Liquid (HSL)

DUT: D1900V2 - SN: 5D043; Type: D1900V2; Serial: SN: 5D043

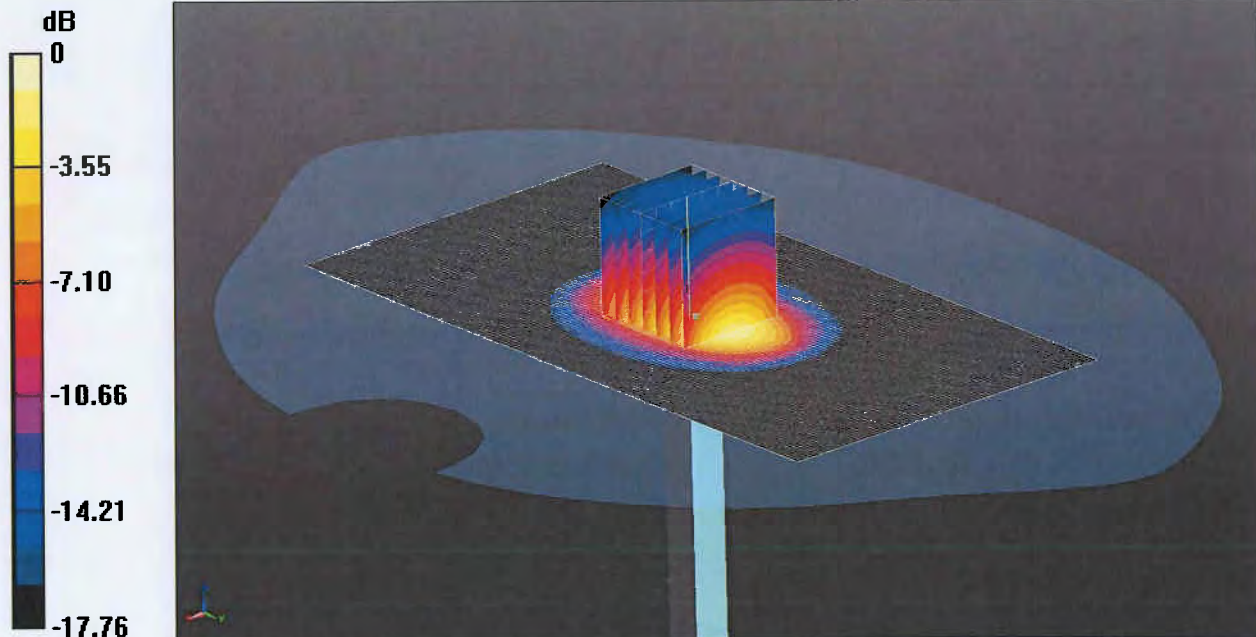

0 dB = 13.6 W/kg = 11.34 dBW/kg

Communication System: UID 0, CW (0); Frequency: 1900 MHz; Duty Cycle: 1:1
Medium: 750,835,900,1800,1900 MHz HSL Medium parameters used: $f = 1900$ MHz; $\sigma = 1.438$ S/m; $\epsilon_r = 39.91$; $\rho = 1000$ kg/m³
Phantom section: Flat Section

DASY5 Configuration:

- Probe: EX3DV4 - SN3995; ConvF(8.37, 8.37, 8.37); Calibrated: 04/05/2017;
- Sensor-Surface: 3mm (Mechanical Surface Detection)
- Electronics: DAE4 Sn1435; Calibrated: 10/02/2017
- Phantom: SAM (30deg probe tilt) with CRP v5.0; Type: QD000P40CD; Serial: TP:xxxx
- ; SEMCAD X Version 14.6.10 (7372)

Configuration/d=10mm, Pin=250mW/Area Scan (81x151x1): Interpolated grid: dx=1.200 mm, dy=1.200 mm

Maximum value of SAR (interpolated) = 14.1 W/kg

Configuration/d=10mm, Pin=250mW/Zoom Scan (5x5x7) (7x7x7)/Cube 0: Measurement grid: dx=5mm, dy=5mm, dz=5mm

Reference Value = 97.92 V/m; Power Drift = 0.01 dB

Peak SAR (extrapolated) = 20.2 W/kg

SAR(1 g) = 10.8 W/kg; SAR(10 g) = 5.57 W/kg

Maximum value of SAR (measured) = 13.6 W/kg

CERTIFICATE OF CALIBRATION ISSUED BY UL VS LTD

CERTIFICATE
NUMBER :
11903932JD01E

UKAS Accredited Calibration Laboratory No. 5248

Page 6 of 10

Impedance Measurement Plot for Head Stimulating Liquid (HSL)



11/28/2017 11:24:05 AM
1326.5170K92-100151-MV

Trc1 — S11 Smith 200 mU/ Ref 1 U Cal 5mo

1

M1 1.900000 GHz 52.432 Ω
-j3.486 Ω
24.031 pF

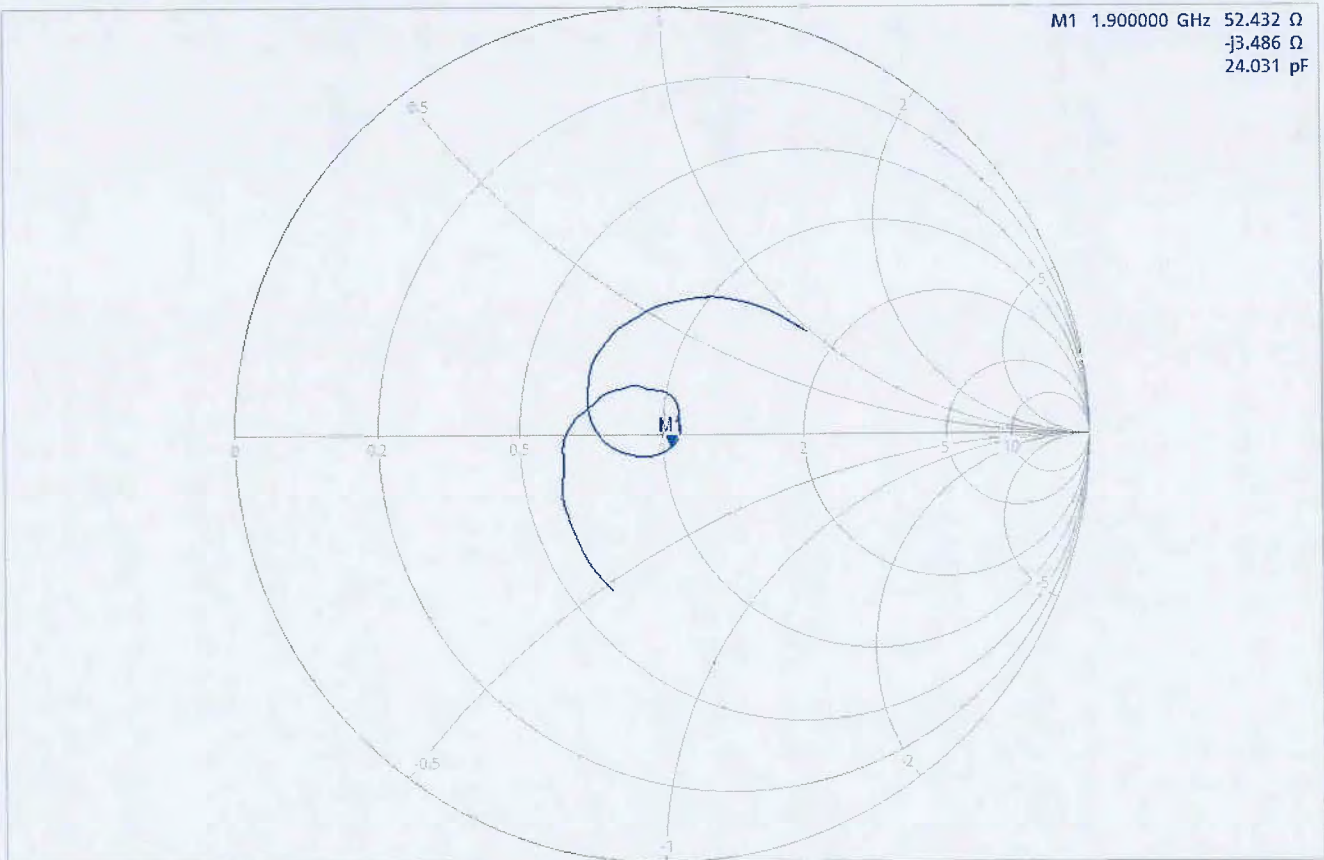

Ch1 Start 1.7 GHz

Pwr -10 dBm Bw 10 kHz

Stop 2.1 GHz

CERTIFICATE OF CALIBRATION

ISSUED BY UL VS LTD

UKAS Accredited Calibration Laboratory No. 5248

CERTIFICATE
NUMBER :
11903932JD01E

Page 7 of 10

Return Loss Measurement Plot for Head Stimulating Liquid (HSL)



CERTIFICATE OF CALIBRATION

ISSUED BY UL VS LTD

CERTIFICATE
NUMBER :
11903932JD01E

UKAS Accredited Calibration Laboratory No. 5248

Page 8 of 10

DASY Validation Scan for Body Stimulating Liquid (MSL)

DUT: Dipole 1900 MHz; Type: D1900V2; Serial: SN5d043

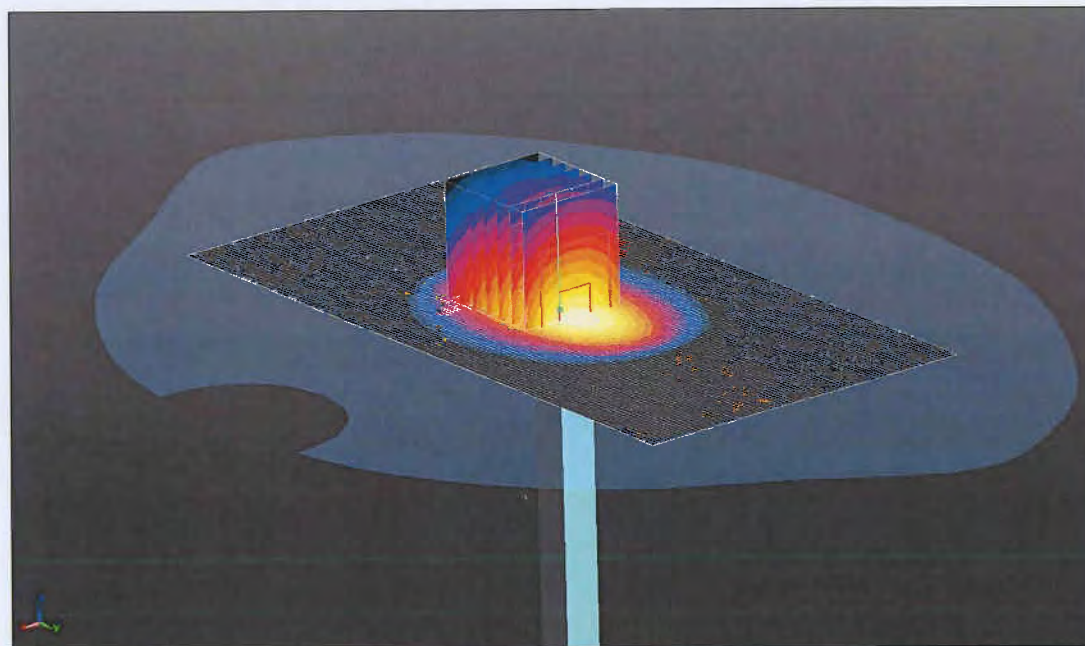
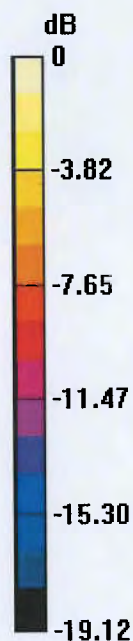

0 dB = 13.0 W/kg = 11.14 dBW/kg

Communication System: UID 0, CW (0); Frequency: 1900 MHz; Duty Cycle: 1:1
Medium: MSL(750,835,900,1800,1900,5G) Medium parameters used: $f = 1900$ MHz; $\sigma = 1.564$ S/m; $\epsilon_r = 52.87$; $\rho = 1000$ kg/m³
Phantom section: Flat Section

DASY 5 Configuration:

- Probe: EX3DV4 - SN3995; ConvF(8.04, 8.04, 8.04); Calibrated: 04/05/2017;
- Sensor-Surface: 3mm (Mechanical Surface Detection)
- Electronics: DAE4 Sn1435; Calibrated: 10/02/2017
- Phantom: SAM (20deg probe tilt) with CRP v4.0; Type: QD000P40CC; Serial: TP:xxxx
- ; SEMCAD X Version 14.6.10 (7372)

SAR/d=10mm, Pin=250mW/Area Scan (81x151x1): Interpolated grid: dx=1.200 mm, dy=1.200 mm

Maximum value of SAR (interpolated) = 13.4 W/kg

SAR/d=10mm, Pin=250mW/Zoom Scan (5x5x7) (7x7x7)/Cube 0: Measurement grid: dx=5mm, dy=5mm, dz=5mm

Reference Value = 91.38 V/m; Power Drift = -0.07 dB

Peak SAR (extrapolated) = 18.4 W/kg

SAR(1 g) = 10.3 W/kg; SAR(10 g) = 5.25 W/kg

Maximum value of SAR (measured) = 13.0 W/kg

CERTIFICATE OF CALIBRATION ISSUED BY UL VS LTD

UKAS Accredited Calibration Laboratory No. 5248

CERTIFICATE
NUMBER :
11903932JD01E

Page 9 of 10

Impedance Measurement Plot for Body Stimulating Liquid (MSL)



11/28/2017 11:30:05 AM
1328.5170K92-100151-MV

Trc1 — S11 Smith 200 mU/ Ref 1 U Cal Smo

1

M1 1.900000 GHz 55.431 Ω
-j4.686 Ω
17.875 pF

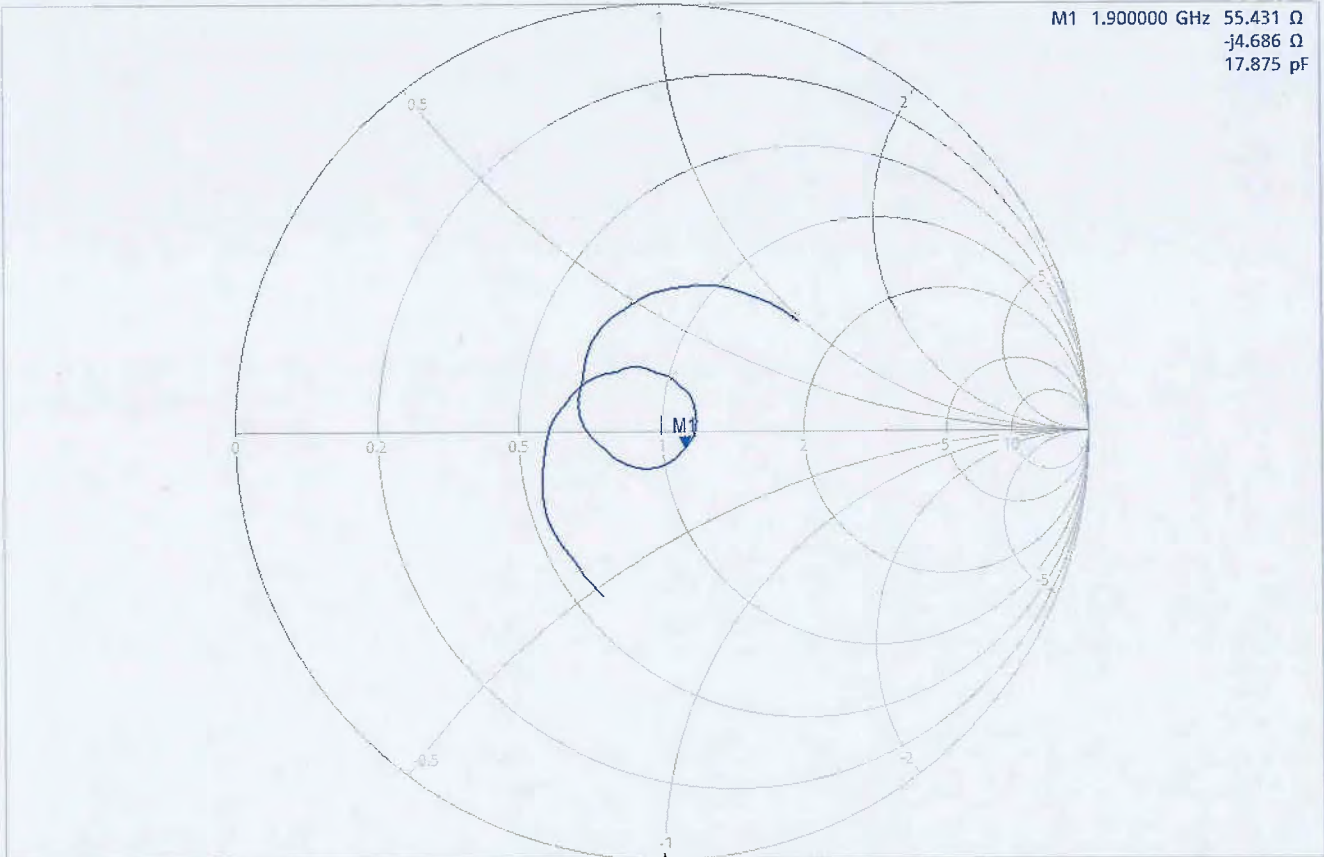

Ch1 Start 1.7 GHz

Pwr -10 dBm Bw 10 kHz

Stop 2.1 GHz

CERTIFICATE OF CALIBRATION

ISSUED BY UL VS LTD

UKAS Accredited Calibration Laboratory No. 5248

CERTIFICATE
NUMBER :
11903932JD01E

Page 10 of 10

Return Loss Measurement Plot for Body Stimulating Liquid (MSL)

11/25/2017 11:31:09 AM
1328.5170K92-100151-MV

Trc1 — S11 dB Mag 5 dB/ Ref -20 dB Cal Smo

1

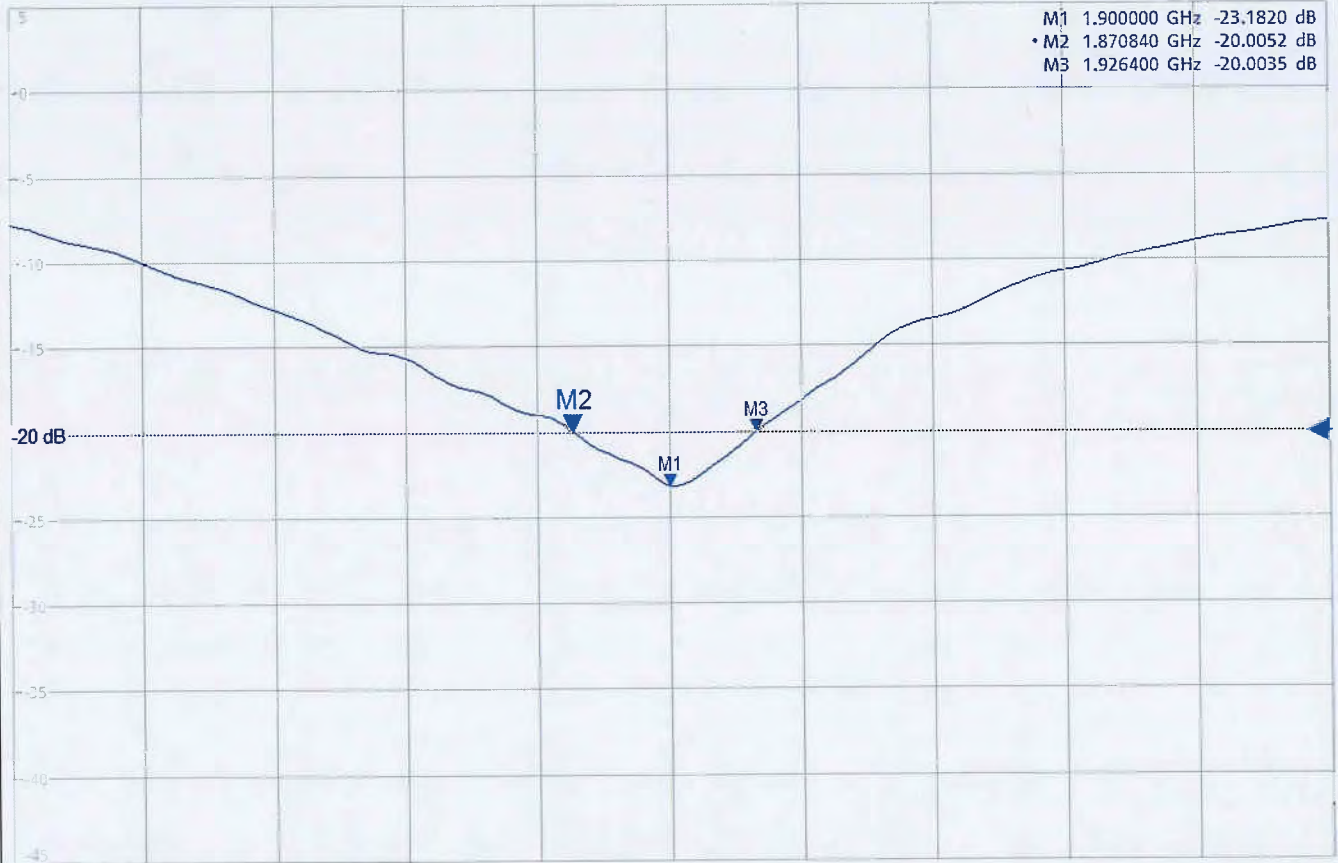

Ch1 Start 1.7 GHz

Pwr -10 dBm Bw 10 kHz

Stop 2.1 GHz

Calibration Certificate Label:

 <p>UKAS CALIBRATION 5248</p>	<p>UL VS LTD - Tel: +44 (0) 1256312000</p> <p>Certificate Number: 11903932JD01E</p> <p>Instrument ID: 5d043</p> <p>Calibration Date: 22/Nov/2017</p> <p>Calibration Due Date:</p>
--	--

 <p>UKAS CALIBRATION 5248</p>	<p>UL VS LTD - Tel: +44 (0) 1256312000</p> <p>Certificate Number: 11903932JD01E</p> <p>Instrument ID: 5d043</p> <p>Calibration Date: 22/Nov/2017</p> <p>Calibration Due Date:</p>
--	--

 <p>UKAS CALIBRATION 5248</p>	<p>UL VS LTD - Tel: +44 (0) 1256312000</p> <p>Certificate Number: 11903932JD01E</p> <p>Instrument ID: 5d043</p> <p>Calibration Date: 22/Nov/2017</p> <p>Calibration Due Date:</p>
---	--