

Antenna Specification

Model: BT-402

Manufacturer: Datecs

Antenna type: PCB printed antenna

Antenna Gain: 2dBi

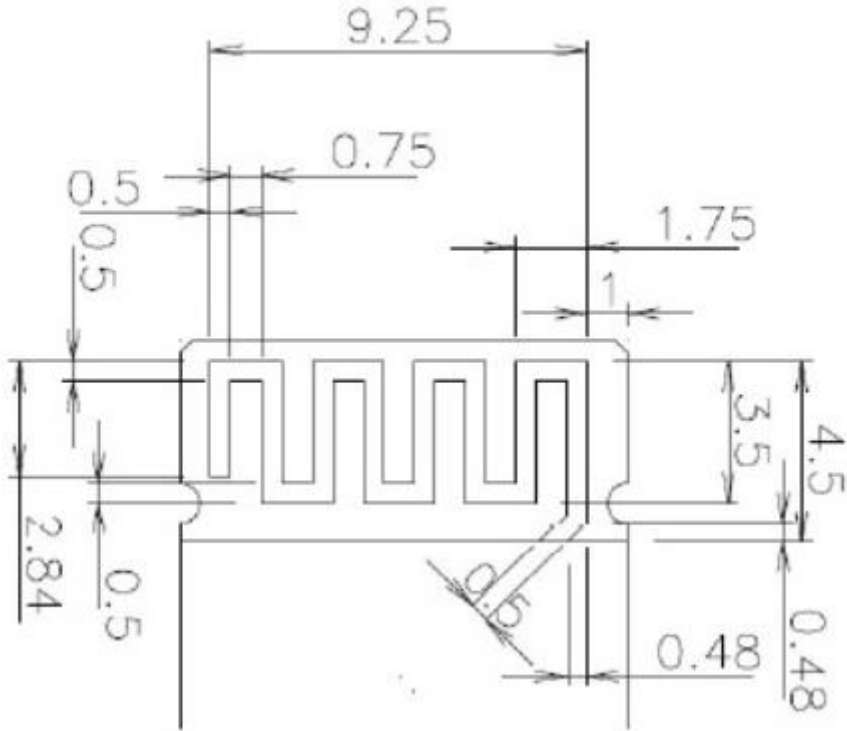

Antenna dimensions (mm)

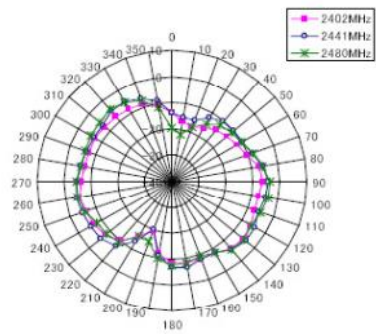
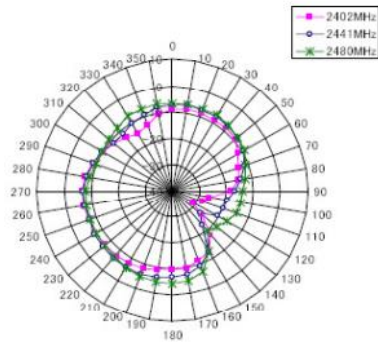
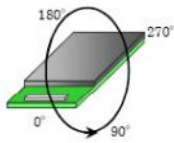
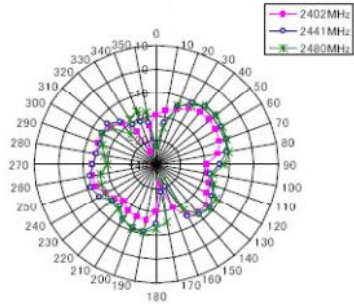
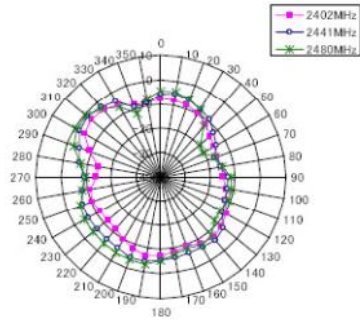
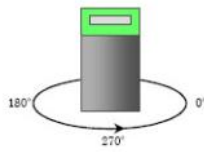
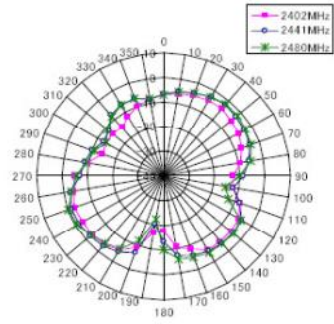
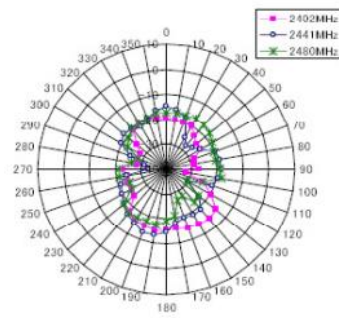
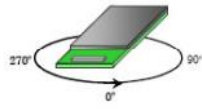

Antenna Gain (dBi)