



FCC TEST REPORT FOR

Datecs Ltd.

BlueCash-50

Test Model: BlueCash-50

Additional Model No.: QuantumPay Pro Plus

Prepared for : Datecs Ltd.
Address : 115A Tzarigradsko Shosse, Fl.4 SOFIA Bulgaria

Prepared by : Shenzhen LCS Compliance Testing Laboratory Ltd.
Address : 101, 201 Bldg A & 301 Bldg C, Juji Industrial Park
Yabianxueziwei, Shajing Street, Baoan District, Shenzhen,
518000, China
Tel : (+86)755-82591330
Fax : (+86)755-82591332
Web : www.LCS-cert.com
Mail : webmaster@LCS-cert.com

Date of receipt of test sample : September 14, 2022
Number of tested samples : 2
Sample No. : A090822018-1, A090822018-2
Serial number : Prototype
Date of Test : September 14, 2022 ~ September 29, 2022
Date of Report : September 30, 2022





FCC PART 22/24/27 TEST REPORT

FCC Part 22H / Part 24E /Part 27

Report Reference No.: LCSA090822018EH
 FCC ID.: YRW-BLUECASH50
 Date of Issue.: September 30, 2022

Testing Laboratory Name: Shenzhen LCS Compliance Testing Laboratory Ltd.
 Address: 101, 201 Bldg A & 301 Bldg C, Juji Industrial Park Yabianxueziwei, Shajing Street, Baoan District, Shenzhen, 518000, China

Applicant's name: Datecs Ltd.
 Address: 115A Tzarigradsko Shosse, Fl.4 SOFIA Bulgaria

Test specification:
 Standard: FCC Part 22H: Cellular Radiotelephone Service
 FCC Part 24E: Broadband PCS
 FCC Part 27: MISCELLANEOUS WIRELESS COMMUNICATIONS SERVICES

Test Report Form No: LCSEMC-1.0
 TRF Originator.....: Shenzhen LCS Compliance Testing Laboratory Ltd.
 Master TRF: Dated 2011-03

Shenzhen LCS Compliance Testing Laboratory Ltd. All rights reserved.
 This publication may be reproduced in whole or in part for non-commercial purposes as long as the Shenzhen LCS Compliance Testing Laboratory Ltd. is acknowledged as copyright owner and source of the material. Shenzhen LCS Compliance Testing Laboratory Ltd. takes no responsibility for and will not assume liability for damages resulting from the reader's interpretation of the reproduced material due to its placement and context.

Test item description: BlueCash-50
 Trade Mark: N/A
 Test Model.....: BlueCash-50
 Ratings: Input: DC 5V/2.4A
 Output: DC 5V/0.5A
 DC 7.2V by Rechargeable Li-ion Battery, 2600mAh
 Hardware version: 21.12.xx.xxx
 Software version: 1.0.xx.xx
 Frequency: UMTS Band II/IV/V
 Result: PASS

Compiled by:

Kay Hu/ Administrator

Supervised by:

Cary Luo/ Technique principal

Approved by:

Gavin Liang/ Manager





TEST REPORT

| | | |
|--------------------------|------------------------|--------------------|
| Test Report No. : | LCSA090822018EH | September 30, 2022 |
| | | Date of issue |

| | |
|--------------------------|---|
| EUT..... | : BlueCash-50 |
| Test Model..... | : BlueCash-50 |
| Applicant..... | : Datecs Ltd. |
| Address..... | : 115A Tzarigradsko Shosse, Fl.4 SOFIA Bulgaria |
| Telephone..... | : / |
| Fax..... | : / |
| Manufacturer..... | : Datecs Ltd. |
| Address..... | : 115A Tzarigradsko Shosse, Fl.4 SOFIA Bulgaria |
| Telephone..... | : / |
| Fax..... | : / |
| Factory..... | : Datecs Ltd. |
| Address..... | : 115A Tzarigradsko Shosse, Fl.4 SOFIA Bulgaria |
| Telephone..... | : / |
| Fax..... | : / |

| | |
|---------------------|-------------|
| Test Result: | PASS |
|---------------------|-------------|

The test report merely corresponds to the test sample.
 It is not permitted to copy extracts of these test result without the written permission of the test laboratory.





Revision History

| Report Version | Issue Date | Revision Content | Revised By |
|----------------|--------------------|------------------|------------|
| 000 | September 30, 2022 | Initial Issue | --- |
| | | | |
| | | | |





Contents

| | | |
|----------|---|-----------|
| 1 | <u>TEST STANDARDS</u> | 6 |
| 2 | <u>SUMMARY</u> | 7 |
| 2.1 | Product Description | 7 |
| 2.2 | Equipment under Test | 10 |
| 2.3 | Short description of the Equipment under Test (EUT) | 10 |
| 2.4 | Internal Identification of AE used during the test | 10 |
| 2.5 | Normal Accessory setting | 10 |
| 2.6 | Test Sample | 11 |
| 2.7 | EUT configuration | 11 |
| 2.8 | Related Submittal(s) / Grant (s) | 11 |
| 2.9 | Modifications | 11 |
| 2.10 | General Test Conditions/Configurations | 11 |
| 3 | <u>TEST ENVIRONMENT</u> | 12 |
| 3.1 | Address of the test laboratory | 12 |
| 3.2 | Test Facility | 12 |
| 3.3 | Environmental conditions | 12 |
| 3.4 | Test Description | 13 |
| 3.5 | Equipments Used during the Test | 15 |
| 3.6 | Measurement uncertainty | 16 |
| 4 | <u>TEST CONDITIONS AND RESULTS</u> | 17 |
| 4.1 | Output Power | 17 |
| 4.2 | Radiated Spurious Emssion | 21 |
| 4.3 | Occupied Bandwidth and Emission Bandwith | 25 |
| 4.4 | Band Edge Compliance | 28 |
| 4.5 | Spurious Emssion on Antenna Port | 31 |
| 4.6 | Frequency Stability Test | 41 |
| 4.7 | Peak-to-Average Ratio (PAR) | 44 |
| 5 | <u>TEST SETUP PHOTOS OF THE EUT</u> | 47 |
| 6 | <u>EXTERNAL PHOTOS OF THE EUT</u> | 47 |
| 7 | <u>INTERNAL PHOTOS OF THE EUT</u> | 47 |





1 TEST STANDARDS

The tests were performed according to following standards:

[FCC Part 22H](#): Cellular Radiotelephone Service.

[FCC Part 24E](#): Broadband PCS.

[FCC Part 27](#): MISCELLANEOUS WIRELESS COMMUNICATIONS SERVICES

[TIA-603-E March 2016](#): Land Mobile FM or PM Communications Equipment Measurement and Performance Standards.

[47 CFR FCC Part 15 Subpart B](#): Unintentional Radiators.

[FCC Part 2](#): Frequency Allocations And Radio Treaty Matters; General Rules And Regulations.

[ANSI C63.4:2014](#): Methods of Measurement of Radio-Noise Emissions from Low-Voltage Electrical and Electronic Equipment in the Range of 9 kHz to 40 GHz.

[FCC KDB971168 D01](#): Power Meas License Digital Systems v03r01.

[ANSI C63.26-2015](#): Compliance Testing of Transmitters Used in Licensed Radio Services.



Shenzhen LCS Compliance Testing Laboratory Ltd.

Add: 101, 201 Bldg A & 301 Bldg C, Juji Industrial Park Yabianxueziwei, Shajing Street, Baoan District, Shenzhen, 518000, China

Tel: +(86) 0755-82591330 | E-mail: webmaster@lcs-cert.com | Web: www.lcs-cert.com

Scan code to check authenticity



2 SUMMARY

2.1 Product Description

The **Datacs Ltd.**'s Model: BlueCash-50 or the "EUT" as referred to in this report; more general information as follows, for more details, refer to the user's manual of the EUT.

| | |
|----------------------|---|
| EUT | : BlueCash-50 |
| Test Model | : BlueCash-50 |
| Additional Model No. | : QuantumPay Pro Plus |
| Model Declaration | : PCB board, structure and internal of these model(s) are the same, So no additional models were tested |
| Power Supply | : Input: DC 5V/2.4A Output: DC 5V/0.5A DC 7.2V by Rechargeable Li-ion Battery, 2600mAh |
| Hardware Version | : 21.12.xx.xxx |
| Software Version | : 1.0.xx.xx |

WIFI(2.4G Band)

| | |
|---------------------|--|
| Frequency Range | : 2412MHz ~ 2462MHz |
| Channel Spacing | : 5MHz |
| Channel Number | : 11 Channels for 20MHz bandwidth (2412~2462MHz) 7 Channels for 40MHz bandwidth (2422~2452MHz) |
| Modulation Type | : IEEE 802.11b: DSSS (CCK, DQPSK, DBPSK) IEEE 802.11g: OFDM (64QAM, 16QAM, QPSK, BPSK) IEEE 802.11n: OFDM (64QAM, 16QAM, QPSK, BPSK) |
| Antenna Description | : FPC Antenna, 1.36dBi(Max.) |

5G WLAN

| | |
|---------------------|---|
| Frequency Range | : 5180-5240MHz,5260-5320MHz,5500-5700MHz |
| Channel Number | : 4 Channels for 20MHz bandwidth(5180MHz-5240MHz) 4 Channels for 20MHz bandwidth(5260MHz-5320MHz) 11 Channels for 20MHz bandwidth(5500MHz-5700MHz) 2 channels for 40MHz bandwidth(5190MHz~5230MHz) 2 channels for 40MHz bandwidth(5270MHz~5310MHz) 5 Channels for 40MHz bandwidth(5510MHz-5670MHz) 1 channels for 80MHz bandwidth(5210MHz) 1 channels for 80MHz bandwidth(5290MHz) 2 Channels for 80MHz bandwidth(5530MHz, 5610MHz) |
| Modulation Type | : IEEE 802.11a/n/ac: OFDM (256QAM, 64QAM, 16QAM, QPSK, BPSK) |
| Antenna Description | : FPC Antenna, -0.14dBi(Max.) For 5180-5240MHz -0.24dBi(Max.) For 5260-5320MHz 0.42dBi(Max.) For 5500-5700MHz |

5.8G WLAN

| | |
|-----------------|---|
| Frequency Range | : 5745MHz-5825MHz |
| Channel Number | : 5 channels for 20MHz bandwidth(5745MHz-5825MHz) 2 channels for 40MHz bandwidth(5755MHz~5795MHz) 1 channels for 80MHz bandwidth(5775MHz) |



Shenzhen LCS Compliance Testing Laboratory Ltd.

Add: 101, 201 Bldg A & 301 Bldg C, Juji Industrial Park Yabianxueziwei, Shajing Street, Baoan District, Shenzhen, 518000, China

Tel: +(86) 0755-82591330 | E-mail: webmaster@lcs-cert.com | Web: www.lcs-cert.com

Scan code to check authenticity



Modulation Type : IEEE 802.11a/n/ac: OFDM (256QAM, 64QAM, 16QAM, QPSK, BPSK)

Antenna Description : FPC Antenna, 1.0dBi(Max.)

2G :

Support Band : GSM 900 (EU-Band) DCS 1800 (EU-Band)
GSM 850 (U.S.-Band) PCS 1900 (U.S.-Band)

Release Version : R99

GPRS Class : Class 12

EGPRS Class : Class 12

Type Of Modulation : GMSK for GSM/GPRS; GMSK/8PSK for EGPRS

Antenna Description : FPC Antenna
-3.63dBi (max.) For GSM 850
0.10dBi (max.) For PCS 1900

3G :

Support Band : WCDMA Band II (U.S.-Band)
WCDMA Band V (U.S.-Band)
WCDMA Band IV (U.S.-Band)
WCDMA Band I (EU-Band)
WCDMA Band VIII (EU-Band)

Release Version : R7/R8

Type Of Modulation : QPSK,16QAM

Antenna Description : FPC Antenna
0.10dBi (max.) For WCDMA Band II
1.88dBi (max.) For WCDMA Band IV
-3.63dBi (max.) For WCDMA Band V

LTE :

Support Band : E-UTRA Band 2(U.S.-Band)
E-UTRA Band 4(U.S.-Band)
E-UTRA Band 5(U.S.-Band)
E-UTRA Band 7(U.S.-Band)
E-UTRA Band 12(U.S.-Band)
E-UTRA Band 17(U.S.-Band)
E-UTRA Band 25(U.S.-Band)
E-UTRA Band 26(U.S.-Band)
E-UTRA Band 38(U.S.-Band)
E-UTRA Band 41(U.S.-Band)
E-UTRA Band 66(U.S.-Band)

LTE Release Version : R9

Type Of Modulation : QPSK/16QAM

Antenna Description : FPC Antenna
0.10dBi (max.) For E-UTRA Band 2
1.88dBi (max.) For E-UTRA Band 4
-3.63dBi (max.) For E-UTRA Band 5
1.85dBi (max.) For E-UTRA Band 7
-3.77dBi (max.) For E-UTRA Band 12
-3.77dBi (max.) For E-UTRA Band 17
0.10dBi (max.) For E-UTRA Band 25
-3.63dBi (max.) For E-UTRA Band 26
1.57dBi (max.) For E-UTRA Band 38





1.85dBi (max.) For E-UTRA Band 41
1.88dBi (max.) For E-UTRA Band 66
Power Class : Class 3
NFC :
Operating Frequency : 13.56MHz
Modulation Type : ASK
Antenna Description : FPC Antenna, 0dBi(Max.)
GPS function : Support and only RX
Extreme temp. Tolerance : -30°C to +50°C
Extreme vol. Limits : 6.2VDC to 8.4VDC (nominal: 7.2VDC)





2.2 Equipment under Test

Power supply system utilised

| | | | |
|----------------------|---|---|-----------------------------------|
| Power supply voltage | : | <input type="radio"/> 120V / 60 Hz | <input type="radio"/> 115V / 60Hz |
| | | <input type="radio"/> 12 V DC | <input type="radio"/> 24 V DC |
| | | <input checked="" type="radio"/> Other (specified in blank below) 7.2V DC | |

Test frequency list

| Test Mode | TX/RX | RF Channel | | |
|---------------|-------|--------------|--------------|--------------|
| | | Low(L) | Middle (M) | High (H) |
| WCDMA Band V | TX | Channel 4132 | Channel 4182 | Channel 4233 |
| | | 826.4 MHz | 836.4 MHz | 846.6 MHz |
| | RX | Channel 4357 | Channel 4407 | Channel 4458 |
| | | 871.4 MHz | 881.4 MHz | 891.6 MHz |
| Test Mode | TX/RX | RF Channel | | |
| WCDMA Band II | TX | Channel 9262 | Channel 9400 | Channel 9538 |
| | | 1852.4 MHz | 1880.0 MHz | 1907.6 MHz |
| | RX | Channel 9662 | Channel 9800 | Channel 9938 |
| | | 1932.4 MHz | 1960.0 MHz | 1987.6 MHz |
| Test Mode | TX/RX | RF Channel | | |
| WCDMA Band IV | TX | Channel1312 | Channel1413 | Channel1513 |
| | | 1712.4MHz | 1732.6MHz | 1752.6MHz |
| | RX | Channel1537 | Channel1638 | Channel1738 |
| | | 2112.4MHz | 2132.6MHz | 2152.6MHz |

2.3 Short description of the Equipment under Test (EUT)

2.3.1 General Description

BlueCash-50 is subscriber equipment in the 2.4GWIFI/5GWIFI/5.8GWIFI/GSM/WCDMA/LTE/NFC/GPS system. GSM/GPRS/EGPRS frequency band is Band II/V. The HSPA/UMTS frequency band is Band II/IV/V. LTE frequency band is band 2/4/5/7/12/17/25/26/38/41/66. The HSPA/UMTS frequency band II and Band IV and Band V test data included in this report. The BlueCash-50 implements such functions as RF signal receiving/transmitting, GSM/GPRS/EGPRS/ HSPA/UMTS/LTE protocol processing, video MMS service and etc. Externally it provides SIM card interface.

2.4 Internal Identification of AE used during the test

| AE ID* | Description |
|--------|---------------------------------|
| AE1 | Rechargeable Li-Polymer Battery |
| AE2 | Switching Adapter |

AE2

Adapter Model: ES518-U050200XYE

For Adapter Input: 100-240V~, 50/60Hz, 500mA

For Adapter Output: 5.0V---2000mA

2.5 Normal Accessory setting

N/A



Shenzhen LCS Compliance Testing Laboratory Ltd.

Add: 101, 201 Bldg A & 301 Bldg C, Juji Industrial Park Yabianxueziwei, Shajing Street, Baoan District, Shenzhen, 518000, China

Tel: +(86) 0755-82591330 | E-mail: webmaster@lcs-cert.com | Web: www.lcs-cert.com

Scan code to check authenticity



2.6 Test Sample

The application provides 2 samples to meet requirement;

| Sample Number | Description |
|------------------------|---------------------------------------|
| Sample 1(A090822018-1) | Engineer sample – continuous transmit |
| Sample 2(A090822018-2) | Normal sample – Intermittent transmit |

2.7 EUT configuration

The following peripheral devices and interface cables were connected during the measurement:

- - supplied by the manufacturer
- - supplied by the lab

| | | |
|---------------|----------------|---|
| ○ Power Cable | Length (m) : | / |
| | Shield : | / |
| | Detachable : | / |
| ○ Multimeter | Manufacturer : | / |
| | Model No. : | / |

2.8 Related Submittal(s) / Grant (s)

This submittal(s) (test report) is intended for **FCC ID: YRW-BLUECASH50** filing to comply with FCC Part 22H, Part 24E, FCC Part 27 Rules.

2.9 Modifications

No modifications were implemented to meet testing criteria.

2.10 General Test Conditions/Configurations

2.10.1 Test Modes

NOTE: The test mode(s) are selected according to relevant radio technology specifications.

| Test Mode | Test Modes Description |
|-----------|-------------------------------------|
| UMTS/TM1 | WCDMA system, QPSK,16QAM modulation |
| UMTS/TM2 | HSDPA system, QPSK,16QAM modulation |
| UMTS/TM3 | HSUPA system, QPSK,16QAM modulation |

Note: As WCDMA, HSDPA and HSUPA with the same emission designator, test result recorded in this report at the worst case UMTS/TM1 only after exploratory scan.

2.10.2 Test Environment

| Environment Parameter | Selected Values During Tests | |
|-----------------------|------------------------------|---------|
| Relative Humidity | Ambient | |
| Temperature | TN | Ambient |
| Voltage | VL | DC 6.2V |
| | VN | DC 7.2V |
| | VH | DC 8.4V |

NOTE: VL=lower extreme test voltage VN=nominal voltage
VH=upper extreme test voltage TN=normal temperature





3 TEST ENVIRONMENT

3.1 Address of the test laboratory

Shenzhen LCS Compliance Testing Laboratory Ltd

101, 201 Bldg A & 301 Bldg C, Juji Industrial Park Yabianxueziwei, Shajing Street, Baoan District, Shenzhen, 518000, China

The sites are constructed in conformance with the requirements of ANSI C63.4 (2014) and CISPR Publication 32.

3.2 Test Facility

The test facility is recognized, certified, or accredited by the following organizations:

NVLAP Accreditation Code is 600167-0.

FCC Designation Number is CN5024.

CAB identifier is CN0071.

CNAS Registration Number is L4595.

Test Firm Registration Number: 254912

3.3 Environmental conditions

During the measurement the environmental conditions were within the listed ranges:

| | |
|-----------------------|--------------|
| Temperature: | 15-35 ° C |
| Humidity: | 30-60 % |
| Atmospheric pressure: | 950-1050mbar |

(1)expressed at approximately the 95% confidence level using a coverage factor of k=1.96.



Shenzhen LCS Compliance Testing Laboratory Ltd.

Add: 101, 201 Bldg A & 301 Bldg C, Juji Industrial Park Yabianxueziwei, Shajing Street, Baoan District, Shenzhen, 518000, China

Tel: +(86) 0755-82591330 | E-mail: webmaster@lcs-cert.com | Web: www.lcs-cert.com

Scan code to check authenticity



3.4 Test Description

3.4.1 Cellular Band (824-849MHz paired with 869-894MHz) (Band V)

| Test Item | FCC Rule No. | Requirements | Verdict |
|--|------------------|---|---------|
| Effective(Isotropic) Radiated Output Power | §2.1046, §22.913 | FCC: ERP ≤ 7W. | Pass |
| Modulation Characteristics | §2.1047 | Digital modulation | N/A |
| Bandwidth | §2.1049 | OBW: No limit. EBW: No limit. | Pass |
| Band Edges Compliance | §2.1051, §22.917 | ≤-13dBm/1%*EBW, in 1MHz bands immediately outside and adjacent to The frequency block. | Pass |
| Spurious Emission at Antenna Terminals | §2.1051, §22.917 | ≤ -13dBm/100kHz, from 9kHz to 10 th harmonics but outside authorized operating frequency ranges. | Pass |
| Field Strength of Spurious Radiation | §2.1053, §22.917 | ≤ -13dBm/100kHz. | Pass |
| Frequency Stability | §2.1055, §22.355 | ≤ ±2.5ppm. | Pass |
| Peak-Average Ratio | §24.232 | ≤13dB | Pass |

NOTE 1: For the verdict, the "N/A" denotes "not applicable", the "N/T" de notes "not tested".

3.4.2 PCS Band (1850-1910MHz paired with 1930-1990MHz) (Band II)

| Test Item | FCC Rule No. | Requirements | Verdict |
|--|------------------|--|---------|
| Effective(Isotropic) Radiated Output Power | §2.1046, §24.232 | EIRP ≤ 2W | Pass |
| Peak-Average Ratio | §2.1046, §24.232 | ≤13dB | Pass |
| Modulation Characteristics | §2.1047 | Digital modulation | N/A |
| Bandwidth | §2.1049 | OBW: No limit. EBW: No limit. | Pass |
| Band Edges Compliance | §2.1051, §24.238 | ≤ -13dBm/1%*EBW, In 1MHz bands immediately outside and adjacent to The frequency block. | Pass |
| Spurious Emission at Antenna Terminals | §2.1051, §24.238 | ≤-13dBm/1MHz, from 9kHz to 10 th harmonics but outside authorized operating frequency ranges. | Pass |
| Field Strength of Spurious Radiation | §2.1053, §24.238 | ≤ -13dBm/1MHz. | Pass |
| Frequency Stability | §2.1055, §24.235 | ≤ ±2.5ppm. | Pass |

NOTE 1: For the verdict, the "N/A" denotes "not applicable", the "N/T" de notes "not tested".



Shenzhen LCS Compliance Testing Laboratory Ltd.

Add: 101, 201 Bldg A & 301 Bldg C, Juji Industrial Park Yabianxueziwei, Shajing Street, Baoan District, Shenzhen, 518000, China

Tel: +(86) 0755-82591330 | E-mail: webmaster@lcs-cert.com | Web: www.lcs-cert.com

Scan code to check authenticity

**3.4.3 AWS Band (1710-1755MHz pairedwith 2110-2155MHz) (Band IV)**

| Test Item | FCC RuleNo. | Requirements | Verdict |
|---|--------------------|--|---------|
| Effective(Isotropic) Radiated Power Output Data | §2.1046, §27.50(d) | EIRP ≤ 1W; | Pass |
| Peak-Average Ratio | §2.1046, §27.50(d) | Limits≤13dB | Pass |
| Modulation Characteristics | §2.1047 | Digitalmodulation | N/A |
| Bandwidth | §2.1049 | OBW: Nolimit. EBW: Nolimit. | Pass |
| BandEdges Compliance | §2.1051, §27.53(h) | ≤ -13dBm/1%*EBW,in1 MHz bands immediately outside and adjacent to the frequency block. | Pass |
| Spurious Emission at Antenna Terminals | §2.1051, §27.53(h) | ≤ -13dBm/1MHz, from 9kHz to10th harmonics but outside authorized operating frequency ranges. | Pass |
| Frequency Stability | §2.1055, §27.54 | Within authorized bands of operation/frequency block. | Pass |
| Radiated spurious emission | §2.1053, §27.53(h) | ≤ -13dBm/1MHz. | Pass |

NOTE 1: For the verdict, the "N/A" denotes "not applicable", the "N/T" de notes "not tested"



Shenzhen LCS Compliance Testing Laboratory Ltd.

Add: 101, 201 Bldg A & 301 Bldg C, Juji Industrial Park Yabianxueziwei, Shajing Street, Baoan District, Shenzhen, 518000, China

Tel: +(86) 0755-82591330 | E-mail: webmaster@lcs-cert.com | Web: www.lcs-cert.com

Scan code to check authenticity



3.5 Equipments Used during the Test

| Item | Equipment | Manufacturer | Model No. | Serial No. | Cal Date | Due Date |
|------|-------------------------------------|-------------------|------------|-------------|------------|------------|
| 1 | Power Meter | R&S | NRVS | 100444 | 2022-06-16 | 2023-06-15 |
| 2 | Power Sensor | R&S | NRV-Z81 | 100458 | 2022-06-16 | 2023-06-15 |
| 3 | Power Sensor | R&S | NRV-Z32 | 10057 | 2022-06-16 | 2023-06-15 |
| 4 | LTE Test Software | Tonscend | JS1120-1 | N/A | N/A | N/A |
| 5 | RF Control Unit | Tonscend | JS0806-1 | 158060009 | 2022-06-16 | 2023-06-15 |
| 6 | MXA Signal Analyzer | Agilent | N9020A | MY51250905 | 2021-11-16 | 2022-11-15 |
| 7 | WIDEBAND RADIO COMMUNICATION TESTER | R&S | CMW 500 | 103818 | 2022-06-16 | 2023-06-15 |
| 8 | DC Power Supply | Agilent | E3642A | N/A | 2021-11-15 | 2022-11-14 |
| 9 | EMI Test Software | AUDIX | E3 | / | N/A | N/A |
| 10 | 3m Semi Anechoic Chamber | SIDT FRANKONIA | SAC-3M | 03CH03-HY | 2022-06-16 | 2023-06-15 |
| 11 | Positioning Controller | Max-Full | MF7802BS | MF780208586 | N/A | N/A |
| 12 | Active Loop Antenna | SCHWARZBECK | FMZB 1519B | 00005 | 2021-08-29 | 2024-08-28 |
| 13 | By-log Antenna | SCHWARZBECK | VULB9163 | 9163-470 | 2021-09-12 | 2024-09-11 |
| 14 | Horn Antenna | SCHWARZBECK | BBHA 9120D | 9120D-1925 | 2021-09-05 | 2024-09-04 |
| 15 | Broadband Horn Antenna | SCHWARZBECK | BBHA 9170 | 791 | 2021-08-29 | 2024-08-28 |
| 16 | Broadband Preamplifier | SCHWARZBECK | BBV9719 | 9719-025 | 2022-06-16 | 2023-06-15 |
| 17 | EMI Test Receiver | R&S | ESR 7 | 101181 | 2022-06-16 | 2023-06-15 |
| 18 | RS SPECTRUM ANALYZER | R&S | FSP40 | 100503 | 2021-11-16 | 2022-11-15 |
| 19 | Broadband Preamplifier | / | BP-01M18G | P190501 | 2022-06-16 | 2023-06-15 |
| 20 | 6dB Attenuator | / | 100W/6dB | 1172040 | 2022-06-16 | 2023-06-15 |
| 21 | 3dB Attenuator | / | 2N-3dB | / | 2021-11-15 | 2022-11-14 |
| 22 | Temperature & Humidity Chamber | GUANGZHOU GOGNWEN | GDS-100 | 70932 | 2021-10-07 | 2022-10-06 |
| 23 | EMI Test Software | Farad | EZ | / | N/A | N/A |



Shenzhen LCS Compliance Testing Laboratory Ltd.

Add: 101, 201 Bldg A & 301 Bldg C, Juji Industrial Park Yabianxueziwei, Shajing Street, Baoan District, Shenzhen, 518000, China

Tel: +(86) 0755-82591330 | E-mail: webmaster@lcs-cert.com | Web: www.lcs-cert.com

Scan code to check authenticity



3.6 Measurement uncertainty

The data and results referenced in this document are true and accurate. The reader is cautioned that there may be errors within the calibration limits of the equipment and facilities. The measurement uncertainty was calculated for all measurements listed in this test report acc. to ETSI TR 100 028 " Electromagnetic compatibility and Radio spectrum Matters (ERM); Uncertainties in the measurement of mobile radio equipment characteristics" and is documented in the Shenzhen LCS Compliance Testing Laboratory Ltd. quality system acc. to DIN EN ISO/IEC 17025. Furthermore, component and process variability of devices similar to that tested may result in additional deviation. The manufacturer has the sole responsibility of continued compliance of the device.

Hereafter the best measurement capability for Shenzhen LCS Compliance Testing Laboratory Ltd. is reported:

| Test | Range | Measurement Uncertainty | Notes |
|-------------------------------------|------------|-------------------------|-------|
| Radiated Emission | 30~1000MHz | 3.10 dB | (1) |
| Radiated Emission | 1~18GHz | 3.80 dB | (1) |
| Radiated Emission | 18-40GHz | 3.90 dB | (1) |
| Conducted Disturbance | 0.15~30MHz | 1.63 dB | (1) |
| Conducted Power | 9KHz~18GHz | 0.61 dB | (1) |
| Spurious RF Conducted Emission | 9KHz~40GHz | 1.22 dB | (1) |
| Band Edge Compliance of RF Emission | 9KHz~40GHz | 1.22 dB | (1) |
| Occupied Bandwidth | 9KHz~40GHz | - | (1) |

(1) This uncertainty represents an expanded uncertainty expressed at approximately the 95% confidence level using a coverage factor of $k=1.96$.



Shenzhen LCS Compliance Testing Laboratory Ltd.

Add: 101, 201 Bldg A & 301 Bldg C, Juji Industrial Park Yabianxueziwei, Shajing Street, Baoan District, Shenzhen, 518000, China

Tel: +(86) 0755-82591330 | E-mail: webmaster@lcs-cert.com | Web: www.lcs-cert.com

Scan code to check authenticity



4 TEST CONDITIONS AND RESULTS

4.1 Output Power

TEST APPLICABLE

During the process of testing, the EUT was controlled via R&S WIDEBAND RADIO COMMUNICATION TESTER (CMW 500) to ensure max power transmission and proper modulation. This result contains output power and EIRP measurements for the EUT. In all cases, output power is within the specified limits.

4.1.1. Conducted Output Power

TEST CONFIGURATION

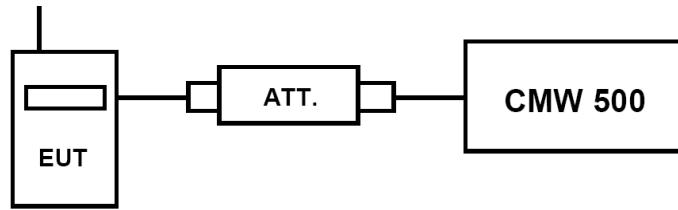

TEST PROCEDURE

Conducted Power Measurement:

- Place the EUT on a bench and set it in transmitting mode.
- Connect a low loss RF cable from the antenna port to a CMW 500 by an Att.
- EUT Communicate with CMW 500 then selects a channel for testing.
- Add a correction factor to the display CMW 500, and then test.

TEST RESULTS

| Item | band | WCDMA Band II result (dBm) | | | WCDMA Band IV result (dBm) | | | WCDMA Band V result (dBm) | | |
|-------|--------------|----------------------------|---------------|-----------------|----------------------------|-----------------|-----------------|---------------------------|----------------|----------------|
| | | Channel/Frequency(MHz) | | | Channel/Frequency(MHz) | | | Channel/Frequency(MHz) | | |
| | | 9262/ 1852.4 | 9400/ 1880 | 9538/ 1907.6 | 1312/ 1712.4 | 1413/ 1732.6 | 1513/ 1752.6 | 4132/ 826.4 | 4182/ 836.4 | 4233/ 846.6 |
| RMC | 12.2kbps RMC | 23.29 | 23.34 | 23.25 | 23.25 | 23.27 | 23.37 | 22.72 | 22.87 | 22.74 |
| HSDPA | Sub -Test 1 | 22.76 | 22.75 | 22.55 | 22.46 | 22.64 | 22.63 | 22.42 | 22.75 | 22.64 |
| | Sub -Test 2 | 22.51 | 22.52 | 22.69 | 22.57 | 22.50 | 22.58 | 22.66 | 22.69 | 22.71 |
| | Sub -Test 3 | 22.57 | 22.47 | 22.54 | 22.46 | 22.56 | 22.52 | 22.49 | 22.73 | 22.59 |
| | Sub -Test 4 | 22.43 | 22.71 | 22.45 | 22.36 | 22.53 | 22.61 | 22.64 | 22.60 | 22.57 |
| HSUPA | Sub -Test 1 | 22.52 | 22.47 | 22.47 | 22.39 | 22.59 | 22.58 | 22.51 | 22.58 | 22.45 |
| | Sub -Test 2 | 22.49 | 22.59 | 22.26 | 22.41 | 22.85 | 22.63 | 22.46 | 22.74 | 22.54 |
| | Sub -Test 3 | 22.63 | 22.64 | 22.46 | 22.62 | 22.60 | 22.37 | 22.51 | 22.69 | 22.50 |
| | Sub -Test 4 | 22.42 | 22.35 | 22.30 | 22.37 | 22.48 | 22.39 | 21.66 | 21.88 | 21.75 |
| | Sub -Test 5 | 21.54 | 21.77 | 21.45 | 21.74 | 21.08 | 21.79 | 21.59 | 21.68 | 21.51 |



4.1.1 Radiated Output Power

TEST DESCRIPTION

This is the test for the maximum radiated power from the EUT.

Rule Part 24.232(c) specifies, "Mobile/portable stations are limited to 2 watts e.i.r.p. Peak power" and 24.232(e) specifies that "Peak transmit power must be measured over any interval of continuous transmission using instrumentation calibrated in terms of an rms-equivalent voltage."

Rule Part 22.913(a) specifies "The ERP of mobile transmitters and auxiliary test transmitters must not exceed 7 Watts."

Per Part 27.50(d) (4) specifies, Fixed, mobile, and portable (hand-held) stations operating in the 1710-1755MHz band are limited to 1W EIRP. Fixed stations operating in this band are limited to a maximum antenna height of 10 meters above ground. Mobile and portable stations operating in this band must employ a means for limiting power to the minimum necessary for successful communications.

TEST CONFIGURATION

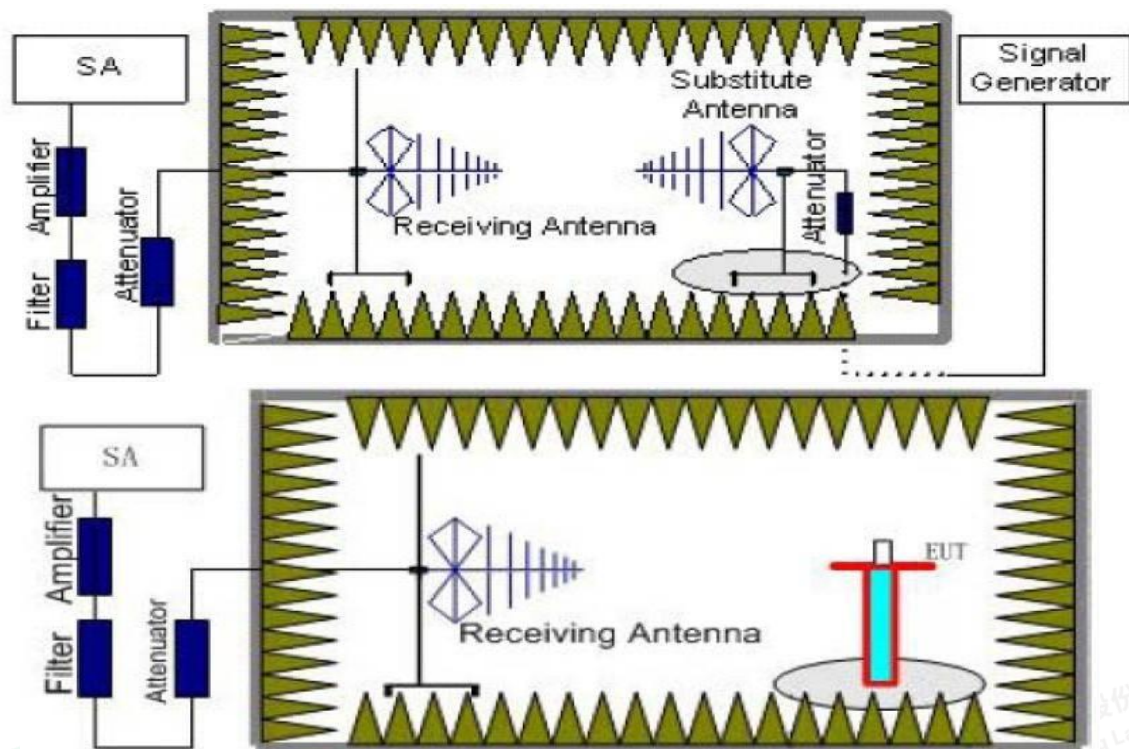

TEST PROCEDURE

1. EUT was placed on a 1.50 meter high non-conductive stand at a 3 meter test distance from the receive antenna. A receiving antenna was placed on the antenna mast 3 meters from the EUT for emission measurements. The height of receiving antenna is 1.50m. Detected emissions were maximized at each frequency by rotating the EUT through 360° and adjusting the receiving antenna polarization. The radiated emission measurements of all transmit frequencies in three channels (High, Middle, Low) were measured with peak detector.
2. A log-periodic antenna or double-ridged waveguide horn antenna shall be substituted in place of the EUT. The log-periodic antenna will be driven by a signal generator and the level will be adjusted till the same power value on the spectrum analyzer or receiver. The level of the spurious emissions can be calculated through the level of the signal generator, cable loss, the gain of the substitution antenna and the reading of the spectrum analyzer or receiver.





3. The EUT is then put into continuously transmitting mode at its maximum power level during the test. Set Test Receiver or Spectrum RBW=10MHz, VBW=10MHz, And the maximum value of the receiver should be recorded as (P_r).
4. The EUT shall be replaced by a substitution antenna. In the chamber, an substitution antenna for the frequency band of interest is placed at the reference point of the chamber. An RF Signal source for the frequency band of interest is connected to the substitution antenna with a cable that has been constructed to not interfere with the radiation pattern of the antenna. A power (P_{Mea}) is applied to the input of the substitution antenna, and adjust the level of the signal generator output until the value of the receiver reach the previously recorded (P_r). The power of signal source (P_{Mea}) is recorded. The test should be performed by rotating the test item and adjusting the receiving antenna polarization.
5. A amplifier should be connected to the Signal Source output port. And the cable should be connect between the Amplifier and the Substitution Antenna. The cable loss (P_{cl}), the Substitution Antenna Gain (G_a) and the Amplifier Gain (P_{Ag}) should be recorded after test.
The measurement results are obtained as described below:
 $Power(EIRP) = P_{Mea} + P_{Ag} - P_{cl} + G_a$
6. This value is EIRP since the measurement is calibrated using an antenna of known gain (2.15 dBi) and known input power.
7. ERP can be calculated from EIRP by subtracting the gain of the dipole, $ERP = EIRP - 2.15dBi$.

TEST LIMIT

According to 22.913(a)(5), 24.232(c), §27.50(d) the ERP(EIRP) should be not exceeding following table limits:

| | |
|--------------|---|
| UMTS Band II | Burst Average EIRP FCC: $\leq 33.01dBm$ (2W) |
| UMTS Band V | Burst Average ERP FCC: $\leq 38.45dBm$ (7W) |
| UMTS Band IV | Burst Average EIRP FCC: $\leq 30.00dBm$ (1W) |

TEST RESULTS

Remark:

1. We were tested all Configuration refer 3GPP TS134 121.
2. $EIRP = P_{Mea}(dBm) - P_{cl}(dB) + P_{Ag}(dB) + G_a(dBi)$
3. $ERP = EIRP - 2.15dBi$ as EIRP by subtracting the gain of the dipole.
4. Margin = Emission Level - Limit
5. We tested the worst-case records for H and V directions, and only the worst-case records for V direction were recorded in the report.



*UMTS/TM1/UMTS Band II*

| Frequency (MHz) | P _{Mea} (dBm) | P _{cl} (dB) | G _a Antenna Gain (dB) | P _{Ag} (dB) | Burst Average EIRP (dBm) | Limit (dBm) | Margin (dB) | Polarization |
|-----------------|------------------------|----------------------|----------------------------------|----------------------|--------------------------|-------------|-------------|--------------|
| 1852.4 | -17.08 | 4.03 | 8.38 | 35.51 | 22.78 | 33.01 | -10.23 | V |
| 1880.0 | -16.69 | 4.08 | 8.33 | 35.56 | 23.12 | 33.01 | -9.89 | V |
| 1907.6 | -17.26 | 4.14 | 8.26 | 35.63 | 22.49 | 33.01 | -10.52 | V |

UMTS/TM1/UMTS Band V

| Frequency (MHz) | P _{Mea} (dBm) | P _{cl} (dB) | G _a Antenna Gain (dB) | Correction (dB) | P _{Ag} (dB) | Burst Average ERP (dBm) | Limit (dBm) | Margin (dB) | Polarization |
|-----------------|------------------------|----------------------|----------------------------------|-----------------|----------------------|-------------------------|-------------|-------------|--------------|
| 826.4 | -13.93 | 3.45 | 8.45 | 2.15 | 33.79 | 22.71 | 38.45 | -15.74 | V |
| 836.4 | -13.25 | 3.49 | 8.45 | 2.15 | 33.85 | 23.41 | 38.45 | -15.04 | V |
| 846.6 | -13.42 | 3.55 | 8.36 | 2.15 | 33.88 | 23.12 | 38.45 | -15.33 | V |

UMTS/TM1/UMTS Band IV

| Frequency (MHz) | P _{Mea} (dBm) | P _{cl} (dB) | G _a Antenna Gain (dB) | P _{Ag} (dB) | Burst Average EIRP (dBm) | Limit (dBm) | Margin (dB) | Polarization |
|-----------------|------------------------|----------------------|----------------------------------|----------------------|--------------------------|-------------|-------------|--------------|
| 1712.4 | -17.80 | 3.93 | 9.05 | 34.96 | 22.28 | 30.00 | -7.72 | V |
| 1732.6 | -17.40 | 3.93 | 8.89 | 35.01 | 22.57 | 30.00 | -7.43 | V |
| 1752.6 | -17.14 | 3.94 | 8.76 | 35.08 | 22.76 | 30.00 | -7.24 | V |



Shenzhen LCS Compliance Testing Laboratory Ltd.

Add: 101, 201 Bldg A & 301 Bldg C, Juji Industrial Park Yabianxueziwei, Shajing Street, Baoan District, Shenzhen, 518000, China

Tel: +(86) 0755-82591330 | E-mail: webmaster@lcs-cert.com | Web: www.lcs-cert.com

Scan code to check authenticity

4.2 Radiated Spurious Emission

TEST APPLICABLE

According to the TIA-603-E:2016 and FCC Part 2.1033 test method, The Receiver or Spectrum was scanned from lowest frequency frequency generated within the equipment to the 10th harmonic of the highest frequency generated within the equipment, which is the transmitted carrier that can be as high as 1910 MHz. The resolution bandwidth is set as outlined in Part 24.238, Part 22.917, Part 27.53 The spectrum is scanned with the mobile station transmitting at carrier frequencies that pertain to low, mid and high channels of WCDMA Band II , WCDMA Band V and WCDMA Band IV.

TEST CONFIGURATION

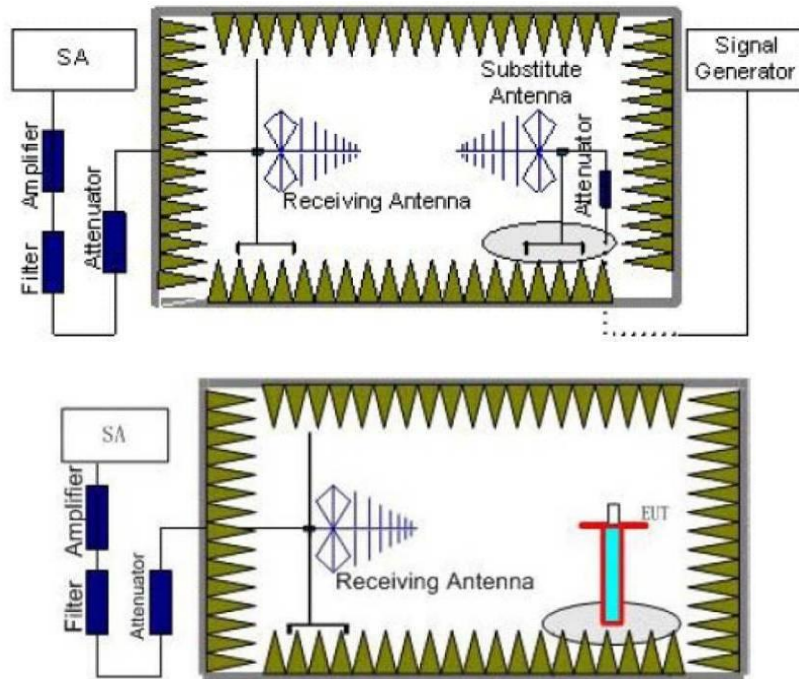

TEST PROCEDURE

1. EUT was placed on a 1.50 meter high non-conductive stand at a 3 meter test distance from the receive antenna. A receiving antenna was placed on the antenna mast 3 meters from the EUT for emission measurements. The height of receiving antenna is 1.50 m. Detected emissions were maximized at each frequency by rotating the EUT through 360° and adjusting the receiving antenna polarization. The radiated emission measurements of all transmit frequencies in three channels (High, Middle, Low) were measured with peak detector.
2. A log-periodic antenna or double-ridged waveguide horn antenna shall be substituted in place of the EUT. The log-periodic antenna will be driven by a signal generator and the level will be adjusted till the same power value on the spectrum analyzer or receiver. The level of the spurious emissions can be calculated through the level of the signal generator, cable loss, the gain of the substitution antenna and the reading of the spectrum analyzer or receiver.
3. The EUT is then put into continuously transmitting mode at its maximum power level during the test. Set Test Receiver or Spectrum RBW=1MHz, VBW=3MHz, And the maximum value of the receiver should be recorded as (P_r).
4. The EUT shall be replaced by a substitution antenna. In the chamber, an substitution antenna for the frequency band of interest is placed at the reference point of the chamber. An RF Signal source for the frequency band of interest is connected to the substitution antenna with a cable that has been constructed to not interfere with the radiation pattern of the antenna. A power (P_{Mea}) is applied to the input of the substitution antenna, and adjust the level of the signal generator output until the value of the receiver reach





the previously recorded (P_r). The power of signal source (P_{Mea}) is recorded. The test should be performed by rotating the test item and adjusting the receiving antenna polarization.

- A amplifier should be connected to the Signal Source output port. And the cable should be connect between the Amplifier and the Substitution Antenna. The cable loss (P_{cl}), the Substitution Antenna Gain (G_a) and the Amplifier Gain (P_{Ag}) should be recorded after test.

The measurement results are obtained as described below:

$$\text{Power(EIRP)} = P_{Mea} + P_{Ag} - P_{cl} + G_a$$

- This value is EIRP since the measurement is calibrated using an antenna of known gain (2.15 dBi) and known input power.
- ERP can be calculated from EIRP by subtracting the gain of the dipole, $ERP = EIRP - 2.15\text{dBi}$.
- In order to make sure test results more clearly, we set frequency range and sweep time for difference frequency range as follows table:

| Working Frequency | Subrange (GHz) | RBW | VBW | Sweep time (s) |
|----------------------------|----------------|--------|--------|----------------|
| UMTS/TM1/ WCDMA Band V | 0.00009~0.15 | 1KHz | 3KHz | 30 |
| | 0.00015~0.03 | 10KHz | 30KHz | 10 |
| | 0.03~1 | 100KHz | 300KHz | 10 |
| | 1~2 | 1 MHz | 3 MHz | 2 |
| | 2~5 | 1 MHz | 3 MHz | 3 |
| | 5~8 | 1 MHz | 3 MHz | 3 |
| | 8~10 | 1 MHz | 3 MHz | 3 |
| UMTS/TM1/ WCDMA Band II | 0.00009~0.15 | 1KHz | 3KHz | 30 |
| | 0.00015~0.03 | 10KHz | 30KHz | 10 |
| | 0.03~1 | 100KHz | 300KHz | 10 |
| | 1~2 | 1 MHz | 3 MHz | 2 |
| | 2~5 | 1 MHz | 3 MHz | 3 |
| | 5~8 | 1 MHz | 3 MHz | 3 |
| | 8~11 | 1 MHz | 3 MHz | 3 |
| | 11~14 | 1 MHz | 3 MHz | 3 |
| | 14~18 | 1 MHz | 3 MHz | 3 |
| UMTS/TM1/ WCDMA Band IV | 0.00009~0.15 | 1KHz | 3KHz | 30 |
| | 0.00015~0.03 | 10KHz | 30KHz | 10 |
| | 0.03~1 | 100KHz | 300KHz | 10 |
| | 1~2 | 1 MHz | 3 MHz | 2 |
| | 2~5 | 1 MHz | 3 MHz | 3 |
| | 5~8 | 1 MHz | 3 MHz | 3 |
| | 8~11 | 1 MHz | 3 MHz | 3 |
| | 11~14 | 1 MHz | 3 MHz | 3 |
| | 14~18 | 1 MHz | 3 MHz | 3 |

TEST LIMITS

According to 24.238, 22.917, 27.53, specify that the power of any emission outside of the authorized operating frequency ranges must be attenuated below the transmitting power (P) by a factor of at least $43 + 10 \log(P)$ dB. The specification that emissions shall be attenuated below the transmitter power (P) by at least $43 + 10 \log(P)$ dB, translates in the relevant power range (1 to 0.001 W) to -13 dBm. At 1 W the specified minimum attenuation becomes 43 dB and relative to a 30 dBm (1 W) carrier becomes a limit of -13 dBm. At 0.001 W (0 dBm) the minimum attenuation is 13 dB, which again yields a limit of -13 dBm. In this way a translation of the specification from relative to absolute terms is carried out.



Shenzhen LCS Compliance Testing Laboratory Ltd.

Add: 101, 201 Bldg A & 301 Bldg C, Juji Industrial Park Yabianxueziwei, Shajing Street, Baoan District, Shenzhen, 518000, China

Tel: +(86) 0755-82591330 | E-mail: webmaster@lcs-cert.com | Web: www.lcs-cert.com

Scan code to check authenticity



| Frequency | Channel | Frequency Range | Verdict |
|----------------------------|---------|-----------------|---------|
| UMTS/TM1/ WCDMA Band V | Low | 9KHz - 10GHz | PASS |
| | Middle | 9KHz - 10GHz | PASS |
| | High | 9KHz - 10GHz | PASS |
| UMTS/TM1/ WCDMA Band II | Low | 9KHz - 20GHz | PASS |
| | Middle | 9KHz - 20GHz | PASS |
| | High | 9KHz - 20GHz | PASS |
| UMTS/TM1/ WCDMA Band IV | Low | 9KHz – 18GHz | PASS |
| | Middle | 9KHz – 18GHz | PASS |
| | High | 9KHz – 18GHz | PASS |

TEST RESULTS

Remark:

1. We were tested all Configuration refer 3GPP TS134 121.
2. $EIRP = P_{Mea}(dBm) - P_{cl}(dB) + P_{Ag}(dB) + G_a(dBi)$
3. $ERP = EIRP - 2.15dBi$ as EIRP by subtracting the gain of the dipole.
4. $Margin = EIRP - Limit$

UMTS/TM1/ WCDMA Band II _ Low Channel

| Frequency (MHz) | P _{Mea} (dBm) | P _{cl} (dB) | Diatance | G _a Antenna Gain(dB) | Peak EIRP (dBm) | Limit (dBm) | Margin (dB) | Polarization |
|-----------------|------------------------|----------------------|----------|---------------------------------|-----------------|-------------|-------------|--------------|
| 3704.8 | -39.94 | 5.26 | 3.00 | 9.88 | -35.32 | -13.00 | -22.32 | H |
| 5557.2 | -45.10 | 6.11 | 3.00 | 11.36 | -39.85 | -13.00 | -26.85 | H |
| 3704.8 | -44.66 | 5.26 | 3.00 | 9.88 | -40.04 | -13.00 | -27.04 | V |
| 5557.2 | -48.27 | 6.11 | 3.00 | 11.36 | -43.02 | -13.00 | -30.02 | V |

UMTS/TM1/ WCDMA Band II _ Middle Channel

| Frequency (MHz) | P _{Mea} (dBm) | P _{cl} (dB) | Diatance | G _a Antenna Gain(dB) | Peak EIRP (dBm) | Limit (dBm) | Margin (dB) | Polarization |
|-----------------|------------------------|----------------------|----------|---------------------------------|-----------------|-------------|-------------|--------------|
| 3760.0 | -38.42 | 5.32 | 3.00 | 10.03 | -33.71 | -13.00 | -20.71 | H |
| 5640.0 | -43.79 | 6.19 | 3.00 | 11.41 | -38.57 | -13.00 | -25.57 | H |
| 3760.0 | -43.67 | 5.32 | 3.00 | 10.03 | -38.96 | -13.00 | -25.96 | V |
| 5640.0 | -47.58 | 6.19 | 3.00 | 11.41 | -42.36 | -13.00 | -29.36 | V |

UMTS/TM1/ WCDMA Band II _ High Channel

| Frequency (MHz) | P _{Mea} (dBm) | P _{cl} (dB) | Diatance | G _a Antenna Gain(dB) | Peak EIRP (dBm) | Limit (dBm) | Margin (dB) | Polarization |
|-----------------|------------------------|----------------------|----------|---------------------------------|-----------------|-------------|-------------|--------------|
| 3815.2 | -43.32 | 5.36 | 3.00 | 9.62 | -39.06 | -13.00 | -26.06 | H |
| 5722.8 | -51.42 | 6.24 | 3.00 | 11.46 | -46.20 | -13.00 | -33.20 | H |
| 3815.2 | -46.46 | 5.36 | 3.00 | 9.62 | -42.20 | -13.00 | -29.20 | V |
| 5722.8 | -53.94 | 6.24 | 3.00 | 11.46 | -48.72 | -13.00 | -35.72 | V |

UMTS/TM1/ WCDMA Band V _ Low Channel

| Frequency (MHz) | P _{Mea} (dBm) | P _{cl} (dB) | Diatance | G _a Antenna Gain(dB) | Peak EIRP (dBm) | Limit (dBm) | Margin (dB) | Polarization |
|-----------------|------------------------|----------------------|----------|---------------------------------|-----------------|-------------|-------------|--------------|
| 1652.8 | -47.83 | 3.86 | 3.00 | 8.56 | -43.13 | -13.00 | -30.13 | H |
| 2479.2 | -49.45 | 4.29 | 3.00 | 6.98 | -46.76 | -13.00 | -33.76 | H |
| 1652.8 | -44.29 | 3.86 | 3.00 | 8.56 | -39.59 | -13.00 | -26.59 | V |
| 2479.2 | -44.57 | 4.29 | 3.00 | 6.98 | -41.88 | -13.00 | -28.88 | V |



Shenzhen LCS Compliance Testing Laboratory Ltd.

Add: 101, 201 Bldg A & 301 Bldg C, Juji Industrial Park Yabianxueziwei, Shajing Street, Baoan District, Shenzhen, 518000, China

Tel: +(86) 0755-82591330 | E-mail: webmaster@lcs-cert.com | Web: www.lcs-cert.com

Scan code to check authenticity

*UMTS/TM1/ WCDMA Band V _ Middle Channel*

| Frequency (MHz) | P _{Mea} (dBm) | P _{cl} (dB) | Diatance | G _a Antenna Gain(dB) | Peak EIRP (dBm) | Limit (dBm) | Margin (dB) | Polarization |
|-----------------|------------------------|----------------------|----------|---------------------------------|-----------------|-------------|-------------|--------------|
| 1672.8 | -49.31 | 3.9 | 3.00 | 8.58 | -44.63 | -13.00 | -31.63 | H |
| 2509.2 | -51.26 | 4.32 | 3.00 | 6.8 | -48.78 | -13.00 | -35.78 | H |
| 1672.8 | -45.14 | 3.9 | 3.00 | 8.58 | -40.46 | -13.00 | -27.46 | V |
| 2509.2 | -45.40 | 4.32 | 3.00 | 6.8 | -42.92 | -13.00 | -29.92 | V |

UMTS/TM1/ WCDMA Band V _ High Channel

| Frequency (MHz) | P _{Mea} (dBm) | P _{cl} (dB) | Diatance | G _a Antenna Gain(dB) | Peak EIRP (dBm) | Limit (dBm) | Margin (dB) | Polarization |
|-----------------|------------------------|----------------------|----------|---------------------------------|-----------------|-------------|-------------|--------------|
| 1693.2 | -52.05 | 3.91 | 3.00 | 9.06 | -46.90 | -13.00 | -33.90 | H |
| 2539.8 | -54.81 | 4.32 | 3.00 | 6.65 | -52.48 | -13.00 | -39.48 | H |
| 1693.2 | -49.59 | 3.91 | 3.00 | 9.06 | -44.44 | -13.00 | -31.44 | V |
| 2539.8 | -50.90 | 4.32 | 3.00 | 6.65 | -48.57 | -13.00 | -35.57 | V |

UMTS/TM1/ WCDMA Band IV _ Low Channel

| Frequency (MHz) | P _{Mea} (dBm) | P _{cl} (dB) | Diatance | G _a Antenna Gain(dB) | Peak EIRP (dBm) | Limit (dBm) | Margin (dB) | Polarization |
|-----------------|------------------------|----------------------|----------|---------------------------------|-----------------|-------------|-------------|--------------|
| 3424.8 | -46.06 | 4.62 | 3.00 | 9.81 | -40.87 | -13.00 | -27.87 | H |
| 5137.2 | -50.27 | 5.94 | 3.00 | 10.86 | -45.35 | -13.00 | -32.35 | H |
| 3424.8 | -48.63 | 4.62 | 3.00 | 9.81 | -43.44 | -13.00 | -30.44 | V |
| 5137.2 | -53.63 | 5.94 | 3.00 | 10.86 | -48.71 | -13.00 | -35.71 | V |

UMTS/TM1/ WCDMA Band IV _ Middle Channel

| Frequency (MHz) | P _{Mea} (dBm) | P _{cl} (dB) | Diatance | G _a Antenna Gain(dB) | Peak EIRP (dBm) | Limit (dBm) | Margin (dB) | Polarization |
|-----------------|------------------------|----------------------|----------|---------------------------------|-----------------|-------------|-------------|--------------|
| 3465.2 | -41.11 | 4.63 | 3.00 | 9.84 | -35.90 | -13.00 | -22.90 | H |
| 5197.8 | -46.23 | 5.94 | 3.00 | 10.86 | -41.31 | -13.00 | -28.31 | H |
| 3465.2 | -44.36 | 4.63 | 3.00 | 9.84 | -39.15 | -13.00 | -26.15 | V |
| 5197.8 | -49.31 | 5.94 | 3.00 | 10.86 | -44.39 | -13.00 | -31.39 | V |

UMTS/TM1/ WCDMA Band IV _ High Channel

| Frequency (MHz) | P _{Mea} (dBm) | P _{cl} (dB) | Diatance | G _a Antenna Gain(dB) | Peak EIRP (dBm) | Limit (dBm) | Margin (dB) | Polarization |
|-----------------|------------------------|----------------------|----------|---------------------------------|-----------------|-------------|-------------|--------------|
| 3505.2 | -48.42 | 4.65 | 3.00 | 9.9 | -43.17 | -13.00 | -30.17 | H |
| 5257.8 | -51.35 | 5.95 | 3.00 | 10.91 | -46.39 | -13.00 | -33.39 | H |
| 3505.2 | -50.54 | 4.65 | 3.00 | 9.9 | -45.29 | -13.00 | -32.29 | V |
| 5257.8 | -53.63 | 5.95 | 3.00 | 10.91 | -48.67 | -13.00 | -35.67 | V |



Shenzhen LCS Compliance Testing Laboratory Ltd.

Add: 101, 201 Bldg A & 301 Bldg C, Juji Industrial Park Yabianxueziwei, Shajing Street, Baoan District, Shenzhen, 518000, China

Tel: +(86) 0755-82591330 | E-mail: webmaster@lcs-cert.com | Web: www.lcs-cert.com

Scan code to check authenticity



4.3 Occupied Bandwidth and Emission Bandwidth

TEST APPLICABLE

Similar to conducted emissions; occupied bandwidth measurements are only provided for selected frequencies in order to reduce the amount of submitted data. The table below lists the measured 99% Bandwidth and -26dBc Bandwidth.

TEST CONFIGURATION

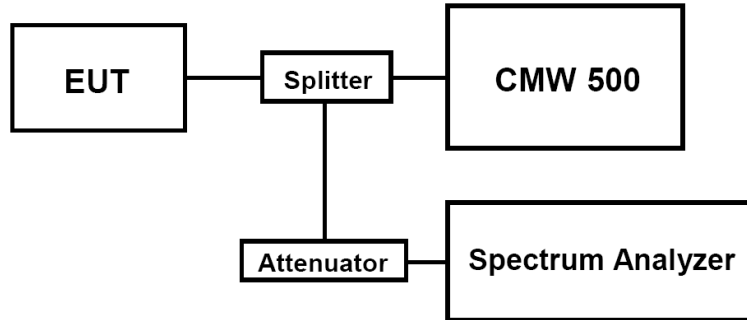

TEST PROCEDURE

1. The EUT was set up for the max output power with pseudo random data modulation;
2. The Occupied bandwidth and Emission Bandwidth were measured with Aglient Spectrum Analyzer N9020A (peak);
3. Set RBW=100KHz,VBW=300KHz,Span=10MHz,SWT=Auto;
4. Set SPA Max hold and View, Set 99% Occupied Bandwidth/ Set -26dBc Occupied Bandwidth
5. These measurements were done at 3 frequencies for WCDMA band II/IV/V. (low, middle and high of operational frequency range).

TEST RESULTS

| Test Mode | Channel | Frequency (MHz) | Occupied Bandwidth (99% BW) (MHz) | Emission Bandwidth (-26 dBc BW) (MHz) | Verdict |
|----------------------------|---------|-----------------|-----------------------------------|---------------------------------------|---------|
| UMTS/TM1/ WCDMA Band II | 9262 | 1852.4 | 4.1684 | 4.710 | PASS |
| | 9400 | 1880.0 | 4.1743 | 4.716 | PASS |
| | 9538 | 1907.6 | 4.1645 | 4.727 | PASS |
| UMTS/TM1/ WCDMA Band V | 4132 | 826.4 | 4.1679 | 4.715 | PASS |
| | 4182 | 836.4 | 4.1691 | 4.716 | PASS |
| | 4233 | 846.6 | 4.1771 | 4.703 | PASS |
| UMTS/TM1/ WCDMA Band IV | 1312 | 1712.4 | 4.1665 | 4.702 | PASS |
| | 1413 | 1732.6 | 4.1606 | 4.702 | PASS |
| | 1513 | 1752.6 | 4.1713 | 4.721 | PASS |

Remark:

1. Test results including cable loss;
2. Please refer to following plots;





Occupied Bandwidth and Emission Bandwidth

UMTS/TM1/ WCDMA Band II

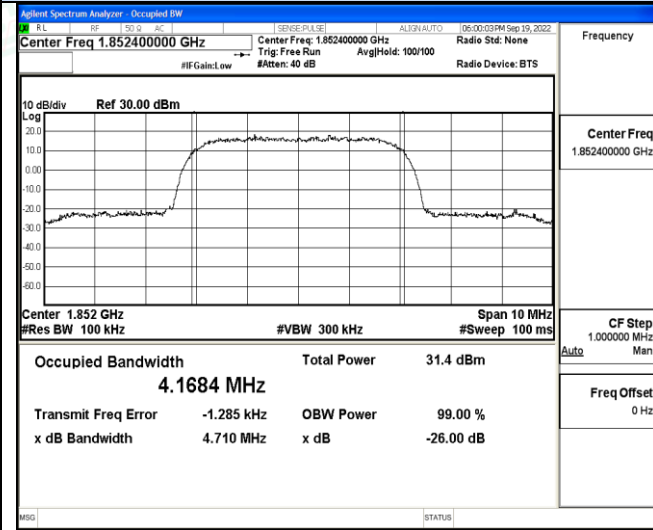

UMTS/TM1/ WCDMA Band V

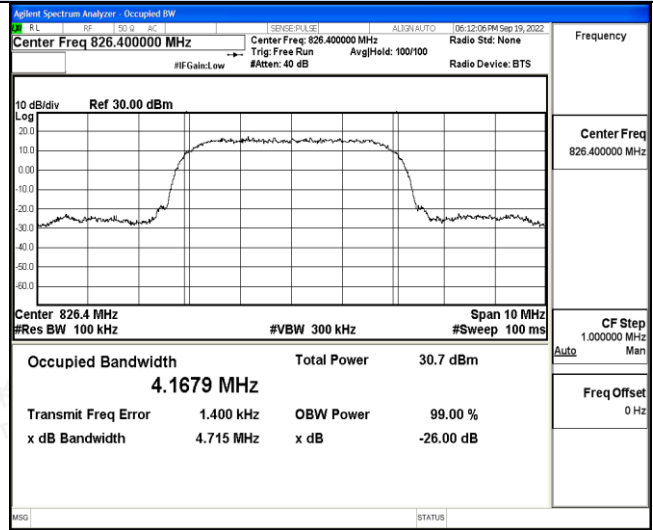

Channel 9262 / 1852.4 MHz

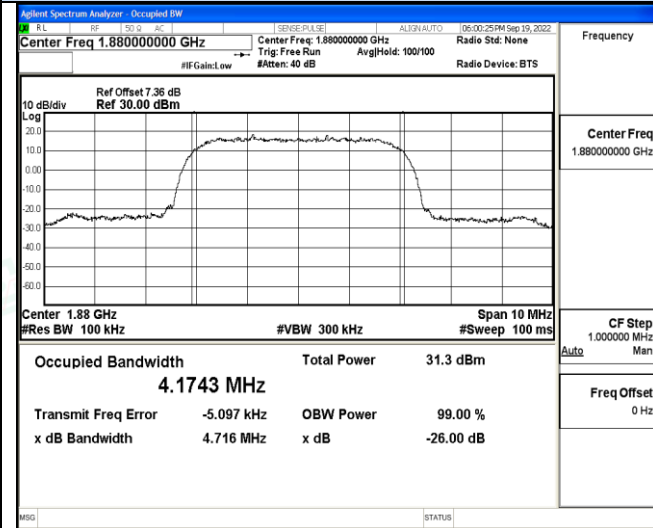

Channel 4132 / 826.4 MHz

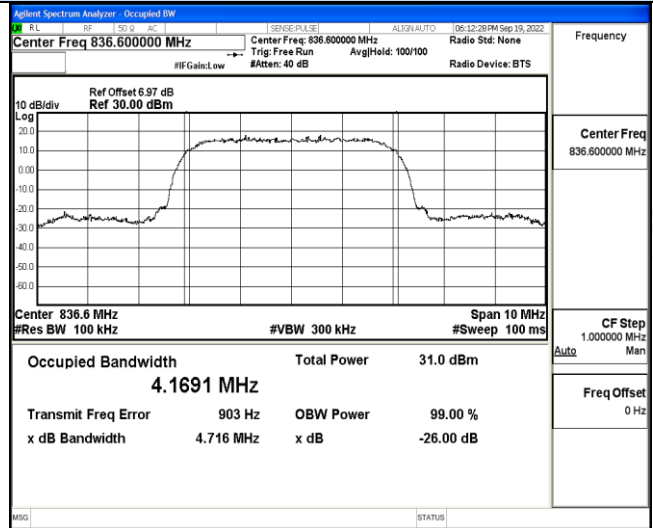

Channel 9400 / 1880.0 MHz

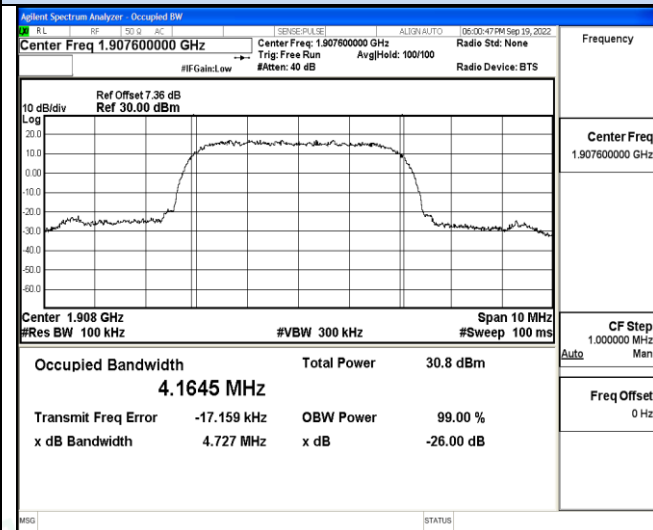

Channel 4182 / 836.4 MHz

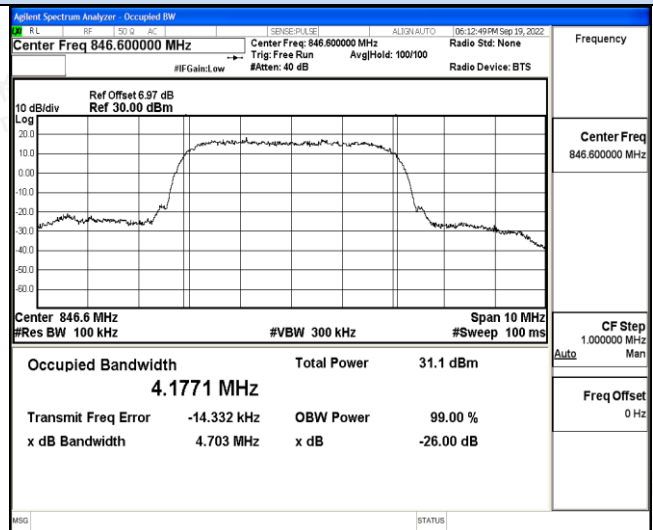

Channel 9538 / 1907.6 MHz

Channel 4233 / 846.6 MHz



Shenzhen LCS Compliance Testing Laboratory Ltd.

Add: 101, 201 Bldg A & 301 Bldg C, Juji Industrial Park Yabianxueziwei, Shajing Street, Baoan District, Shenzhen, 518000, China

Tel: +(86) 0755-82591330 | E-mail: webmaster@lcs-cert.com | Web: www.lcs-cert.com

Scan code to check authenticity



Occupied Bandwidth and Emission Bandwidth

UMTS/TM1/ WCDMA Band IV

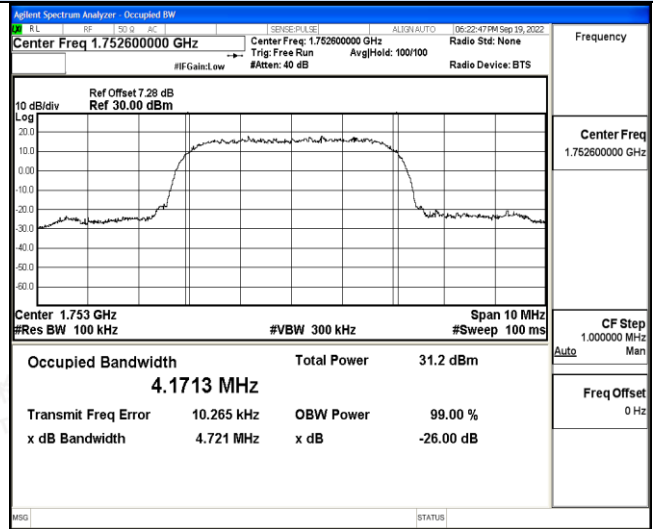
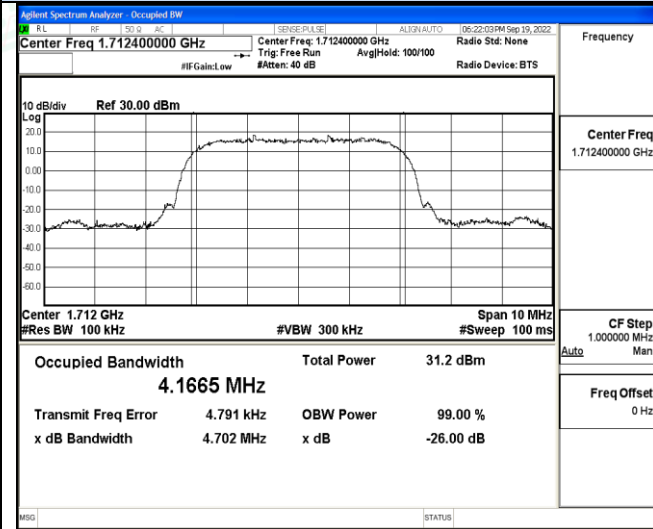

Channel 1312 / 1712.4 MHz

Channel 1513 / 1752.6 MHz

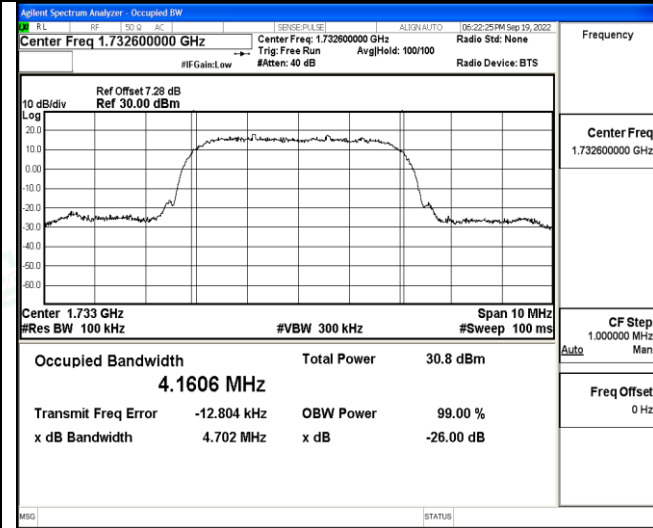

Channel 1413 / 1732.6 MHz





4.4 Band Edge Compliance

TEST APPLICABLE

During the process of testing, the EUT was controlled via R&S WIDEBAND RADIO COMMUNICATION TESTER (CMW 500) to ensure max power transmission and proper modulation.

TEST CONFIGURATION

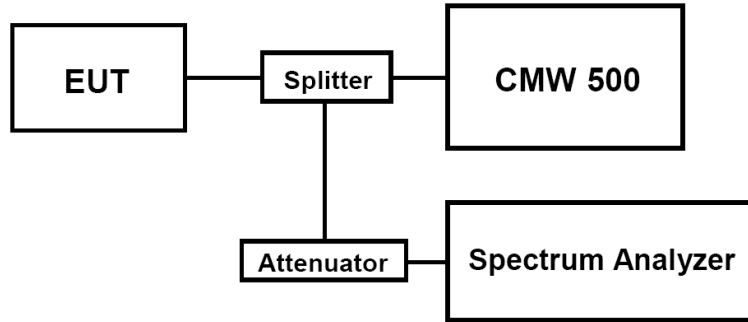

TEST PROCEDURE

1. The EUT was set up for the max output power with pseudo random data modulation;
 2. The power was measured with Spectrum Analyzer N9020A;
 3. Set RBW=100KHz,VBW=300KHz,Span=2MHz,SWT=Auto,Dector: RMS;
- These measurements were done at 2 frequencies for WCDMA band II/IV/V. (low and high of operational frequency range).

TEST RESULTS

| UMTS/TM1/WCDMA Band II | | | | | |
|------------------------|---------|-----------------|---------------------------|--------------|---------|
| Test Mode | Channel | Frequency (MHz) | Band Edg Compliance (dBm) | Limits (dBm) | Verdict |
| UMTS/TM1/WCDMA Band II | 9262 | 1852.4 | -21.24 | <-13dBm | PASS |
| | 9538 | 1907.6 | -22.96 | <-13dBm | |
| UMTS/TM1/WCDMA Band V | | | | | |
| Test Mode | Channel | Frequency (MHz) | Band Edg Compliance (dBm) | Limits (dBm) | Verdict |
| UMTS/TM1/WCDMA Band V | 4132 | 826.4 | -23.03 | <-13dBm | PASS |
| | 4233 | 846.6 | -23.12 | <-13dBm | |
| UMTS/TM1/WCDMA Band IV | | | | | |
| Test Mode | Channel | Frequency (MHz) | Band Edg Compliance (dBm) | Limits (dBm) | Verdict |
| UMTS/TM1/WCDMA Band IV | 1312 | 1712.4 | -23.52 | <-13dBm | PASS |
| | 1513 | 1752.6 | -21.20 | <-13dBm | |

Remark:

1. Test results including cable loss;
2. Please refer to following plots;





Band-edge Compliance

UMTS/TM1/WCDMA Band II

UMTS/TM1/WCDMA Band V

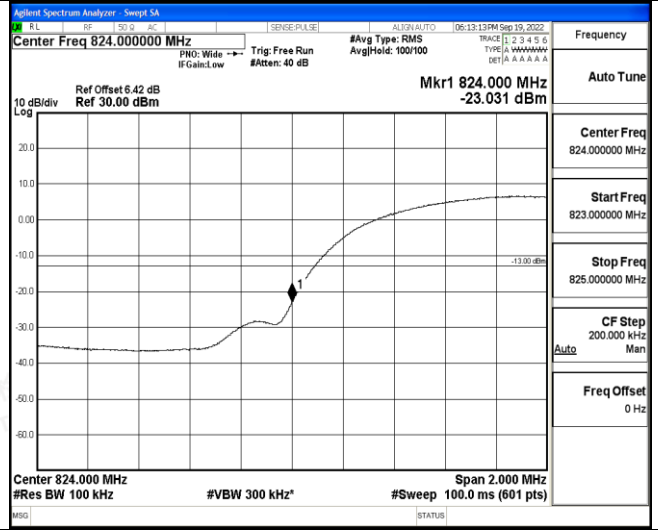
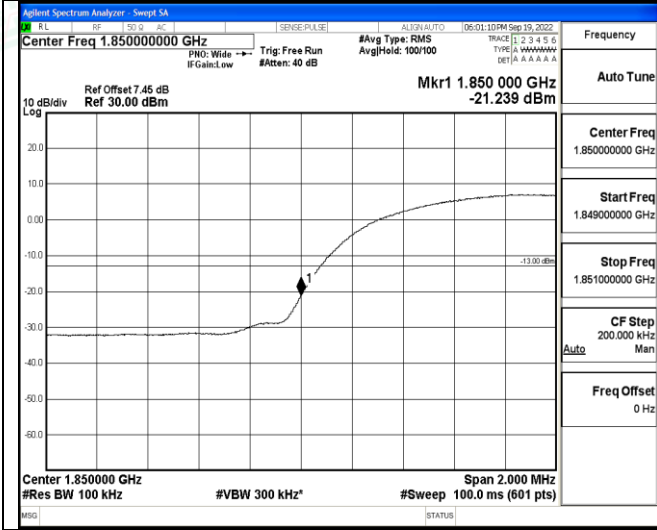

Channel 9262 / 1852.4 MHz

Channel 4132 / 826.4 MHz

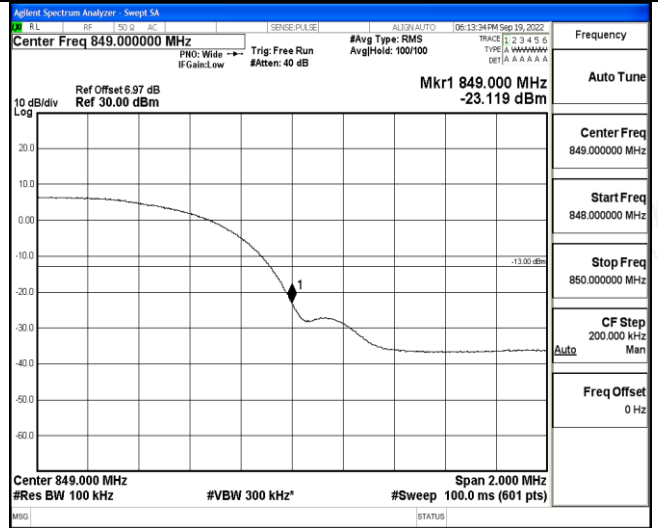
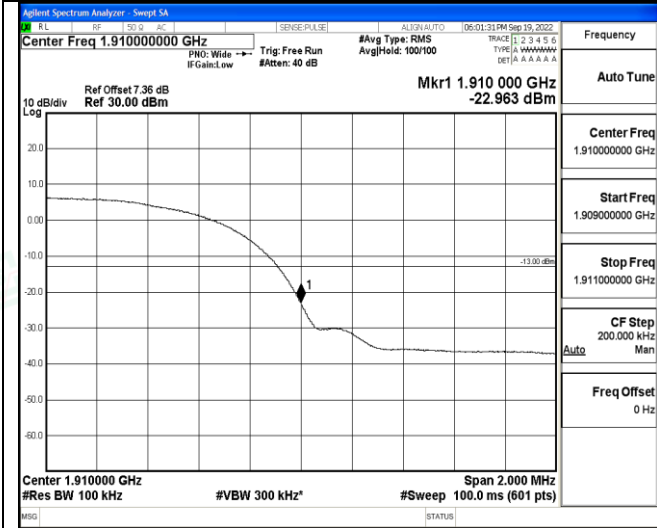

Channel 9538 / 1907.6 MHz

Channel 4233 / 846.6 MHz



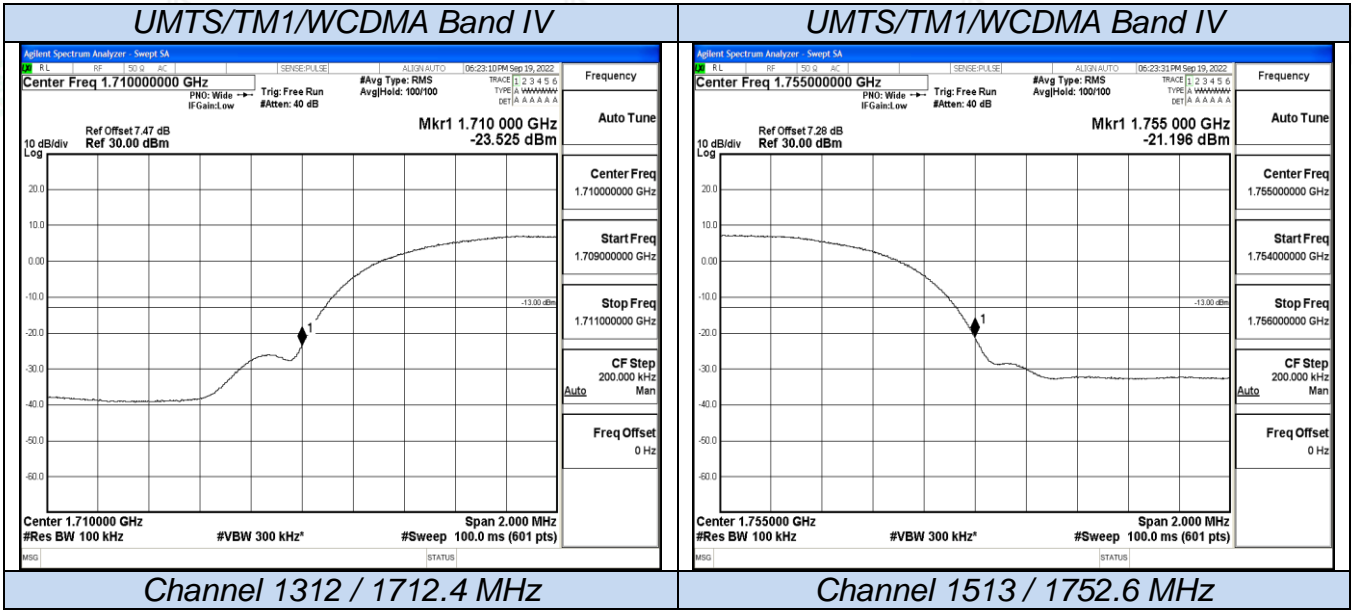

Shenzhen LCS Compliance Testing Laboratory Ltd.
 Add: 101, 201 Bldg A & 301 Bldg C, Juji Industrial Park Yabianxueziwei, Shajing Street, Baoan District, Shenzhen, 518000, China
 Tel: +(86) 0755-82591330 | E-mail: webmaster@lcs-cert.com | Web: www.lcs-cert.com
 Scan code to check authenticity



4.5 Spurious Emission on Antenna Port

TEST APPLICABLE

The following steps outline the procedure used to measure the conducted emissions from the EUT.

1. Determine frequency range for measurements: From CFR 2.1057 the spectrum should be investigated from the lowest radio frequency generated in the equipment up to at least the 10th harmonic of the carrier frequency. For the equipment of WCDMA band II, this equates to a frequency range of 9 KHz to 19GHz, data taken from 30 MHz to 19 GHz. For WCDMA Band V, this equates to a frequency range of 9 KHz to 9 GHz, data taken from 30 MHz to 9 GHz. For WCDMA Band IV, this equates to a frequency range of 9 KHz to 18 GHz, data taken from 30 MHz to 18GHz.
2. The sweep time is set automatically by instrument itself. That should be the optimal sweep time for the span and the RBW. If the sweep time is too short, that is sweep is too fast, the sweep result is not accurate; if the sweep time is too long, that is sweep is too low, some frequency components may be lost. The instrument will give an optimal sweep time according to the selected span and RBW.
3. The procedure to get the conducted spurious emission is as follows:
The trace mode is set to MaxHold to get the highest signal at each frequency;
Wait 25 seconds;
Get the result.
4. Determine EUT transmit frequencies: below outlines the band edge frequencies pertinent to conducted emissions testing.

TEST CONFIGURATION

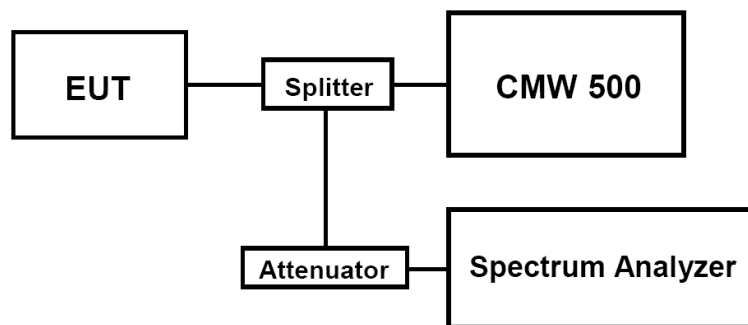

TEST PROCEDURE

1. The EUT was set up for the max output power with pseudo random data modulation;
2. The power was measured with Spectrum Analyzer N9020A;
3. These measurements were done at 3 frequencies for WCDMA band II/IV/V. (low, middle and high of operational frequency range).

TEST LIMIT

Part 24.238, Part 22.917, Part 27.53, specify that the power of any emission outside of the authorized operating frequency ranges must be attenuated below the transmitting power (P) by a factor of at least $43 + 10 \log(P)$ dB. The specification that emissions shall be attenuated below the transmitter power (P) by at least $43 + 10 \log(P)$ dB, translates in the relevant power range (1 to 0.001 W) to -13 dBm. At 1 W the specified minimum attenuation becomes 43 dB and relative to a 30 dBm (1 W) carrier becomes a limit of -13 dBm. At 0.001 W (0 dBm) the minimum attenuation is 13 dB, which again yields a limit of -13 dBm. In this way a translation of the specification from relative to absolute terms is carried out.



**TEST RESULTS**

| Test Mode | Channel | Frequency (MHz) | Spurious RF Conducted Emission (dBm) | Limits (dBm) | Verdict |
|---------------------------|---------|-----------------|--------------------------------------|--------------|---------|
| UMTS/TM1/WCDMA Band II | 9262 | 1852.4 | <-13dBm | -13dBm | PASS |
| | 9400 | 1880.0 | <-13dBm | -13dBm | |
| | 9538 | 1907.6 | <-13dBm | -13dBm | |
| UMTS/TM1/WCDMA Band V | 4132 | 826.4 | <-13dBm | -13dBm | PASS |
| | 4182 | 836.4 | <-13dBm | -13dBm | |
| | 4233 | 846.6 | <-13dBm | -13dBm | |
| UMTS/TM1/WCDMA Band IV | 1312 | 1712.4 | <-13dBm | -13dBm | PASS |
| | 1413 | 1732.6 | <-13dBm | -13dBm | |
| | 1513 | 1752.6 | <-13dBm | -13dBm | |

Remark:

1. Test results including cable loss;
2. Please refer to following plots;
3. Not reorded test plots from 9 KHz to 30 MHz as emission levels 20dB lower than emission limit;



Shenzhen LCS Compliance Testing Laboratory Ltd.

Add: 101, 201 Bldg A & 301 Bldg C, Juji Industrial Park Yabianxueziwei, Shajing Street, Baoan District, Shenzhen, 518000, China

Tel: +(86) 0755-82591330 | E-mail: webmaster@lcs-cert.com | Web: www.lcs-cert.com

Scan code to check authenticity



Spurious Emission on Antenna Port
UMTS/TM1/WCDMA Band II
Channel 9262 / 1852.4 MHz

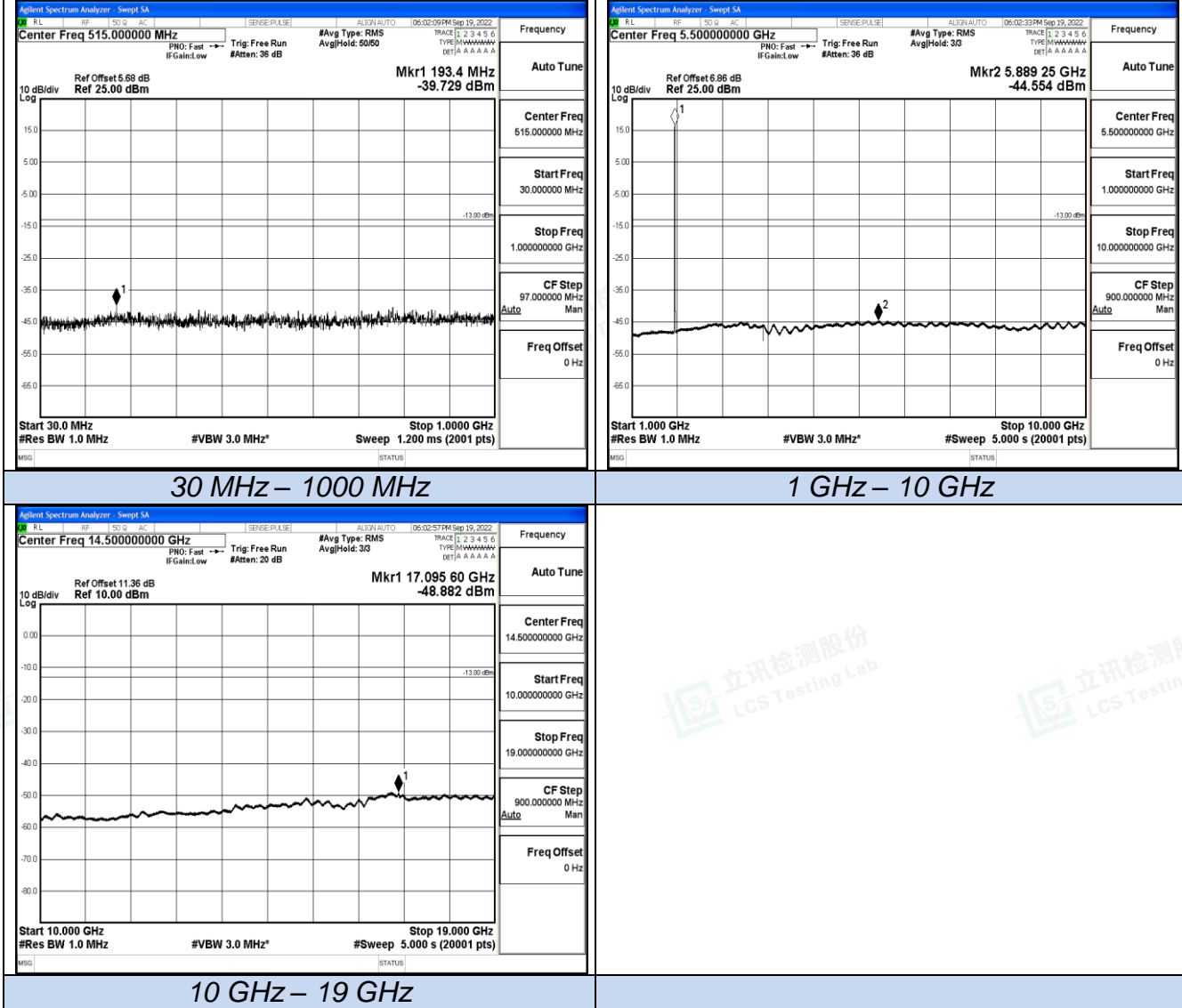

30 MHz – 1000 MHz

1 GHz – 10 GHz

10 GHz – 19 GHz





Spurious Emission on Antenna Port
UMTS/TM1/WCDMA Band II
Channel 9400 / 1880 MHz

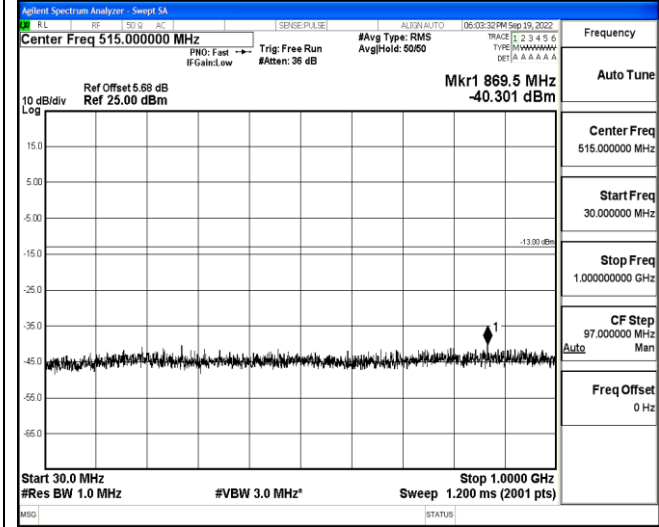

30 MHz – 1000 MHz

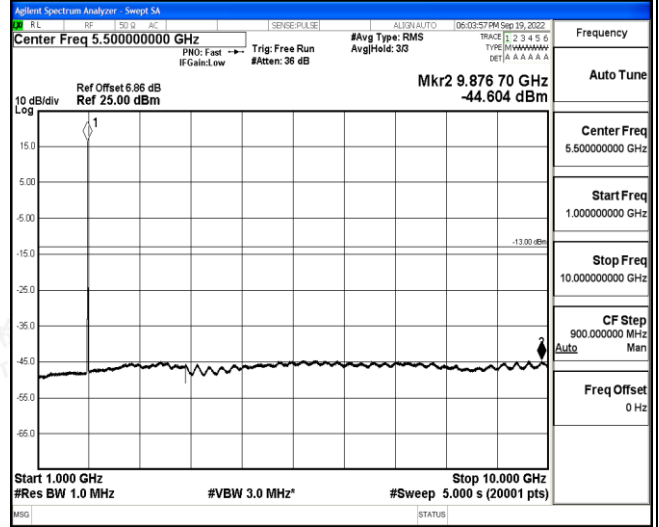

1 GHz – 10 GHz

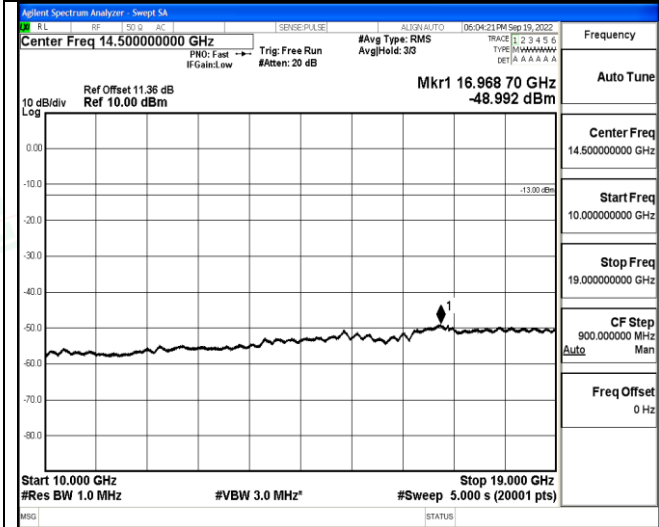

10 GHz – 19 GHz





Spurious Emission on Antenna Port
UMTS/TM1/WCDMA Band II
Channel 9538 / 1907.6 MHz

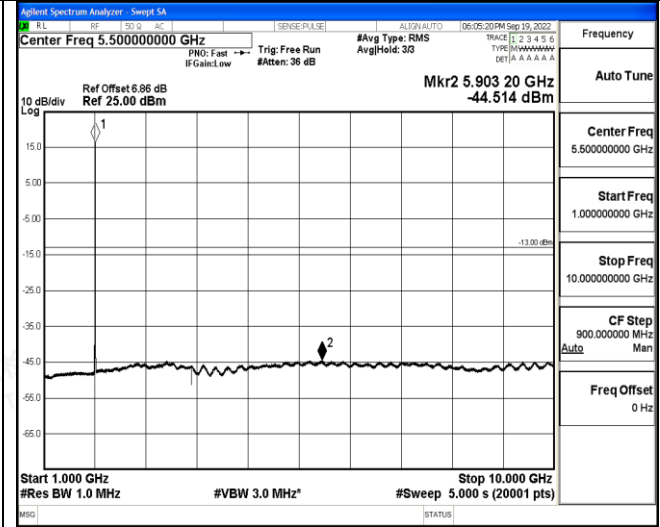
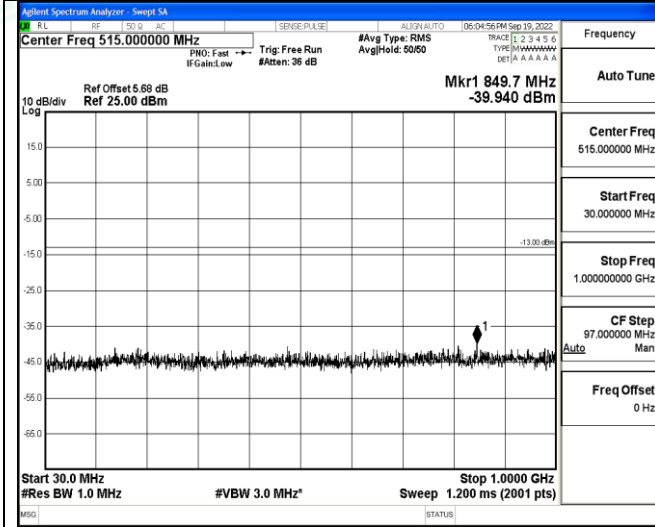

30 MHz – 1000 MHz

1 GHz – 10 GHz

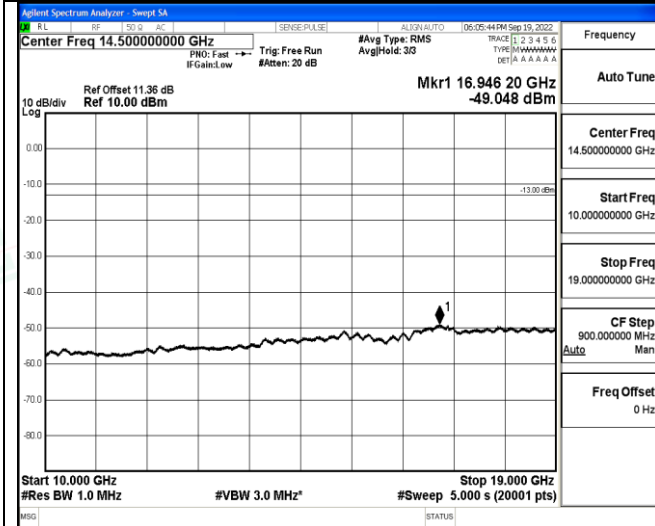

10 GHz – 19 GHz





Spurious Emission on Antenna Port

UMTS/TM1/WCDMA Band V

Channel 4132 / 826.4 MHz

Channel 4182 / 836.4 MHz

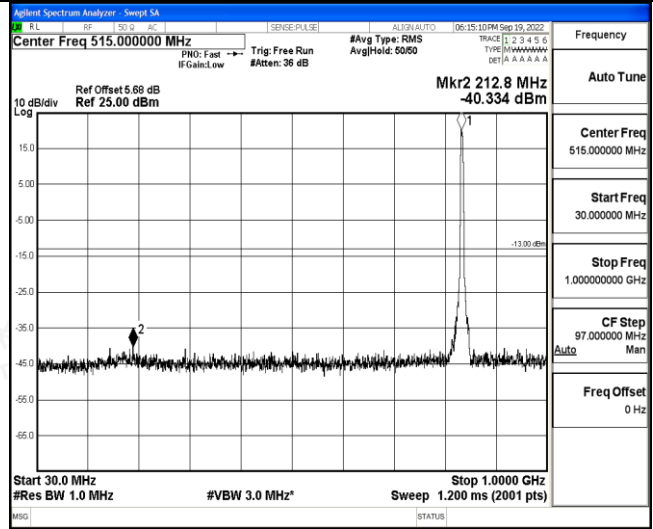
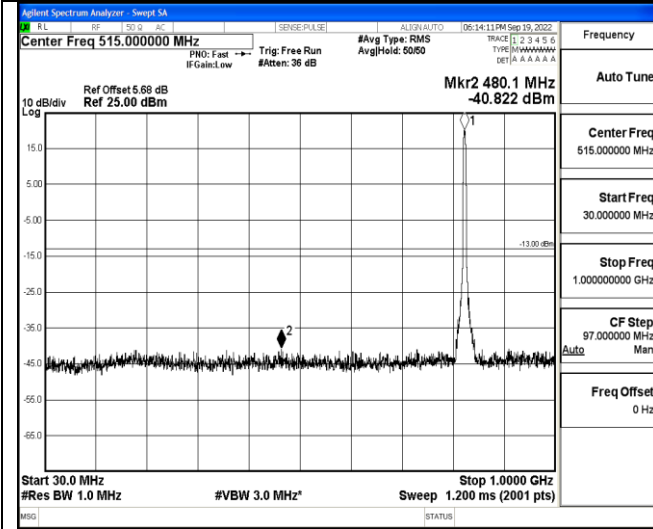

30 MHz – 1000 MHz

30 MHz – 1000 MHz

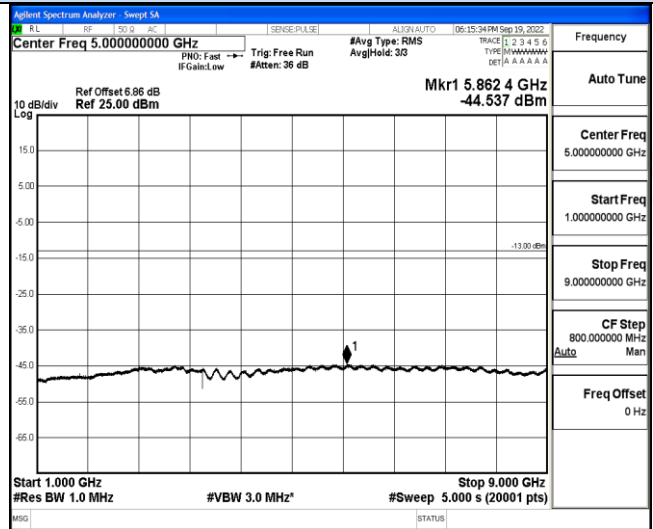
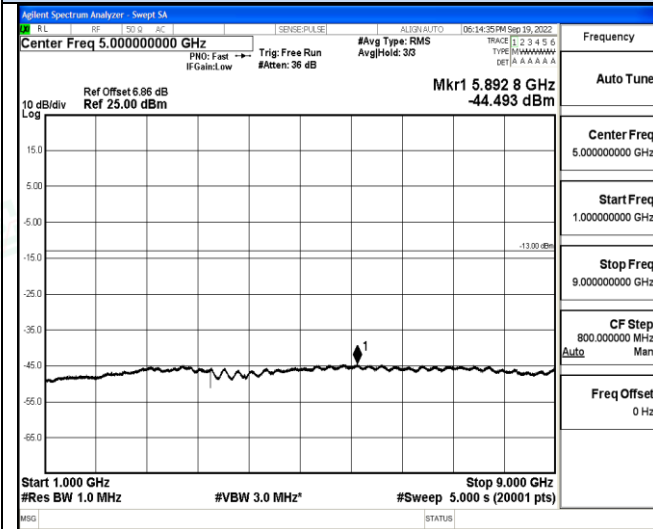

1 GHz – 9 GHz

1 GHz – 9 GHz





Spurious Emission on Antenna Port UMTS/TM1/WCDMA Band V

Channel 4233 / 846.6 MHz

Channel 4233 / 846.6 MHz

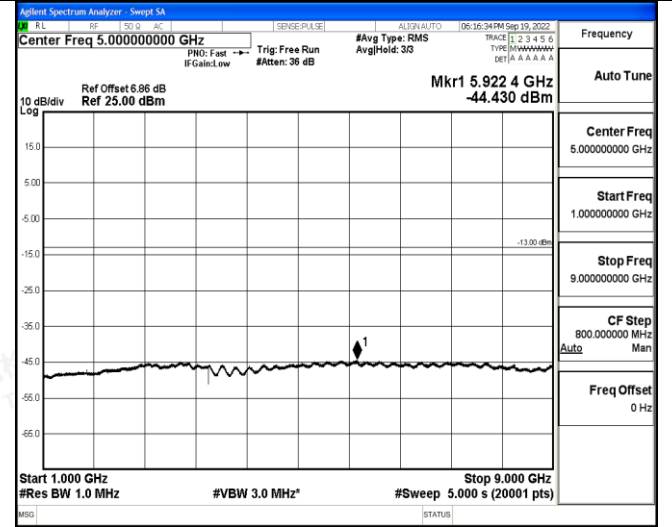
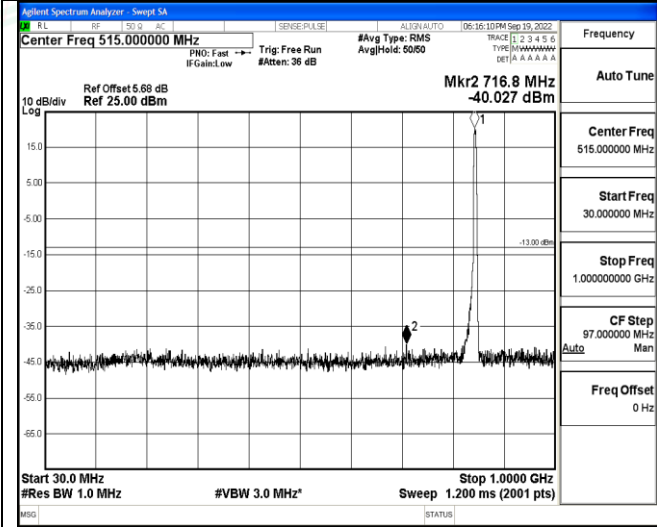

30 MHz – 1000 MHz

1 GHz – 9 GHz





Spurious Emission on Antenna Port
UMTS/TM1/WCDMA Band IV
Channel 1312 / 1712.4 MHz

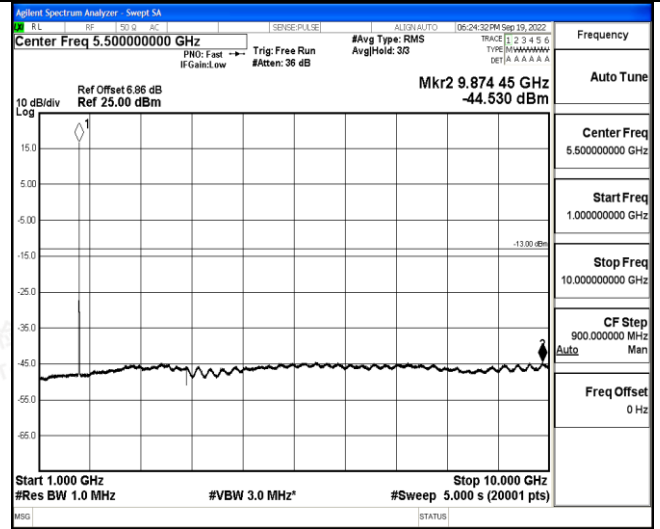
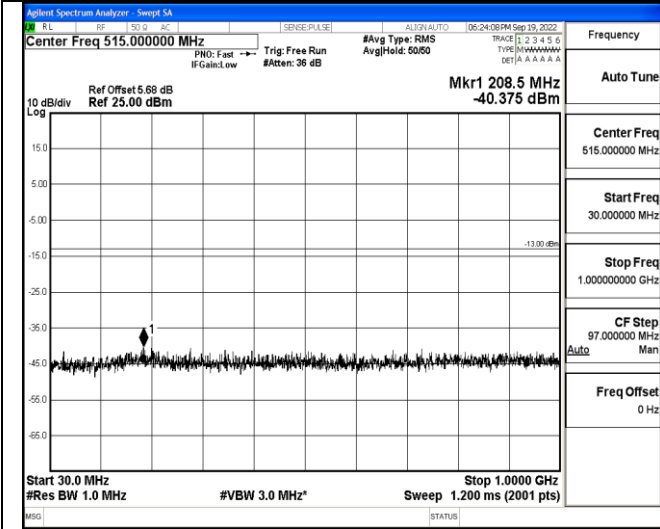

30 MHz – 1000 MHz

1 GHz – 10 GHz

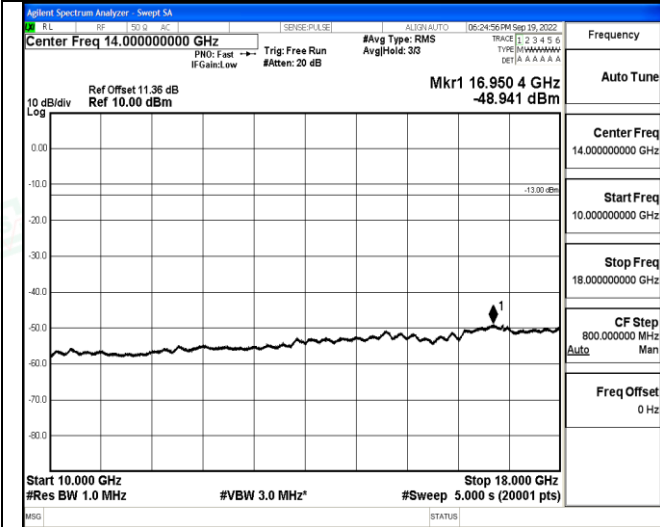

10 GHz – 18 GHz





Spurious Emission on Antenna Port UMTS/TM1/WCDMA Band IV Channel 1413 / 1732.6 MHz

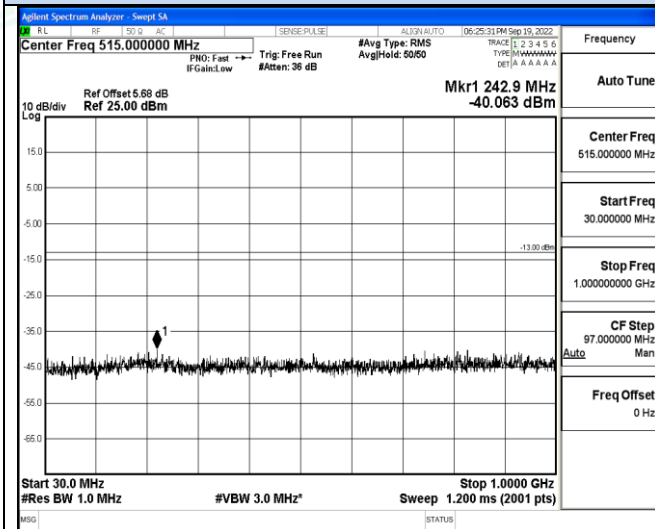

30 MHz – 1000 MHz

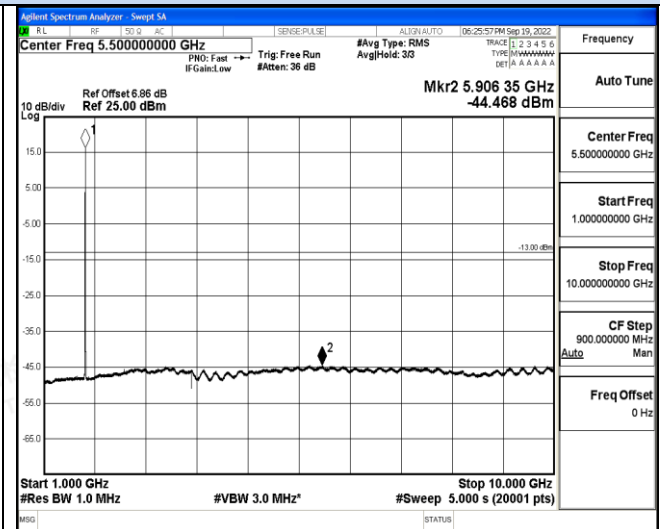

1 GHz – 10 GHz

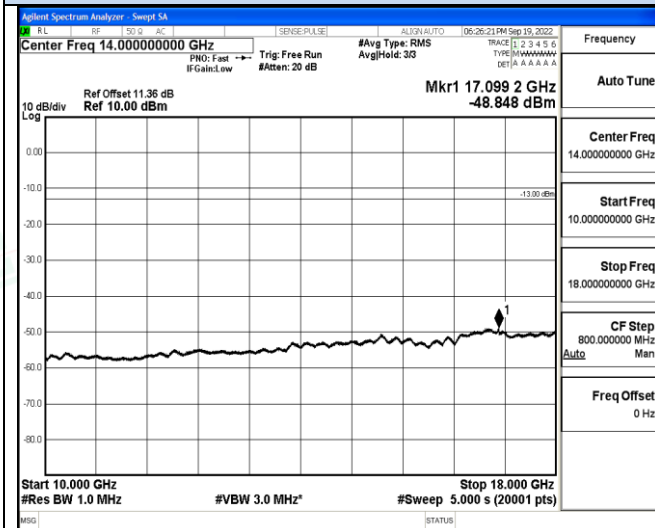

10 GHz – 18 GHz





Spurious Emission on Antenna Port
UMTS/TM1/WCDMA Band IV
Channel 1513 / 1752.6 MHz

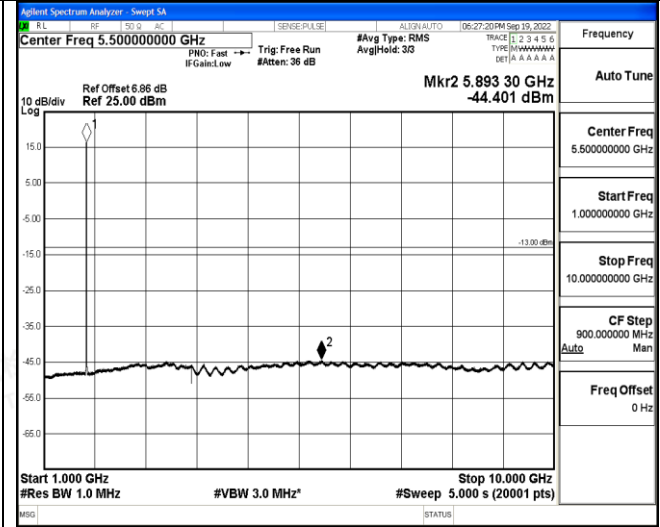
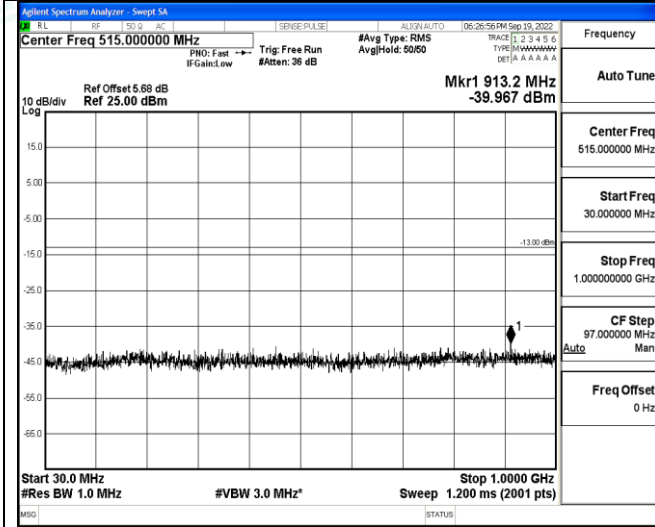

30 MHz – 1000 MHz

1 GHz – 10 GHz

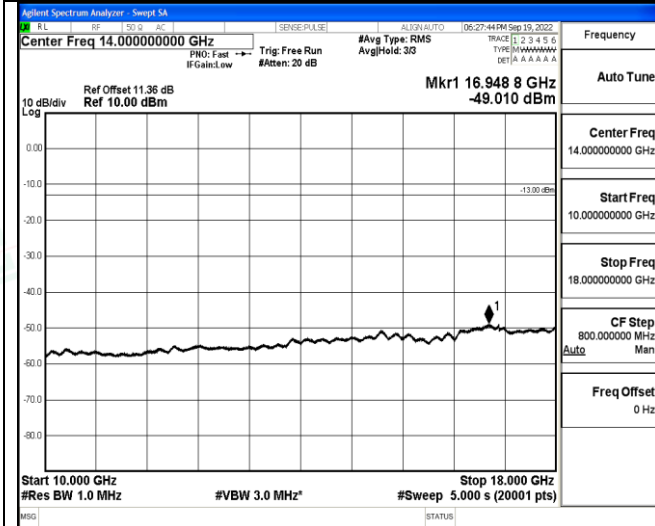

1 GHz – 18 GHz





4.6 Frequency Stability Test

TEST APPLICABLE

1. According to FCC Part 2 Section 2.1055 (a)(1), the frequency stability shall be measured with variation of ambient temperature from -30°C to $+50^{\circ}\text{C}$ centigrade.
2. According to FCC Part 2 Section 2.1055 (e)(2), for battery powered equipment, the frequency stability shall be measured with reducing primary supply voltage to the battery operating end point, which is specified by the manufacture.
3. Vary primary supply voltage from 85 to 115 percent of the nominal value for other than hand carried voltage equipment and the end voltage point was 3.3V.

TEST PROCEDURE

In order to measure the carrier frequency under the condition of AFC lock, it is necessary to make measurements with the EUT in a "call mode". This is accomplished with the use of R&S WIDEBAND RADIO COMMUNICATION TESTER (CMW 500).

1. Measure the carrier frequency at room temperature;
2. Subject the EUT to overnight soak at -30°C ;
3. With the EUT, powered via nominal voltage, connected to the CMW 500 and in a simulated call on middle channel of WCDMA band II/IV/V, measure the carrier frequency. These measurements should be made within 2 minutes of Powering up the EUT, to prevent significant self-warming;
4. Repeat the above measurements at 10°C increments from -30°C to $+50^{\circ}\text{C}$. Allow at least 0.5 hours at each temperature, unpowered, before making measurements;
5. Remeasure carrier frequency at room temperature with nominal voltage. Vary supply voltage from minimum voltage to maximum voltage, in 0.1Volt increments remeasuring carrier frequency at each voltage. Pause at nominal voltage for 0.5 hours unpowered, to allow any self-heating to stabilize, before continuing;
6. Subject the EUT to overnight soak at $+50^{\circ}\text{C}$;
7. With the EUT, powered via nominal voltage, connected to the CMW 500 and in a simulated call on the centre channel, measure the carrier frequency. These measurements should be made within 2 minutes of Powering up the EUT, to prevent significant self-warming;
8. Repeat the above measurements at 10°C increments from $+50^{\circ}\text{C}$ to -30°C . Allow at least 0.5 hours at each temperature, unpowered, before making measurements;
9. At all temperature levels hold the temperature to $\pm 0.5^{\circ}\text{C}$ during the measurement procedure;

TEST CONFIGURATION

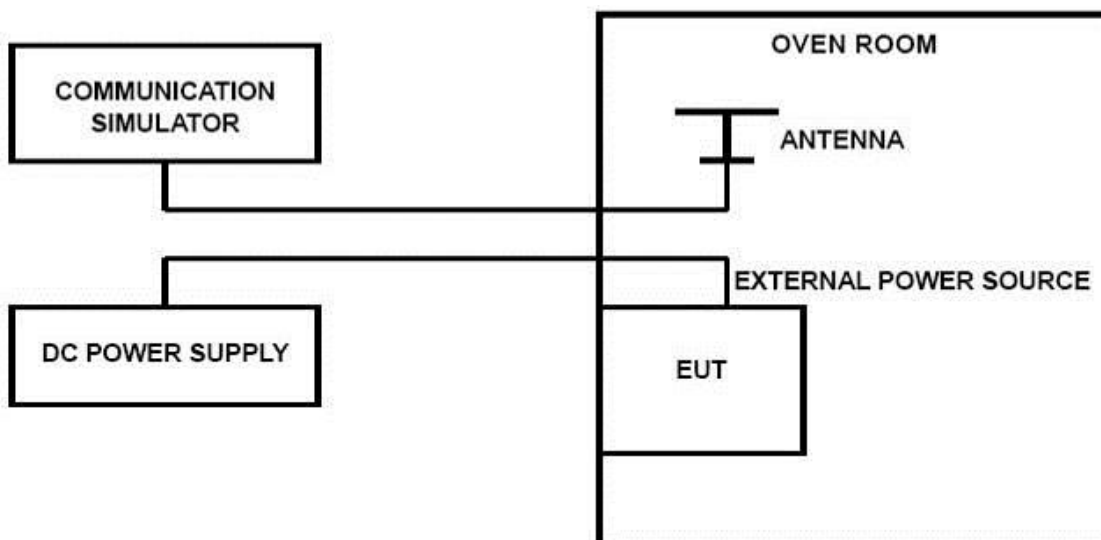

**TEST LIMITS****For Hand carried battery powered equipment**

According to the JTC standard the frequency stability of the carrier shall be accurate to within 0.1 ppm of the received frequency from the base station. This accuracy is sufficient to meet Sec. 24.235, Frequency Stability. The frequency stability shall be sufficient to ensure that the fundamental emission stays within the authorized frequency block. As this transceiver is considered "Hand carried, battery powered equipment" Section 2.1055(d)(2) applies. This requires that the lower voltage for frequency stability testing be specified by the manufacturer. This transceiver is specified to operate with an input voltage of between 3.40VDC and 4.30VDC, with a nominal voltage of 3.80DC. Operation above or below these voltage limits is prohibited by transceiver software in order to prevent improper operation as well as to protect components from overstress. These voltages represent a tolerance of -10 % and +12.5 %. For the purposes of measuring frequency stability these voltage limits are to be used.

For equipment powered by primary supply voltage

According to the JTC standard the frequency stability of the carrier shall be accurate to within 0.1 ppm of the received frequency from the base station. This accuracy is sufficient to meet Sec. 24.235, Frequency Stability. The frequency stability shall be sufficient to ensure that the fundamental emission stays within the authorized frequency block. For this EUT section 2.1055(d)(1) applies. This requires varying primary supply voltage from 85 to 115 percent of the nominal value for other than hand carried battery equipment.

TEST RESULTS

| UMTS/TM1/WCDMA Band II | | | | | |
|------------------------|------------------|---------------------|----------------------|-------------|---------|
| DC Power | Temperature (°C) | Frequency error(Hz) | Frequency error(ppm) | Limit (ppm) | Verdict |
| 6.2 | 25 | -8 | -0.004 | 2.50 | PASS |
| 7.2 | 25 | -21 | -0.011 | 2.50 | PASS |
| 8.4 | 25 | -21 | -0.011 | 2.50 | PASS |
| 7.2 | -30 | 17 | 0.009 | 2.50 | PASS |
| 7.2 | -20 | 28 | 0.015 | 2.50 | PASS |
| 7.2 | -10 | 10 | 0.005 | 2.50 | PASS |
| 7.2 | 0 | -29 | -0.015 | 2.50 | PASS |
| 7.2 | 10 | 25 | 0.013 | 2.50 | PASS |
| 7.2 | 20 | 8 | 0.004 | 2.50 | PASS |
| 7.2 | 30 | -24 | -0.013 | 2.50 | PASS |
| 7.2 | 40 | 6 | 0.003 | 2.50 | PASS |
| 7.2 | 50 | -27 | -0.014 | 2.50 | PASS |

| UMTS/TM1/WCDMA Band V | | | | | |
|-----------------------|------------------|---------------------|----------------------|-------------|---------|
| DC Power | Temperature (°C) | Frequency error(Hz) | Frequency error(ppm) | Limit (ppm) | Verdict |
| 6.2 | 25 | 1 | 0.001 | 2.50 | PASS |
| 7.2 | 25 | -24 | -0.029 | 2.50 | PASS |
| 8.4 | 25 | -14 | -0.017 | 2.50 | PASS |
| 7.2 | -30 | 11 | 0.013 | 2.50 | PASS |
| 7.2 | -20 | -26 | -0.031 | 2.50 | PASS |
| 7.2 | -10 | 13 | 0.016 | 2.50 | PASS |
| 7.2 | 0 | 29 | 0.035 | 2.50 | PASS |
| 7.2 | 10 | -13 | -0.016 | 2.50 | PASS |
| 7.2 | 20 | 29 | 0.035 | 2.50 | PASS |
| 7.2 | 30 | -7 | -0.008 | 2.50 | PASS |
| 7.2 | 40 | 6 | 0.007 | 2.50 | PASS |
| 7.2 | 50 | -21 | -0.025 | 2.50 | PASS |



Shenzhen LCS Compliance Testing Laboratory Ltd.

Add: 101, 201 Bldg A & 301 Bldg C, Juji Industrial Park Yabianxueziwei, Shajing Street, Baoan District, Shenzhen, 518000, China

Tel: +(86) 0755-82591330 | E-mail: webmaster@lcs-cert.com | Web: www.lcs-cert.com

Scan code to check authenticity



| UMTS/TM1/WCDMA Band IV | | | | | |
|------------------------|------------------|---------------------|----------------------|-------------|---------|
| DC Power | Temperature (°C) | Frequency error(Hz) | Frequency error(ppm) | Limit (ppm) | Verdict |
| 6.2 | 25 | -3 | -0.002 | ±2.50 | PASS |
| 7.2 | 25 | -19 | -0.011 | ±2.50 | PASS |
| 8.4 | 25 | -17 | -0.010 | ±2.50 | PASS |
| 7.2 | -30 | 10 | 0.006 | ±2.50 | PASS |
| 7.2 | -20 | -18 | -0.010 | ±2.50 | PASS |
| 7.2 | -10 | 16 | 0.009 | ±2.50 | PASS |
| 7.2 | 0 | 13 | 0.008 | ±2.50 | PASS |
| 7.2 | 10 | 17 | 0.010 | ±2.50 | PASS |
| 7.2 | 20 | -15 | -0.009 | ±2.50 | PASS |
| 7.2 | 30 | -12 | -0.007 | ±2.50 | PASS |
| 7.2 | 40 | -8 | -0.005 | ±2.50 | PASS |
| 7.2 | 50 | -5 | -0.003 | ±2.50 | PASS |





4.7 Peak-to-Average Ratio (PAR)

LIMIT

The Peak-to-Average Ratio (PAR) of the transmission may not exceed 13 dB.

TEST CONFIGURATION

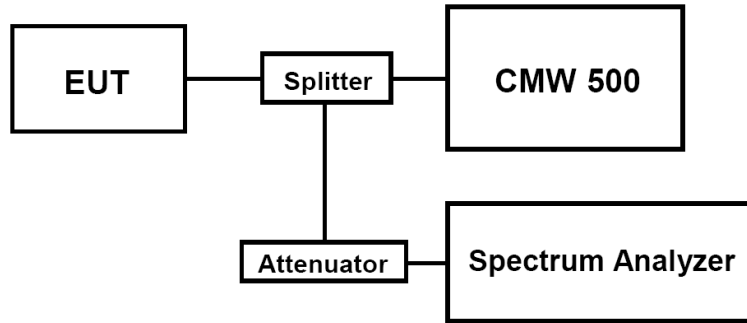

TEST PROCEDURE

1. Refer to instrument’s analyzer instruction manual for details on how to use the power statistics/CCDF function;
2. Set resolution/measurement bandwidth ≥ signal’s occupied bandwidth;
3. Set the number of counts to a value that stabilizes the measured CCDF curve;
4. Set the measurement interval as follows:
 - 1). for continuous transmissions, set to 1 ms,
 - 2). for burst transmissions, employ an external trigger that is synchronized with the EUT burst timing sequence, or use the internal burst trigger with a trigger level that allows the burst to stabilize and set the measurement interval to a time that is less than or equal to the burst duration.
5. Record the maximum PAPR level associated with a probability of 0.1%.

TEST RESULTS

| Test Mode | Channel | Frequency (MHz) | PAPR Value (dB) | Limits (dB) | Verdict |
|------------------------|---------|-----------------|-----------------|-------------|---------|
| UMTS/TM1/WCDMA Band II | 9262 | 1852.4 | 2.67 | 13.0 | PASS |
| | 9400 | 1880.0 | 2.77 | 13.0 | PASS |
| | 9538 | 1907.6 | 2.81 | 13.0 | PASS |
| UMTS/TM1/WCDMA Band V | 4132 | 826.4 | 2.99 | 13.0 | PASS |
| | 4182 | 836.4 | 2.94 | 13.0 | PASS |
| | 4233 | 846.6 | 3.04 | 13.0 | PASS |
| UMTS/TM1/WCDMA Band IV | 1312 | 1712.4 | 2.97 | 13.0 | PASS |
| | 1413 | 1732.6 | 2.9 | 13.0 | PASS |
| | 1513 | 1752.6 | 2.78 | 13.0 | PASS |

Remark:

1. Test results including cable loss;
2. Please refer to following plots;





Peak-to-Average Ratio (PAR)

UMTS/TM1/ WCDMA Band II

UMTS/TM1/ WCDMA Band V

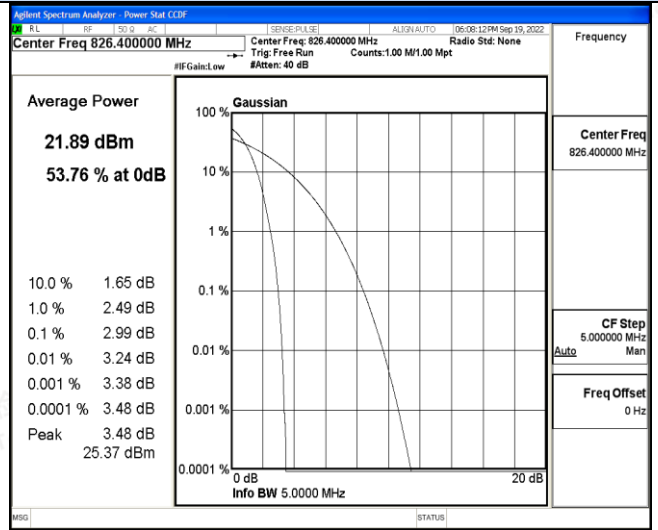
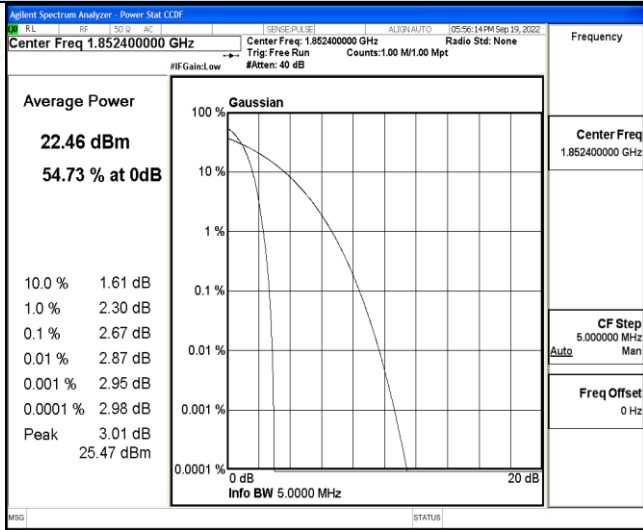

Channel 9262 / 1852.4 MHz

Channel 4132/ 826.4 MHz

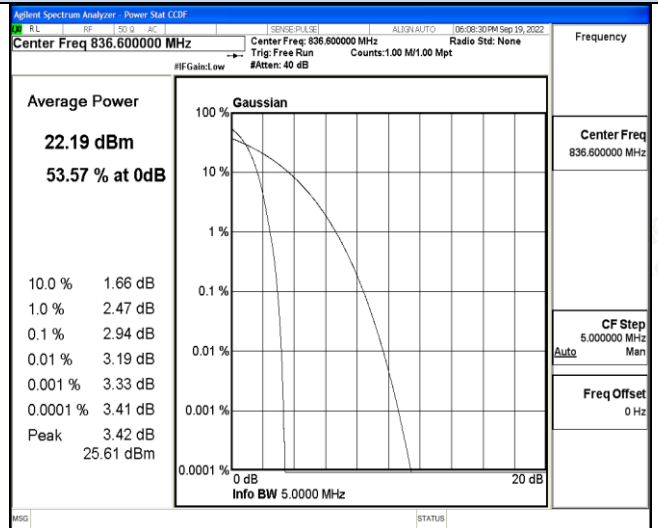
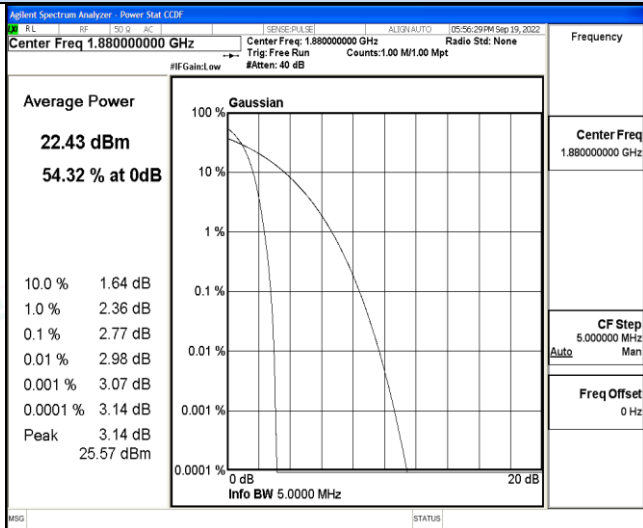

Channel 9400 / 1880.0 MHz

Channel 4182/ 836.4 MHz

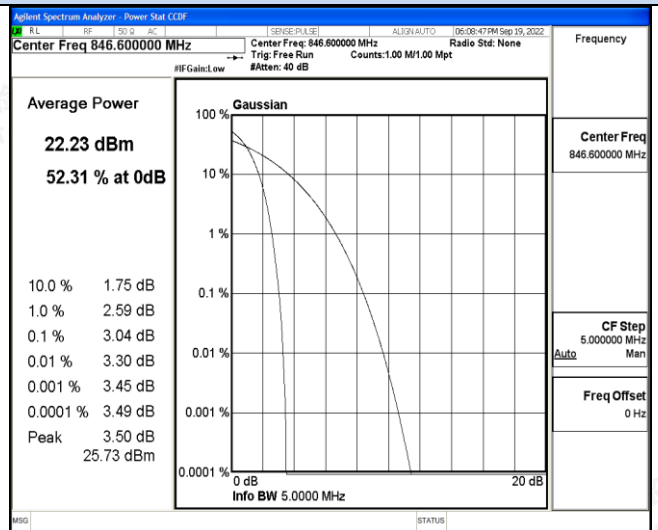
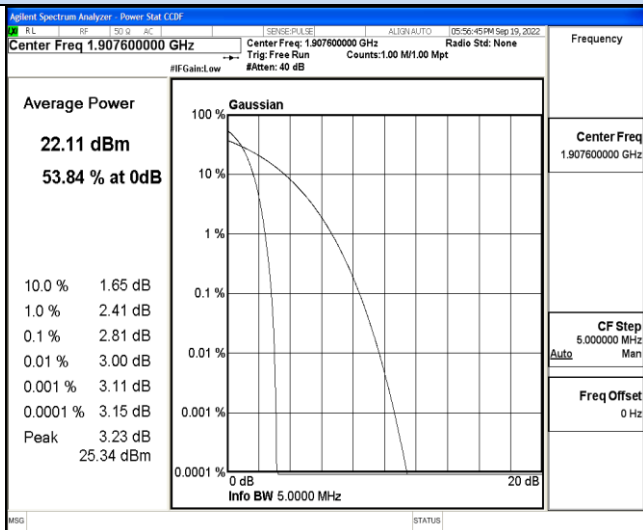

Channel 9538 / 1907.6 MHz

Channel 4233/ 846.6 MHz

Peak-to-Average Ratio (PAR)



Shenzhen LCS Compliance Testing Laboratory Ltd.

Add: 101, 201 Bldg A & 301 Bldg C, Juji Industrial Park Yabianxueziwei, Shajing Street, Baoan District, Shenzhen, 518000, China

Tel: +(86) 0755-82591330 | E-mail: webmaster@lcs-cert.com | Web: www.lcs-cert.com

Scan code to check authenticity



UMTS/TM1/ WCDMA Band IV

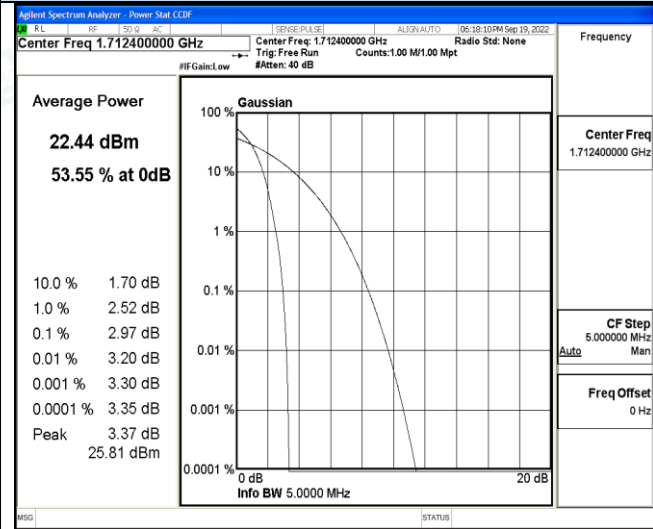

Channel 1312 / 1712.4 MHz

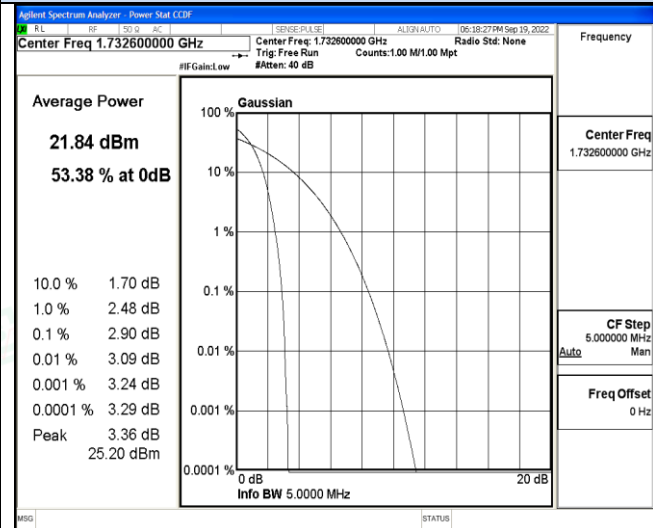

Channel 1413 / 1732.6 MHz

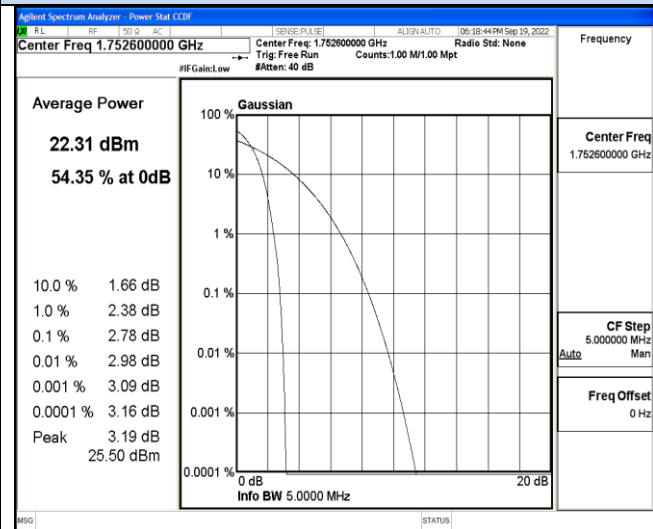

Channel 1513 / 1752.6 MHz



Shenzhen LCS Compliance Testing Laboratory Ltd.

Add: 101, 201 Bldg A & 301 Bldg C, Juji Industrial Park Yabianxueziwei, Shajing Street, Baoan District, Shenzhen, 518000, China

Tel: +(86) 0755-82591330 | E-mail: webmaster@lcs-cert.com | Web: www.lcs-cert.com

Scan code to check authenticity



5 Test Setup Photos of the EUT

Please refer to separated files for Test Setup Photos of the EUT.

6 External Photos of the EUT

Please refer to separated files for External Photos of the EUT.

7 Internal Photos of the EUT

Please refer to separated files for Internal Photos of the EUT.

.....**End of Report**.....

