

Infotainment System User's Manual

[Only for INFO3.0]

[작업메모]

Initial Release

[Style of each level]

**Level 1: Arial Bold
16**

Level 2: Arial Bold 14

Level 3: Arial Bold 12

Level 4: Arial Bold 10

Main text (Item title): Arial Bold 9

Main text (Description): Arial Normal 9

- Notes: Arial Normal 8

Infotainment System

Introduction	1
Personalization	8
Radio	10
Audio Players	14
Phone	18

Introduction

Introduction

General Information

The Infotainment system provides you with state-of-the-art in-car infotainment.

Using the radio tuner functions, you can register a large number of stations on different favorite pages.

You can connect external data storage devices, e.g. iPod, USB devices, or other auxiliary devices to the Infotainment system as further audio sources; either via a cable or via Bluetooth.

The digital sound processor provides you with several preset equalizer modes for sound optimization.

In addition, the Infotainment system is equipped with a Phone portal that allows comfortable and safe use of your mobile phone in the vehicle.

Optionally, the Infotainment system can be operated using the control panel or the controls on the steering wheel.

If provided by your mobile phone, the system can also be operated via speech recognition.

Note

This manual describes all options and features available for the various Infotainment systems.

Certain descriptions, including those for display and menu functions, may not apply to your vehicle due to model variant, country specifications, special equipment or accessories.

Important information on operation and traffic safety

⚠Warning
Drive safely at all times when using the Infotainment system. If in doubt, stop the vehicle before operating the Infotainment system.

Radio reception

Radio reception may be disrupted by static, noise, distortion or loss of reception due to:

- changes in distance from the transmitter
- multi-path reception due to reflection
- shadowing

Theft-deterrent feature

The Infotainment system is equipped with an electronic security system for the purpose of theft deterrence.

The Infotainment system therefore functions only in your vehicle and is worthless to a thief.

3 Infotainment System

Overview

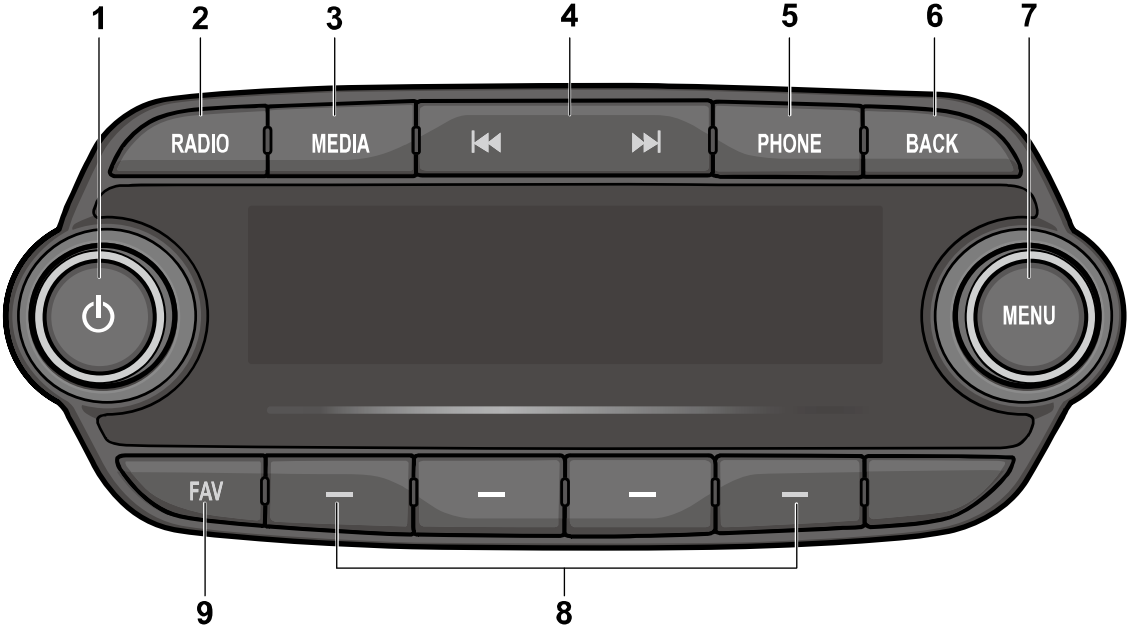

(1) 

- When power is off, press to turn power on.
- When power is on, press and hold to turn power off.
- When power is on, press shortly to turn the mute function on or off.
- Turn to adjust volume.



(2) RADIO

Select Radio mode. Each time **RADIO** is pressed, the mode is changed in order of AM RADIO → FM RADIO → DAB → AM RADIO →....

(3) MEDIA

Activate media or change media source.

(4)  / 

- In Radio mode:
 - When pressed shortly, automatically seeks station with superior reception.
 - When pressed and held, continuously changes the station until  or  is released. When releasing, the system seeks the next station.
- In USB/iPod/Bluetooth audio playback:
 - When pressed shortly, move to the previous or next file.
 - When pressed and held, rewind or fast forward the file.

(5) PHONE

Press to open phone menu.

(6) BACK

Cancel input content or return to the previous menu.

(7) MENU

- Turn **MENU** to search the station/file on the list screen or move/change setup content or setup values.
- Press **MENU** to display the currently functioning menu or select/practice setup content and setup values.

(8) -

- In Radio mode:
 - When pressed shortly, recall the stored radio station.
 - When pressed and held, store the current radio station to the Favorites page.
- In Menu mode:
 - Press any of these buttons to select the function linked to that button.

(9) FAV



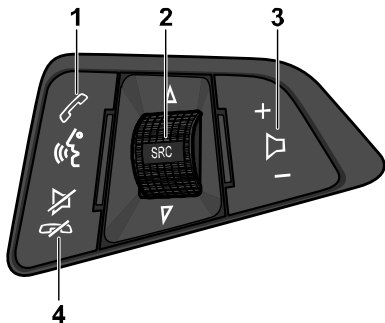

Press **FAV** to select the page of saved favorite channels.

5 Infotainment System





Steering wheel audio remote control: option





(1) /

- Press  or  to answer the call or enter the recent call. If Siri function is enabled, Siri is re-activated.
- Press and hold  or  to enter the dialed call log or to move back and forth from hands-free mode and private call mode during a call.
- When iPhone is connected, press and hold to enter the Siri function.





(2) SRC /

- When **SRC**  /  are turned up/down. In Radio modes, changes broadcast frequencies saved to the - buttons. In USB/iPod/Bluetooth audio modes, changes the file.
- Press **SRC**  /  to change the audio source.

(3) +/-

- Press  +/- to increase/decrease the volume.
- Press and hold  +/- to quickly increase/decrease the volume.

(4) /

- Press  /  in any music play mode to turn the mute function on or off.
- Press and hold  /  to reject or finish the call during a call.

Operation

Buttons and controlling device

The Infotainment system is operated by using the function buttons, multifunctional dial, and the menu indicated on the screen display.

The buttons and control devices used in the system are as follows.

- The Infotainment system buttons and dial
- The Steering wheel audio remote control buttons

The Infotainment system is operated via function buttons, a MENU knob and menus that are shown on the display.

Inputs are made optionally via:

- The control panel on the Infotainment system
- Audio controls on the steering wheel
- The speech recognition

System on/off

Press  to turn the power on.

- When the power is off, pressing the  will turn the power on and play a radio broadcast.

Automatically turn power on

- When the external source is connected on the power off mode, system will turn power on and play.
If this connection is removed, system is automatically turn power off.
- When a call is received or initiated, the power is turned on and the action is carried out.

If this action is ended, system is automatically turn power off.

- When pressing a HVAC related button, system will turn power on and operate this action.

If no action is taken within 5 seconds, the system will automatically turn power off.

Press and hold  to turn the power off.

- When the System is turned off, the time of Day is displayed.



Volume control

Turn  to adjust the volume.

- When the Infotainment system is switched on, the last selected volume is set, provided that the volume is lower than the maximum start-up volume

Mute control

Press  to turn mute on.

- Mute symbol “” will display on the status area and mute the sound.
- To cancel the mute function, press .

Tone settings

Press **MENU** > select the Settings > select the Tone Settings to enter the Tone Settings screen.

- Turn **MENU** to select the Tone Settings mode. Use **MENU** to switch between Bass ↔ Midrange ↔ Treble ↔ Fade ↔ Balance ↔ EQ.
- Highlight the desired tone setting option and press **MENU** to be able to change its current value.
- Turning **MENU** will change the tone setting value and the changes will be reflected in the bar graphic on the display.

7 Infotainment System

Press **MENU** to store the new setting and return to the Tone Settings screen.

Tone setting menu

- Bass: sets the bass sound level.
- Midrange: sets the middle sound level.
- Treble: sets the treble sound level.
- Fade: sets the sound fade between the front and rear speaker.
- Balance: sets the sound balance between the right and left speaker.
- EQ: selects the one of the 7 EQ styles (Custom, Pop, Rock, Country, Jazz, Talk, Classical)
- The tone settings values range between -12 and +12.

Speed compensated volume

When Auto volume is activated, the volume is adapted automatically to make up for the road and wind noises as you drive.

Select function

AM/FM Radio or DAB

Press **RADIO** to select AM/FM radio or DAB function.

Press **MENU** to open the AM/FM or DAB menu that includes options for selecting broadcast stations.

USB/iPod/Bluetooth audio or exterior sound (AUX) input play

Press **MEDIA** to select the audio player functions.

Each time **MEDIA** is pressed, the system switches between **USB/ iPod → Bluetooth music → AUX → USB/iPod →...**

Press **MENU** to open the menu with options for the relevant function or the menu of the relevant device.

Bluetooth Hands-free phone device

Press **PHONE** to establish a Bluetooth connection between the Infotainment system and a mobile phone.

If a connection can be established, the main menu of the phone mode is displayed.

If no connection can be established, a corresponding menu is displayed.

For a detailed description of preparing and establishing a Bluetooth connection between the Infotainment system and a mobile phone

Personalization

Personalization

How to use the Settings menu for personalization

The **MENU** knob is one of the central control elements for menu operation.

Turn:

- to select a screen button or menu item
- to scroll through a list of menu items
- to change a settings value

Press:

- to activate a selected screen button or menu item
- to confirm a changed settings value
- to switch to a different settings option
- to display the application-specific submenu

Select the Settings in the Menu > Turn **MENU** to move to the desired menu item > press **MENU** to enter the item's detailed menu.

Setting the Time and Date

Set Time

Select Set Time to enter the respective submenu.

Select Auto Set at the bottom of the screen. Activate either On - RDS or Off (Manual).

If Off (Manual) is selected, adjust hours and minutes.

Repeatedly select 12-24 HR at the bottom of the screen to choose a time mode.

If the 12-hour mode is selected, a third column for AM and PM selection is displayed. Select the desired option.

Set Date

Select Set Date to enter the respective submenu.

Select Auto Set at the bottom of the screen. Activate either On - RDS or Off (Manual).

If Off (Manual) is selected, adjust the date settings.

Volume settings

Adjusting the speed compensated volume

Press **MENU** to open the respective audio menu.

Scroll through the list and select Settings.

Select Auto Volume Control.

The Auto Volume function can be deactivated or the degree of volume adaptation can be selected in the menu displayed.

Scroll through the list and select the desired option.

Adjusting the maximum startup volume

Press **MENU** to open the respective audio menu.

Scroll through the list and select Settings.

Select Maximum Startup Volume.

Set the desired value.

9 Infotainment System

Volume of traffic announcements

To adjust the volume of traffic announcements, set the desired volume while a traffic announcement is given out by the system.

The respective setting is stored by the system.

Setting the Language

Press **MENU** to open the respective audio menu.

Select Settings, scroll through the list and select Vehicle Settings.

Select Languages.

Scroll through the list and select the desired language.

Return Factory Settings

Press **MENU** to open the respective audio menu.

Select Settings, scroll through the list and select Vehicle Settings.

Select Restore Factory Settings to enter the respective submenu.

Select the desired option and confirm the message.

Software Information

The Software Information menu contains specific information on the software.

Press **MENU** to open the respective audio menu.

Select Settings, scroll through the list and select Vehicle Settings.

Select Software Information.

Radio

AM/FM Radio

Selecting the radio mode

Press **RADIO** to enter the radio function.

Repeatedly press **RADIO** on the control panel to toggle between the different wavebands.

Seeking for radio station

Press **◀** or **▶** to move to the previous or next station.

Press and hold **◀** or **▶**.

Release the button when the required frequency has almost been reached.

Tuning a radio station manually

Press **MENU** to open the waveband menu and then select Manual Tuning. Depending on the waveband selected, a list of all frequencies is displayed. Select the desired frequency.

Station lists

Turn **MENU** to display a list of all stations currently receivable.

Scroll through the list and select the desired station.

Storing Radio Frequency

Repeatedly press **FAV** to select the desired page of stored favorites. Press and hold any of the - buttons to store the current radio station to that button of the selected Favorites page.

Selecting Presets

Repeatedly press **FAV** to select the desired FAV preset page. Press a - to directly listen to the radio station stored to that button.

FM/AM Menu

While listening to the radio, press **MENU** to enter the FM/AM menu.

Turn **MENU** to move the desired menu item, and then press **MENU** to select the relevant item or to enter the item's detailed menu.

- Station List: selects a station in the list of strong stations.
- Update Station List: Automatically search and save receivable frequencies to Station List.
- Manual Tuning: Briefly turn the dial, moves previous/next frequency.
- Set Number of Favorites Page: sets the number of the maximum number of Favorites pages.

11 Infotainment System

Digital audio broadcasting (DAB)

Advantages of DAB

- DAB stations are indicated by the program name instead of the broadcasting frequency.
- With DAB, several radio programs (services) can be broadcasted on a single frequency (ensemble).
- Besides high-quality digital audio services, DAB is also able to transmit program-associated data and a multitude of other data services including travel and traffic information.
- As long as a given DAB receiver can pick up the signal sent out by a broadcasting station (even if the signal is very weak), sound reproduction is ensured.
- In the event of poor reception, the volume is reduced automatically to avoid the output of disagreeable noises.
If the DAB signal is too weak to be picked up by the receiver, reception is interrupted completely. This can be avoided by activating DAB to DAB Linking and/or DAB to FM Linking in the DAB option menu (see below).
- Interference caused by stations that are on nearby frequencies (a phenomenon that is

typical of AM and FM reception) does not occur with DAB.

- If the DAB signal is reflected by natural obstacles or buildings, the reception quality of DAB is improved, whereas AM or FM reception is considerably impaired in such cases.
- When DAB reception is enabled, the FM tuner of the Infotainment system remains active in the background and continually searches for the best receivable FM stations. If TP is activated, traffic announcements of the FM station with the current best reception are issued.
Deactivate TP if DAB reception should not be interrupted by FM traffic announcements.

DAB settings

To configure the DAB settings options, activate the radio function and then select the DAB waveband.

Press **MENU** to display the DAB waveband menu.

DAB Announcements

Besides their music programs, a lot of DAB stations also broadcast

announcements of various categories. If you activate some or all categories, the currently received DAB service is interrupted when an announcement of these categories is made.

Select DAB Announcements to display the DAB categories list.

Select the desired categories. The selected categories are marked with ✓.

DAB to DAB Linking

If this function is activated, the device switches over to the same service (program) on another DAB ensemble (if available) when the DAB signal is too weak to be picked up by the receiver. Set DAB to DAB Linking to On or Off.

DAB to FM Linking

If this function is activated, the device switches over to a corresponding FM station of the active DAB service (if available) when the DAB signal is too weak to be picked up by the receiver. Set DAB to FM Linking to On or Off.

L Band

If L Band is activated, the Infotainment system receives an additional frequency range (1452 - 1492 MHz).

Set L-Band to On or Off.

Intellitext

The Intellitext function allows for the reception of additional information such as announcements, financial information, sports, news etc.

Select one of the categories and choose a specific item from the list to display detailed information.

13 Infotainment System

Audio Players

Auxiliary Devices

USB player

Cautions for using USB devices

- Operation cannot be guaranteed if the HDD built-in USB mass storage device or CF or SD memory card is connected by using a USB adaptor. Use a USB or flash memory type storage device.
- Take caution to avoid static electricity discharge when connecting or disconnecting the USB. If connection and disconnection are repeated many times in a short time, this may cause a problem in using the device.
- Operation is not guaranteed if the connecting terminal of the USB device is not metal.
- Connection with i-Stick Type USB storage devices may be faulty due to vehicle vibration, so their operation cannot be guaranteed.
- Be careful not to touch the USB connecting terminal with an object or any part of your body.
- The USB storage device can only be recognized when it is formatted in FAT16/32 file format. Only devices with an

allocated unit size of 512 byte/sector or 2,048 byte/sector can be used. NTFS and other file systems cannot be recognized.

- According to the type and capacity of the USB storage device and the type of the stored file, the time it takes to recognize the files may differ. This is not a problem with the product in this case, so please wait for the files to be processed.
- Files in some USB storage devices may not be recognized due to compatibility problems, and connections with a memory reader or a USB hub are not supported. Please check the device's operation in the vehicle before use.
- When devices such as an MP3 player or digital camera are connected through a mobile disc, it may not operate normally.
- Do not disconnect the USB storage device while it is being played.
This may cause damage to the product or the performance of the USB device.
- Disconnect the connected USB storage device when the vehicle ignition turned off. If the ignition is turned on while the USB storage device is connected, the USB storage device may be damaged or may not operate normally in some cases.

Caution

USB storage devices can only be connected to this product for the purpose of playing music files.

The product's USB terminal should not be used to charge USB accessory equipment since the heat generation using the USB terminal may cause performance issues or damage to the product.

- When the logical drive is separated from a mass USB storage device, only the files from the top-level logical drive can be played for USB music files. This is the reason that the music files to be played should be stored in the top-level drive of the device. Music files in particular USB storage devices may also not be normally played if an application is loaded by partitioning a separate drive inside the USB device.
- Music files to which Digital Right Management (DRM) is applied cannot be played.

This product can support USB storage devices that are up to 16 Gigabytes in capacity with a limit of 6,000 files, 100 folders, and 8 stages of folder structure. Normal usage cannot be guaranteed for storage devices that exceed this limit.

Caution for using USB music files

- Damaged music files may be cut-off during playback or may not be played at all.

About MP3 (WMA) music files

- The MP3 files that can be played are as follows.
 - Bit rate: 8 kbps ~ 320 kbps
 - Sampling frequency:
 - 48 kHz, 44.1 kHz, 32 kHz (for MPEG-1)
 - 24 kHz, 22.05 kHz, 16 kHz (for MPEG-2)
- This product displays MP3 (WMA) files with the mp3, .wma (lower case letters) or .MP3 or .WMA (capital letters) file name extensions.
- This product can display ID3 tag (Version 1.0, 1.1, 2.2, 2.3, 2.4) information about album, artist, etc. for MP3 files.
- The file/folder names that can be used according to storage type are as follows, including the four character file name extensions (.mp3).
- This product can play MP3 files which use VBR. When a VBR type MP3 file is being played, the remaining time displayed may be different from the actual time remaining.

Connecting the USB storage device

Connect the USB storage device in which music files are stored to the USB connection terminal.

Once the product finishes reading the information on the USB storage device, it will automatically start playing.

If a non-readable USB storage device is connected, then an error message will appear and the product will automatically switch to the previously used function or the FM radio function.

If the USB storage device to be played is already connected, repeatedly press **MEDIA** to select the USB player.

- It will automatically play from the previous playing point.
- If there is no connected, "No Media Available" with a DISMISS and PAIR option in the display screen.
- The information displayed includes the file name, folder name, and ID3 Tag information saved with the song.

If incorrect ID3 Tag information (e.g. artist, song title) was added to MP3 (WMA) files before they are burnt to disc, this information will be displayed as is by the

Infotainment system.

Incorrect ID3 Tag information cannot be modified or corrected on the Infotainment system (ID3 Tags can only be corrected on a PC).

The information for songs expressed in special symbols or in unavailable languages may be displayed as "*****" or are not displayed at all.

Ending USB music files playback

Press **RADIO** or **MEDIA** to select other functions.

Selecting playing file

While playing, press ◀ or ▶ to select the previous or next file.

Turn **MENU** to move the desired file in the file list, and then press **MENU** to instantly change it.

Fast-forwarding and Re-winding the file

While playing, press and hold ◀◀ or ▶▶ to rewind or fast-forward through the song until released.

15 Infotainment System

Once released, the file will begin playing at normal speed.

Using the USB menu

While playing the file, press **MENU** to enter the USB menu.

Turn **MENU** to move the desired menu item, and then press **MENU** to select the relevant item or to enter the item's detailed menu.

- Folder View: Enter the Folder View mode, and move to the previous or next folder.
- Shuffle: Turn the shuffle feature on or off.

Browsing/Indexing Device

- Browsing is not supported until indexing is completed for the connected device.
- While indexing, if select browse from the menu, a pop-up "Feature not supported during Indexing Use folder view to browse contents" will display.
- When a single device with greater than 6,000 songs is connected, a pop-up "Media indexing memory full Use folder view or remove other device" will display.

Using the MTP menu

Charge Only: select the charge option for the MTP device. MTP device will be charged, and system will show the pop-up message, when it is connected.

- The default is Charge Only.
- When the Charge Only option is selected in the Media Transfer Protocol (MTP) Setting Menu, the audio source is not changed and the connected device is only charged.
- If you change to USB mode while charging the device, a Charge message with charging activity indicator is shown on the display screen. In this case, the system will not start indexing the files on the device.
- Charging may not be supported by some MTP devices.

Scan Music Folder Only: select the Music Folder Scan option for the MTP device.

The system can display the Artist Name/Song Name/Elapsed Time regarding the current song and access the playlist on the MTP device.

Scan All Folder: select the All Folder scan option for the MTP device.

- The device indexing time takes longer than the setting of Scan Music Folder Only. It depends on the smartphone and the files/folders on the smartphone.
- With some phones featuring Media Transfer Protocol (MTP), music search can take a long time.
- If the phone screen is locked, you cannot search for music. To access music on the phone, unlock the phone screen.
- If you connect the abnormal device, the system may not properly operate.

iPod player

Connecting iPod player

Connect the iPod device in which the music files are stored to the USB connection terminal.

Some iPod/iPhone product models may not be supported.

If you connect the abnormal device, the system may not properly operate.

Only connect the iPod to this product with connection cables supported by iPod products. Other connection cables cannot be used.

- In some cases, the iPod product may be damaged if the ignition is turned off when it is connected to the product.
When the iPod product is not being used, keep it separately from this product with the car ignition turned off.
- Once the product finishes reading the information on the iPod device, it will play automatically.
- If a non-readable iPod device is connected, then the relevant error message will appear and the product will automatically switch to the previously used function or the FM radio function.

If the iPod device to be played is already connected, repeatedly press **MEDIA** to select the iPod player.

- It will automatically play from the previously played point.
- The playback functions and the information display items of the iPod player used with this product may be different from the iPod in terms of play order, method, and the information displayed.

Ending iPod playback

To end playback, press **RADIO** or **MEDIA** to select other functions.

Using the iPod menu

While playing the file, press **MENU** to enter the Menu iPod.

Turn **MENU** to move the desired menu item, and then press **MENU** to select the relevant item or to enter the item's detailed menu.

- Browse "Device Name": selects a list item in the list of browse names such as Playlists, Artists, Albums, Tracks, Genres, Audio Books, and Composers.
- Shuffle: turn the shuffle feature on/off.

Exterior Sound (AUX) Input

Connecting an exterior sound

Connect the audio output of the external audio equipment to AUX input terminal.

- The Infotainment system will automatically switch to the exterior sound (AUX) input mode when the exterior sound device is connected.

Press **MEDIA** to switch to the exterior sound input mode if the exterior sound system has already been connected.

Phone

Bluetooth

About Bluetooth

About Bluetooth wireless technology

- Bluetooth® Wireless Technology refers to a short-distance wireless networking technology which uses a 2.45GHz frequency to connect various devices within a certain distance.
- Supported within PCs, external devices, Bluetooth® phones, PDAs, various electronic devices, and automotive environments, Bluetooth® Wireless Technology to be transmitted at high speeds without having to use a connector cable.
- Bluetooth® Hands-free refers to a device which allows the user to conveniently make phone calls with Bluetooth® mobile phones through the multimedia system.

Before Connecting the Bluetooth Unit

- Before connecting the head unit with the mobile phone, check to see that the mobile phone supports Bluetooth features.

- Even if the phone supports Bluetooth Wireless Technology, the phone will not be found during device searches if the phone has been set to hidden state or the Bluetooth power is turned off.
- Disable the hidden state or turn on the Bluetooth power prior to searching or connecting with the head unit.
- If Auto Connection is used, the Bluetooth phone is automatically connected when the ignition is turned on, making it unnecessary to have to connect the phone with the head unit every time.
- If you do not want automatic connection with your Bluetooth device, turn the Bluetooth feature off of the Bluetooth device.
- Park the vehicle when connecting the unit with the mobile phone.
- Bluetooth connection may become intermittently disconnected in some mobile phones. Follow these steps to try again.
 1. Turn the Bluetooth® function within the mobile phone OFF/ON and try again.
 2. Turn the mobile phone power OFF/ON and try again.
 3. Completely remove the mobile phone battery, reboot, and then again.
 4. Reboot this unit and try again.
 5. Delete all paired devices, pair and try

again.

- The hands-free call volume and quality may differ depending on the mobile phone.
- Pairing Bluetooth devices and use of other Bluetooth features are not supported when the vehicle is in motion. Please first park your vehicle.
- When downloading contacts, phenomenon not described within this user's manual may be related with the mobile device. When such occurs, inquire within the mobile phone manufacturer.
- As a Bluetooth wireless connection can extend to 10 meters, your Bluetooth device may automatically connect to this unit even if the device is not in the car. Please consider this, especially when pairing or connecting Bluetooth devices to the car radio when other Bluetooth devices may be within wireless radio range of the car radio.
- This unit uses the latest Digital Noise & Echo suppression system to provide the best sound clarity with little or no distortion, but in some conditions there may be some echo and noise experienced. It is recommended to keep the car windows closed during hands-free calls for best results.
- This unit uses the following Bluetooth profiles:

1. Phone Book Access Profile (PBAP)
 2. Hands Free Profile (HFP)
 3. Advanced Audio Distribution Profile (A2DP)
 4. Audio Video Remote Control Profile (AVRCP)
- If Bluetooth profile does not matched, system will display the “Action not supported by this device” pop-up on the display screen. (e.g.: device is not able to control **MENU**.)

Before Using Bluetooth Music mode

- Bluetooth Audio mode can be used only when a Bluetooth Audio mode capable device has been connected.
- If music is not yet playing from your mobile device after converting to streaming audio (Bluetooth Audio) mode or after pressing Play on the mobile device itself, pressing again the button once may begin playing the music.
- Check to see whether music is playing from the Bluetooth device after converting to streaming audio mode. The Streaming audio feature may not be supported in some mobile phones.
- While Bluetooth Audio mode is playing, if the Bluetooth phone is disconnected, then

the music will also stop.

- Bluetooth streaming audio may not be supported with some mobile phones.
- If this indicator is not displayed, then no Bluetooth device is connected or the connection is not of satisfactory quality.
- This unit can pair up to 5 Bluetooth devices.

Connecting Bluetooth

Registering the Bluetooth device

Register the Bluetooth device to be connected to the Infotainment system.

Firstly, set up the Bluetooth device to be connected from the Bluetooth settings menu to enable other devices to search for the Bluetooth device.

Press PHONE to enter the Phone application mode.

To select Pair, press -. The information “Name: Device name / PIN: 0000” appears in the display screen and then the Pairing progress starts.

- If no phone source is connected, the status region displays “**No Device Paired**”.
- To change the PIN, press the - and select New Pin in the Pair menu. Turn and press **MENU** to change the PIN.

From the Bluetooth device, search for this unit and pair the device.

1. Turn on the Bluetooth on your phone.
2. Search and select device “**Device name**” in Bluetooth menu.
3. Enter this item on your phone.

To learn more about searching from Bluetooth devices and pairing, refer to the user’s manual for your Bluetooth device.

After a while, the Bluetooth device is automatically registered.

- If the registration of device to be connected to the unit is successful, then the “**Bluetooth Connected**” appears in the display screen.
- After Pairing is complete, a contacts download request is sent to your mobile phone. Please check your phone and accept the download request if necessary.

When pairing a second device, repeat the above steps.

- If a Bluetooth device is connected, a new device cannot be paired. If you want to pair a new phone, first disconnect the connected Bluetooth device.
- This unit can pair up to 5 Bluetooth devices.

19 Infotainment System

When pairing a second device, repeat the above steps.

- If a Bluetooth device is connected, a new device cannot be paired. If you want to pair a new phone, first disconnect the connected Bluetooth device.
- This unit can pair up to 5 Bluetooth devices.

Adding/Connecting/Disconnecting/Deleting the Bluetooth devices

Firstly, set up the Bluetooth device to be connected from the Bluetooth setup menu to enable other devices to search for the Bluetooth device.

Press **PHONE** > press **MENU** to select the Bluetooth Devices to enter the Phone List menu > turn **MENU** to move to the list device item > press - to select the desired menu item.

- **Select Add:** The information "**Name: Device name / PIN: 0000**" appears in the display screen and then the Pairing progress starts.
- **Select Connect:** After a while, the Bluetooth device is automatically connected, and "**Bluetooth Connected**" appears on the display screen.

- **Select Disconnect:** Disconnect the connected Bluetooth device from the Phone List menu.
- **Select Delete:** Delete the registered Bluetooth device from the Phone List menu.

Bluetooth Music player

Connecting Bluetooth music player

Connect the Bluetooth device in which the music files are stored.

Repeatedly press **MEDIA** to select the Bluetooth Music mode.

- Audio file within the Bluetooth device will automatically play once "Bluetooth Music" is displayed on the display screen.
- If music is not yet playing from your mobile device after switching to streaming audio (Bluetooth Music) mode or after pressing Play on the mobile device itself, try to start music playback by pressing the Play button again.

While playing, press **◀** or **▶** to moves to the previous or next track.

- This function only operates with Bluetooth devices that support Audio Video Remote Control Profile (AVRCP) version 1.0 or above. Depending on the Bluetooth device options, some devices may display Audio Video Remote Control Profile (AVRCP)

being connected for the initial connection.

- If the Bluetooth device is disconnected while Bluetooth music is playing, the music will also stop.

Using the Bluetooth Music menu

While playing, press **MENU** to enter the Bluetooth Audio Menu.

Turn **MENU** to move the desired menu item, and then press **MENU** to select the relevant item or to enter the item's detailed menu.

- **Browse "Device Name":** Select a list item in the list of browse names. If the Bluetooth profiles do not match, the system will display "**Action not supported by devices**".
- Support Profile version: Audio Video Remote Control Profile (AVRCP) 1.4.
- **Shuffle:** Turn the shuffle feature on or off.
- **Manage Bluetooth devices:** Enter the Phone List menu.

Phone

Emergency call

Warning: *Connection setup cannot be guaranteed in all situations. For this reason, do not rely exclusively on a mobile phone when a vitally important communication (e.g. a medical emergency) is concerned.*

On some networks, it may be necessary for a valid SIM card to be properly inserted in the mobile phone.

Warning: *Bear in mind that you can make and receive calls with the mobile phone, if it is in a service area with a sufficiently strong signal. Under certain circumstances emergency calls cannot be made on all mobile phone networks; it is possible that they cannot be made when certain network services and/or telephone functions are active. You can enquire about this with the local network operators.*

The emergency call number can differ depending on the region and country. Please enquire beforehand about the correct emergency call number for the relevant region.

Making an emergency call

Dial the emergency call number (e.g. 112).



The telephone connection to the emergency call center is set up.

Answer when the service personnel questions you about the emergency.

Warning: *Do not end the call until you are requested to do so by the emergency call center.*

Using the Siri function



In order to use the Siri function, the iPhone must be connected to the Infotainment system via USB cable or via Bluetooth.

When iPhone is connected, press and hold  /  on the steering wheel audio control to activate the Siri function.

- Compatible with iPhone devices that support iOS 4.0 or later.
- When Siri is already enabled, press to re-activate the Siri.
- Siri commands that can be used in conjunction with this product supports dialing commands via the iPhone, select the song and playback of iPhone Music Player.



Incoming Call

When a phone call comes through the connected Bluetooth mobile phone, the playing track will be cut off and the phone will ring with the relevant information displayed.

To receive a call, press  /  on the steering wheel audio control to move to the Active Call screen or press - to

21 Infotainment System

select the Answer to move to the Active Call screen.

To reject a call, press and hold  /  on the steering wheel audio control or press - to select the Ignore.

- An ignored call is sent to the voice mail box, the ringtone stops, and the alert is extinguished, returning the display to the previous screen prior to the alert.
- If the call is not ignored or answered before it is transferred to the voice mail box, the alert will extinguish returning to the previous screen and the ringtone stops.

Call Waiting

If another person calls while you are already on the phone, the system displays a second incoming call pop-up.

Press PHONE or % on the steering wheel audio control to switch between 1st call and 2nd call.

If two calls are active (call waiting mode), a call waiting alert is not displayed.

Phone Volume Control

Turn  to adjust the Phone Volume while in an active phone call (e.g. through volume steps 0 ~ 63).

Caution
It is possible to transfer your ringtone depending on the mobile phones. Adjust the ringtone volume of the mobile phone if the volume is too low.

You can use the volume control to adjust the Ring Tone Volume while the ring tone is given out starting at a defined minimum volume. The volume ranges from level 3 to max.

During a Call

During the active call, the Active Call screen displays information relevant to an active phone call.

End: End an active phone call.

When a call is ended, the system returns to the screen active before the call.

Mute/Unmute: Mute the vehicle microphone while in an active call by pressing the button.

If the microphone is muted, the label changes Unmute. Press the button again to unmute the microphone.

Handset/Hands-free: Switch from Hands-free mode to the phone handset by pressing - directly.

- If the phone call on the active phone source is handled in handset mode, the label changes to hands-free.
- Pressing the button now returns the phone conversation to hands-free mode.
- The hands-free mode is default when a call is initiated.
- If there is an issue and the call is not transferred to hands-free or handset as the user requested, a message is displayed notifying the user that the transfer could not be carried out. Please retry.

Keypad: Enter the Keypad screen.

Ending a Call

If a call is ended while the system is displaying any other screen than the Active Call screen, the Call Ended message is displayed.

- The call may be ended by the person on the other end of the line, from the Bluetooth handheld device or by pressing  on the steering wheel audio remote control.
- After 5 seconds, the display returns to the previous screen.

Re-dialing a Call

If the phone call was dropped, you can re-dial the number before the time out by pressing  – directly below the display labeled Redial.

Calling a number in the call log

Press **PHONE** to enter the Phone List menu > turn **MENU** to select the Recent Calls > press **MENU** > turn **MENU** to select Missed Calls, Received Calls or Sent Calls, then press **MENU**.

The recent calls list displays an intermediate menu containing missed calls, received calls, and sent calls.

Turn **MENU** to select a name or phone number, and press **MENU** to make a call.

Calling a Number in the Phone Book

Press **PHONE** to enter the Phone List menu > turn **MENU** to select Contacts > press **MENU** > turn **MENU** to select a name or phone number, and press **MENU** to make a call.

The last outgoing phone source is retained at the next ignition cycle, if that phone device is connected, and it is the outgoing phone source.

Downloading the Phone Book

If the Bluetooth device supports a phone book synchronization function, the phonebook is downloaded automatically after the connection has been established.

- The call history lists can be downloaded from the connected Bluetooth device.
- Sorting call histories by time is not supported.
- It is possible to download the call history even when proceeding another action.
- It is not possible to start the download process when the call history download feature is turned off within the Bluetooth device.
- After Pairing is completed, a contacts

download request is sent to your mobile phone. Some phones require additional confirmation. Please check your phone and accept the download request if necessary.

- If a paired phone is deleted, its call history lists will also be deleted from the system.
- The system only uses information coded in UTF-8 format.

Dial a Number by Keypad

Press **PHONE** to enter the Phone List menu > turn **MENU** to select the Keypad and press **MENU** to enter the Keypad screen.

- When users select Keypad from the Phone Home Screen, a phone dialer keypad is displayed.
- Users rotate the knob to highlight the desired digit to dial and press the knob to select it.

Turn **MENU** to highlight the desired digit to dial and press **MENU** to select it.

You can enter max 24 digits.

- If the user continues to turn the knob when the end of the keypad is reached, it jumps to the other side of the keypad.
- Digits are displayed in the digit screen as they are entered.

23 Infotainment System

- The Call button is not active until the user has input a digit.
- Once the user has entered the desired phone number, press – to begin calling that number.
- While the connection is established, the system displays the Active Call screen.
- If the user made a mistake while entering a phone number, turn **MENU** to highlight Delete and press the knob to delete the last digit entered.
- Pressing and holding **MENU** for the standard time while Delete is highlighted clears the entire digit field.

Bluetooth Devices View

Press **PHONE** to enter the Phone menu > turn **MENU** to select the Bluetooth Devices > press **MENU** to enter the Phone List menu.

- The list contains the device names of all Bluetooth devices that have been paired with the system.
- If the device name received is blank, empty string is displayed.
- From the Bluetooth Device List menu, the user may add (pair) a device, delete a device, and connect a device.

Incoming Text Message

When a Text Message is received by the connected Bluetooth mobile phone, the phone will display the relevant information.

- If the sender is registered in the phone book, the first and last name is displayed.
- If the number is not stored in the phone book, the phone number is displayed.
- The Text Message alert is displayed as soon as all information is available.

To display the entire message, press – directly below the display labeled “**View**”. The detail message screen is now displayed.

This feature is not available while vehicle is moving.

FCC Information to User

This equipment has been tested and found to comply with the limits for a Class B digital device, pursuant to Part 15 of the FCC Rules. These limits are designed to provide reasonable protection against harmful interference in a residential installation. This equipment generates, uses and can radiate radio frequency energy and, if not installed and used in accordance with the instructions, may cause harmful interference to radio communications. However, there is no guarantee that interference will not occur in a particular installation. If this equipment does cause harmful interference to radio or television reception, which can be determined by turning the equipment off and on, the user is encouraged to try to correct the interference by one of the following measures:

- Reorient or relocate the receiving antenna.
- Increase the separation between the equipment and receiver.
- Connect the equipment into an outlet on a circuit different from that to which the receiver is connected.
- Consult the dealer or an experienced radio/TV technician for help.

Caution

Modifications not expressly approved by the party responsible for compliance could void the user's authority to operate the equipment.

FCC Compliance Information : This device complies with Part 15 of the FCC Rules. Operation is subject to the following two conditions: (1) This device may not cause harmful interference, and (2) this device must accept any interference received, including interference that may cause undesired operation

IMPORTANT NOTE:

FCC RF Radiation Exposure Statement:

This equipment complies with FCC RF radiation exposure limits set forth for an uncontrolled environment. This equipment should be installed and operated with a minimum distance of 20 centimeters between the radiator and your body. This transmitter must not be co-located or operating in conjunction with any other antenna or transmitter.

European Union Regulatory Notice

Compliance with these directives implies conformity to harmonized European standards (European Norms) that are listed in the EU Declaration of Conformity issued by HP for this product or product family. This compliance is indicated by the following conformity marking placed on the product.

CE 0678

The wireless telecommunications functionality of this product may be used in the following EU and EFTA countries:

Austria, Belgium, Bulgaria, Cyprus, Czech Republic, Denmark, Estonia, Finland, France, Germany, Greece, Hungary, Iceland, Ireland, Italy, Latvia, Liechtenstein, Lithuania, Luxembourg, Malta, Netherlands, Norway, Poland, Portugal, Slovak Republic, Slovenia, Spain, Sweden, Switzerland, and United Kingdom.

Products with 2.4-GHz wireless LAN devices France

For 2.4 GHz Wireless LAN operation of this product certain restrictions apply:

This product may be used indoor for the entire 2400-2483.5 MHz frequency band (channels 1-13). For outdoor use, only 2400-2454 MHz frequency band (channels 1-9) may be used. For the latest requirements, see <http://www.art-telecom.fr>.

Italy :

License required for use. Verify with your dealer or directly with the General Direction for Frequency Planning and Management (Direzione Generale Pianificazione e Gestione Frequenze).

CE RF Radiation Exposure Statement:

Caution This equipment complies with European RF radiation exposure limits set forth for an uncontrolled environment. This equipment should be installed and operated with a minimum distance of 20 centimeters between the radiator and your body. This transmitter must not be co-located or operating in conjunction with any other antenna or transmitter.