



Part 15B

TEST REPORT

Product Name	GPS Tracker
Model Name	ES710
FCC ID	YR8ES710
Applicant	eSky wireless Inc.
Manufacturer	ASIATELCO TECHNOLOGIES CO.
Date of issue	March 20, 2015

TA Technology (Shanghai) Co., Ltd.

TA Technology (Shanghai) Co., Ltd.
Test Report

Report No.: RXA1502-0023EMC01R2

Page 2 of 20

GENERAL SUMMARY

Reference Standard(s)	FCC Code CFR47 Part15B (2013) Radio frequency device. ANSI C63.4 (2009) Methods of Measurement of Radio-Noise Emission from Low-Voltage Electrical and Electronic Equipment in the Range of 9 KHz to 40GHz.
Conclusion	This fixed equipment has been measured in all cases requested by the relevant standards. Test results in Chapter 2 of this test report are below limits specified in the relevant standards. General Judgment : Pass
Comment	The test result only responds to the measured sample.

Approved by Guangchang Fan

Guangchang Fan
Director

Revised by Wei Liu

Wei Liu
EMC Manager

Performed by Deyou Zhou

Deyou Zhou
EMC Engineer

TA Technology (Shanghai) Co., Ltd.
Test Report

Report No.: RXA1502-0023EMC01R2

Page 3 of 20

TABLE OF CONTENT

1. General Information	4
1.1. Notes of the test report	4
1.2. Testing laboratory	5
1.3. Applicant Information	5
1.4. Manufacturer Information	5
1.5. Information of EUT	6
1.6. Test Date	6
2. Test Information	7
2.1. Summary of test results	7
2.2. Radiated Emission	8
2.3. Conducted Emission	14
3. Main Test Instruments	17
ANNEX A: The EUT Appearance and Test Setup	18
A.1 EUT Appearance	18
A.2 Test Setup	19

TA Technology (Shanghai) Co., Ltd. Test Report

Report No.: RXA1502-0023EMC01R2

Page 4 of 20

1. General Information

1.1. Notes of the test report

TA Technology (Shanghai) Co., Ltd. has obtained the accreditation of China National Accreditation Service for Conformity Assessment (CNAS), and accreditation number: L2264.

TA Technology (Shanghai) Co., Ltd. has been listed on the US Federal Communications Commission list of test facilities recognized to perform electromagnetic emissions measurements. The site recognition number is 428261.

TA Technology (Shanghai) Co., Ltd. has been listed by industry Canada to perform electromagnetic emission measurement. The site recognition number is 8510A.

TA Technology (Shanghai) Co., Ltd. guarantees the reliability of the data presented in this test report, which is the results of measurements and tests performed for the items under test on the date and under the conditions stated in this test report and is based on the knowledge and technical facilities available at TA Technology (Shanghai) Co., Ltd. at the time of execution of the test.

TA Technology (Shanghai) Co., Ltd. is liable to the client for the maintenance by its personnel of the confidentiality of all information related to the items under test and the results of the test. The sample under test was selected by the Client. This report only refers to the item that has undergone the test.

This report alone does not constitute or imply by its own an approval of the product by the certification Bodies or competent Authorities. This report can not be used partially or in full for publicity and/or promotional purposes without previous written approval of **TA Technology (Shanghai) Co., Ltd.** and the Accreditation Bodies, if it applies.

If the electronic report is inconsistent with the printed one, it should be subject to the latter.

TA Technology (Shanghai) Co., Ltd. Test Report

Report No.: RXA1502-0023EMC01R2

Page 5 of 20

1.2. Testing laboratory

Company: TA Technology (Shanghai) Co., Ltd.
Address: No.145, Jintang Rd, Tangzhen Industry Park, Pudong
City: Shanghai
Post code: 201201
Country: P. R. China
Contact: Xu Kai
Telephone: +86-021-50791141/2/3
Fax: +86-021-50791141/2/3-8000
Website: <http://www.ta-shanghai.com>
E-mail: xukai@ta-shanghai.com

1.3. Applicant Information

Company: eSky wireless Inc.
Address: A311#,258,Road Ren'ai Suzhou 215021
PR.China

1.4. Manufacturer Information

Company: ASIATELCO TECHNOLOGIES CO.
Address: #289 BISHENG ROAD, BUILDING-8,3F,ZHANGJIANG HI-TECH PARK,
PUDONG, SHANGHAI 201204,
PR.CHINA

TA Technology (Shanghai) Co., Ltd.

Test Report

Report No.: RXA1502-0023EMC01R2

Page 6 of 20

1.5. Information of EUT

General information

Product MEID:	A100003230B9D6
Hardware Version:	P1
Software Version:	1.1.67T
Antenna Type:	Internal Antenna
Ancillary equipment:	Lenovo X61
	USB cable

Ancillary equipment information

Equipment	Lenovo X61	USB cable
SN:	L3-D1224	/
Manufacturer:	Lenovo	/

Note: During the test the EUT is in USB mode.

1.6. Test Date

The test is performed from February 14, 2015 to February 17, 2015.

TA Technology (Shanghai) Co., Ltd.
Test Report

Report No.: RXA1502-0023EMC01R2

Page 7 of 20

2. Test Information

2.1. Summary of test results

Number	Test Case	Clause in FCC Rules	conclusion
1	Radiated Emission	15.109, ANSI C63.4-2009	PASS
2	Conducted Emission	15.107, ANSI C63.4-2009	PASS

TA Technology (Shanghai) Co., Ltd.

Test Report

2.2. Radiated Emission

Ambient condition

Temperature	Relative humidity	Pressure
24°C~26°C	45%~50%	102.5kPa

Methods of Measurement

The EUT is placed on a non-metallic table 0.8m above the horizontal metal reference ground plane. The distance between EUT and receive antenna should be 3 meters. During the test, the EUT was operating in its typical mode. The test method is according to ANSI C63.4-2009. Sweep the whole frequency band through the range from 30MHz to the 5th harmonic of the carrier. During the test, the height of receive antenna shall be moved from 1 to 4 meters, and the antenna shall be performed under horizontal and vertical polarization. The turn table shall be rotated from 0 to 360 degrees for detecting the maximum of radiated signal level. During the test, EUT is connected to a laptop via a USB cable in the case of USB mode. The EUT is used as the peripheral equipment of the PC. The model of laptop is Lenovo X61 and the serial number of laptop is L3-D1224.

The data is transferred from EUT to PC; PC is connected to server via a long LAN cable.

The data of cable loss and antenna factor has been calibrated in full testing frequency range before the testing.

Set the spectrum analyzer in the following:

Below 1GHz:

RBW=100kHz / VBW=300kHz / Sweep=AUTO

Above 1GHz:

(a) PEAK: RBW=1MHz VBW=3MHz/ Sweep=AUTO

(b) AVERAGE: RBW=1MHz / VBW=10Hz / Sweep=AUTO

TA Technology (Shanghai) Co., Ltd. Test Report

Report No.: RXA1502-0023EMC01R2

Page 9 of 20

Test Setup

Below 1GHz

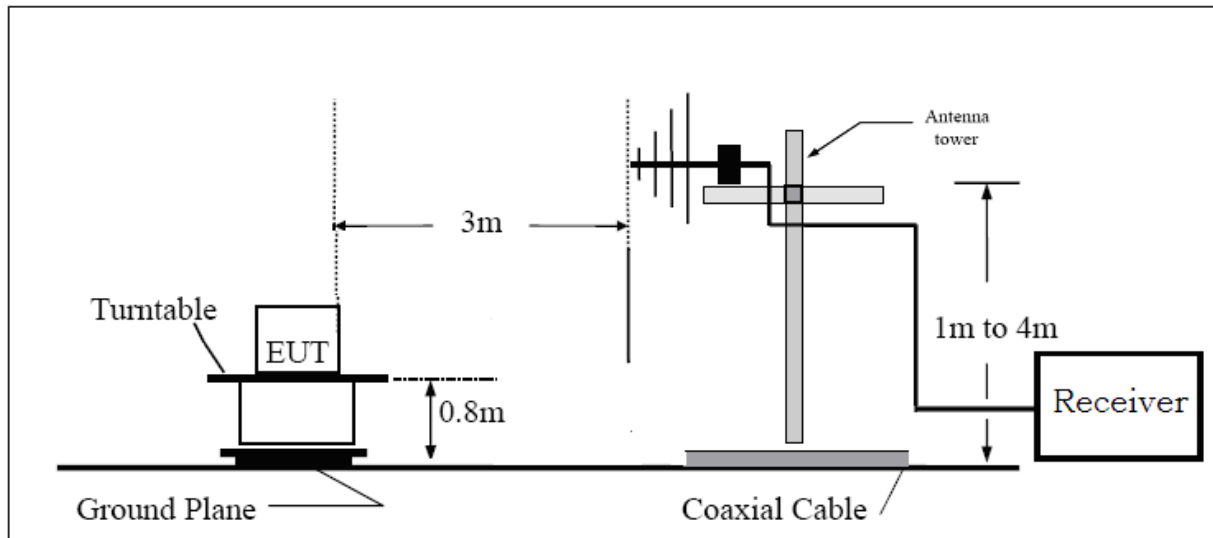

Above 1GHz

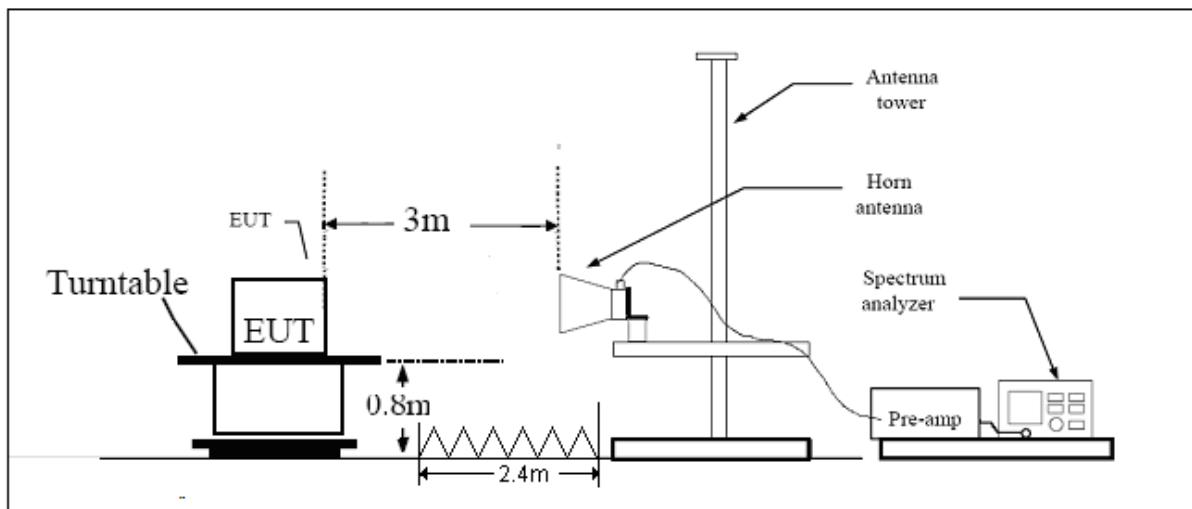

Note: Area side: 2.4mX3.6m

TA Technology (Shanghai) Co., Ltd.

Test Report

Report No.: RXA1502-0023EMC01R2

Page 10 of 20

Limits

Frequency (MHz)	Field Strength (dB μ V/m)	Detector
30 -88	40.0	Quasi-peak
88-216	43.5	Quasi-peak
216 – 960	46.0	Quasi-peak
960-1000	54.0	Quasi-peak
1000-5 th harmonic of the highest frequency or 40GHz, which is lower	54 74	Average Peak

Measurement Uncertainty

The assessed measurement uncertainty to ensure 95% confidence level for the normal distribution is with the coverage factor $k = 1.96$. $U = 3.92$ dB.

TA Technology (Shanghai) Co., Ltd. Test Report

Test Results

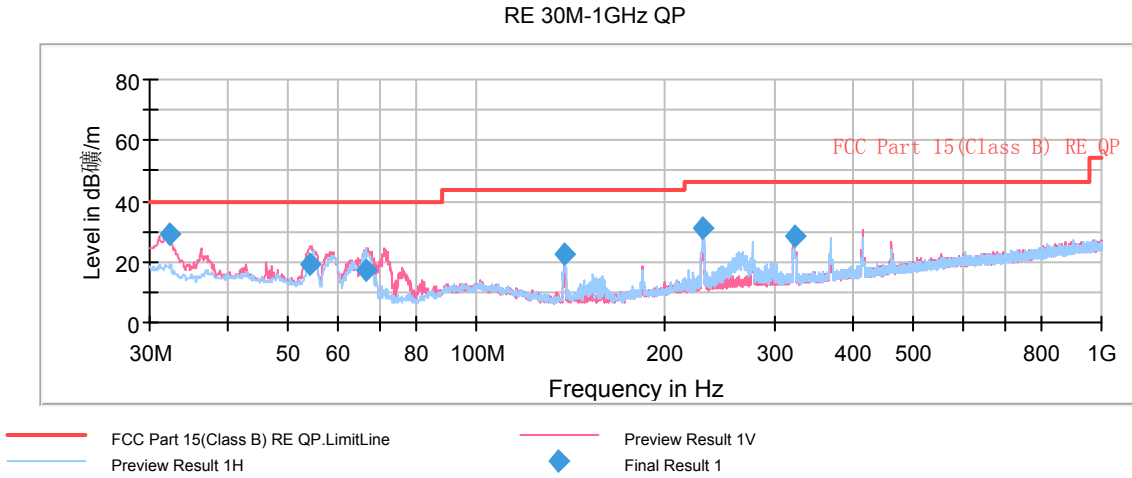

Radiated Emission from 30MHz to 1GHz

Frequency (MHz)	Quasi-Peak (dBuV/m)	Reading value (dBuV/m)	Height (cm)	Polarization	Azimuth (deg)	Correct Factor (dB)	Margin (dB)	Limit (dBuV/m)
32.383938	29.0	47.3	99.0	V	320.0	-18.3	11.0	40.0
54.194375	19.0	41.3	119.0	V	303.0	-22.3	21.0	40.0
66.784044	17.2	43.7	127.0	V	307.0	-26.5	22.8	40.0
138.331506	22.6	51.9	174.0	H	250.0	-29.3	20.9	43.5
230.612250	30.8	56.2	126.0	H	44.0	-25.4	15.2	46.0
322.889750	28.7	51.5	176.0	V	269.0	-22.8	17.3	46.0

- Remark:**
1. Quasi-Peak = Reading value + Correction factor
 2. Correction Factor = Antenna factor+ Insertion loss(cable loss+amplifier gain)
 3. Margin = Limit – Quasi-Peak

TA Technology (Shanghai) Co., Ltd. Test Report

Report No.: RXA1502-0023EMC01R2

Page 12 of 20

RE 1G-3GHz PK+AV

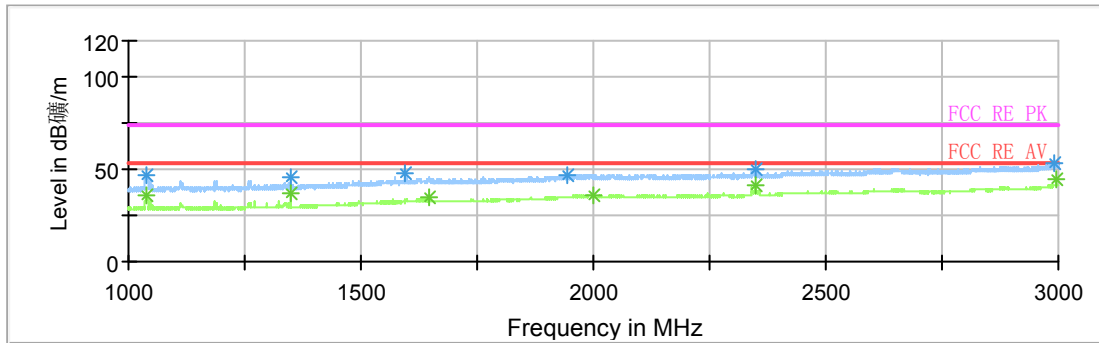

- FCC RE AV.LimitLine
— Preview Result 1
* Data Reduction Result 1 [2]
- FCC RE PK.LimitLine
— Preview Result 2
* Data Reduction Result 2 [2]

Radiated Emission from 1GHz to 3GHz

Frequency (MHz)	Peak (dBuV/m)	Reading value (dBuV/m)	Height (cm)	Polarization	Azimuth (deg)	Correct Factor (dB)	Margin (dB)	Limit (dBuV/m)
1038.250000	45.9	55.8	201.0	V	249.0	-9.9	28.1	74
1347.500000	44.1	53.0	101.0	V	348.0	-8.9	29.9	74
1646.500000	45.3	50.7	101.0	V	185.0	-5.4	28.7	74
1999.000000	44.9	47.9	201.0	V	207.0	-3.0	29.1	74
2350.000000	49.4	51.6	101.0	V	192.0	-2.2	24.6	74
2994.750000	51.2	52.6	101.0	V	245.0	1.4	22.8	74

Frequency (MHz)	Average (dBuV/m)	Reading value (dBuV/m)	Height (cm)	Polarization	Azimuth (deg)	Correct Factor (dB)	Margin (dB)	Limit (dBuV/m)
1038.250000	36.4	46.3	201.0	V	249.0	-9.9	17.6	54
1347.500000	37.3	46.2	101.0	V	348.0	-8.9	16.7	54
1646.500000	35.3	40.7	101.0	V	185.0	-5.4	18.7	54
1999.000000	36.0	39.0	201.0	V	207.0	-3.0	18.0	54
2350.000000	41.6	43.8	101.0	V	192.0	-2.2	12.4	54
2994.750000	44.7	46.1	101.0	V	245.0	1.4	9.3	54

TA Technology (Shanghai) Co., Ltd. Test Report

Report No.: RXA1502-0023EMC01R2

Page 13 of 20

RE 3-18GHz PK+AV

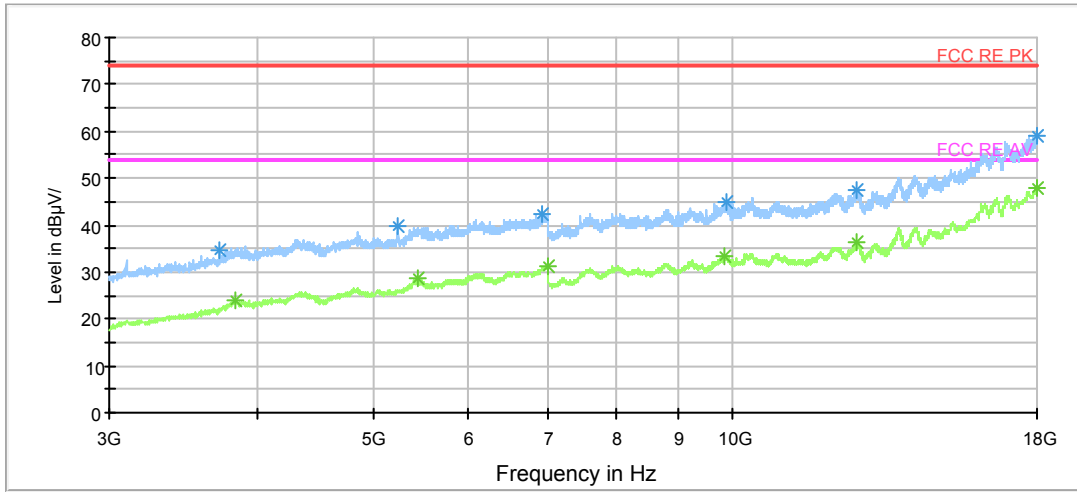

— FCC RE PK.LimitLine — FCC RE AV.LimitLine — Preview Result 1
— Preview Result 2 * Data Reduction Result 1 [1] * Data Reduction Result 2 [1]

Radiated Emission from 3GHz to 18GHz

Frequency (MHz)	Peak (dBuV/m)	Reading value (dBuV/m)	Height (cm)	Polarization	Azimuth (deg)	Correct Factor (dB)	Margin (dB)	Limit (dBuV/m)
3823.125000	33.0	33.1	99.0	H	173.0	-0.1	41.0	74
5450.625000	37.7	40.5	199.0	H	208.0	2.8	36.3	74
6991.875000	41.0	46.0	99.0	H	236.0	5.0	33.0	74
9849.375000	43.6	53.4	99.0	H	0.0	9.8	30.4	74
12723.750000	45.7	58.3	401.0	H	245.0	12.6	28.3	74
17988.750000	57.5	81.0	299.0	H	23.0	23.5	16.5	74

Frequency (MHz)	Average (dBuV/m)	Reading value (dBuV/m)	Height (cm)	Polarization	Azimuth (deg)	Correct Factor (dB)	Margin (dB)	Limit (dBuV/m)
3823.125000	23.9	24.0	99.0	H	173.0	-0.1	30.1	54
5450.625000	28.6	31.4	199.0	H	208.0	2.8	25.4	54
6991.875000	31.4	36.4	99.0	H	236.0	5.0	22.6	54
9849.375000	33.4	43.2	99.0	H	0.0	9.8	20.6	54
12723.750000	36.2	48.8	401.0	H	245.0	12.6	17.8	54
17988.750000	47.7	71.2	299.0	H	23.0	23.5	6.3	54

TA Technology (Shanghai) Co., Ltd.

Test Report

Report No.: RXA1502-0023EMC01R2

Page 14 of 20

2.3. Conducted Emission

Ambient condition

Temperature	Relative humidity	Pressure
24°C ~26°C	50%~55%	102.5kPa

Methods of Measurement

The EUT is placed on a non-metallic table of 80cm height above the horizontal metal reference ground plane. During the test, the EUT was operating in its typical mode. The test method is according to ANSI C63.4-2009. Connect the AC power line of the EUT to the L.I.S.N. Use EMI receiver to detect the average and Quasi-peak value. RBW is set to 9 kHz, VBW is set to 30kHz. The measurement result should include both L line and N line. During the test, EUT is connected to a laptop via a USB cable in the case of USB mode. The EUT is used as the peripheral equipment of the PC. The model of laptop is Lenovo X61 and the serial number of laptop is L3-D1224.

The data is transferred from EUT to PC; PC is connected to server via a long LAN cable.

Test Setup

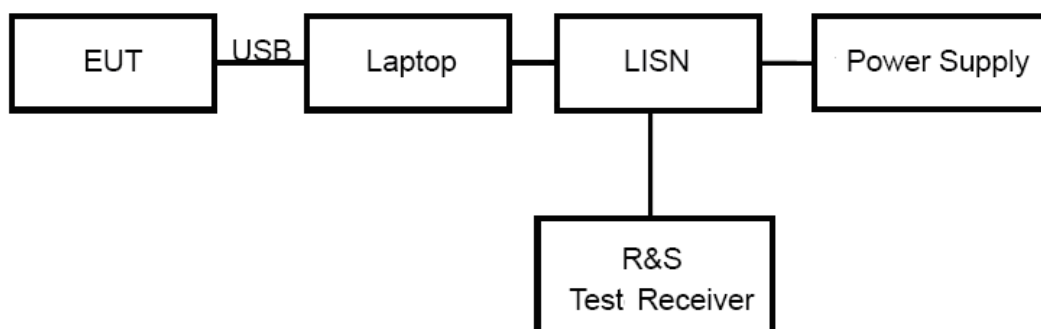

Note: Power Supply is AC Power source and it is used to change the voltage to 120V/60Hz. The EUT power is supplied by PC via the usb cable.

Limits

Frequency (MHz)	Conducted Limits(dB μ V)	
	Quasi-peak	Average
0.15 - 0.5	66 to 56 *	56 to 46 *
0.5 - 5	56	46
5 - 30	60	50

*: Decreases with the logarithm of the frequency.

Measurement Uncertainty

The assessed measurement uncertainty to ensure 95% confidence level for the normal distribution is with the coverage factor $k = 1.96$. $U = 2.69$ dB.

TA Technology (Shanghai) Co., Ltd. Test Report

Report No.: RXA1502-0023EMC01R2

Page 15 of 20

Test Results

USB Mode

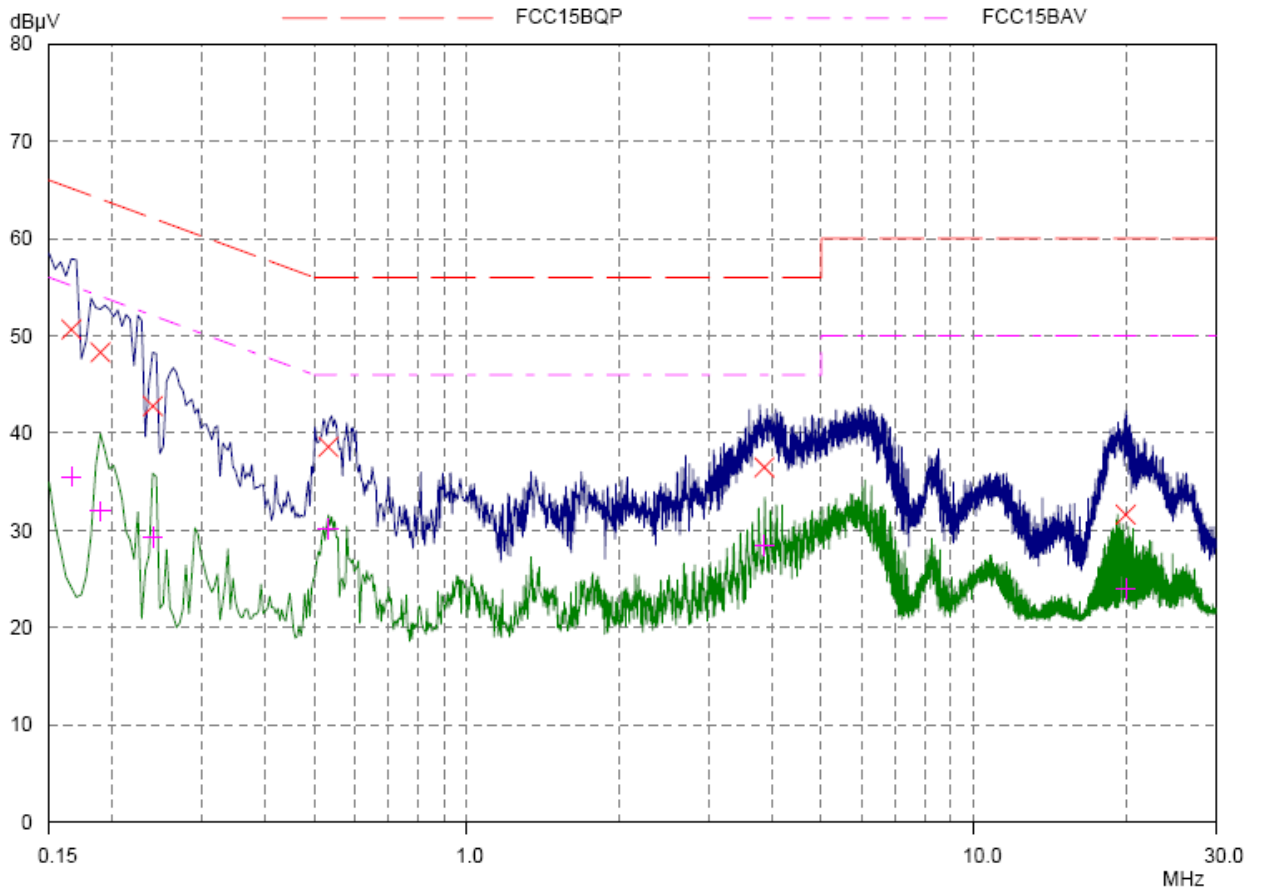

Final Measurement Results

Frequency MHz	QP Level dBµV	QP Limit dBµV	QP Delta dB	Phase -	PE -
0.16562	50.66	65.18	14.52	L1	gnd
0.18906	48.30	64.08	15.78	L1	gnd
0.23984	42.78	62.10	19.32	L1	gnd
0.53281	38.59	56.00	17.41	L1	gnd
3.86093	36.48	56.00	19.52	L1	gnd
19.94296	31.62	60.00	28.38	L1	gnd

Frequency MHz	AV Level dBµV	AV Limit dBµV	AV Delta dB	Phase -	PE -
0.16562	35.50	55.18	19.68	L1	gnd
0.18906	31.98	54.08	22.10	L1	gnd
0.23984	29.28	52.10	22.82	L1	gnd
0.53281	30.19	46.00	15.81	L1	gnd
3.86093	28.43	46.00	17.57	L1	gnd
19.94296	24.01	50.00	25.99	L1	gnd

Conducted Emission ES710_L_USB_0.15-30MHz

TA Technology (Shanghai) Co., Ltd. Test Report

Report No.: RXA1502-0023EMC01R2

Page 16 of 20

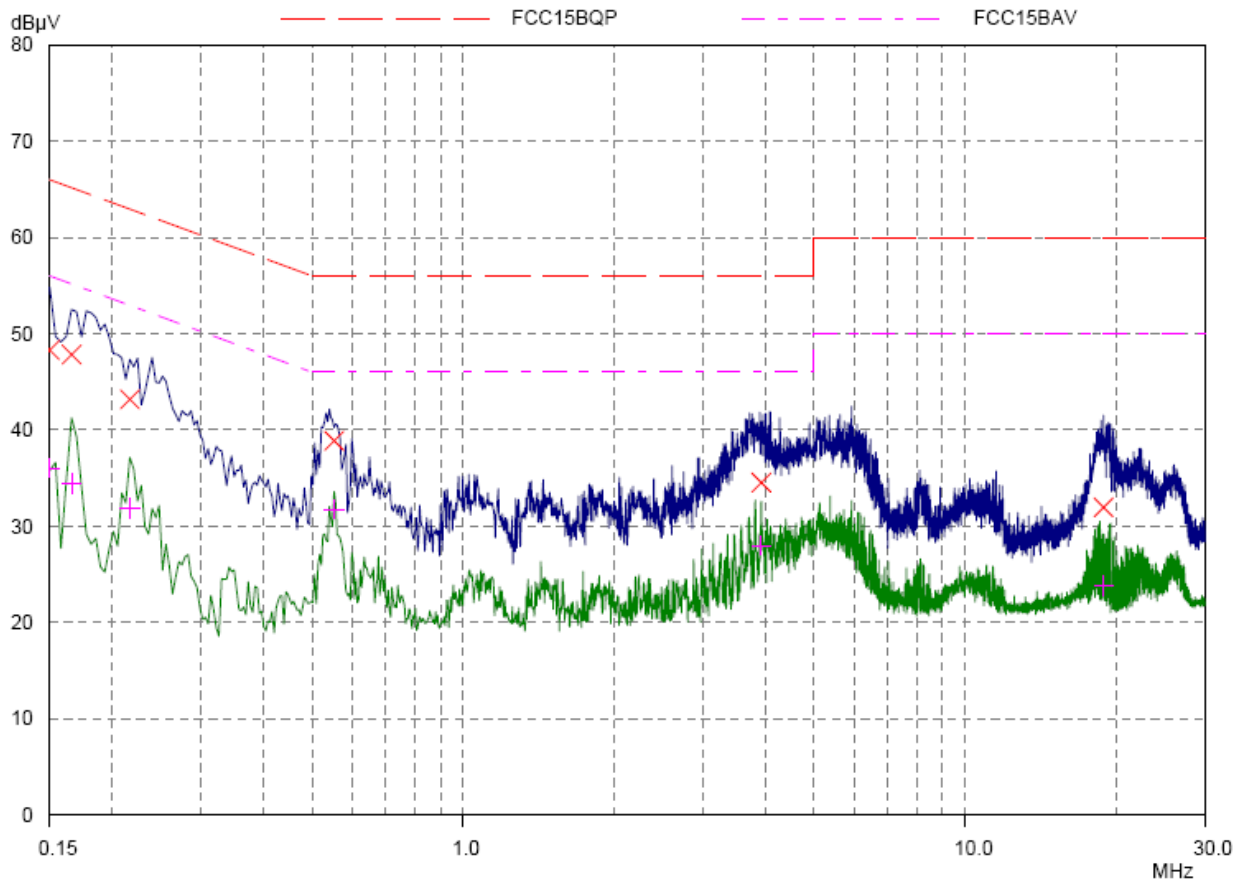

Final Measurement Results

Frequency MHz	QP Level dBµV	QP Limit dBµV	QP Delta dB	Phase -	PE -
0.15	48.30	66.00	17.70	N	gnd
0.16562	47.84	65.18	17.34	N	gnd
0.2164	43.17	62.96	19.79	N	gnd
0.55234	38.87	56.00	17.13	N	gnd
3.92343	34.53	56.00	21.47	N	gnd
18.86093	31.96	60.00	28.04	N	gnd

Frequency MHz	AV Level dBµV	AV Limit dBµV	AV Delta dB	Phase -	PE -
0.15	36.05	56.00	19.95	N	gnd
0.16562	34.44	55.18	20.74	N	gnd
0.2164	31.85	52.96	21.11	N	gnd
0.55234	31.75	46.00	14.25	N	gnd
3.92343	28.00	46.00	18.00	N	gnd
18.86093	23.80	50.00	26.20	N	gnd

Conducted Emission ES710_N_USB_0.15-30MHz

TA Technology (Shanghai) Co., Ltd.
Test Report

Report No.: RXA1502-0023EMC01R2

Page 17 of 20

3. Main Test Instruments

No.	Name	Type	Manufacturer	Serial Number	Calibration Date	Expiration Time	Valid Period
01	EMI Test Receiver	ESCI	R&S	100948	2014-06-29	2015-06-28	1year
02	Trilog Antenna	VULB 9163	SCHWARZBECK	9163-201	2013-06-19	2016-06-18	3years
03	Signal Analyzer	FSV30	R&S	100815	2014-06-29	2015-06-28	1year
04	Horn Antenna	HF907	R&S	100126	2012-07-01	2015-06-30	3years
05	Horn Antenna	3160-09	ETS-Lindgren	00102643	2012-07-01	2015-06-30	3years
06	EMI Test Receiver	ESCS30	R&S	100138	2015-01-14	2016-01-13	1year
07	LISN	ENV216	R&S	101171	2014-04-13	2015-04-12	1year
08	RF cable	SF104-11N-11 N-1200mm	HUBER+SUHNER	CE-01	2014-11-20	2015-11-19	1year
09	RF cable	SF106A-11N-1 1N-8000mm	HUBER+SUHNER	RE-01	2014-12-15	2015-12-14	1year

*****END OF REPORT *****

TA Technology (Shanghai) Co., Ltd.
Test Report

Report No.: RXA1502-0023EMC01R2

Page 18 of 20

ANNEX A: The EUT Appearance and Test Setup

A.1 EUT Appearance



a: EUT

Picture 1 EUT

**TA Technology (Shanghai) Co., Ltd.
Test Report**

Report No.: RXA1502-0023EMC01R2

Page 19 of 20

A.2 Test Setup



a: Below 1GHz



b: Above 1GHz

Picture 2 Radiated Emission Test Setup

TA Technology (Shanghai) Co., Ltd.
Test Report

Report No.: RXA1502-0023EMC01R2

Page 20 of 20



Picture 3 Conducted Emission Test Setup