



TEST REPORT

According to

FCC 47 CFR PART 22 SUBPART H AND PART 24 SUBPART E Industry Canada RSS-132, Issue 3 / Industry Canada RSS-133, Issue 6

Applicant	: eSky Wireless Inc.
Address	: 22-303,328 Xinghu Street,Suzhou,China
Manufacturer	: eSky Wireless Inc.
Address	: 22-303,328 Xinghu Street,Suzhou,China
Equipment	: GPS Tracker
Model No.	: ES310
Trade Name	: eSky
FCC ID	: YR8ES310
IC	: 20052-ES310

- The test result refers exclusively to the test presented test model / sample.
- Without written approval of **CerpPASS Technology Corp.** the test report shall not be reproduced except in full.
- The test report must not be used by the clients to claim product certification approval by **NVLAP** or any agency of the Government.



Table of Contents

1. Report of Measurements and Examinations	6
2. Test Configuration of Equipment under Test	7
2.1. Feature of Equipment under Test	7
2.2. Test Manner	8
2.3. Description of Test System	8
2.4. General Information of Test	9
2.5. Measurement Uncertainty	9
3. Test of Conducted Emission	10
3.1. Test Limit.....	10
3.2. Test Procedures.....	10
3.3. Typical Test Setup.....	10
3.4. Measurement Equipment	11
3.5. Test Result and Data	12
4. FIELD STRENGTH OF SPURIOUS RADIATION MEASUREMENT	14
4.1. Test Limit.....	14
4.2. Test Procedures.....	14
4.3. Typical Test Setup.....	15
4.4. Measurement Equipment	16
4.5. Test Result and Data	17
5. Occupied Bandwidth.....	41
5.1. Test Limit.....	41
5.2. Test Procedures.....	41
5.3. Test Setup Layout.....	41
5.4. Measurement Equipment	41
5.5. Test Result and Data	42
6. Maximum Peak Output Power	50
6.1. Test Limit.....	50
6.2. Test Procedure.....	50
6.3. Test Setup Layout.....	50
6.4. Measurement Equipment	50
6.5. Test Result and Data	51
7. ERP & EIRP MEASUREMENT	59
7.1. Test Limit.....	59
7.2. Test Procedure.....	59
7.3. Test Setup Layout.....	60
7.4. Measurement Equipment	61
7.5. Test Result and Data	62
8. OUT OF BAND EMISSION AT ANTENNA TERMINALS.....	64
8.1. Test Limit.....	64
8.2. Test Procedure.....	64
8.3. Test Setup Layout.....	64
8.4. Measurement Equipment	64



8.5. Test Result and Data 65

9. FREQUENCY STABILITY V.S. TEMPERATURE MEASUREMENT 77

9.1. Test Limit..... 77

9.2. Test Procedure..... 77

9.3. Test Setup Layout 77

9.4. Measurement Equipment 77

9.5. Test Result and Data 78

10. FREQUENCY STABILITY V.S. VOLTAGE MEASUREMENT 80

10.1. Test Limit..... 80

10.2. Test Procedure..... 80

10.3. Test Setup Layout 80

10.4. Measurement Equipment 80

10.5. Test Result and Data 81

11. Receiver Spurious Emission for RSS 132/133 83

11.1. Test Equipment..... 83

11.2. Test Setup 83

11.3. Limit 84

11.4. Test Procedure..... 84

11.5. Test Result 86



TEST REPORT

according to

FCC 47 CFR PART 22 SUBPART H AND PART 24 SUBPART E Industry Canada RSS-132, Issue 3 / Industry Canada RSS-133, Issue 6

Applicant	: eSky Wireless Inc.
Address	: 22-303,328 Xinghu Street,Suzhou,China
Manufacturer	: eSky Wireless Inc.
Address	: 22-303,328 Xinghu Street,Suzhou,China
Equipment	: GPS Tracker
Model No.	: ES310
Trade Name	: eSky
FCC ID	: YR8ES310
IC	: 20052-ES310

I HEREBY CERTIFY THAT :

The measurements shown in this test report were made in accordance with the procedures given in **ANSI C63.4 – 2009** and **TIA/EIA 603** and the energy emitted by this equipment was **passed** **FCC Rule FCC PART 22 Subpart H and PART 24 Subpart E** in both radiated and conducted emission limits.

Testing was carried out on May 23, 2014 at **CerpPASS Technology Corp.**

Signature

Miro Chueh/ Technical director



1. Report of Measurements and Examinations

FCC 47 CFR PART 22 SUBPART H AND PART 24 SUBPART E ANSI C63.4: 2009, TIA/EIA 603 and RSS GEN, RSS-133		
Test Parameter	Test Performed	Remark
Conducted Emission	YES	PASS
Field Strength of Spurious Radiation Measurement	YES	PASS
Occupied Bandwidth	YES	PASS
Maximum Peak Output Power	YES	PASS
ERP & EIRP Measurement	YES	PASS
Out of Band Emission at Antenna Terminals	YES	PASS
Frequency Stability V.S. Temperature Measurement	YES	PASS
Requency Stability V.S. Voltage Measurement	YES	PASS



2. Test Configuration of Equipment under Test

2.1. Feature of Equipment under Test

ES310	Model No:	ES310
Operation Frequency Range	GSM /GPRS/EDGE 850:824.2MHz-848.8MHz GSM /GPRS/EDGE 1900:1850.2MHz-1909.8MHz	
Battery	Rated Voltage&Cap.	3.7V 400mAh



2.2. Test Manner

Test Manner	
a	During testing, the interface cables and equipment positions were varied according to 47 CFR, Part 2, PART 22 Subpart H and PART 24 Subpart E.
b	Adjust the EUT at the test mode and the test channel. Then test.
The test modes:	
<p>The EUT had been tested under operating condition.</p> <p>After verification, all tests were carried out with the worst case test modes as shown below except radiated spurious emission below 1GHz and power line conducted emissions below 30MHz, which worst case was in normal link mode only.</p> <p>EUT staying in continuous transmitting mode was programmed.</p> <p>GSM 850: Channel Low (CH128), Channel Mid (CH190) and Channel High (CH251) were chosen for full testing.</p> <p>GSM 1900: Channel Low (CH512), Channel Mid (CH661) and Channel High (CH810) were chosen for full testing.</p> <p>EDGE 850: Channel Low (CH128), Channel Mid (CH190) and Channel High (CH251) were chosen for full testing.</p> <p>EDGE 1900: Channel Low (CH512), Channel Mid (CH661) and Channel High (CH810) were chosen for full testing.</p>	

2.3. Description of Test System

No.	Device	Manufacturer	Model No.	Description
1	N/A	N/A	N/A	N/A



2.4. General Information of Test

Test Site:	CerpPASS Technology Corp.
Performand Location :	No.66,Tangzhuang Road, Suzhou Industrial Park, Jiangsu 215006, China

Laboratory accreditation



2.5. Measurement Uncertainty

Measurement Item	Measurement Frequency	Polarization	Uncertainty
Conducted Emission	9 kHz ~ 30 MHz	LINE/NEUTRAL	±2.71 dB
Radiated Emission	30 MHz ~ 25GHz	Vertical	±4.11 dB
		Horizontal	±4.10 dB
Occupied Bandwidth	---	---	±7500 Hz
Maximum Peak Output Power	---	---	±1.4 dB
Band Edges	---	---	±2.2 dB
Power Spectral Density	---	---	±2.2 dB



3. Test of Conducted Emission

3.1. Test Limit

Conducted Emissions were measured from 150 kHz to 30 MHz with a bandwidth of 9 KHz on the 120 VAC power and return leads of the EUT according to the methods defined in ANSI C63.4-2003 Section 3.1. The EUT was placed on a nonmetallic stand in a shielded room 0.8 meters above the ground plane as shown in section 2.2. The interface cables and equipment positioning were varied within limits of reasonable applications to determine the position produced maximum conducted emissions.

Frequency (MHz)	Quasi Peak (dB μ V)	Average (dB μ V)
0.15 – 0.5	66-56*	56-46*
0.5 – 5.0	56	46
5.0 – 30.0	60	50

*Decreases with the logarithm of the frequency.

3.2. Test Procedures

1. The EUT was placed on a table, which is 0.8m above ground plane.
2. Maximum procedure was performed on the six highest emissions to ensure EUT compliance.
3. Repeat above procedures until all frequency measured were complete.

3.3. Typical Test Setup

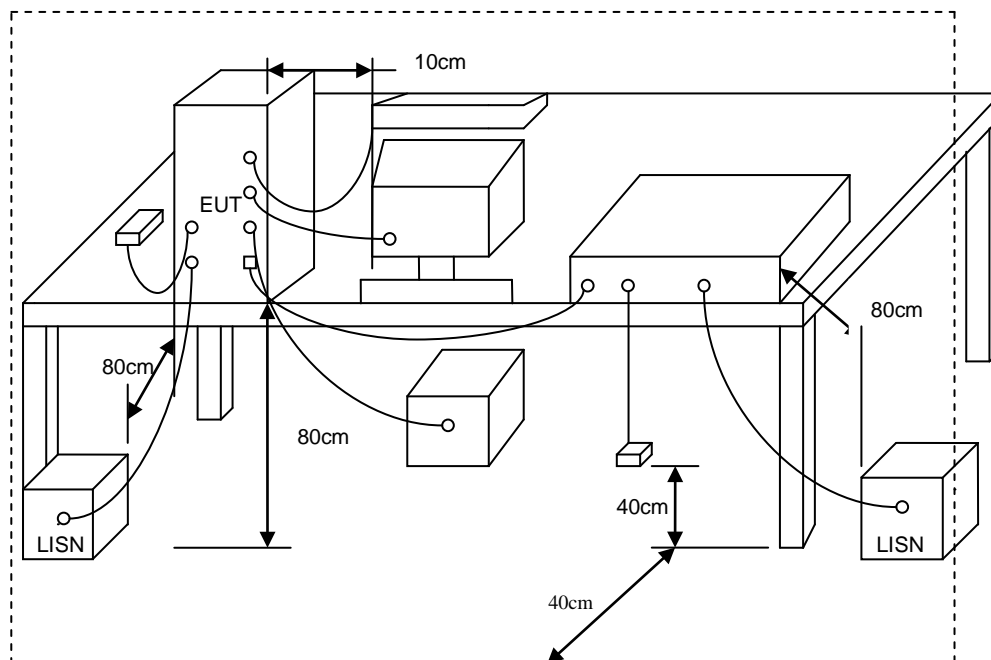

**3.4. Measurement Equipment**

Instrument/Ancillary	Manufacturer	Model No.	Serial No.	Calibration Date	Valid Date.
Test Receiver	R&S	ESCI	100565	2014.03.24	2015.03.23
AMN	R&S	ESH2-Z5	100182	2014.09.04	2015.09.03
Two-Line V-Network	R&S	ENV216	100325	2014.12.04	2015.12.05
ISN	FCC	FCC-TLISN-T2-02	20379	2014.03.24	2015.03.23
ISN	FCC	FCC-TLISN-T4-02	20380	2014.03.24	2015.03.23
ISN	FCC	FCC-TLISN-T8-02	20381	2014.03.24	2015.03.23
ISN	TESEQ	ISN ST08	30175	2014.03.24	2015.03.23
Current Probe	R&S	EZ-17	100303	2014.04.04	2015.04.03
Passive Voltage Probe	R&S	ESH2-Z3	100026	2014.03.24	2015.03.23
Pulse Limiter	R&S	ESH3-Z2	100529	2014.03.24	2015.03.23
Temperature/ Humidity Meter	Zhicheng	ZC1-11	CEP-TH-004	2014.03.31	2015.03.30



3.5. Test Result and Data

Test Mode :	Normal Link	Phase :	Line
Temperature :	20°C	Humidity:	51%
Pressur(mbar) :	1002	Date:	2015-02-23

No.	Frequency (MHz)	Factor (dB)	Reading (dBuV)	Level (dBuV)	Limit (dBuV)	Margin (dB)	Detector
1	0.1500	10.13	28.34	38.47	65.99	-27.52	QP
2	0.1500	10.13	13.00	23.13	55.99	-32.86	AVG
3	0.4420	10.15	27.37	37.52	57.02	-19.50	QP
4	0.4420	10.15	19.87	30.02	47.02	-17.00	AVG
5	0.4540	10.16	24.67	34.83	56.80	-21.97	QP
6	0.4540	10.16	16.51	26.67	46.80	-20.13	AVG
7	0.4900	10.16	17.04	27.20	56.17	-28.97	QP
8	0.4900	10.16	10.42	20.58	46.17	-25.59	AVG
9	0.8940	10.15	16.82	26.97	56.00	-29.03	QP
10	0.8940	10.15	9.37	19.52	46.00	-26.48	AVG
11	1.9380	10.17	9.48	19.65	56.00	-36.35	QP
12	1.9380	10.17	4.97	15.14	46.00	-30.86	AVG

Note: Measurement Level = Reading Level + Correct Factor



Test Mode :	Normal Link	Phase :	Neutral
Temperature :	20°C	Humidity :	51%
Pressur(mbar) :	1002	Date :	2015-02-23

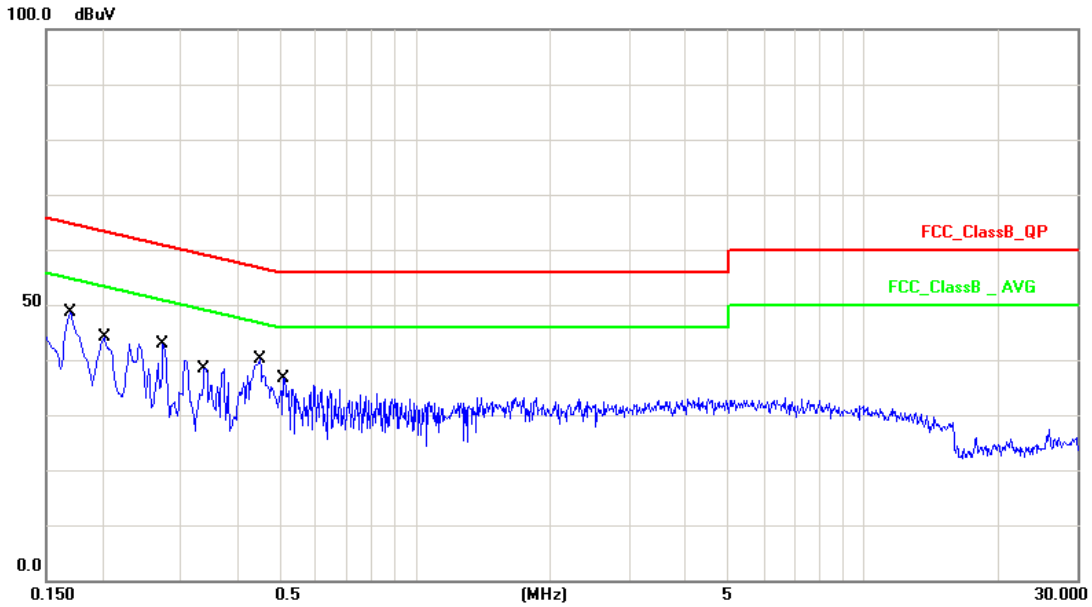

No.	Frequency (MHz)	Factor (dB)	Reading (dBuV)	Level (dBuV)	Limit (dBuV)	Margin (dB)	Detector
1	0.1700	10.13	28.65	38.78	64.96	-26.18	QP
2	0.1700	10.13	12.28	22.41	54.96	-32.55	AVG
3	0.2020	10.13	23.98	34.11	63.52	-29.41	QP
4	0.2020	10.13	7.58	17.71	53.52	-35.81	AVG
5	0.2740	10.13	15.65	25.78	60.99	-35.21	QP
6	0.2740	10.13	1.92	12.05	50.99	-38.94	AVG
7	0.3379	10.14	16.00	26.14	59.25	-33.11	QP
8	0.3379	10.14	3.12	13.26	49.25	-35.99	AVG
9	0.4500	10.15	22.15	32.30	56.87	-24.57	QP
10	0.4500	10.15	10.76	20.91	46.87	-25.96	AVG
11	0.5100	10.15	13.56	23.71	56.00	-32.29	QP
12	0.5100	10.15	2.31	12.46	46.00	-33.54	AVG

Note: Measurement Level = Reading Level + Correct Factor



4. FIELD STRENGTH OF SPURIOUS RADIATION MEASUREMENT

4.1. Test Limit

The power of any emission outside of the authorized operating frequency ranges must be attenuated below the transmitting power (P) by a factor of at least $43 + 10\log(P)$ dB.

It is measured by means of a calibrated spectrum analyzer and scanned from 30 MHz up to a frequency including its 10th harmonic.

4.2. Test Procedures

Final radiation measurements were made on a three-meter, Semi Anechoic Chamber. The EUT system was placed on a nonconductive turntable which is 0.8 meters height, top surface 1.0 x 1.5 meter. The spectrum was examined from 250 MHz to 2.5 GHz in order to cover the whole spectrum below 10th harmonic which could generate from the EUT. During the test, EUT was set to transmit continuously & Measurements spectrum range from 30 MHz to 26.5 GHz is investigated. For measurements below 1 GHz the resolution bandwidth is set to 100 kHz for peak detection measurements or 120 kHz for quasi-peak detection measurements. Peak detection is used unless otherwise noted as quasi-peak. For measurements above 1 GHz the resolution bandwidth is set to 1 MHz, and then the video bandwidth is set to 1 MHz for peak measurements and 10 Hz for average measurements. A nonconductive material surrounded the EUT to supporting the EUT for standing on three orthogonal planes. At each condition, the EUT was rotated 360 degrees, and the antenna was raised and lowered from one to four meters to find the maximum emission levels. Measurements were taken using both horizontal and vertical antenna polarization.

For testing above 1GHz, the emission level of the EUT in peak mode was 20dB lower than average limit (that means the emission level in peak mode also complies with the limit in average mode), then testing will be stopped and peak values of EUT will be reported, otherwise, the emissions will be measured in average mode again and reported.

Appropriate preamplifiers were used for improving sensitivity and precautions were taken to avoid overloading or desensitizing the spectrum analyzer. No post – detector video filters were used in the test. The spectrum analyzer's 6 dB bandwidth was set to 1 MHz, and the analyzer was operated in the peak detection mode, for frequencies both below and up 1 GHz. The average levels were obtained by subtracting the duty cycle correction factor from the peak readings.

The following procedures were used to convert the emission levels measured in decibels referenced to 1 microvolt (dBuV) into field intensity in micro volts pre meter (uV/m).



The actual field intensity in decibels referenced to 1 microvolt in to field intensity in micro volts per meter (dBuV/m).The actual field is intensity in referenced to 1 microvolt per meter (dBuV/m) is determined by algebraically adding the measured reading in dBuV, the antenna factor (dB), and cable loss (dB) and Subtracting the gain of preamplifier (dB) is auto calculate in spectrum analyzer.

$$(1) \text{ Amplitude (dBuV/m)} = \text{FI (dBuV)} + \text{AF (dBuV)} + \text{CL (dBuV)} - \text{Gain (dB)}$$

FI= Reading of the field intensity.

AF= Antenna factor.

CL= Cable loss.

P.S Amplitude is auto calculate in spectrum analyzer.

$$(2) \text{ Actual Amplitude (dBuV/m)} = \text{Amplitude (dBuV)} - \text{Dis(dB)}$$

The FCC specified emission limits were calculated according the EUT operating frequency and by following linear interpolation equations:

(a) For fundamental frequency : Transmitter Output < +30dBm

(b) For spurious frequency : Spurious emission limits = fundamental emission limit /10

4.3. Typical Test Setup

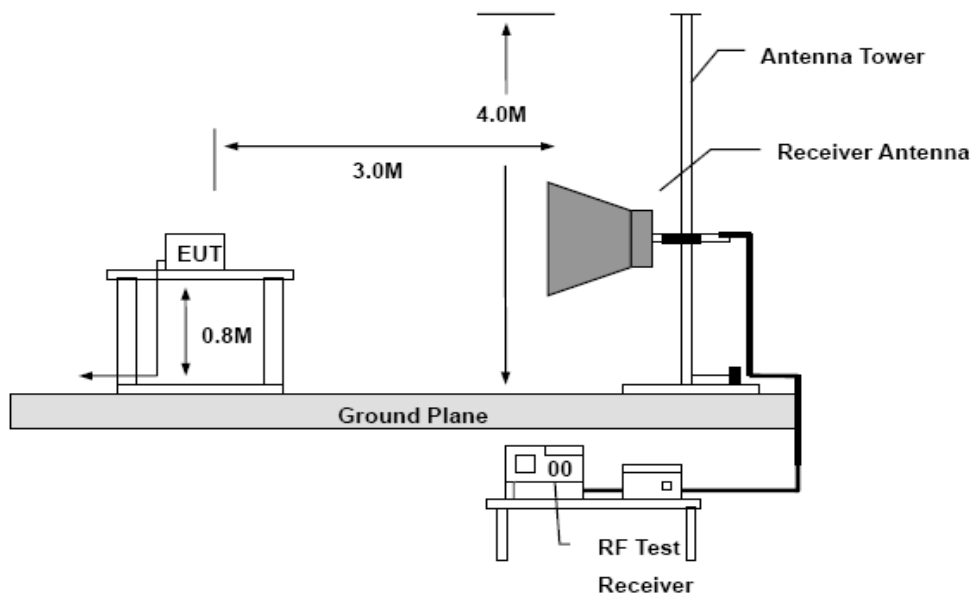

**4.4. Measurement Equipment**

Instrument	Model No.	Manufacturer	Serial No.	Calibration Date	Valid Date.
EMI Test Receiver	R&S	ESCI	100563	2014.03.24	2015.03.23
H64 Preamplifier	HP	8447F	3113A05582	2014.03.24	2015.03.23
Preamplifier	Agilent	8449B	3008A02342	2014.03.24	2015.03.23
Ultra Broadband Antenna	R&S	HL562	100362	2014.05.24	2015.05.23
Broad-Band Horn Antenna	Schwarzbeck	BBHA9120D	9120D-619	2014.05.24	2015.05.23
Broad-Band Horn Antenna	Schwarzbeck	BBHA9170	9170-348	2014.05.24	2015.05.23
Spectrum Analyzer	R&S	FSP40	100324	2014.03.23	2015.03.24
Temperature/ Humidity Meter	Zhicheng	ZC1-11	CEP-TH-002	2014.03.31	2015.03.30



4.5. Test Result and Data

Radiated Spurious Emission Measurement Result:

Engineer : Kerry	Time : 2015-02-23
Site : EMC Lab AC 102	Margin : 6
Limit : FCC_Part22&24 and RSS 133 Clause 6.5&6.6	Probe : VERTICAL/ HORIZONTAL
EUT : ES310	Note : GSM 850 / CH 128

Frequency (MHz)	Antenna Polarization	Antenna Terminals leve (dBm)	Substitution Antenna Gain (dBd)	Emission level (dBm)	Limit (dBm)	Margin (dB)
38.28	V	-16.17	-11.29	-27.46	-13.00	-14.46
108.16	V	-12.50	-13.44	-25.94	-13.00	-12.94
114.39	V	-13.32	-13.78	-27.10	-13.00	-14.10
130.67	V	-15.74	-14.15	-29.89	-13.00	-16.89
141.09	V	-14.96	-14.47	-29.43	-13.00	-16.43
829.33	V	-27.15	1.87	-25.28	-13.00	-12.28
75.96	H	-12.33	-16.63	-28.96	-13.00	-15.96
85.52	H	-13.08	-15.27	-28.35	-13.00	-15.35
109.17	H	-12.74	-14.25	-26.99	-13.00	-13.99
125.46	H	-11.15	-14.15	-25.30	-13.00	-12.30
312.85	H	-15.96	-9.74	-25.70	-13.00	-12.70
896.38	H	-23.77	-2.44	-26.21	-13.00	-13.21



Engineer : Kerry	Time : 2015-02-23
Site : EMC Lab AC 102	Margin : 6
Limit : FCC_ Part22&24 and RSS 133 Clause 6.5&6.6	Probe : VERTICAL/ HORIZONTAL
EUT : ES310	Note : GSM 850 / CH 190

Frequency (MHz)	Antenna Polarization	Antenna Terminals leve (dBm)	Substitution Antenna Gain (dBd)	Emission level (dBm)	Limit (dBm)	Margin (dB)
37.28	V	-13.32	-11.29	-24.61	-13.00	-11.61
110.95	V	-11.06	-13.44	-24.50	-13.00	-11.50
115.36	V	-12.74	-13.78	-26.52	-13.00	-13.52
131.77	V	-12.62	-14.15	-26.77	-13.00	-13.77
141.19	V	-13.15	-14.47	-27.62	-13.00	-14.62
829.63	V	-26.74	1.87	-24.87	-13.00	-11.87
74.46	H	-12.18	-16.63	-28.81	-13.00	-15.81
86.11	H	-13.96	-15.27	-29.23	-13.00	-16.23
110.19	H	-12.08	-14.25	-26.33	-13.00	-13.33
128.07	H	-12.75	-14.15	-26.90	-13.00	-13.90
314.29	H	-15.33	-9.74	-25.07	-13.00	-12.07
899.71	H	-24.85	-2.44	-27.29	-13.00	-14.29



Engineer : Kerry	Time : 2015-02-23
Site : EMC Lab AC 102	Margin : 6
Limit : FCC_ Part22&24 and RSS 133 Clause 6.5&6.6	Probe : VERTICAL/ HORIZONTAL
EUT : ES310	Note : GSM 850 / CH 251

Frequency (MHz)	Antenna Polarization	Antenna Terminals level (dBm)	Substitution Antenna Gain (dBd)	Emission level (dBm)	Limit (dBm)	Margin (dB)
39.63	V	-11.62	-11.29	-22.91	-13.00	-9.91
107.19	V	-13.74	-13.44	-27.18	-13.00	-14.18
110.58	V	-12.25	-13.78	-26.03	-13.00	-13.03
127.67	V	-12.18	-14.15	-26.33	-13.00	-13.33
136.30	V	-13.36	-14.47	-27.83	-13.00	-14.83
828.12	V	-27.52	1.87	-25.65	-13.00	-12.65
74.28	H	-12.63	-16.63	-29.26	-13.00	-16.26
86.32	H	-12.85	-15.27	-28.12	-13.00	-15.12
108.90	H	-11.29	-14.25	-25.54	-13.00	-12.54
127.16	H	-12.28	-14.15	-26.43	-13.00	-13.43
311.29	H	-15.17	-9.74	-24.91	-13.00	-11.91
895.08	H	-22.10	-2.18	-24.28	-13.00	-11.28



Engineer : Kerry	Time : 2015-02-23
Site : EMC Lab AC 102	Margin : 6
Limit : FCC_ Part22&24 and RSS 133 Clause 6.5&6.6	Probe : VERTICAL/ HORIZONTAL
EUT : ES310	Note : GSM 1900 / CH 512

Frequency (MHz)	Antenna Polarization	Antenna Terminals leve (dBm)	Substitution Antenna Gain (dBd)	Emission level (dBm)	Limit (dBm)	Margin (dB)
38.25	V	-12.74	-11.01	-23.75	-13.00	-10.75
107.39	V	-11.16	-13.44	-24.60	-13.00	-11.60
117.85	V	-12.52	-13.65	-26.17	-13.00	-13.17
127.36	V	-12.18	-14.15	-26.33	-13.00	-13.33
136.85	V	-11.96	-14.47	-26.43	-13.00	-13.43
830.18	V	-26.65	1.87	-24.78	-13.00	-11.78
75.09	H	-12.15	-16.63	-28.78	-13.00	-15.78
84.50	H	-11.33	-15.27	-26.60	-13.00	-13.60
107.31	H	-13.20	-14.25	-27.45	-13.00	-14.45
128.67	H	-12.79	-14.15	-26.94	-13.00	-13.94
312.15	H	-13.85	-9.74	-23.59	-13.00	-10.59
897.89	H	-23.75	-2.44	-26.19	-13.00	-13.19



Engineer : Kerry	Time : 2015-02-23
Site : EMC Lab AC 102	Margin : 6
Limit : FCC_ Part22&24 and RSS 133 Clause 6.5&6.6	Probe : VERTICAL/ HORIZONTAL
EUT : ES310	Note : GSM 1900 / CH 661

Frequency (MHz)	Antenna Polarization	Antenna Terminals leve (dBm)	Substitution Antenna Gain (dBd)	Emission level (dBm)	Limit (dBm)	Margin (dB)
40.15	V	-12.65	-11.29	-23.94	-13.00	-10.94
107.28	V	-13.96	-11.47	-25.43	-13.00	-12.43
111.36	V	-12.08	-13.78	-25.86	-13.00	-12.86
128.17	V	-11.42	-14.15	-25.57	-13.00	-12.57
137.63	V	-12.26	-14.47	-26.73	-13.00	-13.73
827.85	V	-24.30	1.87	-22.43	-13.00	-9.43
75.96	H	-14.75	-16.63	-31.38	-13.00	-18.38
87.30	H	-12.65	-15.27	-27.92	-13.00	-14.92
107.16	H	-11.81	-14.25	-26.06	-13.00	-13.06
127.82	H	-12.06	-14.15	-26.21	-13.00	-13.21
311.65	H	-13.65	-9.74	-23.39	-13.00	-10.39
900.37	H	-23.67	-2.44	-26.11	-13.00	-13.11



Engineer : Kerry	Time : 2015-02-23
Site : EMC Lab AC 102	Margin : 6
Limit : FCC_ Part22&24 and RSS 133 Clause 6.5&6.6	Probe : VERTICAL/ HORIZONTAL
EUT : ES310	Note : GSM 1900 / CH 810

Frequency (MHz)	Antenna Polarization	Antenna Terminals leve (dBm)	Substitution Antenna Gain (dBd)	Emission level (dBm)	Limit (dBm)	Margin (dB)
39.53	V	-14.52	-11.29	-25.81	-13.00	-12.81
107.48	V	-13.36	-13.44	-26.80	-13.00	-13.80
111.39	V	-12.29	-13.78	-26.07	-13.00	-13.07
129.65	V	-11.85	-14.15	-26.00	-13.00	-13.00
138.90	V	-12.47	-14.47	-26.94	-13.00	-13.94
827.16	V	-23.92	1.87	-22.05	-13.00	-9.05
75.36	H	-11.26	-16.63	-27.89	-13.00	-14.89
87.85	H	-12.82	-15.27	-28.09	-13.00	-15.09
107.93	H	-12.63	-14.25	-26.88	-13.00	-13.88
127.10	H	-13.85	-14.15	-28.00	-13.00	-15.00
311.18	H	-13.71	-9.74	-23.45	-13.00	-10.45
900.25	H	-24.53	-2.18	-26.71	-13.00	-13.71



Engineer : Kerry	Time : 2015-02-23
Site : EMC Lab AC 102	Margin : 6
Limit : FCC_ Part22&24 and RSS 133 Clause 6.5&6.6	Probe : VERTICAL/ HORIZONTAL
EUT : ES310	Note : EDGE 850 / CH 128

Frequency (MHz)	Antenna Polarization	Antenna Terminals leve (dBm)	Substitution Antenna Gain (dBd)	Emission level (dBm)	Limit (dBm)	Margin (dB)
37.63	V	-14.10	-11.01	-25.11	-13.00	-12.11
106.27	V	-11.96	-13.44	-25.40	-13.00	-12.40
109.35	V	-10.53	-13.65	-24.18	-13.00	-11.18
127.52	V	12.06	-14.15	-24.27	-13.00	-11.27
134.14	V	-12.63	-14.47	-27.10	-13.00	-14.10
827.39	V	-25.95	1.87	-24.08	-13.00	-11.08
74.85	H	-10.17	-16.63	-26.80	-13.00	-13.80
86.53	H	-10.35	-15.27	-25.62	-13.00	-12.62
107.81	H	-13.60	-14.25	-27.85	-13.00	-14.85
128.39	H	-11.16	-14.15	-25.31	-13.00	-12.31
312.93	H	-16.61	-9.74	-26.35	-13.00	-13.35
895.19	H	-22.63	-2.44	-25.07	-13.00	-12.07



Engineer : Kerry	Time : 2015-02-23
Site : EMC Lab AC 102	Margin : 6
Limit : FCC_ Part22&24 and RSS 133 Clause 6.5&6.6	Probe : VERTICAL/ HORIZONTAL
EUT : ES310	Note : EDGE 850 / CH 190

Frequency (MHz)	Antenna Polarization	Antenna Terminals leve (dBm)	Substitution Antenna Gain (dBd)	Emission level (dBm)	Limit (dBm)	Margin (dB)
37.16	V	-14.65	-11.29	-25.94	-13.00	-12.94
101.93	V	-13.50	-11.47	-24.97	-13.00	-11.97
111.47	V	-12.31	-13.78	-26.09	-13.00	-13.09
126.29	V	-12.62	-14.15	-26.77	-13.00	-13.77
136.32	V	-13.09	-14.47	-27.56	-13.00	-14.56
817.96	V	-25.19	1.87	-23.32	-13.00	-10.32
75.29	H	-10.16	-16.63	-26.79	-13.00	-13.79
86.65	H	-11.69	-15.27	-26.96	-13.00	-13.96
107.53	H	-10.52	-14.25	-24.77	-13.00	-11.77
126.47	H	-11.37	-14.15	-25.52	-13.00	-12.52
312.85	H	-13.19	-9.74	-22.93	-13.00	-9.93
896.06	H	-22.53	-2.44	-24.97	-13.00	-11.97



Engineer : Kerry	Time : 2015-02-23
Site : EMC Lab AC 102	Margin : 6
Limit : FCC_ Part22&24 and RSS 133 Clause 6.5&6.6	Probe : VERTICAL/ HORIZONTAL
EUT : ES310	Note : EDGE 850 / CH 251

Frequency (MHz)	Antenna Polarization	Antenna Terminals leve (dBm)	Substitution Antenna Gain (dBd)	Emission level (dBm)	Limit (dBm)	Margin (dB)
38.19	V	-14.63	-11.29	-25.92	-13.00	-12.92
106.63	V	-11.16	-13.44	-24.60	-13.00	-11.60
111.35	V	-11.02	-13.78	-24.80	-13.00	-11.80
127.29	V	-12.57	-14.15	-26.72	-13.00	-13.72
136.71	V	-11.68	-14.47	-26.15	-13.00	-13.15
828.28	V	-28.29	1.87	-26.42	-13.00	-13.42
75.93	H	-10.54	-16.63	-27.17	-13.00	-14.17
86.27	H	-10.18	-15.27	-25.45	-13.00	-12.45
107.95	H	-9.75	-14.25	-24.00	-13.00	-11.00
128.17	H	-12.65	-14.15	-26.80	-13.00	-13.80
311.42	H	-12.46	-9.74	-22.20	-13.00	-9.20
897.85	H	-23.94	-2.44	-26.38	-13.00	-13.38



Engineer : Kerry	Time : 2015-02-23
Site : EMC Lab AC 102	Margin : 6
Limit : FCC_ Part22&24 and RSS 133 Clause 6.5&6.6	Probe : VERTICAL/ HORIZONTAL
EUT : ES310	Note : EDGE 1900 / CH 512

(MHz)	Polarization	Terminals level (dBm)	Antenna Gain (dBd)	(dBm)	(dBm)	(dB)
39.74	V	-13.26	-11.29	-24.55	-13.00	-11.55
107.85	V	-12.46	-13.44	-25.90	-13.00	-12.90
110.80	V	-13.95	-13.78	-27.73	-13.00	-14.73
127.39	V	-13.72	-14.15	-27.87	-13.00	-14.87
135.25	V	-14.54	-14.47	-29.01	-13.00	-16.01
827.59	V	-27.18	1.87	-25.31	-13.00	-12.31
74.16	H	-11.95	-16.63	-28.58	-13.00	-15.58
86.23	H	-12.10	-15.27	-27.37	-13.00	-14.37
108.84	H	-12.18	-14.25	-26.43	-13.00	-13.43
127.09	H	-11.97	-14.15	-26.12	-13.00	-13.12
311.64	H	-17.36	-9.74	-27.10	-13.00	-14.10
895.36	H	-24.82	-2.44	-27.26	-13.00	-14.26



Engineer : Kerry	Time : 2015-02-23
Site : EMC Lab AC 102	Margin : 6
Limit : FCC_ Part22&24 and RSS 133 Clause 6.5&6.6	Probe : VERTICAL/ HORIZONTAL
EUT : ES310	Note : EDGE 1900 / CH 661

Frequency (MHz)	Antenna Polarization	Antenna Terminals leve (dBm)	Substitution Antenna Gain (dBd)	Emission level (dBm)	Limit (dBm)	Margin (dB)
39.36	V	-14.63	-11.29	-25.92	-13.00	-12.92
107.29	V	-13.51	-13.44	-26.95	-13.00	-13.95
111.97	V	-12.29	-13.78	-26.07	-13.00	-13.07
128.82	V	-14.36	-14.15	-28.51	-13.00	-15.51
136.84	V	-13.84	-14.47	-28.31	-13.00	-15.31
827.63	V	-27.60	1.87	-25.73	-13.00	-12.73
75.09	H	-10.05	-16.63	-26.68	-13.00	-13.68
86.28	H	-11.25	-15.27	-26.52	-13.00	-13.52
107.32	H	-11.74	-14.25	-25.99	-13.00	-12.99
127.68	H	-12.26	-14.15	-26.41	-13.00	-13.41
310.47	H	-16.19	-9.74	-25.93	-13.00	-12.93
899.29	H	-23.68	-2.18	-25.86	-13.00	-12.86



Engineer : Kerry	Time : 2015-02-23
Site : EMC Lab AC 102	Margin : 6
Limit : FCC_ Part22&24 and RSS 133 Clause 6.5&6.6	Probe : VERTICAL/ HORIZONTAL
EUT : ES310	Note : EDGE 1900 / CH 810

Frequency (MHz)	Antenna Polarization	Antenna Terminals leve (dBm)	Substitution Antenna Gain (dBd)	Emission level (dBm)	Limit (dBm)	Margin (dB)
38.85	V	-15.65	-11.29	-26.94	-13.00	-13.94
107.96	V	-14.48	-13.44	-27.92	-13.00	-14.92
111.72	V	-11.82	-13.78	-25.60	-13.00	-12.60
127.36	V	-12.26	-14.15	-26.41	-13.00	-13.41
136.90	V	-14.75	-14.47	-29.22	-13.00	-16.22
829.31	V	-28.08	1.87	-26.21	-13.00	-13.21
75.73	H	-10.59	-16.63	-27.22	-13.00	-14.22
84.69	H	-10.65	-15.27	-25.92	-13.00	-12.92
107.51	H	-10.87	-14.25	-25.12	-13.00	-12.12
128.45	H	-12.62	-14.15	-26.77	-13.00	-13.77
312.09	H	-15.17	-9.74	-24.91	-13.00	-11.91
897.38	H	-25.15	-2.44	-27.59	-13.00	-14.59



Engineer : Kerry	Time : 2015-02-23
Site : EMC Lab AC 102	Margin : 6
Limit : FCC_ Part22&24 and RSS 133 Clause 6.5&6.6	Probe : VERTICAL/ HORIZONTAL
EUT : ES310	Note : GSM 850 / CH 128

Frequency (MHz)	Antenna Polarization	Antenna Terminals leve (dBm)	Substitution Antenna Gain (dBi)	Emission level (dBm)	Limit (dBm)	Margin (dB)
1648.32	V	-24.63	1.29	-23.34	-13.00	-10.34
1648.05	H	-25.08	1.31	-23.77	-13.00	-10.77

Note: The other harmonic spurious emissions are under limit 20dB more, so the results were not shown in the table.



Engineer : Kerry	Time : 2015-02-23
Site : EMC Lab AC 102	Margin : 6
Limit : FCC_ Part22&24 and RSS 133 Clause 6.5&6.6	Probe : VERTICAL/ HORIZONTAL
EUT : ES310	Note : GSM 850 / CH 190

Frequency (MHz)	Antenna Polarization	Antenna Terminals leve (dBm)	Substitution Antenna Gain (dBi)	Emission level (dBm)	Limit (dBm)	Margin (dB)
1674.33	V	-23.85	1.33	-22.52	-13.00	-9.52
1674.85	H	-24.63	1.36	-23.27	-13.00	-10.27

Note :The other harmonic spurious emissions are under limit 20dB more,
so the results were not shown in the table.



Engineer : Kerry	Time : 2015-02-23
Site : EMC Lab AC 102	Margin : 6
Limit : FCC_ Part22&24 and RSS 133 Clause 6.5&6.6	Probe : VERTICAL/ HORIZONTAL
EUT : ES310	Note : GSM 850 / CH 251

Frequency (MHz)	Antenna Polarization	Antenna Terminals level (dBm)	Substitution Antenna Gain (dBi)	Emission level (dBm)	Limit (dBm)	Margin (dB)
1698.31	V	-22.08	1.38	-20.70	-13.00	-7.70
1698.85	H	-23.96	1.41	-22.55	-13.00	-9.55

Note :The other harmonic spurious emissions are under limit 20dB more,
so the results were not shown in the table.



Engineer : Kerry	Time : 2015-02-23
Site : EMC Lab AC 102	Margin : 6
Limit : FCC_ Part22&24 and RSS 133 Clause 6.5&6.6	Probe : VERTICAL/ HORIZONTAL
EUT : ES310	Note : GSM 1900 / CH 512

Frequency (MHz)	Antenna Polarization	Antenna Terminals leve (dBm)	Substitution Antenna Gain (dBi)	Emission level (dBm)	Limit (dBm)	Margin (dB)
3700.15	V	-24.85	3.41	-21.44	-13.00	-8.44
3700.72	H	-26.36	3.52	-22.84	-13.00	-9.84

Note :The other harmonic spurious emissions are under limit 20dB more,
so the results were not shown in the table.



Engineer : Kerry	Time : 2015-02-23
Site : EMC Lab AC 102	Margin : 6
Limit : FCC_ Part22&24 and RSS 133 Clause 6.5&6.6	Probe : VERTICAL/ HORIZONTAL
EUT : ES310	Note : GSM 1900 / CH 661

Frequency (MHz)	Antenna Polarization	Antenna Terminals leve (dBm)	Substitution Antenna Gain (dBi)	Emission level (dBm)	Limit (dBm)	Margin (dB)
3760.82	V	-26.17	3.48	-22.69	-13.00	-9.69
3760.49	H	-26.75	3.56	-23.19	-13.00	-10.19

Note :The other harmonic spurious emissions are under limit 20dB more,
so the results were not shown in the table.



Engineer : Kerry	Time : 2015-02-23
Site : EMC Lab AC 102	Margin : 6
Limit : FCC_ Part22&24 and RSS 133 Clause 6.5&6.6	Probe : VERTICAL/ HORIZONTAL
EUT : ES310	Note : GSM 1900 / CH 810

Frequency (MHz)	Antenna Polarization	Antenna Terminals leve (dBm)	Substitution Antenna Gain (dBi)	Emission level (dBm)	Limit (dBm)	Margin (dB)
3819.14	V	-25.45	3.57	-21.88	-13.00	-8.88
3819.92	H	-26.87	3.64	-23.23	-13.00	-10.23

Note :The other harmonic spurious emissions are under limit 20dB more,
so the results were not shown in the table.



Engineer : Kerry	Time : 2015-02-23
Site : EMC Lab AC 102	Margin : 6
Limit : FCC_ Part22&24 and RSS 133 Clause 6.5&6.6	Probe : VERTICAL/ HORIZONTAL
EUT : ES310	Note : EDGE 850 / CH 128

Frequency (MHz)	Antenna Polarization	Antenna Terminals leve (dBm)	Substitution Antenna Gain (dBi)	Emission level (dBm)	Limit (dBm)	Margin (dB)
1649.31	V	-26.23	1.29	-24.94	-13.00	-11.94
1649.09	H	-28.58	1.31	-27.27	-13.00	-14.27

Note :The other harmonic spurious emissions are under limit 20dB more,
so the results were not shown in the table.



Engineer : Kerry	Time : 2015-02-23
Site : EMC Lab AC 102	Margin : 6
Limit : FCC_ Part22&24 and RSS 133 Clause 6.5&6.6	Probe : VERTICAL/ HORIZONTAL
EUT : ES310	Note : EDGE 850 / CH 190

Frequency (MHz)	Antenna Polarization	Antenna Terminals leve (dBm)	Substitution Antenna Gain (dBi)	Emission level (dBm)	Limit (dBm)	Margin (dB)
1674.20	V	-28.59	1.33	-27.26	-13.00	-14.26
1675.38	H	-29.61	1.36	-28.25	-13.00	-15.25

Note :The other harmonic spurious emissions are under limit 20dB more,
so the results were not shown in the table.



Engineer : Kerry	Time : 2015-02-23
Site : EMC Lab AC 102	Margin : 6
Limit : FCC_ Part22&24 and RSS 133 Clause 6.5&6.6	Probe : VERTICAL/ HORIZONTAL
EUT : ES310	Note : EDGE 850 / CH 251

Frequency (MHz)	Antenna Polarization	Antenna Terminals level (dBm)	Substitution Antenna Gain (dBi)	Emission level (dBm)	Limit (dBm)	Margin (dB)
1699.23	V	-27.35	1.38	-25.97	-13.00	-12.97
1698.74	H	-29.58	1.41	-28.17	-13.00	-15.17

Note: The other harmonic spurious emissions are under limit 20dB more, so the results were not shown in the table.



Engineer : Kerry	Time : 2015-02-23
Site : EMC Lab AC 102	Margin : 6
Limit : FCC_ Part22&24 and RSS 133 Clause 6.5&6.6	Probe : VERTICAL/ HORIZONTAL
EUT : ES310	Note : EDGE 1900 / CH 512

Frequency (MHz)	Antenna Polarization	Antenna Terminals leve (dBm)	Substitution Antenna Gain (dBi)	Emission level (dBm)	Limit (dBm)	Margin (dB)
3700.11	V	-32.01	3.41	-28.60	-13.00	-15.60
3700.52	H	-32.48	3.52	-28.96	-13.00	-15.96

Note: The other harmonic spurious emissions are under limit 20dB more, so the results were not shown in the table.



Engineer : Kerry	Time : 2015-02-23
Site : EMC Lab AC 102	Margin : 6
Limit : FCC_ Part22&24 and RSS 133 Clause 6.5&6.6	Probe : VERTICAL/ HORIZONTAL
EUT : ES310	Note : EDGE 1900 / CH 661

Frequency (MHz)	Antenna Polarization	Antenna Terminals leve (dBm)	Substitution Antenna Gain (dBi)	Emission level (dBm)	Limit (dBm)	Margin (dB)
3760.85	V	-31.53	3.48	-28.05	-13.00	-15.05
3760.35	H	-33.18	3.56	-29.62	-13.00	-16.62

Note :The other harmonic spurious emissions are under limit 20dB more,
so the results were not shown in the table.



Engineer : Kerry	Time : 2015-02-23
Site : EMC Lab AC 102	Margin : 6
Limit : FCC_ Part22&24 and RSS 133 Clause 6.5&6.6	Probe : VERTICAL/ HORIZONTAL
EUT : ES310	Note : EDGE 1900 / CH 810

Frequency (MHz)	Antenna Polarization	Antenna Terminals leve (dBm)	Substitution Antenna Gain (dBi)	Emission level (dBm)	Limit (dBm)	Margin (dB)
3819.74	V	-30.19	3.57	-26.62	-13.00	-13.62
3820.69	H	-31.18	3.64	-27.54	-13.00	-14.54

Note :The other harmonic spurious emissions are under limit 20dB more,
so the results were not shown in the table.



5. Occupied Bandwidth

5.1. Test Limit

According to §FCC 2.1049.

5.2. Test Procedures

The EUT's output RF connector was connected with a short cable to the spectrum analyzer, RBW was set to about 1% of emission BW, VBW is set to 3 times the RBW, -26dBc display line was placed on the screen (or 99% bandwidth), the occupied bandwidth is the delta frequency between the two points where the display line intersects the signal trace.

5.3. Test Setup Layout

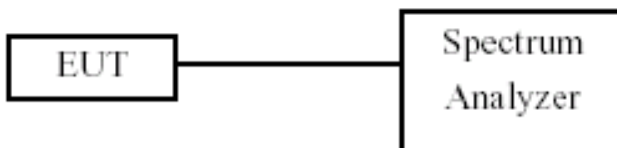

5.4. Measurement Equipment

Instrument/Ancillary	Model No.	Manufacturer	Serial No.	Calibration Date	Valid Date
Spectrum Analyzer	Agilent	E4407B	MY44211883	2014.09.12	2015.09.11
Temperature/ Humidity Meter	Zhicheng	ZC1-11	CEP-TH-002	2014.03.31	2015.03.30



5.5. Test Result and Data

Test Item	Occupied Bandwidth
Test Mode	GSM 850
Test Date	2015-02-23

Channel No.	Frequency (MHz)	Measurement Level (kHz)	99% Occupied Bandwidth (kHz)
128	824.2	316.933	243.271
190	836.6	323.537	241.857
251	848.8	319.086	243.461

Figure Channel 128 (824.20MHz)

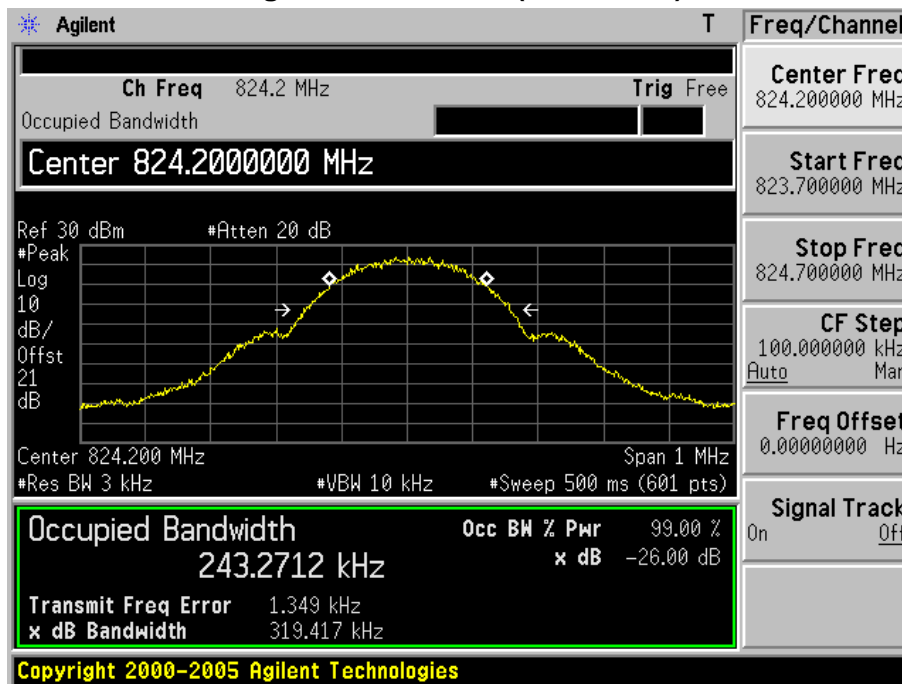



Figure Channel 189 (836.40MHz)

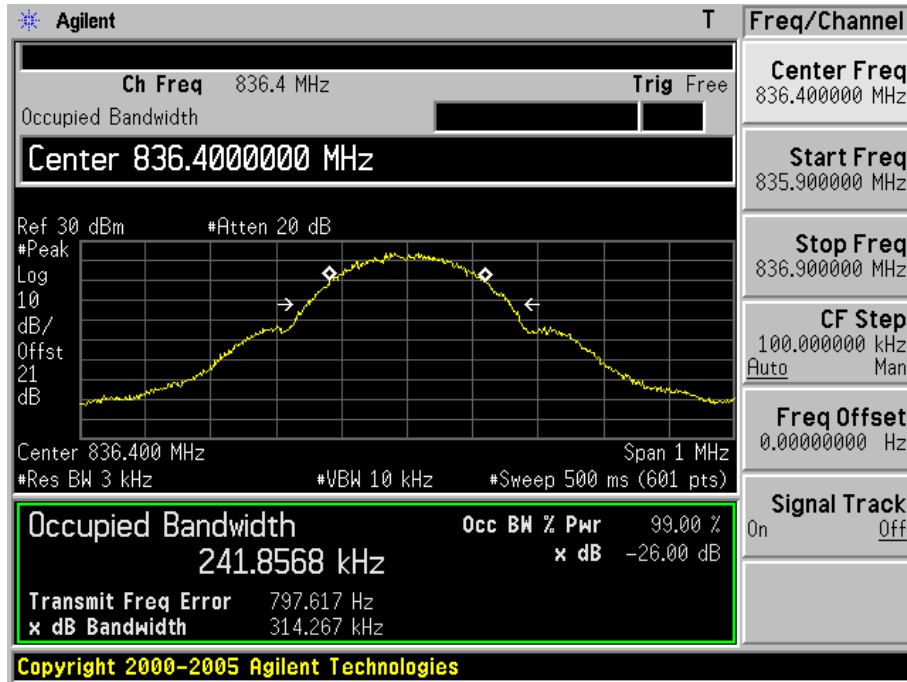
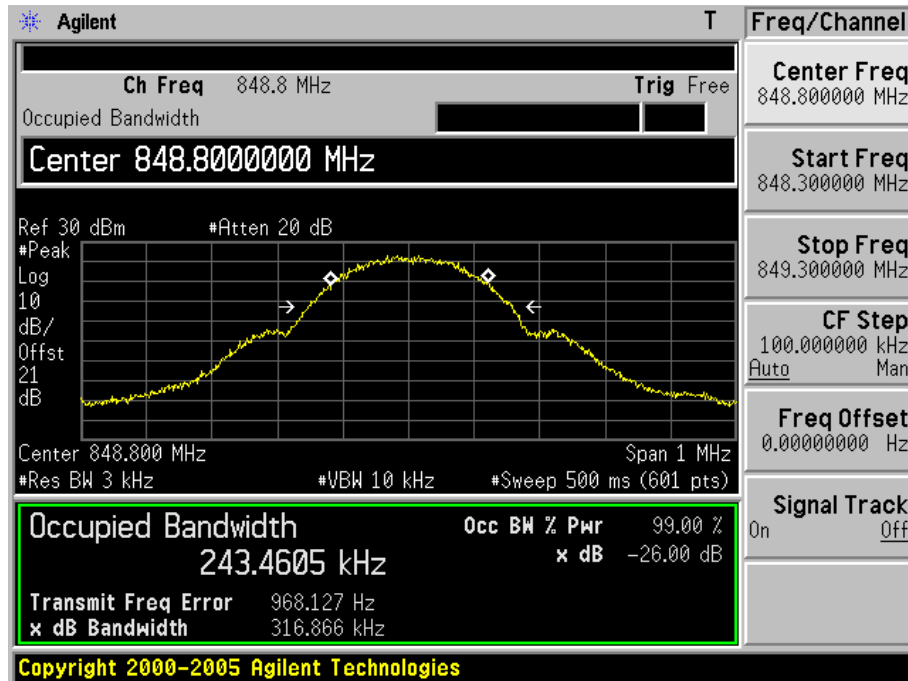

Figure Channel 251 (848.80MHz)





Test Item	Occupied Bandwidth
Test Mode	GSM 1900
Test Date	2015-02-23

Channel No.	Frequency (MHz)	Measurement Level (kHz)	99% Occupied Bandwidth (kHz)
512	1850.2	320.217	242.888
661	1880.0	325.981	242.756
810	1909.8	319.034	244.078

Figure Channel 512 (1850.20MHz)

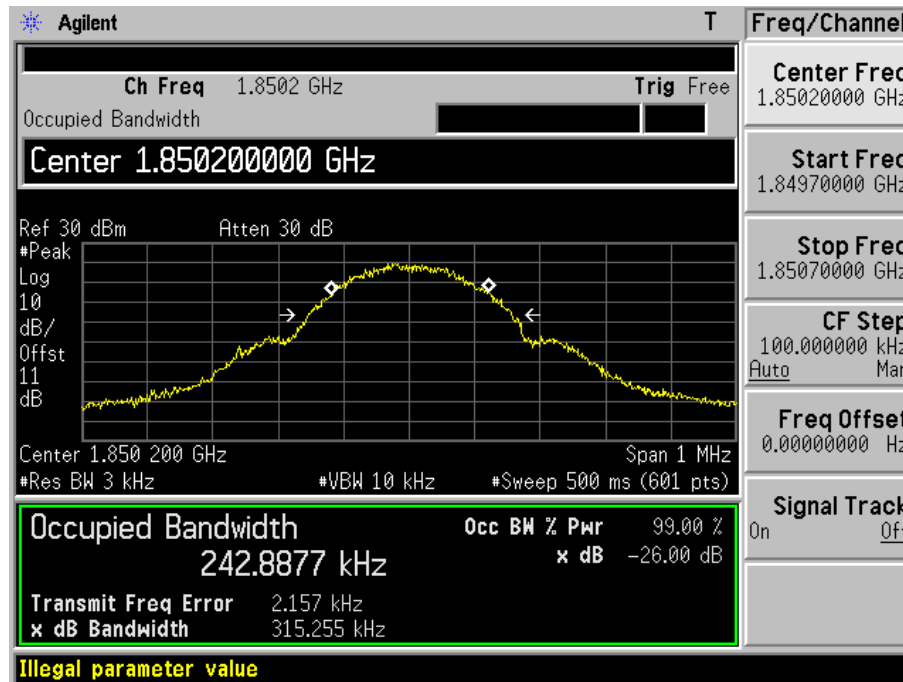



Figure Channel 661 (1880.00MHz)

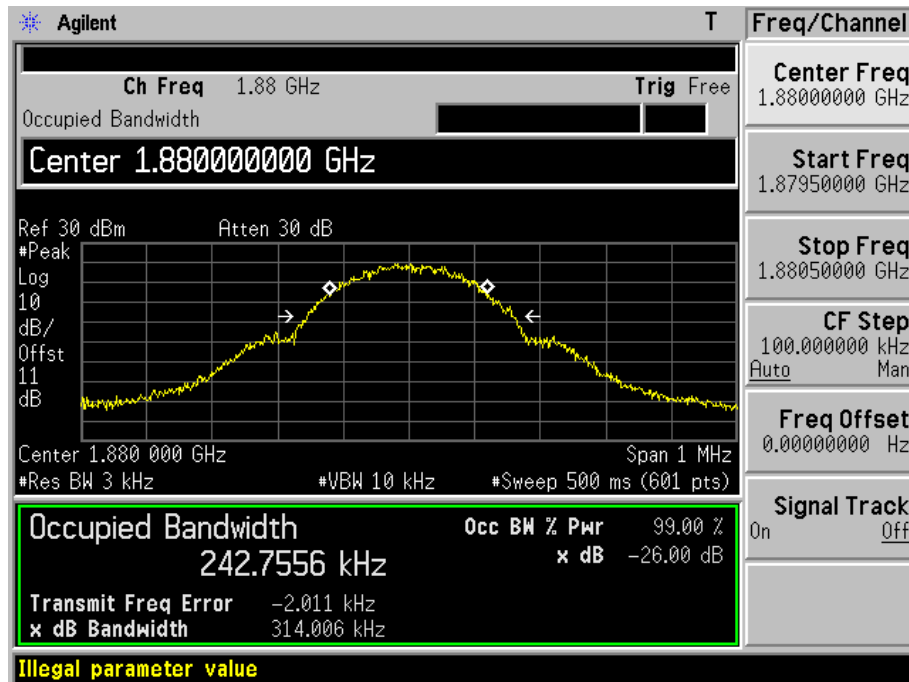
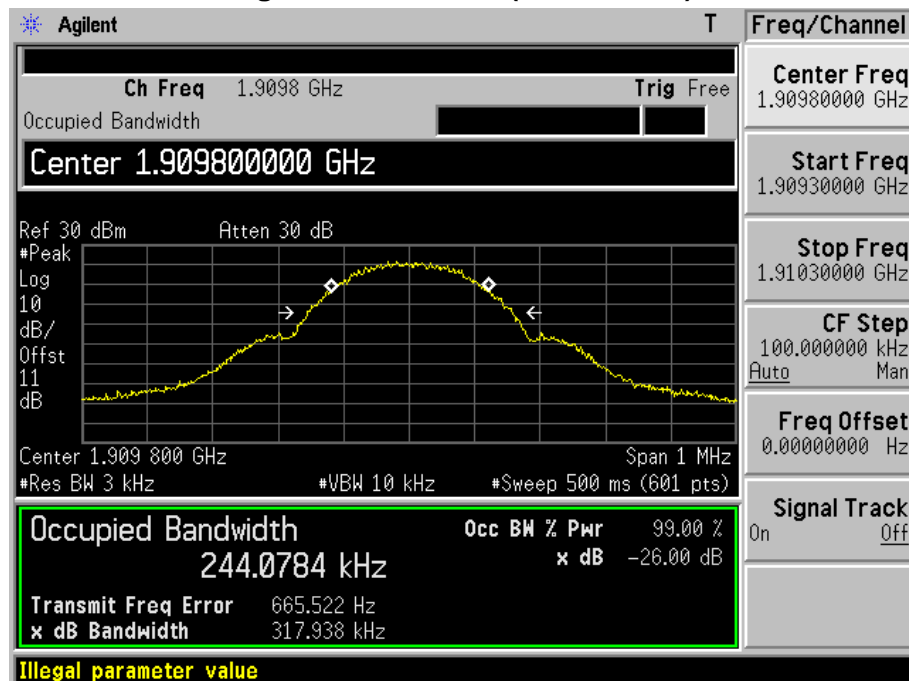

Figure Channel 810 (1909.80MHz)





Test Item	Occupied Bandwidth
Test Mode	EDGE 850
Test Date	2014-06-10

Channel No.	Frequency (MHz)	Measurement Level (kHz)	99% Occupied Bandwidth (kHz)
128	824.2	314.589	238.821
190	836.6	315.589	243.602
251	848.8	317.722	244.262

Figure Channel 128 (824.20MHz)

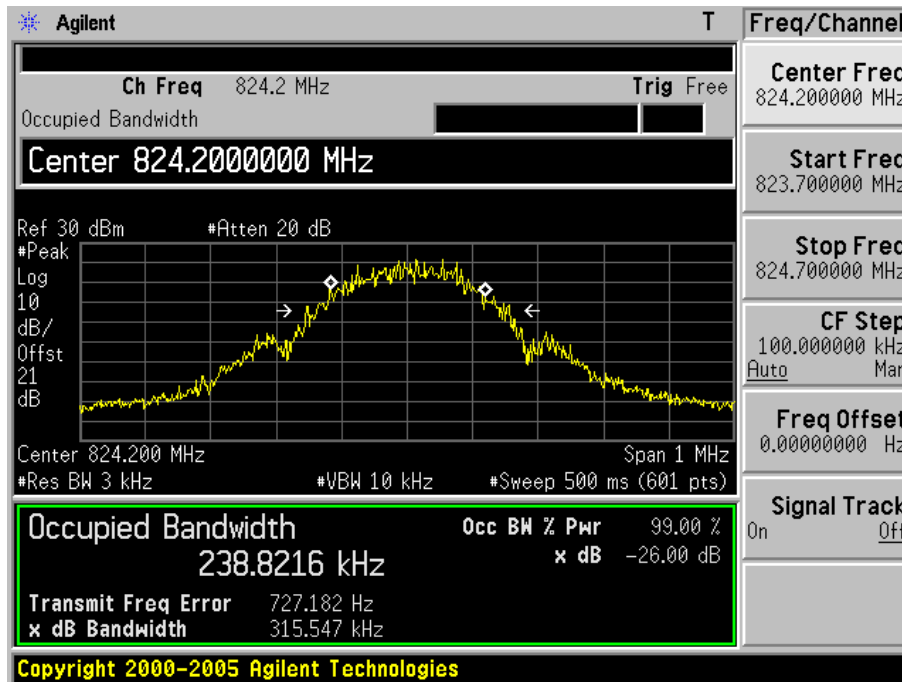



Figure Channel 189 (836.40MHz)

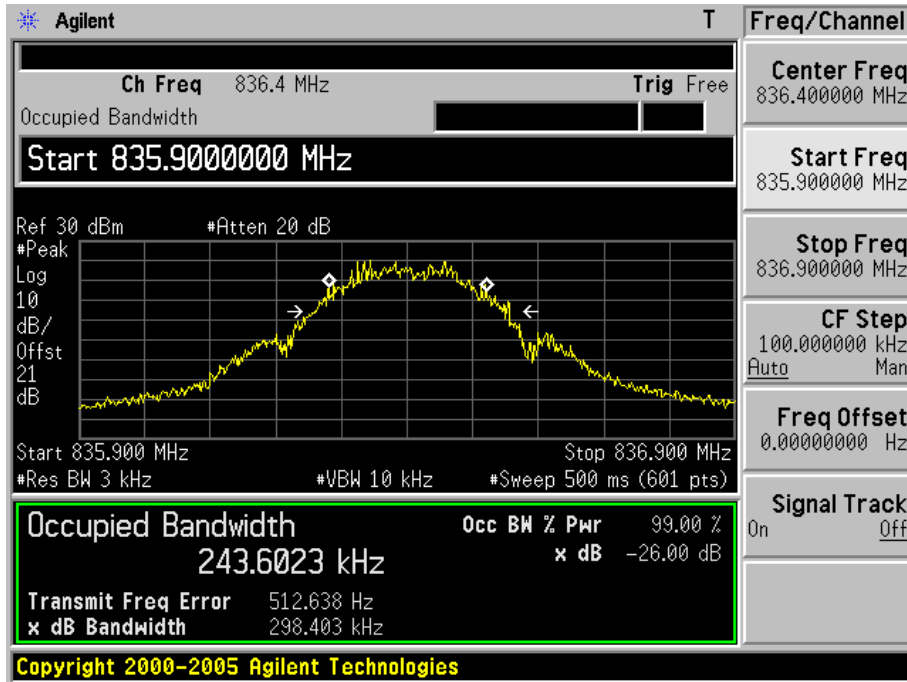
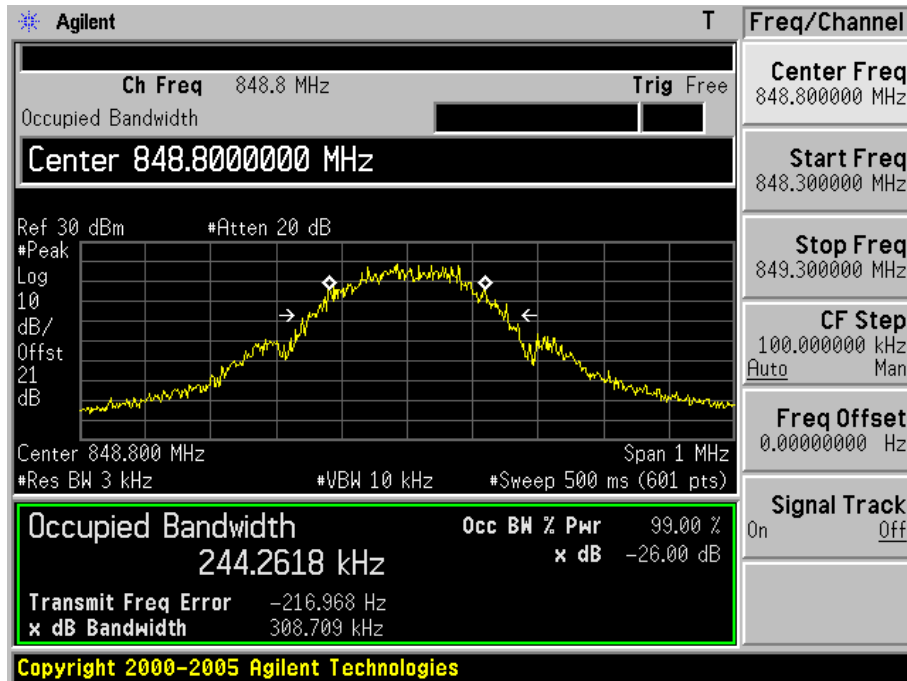

Figure Channel 251 (848.80MHz)





Test Item	Occupied Bandwidth
Test Mode	EDGE 1900
Test Date	2015-02-23

Channel No.	Frequency (MHz)	Measurement Level (kHz)	99% Occupied Bandwidth (kHz)
512	1850.2	298.065	243.671
661	1880.0	312.966	242.394
810	1909.8	315.615	245.244

Figure Channel 512 (1850.20MHz)

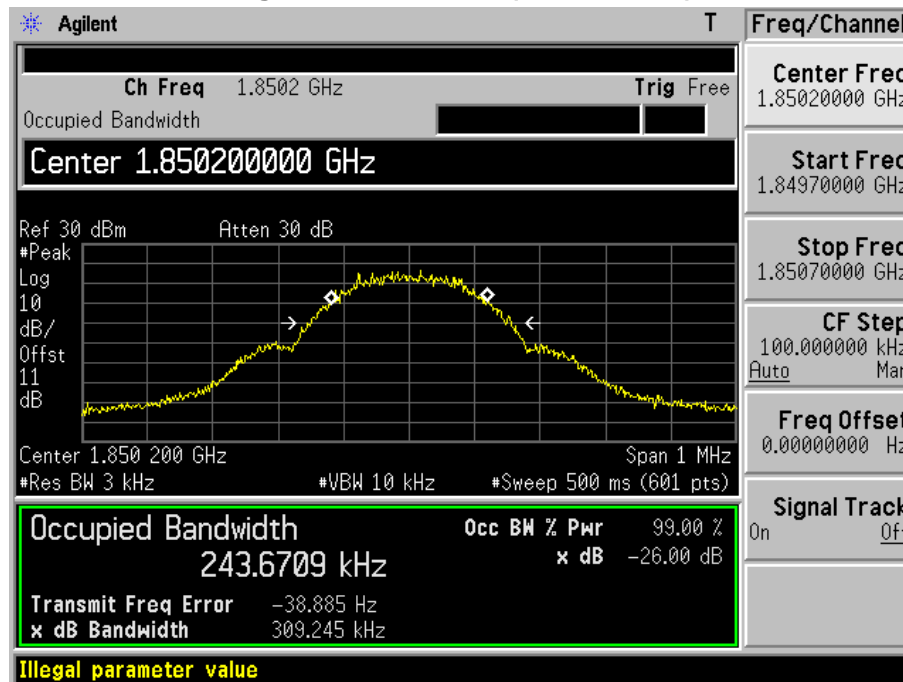



Figure Channel 661 (1880.00MHz)

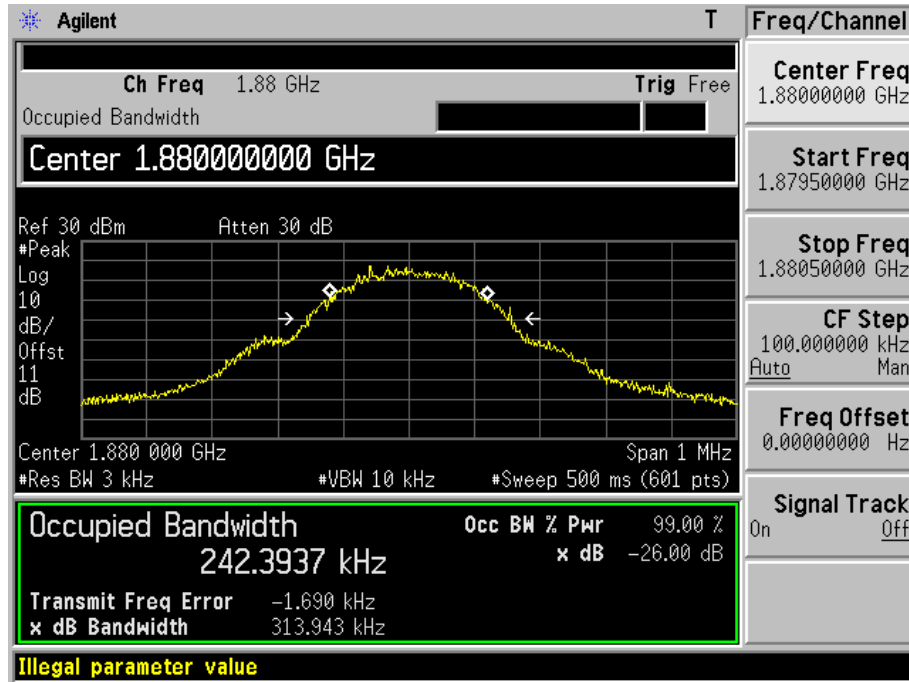
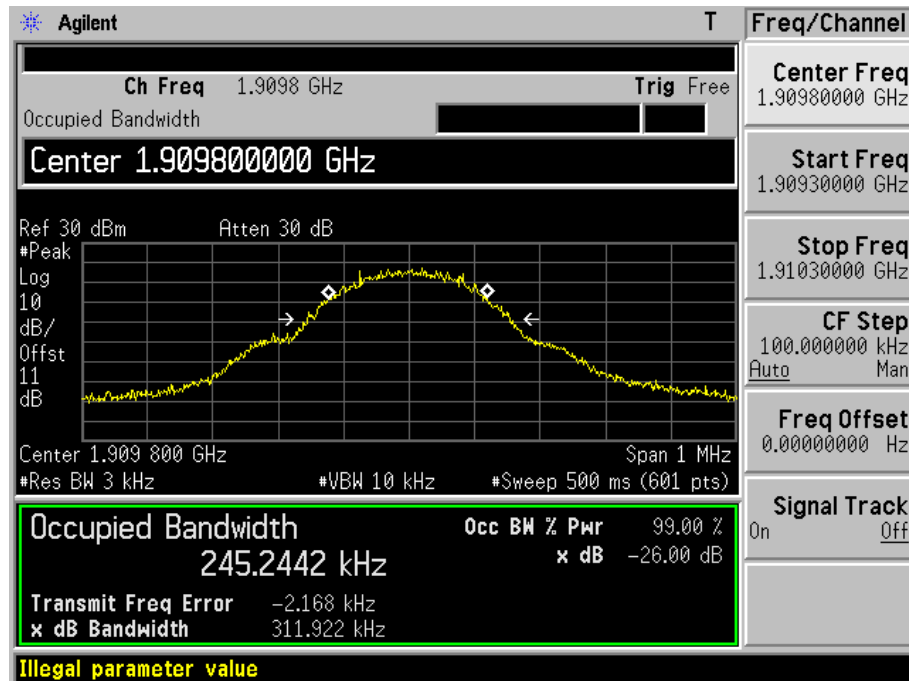

Figure Channel 810 (1909.80MHz)





6. Maximum Peak Output Power

6.1. Test Limit

According to FCC §2.1046.

6.2. Test Procedure

- a) Place the EUT on a bench and set it in transmitting mode.
- b) Connect a low loss RF cable from the antenna port to a spectrum analyzer and CMU200 by a Directional Coupler.
- c) EUT Communicate with CMU200, then selects a channel for testing.
- d) Add a correction factor to the display of spectrum, and then test.

6.3. Test Setup Layout

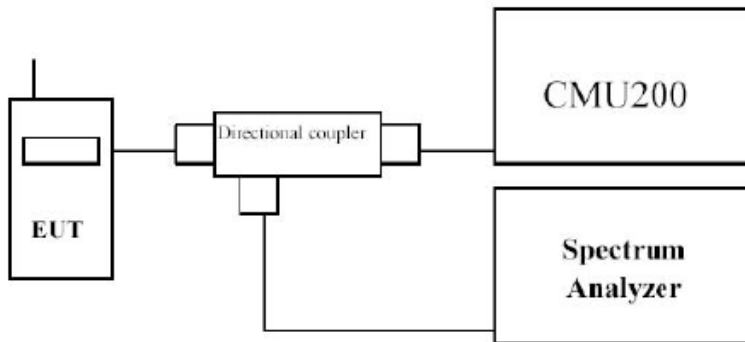

6.4. Measurement Equipment

Instrument/Ancillary	Model No.	Manufacturer	Serial No.	Calibration Date	Valid Date
Spectrum Analyzer	E4407B	Agilent	MY44211883	2014.09.12	2015.09.11
Temperature/ Humidity Meter	Zhicheng	ZC1-11	CEP-TH-002	2014.03.31	2015.03.30
Universal Radio Communication Tester	R&S	CMU200	108823	2014.03.24	2015.03.23



6.5. Test Result and Data

Test Item	Maximum Peak Output Power
Test Mode	GSM 850
Test Date	2015-02-23

Channel No.	Frequency (MHz)	Average Power (dBm)	Peak Power (dBm)
128	824.2	30.21	31.37
190	836.6	30.37	31.44
251	848.8	30.82	31.61

Channel 128

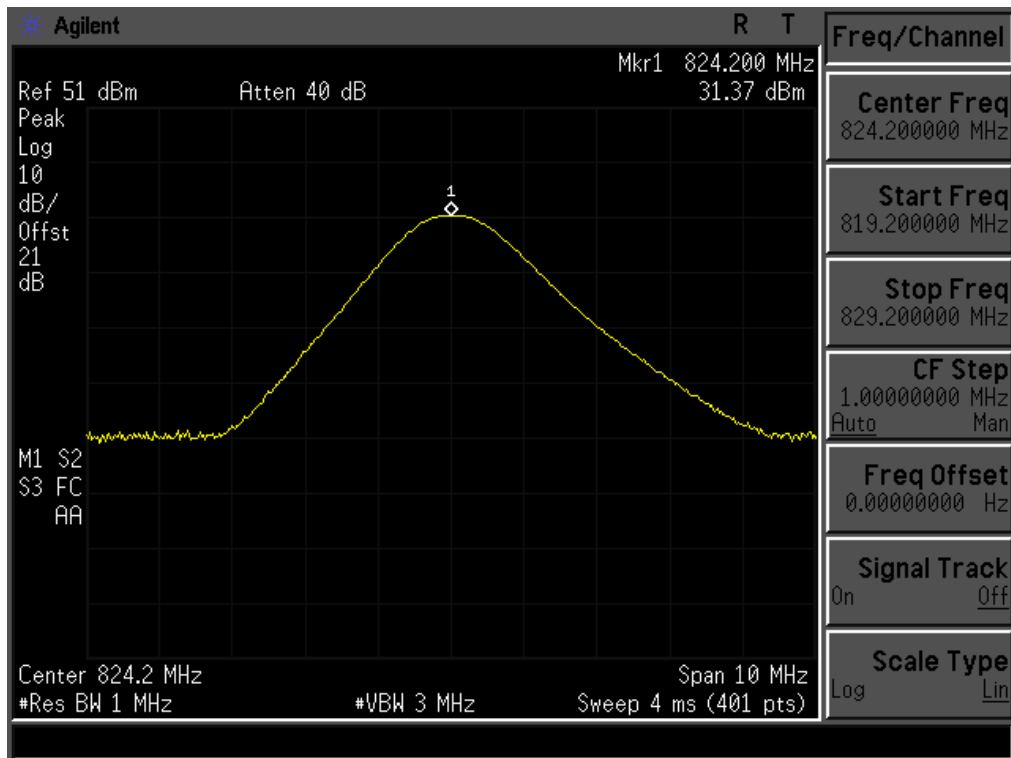



Channel 190

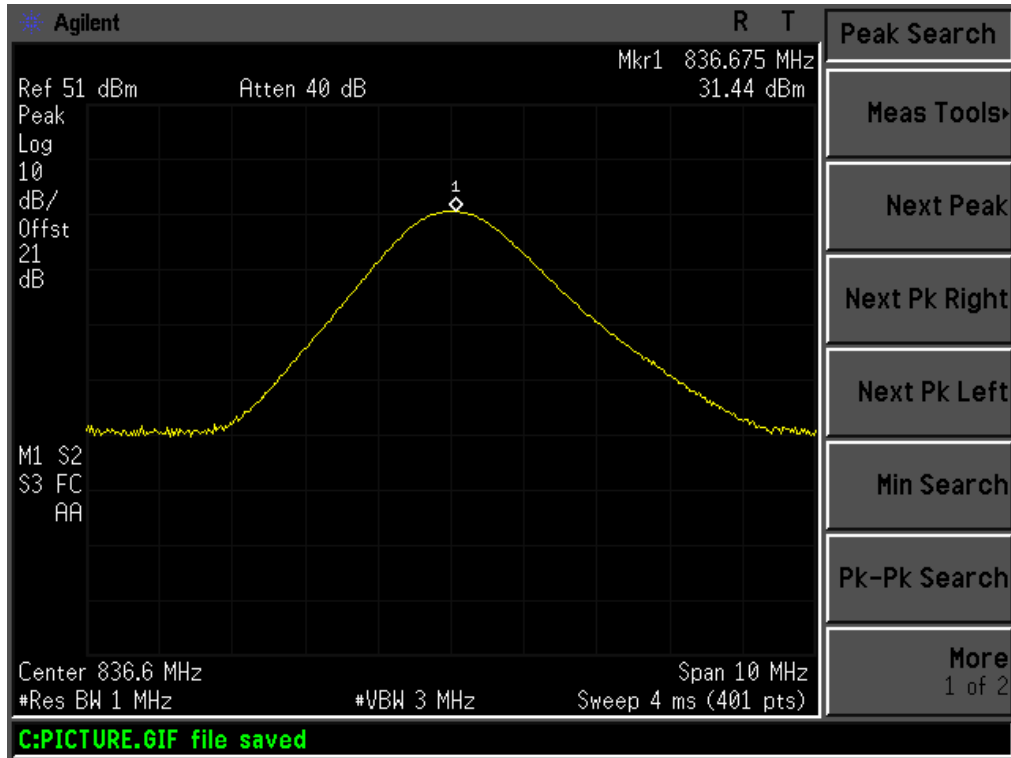

Channel 251

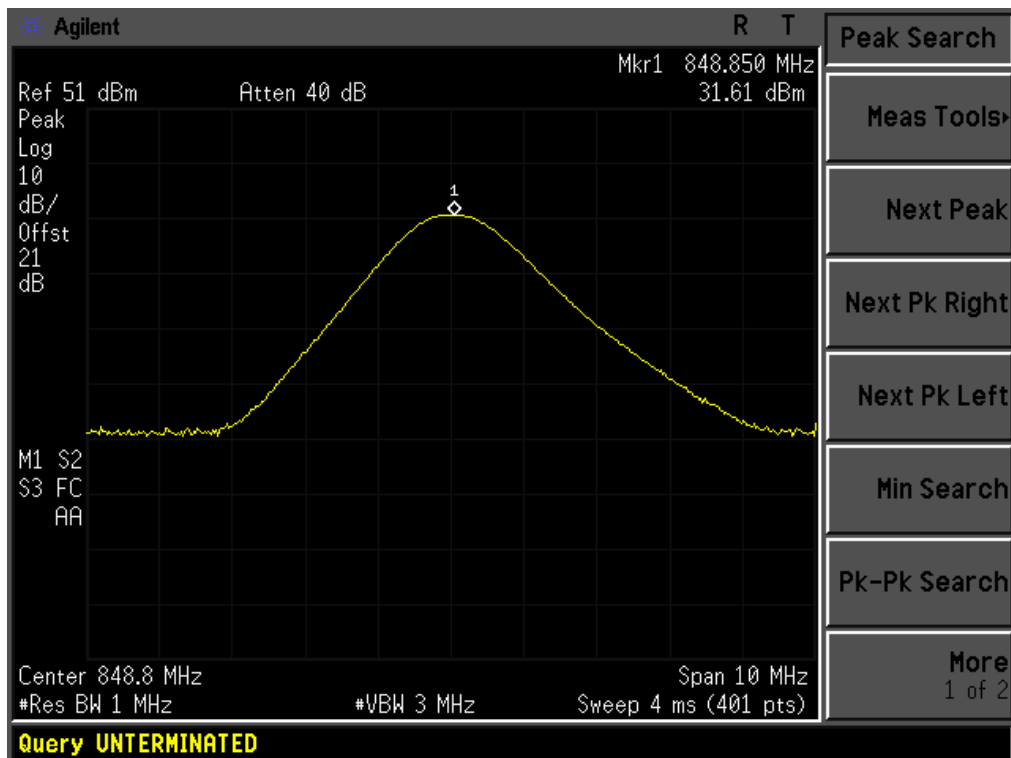



Test Item	Maximum Peak Output Power
Test Mode	GSM 1900
Test Date	2015-02-23

Channel No.	Frequency (MHz)	Average Power (dBm)	Peak Power (dBm)
512	1850.2	24.38	25.42
661	1880.0	24.10	24.97
810	1909.8	24.21	25

Channel 512

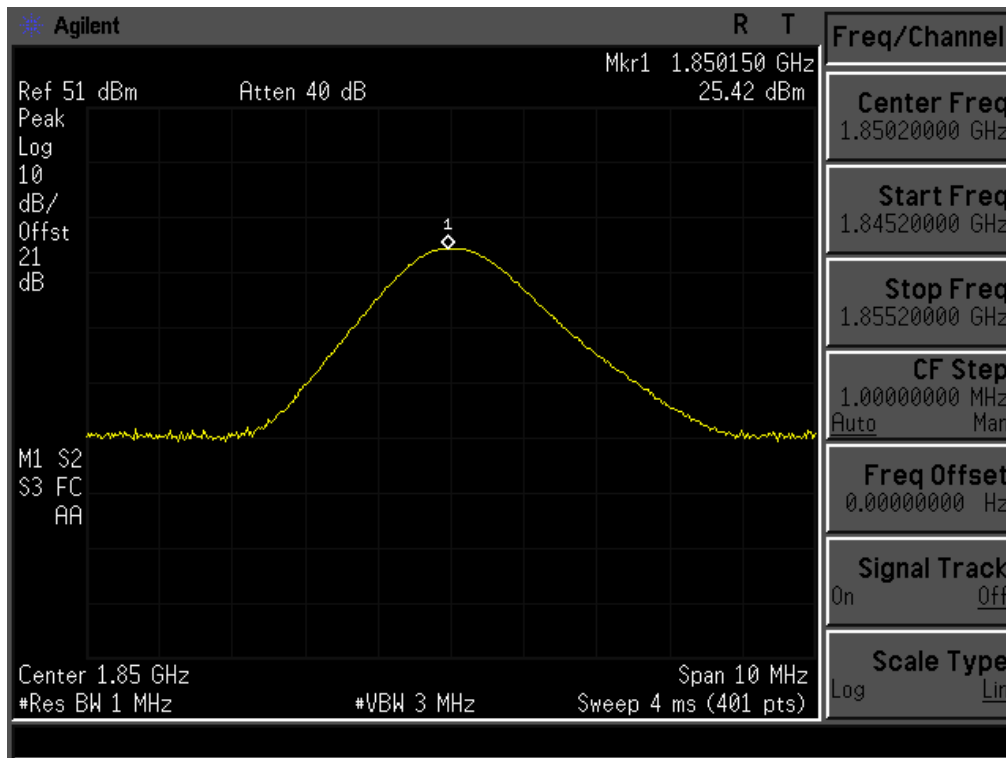



Channel 661

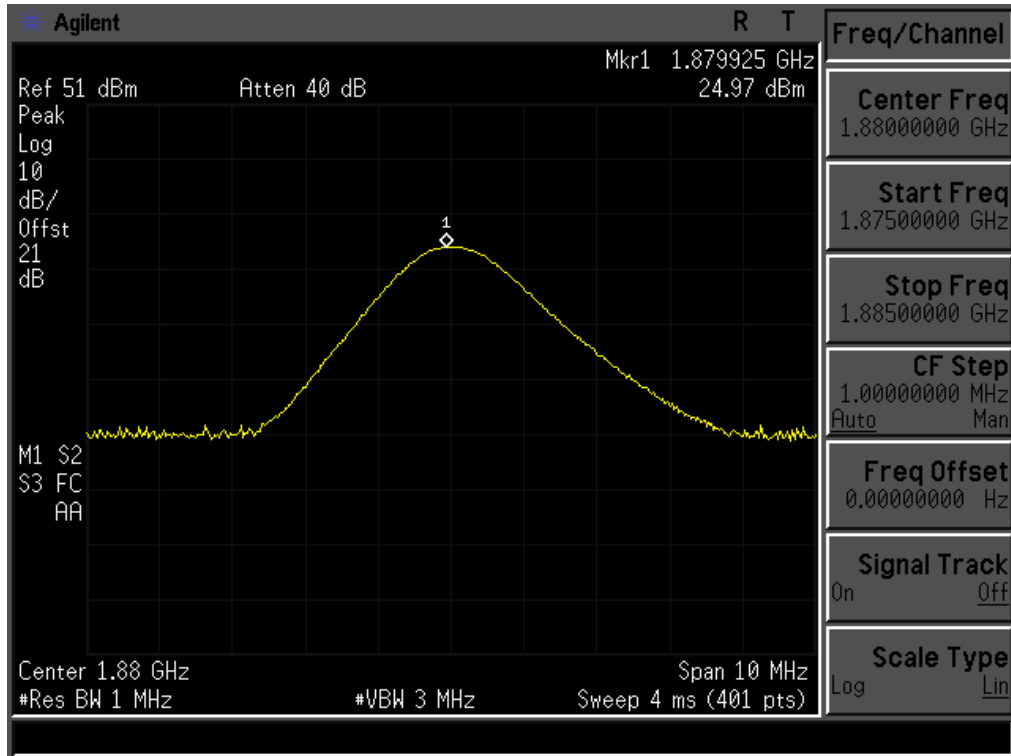

Channel 810

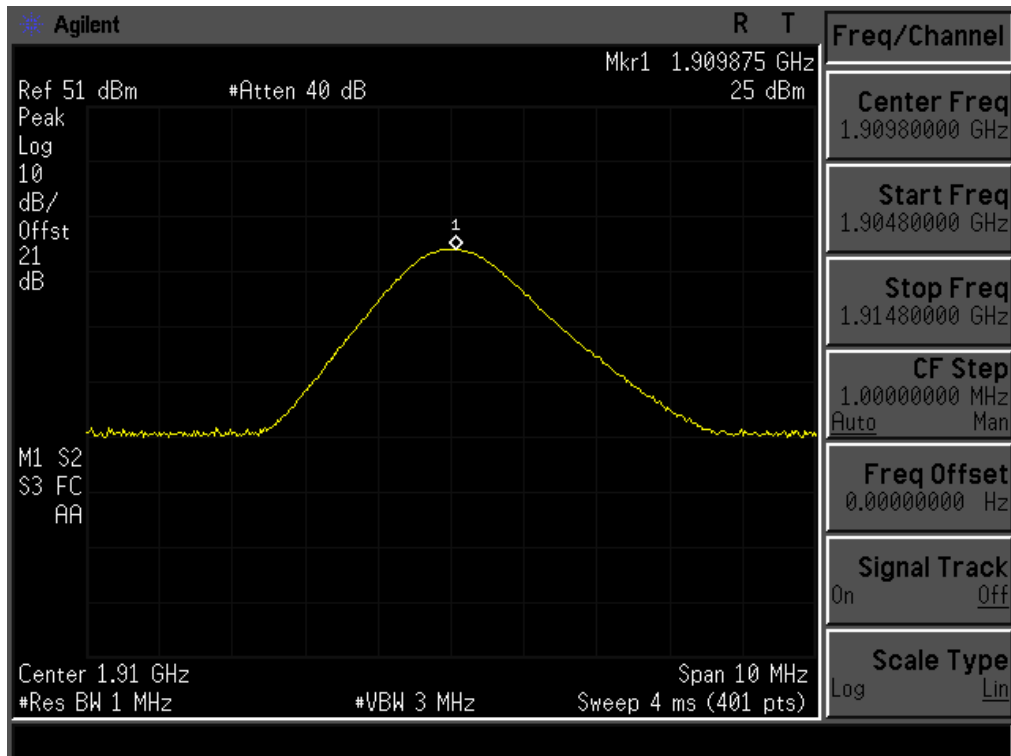



Test Item	Maximum Peak Output Power
Test Mode	EDGE 850
Test Date	2015-02-23

Channel No.	Frequency (MHz)	Average Power (dBm)	Peak Power (dBm)
128	824.2	30.19	31.52
190	836.6	30.35	31.48
251	848.8	29.91	31.41

Channel 128

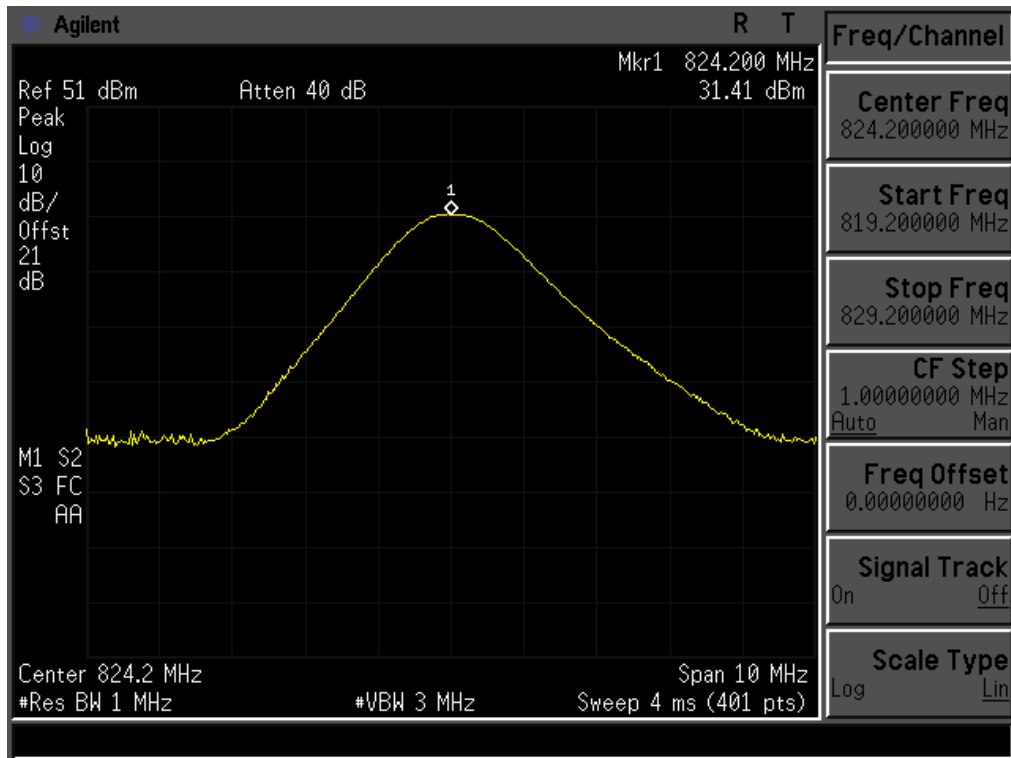



Channel 190

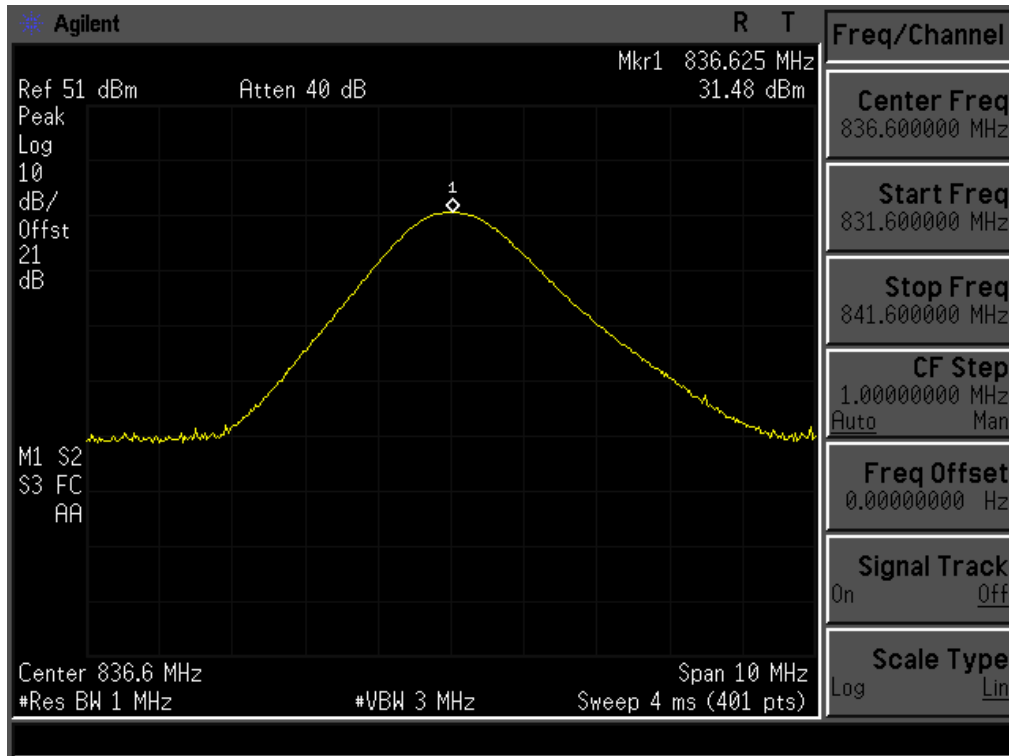

Channel 251

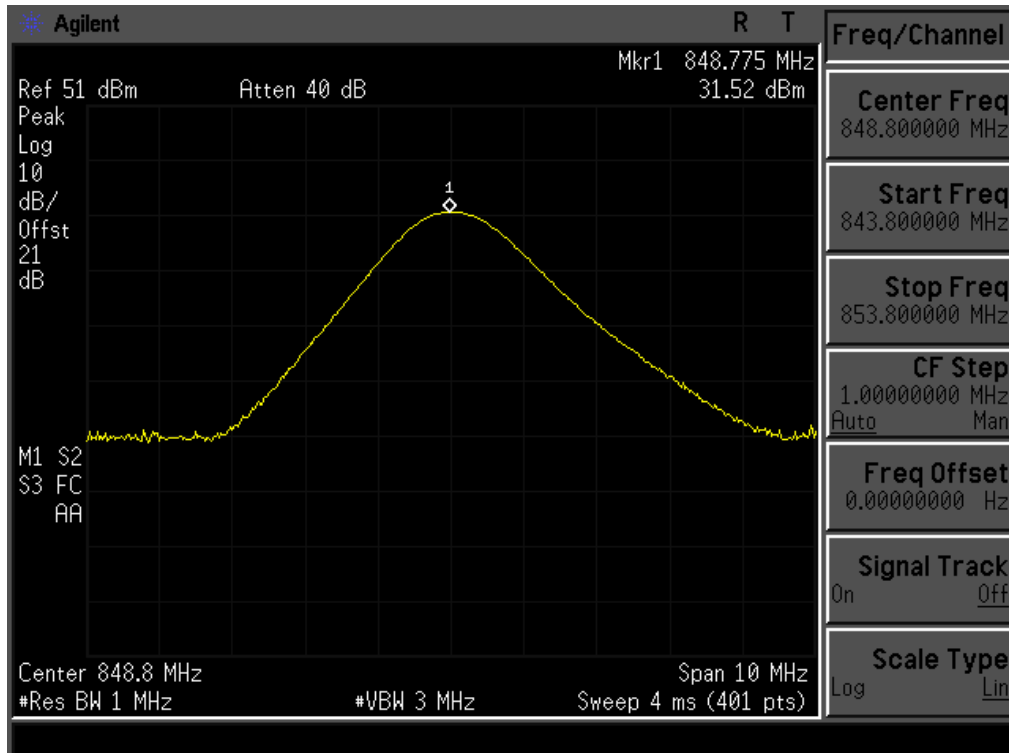



Test Item	Maximum Peak Output Power
Test Mode	EDGE 1900
Test Date	2015-02-23

Channel No.	Frequency (MHz)	Average Power (dBm)	Peak Power (dBm)
512	1850.2	24.15	25.32
661	1880.0	24.06	25
810	1909.8	23.81	24.95

Channel 512

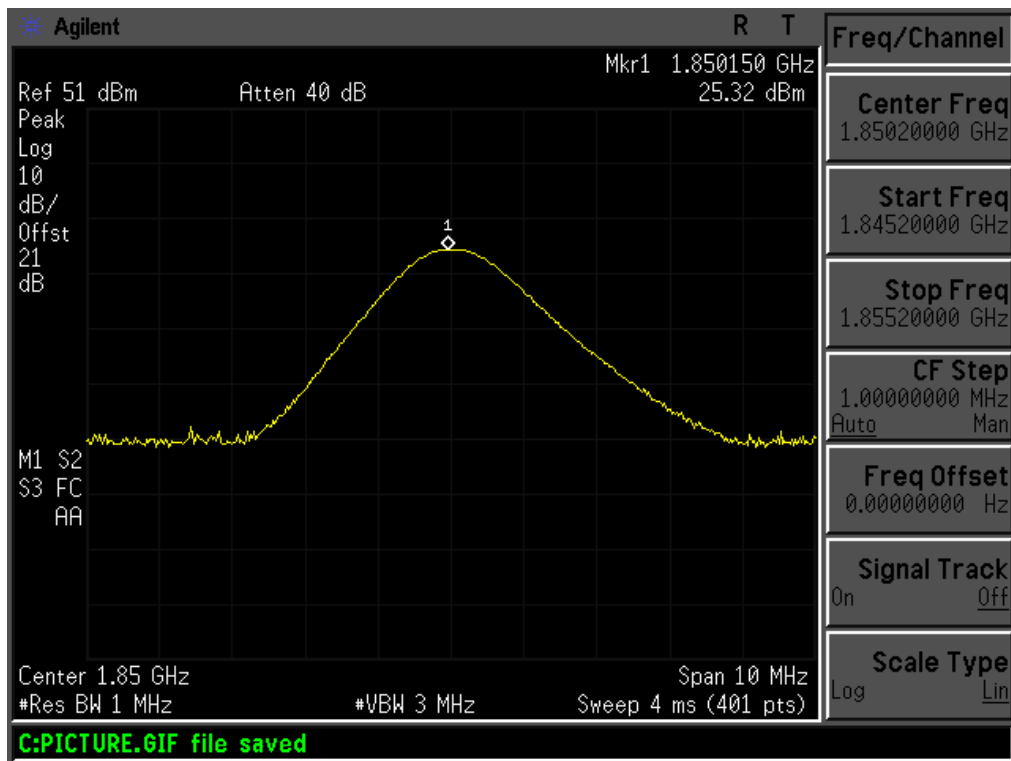



Channel 661

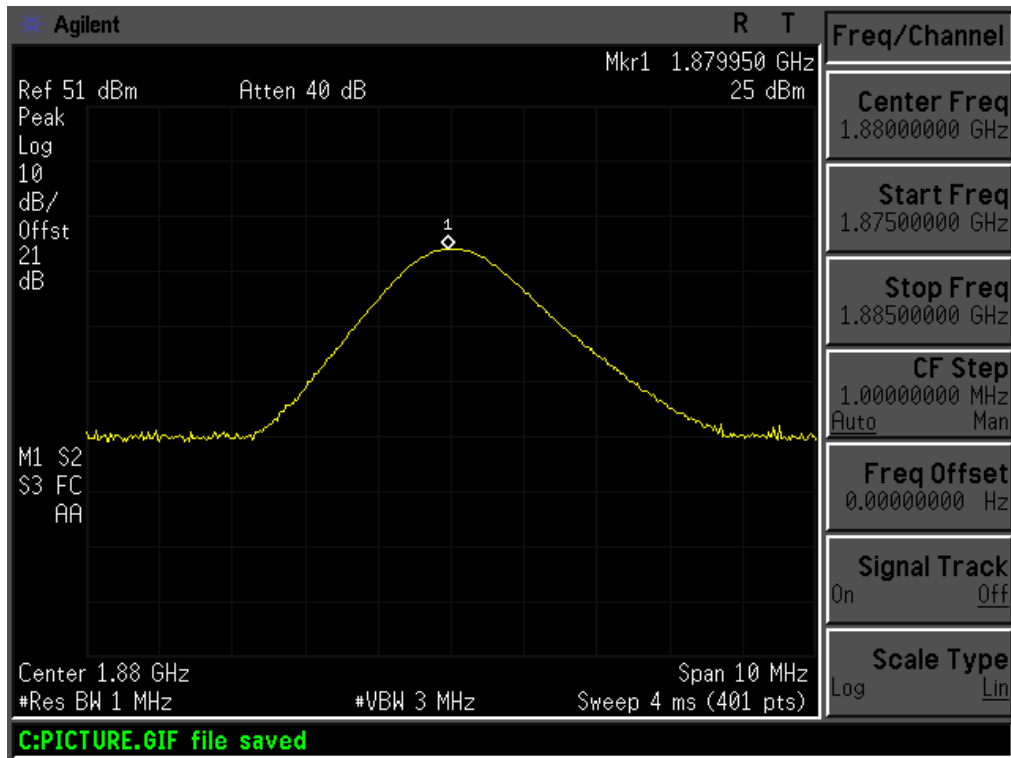

Channel 810

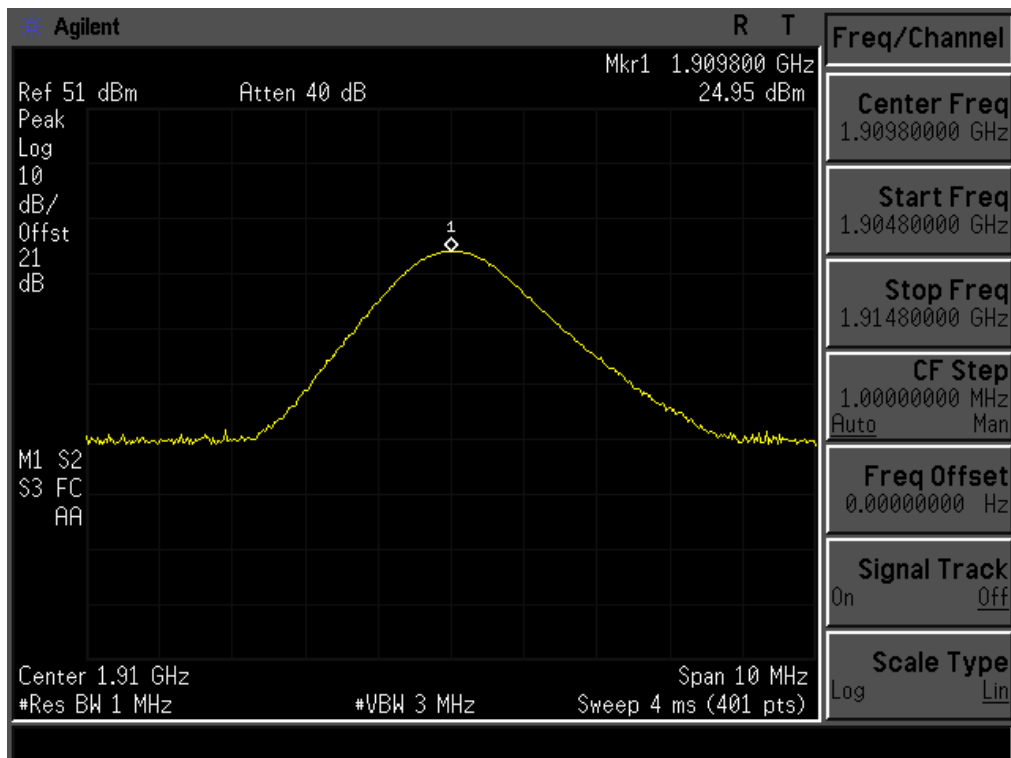



7. ERP & EIRP MEASUREMENT

7.1. Test Limit

According to FCC §2.1046

FCC 22.913(a): The Effective Radiated Power (ERP) of mobile transmitters must not exceed 7 Watts.

FCC 24.232(b): The equivalent Isotropic Radiated Power (EIRP) must not exceed 2 Watts.

7.2. Test Procedure

The EUT was placed on a non-conductive turntable using a non-conductive support. The radiated emission at the fundamental frequency was measured at 3 m with a test antenna and EMI spectrum analyzer.

During the measurement of the EUT, the resolution bandwidth was set to 3MHz and the average bandwidth was set to 3MHz. The highest emission was recorded with the rotation of the turntable and the lowering of the test antenna. The reading was recorded and the field strength (E in dBuV/m) was calculated.

ERP in frequency band 824-849MHz, and EIRP in frequency band 1850 –1910MHz were measured using a substitution method. The EUT was replaced by half-wave dipole (824-849MHz) or horn antenna (1850-1910MHz) connected to a signal generator. The spectrum analyzer reading was recorded and ERP/EIRP was calculated as follows:

$$\text{ERP} = \text{S.G. output (dBm)} + \text{Antenna Gain (dBd)} - \text{Cable (dB)}$$

$$\text{EIRP} = \text{S.G. output (dBm)} + \text{Antenna Gain (dBi)} - \text{Cable (dB)}$$



7.3. Test Setup Layout

Below 1 GHz

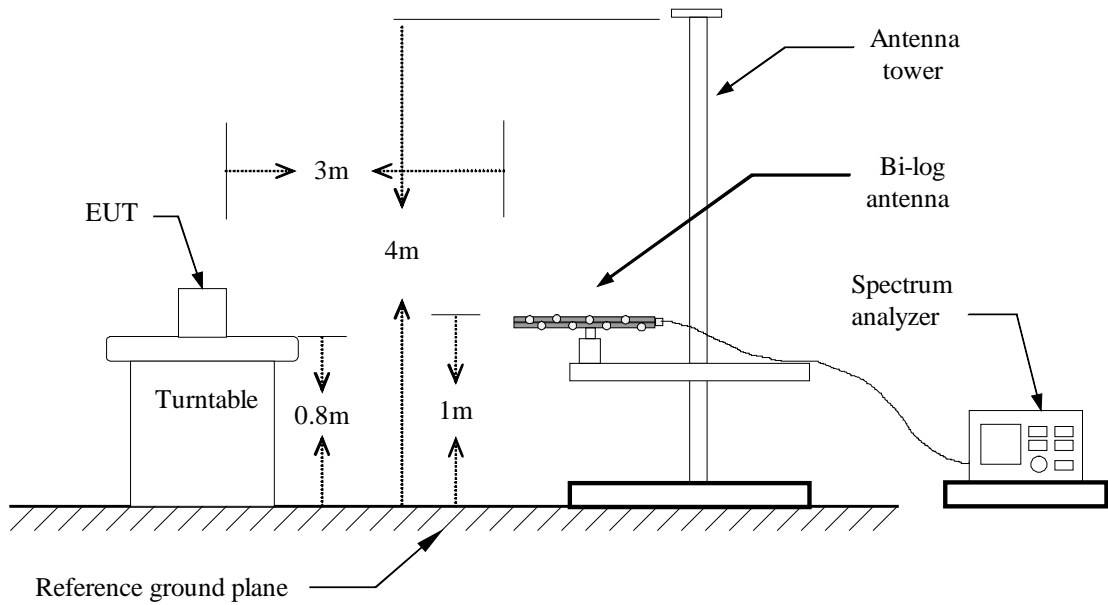

Above 1 GHz

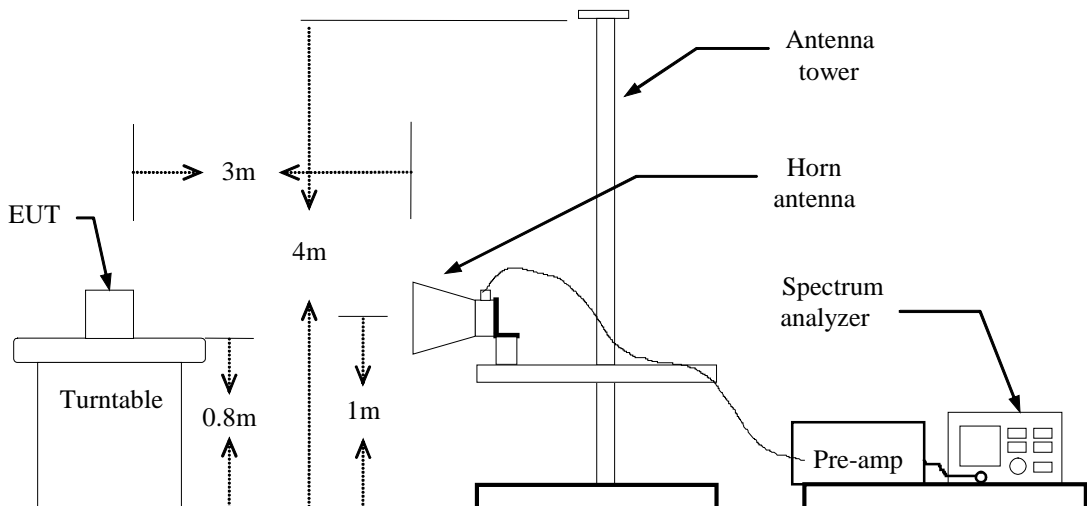



For Substituted Method Test Set-UP

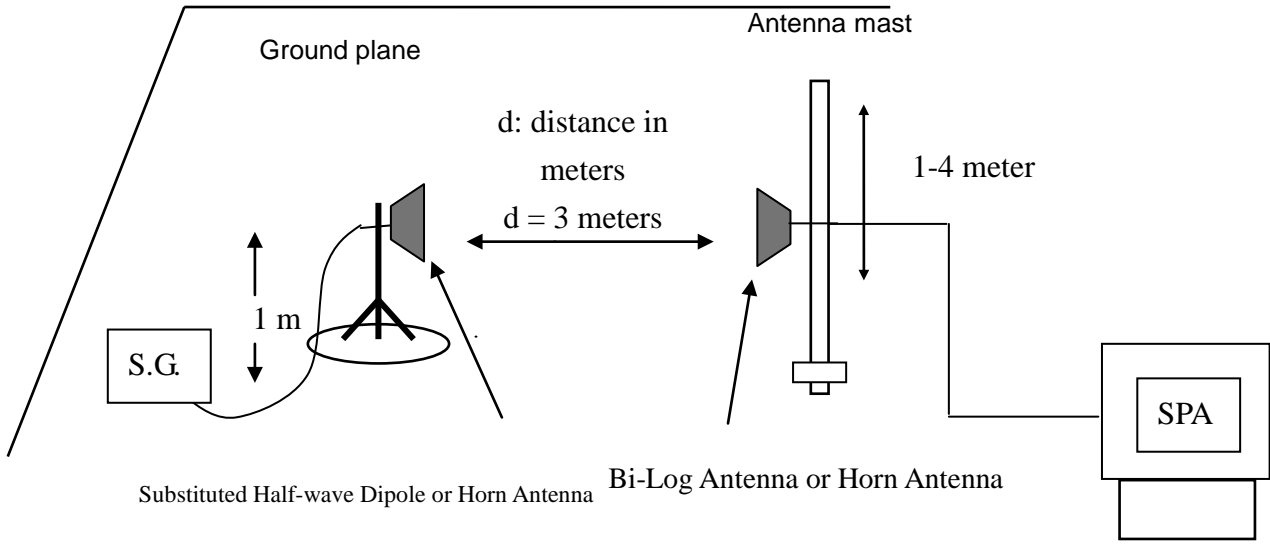

7.4. Measurement Equipment

Instrument/Ancillary	Manufacturer	Model No.	Serial No.	Calibration Date	Valid Date
Spectrum Analyzer	Agilent	E4407B	MY44211883	2013.09.25	2014.09.25
H64 Amplifier	HP	8447F	3113A05582	2014.03.24	2015.03.23
Preamplifier	Agilent	8449B	ED-HE-EMI-077	2014.03.24	2015.03.23
Broad-Band Horn Antenna	Schwarzbeck	BBHA9120D	9120D-619	2014.05.24	2015.05.23
Broad-Band Horn Antenna	Schwarzbeck	BBHA9120D	9120D-618	2014.05.24	2015.05.23
Temperature/Humidity Meter	Zhicheng	ZC1-11	CEP-TH-002	2014.03.31	2015.03.30



7.5. Test Result and Data

GSM 850 TEST DATA

Channel	Frequency (MHz)	Antenna Pol.	Reading level (Peak) (dB)	Correction Factor (dB)	Emission level (dBm)	Limit (dBm)	Margin (dB)
128	824.2	V	29.72	1.01	30.73	38.5	-7.77
	824.2	H	28.63	0.96	29.59	38.5	-8.91
190	836.6	V	29.33	1.77	31.1	38.5	-7.4
	836.6	H	28.85	1.46	30.31	38.5	-8.19
251	848.8	V	29.18	1.85	31.03	38.5	-7.47
	848.8	H	28.35	1.54	29.89	38.5	-8.61

GSM 1900 TEST DATA

Channel	Frequency (MHz)	Antenna Pol.	Reading level (Peak) (dB)	Correction Factor (dB)	Emission level (dBm)	Limit (dBm)	Margin (dB)
512	1852.4	V	25.27	2.34	27.61	33	-5.39
	1852.4	H	25.11	1.88	26.99	33	-6.01
661	1880	V	26.39	2.12	28.51	33	-4.49
	1880	H	25.4	2.41	27.81	33	-5.19
810	1907.6	V	26.29	2.34	28.63	33	-4.37
	1907.6	H	25.68	1.98	27.66	33	-5.34

**EDGE 850 TEST DATA**

Channel	Frequency (MHz)	Antenna Pol.	Reading level (Peak) (dB)	Correction Factor (dB)	Emission level (dBm)	Limit (dBm)	Margin (dB)
128	824.2	V	29.32	1.01	30.33	38.5	-8.17
	824.2	H	29.28	0.96	30.24	38.5	-8.26
190	836.6	V	29.74	1.77	31.51	38.5	-6.99
	836.6	H	28.67	1.46	30.13	38.5	-8.37
251	848.8	V	28.59	1.85	30.44	38.5	-8.06
	848.8	H	28.93	1.54	30.47	38.5	-8.03

EDGE 1900 TEST DATA

Channel	Frequency (MHz)	Antenna Pol.	Reading level (Peak) (dB)	Correction Factor (dB)	Emission level (dBm)	Limit (dBm)	Margin (dB)
512	1852.4	V	24.28	2.34	26.62	33	-6.38
	1852.4	H	23.31	1.88	25.19	33	-7.81
661	1880	V	23.08	2.12	25.2	33	-7.8
	1880	H	23.85	2.41	26.26	33	-6.74
810	1907.6	V	23.96	2.34	26.3	33	-6.7
	1907.6	H	23.47	1.98	25.45	33	-7.55



8. OUT OF BAND EMISSION AT ANTENNA TERMINALS

8.1. Test Limit

According to FCC §2.1051, FCC §22.917, FCC §24.238(a).

Out of Band Emissions: The mean power of emission must be attenuated below the mean power of the non-modulated carrier (P) on any frequency twice or more than twice the fundamental frequency by at least $43 + 10 \log P$ dB.

Mobile Emissions in Base Frequency Range: The mean power of any emissions appearing in the base station frequency range from cellular mobile transmitters operated must be attenuated to a level not exceed -80 dBm at the transmit antenna connector.

Band Edge Requirements: In the 1MHz bands immediately outside and adjacent to the frequency block, a resolution bandwidth of at least 1% of the emission bandwidth of the fundamental emission of the transmitter may be employed to measure the Out of band Emission.

8.2. Test Procedure

The RF output of the transceiver was connected to a spectrum analyzer through appropriate attenuation. The resolution bandwidth of the spectrum analyzer was set at 1MHz, sufficient scans were taken to show the out of band Emissions if any up to 10th harmonic.

For the out of band: Set the RBW, VBW = 1MHz, Start=30MHz, Stop= 10 th harmonic. Limit = -13dBm

Band Edge Requirements (824 MHz and 849 MHz /1850MHz and 1910MHz): In the 1 MHz bands immediately outside and adjacent to the frequency block, a resolution bandwidth of at least 1 percent of the emission bandwidth of the fundamental emission of the transmitter may be employed to measure the out of band Emissions. Limit, -13dBm.

8.3. Test Setup Layout

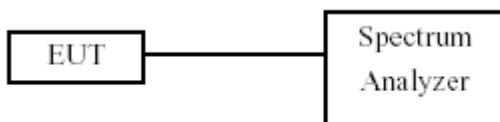

8.4. Measurement Equipment

Instrument/Ancillary	Model No.	Manufacturer	Serial No.	Calibration Date	Valid Date
Spectrum Analyzer	Agilent	E4407B	MY44211883	2014.09.12	2015.09.11
Temperature/ Humidity Meter	Zhicheng	ZC1-11	CEP-TH-002	2014.03.31	2015.03.30



8.5. Test Result and Data

Test Item	Conducted spurious emissions, 30MHz - 20GHz
Test Mode	GSM 850
Test Date	2015-02-23

Channel 128

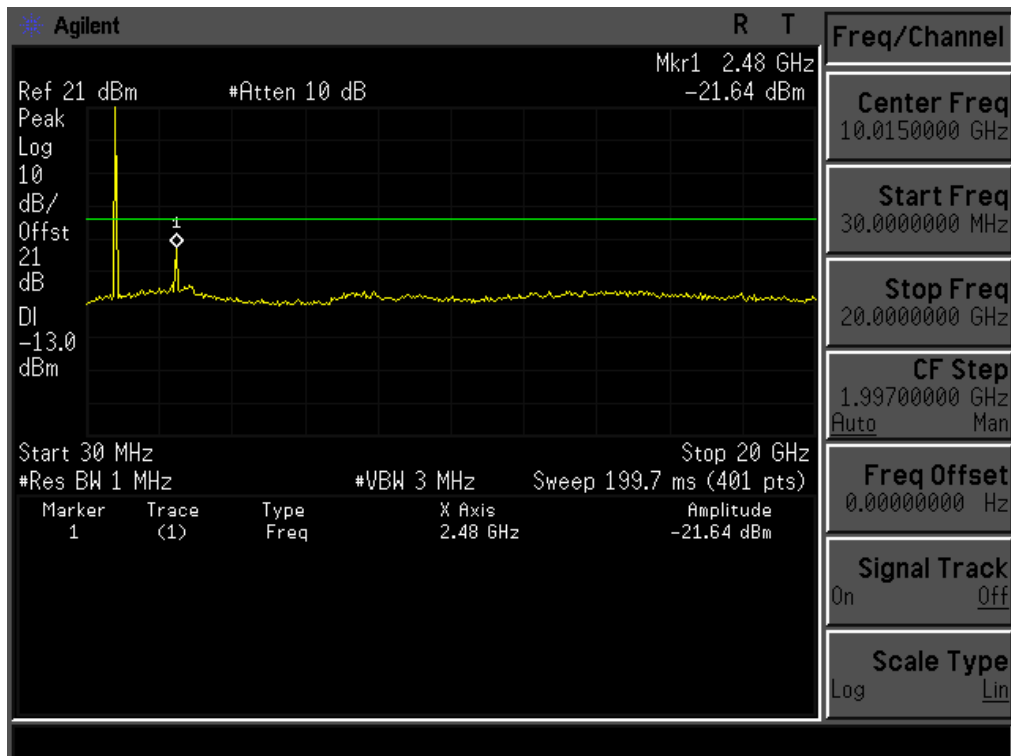



Channel 190

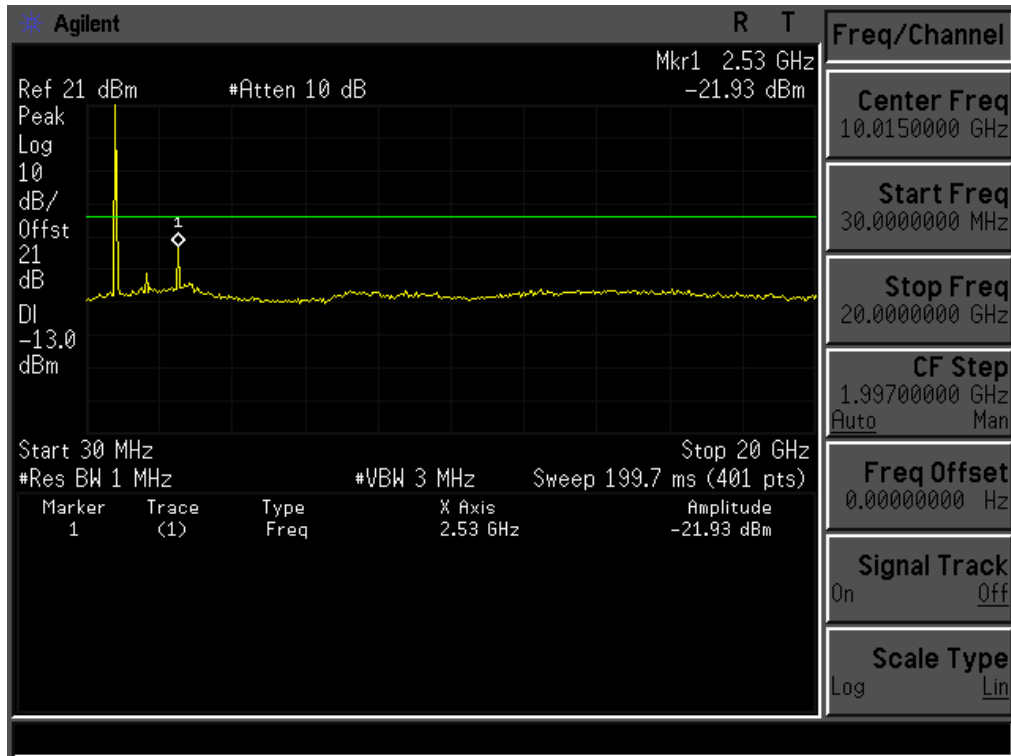

Channel 251

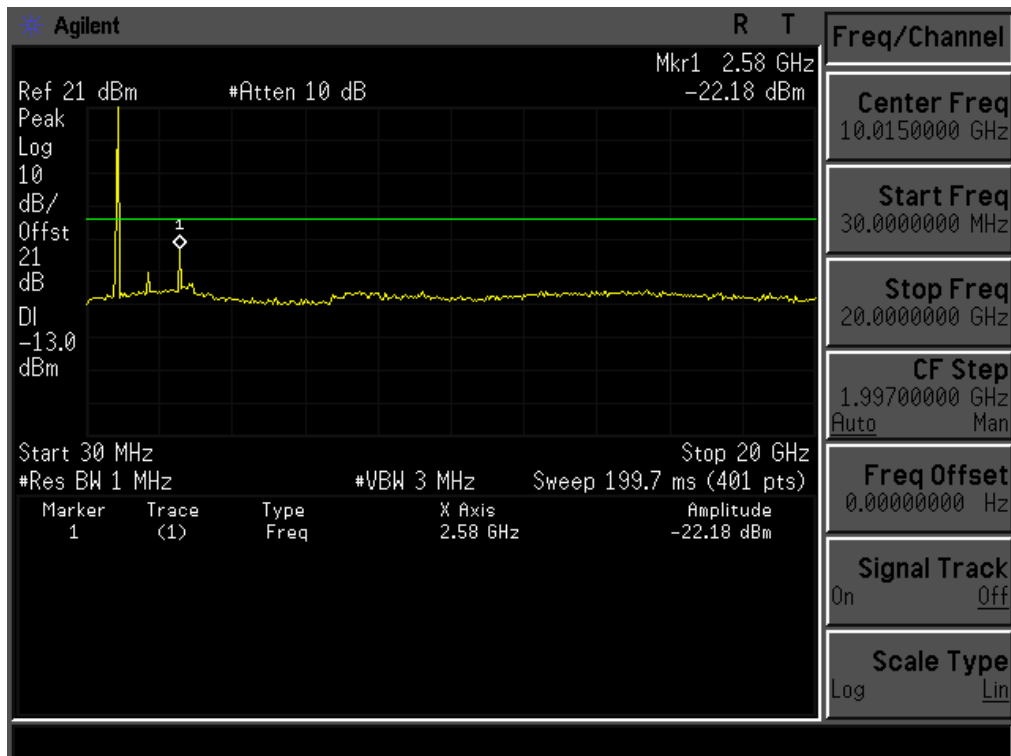



Test Item	Conducted spurious emissions, 30MHz - 20GHz
Test Mode	GSM 1900
Test Date	2015-02-23

Channel 512

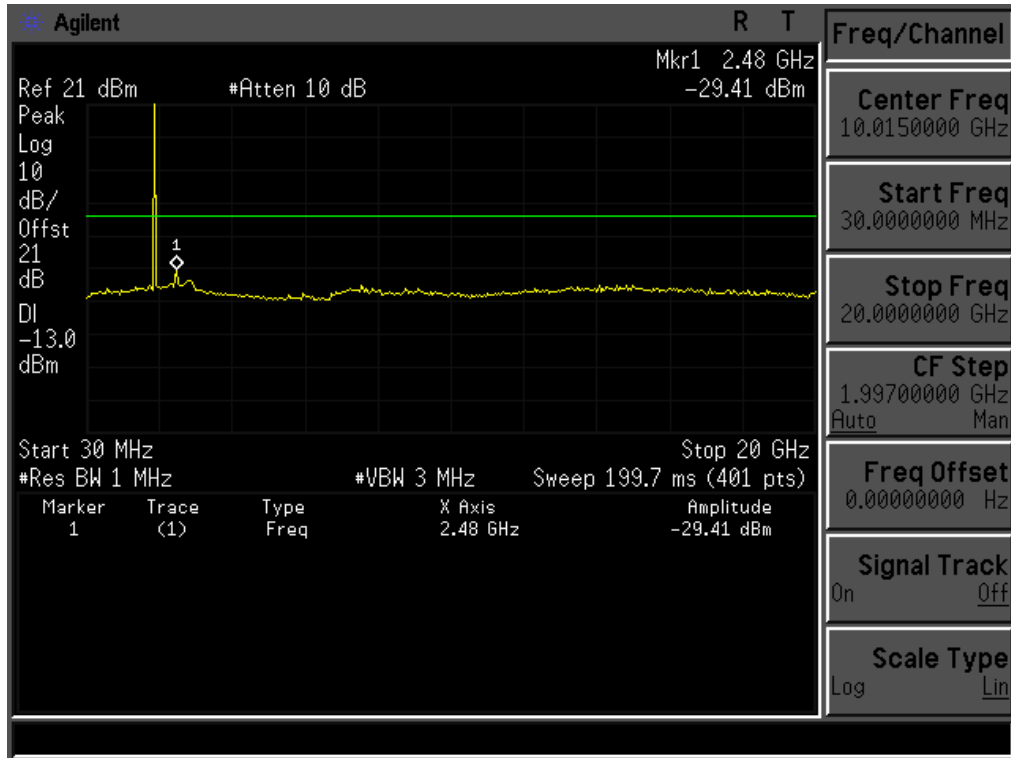



Channel 661

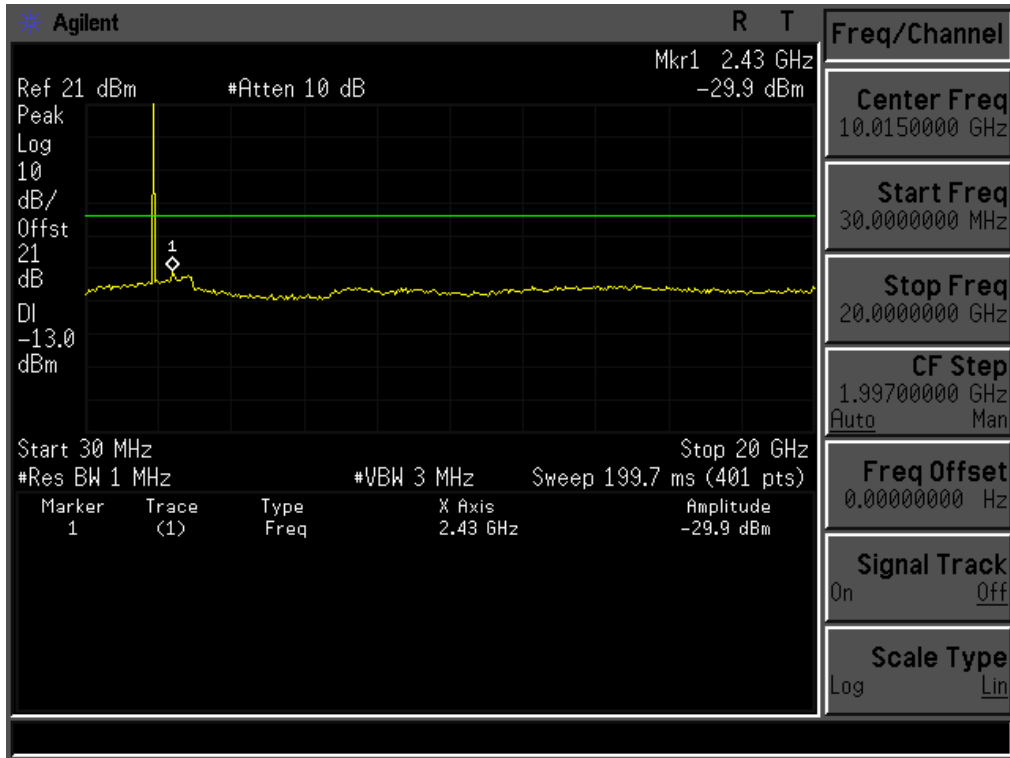

Channel 810

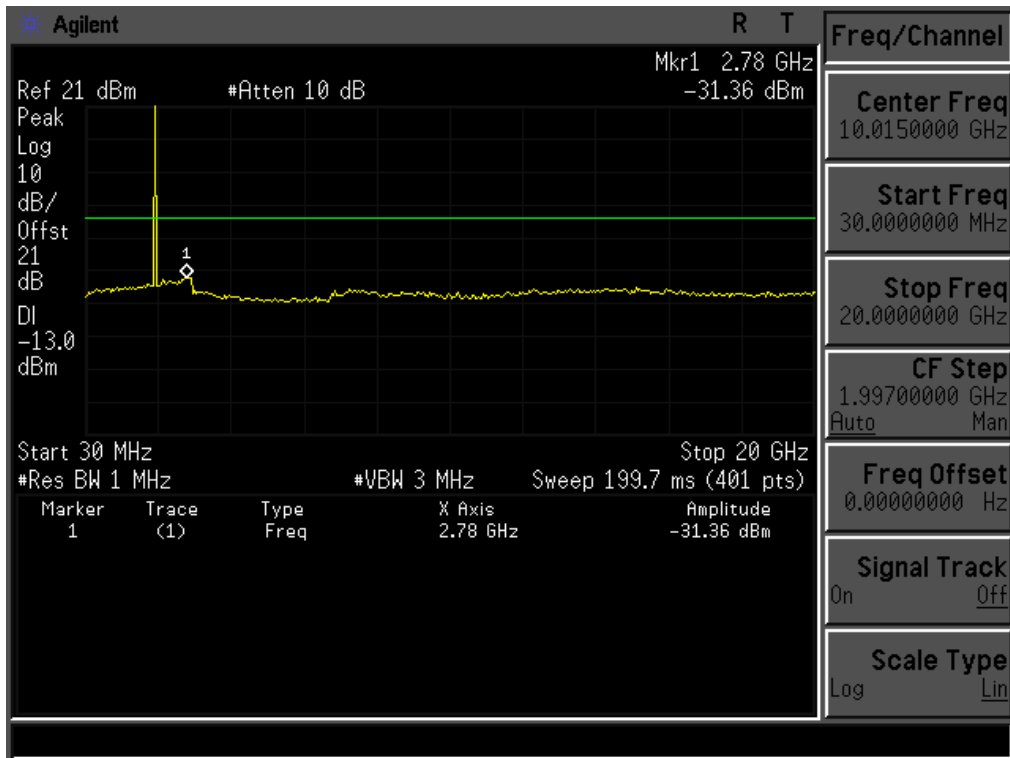



Test Item	Conducted spurious emissions, 30MHz - 20GHz
Test Mode	EDGE 850
Test Date	2015-02-23

Channel 128

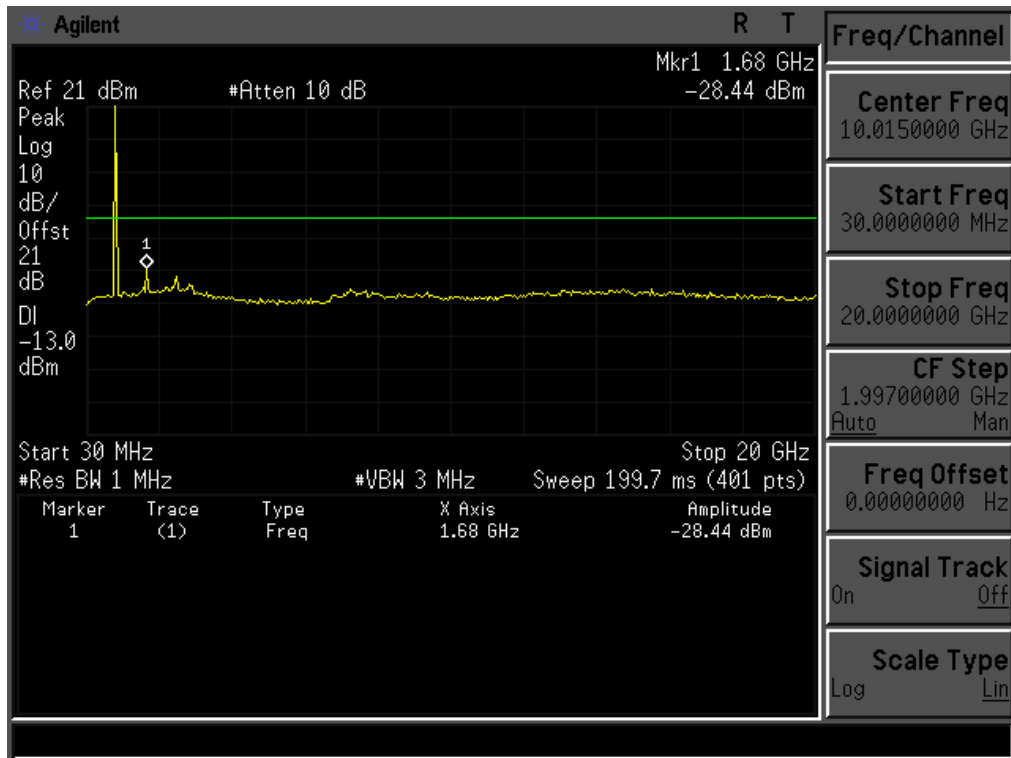



Channel 190

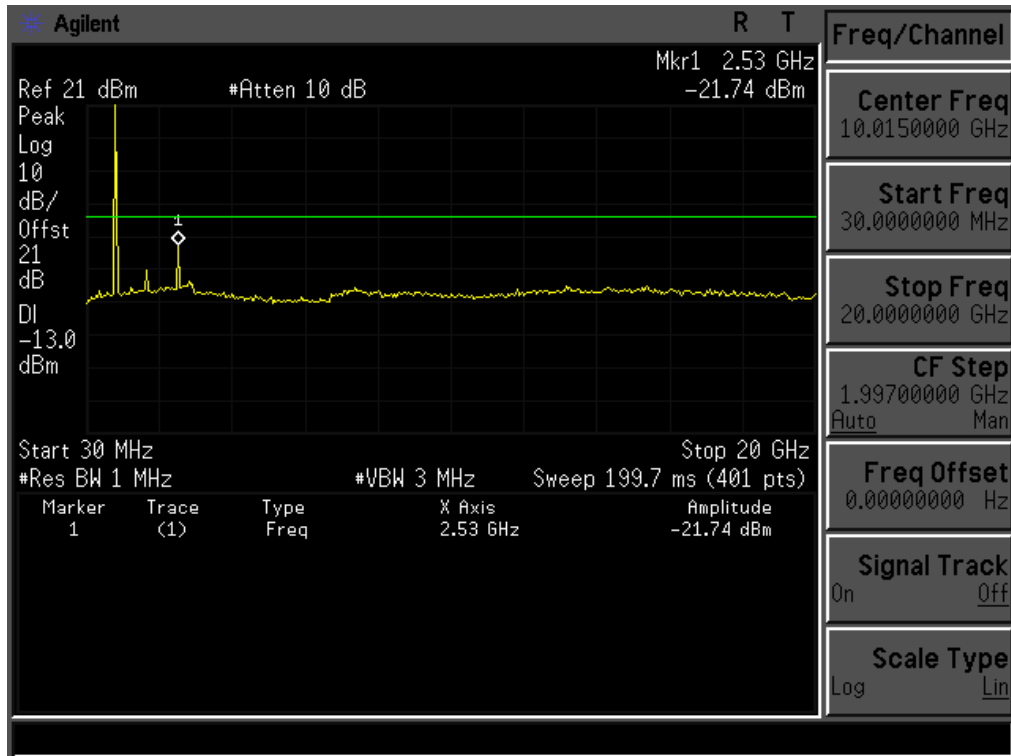

Channel 251

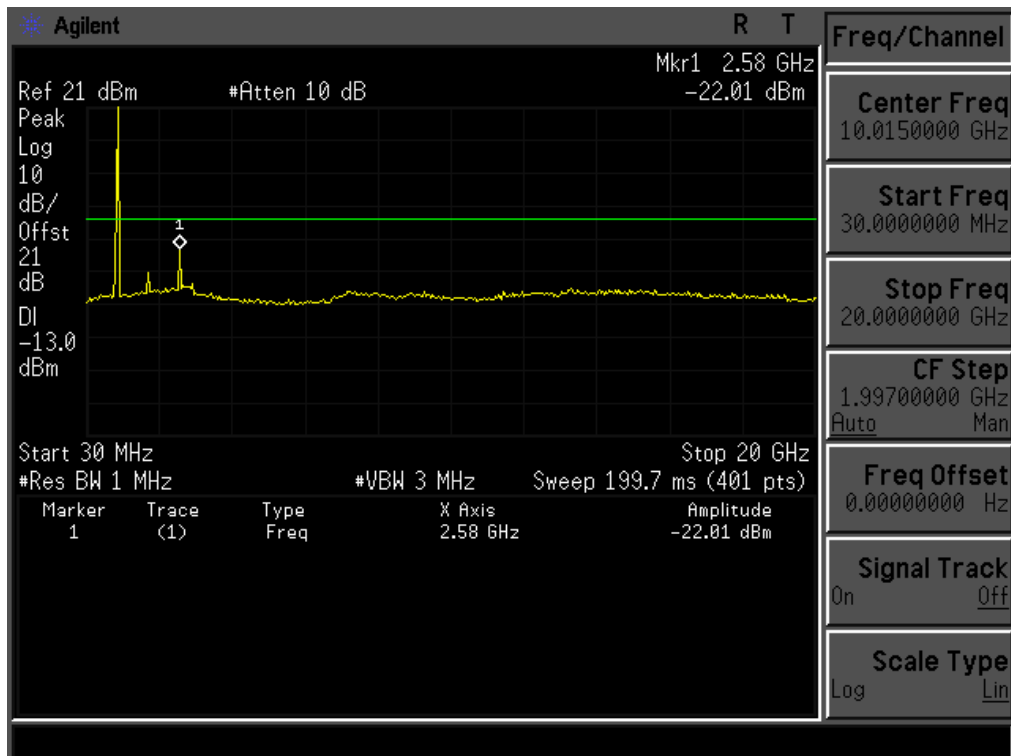



Test Item	Conducted spurious emissions, 30MHz - 20GHz
Test Mode	EDGE 1900
Test Date	2015-02-23

Channel 512

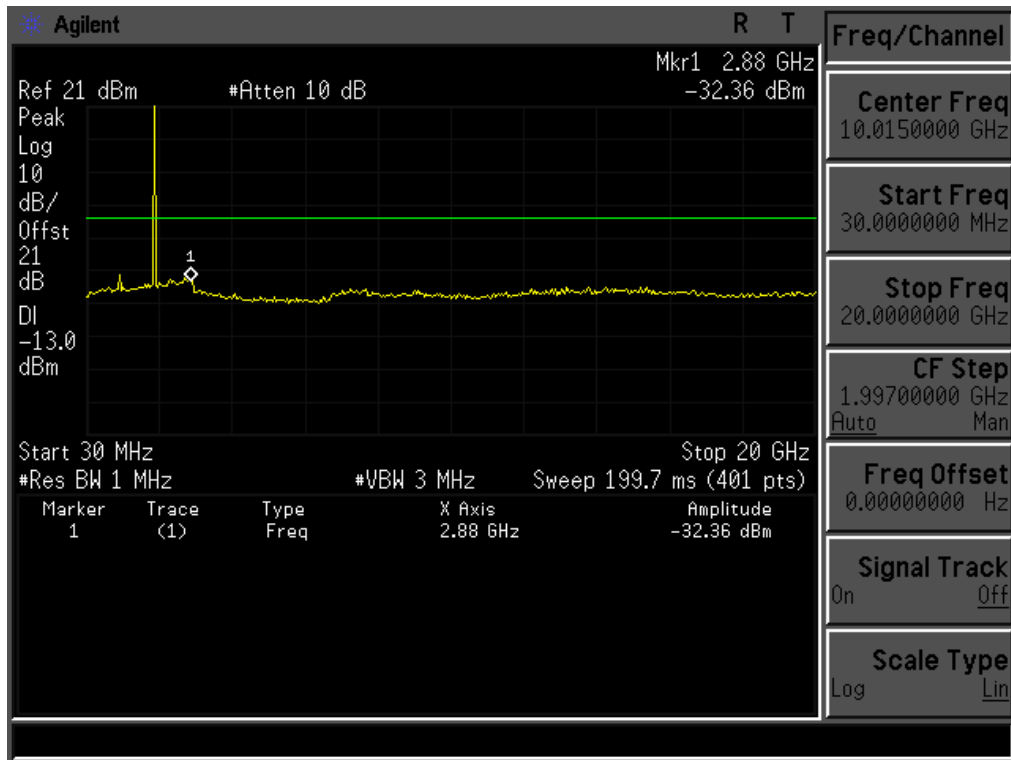



Channel 661

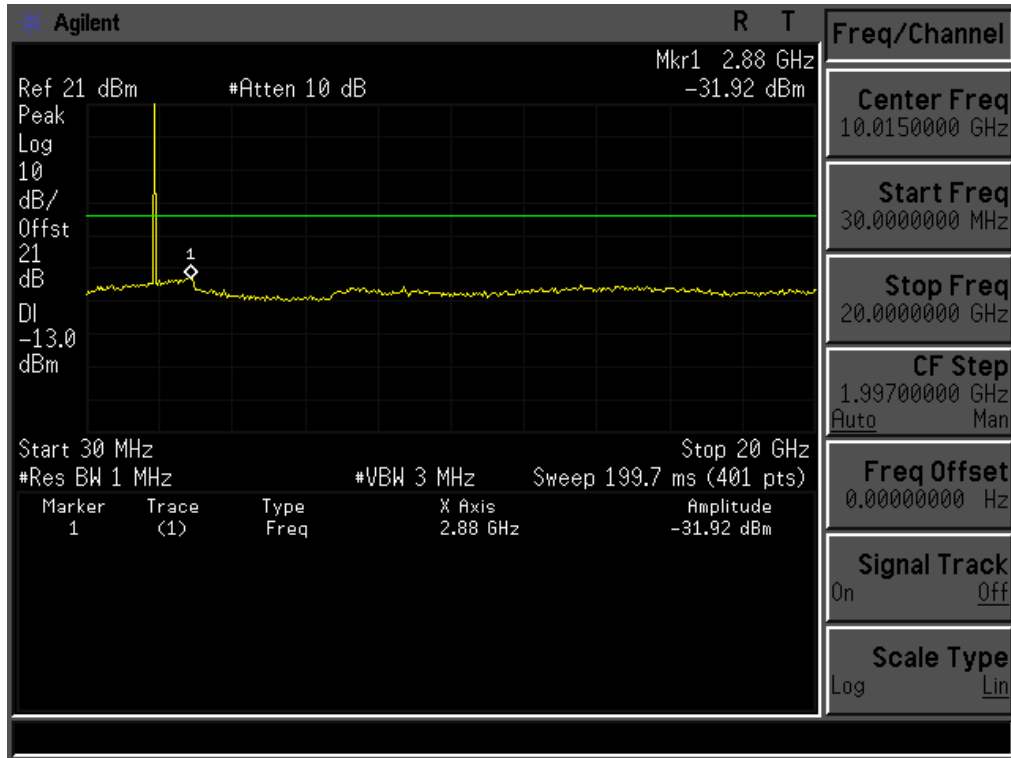

Channel 810

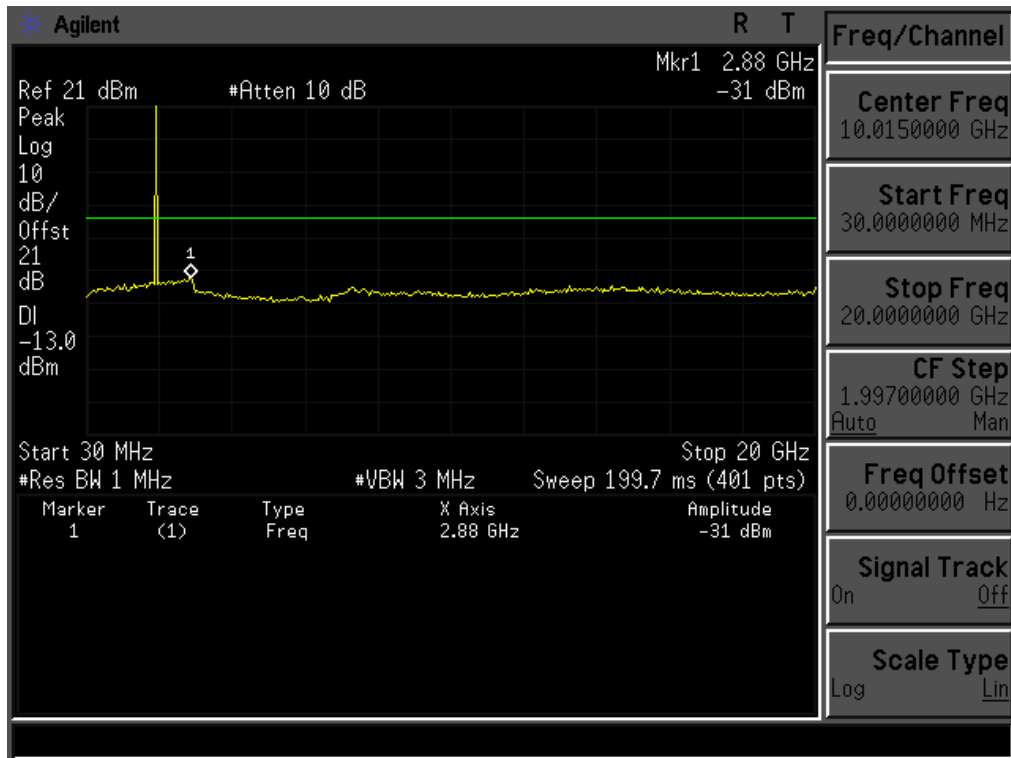



Test Item	Band Edge emissions
Test Mode	GSM 850
Test Date	2015-02-23

Figure Channel 128 (824.20MHz)

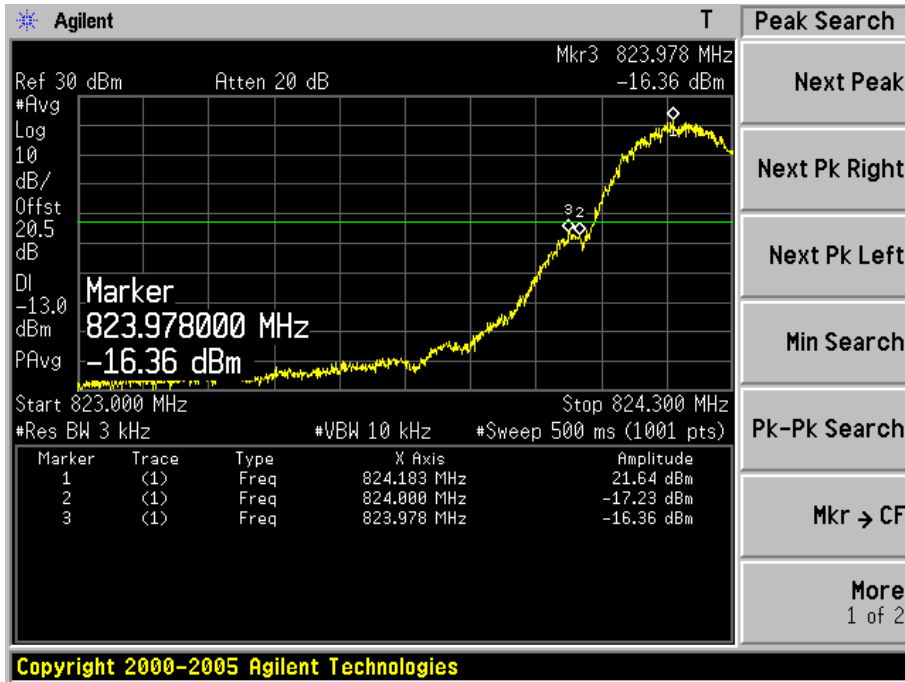
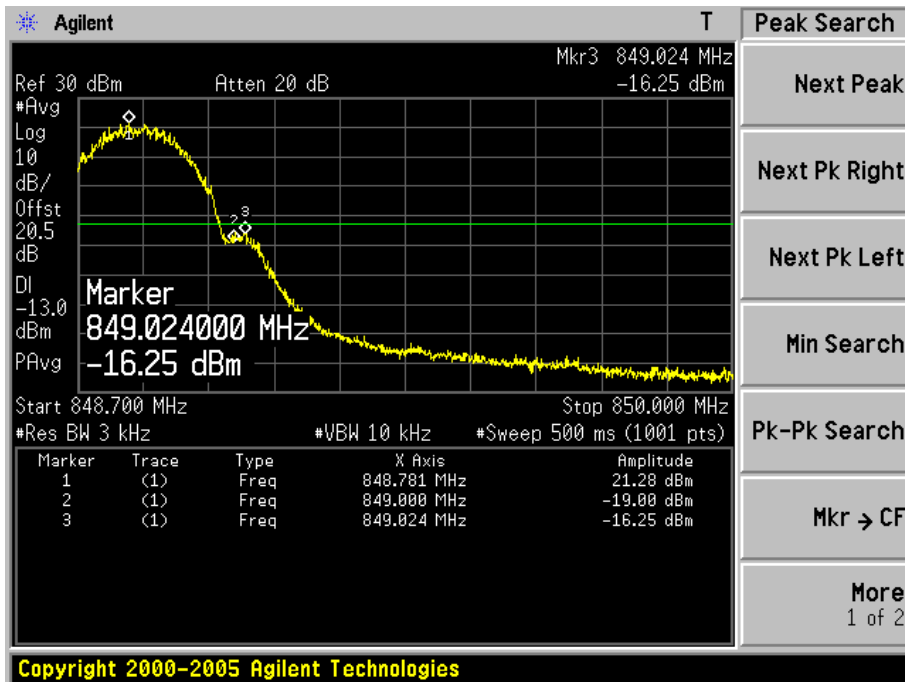

Figure Channel 251 (848.80MHz)





Test Item	Band Edge emissions
Test Mode	GSM 1900
Test Date	2015-02-23

Figure Channel 512 (1850.20MHz)

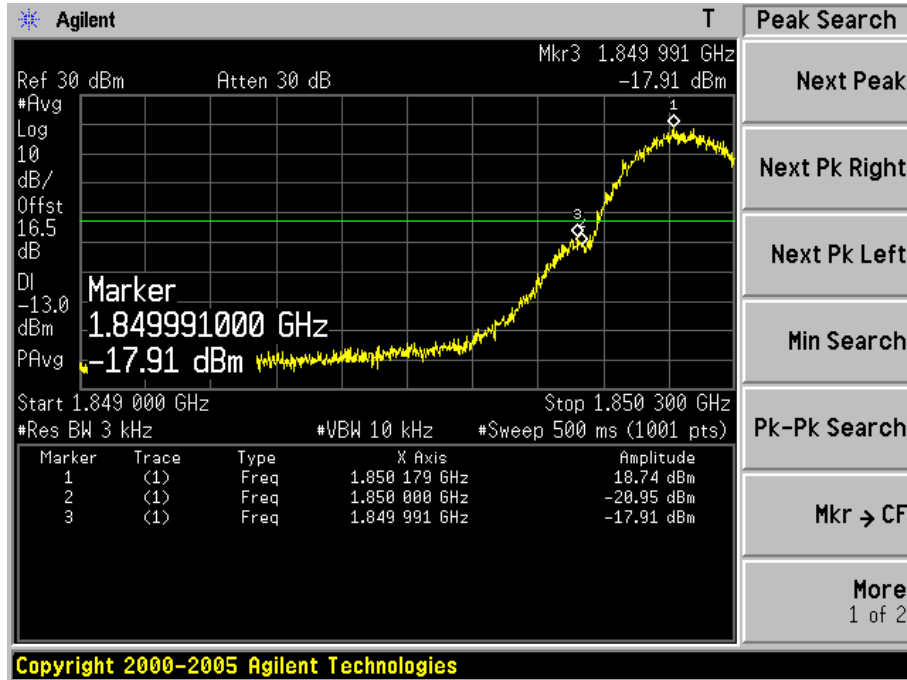
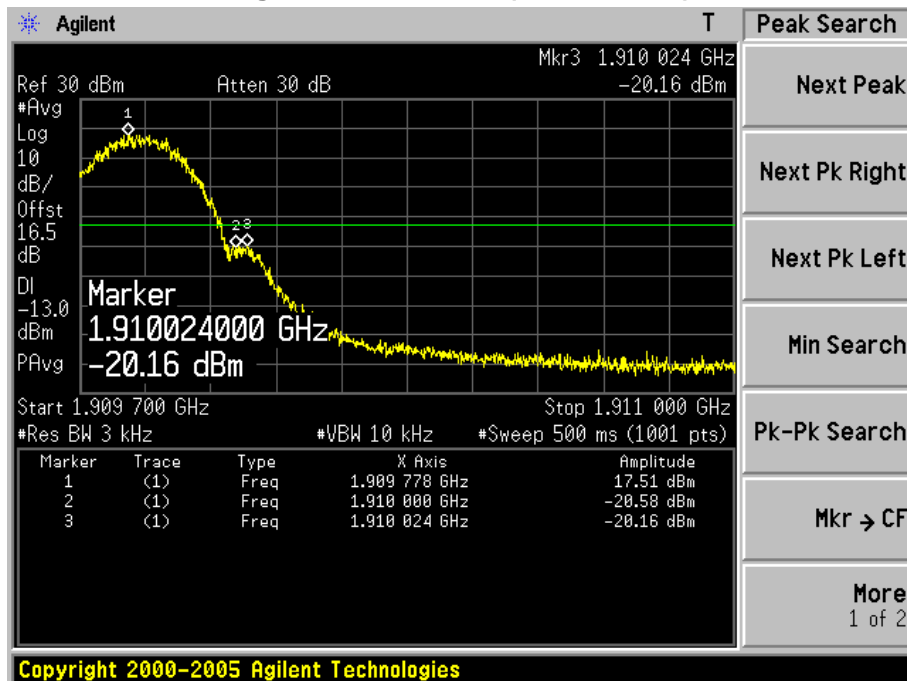

Figure Channel 810 (1909.80MHz)





Test Item	Band Edge emissions
Test Mode	EDGE 850
Test Date	2015-02-23

Figure Channel 128 (824.20MHz)

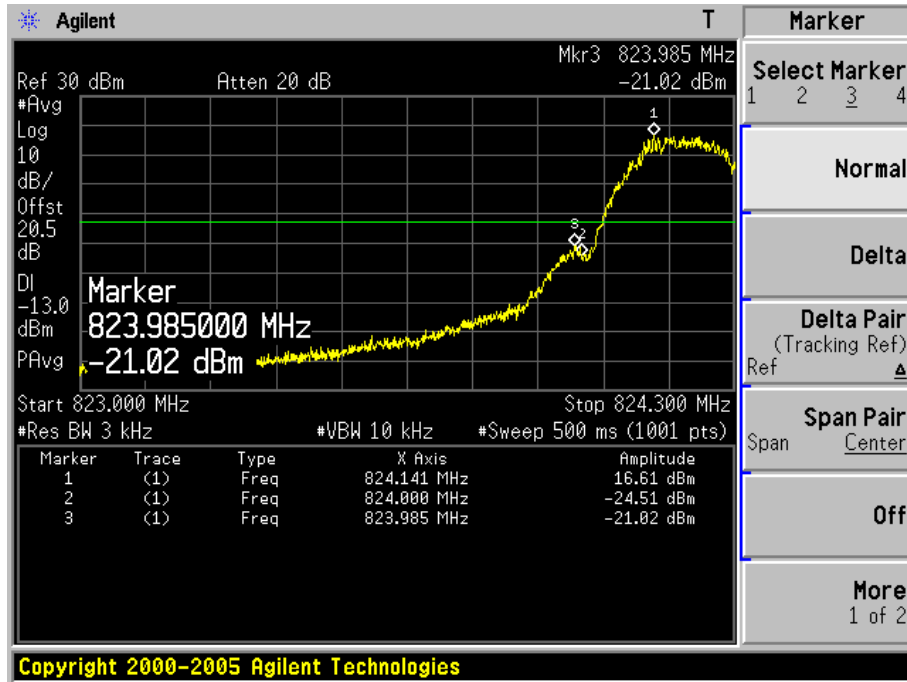
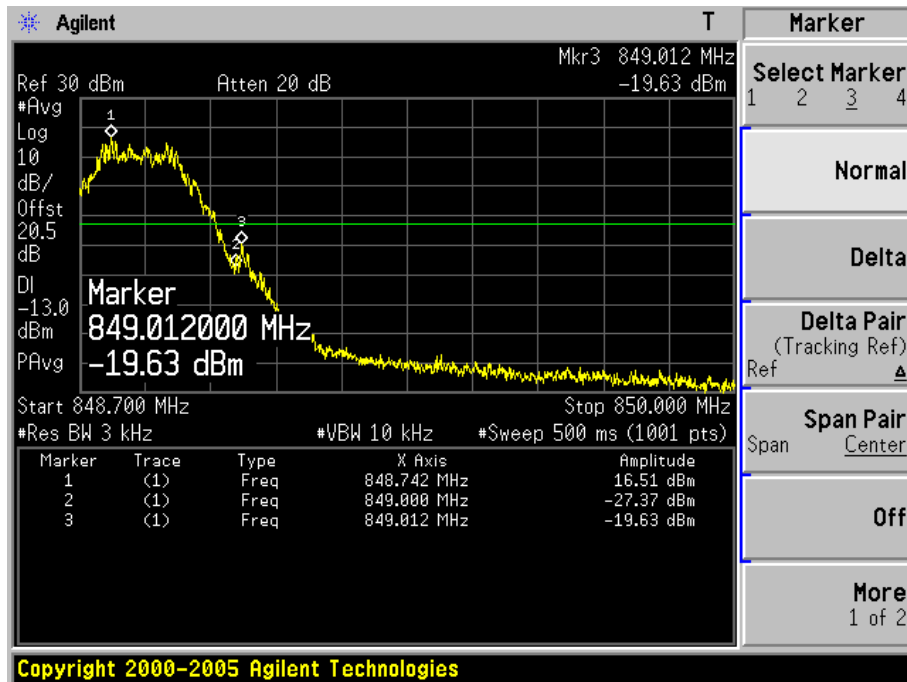

Figure Channel 251 (848.80MHz)





Test Item	Band Edge emissions
Test Mode	EDGE 1900
Test Date	2015-02-23

Figure Channel 512 (1850.20MHz)

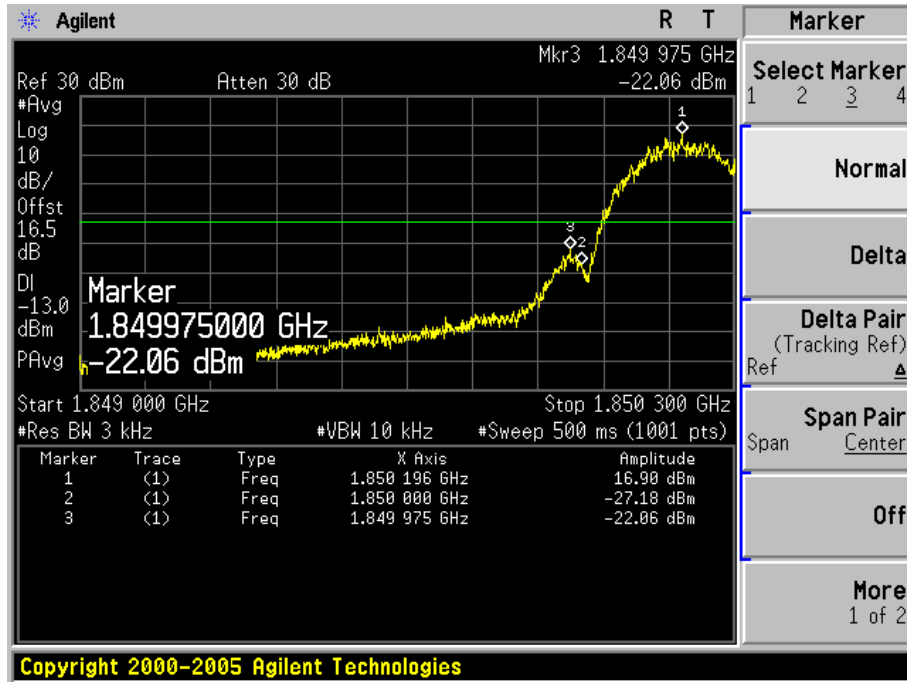
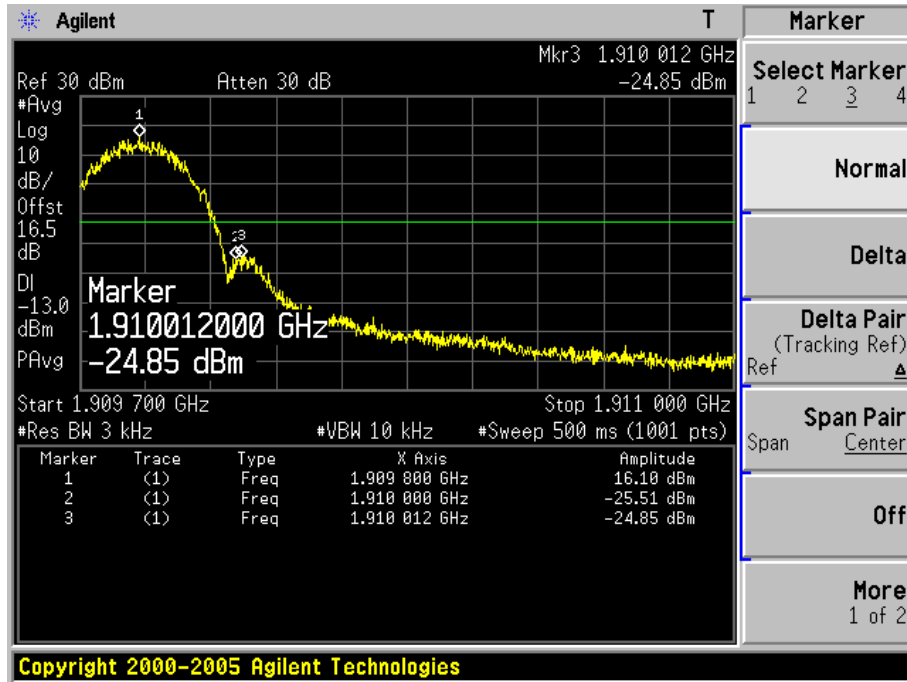

Figure Channel 810 (1909.80MHz)





9. FREQUENCY STABILITY V.S. TEMPERATURE MEASUREMENT

9.1. Test Limit

According to FCC §2.1055, FCC §22.355, .FCC §24.235.

Frequency Tolerance: 2.5 ppm

9.2. Test Procedure

The equipment under test was connected to an external AC or DC power supply and input rated voltage. RF output was connected to a frequency counter or spectrum analyzer via feed through attenuators. The EUT was placed inside the temperature chamber. Set the spectrum analyzer RBW low enough to obtain the desired frequency resolution and measure EUT 20°C operating frequency as reference frequency. Turn EUT off and set the chamber temperature to -30°C. After the temperature stabilized for approximately 30 minutes recorded the frequency. Repeat step measure with 10°C increased per stage until the highest temperature of +50°C reached.

9.3. Test Setup Layout

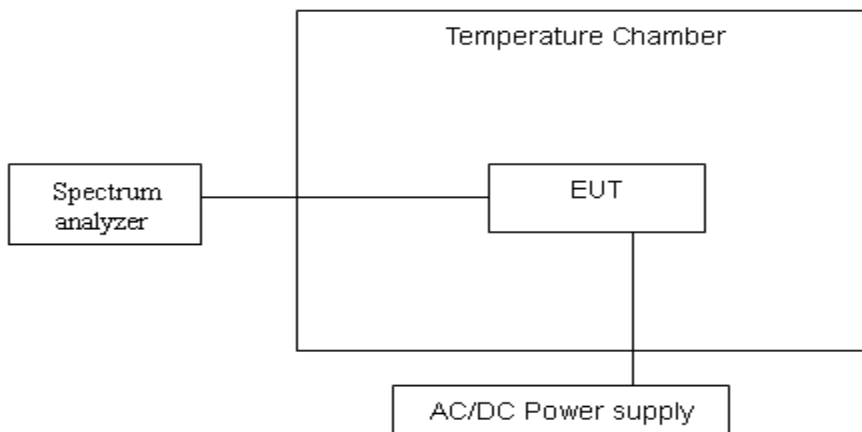

9.4. Measurement Equipment

Instrument/Ancillary	Model No.	Manufacturer	Serial No.	Calibration Date	Valid Date
Spectrum Analyzer	Agilent	E4407B	MY44211883	2014.09.12	2015.09.11
Temperature/ Humidity Meter	Zhicheng	ZC1-11	CEP-TH-002	2014.03.31	2015.03.30



9.5. Test Result and Data

Test Item	FREQUENCY STABILITY V.S. TEMPERATURE
Test Mode	GSM 850 Channel 190
Test Date	2015-02-23

Reference Frequency: 836.6 MHz @ 20°C				
Limit: +/- 2.5 ppm = 2090 Hz				
Power Supply Vac	Environment Temperature (°C)	Frequency (Hz)	Delta (Hz)	Limit (Hz)
3.7	50	836600059	59	2090
	40	836600028	28	
	30	836600008	08	
	20	836600000	0	
	10	836600041	41	
	0	836600026	26	
	-30	836600063	63	

Test Item	FREQUENCY STABILITY V.S. TEMPERATURE
Test Mode	GSM 1900 Channel 661
Test Date	2015-02-23

Reference Frequency: 1880 MHz @ 20°C				
Limit: ± 2.5 ppm = 4700 Hz				
Power Supply Vac	Environment Temperature (°C)	Frequency (Hz)	Delta (Hz)	Limit (Hz)
3.7	50	1880000009	09	4700
	40	1880000051	51	
	30	1880000032	32	
	20	1880000000	0	
	10	1880000012	12	
	0	1880000039	39	
	-30	1880000015	15	



Test Item	FREQUENCY STABILITY V.S. TEMPERATURE
Test Mode	EDGE 850 Channel 190
Test Date	2015-02-23

Reference Frequency: 836.6 MHz @ 20°C				
Limit: +/- 2.5 ppm = 2090 Hz				
Power Supply Vac	Environment Temperature (°C)	Frequency (Hz)	Delta (Hz)	Limit (Hz)
3.7	50	836600023	23	2090
	40	836600031	31	
	30	836600044	44	
	20	836600000	0	
	10	836600031	31	
	0	836600009	9	
	-30	836600023	23	

Test Item	FREQUENCY STABILITY V.S. TEMPERATURE
Test Mode	EDGE 1900 Channel 661
Test Date	2015-02-23

Reference Frequency: 1880 MHz @ 20°C				
Limit: ± 2.5 ppm = 4700 Hz				
Power Supply Vac	Environment Temperature (°C)	Frequency (Hz)	Delta (Hz)	Limit (Hz)
3.7	50	1880000011	11	4700
	40	1880000047	47	
	30	1880000033	33	
	20	1880000000	0	
	10	1880000036	36	
	0	1880000040	40	
	-30	1880000021	21	



10. FREQUENCY STABILITY V.S. VOLTAGE MEASUREMENT

10.1. Test Limit

According to FCC §2.1055, FCC §22.355, .FCC §24.235.

10.2. Test Procedure

Set chamber temperature to 20°C. Use a variable AC power supply / DC power source to power the EUT and set the voltage to rated voltage. Set the spectrum analyzer RBW low enough to obtain the desired frequency resolution and recorded the frequency.

Reduce the input voltage to specify extreme voltage variation ($\pm 10\%$) and endpoint, record the maximum frequency change.

10.3. Test Setup Layout

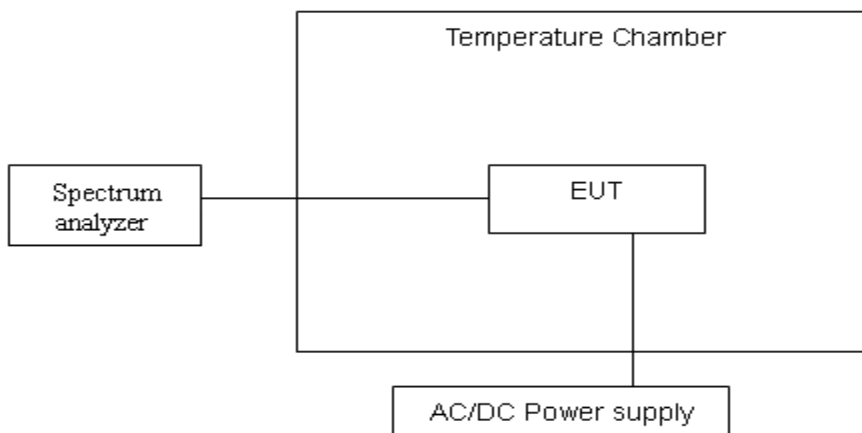

10.4. Measurement Equipment

Instrument/Ancillary	Model No.	Manufacturer	Serial No.	Calibration Date	Valid Date
Spectrum Analyzer	Agilent	E4407B	MY44211883	2014.09.12	2014.09.25
Temperature/ Humidity Meter	Zhicheng	ZC1-11	CEP-TH-002	2014.03.31	2015.03.30



10.5. Test Result and Data

Test Item	REQUENCY STABILITY V.S. VOLTAGE
Test Mode	GSM 850 Channel 190
Test Date	2015-02-23

Reference Frequency: 836.6 MHz @ 20°C				
Limit: ± 2.5 ppm = 2090Hz				
Power Supply Vac	Environment Temperature (°C)	Frequency (Hz)	Delta (Hz)	Limit (Hz)
4.1	20	836599971	29	2090
3.7		836600000	0	
3.3		836599982	18	

Test Item	REQUENCY STABILITY V.S. VOLTAGE
Test Mode	GSM 1900 Channel 661
Test Date	2015-02-23

Reference Frequency: 1880 MHz @ 20°C				
Limit: ± 2.5 ppm = 4700 Hz				
Power Supply Vac	Environment Temperature (°C)	Frequency (Hz)	Delta (Hz)	Limit (Hz)
4.1	20	1879999985	15	4700
3.7		1880000000	0	
3.3		1879999974	26	



Test Item	REQUENCY STABILITY V.S. VOLTAGE
Test Mode	EDGE 850 Channel 190
Test Date	2015-02-23

Reference Frequency: 836.6 MHz @ 20°C				
Limit: ± 2.5 ppm = 2090Hz				
Power Supply Vac	Environment Temperature (°C)	Frequency (Hz)	Delta (Hz)	Limit (Hz)
4.1	20	836599982	18	2090
3.7		836600000	0	
3.3		836599979	21	

Test Item	REQUENCY STABILITY V.S. VOLTAGE
Test Mode	EDGE 1900 Channel 661
Test Date	2015-02-23

Reference Frequency: 1880 MHz @ 20°C				
Limit: ± 2.5 ppm = 4700 Hz				
Power Supply Vac	Environment Temperature (°C)	Frequency (Hz)	Delta (Hz)	Limit (Hz)
4.1	20	1879999979	21	4700
3.7		1880000000	0	
3.3		1879999992	08	



11. Receiver Spurious Emission for RSS 132/133

11.1. Test Equipment

Receiver Spurious Emission / AC104

Instrument	Manufacturer	Type No.	Serial No	Cali. Due Date
PSA Series Spectrum Analyzer	Agilent	E4407B	MY44211883	2015.09.11
Dual Directional Coupler	Agilent	778D	20160	2015.05.30
10dB Coaxial Coupler	Agilent	87300C	MY44300299	2015.09.23
Signal Generator	RS	SMR30	100049	2015.03.23
Signal Generator	RS	SML03	103287	2015.03.23
Preamplifier	EMCI	EMC-051835	980085	2015.09.03
Preamplifier	Agilent	8449B	ED-HE-EMI-077	2015.03.23
Bilog Antenna	Teseq GmbH	CBL6112D	27612	2015.05.15
Half Wave Tuned Dipole Antenna	SCHWARZBECK	VHAP	01141	2015.08.23
Broad-Band Horn Antenna	Schwarzbeck	BBHA9120D	9120D-619	2015.05.23
Broad-Band Horn Antenna	Schwarzbeck	BBHA9120D	9120D-618	2015.05.23
Temperature/ Humidity Meter	Zhicheng	ZC1-11	CEP-TH-002	2015.03.30
Radio Communication Tester	R&S	CMU200	108823	2015.03.23

11.2. Test Setup

Receiver Spurious Emission Under 1GHz Test Setup:

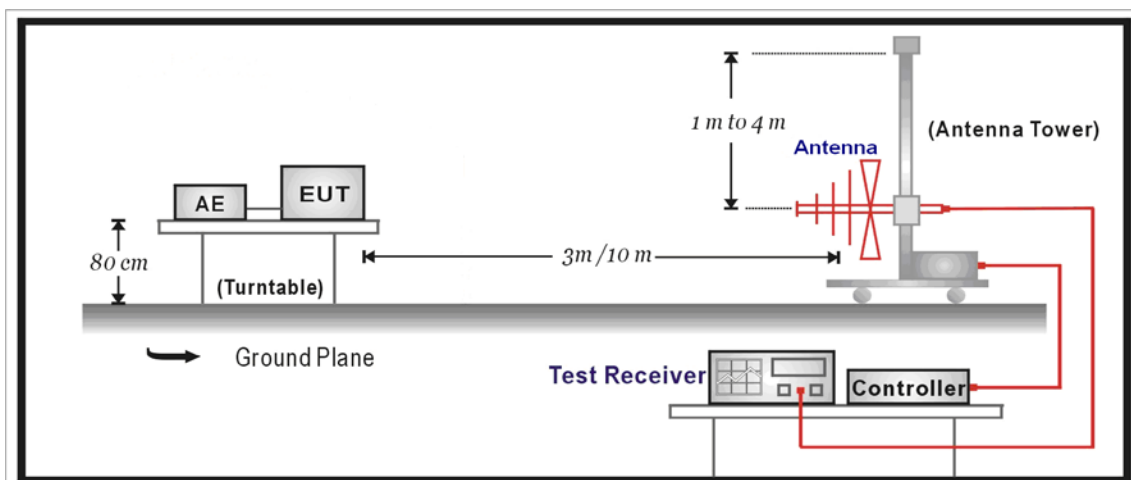



Receiver Spurious Emission Above 1GHz Test Setup:

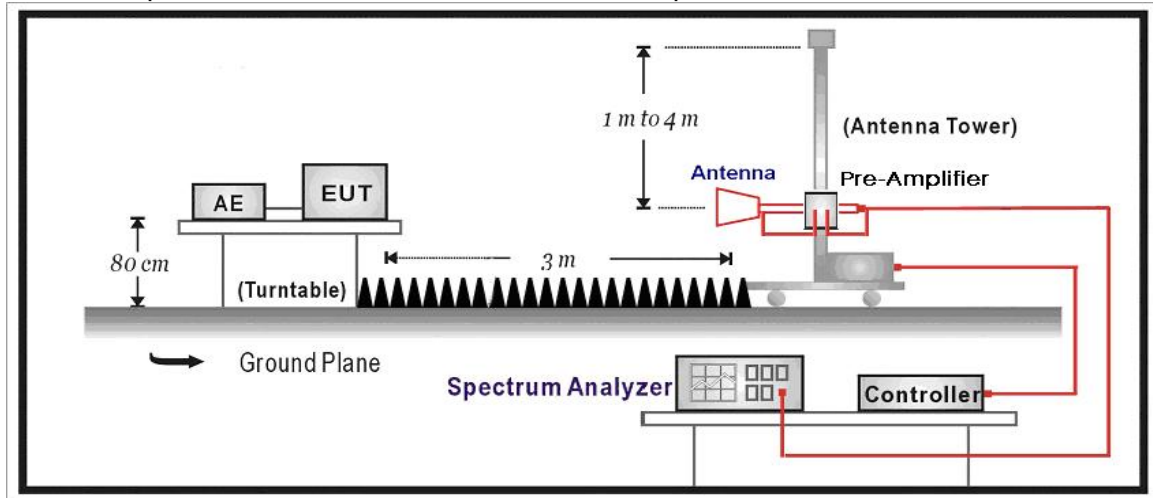

11.3.Limit

According to Standard RSS132/133 refer to RSS-Gen Issue 3.

Field Strength micro-volts/m at 3 meters		
Frequency (MHz)	Distance (m)	Level (dBuV/m)
30 - 88	3	40
88 - 216	3	43.5
216 - 960	3	46
Above 960	3	54

Note 1: The lower limit shall apply at the transition frequency.

Note 2: Distance refers to the distance in meters between the measuring instrument antenna and the closed point of any part of the device or system.

Note 3: E field strength (dBuV/m) = 20 log E field strength (uV/m)

11.4.Test Procedure



The EUT and its simulators are placed on a turn table which is 0.8 meter above ground. The turn table can rotate 360 degrees to determine the position of the maximum emission level. The EUT was positioned such that the distance from antenna to the EUT was 3 meters.

The antenna can move up and down between 1 meter and 4 meters to find out the maximum emission level.

Both horizontal and vertical polarization of the antenna are set on measurement. In order to find the maximum emission, all of the interface cables must be manipulated on radiated measurement.

On any frequency or frequencies below or equal to 1000 MHz, the radiated limits shown are based on measuring equipment employing a quasi-peak detector function and above 1000 MHz, the radiated limits shown are based measuring equipment employing an average detector function.

When average radiated emission measurement are included emission measurement Above 1000 MHz, there also is a limit on the radio frequency emissions, as measured using instrumentation with a peak detector function, corresponding to 20 dB above the maximum permitted average limit.

For class A, the measurement distance between the EUT and antenna is 10 meters for under 1GHz and above 1GHz.

For class B, the measurement distance between the EUT and antenna is 3 meters for under 1GHz and 3 meters for above 1GHz.

The bandwidth below 1GHz setting on the field strength meter (R&S Test Receiver ESCI) is 120 kHz and above 1GHz is 1MHz.

Note: When measurement above 1GHz, the horn antenna will bend down a little (as horn antenna have the narrow beamwidth) in order to find the maximum emission of EUT



11.5. Test Result

Mode1: GSM 850 Idle

CH	Antenna	Frequency (MHz)	Reading Level (dBuV/m)	Factor (dB)	Measure Level (dBuV/m)	Limit (dBuV/m)	Margin (dB)	Detector
128	H	293.4	4.9	20.3	25.2	46.0	-20.8	QP
	V	651.8	5.4	27.4	32.8	46.0	-13.2	QP
	H	2725.5	36.4	1.4	37.8	54.0(Note1)	-16.2	PK
	V	5607.0	27.1	9.7	36.8	54.0(Note1)	-17.2	PK
190	H	319.7	4.8	21.3	26.1	46.0	-19.9	QP
	V	715.8	4.9	28.0	32.9	46.0	-13.1	QP
	H	2836.0	35.7	1.6	37.3	54.0(Note1)	-16.7	PK
	V	5811.0	23.7	10.0	33.7	54.0(Note1)	-20.3	PK
251	H	343.3	4.6	21.9	26.5	46.0	-19.5	QP
	V	750.0	5.5	28.5	34.0	46.0	-12.0	QP
	H	2938.0	35.3	1.6	36.9	54.0(Note1)	-17.1	PK
	V	5998.0	26.4	10.3	36.7	54.0(Note1)	-17.3	PK

Note1: This limit applies for using average detector, if the test result on peak is lower than average limit, then average measurement needn't be performed.



Mode 2: GSM 1900 Idle

CH	Antenna	Frequency (MHz)	Reading Level (dBuV/m)	Factor (dB)	Measure Level (dBuV/m)	Limit (dBuV/m)	Margin (dB)	Detector
512	H	257.6	4.9	19.9	24.8	46.0	-21.2	QP
	V	537.9	5.5	26.3	31.8	46.0	-14.2	QP
	H	3048.5	35.2	1.7	36.9	54.0(Note1)	-17.1	PK
	V	6227.5	24.0	10.2	34.2	54.0(Note1)	-19.8	PK
661	H	264.7	5.4	20.1	25.5	46.0	-20.5	QP
	V	558.3	4.5	26.7	31.2	46.0	-14.8	QP
	H	4706.0	28.5	7.5	36.0	54.0(Note1)	-18.0	PK
	V	6423.0	24.8	10.3	35.1	54.0(Note1)	-18.9	PK
810	H	274.2	4.8	19.9	24.7	46.0	-21.3	QP
	V	580.4	5.8	26.8	32.6	46.0	-13.4	QP
	H	2504.5	39.1	0.6	39.7	54.0(Note1)	-14.3	PK
	V	6040.5	26.6	10.3	36.9	54.0(Note1)	-17.1	PK

Note1: This limit applies for using average detector, if the test result on peak is lower than average limit, then average measurement needn't be performed.



Mode 03: EDGE 850 Idle

CH	Antenna	Frequency (MHz)	Reading Level (dBuV/m)	Factor (dB)	Measure Level (dBuV/m)	Limit (dBuV/m)	Margin (dB)	Detector
128	H	289.1	5.5	20.2	25.7	46.0	-20.3	QP
	V	612.2	5.4	27.1	32.5	46.0	-13.5	QP
	H	2615.0	37.0	1.0	38.0	54.0(Note1)	-16.0	PK
	V	6210.5	24.1	10.2	34.3	54.0(Note1)	-19.7	PK
190	H	308.1	6.1	20.9	27.0	46.0	-19.0	QP
	V	650.1	4.7	27.4	32.1	46.0	-13.9	QP
	H	2751.0	36.3	1.4	37.7	54.0(Note1)	-16.3	PK
	V	6465.5	24.9	10.4	35.3	54.0(Note1)	-18.7	PK
251	H	322.9	4.5	21.3	25.8	46.0	-20.2	QP
	V	690.8	7.3	27.6	34.9	46.0	-11.1	QP
	H	2861.5	37.0	1.5	38.5	54.0(Note1)	-15.5	PK
	V	6737.5	25.1	10.4	35.5	54.0(Note1)	-18.5	PK

Note1: This limit applies for using average detector, if the test result on peak is lower than average limit, then average measurement needn't be performed.



Mode 04: EDGE 1900 Idle

CH	Antenna	Frequency (MHz)	Reading Level (dBuV/m)	Factor (dB)	Measure Level (dBuV/m)	Limit (dBuV/m)	Margin (dB)	Detector
512	H	227.8	6.8	16.7	23.5	46.0	-22.5	QP
	V	517.5	4.1	25.6	29.7	46.0	-16.3	QP
	H	2980.5	36.4	1.6	38.0	54.0(Note1)	-16.0	PK
	V	7018.0	24.6	10.3	34.9	54.0(Note1)	-19.1	PK
661	H	245.8	5.3	19.0	24.3	46.0	-21.7	QP
	V	539.1	4.1	26.4	30.5	46.0	-15.5	QP
	H	3108.0	36.2	1.9	38.1	54.0(Note1)	-15.9	PK
	V	7298.5	26.8	10.8	37.6	54.0(Note1)	-16.4	PK
810	H	265.5	4.8	20.1	24.9	46.0	-21.1	QP
	V	556.7	5.1	26.7	31.8	46.0	-14.2	QP
	H	3218.5	38.1	2.4	40.5	54.0(Note1)	-13.5	PK
	V	7587.5	26.6	11.1	37.7	54.0(Note1)	-16.3	PK

Note1: This limit applies for using average detector, if the test result on peak is lower than average limit, then average measurement needn't be performed.