

AeroDR Battery Charger

- 1 Disconnect the power cable from the wall outlet, and confirm that the LED (green) is off.

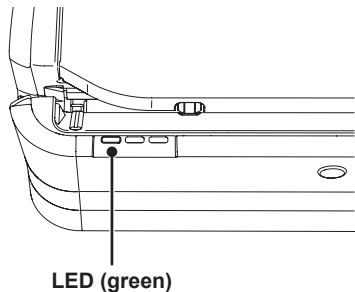

AeroDR Battery Charger2

- 1 Turn off the power switch, and confirm that the LED (green) is off.

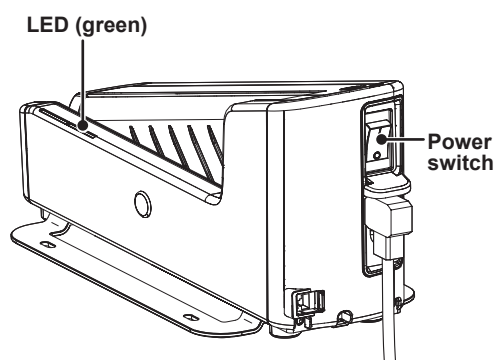

AeroDR Access Point

- 1 Turn off the power switch of the Power Source Device, and confirm that the LED (umber) is off.

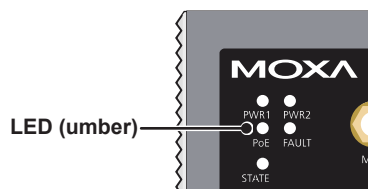

3.2 Operation of DR Detector

3.2.1 Exposure with basic connection or Aero Sync connection

Exposure under the basic connection example

IMPORTANT

- The DR Detector is precision equipment, and therefore impact or vibration during radiography or image transfer may affect the image quality. Be careful when handling the DR Detector during and just after radiography.

- 1 Perform examination registration with the image processing controller.
- 2 Check that this device is ready to expose images, and then prepare for the exposure.
- 3 Push the exposure switch of the X-ray device to perform the exposure.
 - When the exposure is completed, images are stored in the DR Detector and will then be converted to digital data and sent to the image processing controller sequentially.
- 4 Check that the exposed image is displayed on the image processing controller.

HINT

- If the DR Detector remains unused for a long time (time can be set) it transitions to the sleep mode.
- When the image processing controller is ready to expose, it recovers from the sleep mode.

3.2.2 Exposure under the S-SRM connection example

IMPORTANT

- The DR Detector is precision equipment, and therefore impact or vibration during radiography or image transfer may affect the image quality. Be careful when handling the DR Detector during and just after radiography.

- 1 Perform examination registration with the image processing controller.

- 2 Check that this device is ready to expose images, and then prepare for the exposure.

- 3 Push the S-SRM's hand switch to the first stage.
 - The exposure preparation signal is sent to the X-ray device.

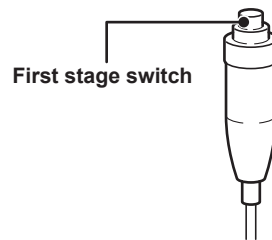

- 4 Push the S-SRM's hand switch up to the second level to perform exposure.

- Exposure is performed from the X-ray device to produce X-ray images.
- When the exposure is completed, images are stored in the DR Detector and will then be converted to digital data and sent to the image processing controller sequentially.

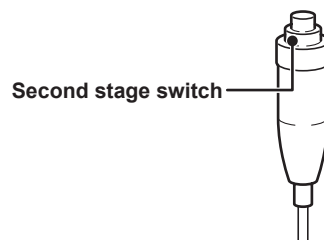

- 5 Check that the exposed image is displayed on the image processing controller.

HINT

- If the DR Detector remains unused for a long time (time can be set) it transitions to the sleep mode.
- When the image processing controller is ready to expose, it recovers from the sleep mode.

3.2.3 Exposure using Aero Storage

IMPORTANT

- The following DR Detector models can be used for Aero Storage exposure: AeroDR 3 Detector.

.....

Starting Aero Storage Mode

IMPORTANT

- When DR Detector is in the following conditions, Aero Storage mode cannot start:
 - It is connected to the AeroDR Battery Charger, AeroDR Battery Charger2, and a wired cable.
 - DR Detector battery level has dropped to less than 10 % level.
- Selection SW cannot be operated while Aero Storage mode is active.
- When 100 Aero Storage images are saved, the Aero Storage mode starts, but it turns to the sleep state, and exposure using Aero Storage cannot be performed.

.....

- 1 Press and hold the mode LED for three seconds.**
- 2 Ensure that the mode LED (blue) blinks slowly, the information LED indicating the number of saved images is on, and the status LED (blue) is on.**

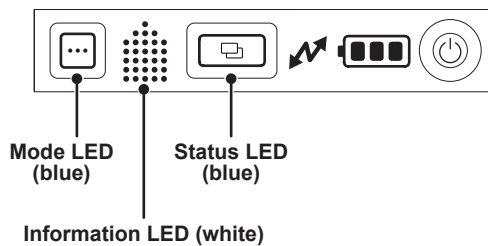

Exiting Aero Storage Mode

IMPORTANT

- You can also exit Aero Storage mode by pressing and holding the mode LED for three seconds.

.....

- 1 Insert DR Detector into the AeroDR Battery Charger and AeroDR Battery Charger2, or connect it to a wired cable.**
- 2 Aero Storage mode exits, and DR Detector is connected to the image processing controller.**

HINT

- Aero Storage mode automatically exits in the following conditions:
 - DR Detector battery level drops to less than 3 % level.
 - DR Detector detects an error.

.....

Exposure

IMPORTANT

- If you do not plan to expose immediately, exit Aero Storage mode.
- In Aero Storage, the maximum exposure time is set to 1.8 seconds and the resolution is set to the default (200µm). Please contact Konica Minolta technical representatives for more information about how to change the settings.
- The DR Detector is precision equipment, and therefore impact or vibration during radiography or image transfer may affect the image quality. Be careful when handling the DR Detector during and just after radiography.
- The number of saved images displayed in the information LED is counted when the orange status LED blinks fast after the X-ray exposure.
- The number of saved images displayed after an exposure is the patient's image number.
- Images exposed using Aero Storage do not have patient information. It is recommended, therefore, to keep record so that you can associate the patient exposed with the number of saved images displayed on DR Detector.
- When the number of saved images in Aero Storage reaches 100, it turns to the sleep state, and exposure using Aero Storage cannot be performed.
- While importing the images, do not disconnect DR Detector from AeroDR Battery Charger, AeroDR Battery Charger2, or the wired cable.
- When the image import process finishes, the number of saved image in DR Detector becomes zero.

.....

- 1 Start Aero Storage mode.**
- 2 Check that this device is ready to expose images, and then prepare for the exposure.**

3 Push the exposure switch of the X-ray device to perform the exposure.

- After exposure, images are saved to DR Detector, and the information LED indicates the number of saved images.

4 Exit Aero Storage mode.

- Insert DR Detector into the AeroDR Battery Charger or AeroDR Battery Charger2, or connect it to a wired cable.
- Aero Storage mode exits, and DR Detector is connected to the image processing controller.

5 Import the images using the image processing controller.

Aero Indicator

Exposure with Aero Indicator is performed with the following procedure.

IMPORTANT

- Do not give diagnoses using the images displayed in Aero Indicator.
- Images displayed in Aero Indicator are for positioning check, and the display differs from the image displayed in the image processing controller.
- When performing exposure using Aero Indicator, align the orientation of the triangular mark of the DR Detector with the orientation of the grid bar as shown in the following figure.

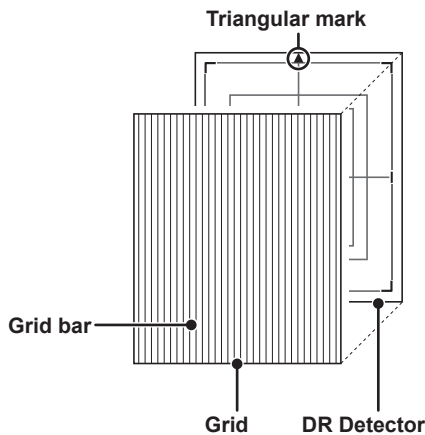

- If the orientation of the grid bar tilts 90° from the orientation of the triangular mark of the DR Detector at exposure, the image display unevenness may occur on Aero Indicator.
 - The image unevenness on Aero Indicator due to the orientation of the grid bar will be removed upon image processing when the image is imported to the image processing controller.
-

1 Start the Aero Storage mode of the DR Detector.

2 Start Aero Indicator of the DR Detector to be accessed from a mobile device, and log in to Aero Indicator.

3 Check the connected DR Detector, and tap [OK].

4 Ensure that the status of Aero Indicator is ready for exposure, and perform an exposure operation.

5 Check the preview image displayed in Aero Indicator. The image is displayed during the reception process, and the preview image is displayed.

6 Exit the Aero Storage mode of the DR Detector as well as Aero Indicator on the mobile terminal.

7 Import the image using the image processing controller.

HINT

- If reconnect to the DR Detector that imported images to the image processing controller without exiting Aero Indicator, the following screen is displayed. Tap [Refresh] to refresh the imported image as well as exposure failure and division display displayed on the mobile terminal.

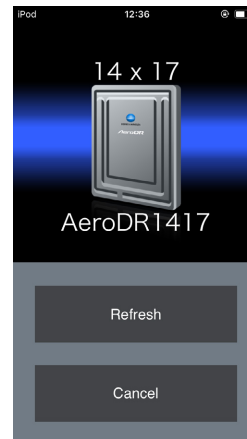

Aero Indicator screen display

IMPORTANT

- Aero Indicator can only be used in the Aero Storage mode of the DR Detector.
- If there are multiple DR Detectors that use Aero Indicator, exit the Aero Storage mode on (or turn off the power of) all DR Detector except the one connecting to the mobile device.
- Exiting the Aero Storage mode of the DR Detector disconnects the connection.
- Because the connection to the DR Detector can be disconnected, do not turn the mobile terminal to the sleep state while Aero Indicator is in use.
- When the number of saved images in Aero Storage reaches 100, it turns to the sleep state, and exposure using Aero Storage cannot be performed.

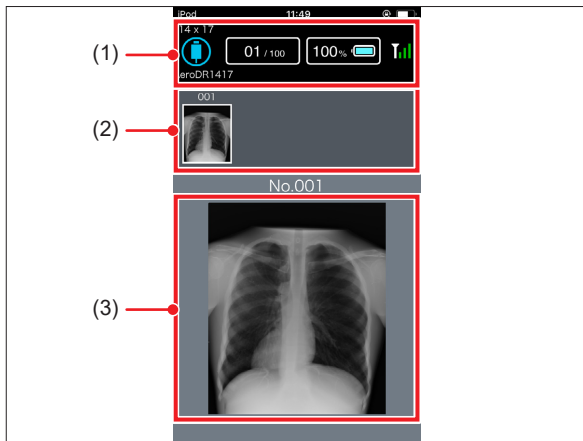

Number	Name	Function	
(1)	Status		Ready for exposure
			DR Detector is in preparation.
			DR Detector is not connected.
		Number of saved images	Number of images saved to the DR Detector.
	Battery level	Battery level of DR Detector.	
	Radio wave intensity	The intensity of the radio wave used for DR Detector connection.	
(2)	Thumbnail	List of images saved to the DR Detector.	
(3)	Preview image	The selected thumbnail is displayed as an enlarged image.	

HINT

- A mobile terminal equipped with an audio output function can be configured to beep when the status turns to READY and when the DR Detector detects the X-ray.

Exposure failure and division display functions of Aero Indicator

IMPORTANT

- The information of exposure failure or division display function cannot be imported to the image processing controller. Record it on a piece of paper before importing the images.

1 Tap on the preview display.

- The exposure failure function and division display function buttons are displayed.

2 Tap the exposure failure function button or the division display function button .

- Tap the exposure failure function button to insert an exposure failure indicator to the preview display and the corresponding thumbnail.

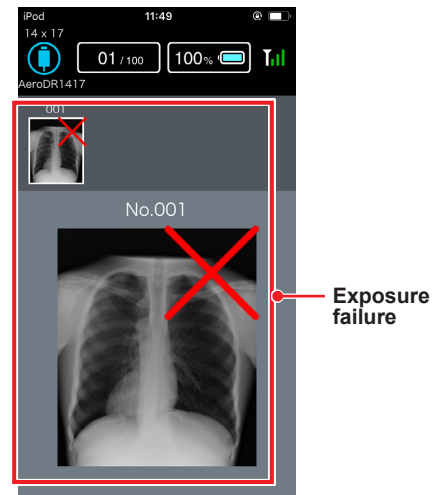

- Tap the division display function button to insert a divider at right of the thumbnail.

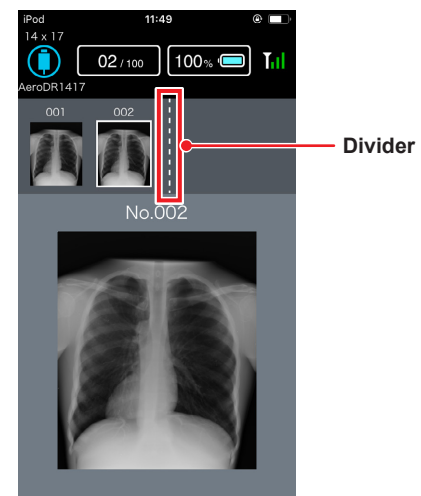

- When either button is Tapped, the exposure failure function and division display function buttons disappear.

HINT

- Repeat the same procedure to delete the exposure failure indicator or the divider.

3.2.4 Serial exposure

IMPORTANT

- DR Detectors capable of serial exposure are: AeroDR 3 1417HD, AeroDR 3 1717HD, AeroDR 3 1417HD2, and AeroDR 3 1717HD2.
- I/F cables capable of serial exposure are: I/F Cable4 1.5mD, I/F Cable4 8mD, and I/F Cable4 8mU.
- Intelligent Grid cannot be used.
- Please use an X-ray generator and a wall stand/table dedicated for serial exposure.
- Because the serial exposure images are exposed with low dosage, it is not guaranteed that these images have the same image quality as the images exposed in other method than serial exposure.
- The DR Detector is precision equipment, and therefore impact or vibration during radiography or image transfer may affect the image quality. Be careful when handling the DR Detector during and immediately after the exposure.

- 1 Perform examination registration with the image processing controller.**
- 2 Check that this device is ready to expose images, and then prepare for the exposure.**
- 3 Push the exposure switch of the X-ray device to perform the exposure.**
 - By pressing and holding the exposure switch, serial exposure is performed. Also, by releasing the exposure switch, X-ray exposure finishes to exit serial exposure.
 - When the exposure is completed, images are stored in the DR Detector and will then be converted to digital data and sent to the image processing controller sequentially.
- 4 Check that the exposed image is displayed on the image processing controller.**

3.2.5 DR Detector orientation

Change the orientation of the DR Detector according to the exposure body part.

Expose with the triangular mark upward when exposing in portrait, and with the triangular mark to the side when exposing in landscape.

When exposing in portrait

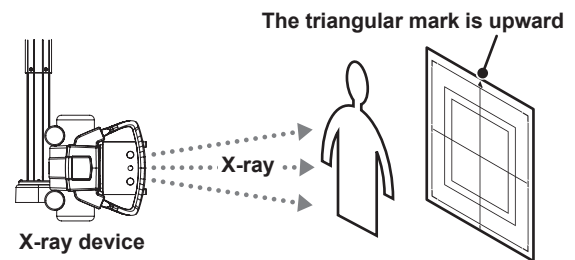

When exposing in landscape

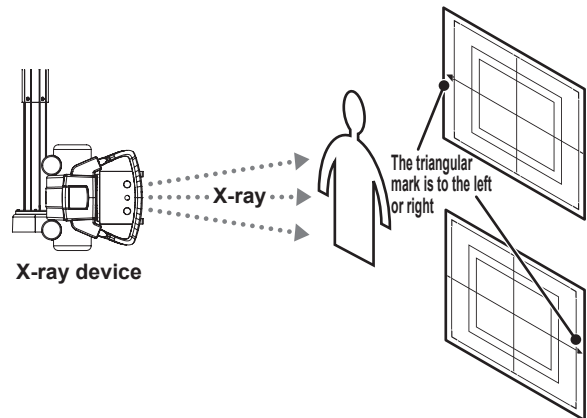

HINT

- The blue label or blue lines also helps you identify the top-bottom orientation of the DR Detector.
- To carry out exposures in portrait orientation, turn the DR Detector so that its blue label or blue lines comes to the bottom position.

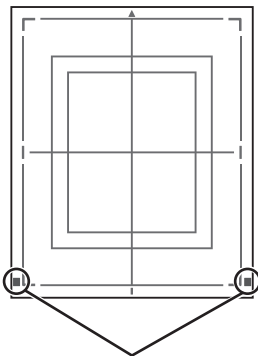

Blue Label

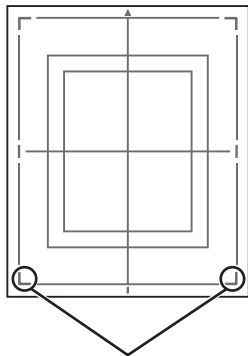

Blue lines

- The side with the triangular mark is the exposure surface.
 - When exposing the chest, abdomen, and pelvis in landscape, because the functions to determine the orientation of the body and to rotate the image automatically is configured, set the orientation of DR Detector as follows:
 - For wired connection with an I/F cable or wireless connection, ensure that the orientation of the triangular mark to the left when performing an exposure.
 - For wired connection with an AeroDR UF cable, perform an exposure in a direction to which the AeroDR UF cable can be connected.
 - Radiography is not allowed on a subject in a horizontal position when an AeroDR 1717HQ, AeroDR 3 1717HD, and AeroDR 3 1717HD2 are used.
-

3.2.6 Precautions for exposure

Exposure area

IMPORTANT

- If the irradiation field is larger than DR Detector when you take an image, an artifact may occur due to the X-ray back-scatter effect. Adjust the irradiation field to fit within the imaging range.
-

- The size lines of DR Detector indicate the exposure size.
- During exposure, place the exposure body part within the white lines on the four corners.

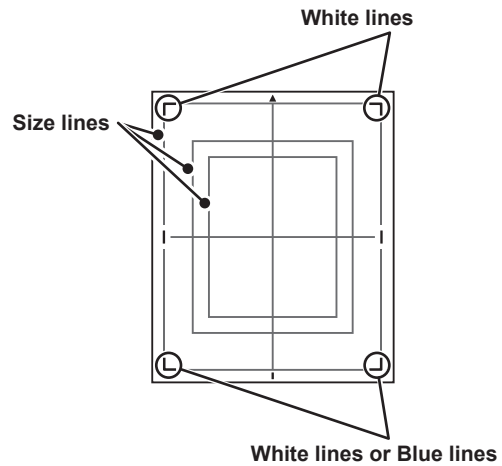

HINT

- As for AeroDR 3 1417HD, AeroDR 3 1717HD and AeroDR 3 1012HQ, the line in the bottom is blue.
-

Wired connection

- When performing exposure with a wired connection, fasten the wired cable horizontally to the wired connection connector of the DR Detector. If connected at an angle, transverse (noise) sometimes gets into acquired images after exposure.

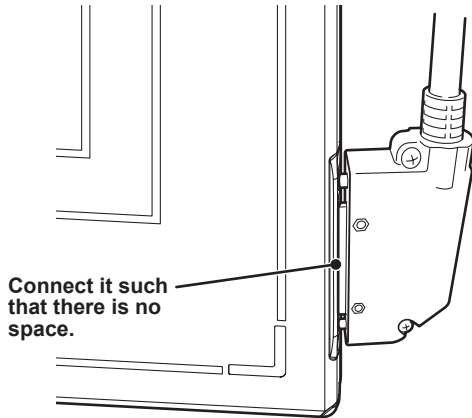

Wireless communications environment

- With a wireless environment, it is possible that errors such as no wireless connection, wireless communication terminates, and lengthened exposure cycle time might occur.

HINT

- Problems with a wireless communications environment can occur in the following conditions:
 - Installed location of the access point is not good.
 - When inserted in the wall stand, table, or stretcher, the opening in the wall stand or table is too small and there is no passage for the radio waves.
 - The radio waves are not emitted due to metal parts close to the antenna, which changes the antenna characteristics.
 - For exposures where the body touches the DR Detector directly, the radio waves may not be emitted if the body completely covers both antennas or either of the antennas.
 - Other devices use the same radio band, and cause interference.
 - When the 2.4 GHz band is used, using high frequency therapy equipment will cause interference.
 - When the DFS band is used, the access point changes channels if weather radar or air control radar is detected. This may cause communication to be temporarily disconnected.

Exposure switch

- If the exposure switch remains held down, it may result in an afterimage becoming visible. Once exposure is finished, release the exposure switch immediately.

Grid

IMPORTANT

- For an AeroDR 1417S without the "1417S" identification, use a grid with a grid density of 34 lp/cm and an angle error of 0.5° or less.



Identification **AeroDR P-12 (1417S)**

- A capped grid is recommended when laying the grid over the DR Detector on the table top or for exposure with the X-ray device.
- Do not use a grid of which the antenna is covered with metal, as the quality of wireless communication may be significantly reduced.

- Use the following grid when exposing.

DR Detector	Grid density	Grid ratio	Convergence distance	Angle error
AeroDR Detector, AeroDR 2 Detector	34 lp/cm 40 lp/cm	Variety	Variety	5.0° or less
AeroDR 3 Detector	34 lp/cm 40 lp/cm 60 lp/cm	Variety	Variety	5.0° or less

High-dose exposure

- When high-dose exposures are performed continuously, afterimages of the last exposure will occasionally be visible. The affect of afterimages in this device can be resolved by leaving longer intervals between exposures, so make the intervals between exposures longer than usual when performing high-dose exposure.
- During high-dose exposure, continual use of a lead or other marker at the same position can cause burning in of the afterimage. Therefore, avoid using it in the same position. Also, if image burn-in is visible, run calibration.

**Exposure time for basic connection/
S-SRM connection**

IMPORTANT

- You cannot select 4.0, 6.7 and 10.3 as the maximum exposure time for the following DR Detectors.

DR Detector	Serial Number	
	First four digits	Number
AeroDR 1417HQ	A5DP	50197 or less
AeroDR 1417S	A50D	51000 or less
AeroDR 1717HQ	A6C3	51000 or less
AeroDR 1012HQ	A5TE	51000 or less

- If you increase the maximum exposure time in AeroDR Detector and AeroDR 2 Detector, the DR Detector may take longer to exit sleep mode.
- When the maximum exposure time of the AeroDR 3 Detector is set at 10.3, the interval between exposures should be 2 minutes or longer. The following exposures also require 2 minutes intervals.

- The maximum exposure time is as follows.

DR Detector	maximum exposure time
AeroDR Detector, AeroDR 2 Detector	0.7, 1.7, 3.2, 4.0, 6.7, 10.3 seconds
AeroDR 3 Detector	0.7, 1.7, 4.0, 10.3 seconds

- The exposure time for actual exposures should not exceed the maximum exposure time you have set. Otherwise, exposure may fail or correct images may not be able to be obtained.

HINT

- Use the image processing controller to set the maximum exposure time. In some cases, the maximum exposure time is fixed according to the X-ray device. For details, contact Konica Minolta technical representatives.
- When using ImagePilot as the image processing controller, it is not possible to change the maximum exposure time.

**Exposure time for Aero Sync mode of
the AeroDR 1417HQ, AeroDR 1717HQ,
AeroDR 1012HQ, AeroDR 2 Detector**

IMPORTANT

- If the conditions are not met, X-rays may not be detected or streaks may occur in the image.
- Because the minimum exposure time for AeroDR 1417HQ, AeroDR 1717HQ, and AeroDR 1012HQ varies depending on the X-ray device to be used, follow the survey results at the time of installation.
- The minimum exposure time applies to the time when X-ray is exposed onto the center of the DR Detector. If X-ray cannot be exposed onto the center, contact Konica Minolta technical representatives.

- Set the maximum exposure time to 0.8 seconds or less.
- Set the minimum exposure time as follows:

DR Detector	Minimum exposure time
AeroDR 1417HQ, AeroDR 1717HQ, AeroDR 1012HQ	2.1 milliseconds
AeroDR 2 Detector	1 millisecond

HINT

- When using ImagePilot as the image processing controller, it is not possible to change the maximum exposure time.

Exposure time for Aero Sync mode of the AeroDR 3 Detector

IMPORTANT

- If the conditions are not met, X-rays may not be detected or streaks may occur in the image.
- The minimum exposure time applies to the time when X-ray is exposed onto the center of the DR Detector. If X-ray cannot be exposed onto the center, contact Konica Minolta technical representatives.
- The cycle time will be extended by setting the longer maximum exposure time. It is recommended that the optimal maximum exposure time be set.

- Set the maximum exposure time according to the sensitivity button setting of the image processing controller. The available values for the maximum exposure time are as follows.

Maximum exposure time	Extra Large	Large	Med
0.8 seconds	Can be set	Can be set	Can be set
1.8 seconds	Can be set	Cannot be set	Cannot be set
4.0 seconds	Can be set	Cannot be set	Cannot be set

- When using Aero Sync mode, set the minimum exposure time as follows:

DR Detector	Minimum exposure time
AeroDR 3 Detector	1 millisecond

HINT

- When using ImagePilot as the image processing controller, it is not possible to change the maximum exposure time.

Identify the DR Detector that users can use in Aero Sync mode

IMPORTANT

- The AeroDR 1012HQ, AeroDR 2 Detector, and AeroDR 3 Detector can use the Aero Sync mode.
- Users can not use Aero Sync Mode in the DR Detector if it is AeroDR 1417S.
- Users cannot use Aero Sync mode in the DR Detector if the first four digits of its SerialNumber are shown in the following table in the AeroDR 1417HQ or AeroDR 1717HQ.

DR Detector	SerialNumber that cannot be used
AeroDR 1417HQ	A45Y
AeroDR 1717HQ	A54T

- Confirm that if the following identification is in the DR Detector that users can use in Aero Sync mode.

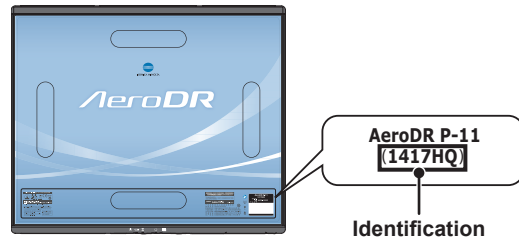

DR Detector	Identification
AeroDR 1417HQ	1417HQ
AeroDR 1717HQ	1717HQ

Exposure with the Aero Sync mode

- To confirm X-ray detection, make sure the following conditions are met.
 - For the AeroDR 1417HQ, AeroDR 1717HQ and AeroDR 1012HQ:
Perform exposure by following the survey results of the installation. For details, contact Konica Minolta technical representatives.
 - For the AeroDR 2 Detector:
Perform X-ray exposure at a range of 10 cm square or more at the center of the DR Detector.
 - For the AeroDR 3 Detector:
Perform X-ray exposure at a range of 10 cm square or more at the center of the DR Detector. You can select the maximum exposure time from 0.8 seconds or shorter, 1.8 seconds or shorter and 4.0 seconds or shorter in the Extra Large mode.

- The conditions of the S value corresponding to the maximum exposure time and the DR Detectors corresponding to them are as follows.

maximum exposure time	S value	DR Detector	
		AeroDR 2 Detector	AeroDR 3 Detector
0.8 seconds or less	2000 or less	Can be set	Can be set
1.8 seconds or less	800 or less	Cannot be set	Can be set
4.0 seconds or less	400 or less	Cannot be set	Can be set

- To use a grid in Aero Sync mode, align the orientation of the triangular mark of the DR Detector with the grid bar as shown in the following figure.

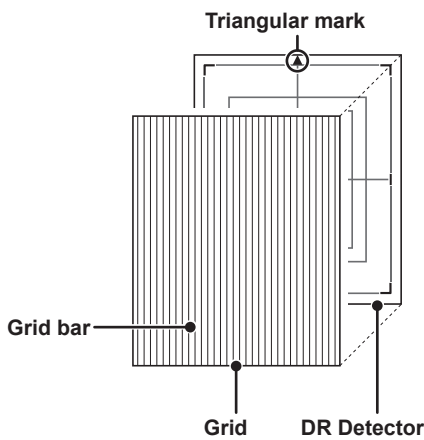

- If the DR Detector is used in an orientation where the grid bars are turned 90 degrees with respect to the triangle mark on the DR Detector, observe the following conditions:

DR Detector	Grid density
AeroDR 1417HQ, AeroDR 1717HQ, AeroDR 1012HQ, AeroDR 2 Detector	34 lp/cm: Angular error must be 1.7° or less 40 lp/cm: Angular error must be 1.0° or less
AeroDR 3 Detector	34 lp/cm: Angular error must be 1.7° or less 40 lp/cm: Angular error must be 1.0° or less 60 lp/cm: Angular error must be 1.0° or less

- Do not use additional filters for exposure dose reduction.
- When another system performs X-ray exposure in the exposure room where the DR Detector is placed, the DR Detector may incorrectly sense the X-ray exposure and transfer images. Do not use the image processing controller to make the DR Detector ready for exposure.

Aero Sync mode exposure when radioactive substances remain

- If there are any radioactive substances remaining in the patient's body after nuclear medicine testing or some other reason, the AeroDR 2 Detector and AeroDR 3 Detector may recognize that X-rays were emitted and start image transfer. When the image is transferred, change the X-ray sensitive setting of the image processing controller to "Large" before performing exposure.
- If you change the X-ray sensitivity to "Large" in AeroDR 2 Detector, make sure that all of the following conditions are met before performing exposure. If you perform exposure under other conditions, you may not be able to get an image.
 - On the DR Detector, set up an area (2 cm x 2 cm or larger) on which the X-rays are emitted directly.
 - Emit the X-rays onto the entire DR Detector.
 - Emit the X-rays by using a tube current of 140 mA or higher or a tube voltage of 90 kV or higher.
- If you change the X-ray sensitivity to "Large" or "Med" in AeroDR 3 Detector, make sure that all of the following conditions are met before performing exposure. If you perform exposure under other conditions, you may not be able to get an image.
 - Emit the X-rays onto the entire DR Detector.
 - Emit the X-rays by using a tube current of 140 mA or higher or a tube voltage of 90 kV or higher.

S-SRM connection

IMPORTANT

- If you restart the image processing controller, also restart the AeroDR Interface Unit or AeroDR Interface Unit2.
.....
- When S-SRM connection is adopted, make sure to perform exposure using the hand switch connected to the AeroDR Interface Unit2, AeroDR Generator Interface Unit and AeroDR Generator Interface Unit2.
- If exposure is performed using the hand switch on the operation panel of the X-ray device, exposure synchronized to the this device is not possible.

AED (Automated External Defibrillator)

- When an AED (Automated External Defibrillator) is used, move the DR Detector away from the patient. High voltage and high current may result in a breakdown of the DR Detector.

The operating temperature environment of DR Detectors

- If an DR Detector is left close to or in contact with a heat generator such as electric carpet, its safety device may be activated and the DR Detector may fail to work properly.

Electromagnetic waves

- If an exposure is performed at a location near a device that emits electromagnetic wave, noise may appear on the image. When performing exposure, turn off that device or move that device away from DR Detector.

Waterproof performance of the AeroDR 2 Detector, AeroDR 3 Detector

IMPORTANT

- The AeroDR Detector is not waterproof.
- If there is a risk of the ingress of patient body fluids, chemicals, water, etc., make sure to put a cover with a vinyl sheet, etc. The ingress of patient body fluids, chemicals, water, etc. into the DR Detector cannot be prevented. In particular, if patient body fluids enter into the protective cover, for hygienic purposes, make sure to replace or clean the parts.
- Subjecting it to strong impacts or excessive loads by dropping or hitting it against other objects may diminish its waterproof capabilities.
- It is designed to have IPX6 waterproof capabilities, but it is not guaranteed to be completely waterproof.

HINT

- An IPX6 (level of jet stream protection) rating indicates that the AeroDR 2 Detector and AeroDR 3 Detector are designed to operate even after being exposed to normal temperature water projected from all angles through a 12.5 mm nozzle for 3 minutes or more (at a flow rate of about 100 L/min) from a distance of 3 meters.
-

Exposure with the remote table

- The DR Detector is precision equipment, therefore impact or vibration during exposure and image transfer may affect the image quality. Impact or vibration when performing exposure using the remote table in particular may significantly increase the effect, therefore observe the following.
 - Prevent the DR Detector from moving until the preview image is displayed immediately after exposure.
 - Do not operate the remote table to eject the DR Detector or load the DR Detector to the standby position.
 - Do not move the remote table position horizontally or vertically.
- Check that the DR Detector does not automatically move immediately after exposure. If it does, please contact a technical representative of the X-ray device manufacturer and request to change the settings so that the DR Detector does not move immediately after exposure.
- If the settings of the X-ray device cannot be changed, check the image quality in advance. Please contact Konica Minolta technical representative for more information about how to check the image quality.
- When using the remote table for exposure in Aero Sync mode of AeroDR 3 Detector, ensure to expose the X-ray to the entire surface of DR Detector.

3.3 Charging of DR Detector

Charge the DR Detector when the LED (blue) on the DR Detector lights or flashes, or when the battery level gets low in the status display of the DR Detector on the image processing controller.

IMPORTANT

- During charging, if the DR Detector should become hot, stop charging immediately.
- If charging errors occur repeatedly, contact Konica Minolta technical representatives.

HINT

- The DR Detector can be charged when the power is either on or off.
- The DR Detector can be used while stopping charging in progress.
- To charge the DR Detector with the AeroDR Battery Charger or AeroDR Battery Charger2 when you do not use it for a long time such as during the night, charge the DR Detector with its power turned off.
- Even if you use the battery equipped with this device for repeated quick charging and use, deterioration of battery life is small compared to a lithium-ion battery.

3.3.1 Charging with AeroDR Battery Charger

IMPORTANT

- The AeroDR 1012HQ, AeroDR 2 1417S, and AeroDR 3 Detector cannot be charged in the AeroDR Battery Charger.
- Handle the DR Detector with extreme care when inserting it into the AeroDR Battery Charger.
- The LED of the DR Detector is not visible when the DR Detector is inserted into the AeroDR Battery Charger.
- The wired connection connector of the DR Detector may become warm right after charging on the AeroDR Battery Charger. This often occurs during charging and is not a malfunction.
- If there is any problem during charging, the LED (orange) on the AeroDR Battery Charger will light. Also, charging will stop when an error occurs.

- 1 Confirm that the LED (green) of the AeroDR Battery Charger is slowly flashing.**
- 2 Slowly insert the DR Detector with its exposure side pointed toward the operator until the buzzer sounds. When inserted, charging of the DR Detector begins.**

Insert from the side

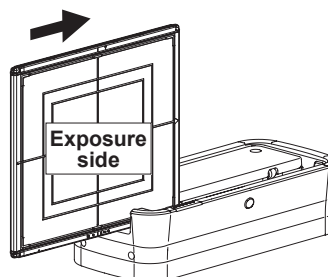

Slide slowly

Insert from the front (top)

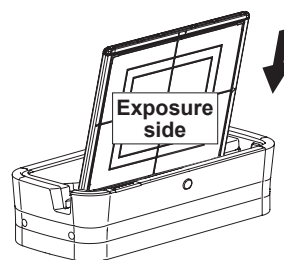

Load slowly

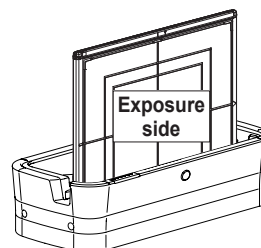

Inserted

- 3 Once the DR Detector is inserted correctly and charging starts, the LED (blue) on the AeroDR Battery Charger will light.**
- 4 Once charging of the DR Detector is completed, the LED (blue) on the AeroDR Battery Charger will turn off.**
- 5 Remove the DR Detector from the AeroDR Battery Charger.**
 - Pull the DR Detector to remove it.

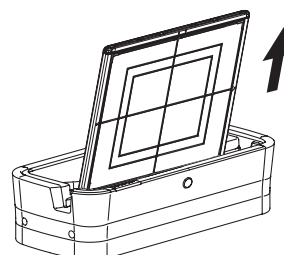

3.3.2 Charging with AeroDR Battery Charger2

IMPORTANT

- Handle the DR Detector with extreme care when inserting it into the AeroDR Battery Charger2.
- The wired connection connector of the DR Detector may become warm right after charging on the AeroDR Battery Charger2. This often occurs during charging and is not a malfunction.
- If there is any problem during charging, the LED (orange) on the AeroDR Battery Charger2 will light. Also, charging will stop when an error occurs.
- As the DR Detector is locked by a magnet, do not pull it out horizontally or vertically.

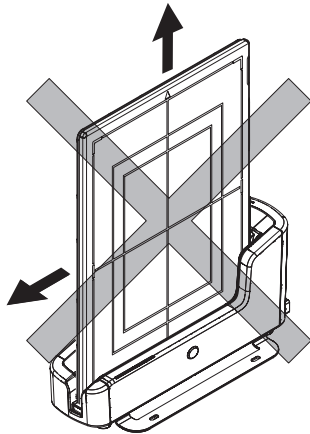

- 1 Confirm that the LED (green) of the AeroDR Battery Charger2 is slowly flashing.
- 2 Slowly insert the DR Detector with its exposure side pointed toward the operator until the buzzer sounds. When inserted, charging of the DR Detector begins.

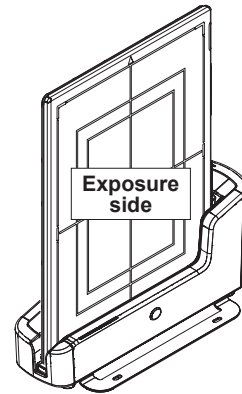
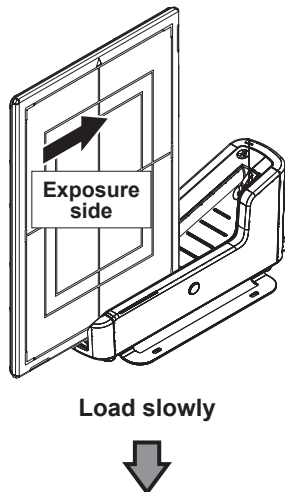

Inserted

- 3 Once the DR Detector is inserted correctly and charging starts, the LED (blue) on the AeroDR Battery Charger2 will flash or light.
 - The LED (blue) on the AeroDR Battery Charger2 changes according to the level of battery power of the DR Detector.
- 4 Once charging of the DR Detector is completed, all the LEDs (blue) on the AeroDR Battery Charger2 will turn on.
- 5 Remove the DR Detector from the AeroDR Battery Charger2.
 - Tilt the DR Detector in the direction shown in the following figure and remove it.

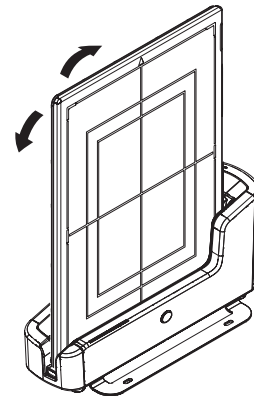

HINT

- AeroDR 3 1717HD is inserted

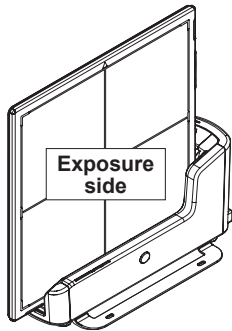

- AeroDR 3 1012HQ is inserted

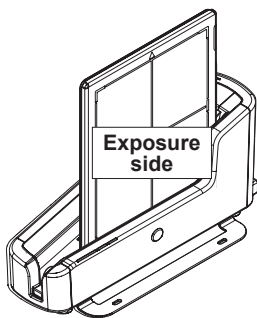

3.3.3 Charging with the wired cable

- 1 Confirm that the devices with I/F cables connected are turned on.
- 2 Securely connect the wired cable to the wired connection connector on the DR Detector. Once it is connected, the DR Detector will start charging.

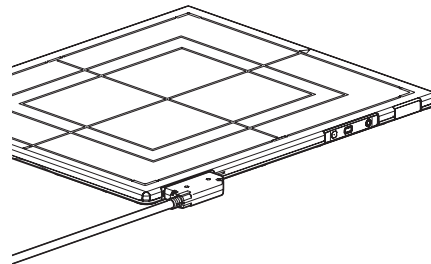

or

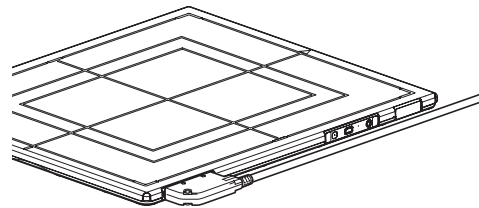

- 3 Once the battery level of the DR Detector becomes 10 % or higher, the LED on the DR Detector changes as follows.

DR Detector	Battery level	LED	Lighting pattern
AeroDR Detector, AeroDR 2 Detector	10 % or more	LED (blue)	Off
AeroDR 3 Detector		Battery LED (blue)	On

HINT

- Confirm completion of full charge and the level of battery power with the image processing controller.
- If there is any problem during charging, an error is displayed on the DR Detector. Also, charging will stop when an error occurs.

3.3.4 Charging time guide

IMPORTANT

- When the DR Detector is on, the charging time will be slightly longer as it depends on the operation status.

AeroDR 1417HQ, AeroDR 1417S, AeroDR 1717HQ

Charging status	Charging time of the DR Detector when the power is off
Via the AeroDR Battery Charger	30 minutes or less
Via AeroDR Battery Charger2	60 minutes or less
Via wired cable	60 minutes or less

AeroDR 1012HQ

Charging status	Charging time of the DR Detector when the power is off
Via the AeroDR Battery Charger	Cannot be recharged.
Via AeroDR Battery Charger2	30 minutes or less
Via wired cable	30 minutes or less

AeroDR 2 1417HQ

Charging status	Charging time of the DR Detector when the power is off
Via the AeroDR Battery Charger	30 minutes or less
Via AeroDR Battery Charger2	30 minutes or less
Via wired cable	30 minutes or less

AeroDR 2 1417S

Charging status	Charging time of the DR Detector when the power is off
Via the AeroDR Battery Charger	Cannot be recharged.
Via AeroDR Battery Charger2	13 minutes or less
Via wired cable	13 minutes or less

AeroDR 3 1417HD, AeroDR 3 1717HD, AeroDR 3 1417HD2, AeroDR 3 1717HD2

Charging status	Charging time of the DR Detector when the power is off
Via the AeroDR Battery Charger	Cannot be recharged.
Via AeroDR Battery Charger2	30 minutes or less
Via wired cable	30 minutes or less

AeroDR 3 1012HQ

Charging status	Charging time of the DR Detector when the power is off
Via the AeroDR Battery Charger	Cannot be recharged.
Via AeroDR Battery Charger2	20 minutes or less
Via wired cable	20 minutes or less

3.3.5 DR Detector battery level display

The DR Detector LED changes according to the battery level.

AeroDR Detector, AeroDR 2 Detector

IMPORTANT





- When the battery runs down completely, all the LEDs go out. Confirm that the LED (green) either lights or flashes when you perform exposure.
-

Battery level	LED display
Less than 3 % (exposure not possible)	Lit (blue)
Less than 5 %	Fast flashing (blue)
Less than 10 %	Slow flashing (blue)
10 % or more	Off

AeroDR 3 Detector

IMPORTANT

- When the battery runs down completely, all the LEDs go out. Confirm that the LED (blue) either lights or flashes when you perform exposure.
-

Battery level	LED display
2 % or less	 Slow flashing (orange)
3 % to 9 %	 Slow flashing (blue)
10 % to 66 %	 Lit and Slow flashing (blue)
67 % to 79 %	 Lit and Slow flashing (blue)
80 % or more	 Lit (blue)

HINT

- Confirm the level of battery power of the AeroDR 3 Detector with the Battery LED. Press the Selection SW which makes the Battery LED light for 3 seconds even when it is turned off.
-

3.4 Registration and selection of the DR Detector

By registering to the image processing controller, the DR Detector can be moved between exposure rooms.

IMPORTANT

- When using ImagePilot as the image processing controller, it is not possible to move the DR Detector between different exposure rooms.
- Once it is registered in a new exposure room, it will not be usable in the previous exposure room. When returning to a previous exposure room, perform the registration operation again.

3.4.1 Registration with AeroDR Battery Charger

IMPORTANT

- AeroDR 1012HQ and AeroDR 3 1012HQ cannot be registered with the AeroDR Battery Charger.
- When an AeroDR Battery Charger exclusively for charge is used, confirm that the battery charger in the destination has a "Charge and registration" label.

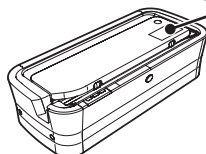

- 1 Make sure that all the devices in the destination exposure room are usable.
- 2 Insert the DR Detector into AeroDR Battery Charger in the destination exposure room.
 - Registration process will start.

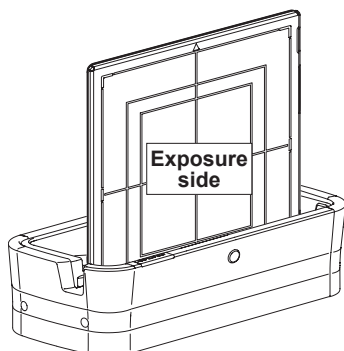

- 3 Once the registration is completed, a buzzer will sound on the AeroDR Battery Charger, and the LED (green) will change from slow flashing to lit.

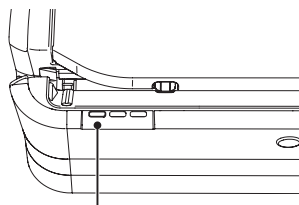

LED (green)

- 4 Confirm that the DR Detector icon is displayed on the image processing controller.

HINT

- Charging will also start when the DR Detector (AeroDR 1417HQ, AeroDR 1417S, AeroDR 1717HQ, AeroDR 2 1417HQ) is inserted into the AeroDR Battery Charger, and the AeroDR Battery Charger LED (blue) will light.
- AeroDR 2 1417S, AeroDR 3 1417HD, AeroDR 3 1717HD, AeroDR 3 1417HD2, and AeroDR 3 1717HD2 can be registered with the AeroDR Battery Charger.

3.4.2 Registration with AeroDR Battery Charger2

- 1** Make sure that all the devices in the destination exposure room are usable.
- 2** Insert the DR Detector into AeroDR Battery Charger2 in the destination exposure room.
 - Registration process will start.

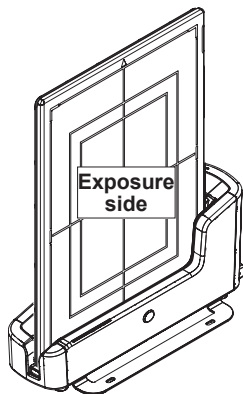

- 3** Once the registration is completed, a buzzer will sound on the AeroDR Battery Charger2, and the LED (green) will change from slow flashing to lit.

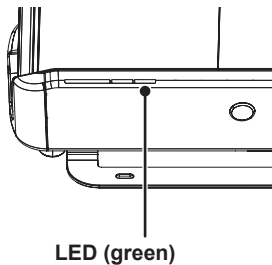

- 4** Confirm that the DR Detector icon is displayed on the image processing controller.

HINT

- Charging will also start when the DR Detector is inserted into the AeroDR Battery Charger2, and the AeroDR Battery Charger2 LED (blue) will light or flash.

.....

3.4.3 Registration with the wired cable

- 1** Make sure that all the devices in the destination exposure room are usable.
- 2** Securely connect the wired cable to the wired connection connector on the DR Detector.
 - Registration process will start.

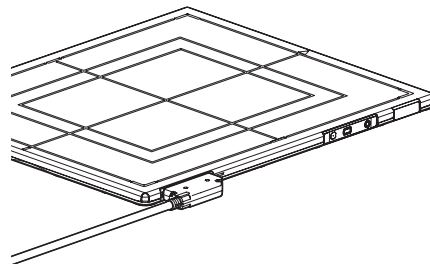

or

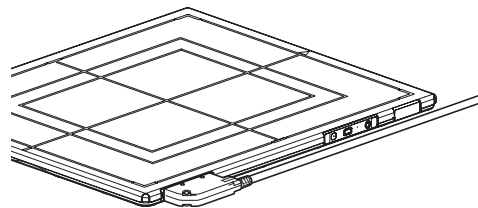

- 3** Confirm that the DR Detector icon is displayed on the image processing controller.

3.4.4 Selection of the DR Detector

An DR Detector is selected as follows depending on the number registered on each image processing controller.

Number of registered DR Detectors	Selection method
1	<ul style="list-style-type: none"> • DR Detector is selected automatically when that DR Detector is ready to be selected. • The DR Detector is not selected if it is not inserted in a wall stand or table that matches the order information.
Multiple	<ul style="list-style-type: none"> • The DR Detector that was selected immediately beforehand will be selected automatically if it is ready to be selected. • Any DR Detector is not selected if it is not inserted in a wall stand or table that matches the order information.

3.4.5 Manual selection of the DR Detector

AeroDR Detector, AeroDR 2 Detector

- 1 Press the selection switch of the DR Detector that will be used for 2 seconds or longer.

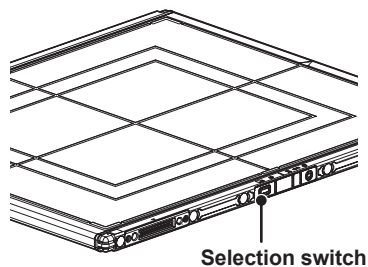

- 2 The LED (green) of the DR Detector flashes fast for 2 seconds.

AeroDR 3 Detector

- 1 Press the Selection SW of the DR Detector that will be used for 2 seconds or longer.

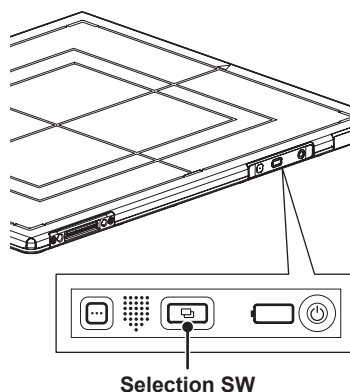

- 2 The Status LED (blue) of the DR Detector flashes fast for 2 seconds.

HINT

- The DR Detector can also be selected manually from the image processing controller. For details, refer to the "Operation Manual" of the image processing controller.

.....

3

3.5 Calibration

Perform calibration so that the DR Detector can provide optimal images.

Perform calibration every year or when a message prompting you to do so is displayed in the image processing controller.

IMPORTANT

- It is necessary to perform the gain calibration periodically to compensate for changes over time or changes in the exposure environment.
- Fully charge the DR Detector before the calibration.
- Perform by waiting at least 10 minutes after the previous exposure.

HINT

- For the calibration, refer to the "Operation Manual" or the "User Tool Operation Manual" of the image processing controller.

3.6 Position to affix DR Detector identification label and AeroDR Grip sheet

3.6.1 Position to affix DR Detector identification label

When using more than 1 DR Detector and affixing identification labels (stickers) to the outside of the DR Detectors, it is recommended to affix the labels to the 2 places ((1), (2)) shown as follows.

IMPORTANT

- Affix the labels only in the recommended places. Failure to do so may cause the labels to come off or image unevenness to occur.

Position to affix DR Detector identification label

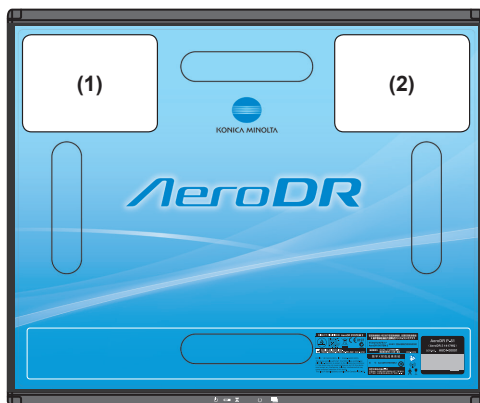

HINT

- Use of commercially available vinyl (Tepa, etc.) labels are recommended for the identification labels (stickers). When possible, use labels that do not easily peel off.
- It is recommended to write the name and identification number registered in the image processing controller on the label.

3.6.2 AeroDR Grip sheet

When using the AeroDR Grip sheet, hold the DR Detector as shown in the following figure.

IMPORTANT

- The AeroDR Grip sheet may peel off or deteriorate depending on usage. When AeroDR Grip sheet peel off or deteriorate, replace them.
- For replacement AeroDR Grip sheet, contact Konica Minolta technical representatives.
- For how to affix the AeroDR Grip sheet, refer to "6.1.5 AeroDR Grip sheet affixing and replacement".
- The AeroDR 1012HQ and AeroDR 3 Detector do not use the AeroDR Grip sheet.

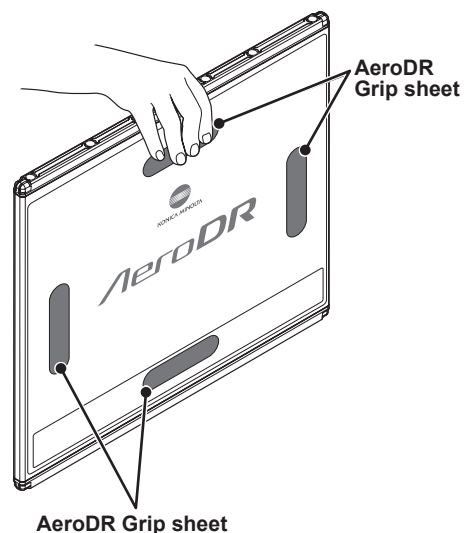





Chapter 4

Status (LED) Display

4.1 LED display of respective devices

Status of the respective devices can be confirmed with LEDs.
Check the status of the respective devices, referring to the "LED display pattern".

LED display pattern

Notation	Display pattern
	Off
	Slow flashing
	Fast flashing
	On



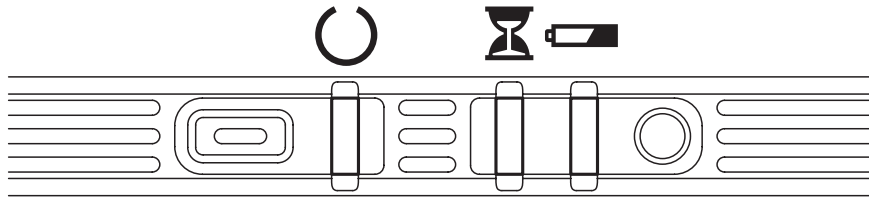

HINT

- For the AeroDR 3 Detector specific display patterns and their statuses, refer to "4.1.3 AeroDR 3 Detector".



4.1.1 AeroDR Detector







 : Status LED (green)

Display pattern	Status
	Shutdown condition
	Standing by
	DR Detector being selected
	Exposing

 : Busy/error LED (orange)

Display pattern	Status
	Shutdown condition or standing by
	Exposing or performing maintenance
	Error occurred

 : Battery LED (blue)

Display pattern	Status
	Shutdown condition or battery level is 10 % or above
	Battery level is less than 10 %
	Battery level is less than 5 %
	Battery level is less than 3 %



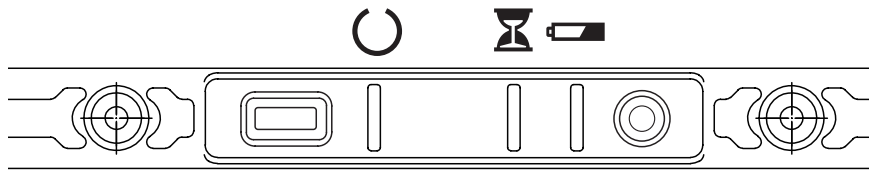

HINT

- During startup/shutdown processing, it also flashes fast and is lit.
-



4.1.2 AeroDR 2 Detector







 : Status LED (green)

Display pattern	Status
	Shutdown condition
	Standing by
	DR Detector being selected
	Exposing

 : Busy/error LED (orange)

Display pattern	Status
	Shutdown condition or standing by
	Exposing or performing maintenance
	Error occurred

 : Battery LED (blue)

Display pattern	Status
	Shutdown condition or battery level is 10 % or above
	Battery level is less than 10 %
	Battery level is less than 5 %
	Battery level is less than 3 %

HINT

- During startup/shutdown processing, it also flashes fast and is lit.
-

4.1.3 AeroDR 3 Detector

IMPORTANT

- When an error occurs, all 3 LEDs, which are the Mode LED, Information LED and Status LED, light or flash at the same time.

Startup/shutdown LED display patterns

Display pattern	LED	Lighting color	Lighting pattern	Status
	Information LED	White	Fast flashing	Startup condition
	Information LED	White	Fast flashing and on	
	Information LED	White	Fast flashing and on	
	Battery LED	Blue or Orange	On or Flashing	Startup completed
	Information LED	White	Fast flashing	Shutdown condition
	Battery LED	Blue or Orange	On or Flashing	
	Information LED	White	Fast flashing and on	
	Battery LED	Blue or Orange	On or Flashing	
	Information LED	White	Fast flashing and on	Shutdown condition
	Battery LED	Blue or Orange	On or Flashing	
	-	-	Off	Shutdown completed

Startup/shutdown LED display patterns



Display pattern	LED	Lighting color	Lighting pattern	Status
	Mode LED	Orange	On	Error occurred
	Information LED	White	Flashing very fast	
	Status LED	Orange	On	

HINT

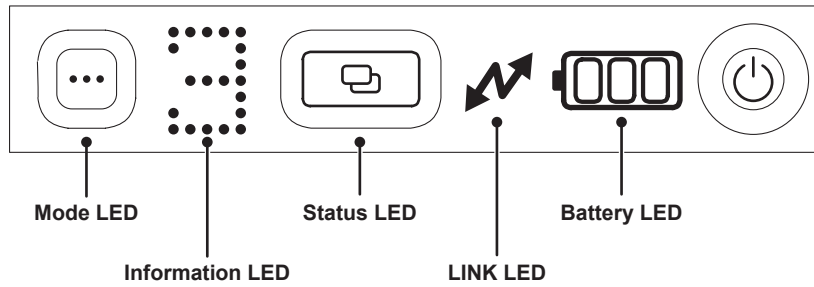



- The Battery LED changes according to the level of battery power of the DR Detector.



 : Mode LED (blue)

Display pattern	Status
	Can exposure with basic connection
	Standing by (Waiting for X-ray exposure), preparing Aero Storage, or Aero Storage in the sleep state

 : Information LED (white)



Display pattern	Lightning pattern	Status
	Flashing fast and on	Startup condition
	Flashing fast and on	Shutdown condition
	Flashing very slowly	Impact occurred
	Flashing	Error occurred

Aero Storage

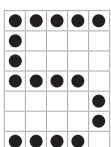
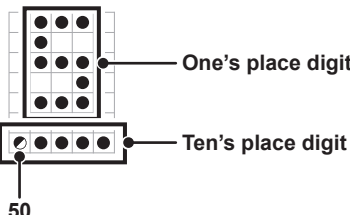
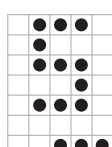
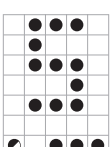

In Aero Storage mode, the number of saved images is displayed on the information LED.

IMPORTANT



- When reading the number of the saved images displayed on the information LED, ensure that the Power SW is on the right.
-

Display pattern	Lightning pattern	Status
The number of saved images: Same as when on	Fast flashing	Preparing
	On	The number of saved images is 0-9
 <p>One's place digit</p> <p>Ten's place digit</p> <p>50</p>	One's place digit : On Ten's place digit : On 50 : Slow flashing	The number of saved images is 10-99 (Examples) 35  85 
	On	The number of saved images is 100, Aero Storage in the sleep state



 : Status LED (blue/orange)

Display pattern	Lighting color	Status
	Orange	Standing by (Waiting for X-ray exposure)
	Orange	Exposing (Reading an image)
	Blue	DR Detector being selected











Aero Storage

Display pattern	Lighting color	Status
	Off	Aero Storage in the sleep state
	Orange	Preparing or during Image processing
	Blue	Standing by (Waiting for X-ray exposure)

 : LINK LED (blue)

Display pattern	Status
	Not connecting
	Wireless connection with image processing controller
	Wired connection with image processing controller or during wired / wireless simultaneous connection

 : Battery LED (blue/orange)

Display pattern		Lighting color		Status
Not charging	Charging	Not charging	Charging	
		Orange	Orange	Battery level is less than 3 %
		Orange	Blue	Battery level is less than 10 %
		Blue	Blue	Battery level is less than 34 %
				Battery level is less than 67 %
		Blue	Blue	Battery level is less than 80 %
		Blue	Blue	Battery level is 80 % or more

HINT

- When both error and impact occur at the same time, the Information LED displays the “E” mark for the error prior to the impact.
 - The Information LED provides 3 types of fast flashing and lighting patterns during startup and shutdown processing.
-

4.1.4 AeroDR Interface Unit

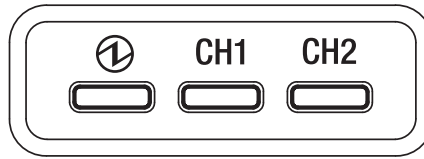

⌚ : Power LED (green)

Display pattern	Status
	Shutdown condition
	Operating

CH1 : Feeding1 LED (blue)

Display pattern	Status
	Shutdown condition or feeding1 is not connected to the DR Detector
	The DR Detector is connected to feeding1

CH2 : Feeding2 LED (blue)

Display pattern	Status
	Shutdown condition or feeding2 is not connected to the DR Detector
	The DR Detector is connected to feeding2

4.1.5 AeroDR Interface Unit2

Detector Connection LED

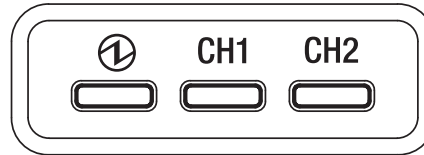

Ⓛ : Power LED (green)

Display pattern	Status
	Shutdown condition
	Operating

CH1 : Feeding1 LED (blue)

Display pattern	Status
	Shutdown condition or feeding1 is not connected to the DR Detector
	The DR Detector is connected to feeding1

CH2 : Feeding2 LED (blue)

Display pattern	Status
	Shutdown condition or feeding2 is not connected to the DR Detector
	The DR Detector is connected to feeding2

Generator Interface LED

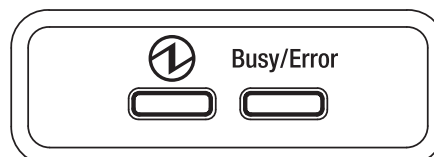

Ⓛ : Power LED (green)

Display pattern	Status
	Shutdown condition
	Operating and not connected to the image processing controller
	Operating and connected to the image processing controller

Busy/Error : Busy/error LED (orange)

Display pattern	Status
	Shutdown condition or standing by
	Exposing or performing maintenance
	Error occurred

4.1.6 Detector Interface Unit/Detector Interface Unit 2



Display pattern	Lighting color	Status
	-	Shutdown condition
	Green	Operating and not connected to the DR Detector
	Blue	Operating and connected to the DR Detector

4.1.7 Power Supply Unit

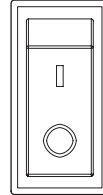

① : Power LED (blue)

Display pattern	Status
	Shutdown condition
	Operating

4.1.8 AeroDR Generator Interface Unit

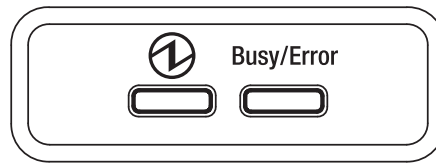

① : Power LED (green)

Display pattern	Status
	Shutdown condition
	Operating and not connected to the image processing controller
	Operating and connected to the image processing controller

Busy/Error : Busy/error LED (orange)

Display pattern	Status
	Shutdown condition or standing by
	Exposing or performing maintenance
	Error occurred

4.1.9 AeroDR Generator Interface Unit2

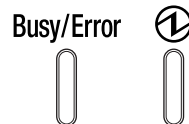

Busy/Error : Busy/error LED (orange)

Display pattern	Status
	Shutdown condition or standing by
	Exposing or performing maintenance
	Error occurred

① : Power LED (green)

Display pattern	Status
	Shutdown condition
	Operating and not connected to the image processing controller
	Operating and connected to the image processing controller

4.1.10 Generator Interface Unit 3



① : Power LED (blue)

Display pattern	Status
	Shutdown condition
	Operating

4.1.11 AeroDR Battery Charger

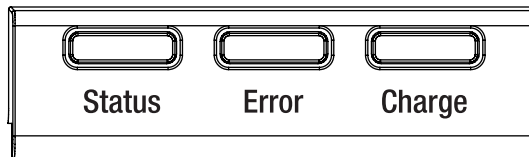

Status : Status LED (green)

Display pattern	Status
	Shutdown condition
	Operating
	Registration processing of the inserted DR Detector is complete

Error : Error LED (orange)

Display pattern	Status
	Shutdown condition or operating normally
	Error occurred

Charge : Feeding LED (blue)

Display pattern	Status
	Shutdown condition or standing by for insertion of the DR Detector Battery charged during DR Detector insertion
	DR Detector battery charging

HINT

- Because the charger dedicated for charging does not perform registration processing of the DR Detector, the status LED always flashes slowly.
-

4.1.12 AeroDR Battery Charger2

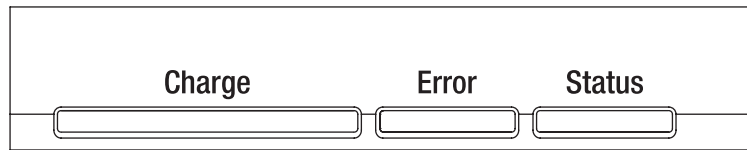

Charge : Feeding LED (blue)

Display pattern	Status
	Shutdown condition or standing by for insertion of the DR Detector
	DR Detector battery charging (battery level is less than 2 %)
	DR Detector battery charging (battery level is 3 to 49 %)
	DR Detector battery charging (battery level is 50 to 79 %)
	DR Detector battery charging (battery level is higher than 80 %)

Error : Error LED (orange)

Display pattern	Status
	Shutdown condition or operating normally
	Error occurred

Status : Status LED (green)

Display pattern	Status
	Shutdown condition
	Operating
	Registration processing of the inserted DR Detector is complete

HINT

- Because the charger dedicated for charging does not perform registration processing of the DR Detector, the status LED always flashes slowly.
- If an AeroDR 3 Detector is installed to the AeroDR Battery Charger2, the Feeding LED shows the same remaining battery percentage as the Battery LED of the AeroDR 3 Detector. For the AeroDR 3 Detector Battery LED displays, refer to "4.1.3 AeroDR 3 Detector".

4.1.13 AeroDR Access Point

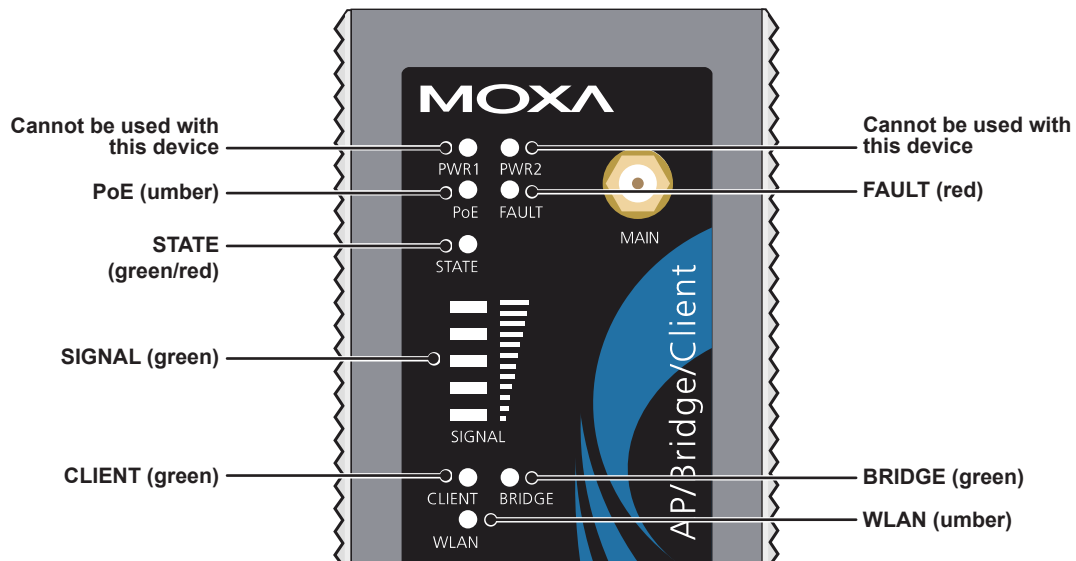

LED	Lighting color	Lighting pattern	Status
PoE	Umber	On	Power is being supplied.
FAULT	Red	Flashing	Error is occurring.
STATE	Green/ Red	Green/on	Lights when operation preparation is completed.
		Red/on	Error is occurring.
SIGNAL	Green	On	Signal strength of wireless. (Only in client mode)
BRIDGE	Green	On	Operating in bridge mode.
CLIENT	Green	On	Operating in client mode.
WLAN	Umber	On	Operating in wireless LAN mode. (Normal)

Chapter 5

Troubleshooting

5.1 Support flow during trouble

If the following problems occur with any of these devices, consult the respective references for countermeasures.

Status	Device	Reference for countermeasures
Error code is displayed.	<ul style="list-style-type: none"> • DR Detector • AeroDR Interface Unit2 • AeroDR Generator Interface Unit • AeroDR Generator Interface Unit2 • Generator Interface Unit 3 	Consult the "Operation Manual" of the image processing controller to take the countermeasures.
Error LED lights.	<ul style="list-style-type: none"> • DR Detector • AeroDR Interface Unit2 • AeroDR Generator Interface Unit • AeroDR Generator Interface Unit2 	Confirm the error code displayed on the image processing controller, and perform corrective actions.
	AeroDR Battery Charger	Consult "5.2.10 AeroDR Battery Charger" to take the countermeasures.
	AeroDR Battery Charger2	Consult "5.2.11 AeroDR Battery Charger2" to take the countermeasures.

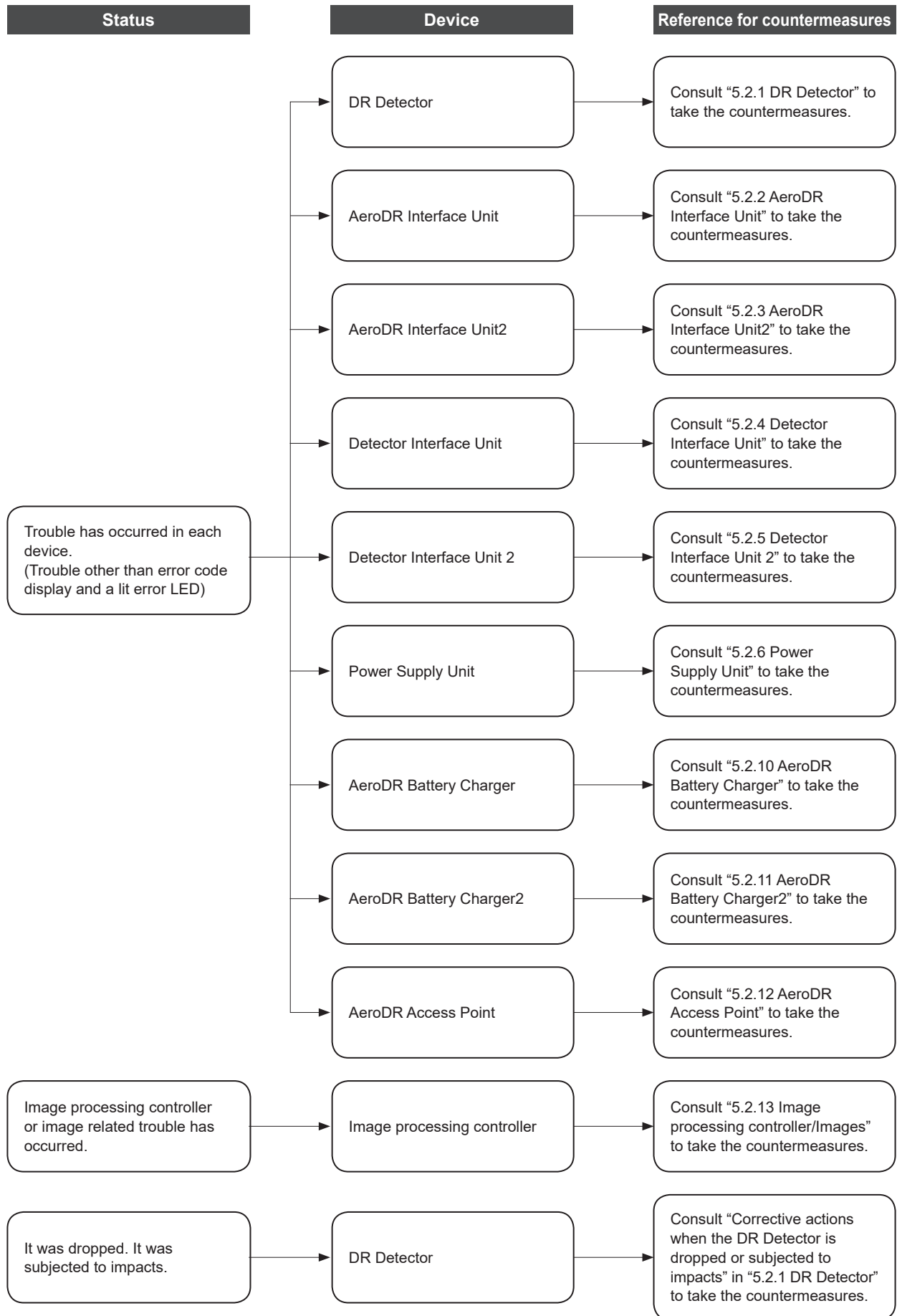

5.2 Various problems and countermeasures

If the following problems occur with any of these devices, consult the respective references for countermeasures.

IMPORTANT

- After performing countermeasures, if the problem does not go away, contact Konica Minolta technical representatives.
- If the exterior or protective cover is damaged extensively, contact Konica Minolta technical representatives.

HINT

- When an error message has been displayed in the image processing controller, check the error description and countermeasures listed in the "Operation Manual" of the image processing controller.
- When using a general-purpose hub or access point, refer to its operation manual.

5.2.1 DR Detector

Status	Error description	Corrective actions
The DR Detector does not start up.	Power does not go on even when the power switch is pressed for 2 seconds or longer.	The battery might be out. Charge it as follows. Then, start it. <ul style="list-style-type: none"> • Inserting it into the AeroDR Battery Charger¹ for more than 2 minutes • Inserting it into the AeroDR Battery Charger² for more than 6 minutes • Connecting a wired cable for more than 6 minutes
The DR Detector does not shut down.	Power does not go off even when the power switch is pressed for 5 seconds or longer.	It is not possible to shut down while exposing. Shut down after exposure is ended.
For AeroDR Detector and AeroDR 2 Detector <ul style="list-style-type: none"> • The status LED (green) is lit, and the busy/error LED (orange) flashes rapidly. ("Ready" is not displayed on the image processing controller) 	System error is occurring.	If an error is displayed for about 10 minutes or more, shutdown the DR Detector. Or, when "Ready" is not displayed on the image processing controller, restart it.
For AeroDR 3 Detector <ul style="list-style-type: none"> • The Information LED (white) flashes fast displaying the "E" mark and the Mode LED (orange) and the Status LED (orange) light. ("Ready" is not displayed on the image processing controller) 		
When the DR Detector is placed on a smooth surface, the DR Detector is not stably attached to the smooth surface.	DR Detector is warped.	If the DR Detector is still warped even after the detector is placed on a smooth surface, contact Konica Minolta technical representatives.
	For AeroDR Detector and AeroDR 2 Detector <ul style="list-style-type: none"> • The protective cover is deformed. 	Contact Konica Minolta technical representatives.
	For AeroDR 3 Detector <ul style="list-style-type: none"> • The back board is deformed. 	

Status	Error description	Corrective actions
The DR Detector will not go into the wall stand or table.	DR Detector is warped.	If the DR Detector is still warped even after the detector is placed on a smooth surface, contact Konica Minolta technical representatives.
	For AeroDR Detector and AeroDR 2 Detector • The protective cover is deformed.	Contact Konica Minolta technical representatives.
	For AeroDR 3 Detector • The back board is deformed.	
The DR Detector cannot be inserted in the AeroDR Battery Charger*1 or AeroDR Battery Charger2.	For AeroDR Detector and AeroDR 2 Detector • The protective cover is deformed.	Contact Konica Minolta technical representatives.
	For AeroDR 3 Detector • The back board is deformed.	
	Foreign material is in the wired connection connector of the DR Detector.	Refer to "6.1.2 Cleaning" and remove the foreign material.
	Foreign material is in the bottom of the AeroDR Battery Charger or AeroDR Battery Charger2.	Contact Konica Minolta technical representatives.
The I/F Cable cannot be connected to the DR Detector.	Part of the wired connection connector of the DR Detector is deformed.	Contact Konica Minolta technical representatives.
	The spring connector of the I/F Cable is deformed.	
	Foreign material is in the wired connection connector of the DR Detector.	Refer to "6.1.2 Cleaning" and remove the foreign material.
	Foreign material is in the spring connector on the I/F Cable.	
Only wired connection with the DR Detector cannot be used.	The wired cable is not connected properly.	Check that the wired cable is properly connected to the DR Detector.
Only wireless connection with the DR Detector cannot be used.	There is an error in the access point.	Check that the Ethernet cable is properly connected to the access point.
	The DR Detector and access point are being used under poor conditions. • Wireless does not connect • Wireless communication terminates • Cycle time is extended	Check the installation location of DR Detector and access point. When performance is noticeably lower than at the initial installation of this device, it is possible that the installation environment or usage environment have changed.
DR Detector wired connection connector is heated up.	DR Detector wired connection connector is heated up immediately after charging with AeroDR Battery Charger*1 or AeroDR Battery Charger2.	This is caused by charging and is not a malfunction.
Charging sometimes takes longer.	Charging may take some time if the battery is completely discharged.	It takes time for internal components to start. Because it is not abnormal, wait a bit.
Battery LED (blue or orange) flashes fast.	Usage time with the battery has gotten shorter.	It could be that the charging function of the battery has deteriorated. It can be replaced with a new battery for a fee if necessary.
	The number of images that can be exposed has decreased.	
	The charging time has gotten shorter.	

Various problems and countermeasures

Status	Error description	Corrective actions
No image is acquired.*2	No image appears after X-ray exposure.	(1)Check the following items. <ul style="list-style-type: none"> • Did you perform exposure in "Ready" status? • Are the exposure conditions correct? • Was X-ray output lowered? • Was X-ray voltage set to a lower value? (2)Perform the following procedures. <ul style="list-style-type: none"> • For AeroDR Detector <ul style="list-style-type: none"> — Set the sensitivity setting of the image processing controller to "Large" before exposure. If the setting is already set to "Large", increase the voltage of the X-ray and perform exposure. • For AeroDR 2 Detector and AeroDR 3 Detector <ul style="list-style-type: none"> — Increase the voltage of the X-ray before exposure.
Reading has automatically started.*2	The machine starts reading the image without X-ray exposure.	(1)Check the following items. <ul style="list-style-type: none"> • For AeroDR Detector <ul style="list-style-type: none"> — Was the DR Detector subjected to strong shocks or vibrations while "Ready" was displayed? — Is the sensitivity setting of the image processing controller correct? (Is the sensitivity setting of the image processing controller set to "Large"?) • For AeroDR 2 Detector and AeroDR 3 Detector <ul style="list-style-type: none"> — Was the DR Detector subjected to strong shocks or vibrations while "Ready" was displayed or wasn't an X-ray exposed nearby? (2)Use caution to prevent strong shocks or vibrations and restart exposure.
Exposure was performed in a condition other than when the exposure with the image processing controller was possible.*2	Exposure was performed when "Ready" was not displayed on the image processing controller. Consequently, a correct image was not acquired.	Wait for one minute or more before starting the next exposure.
	Exposure was performed when "Ready" was not displayed.	Wait for 30 seconds or more before starting the next exposure.

*1 The AeroDR 1012HQ and AeroDR 3 1012HQ cannot be inserted into the AeroDR Battery Charger.

*2 Troubleshooting in the Aero Sync mode.

Corrective actions when the DR Detector is dropped or subjected to impacts

- Run a test using the drop/impact panel check tool of the image processing controller.

IMPORTANT

- The drop/impact panel check tool cannot detect all errors.
If you use the DR Detector after the test and find any error in the image, contact Konica Minolta technical representatives.

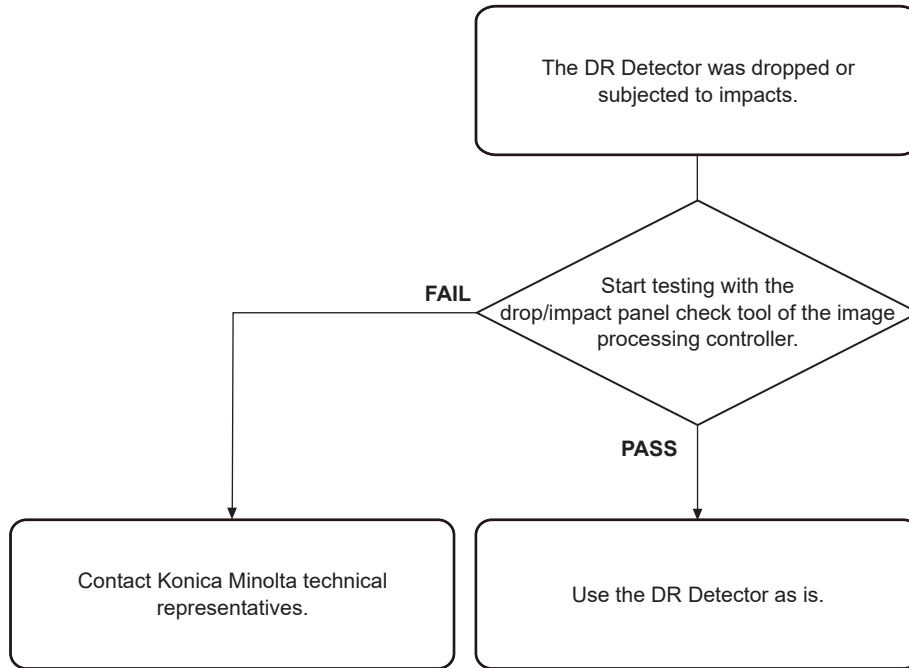

HINT

- If a message is displayed in the image processing controller using the AeroDR 2 Detector, and AeroDR 3 Detector, follow the message and run a test using the drop/impact panel check tool.
- When the AeroDR 3 Detector detect an impact, the Information LED (white) flashes slowly. Run a test using the drop/impact panel check tool.

DR Detector test

IMPORTANT

- If untransferred images remain in the DR Detector, acquire those images before starting the test. The untransferred images in the DR Detector will be deleted when the test starts.
 - Never attempt to test the DR Detector while the DR Detector is connected to the following device.
 - I/F Cable of AeroDR Portable RF Unit2
 - I/F Cable of AeroDR Battery Charging Unit
 - AeroDR Portable UF Detector Charger Kit
-

- 1 Confirm that this device and the image processing controller are powered on.**
- 2 Prepare for exposure with DR Detector.**
 - Place the DR Detector on a stable worktable such as a desk.
 - Make sure that the image processing controller is properly connected to the DR Detector.
- 3 Perform the DR Detector test using the image processing controller.**
- 4 When the DR Detector test is completed, follow the flow above and carry out the corrective action.**

5.2.2 AeroDR Interface Unit

Status	Error description	Corrective actions
Power LED (green) does not light.	AC power not supplied.	Make sure the power cable is connected correctly.
Feeding1/2 LED (blue) does not light.	Feeding1/2 LED (blue) does not light even when connecting the DR Detector.	Make sure that the I/F Cable is connected correctly.
Communications are down between devices, and power LED (green) is off.	The power switch is not on. Or, the power cable is not connected.	Make sure the power switch of the AeroDR Interface Unit is on. Or, make sure the power cable is connected correctly.
The DR Detector is being used with wired connection, but it is not recognized on the image processing controller, and feeding1/2 LEDs (blue) are off.	The I/F Cable is not connected.	Make sure that the I/F Cable is connected correctly.
Battery is not charging while the DR Detector is used with wired connection (the battery level on the battery level display of the image processing controller does not increase), and feeding1/2 LEDs (blue) are off.		

5.2.3 AeroDR Interface Unit2

Status	Error description	Corrective actions
Power LED (green) does not light.	AC power not supplied.	Make sure the power cable is connected correctly.
Feeding1/2 LED (blue) does not light.	Feeding1/2 LED (blue) does not light even when connecting the DR Detector.	Make sure that the I/F Cable is connected correctly.
Communications are down between devices, and power LED (green) is off.	The power switch is not on. Or, the power cable is not connected.	Make sure the power switch of the AeroDR Interface Unit2 is on. Or, make sure the power cable is connected correctly.
The DR Detector is being used with wired connection, but it is not recognized on the image processing controller, and feeding1/2 LEDs (blue) are off.	The I/F Cable is not connected.	Make sure that the I/F Cable is connected correctly.
Battery is not charging while the DR Detector is used with wired connection (the battery level on the battery level display of the image processing controller does not increase), and feeding1/2 LEDs (blue) are off.		

5.2.4 Detector Interface Unit

Status	Error description	Corrective actions
LED(green/blue) does not light.	AC power not supplied.	Make sure that the Ethernet cable is connected to the Power Supply Unit properly. Or, make sure that the DI Unit AC adapter is connected correctly.
LED (blue) does not light.	The I/F cable is not connected to the DR Detector.	Make sure that the DR Detector is connected to the I/F cable correctly.
The DR Detector is being used with wired connection, but it is not recognized on the image processing controller.	The I/F cable is not connected to the DR Detector. Or, the Ethernet cable is not connected to the Power Supply Unit or the hub.	Make sure that the DR Detector is connected to the I/F cable correctly. Or, make sure that the Ethernet cable is connected correctly.

5.2.5 Detector Interface Unit 2

Status	Error description	Corrective actions
LED(green/blue) does not light.	AC power not supplied.	Make sure that the Ethernet cable is connected to the Power Supply Unit properly.
LED (blue) does not light.	The I/F cable is not connected to the DR Detector.	Make sure that the DR Detector is connected to the I/F cable correctly.
The DR Detector is being used with wired connection, but it is not recognized on the image processing controller.	The I/F cable is not connected to the DR Detector. Or, the Ethernet cable is not connected to the Power Supply Unit.	Make sure that the DR Detector is connected to the I/F cable correctly. Or, make sure that the Ethernet cable is connected correctly.
Serial exposure does not start.	The Ethernet cable for relaying serial exposure signals is not connected to the Sync port.	Make sure that the Ethernet cable for relaying serial exposure is connected to the Sync port.

5.2.6 Power Supply Unit

Status	Error description	Corrective actions
LED does not light.	AC power not supplied.	Make sure the power cable is connected correctly.
The power switch cannot be turned on.	There is an error in the power system.	Contact Konica Minolta technical representatives.
The DR Detector is being used with wired connection, but it is not recognized on the image processing controller.	The Ethernet cable is disconnected.	Make sure that the Ethernet cable is connected correctly.

5.2.7 AeroDR Generator Interface Unit

Status	Error description	Corrective actions
LED (green) does not light.	AC power not supplied.	Make sure that the Ethernet cable is connected correctly. Or, make sure the power switch of the AeroDR Interface Unit is on.
LED (green) does not change from flashing to a solid light.	There is a communications error.	Contact Konica Minolta technical representatives.

5.2.8 AeroDR Generator Interface Unit2

Status	Error description	Corrective actions
LED (green) does not light.	AC power not supplied.	Make sure that the Ethernet cable is connected correctly. Make sure the power switch of the AeroDR Interface Unit is on. If the AeroDR Generator Interface Unit2 has a power switch, make sure the power switch is on.
LED (green) does not change from flashing to a solid light.	There is a communications error.	Contact Konica Minolta technical representatives.

5.2.9 Generator Interface Unit 3

Status	Error description	Corrective actions
LED (blue) does not light.	AC power is not supplied.	Make sure that the Ethernet cable is connected correctly. Make sure the power switch of the Power Supply Unit is on. If GIU3 AC Adapter is used, make sure the power cable is connected correctly.
	There is a communications error.	Contact Konica Minolta technical representatives.

5.2.10 AeroDR Battery Charger

Status	Error description	Corrective actions
Status LED (green) does not light.	AC power not supplied.	Make sure that the power cable is connected correctly.
Error LED (orange) is on.	-	Contact Konica Minolta technical representatives.
When the DR Detector*1 is inserted, the error LED (orange) lights.	DR Detector was inserted the wrong way.	Check the insertion orientation of the DR Detector.
	The DR Detector is not inserted correctly.	Make sure that the DR Detector is inserted correctly.
Although the DR Detector*1 is inserted, charging does not start, and the status LED (green) is out.	AC power not supplied.	Make sure that the power cable is connected correctly.
Although the DR Detector*1 is inserted, it cannot be registered, and the status LED (green) is flashing.	The Ethernet cable is disconnected.	Make sure that the Ethernet cable is connected correctly.

*1 The AeroDR 1012HQ and AeroDR 3 1012HQ cannot be inserted into the AeroDR Battery Charger.

5.2.11 AeroDR Battery Charger2

Status	Error description	Corrective actions
Status LED (green) does not light.	AC power not supplied.	Make sure that the power cable is connected correctly.
	The power switch is turned off.	Turn on the power switch.
Error LED (orange) is on.	-	Contact Konica Minolta technical representatives.
When the DR Detector is inserted, the error LED (orange) lights.	DR Detector was inserted the wrong way.	Check the insertion orientation of the DR Detector.
	The DR Detector is not inserted correctly.	Make sure that the DR Detector is inserted correctly.
Although the DR Detector is inserted, charging does not start, and the status LED (green) is out.	AC power not supplied.	Make sure that the power cable is connected correctly.
	The power switch is turned off.	Turn on the power switch.
Although the DR Detector is inserted, it cannot be registered, and the status LED (green) is flashing.	The Ethernet cable is disconnected.	Make sure that the Ethernet cable is connected correctly.

5.2.12 AeroDR Access Point

If a problem occurs in the AeroDR Access Point, contact Konica Minolta technical representatives.

5.2.13 Image processing controller/Images

Status	Error description	Corrective actions
Transverse (noise) has gotten into all images acquired from the DR Detector.	The wired cable is not connected properly.	Connect the wired cable spring connector unit horizontally to the wired connector of the DR Detector.
Operation is normal, but problems can be seen with exposure images.	It has been occurring frequently since a certain time.	Perform calibration.
	There is trouble in only 1 image.	Check the exposure method and image processing.
Exposure cannot be confirmed in image processing controller.	The image processing controller does not become Ready.	Check the image processing controller start up.
	The icons of devices used on the image processing controller are not displayed.	Confirm that the icon of the device to be used is displayed on the system monitor screen. When the icon of the device is not displayed, check that the device to be used is started. Or, check that the Ethernet cable is properly connected.

Chapter 6

Maintenance

6.1 Maintenance and inspection items

This chapter describes the inspections and cleaning required in order to maintain the use of this device in an optimum condition.

Quality Tool

HINT

- "Simple Check QC for CS-7" is available for checking of imaging quality. Please contact our customer service for the detail.
- For details, contact Konica Minolta technical representatives.

6.1.1 Maintenance schedule

The maintenance and inspection items that the user should perform are as follows.

IMPORTANT

- To ensure optimum use of this device, be sure to perform periodic maintenance.
- The following task intervals are estimates and vary according to usage.

Maintenance task	Maintenance interval
Checking and cleaning the surface of the DR Detector	Weekly
Checking for external damage to the DR Detector	Weekly
Cleaning the spring connectors of the wired cable and AeroDR Battery Charger2	Weekly
Cleaning the wired connection connectors of the DR Detector and AeroDR UF Cable	Weekly
Cleaning the AeroDR Battery Charger and AeroDR Battery Charger2	Weekly
Full charge of the DR Detector	Monthly
Calibration	Every year or when a message is displayed

HINT

- Perform calibration when a message that prompts for calibration of the image processing controller is displayed.

6.1.2 Cleaning

IMPORTANT

- Be careful not to apply any cleaning chemical or liquid onto the spring connectors, the wired connection connectors, and the LEDs.
- Do not clean with sharp or hard metal objects. If you cannot remove stains, contact Konica Minolta technical representatives.
- Wear and deformation of the protective cover will occur with the DR Detector due to the way it is handled. The protective cover can be replaced for a fee when the damage becomes extensive, so contact Konica Minolta technical representatives.

DR Detector

IMPORTANT

- If you directly apply or spray anhydrous ethanol on the DR Detector, the liquid will enter the DR Detector through exterior gaps, causing a failure.
- Clean the exterior and AeroDR Grip sheet with a soft lint-free cloth dampened with a small amount of anhydrous ethanol and wrung well.
- To clean the gaps between the exterior of the DR Detector and the protective cover, and the gaps between the exterior of the DR Detector and the AeroDR Grip sheet, remove dirt using a commercial plastic brush.

● AeroDR Detector, AeroDR 2 Detector

IMPORTANT

- The AeroDR 1012HQ do not use the AeroDR Grip sheet.

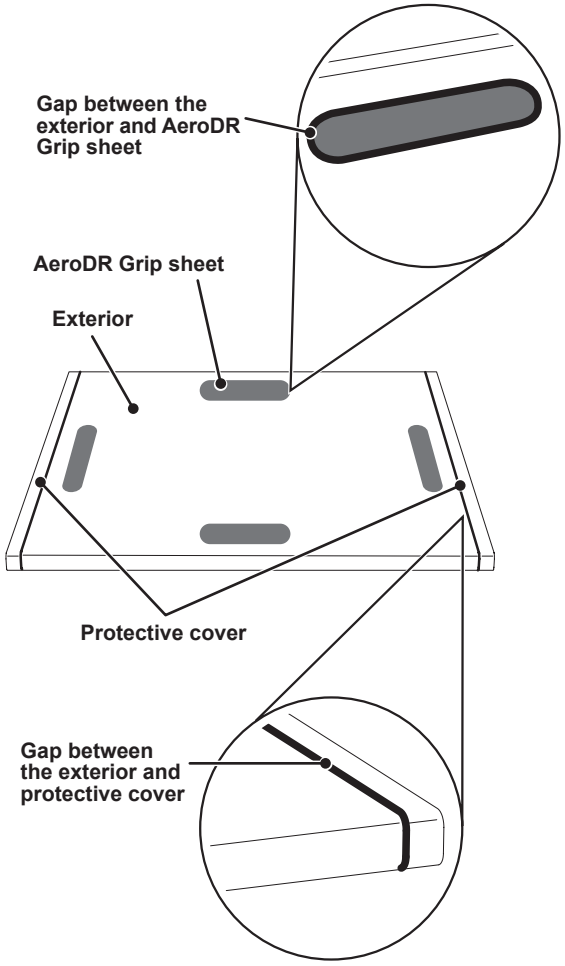

● AeroDR 3 Detector

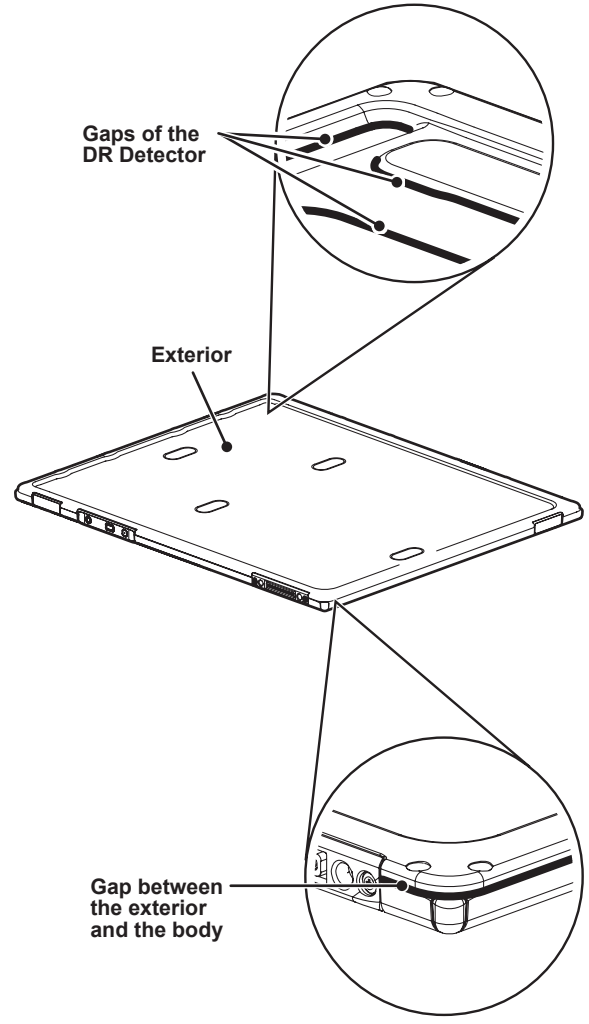

Spring connector

- If foreign material has adhered to the spring connectors of the AeroDR Battery Charger2, and wired cable, remove it with a commercial plastic brush.

● AeroDR Battery Charger2

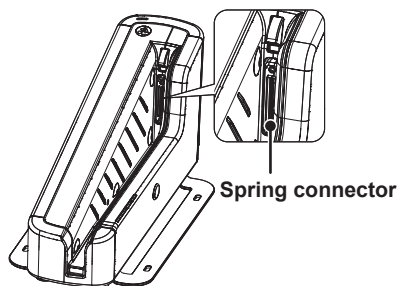

● Wired cable

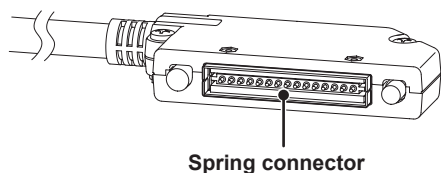

Wired connection connector

- If foreign material has adhered to the wired connection connectors of the DR Detector and AeroDR UF Cable, remove it with a commercial plastic brush.

● DR Detector

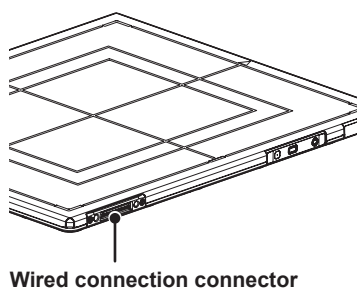

● AeroDR UF Cable

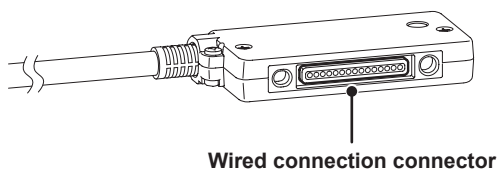

AeroDR Battery Charger

- Clean dust on the insert table of the AeroDR Battery Charger with a soft lint-free cloth dampened with anhydrous ethanol or water and wrung well.

DR Detector insert table (front)

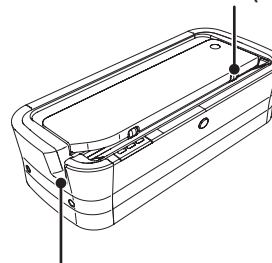

DR Detector insert table (side)

AeroDR Battery Charger2

- Clean dust on the insert table of the AeroDR Battery Charger2 with a soft lint-free cloth dampened with anhydrous ethanol or water and wrung well.

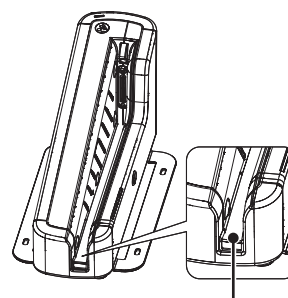

6.1.3 Disinfection of the DR Detector

IMPORTANT

- Bleach and hypochlorite are corrosive, so wash the bleach off well to avoid corrosion.
 - Be careful not to apply any chemical for disinfection onto the wired connection connectors and the LEDs.
 - If you directly apply or spray chemical for disinfection on the DR Detector, the solution will enter the instrument through exterior gaps, causing a failure.
 - Please note that if you use other chemical than instructed, it may affect the quality, performance, and safety of the DR Detector.
-
- If bodily fluid or blood from a patient has contaminated the surface of the DR Detector, disinfect with a soft lint-free cloth dampened with a small quantity of the following disinfectant and wrung well.
 - Ethanol for disinfection
 - Isopropanol for disinfection
 - Commercial chlorine bleach, or 0.5 % hypochlorite (10-fold dilution of household bleach)

6.1.4 Consumables

IMPORTANT

- Refer to each device's manual for information about periodic replacement parts and consumables for the image processing controller, etc.
 - In particular, continued use of the battery may result in degradation and wear, and it may no longer exhibit proper functioning capabilities. For extended, safe use, it is necessary to replace parts which have become worn or degraded.
-

6.1.5 AeroDR Grip sheet affixing and replacement

Application locations

IMPORTANT

- When using a tool to affix the AeroDR Grip sheet or perform replacement, be careful not to get injured by a tip or edge of the tool.
 - For AeroDR Grip sheet affixing or replacement, it is recommended to ask Konica Minolta technical representative.
 - The AeroDR 1012HQ and AeroDR 3 Detector do not use the AeroDR Grip sheet.
 - Be careful not to scratch the DR Detector.
 - Be sure to peel off the label or used AeroDR Grip sheet because it may come off.
 - After removing the label or used AeroDR Grip sheet, clean off any adhesive residue on the surface using a soft cloth moistened with anhydrous ethanol.
-

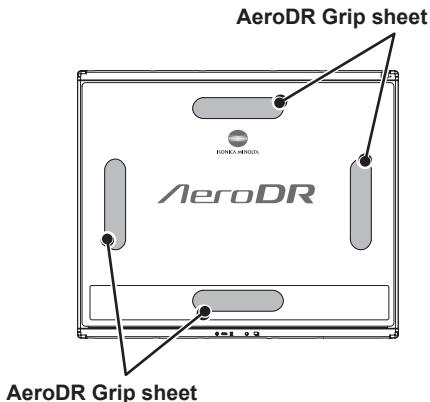

Installation procedure

1 Remove the label from the AeroDR Grip sheet affixing position.

- Insert a precision flat-blade screwdriver, etc. into the step at the AeroDR Grip sheet affixing position to slightly turn the label over, and then remove it completely.

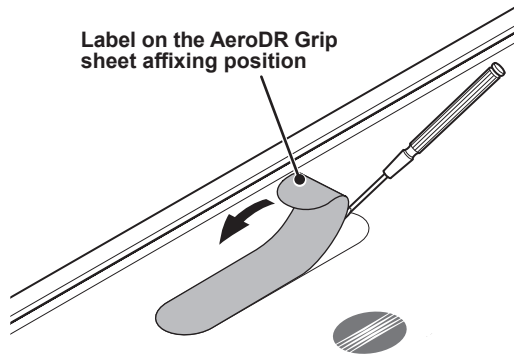

2 Remove dust and contamination from the AeroDR Grip sheet affixing position.

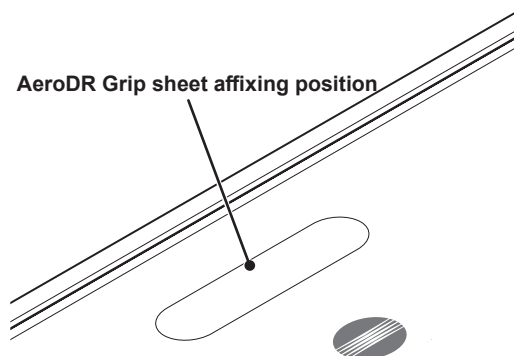

3 Peel off the center piece of the release paper from the AeroDR Grip sheet, and temporarily affix the sheet to the required position on the DR Detector.

- Place the AeroDR Grip sheet in the correct position so that it does not overlap the DR Detector label.

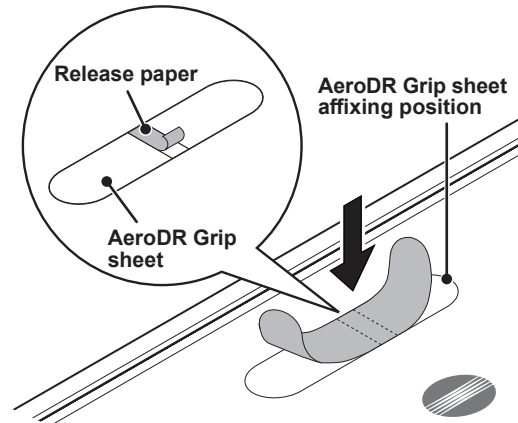

4 Peel off the left and right pieces of the release paper from the AeroDR Grip sheet and affix the sheet to the required position on the DR Detector.

- Affix the sheet slowly from the center to the right and left sides to attach it tightly to the DR Detector.
- Confirm that the AeroDR Grip sheet has been securely placed.

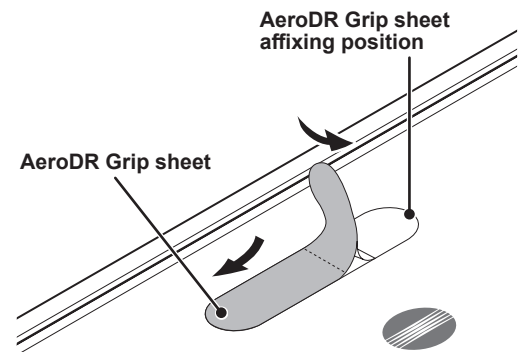

5 Repeat the same steps to affix the other three sheets.

Chapter 7

Specifications

7.1 Specifications

IMPORTANT

- The following specifications described below are nominal values which may be different from actual values and may vary depending on environment and frequency of use. (These are not to provide any guarantees.)
- All specification regarding battery is for a fully-charged battery.

7.1.1 DR Detector

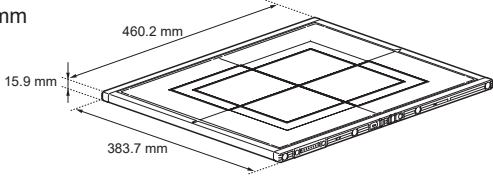
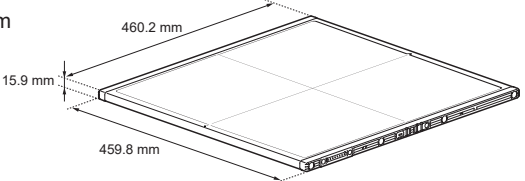
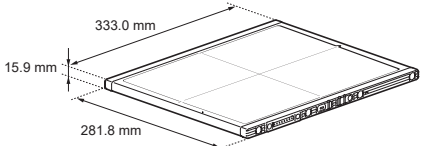
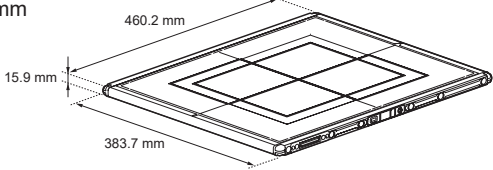
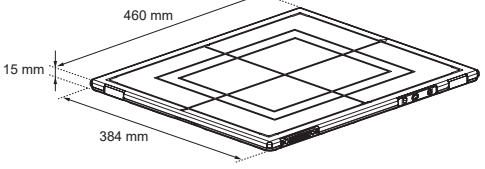
Item	Description
Product name (model name)	AeroDR 1417HQ (AeroDR P-11) AeroDR 1417S (AeroDR P-12) AeroDR 1717HQ (AeroDR P-21) AeroDR 1012HQ (AeroDR P-31) AeroDR 2 1417HQ (AeroDR P-51) AeroDR 2 1417S (AeroDR P-52) P-61 (P-61) P-71 (P-71) P-81 (P-81) P-65 (P-65) P-75 (P-75)
Detection method	Indirect conversion method
Scintillator	CsI (Cesium Iodide)
External dimensions	<p>AeroDR 1417HQ and AeroDR 1417S: 383.7(W)×460.2(D)×15.9(H) mm</p>  <p>AeroDR 1717HQ: 459.8(W)×460.2(D)×15.9(H) mm</p>  <p>AeroDR 1012HQ: 281.8(W)×333.0(D)×15.9(H) mm</p>  <p>AeroDR 2 1417HQ and AeroDR 2 1417S: 383.7(W)×460.2(D)×15.9(H) mm</p>  <p>AeroDR 3 1417HD, AeroDR 3 1417HD2: 384(W)×460(D)×15(H) mm</p> 

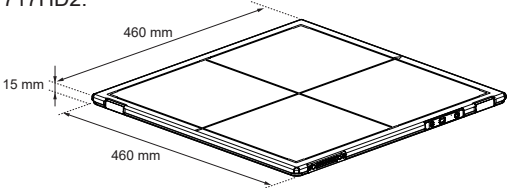
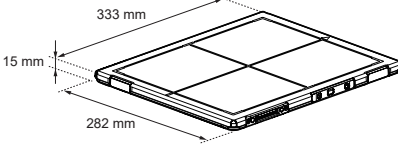
Item	Description
External dimensions	<p>AeroDR 3 1717HD, AeroDR 3 1717HD2: 460(W)×460(D)×15(H) mm</p>  <p>AeroDR 3 1012HQ: 282(W)×333(D)×15(H) mm</p> 
Weight	<p>AeroDR 1417HQ : 2.9 kg AeroDR 1417S : 2.8 kg AeroDR 1717HQ : 3.6 kg AeroDR 1012HQ : 1.7 kg AeroDR 2 1417HQ : 2.6 kg AeroDR 2 1417S : 2.5 kg AeroDR 3 1417HD : 2.6 kg AeroDR 3 1717HD : 3.2 kg AeroDR 3 1012HQ : 1.5 kg AeroDR 3 1417HD2 : 2.6 kg AeroDR 3 1717HD2 : 3.2 kg</p>
Pixel size	<p>AeroDR 1417HQ : 175 um AeroDR 1417S : 175 um AeroDR 1717HQ : 175 um AeroDR 1012HQ : 175 um AeroDR 2 1417HQ : 175 um AeroDR 2 1417S : 175 um AeroDR 3 1417HD : 100 um/200 um AeroDR 3 1717HD : 100 um/200 um AeroDR 3 1012HQ : 100 um/200 um AeroDR 3 1417HD2 : 100 um/200 um AeroDR 3 1717HD2 : 100 um/200 um</p>
Image area size	<p>AeroDR 1417HQ : 348.95×425.25 mm (1,994×2,430 pixels) AeroDR 1417S : 348.95×425.25 mm (1,994×2,430 pixels) AeroDR 1717HQ : 424.9×424.9 mm (2,428×2,428 pixels) AeroDR 1012HQ : 245.7×296.8 mm (1,404×1,696 pixels) AeroDR 2 1417HQ : 348.95×425.25 mm (1,994×2,430 pixels) AeroDR 2 1417S : 348.95×425.25 mm (1,994×2,430 pixels) AeroDR 3 1417HD : 348.8×425.6 mm (3,488×4,256 pixels) AeroDR 3 1717HD : 424.8×424.8 mm (4,248×4,248 pixels) AeroDR 3 1012HQ : 245.6×296.8 mm (2,456×2,968 pixels) AeroDR 3 1417HD2 : 348.8×425.6 mm (3,488×4,256 pixels) AeroDR 3 1717HD2 : 424.8×424.8 mm (4,248×4,248 pixels)</p>
AD conversion	16 bit (65,536 gradients)

Specifications

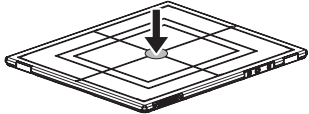
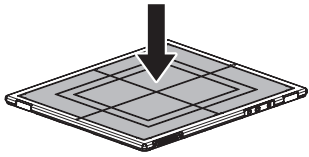
Item	Description
Maximum patient weight	<p>Point load:</p> <p>AeroDR 1417HQ : 150 kg@Φ40 mm AeroDR 1417S : 150 kg@Φ40 mm AeroDR 1717HQ : 150 kg@Φ40 mm AeroDR 1012HQ : 150 kg@Φ40 mm AeroDR 2 1417HQ : 150 kg@Φ40 mm AeroDR 2 1417S : 150 kg@Φ40 mm AeroDR 3 1417HD : 180 kg@Φ40 mm AeroDR 3 1717HD : 180 kg@Φ40 mm AeroDR 3 1012HQ : 180 kg@Φ40 mm AeroDR 3 1417HD2: 180 kg@Φ40 mm AeroDR 3 1717HD2: 180 kg@Φ40 mm</p> <p>Face load:</p> <p>AeroDR 1417HQ : 300 kg@effective image area overall AeroDR 1417S : 300 kg@effective image area overall AeroDR 1717HQ : 300 kg@effective image area overall AeroDR 1012HQ : 300 kg@effective image area overall AeroDR 2 1417HQ : 300 kg@effective image area overall AeroDR 2 1417S : 300 kg@effective image area overall AeroDR 3 1417HD : 400 kg@effective image area overall AeroDR 3 1717HD : 400 kg@effective image area overall AeroDR 3 1012HQ : 400 kg@effective image area overall AeroDR 3 1417HD2: 400 kg@effective image area overall AeroDR 3 1717HD2: 400 kg@effective image area overall</p> <p>* Deadweight, even when loaded on the DR Detector, has no effect on images and the DR Detector. The measurement method is based on KM standards.</p>  
Communication	<p>AeroDR 1417HQ, AeroDR 1417S, AeroDR 1717HQ and AeroDR 1012HQ: Dedicated wired Ethernet connection / wireless LAN (IEEE802.11a compliant)</p> <p>AeroDR 2 1417HQ, AeroDR 2 1417S, AeroDR 3 1417HD, AeroDR 3 1717HD, AeroDR 3 1012HQ, AeroDR 3 1417HD2 and AeroDR 3 1717HD2: Dedicated wired Ethernet connection / wireless LAN (IEEE802.11a/n compliant)</p>
Drive power	Dedicated power cable drive / battery drive
WLAN encryption	<p>Wireless encryption method : AES Authentication method : WPA2-PSK</p>
Patient doses	Patient doses are equivalent to 500-1000 speed film/screen systems.
Required time for wired/wireless switching	Less than 2 seconds
Battery type	Lithium ion capacitor
Number of exposable images	<p>AeroDR 1417HQ : 211 images/5.8 hours AeroDR 1417S : 211 images/5.8 hours AeroDR 1717HQ : 189 images/5.2 hours AeroDR 1012HQ : 146 images/4.0 hours AeroDR 2 1417HQ : 300 images/8.2 hours AeroDR 2 1417S : 150 images/4.1 hours AeroDR 3 1417HD : 100 [um] 251 images/6.9 hours 200 [um] 309 images/8.6 hours AeroDR 3 1717HD : 100 [um] 217 images/6.0 hours 200 [um] 276 images/7.6 hours AeroDR 3 1012HQ : 100 [um] 145 images/3.9 hours 200 [um] 165 images/4.5 hours AeroDR 3 1417HD2: 100 [um] 217 images/6.0 hours 200 [um] 272 images/7.5 hours AeroDR 3 1717HD2: 100 [um] 190 images/5.2 hours 200 [um] 245 images/6.8 hours</p> <p>* Under conditions that the interval between studies is five minutes and three images are captured in each study, assuming 20 seconds for each exposure to position a patient (when connected to the CS-7).</p>

Item	Description
Battery duration in standby status	AeroDR 1417HQ : Approx. 16 hours AeroDR 1417S : Approx. 16 hours AeroDR 1717HQ : Approx. 15 hours AeroDR 1012HQ : Approx. 7.6 hours AeroDR 2 1417HQ : Approx. 20 hours AeroDR 2 1417S : Approx. 10 hours AeroDR 3 1417HD : Approx. 13.2 hours AeroDR 3 1717HD : Approx. 12.2 hours AeroDR 3 1012HQ : Approx. 6.3 hours AeroDR 3 1417HD2 : Approx. 11.6 hours AeroDR 3 1717HD2 : Approx. 10.9 hours
Battery expected lifetime	Above the DR Detector Service life
Serial exposure	Frame rate : 15 fps Max. acquisition time : 20 seconds Max. number of acquisition : 300 Max. Exposure Window : "frame interval time – 53 ms". (e.g. 13 ms @ 15 fps) Pixel size : AeroDR 3 1417HD :400 um AeroDR 3 1717HD :400 um AeroDR 3 1417HD2 :400 um AeroDR 3 1717HD2 :400 um

7.1.2 AeroDR Interface Unit

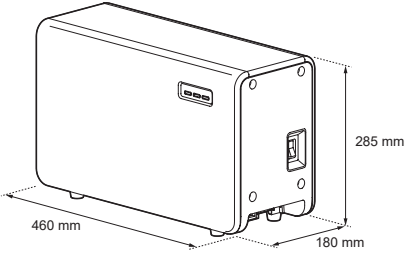
Item	Description
Product name (model name)	AeroDR Interface Unit (AeroDR B-1)
Amount of connectable DR Detectors	2
Power requirements	AC 100/110/120/200/220/240 V ±10 %, single phase, 50/60 Hz
Power consumption	With the DR Detector connected : Approx. 160 VA (100 V-240 V) Without the DR Detector connected : Approx. 33 VA (100 V-240 V)
External dimensions	460(W)×180(D)×285(H) mm 
Weight	11.5 kg

7.1.3 AeroDR Interface Unit2

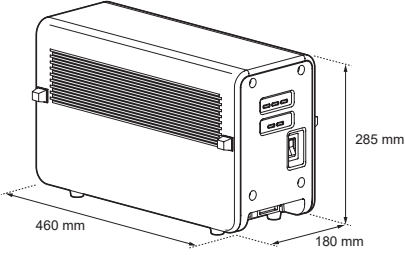
Item	Description
Product name	AeroDR Interface Unit2
Amount of connectable DR Detectors	2
Power requirements	AC 100/110/120/200/220/240 V ±10 %, single phase, 50/60 Hz
Power consumption	With the DR Detector connected : Approx. 160 VA (100 V-240 V) Without the DR Detector connected : Approx. 33 VA (100 V-240 V)
External dimensions	460(W)×180(D)×285(H) mm 
Weight	12.5 kg

7.1.4 Detector Interface Unit

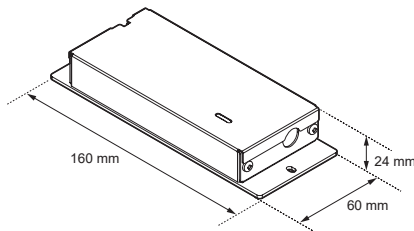
Item	Description
Product name (model name)	Detector Interface Unit (G-21)
Amount of connectable DR Detectors	1
Power requirements	When the AC adapter is used: Supplied from the DI Unit AC Adapter. When the Power Supply Unit is used: Supplied from the Power Supply Unit via the Ethernet cable.
Power supply when using the dedicated AC adapter	AC 100 V-240 V \pm 10 %, single phase, 50/60 Hz
Power consumption when using the dedicated AC adapter	2.62 A (With the DR Detector connected)
External dimensions	60(W) \times 160(D) \times 24(H) mm Without mounting brackets: 60(W) \times 130(D) \times 22(H) mm 
Weight	0.3 kg
The dedicated AC adapter specifications	Product Name : SWITCHING POWER SUPPLY (Model Number. SINPRO ELECTRONICS CO.,LTD. MPU64-108) Dimensions : 76 \times 146 \times 43 mm (excluding cable) Weight : 440 g INPUT : AC100 V-240 V 1.62 A-0.72 A 47 Hz-63 Hz OUTPUT : DC24 V max.2.62 A Safety : IEC60601-1 Class I

7.1.5 Detector Interface Unit 2

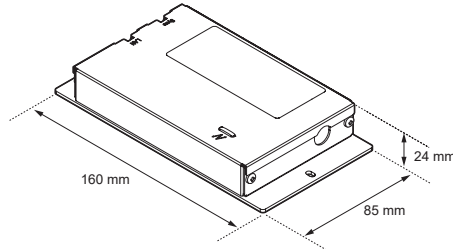
Item	Description
Product name (model name)	Detector Interface Unit 2 (G-52)
Amount of connectable DR Detectors	1
Power requirements	Supplied from the Power Supply Unit via the Ethernet cable.
Power consumption	42.3 W (max) When charging Detector
External dimensions	85(W) \times 160(D) \times 24(H) mm (Excluding lugs) Without mounting brackets: 85(W) \times 130(D) \times 22(H) mm 
Weight	500 g

Specifications

7.1.6 Power Supply Unit

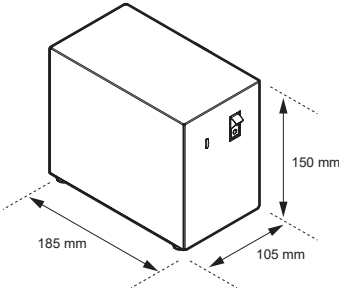
Item	Description
Product name (model name)	Power Supply Unit (G-11)
Power requirements	AC 100 V-240 V \pm 10 %, single phase, 50/60 Hz
Power consumption	Approx. 263.09 VA
Amount of LAN port	3
External dimensions	105(W) \times 185(D) \times 150(H) mm 
Weight	2 kg

7.1.7 AeroDR Generator Interface Unit

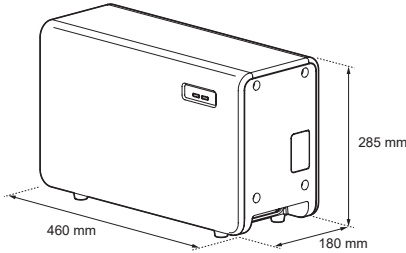
Item	Description
Product name (model name)	AeroDR Generator Interface Unit (AeroDR X-1)
Power supply	Supplied from the AeroDR Interface Unit via the Ethernet cable.
External dimensions	460(W) \times 180(D) \times 285(H) mm 
Weight	7.3 kg

7.1.8 AeroDR Generator Interface Unit2

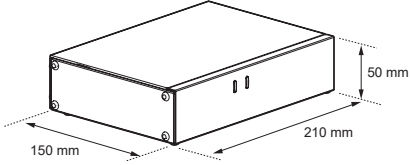
Item	Description
Product name (model name)	AeroDR Generator Interface Unit2 (AeroDR Generator Interface Unit2)
Power requirements	When the AC adapter is used: Supplied from the dedicated AC adapter. When the AeroDR Interface Unit is used: Supplied from the AeroDR Interface Unit via the Ethernet cable. When the Power Supply Unit is used: Supplied from the Power Supply Unit via the Ethernet cable.
Power supply when using the dedicated AC adapter	AC 100 V-240 V ± 10 %, single phase, 50/60 Hz
Power consumption when using the dedicated AC adapter	72 VA (100 V-240 V)
External dimensions	210(W) \times 150(D) \times 50(H) mm 
Weight	0.9 kg
The dedicated AC adapter specifications	Product Name : AC Power Adapter (Model Number: Power-Win Technology Corp. PW-M015A-1Y050KZ) Dimensions : 78 \times 50 \times 35 mm (excluding wall mount & cable) Weight : 130 g INPUT : AC 100 V-240 V 0.6 A-0.3 A 50 Hz-60 Hz OUTPUT : DC 5 V 3 A Safety : IEC60601-1 Class II

7.1.9 Generator Interface Unit 3

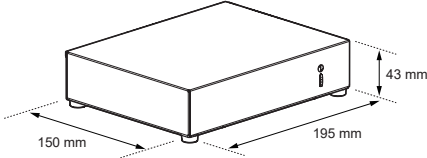
Item	Description
Product name (model name)	Generator Interface Unit 3 (G-51)
Power requirements	When the AC adapter is used: Supplied from the dedicated AC adapter. When the Power Supply Unit is used: Supplied from the Power Supply Unit via the Ethernet cable.
Power supply when using the dedicated AC adapter	AC 100 V-240 V ± 10 %, single phase, 50/60 Hz
Power consumption when using the dedicated AC adapter	72 VA (100 V-240 V)
External dimensions	195(W) \times 150(D) \times 43(H) mm 
Weight	1.0 kg
The dedicated AC adapter specifications	Product Name : AC Power Adapter (Model Number: Power-Win Technology Corp. PW-M015A-1Y050KZ) Dimensions : 78 \times 50 \times 35 mm (excluding wall mount & cable) Weight : 180 g INPUT : AC 100 V-240 V 0.6 A-0.3 A 50 Hz-60 Hz OUTPUT : DC 5 V 3 A Safety : IEC60601-1 Class II

Specifications

7.1.10 AeroDR Battery Charger

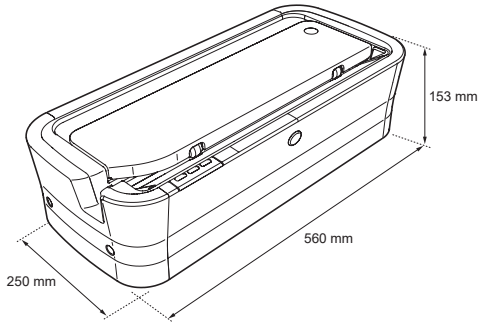
Item	Description
Product name (model name)	AeroDR Battery Charger (AeroDR D-1)
Battery charging system	Automatic charging
Power requirements	AC 100 V-240 V \pm 10 %, single phase, 50/60 Hz
Power consumption	Charging : Approx. 180 VA (100 V-240 V) Standby : Approx. 25 VA (100 V-240 V)
External dimensions	560(W) \times 250(D) \times 153(H) mm 
Weight	7.2 kg

7.1.11 AeroDR Battery Charger2

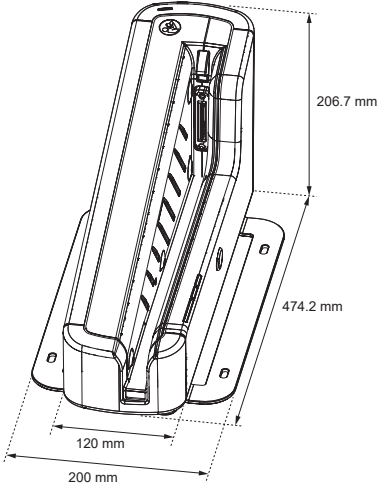
Item	Description
Product name	AeroDR Battery Charger2
Battery charging system	Automatic charging
Power requirements	AC 100 V-240 V \pm 10 %, single phase, 50/60 Hz
Power consumption	Charging : 180 VA (100 V-240 V) Standby : 30 VA (100 V-240 V)
External dimensions	474.2(W) \times 200(D) \times 206.7(H) mm 
Weight	6 kg

7.1.12 AeroDR Access Point

Item	Description
Product name (model name)	AeroDR Access Point (AeroDR C-1)
External dimensions	53.6(W)×135(H)×105(D) mm (without antenna)
Weight	850 g

7.1.13 I/F Cable

Item	Description
Product name	AeroDR I/F Cable AeroDR I/F Cable2 I/F Cable3 0.67mU(G-33) I/F Cable3 1mU(G-57) I/F Cable3 8mD(G-31) I/F Cable3 8mU(G-32) I/F Cable4 1.5mD(G-58) I/F Cable4 8mD(G-53) I/F Cable4 8mU(G-54)
Cable length	AeroDR I/F Cable : 10 m/20 m AeroDR I/F Cable2 : 10 m/20 m I/F Cable3 0.67mU(G-33) : 0.67 m I/F Cable3 1mU(G-57) : 1 m I/F Cable3 8mD(G-31) : 8 m I/F Cable3 8mU(G-32) : 8 m I/F Cable4 1.5mD(G-58) : 1.5 m I/F Cable4 8mD(G-53) : 8 m I/F Cable4 8mU(G-54) : 8 m
External dimensions	AeroDR I/F Cable, AeroDR I/F Cable2, I/F Cable3 8mD(G-31), I/F Cable4 1.5mD(G-58), I/F Cable4 8mD(G-53): 79(W)×42(D)×14(H) mm I/F Cable3 0.67mU(G-33), I/F Cable3 1mU(G-57), I/F Cable3 8mU(G-32), I/F Cable4 8mU(G-54): 79(W)×42(D)×14(H) mm

7.1.14 AeroDR UF Cable

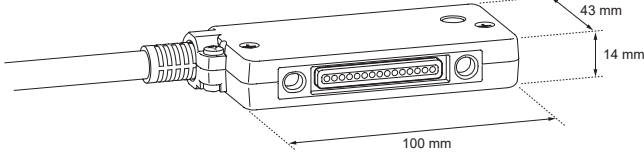
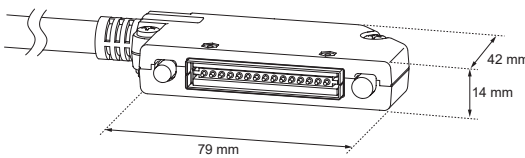

























Item	Description
Product name	AeroDR UF Cable
Cable length	2 m/5 m
External dimensions	<p>Wired connection connector (UIF) side: 100(W)×43(D)×14(H) mm</p>  <p>Spring connector (PIF) side: 79(W)×42(D)×14(H) mm</p> 

7.1.15 Cables and minor components



























Item	Description	
S-SRM	AeroDR S-SRM KIT AeroDR S-SRM KIT 2	
AC adapter	AeroDR AC Adapter KIT DI Unit AC Adapter GIU3 AC Adapter	
AeroDR XG Cable	AeroDR XG Cable Set 100V AeroDR XG Cable Set 120V AeroDR XG Cable Set 220V AeroDR XG Cable Set 230V AeroDR XG Cable Set 240V AeroDR XG Cable Set DC24V AeroDR XG Cable Set DC24V T AeroDR XG Cable Set DC G AeroDR XG Cable Set DC AeroDR XG Cable Set2	
AeroDR Collimator Cable	AeroDR Collimator Cable Set	
AeroDR S-SRM Cable	AeroDR S-SRM Hand S/W 5m Cable AeroDR S-SRM Cable ARX1 AeroDR S-SRM Cable ARX2 AeroDR S-SRM Cable CPX1 AeroDR S-SRM Cable CTX1 AeroDR S-SRM Cable DEX1 AeroDR S-SRM Cable DEX2 AeroDR S-SRM Cable ECX1 AeroDR S-SRM Cable ECX2 AeroDR S-SRM Cable EMX1 AeroDR S-SRM Cable GEX1 AeroDR S-SRM Cable GEX2 AeroDR S-SRM Cable GEX3 AeroDR S-SRM Cable GEX4 AeroDR S-SRM Cable GEX5 AeroDR S-SRM Cable GEX6 AeroDR S-SRM Cable GEX7 AeroDR S-SRM Cable GEX8 AeroDR S-SRM Cable GEX9 AeroDR S-SRM Cable GEX10 AeroDR S-SRM Cable HIX2	AeroDR S-SRM Cable ISX1 AeroDR S-SRM Cable KSX1 AeroDR S-SRM Cable KSX2 AeroDR S-SRM Cable MCX1 AeroDR S-SRM Cable NC AeroDR S-SRM Cable PHX1 AeroDR S-SRM Cable PHX2 AeroDR S-SRM Cable PHX3 AeroDR S-SRM Cable PKX1 AeroDR S-SRM Cable POX1 AeroDR S-SRM Cable SIX1 AeroDR S-SRM Cable SIX2 AeroDR S-SRM Cable SIX4 AeroDR S-SRM Cable SIX5 AeroDR S-SRM Cable SMX1 AeroDR S-SRM Cable SMX3 AeroDR S-SRM Cable SUX1 AeroDR S-SRM Cable TOX1 AeroDR S-SRM Cable TOX3 AeroDR S-SRM Cable TOX4
Serial I/F	GIU3 Serial I/F Kit	

- AeroDR S-SRM Cables is subject to change without notice.
- Other AeroDR S-SRM Cables may be added without notice.
- Some AeroDR S-SRM Cables may not be confirmed to comply with EC Directive 93/42/EEC.



















7.1.16 AeroDR SYSTEM

Item	Description								
Recommended storage and usage environment conditions	When operating	<table border="1"> <thead> <tr> <th>Temperature</th> <th>Humidity</th> <th>Atmospheric pressure</th> </tr> </thead> <tbody> <tr> <td>10 °C to 30 °C </td> <td>35 %RH to 80 %RH (ensure no water condensation) </td> <td>700 hPa to 1060 hPa </td> </tr> </tbody> </table>	Temperature	Humidity	Atmospheric pressure	10 °C to 30 °C 	35 %RH to 80 %RH (ensure no water condensation) 	700 hPa to 1060 hPa 	<p>*Limit continuous use in a hot and humid environment (35 °C to 37 °C/95 % or lower) of an incubator to within 25 minutes.</p>
	Temperature	Humidity	Atmospheric pressure						
	10 °C to 30 °C 	35 %RH to 80 %RH (ensure no water condensation) 	700 hPa to 1060 hPa 						
When not operating	<table border="1"> <thead> <tr> <th>Temperature</th> <th>Humidity</th> <th>Atmospheric pressure</th> </tr> </thead> <tbody> <tr> <td>-10 °C to 40 °C </td> <td>20 %RH to 90 %RH (ensure no water condensation) </td> <td>700 hPa to 1060 hPa </td> </tr> </tbody> </table>	Temperature	Humidity	Atmospheric pressure	-10 °C to 40 °C 	20 %RH to 90 %RH (ensure no water condensation) 	700 hPa to 1060 hPa 		
Temperature	Humidity	Atmospheric pressure							
-10 °C to 40 °C 	20 %RH to 90 %RH (ensure no water condensation) 	700 hPa to 1060 hPa 							
In storage/transport	<table border="1"> <thead> <tr> <th>Temperature</th> <th>Humidity</th> <th>Atmospheric pressure</th> </tr> </thead> <tbody> <tr> <td>-20 °C to 50 °C*1 </td> <td>20 %RH to 90 %RH (ensure no water condensation) </td> <td>700 hPa to 1060 hPa </td> </tr> </tbody> </table>	Temperature	Humidity	Atmospheric pressure	-20 °C to 50 °C*1 	20 %RH to 90 %RH (ensure no water condensation) 	700 hPa to 1060 hPa 	<p>*1 However, performance warranty period when storing at 50 °C is 6 months after packing.</p>	
Temperature	Humidity	Atmospheric pressure							
-20 °C to 50 °C*1 	20 %RH to 90 %RH (ensure no water condensation) 	700 hPa to 1060 hPa 							
Classification	Safety IEC60601-1 Class I								
Operation mode	Continuous operation								

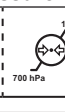
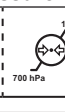
7.1.17 AeroDR SYSTEM 2

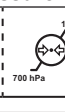
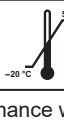
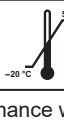
Item	Description								
Recommended storage and usage environment conditions	When operating	<table border="1"> <thead> <tr> <th>Temperature</th> <th>Humidity</th> <th>Atmospheric pressure</th> </tr> </thead> <tbody> <tr> <td>10 °C to 30 °C </td> <td>35 %RH to 80 %RH (ensure no water condensation) </td> <td>700 hPa to 1060 hPa </td> </tr> </tbody> </table>	Temperature	Humidity	Atmospheric pressure	10 °C to 30 °C 	35 %RH to 80 %RH (ensure no water condensation) 	700 hPa to 1060 hPa 	
	Temperature	Humidity	Atmospheric pressure						
	10 °C to 30 °C 	35 %RH to 80 %RH (ensure no water condensation) 	700 hPa to 1060 hPa 						
When not operating	<table border="1"> <thead> <tr> <th>Temperature</th> <th>Humidity</th> <th>Atmospheric pressure</th> </tr> </thead> <tbody> <tr> <td>-10 °C to 40 °C </td> <td>20 %RH to 90 %RH (ensure no water condensation) </td> <td>700 hPa to 1060 hPa </td> </tr> </tbody> </table>	Temperature	Humidity	Atmospheric pressure	-10 °C to 40 °C 	20 %RH to 90 %RH (ensure no water condensation) 	700 hPa to 1060 hPa 		
Temperature	Humidity	Atmospheric pressure							
-10 °C to 40 °C 	20 %RH to 90 %RH (ensure no water condensation) 	700 hPa to 1060 hPa 							
In storage/transport	<table border="1"> <thead> <tr> <th>Temperature</th> <th>Humidity</th> <th>Atmospheric pressure</th> </tr> </thead> <tbody> <tr> <td>-20 °C to 50 °C*1 </td> <td>20 %RH to 90 %RH (ensure no water condensation) </td> <td>700 hPa to 1060 hPa </td> </tr> </tbody> </table>	Temperature	Humidity	Atmospheric pressure	-20 °C to 50 °C*1 	20 %RH to 90 %RH (ensure no water condensation) 	700 hPa to 1060 hPa 	<p>*1 However, performance warranty period when storing at 50 °C is 6 months after packing.</p>	
Temperature	Humidity	Atmospheric pressure							
-20 °C to 50 °C*1 	20 %RH to 90 %RH (ensure no water condensation) 	700 hPa to 1060 hPa 							
Classification	Safety IEC60601-1 Class I								
Operation mode	Continuous operation								

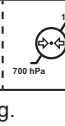
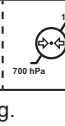
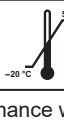
7.1.18 SKR 3000

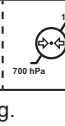
Item	Description									
Recommend- ed storage and usage environment conditions	When oper- ating	<table border="1"> <thead> <tr> <th data-bbox="462 369 740 403">Temperature</th> </tr> </thead> <tbody> <tr> <td data-bbox="462 403 740 488"> 10 °C to 35 °C  </td> </tr> </tbody> </table>	Temperature	10 °C to 35 °C 	<table border="1"> <thead> <tr> <th data-bbox="753 369 1072 403">Humidity</th> </tr> </thead> <tbody> <tr> <td data-bbox="753 403 1072 488"> 35 %RH to 85 %RH (ensure no water condensation)  </td> </tr> </tbody> </table>	Humidity	35 %RH to 85 %RH (ensure no water condensation) 	<table border="1"> <thead> <tr> <th data-bbox="1085 369 1398 403">Atmospheric pressure</th> </tr> </thead> <tbody> <tr> <td data-bbox="1085 403 1398 488"> 700 hPa to 1060 hPa  </td> </tr> </tbody> </table>	Atmospheric pressure	700 hPa to 1060 hPa 
	Temperature									
	10 °C to 35 °C 									
Humidity										
35 %RH to 85 %RH (ensure no water condensation) 										
Atmospheric pressure										
700 hPa to 1060 hPa 										
When not operating	<table border="1"> <thead> <tr> <th data-bbox="462 721 740 754">Temperature</th> </tr> </thead> <tbody> <tr> <td data-bbox="462 754 740 864"> -10 °C to 40 °C  </td> </tr> </tbody> </table>	Temperature	-10 °C to 40 °C 	<table border="1"> <thead> <tr> <th data-bbox="753 721 1072 754">Humidity</th> </tr> </thead> <tbody> <tr> <td data-bbox="753 754 1072 864"> 20 %RH to 90 %RH (ensure no water condensation)  </td> </tr> </tbody> </table>	Humidity	20 %RH to 90 %RH (ensure no water condensation) 	<table border="1"> <thead> <tr> <th data-bbox="1085 721 1398 754">Atmospheric pressure</th> </tr> </thead> <tbody> <tr> <td data-bbox="1085 754 1398 864"> 700 hPa to 1060 hPa  </td> </tr> </tbody> </table>	Atmospheric pressure	700 hPa to 1060 hPa 	
Temperature										
-10 °C to 40 °C 										
Humidity										
20 %RH to 90 %RH (ensure no water condensation) 										
Atmospheric pressure										
700 hPa to 1060 hPa 										
In storage/ transport	<table border="1"> <thead> <tr> <th data-bbox="462 873 740 907">Temperature</th> </tr> </thead> <tbody> <tr> <td data-bbox="462 907 740 1032"> -20 °C to 50 °C*1  </td> </tr> </tbody> </table>	Temperature	-20 °C to 50 °C*1 	<table border="1"> <thead> <tr> <th data-bbox="753 873 1072 907">Humidity</th> </tr> </thead> <tbody> <tr> <td data-bbox="753 907 1072 1032"> 20 %RH to 90 %RH (ensure no water condensation)  </td> </tr> </tbody> </table>	Humidity	20 %RH to 90 %RH (ensure no water condensation) 	<table border="1"> <thead> <tr> <th data-bbox="1085 873 1398 907">Atmospheric pressure</th> </tr> </thead> <tbody> <tr> <td data-bbox="1085 907 1398 1032"> 700 hPa to 1060 hPa  </td> </tr> </tbody> </table>	Atmospheric pressure	700 hPa to 1060 hPa 	
Temperature										
-20 °C to 50 °C*1 										
Humidity										
20 %RH to 90 %RH (ensure no water condensation) 										
Atmospheric pressure										
700 hPa to 1060 hPa 										
*1 However, performance warranty period when storing at 50 °C is 6 months after packing.										
Classification	Safety IEC60601-1 Class I									
Operation mode	Continuous operation									

7.1.19 Label

DR Detector

● AeroDR 1417HQ/AeroDR 1417S



FCC ID : YR7AERO DRP1 IC : 1048H-AERO DRP1
 This device complies with Part 15 of FCC Rules and RSS-Gen of IC Rules. Operation is subject to the following two conditions: (1) this device may not cause interference, and (2) this device must accept any interference, including interference that may cause undesired operation of this device.
 This Class A digital apparatus complies with Canadian ICES-003.

Complies with
 IDA Standards
 DA 104328

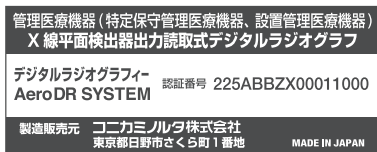

产品名称: 数字 X 射线成像系统
 规格型号: AeroDR SYSTEM
 医疗器械注册证号: 国食药监械(进)字2013第2304598号(更)
 产品标准编号: YZB/JAP 6006-2013《数字X射线成像系统》
 生产企业名称: 柯尼卡美能达株式会社(コニカミノルタ株式会社)
 注册地址: 日本国東京都千代田区丸之内二丁目7番2号
 生产地址: 日本国埼玉県狭山市广瀬台二丁目2番1号



● AeroDR 1717HQ



FCC ID : YR7AERO DRP2 IC : 1048H-AERO DRP2
 This device complies with Part 15 of FCC Rules and RSS-Gen of IC Rules. Operation is subject to the following two conditions: (1) this device may not cause interference, and (2) this device must accept any interference, including interference that may cause undesired operation of this device.
 This Class A digital apparatus complies with Canadian ICES-003.

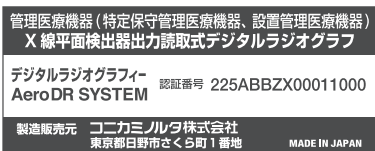

数字 X 射线成像系统
 型 号: AeroDR SYSTEM
 柯尼卡美能达株式会社
 注册地址: 日本国東京都千代田区丸之内二丁目7番2号
 生产地址: 日本国埼玉県狭山市广瀬台2-2-1



● AeroDR 1012HQ



FCC ID : YR7AERO DRP3 IC : 1048H-AERO DRP3
 This device complies with Part 15 of FCC Rules and RSS-Gen of IC Rules. Operation is subject to the following two conditions: (1) this device may not cause interference, and (2) this device must accept any interference, including interference that may cause undesired operation of this device.
 This Class A digital apparatus complies with Canadian ICES-003.

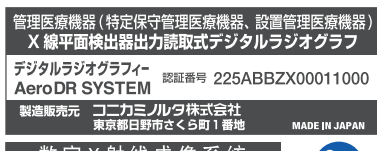

数字 X 射线成像系统
 型 号: AeroDR SYSTEM
 柯尼卡美能达株式会社
 注册地址: 日本国東京都千代田区丸之内二丁目7番2号
 生产地址: 日本国埼玉県狭山市广瀬台2-2-1



● AeroDR 2 Detector



FCC ID : YR7AERODRP5 IC : 1048H-AERODRP5
 This device complies with Part 15 of FCC Rules and Industry Canada license-exempt RSS standard(s). Operation is subject to the following two conditions: (1) this device may not cause interference, and (2) this device must accept any interference, including interference that may cause undesired operation of this device. This Class A digital apparatus complies with Canadian CAN ICES-3(A)/NMB-3(A).

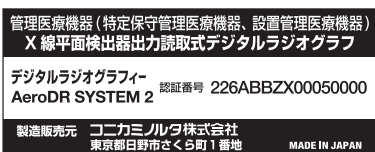

数字 X 射线成像系统
 型 号: AeroDR SYSTEM 2
 柯尼卡美能达株式会社
 注册地址: 日本国東京都千代田区丸之内二丁目7番2号
 生产地址: 日本国埼玉県狭山市广瀬台2-2-1



● AeroDR 3 Detector

DIRECT DIGITIZER SKR 3000

管理医療機器（特定保守管理医療機器、設置管理医療機器）
X線平面検出器出力読取式デジタルラジオグラフィ

デジタルラジオグラフィ- SKR 3000
 登録番号 228ABBZX00115000
 製造販売元 コニカミノルタ株式会社
 東京都日野市さくら町1番地 MADE IN JAPAN

FCC ID : YR7SKR3000P6 IC : 1048H-SKR3000P6
 This device complies with Part 15 of FCC Rules and Industry Canada license-exempt RSS standard(s). Operation is subject to the following two conditions: (1) this device may not cause interference, and (2) this device must accept any interference, including interference that may cause undesired operation of this device. This Class A digital apparatus complies with Canadian CAN ICES-3(A)/NMB-3(A).

KONICA MINOLTA, INC.
1 Sakura-machi, Hino-shi, Tokyo, 191-8511, Japan
MADE IN JAPAN

CE 0197 IPX6

AeroDR Interface Unit

AeroDR B-1 AeroDR 盒

MEDICAL ELECTRICAL EQUIPMENT WITH RESPECT TO ELECTRIC SHOCK - SEE AIE MECHANICAL HAZARDS ONLY IN ACCORDANCE WITH UL 60601-1 (CAN/CSA C22.2 NO. 60951.1)

AC100V 1.6A/
AC110V 1.5A/
AC120V 1.3A/
AC200V 0.8A/
AC220V 0.7A/
AC240V 0.6A/
50/60Hz

SER.NO. 产品批号
SN A20K-00001
产品生产日期 2016-05

KONICA MINOLTA, INC. 柯尼卡美能达株式会社 MADE IN JAPAN

AeroDR Interface Unit2

AeroDR Interface Unit2 AeroDR 盒2

MEDICAL ELECTRICAL EQUIPMENT WITH RESPECT TO ELECTRIC SHOCK - SEE AIE MECHANICAL HAZARDS ONLY IN ACCORDANCE WITH UL 60601-1 (CAN/CSA C22.2 NO. 60951.1)

AC100V 1.6A/
AC110V 1.5A/
AC120V 1.3A/
AC200V 0.8A/
AC220V 0.7A/
AC240V 0.6A/
50/60Hz

SER.NO. 产品批号
SN A6PD-00001
产品生产日期 2016-05

KONICA MINOLTA, INC. 柯尼卡美能达株式会社 MADE IN JAPAN

Detector Interface Unit

SKR 3000 / G-21 (Detector Interface Unit)

AC100V 1.6A/
AC110V 1.5A/
AC120V 1.3A/
AC200V 0.8A/
AC220V 0.7A/
AC240V 0.6A/
50/60Hz

SER.NO. 产品批号
SN A9G5-00001
2016-07-28

GS1
(01)04560141945197(21)A9G5-00001

KONICA MINOLTA, INC. MADE IN JAPAN

7

Detector Interface Unit 2

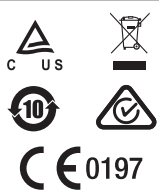
SKR 3000 / G-52(Detector Interface Unit 2)													
	<table border="1"> <tr> <td>SN</td> <td>AC60-00001</td> <td><input type="checkbox"/></td> </tr> <tr> <td></td> <td>2018-04-28</td> <td><input type="checkbox"/></td> </tr> <tr> <td colspan="3"> <div style="border: 1px dashed black; height: 20px; width: 100%;"></div> </td> </tr> <tr> <td colspan="3"> GS1 (01) 04560141947047 (21) AC60-00001 </td> </tr> </table>	SN	AC60-00001	<input type="checkbox"/>		2018-04-28	<input type="checkbox"/>	<div style="border: 1px dashed black; height: 20px; width: 100%;"></div>			GS1 (01) 04560141947047 (21) AC60-00001		
SN	AC60-00001	<input type="checkbox"/>											
	2018-04-28	<input type="checkbox"/>											
<div style="border: 1px dashed black; height: 20px; width: 100%;"></div>													
GS1 (01) 04560141947047 (21) AC60-00001													
KONICA MINOLTA, INC. MADE IN JAPAN													

Power Supply Unit

SKR 3000 / G-11 (Power Supply Unit)																	
	<table border="1"> <tr> <td>100V~240V~</td> <td>SN</td> <td>A9G4-00001</td> <td><input type="checkbox"/></td> </tr> <tr> <td>263VA</td> <td></td> <td>2016-07-28</td> <td><input type="checkbox"/></td> </tr> <tr> <td>50/60Hz</td> <td colspan="3"> <div style="border: 1px dashed black; height: 20px; width: 100%;"></div> </td> </tr> <tr> <td colspan="4"> GS1 (01)04560141945180(21)A9G4-00001 </td> </tr> </table>	100V~240V~	SN	A9G4-00001	<input type="checkbox"/>	263VA		2016-07-28	<input type="checkbox"/>	50/60Hz	<div style="border: 1px dashed black; height: 20px; width: 100%;"></div>			GS1 (01)04560141945180(21)A9G4-00001			
100V~240V~	SN	A9G4-00001	<input type="checkbox"/>														
263VA		2016-07-28	<input type="checkbox"/>														
50/60Hz	<div style="border: 1px dashed black; height: 20px; width: 100%;"></div>																
GS1 (01)04560141945180(21)A9G4-00001																	
KONICA MINOLTA, INC. MADE IN JAPAN																	

AeroDR Generator Interface Unit

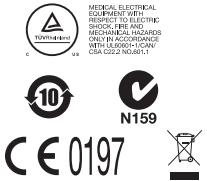
AeroDR X-1													
	<table border="1"> <tr> <td>SER.NO.</td> <td>SN</td> <td>A46K-00001</td> <td><input type="checkbox"/></td> </tr> <tr> <td></td> <td></td> <td>2013 B</td> <td><input type="checkbox"/></td> </tr> <tr> <td colspan="4"> <div style="border: 1px dashed black; height: 20px; width: 100%;"></div> </td> </tr> </table>	SER.NO.	SN	A46K-00001	<input type="checkbox"/>			2013 B	<input type="checkbox"/>	<div style="border: 1px dashed black; height: 20px; width: 100%;"></div>			
SER.NO.	SN	A46K-00001	<input type="checkbox"/>										
		2013 B	<input type="checkbox"/>										
<div style="border: 1px dashed black; height: 20px; width: 100%;"></div>													
KONICA MINOLTA, INC. MADE IN JAPAN													

AeroDR Generator Interface Unit2

AeroDR Generator Interface Unit 2													
	<table border="1"> <tr> <td>SER.NO.</td> <td>SN</td> <td>A7RM-00001</td> <td><input type="checkbox"/></td> </tr> <tr> <td></td> <td></td> <td>2014 B</td> <td><input type="checkbox"/></td> </tr> <tr> <td colspan="4"> <div style="border: 1px dashed black; height: 20px; width: 100%;"></div> </td> </tr> </table>	SER.NO.	SN	A7RM-00001	<input type="checkbox"/>			2014 B	<input type="checkbox"/>	<div style="border: 1px dashed black; height: 20px; width: 100%;"></div>			
SER.NO.	SN	A7RM-00001	<input type="checkbox"/>										
		2014 B	<input type="checkbox"/>										
<div style="border: 1px dashed black; height: 20px; width: 100%;"></div>													
KONICA MINOLTA, INC. MADE IN JAPAN													

Generator Interface Unit 3

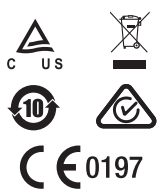
SKR 3000 / G-51(Generator Interface Unit 3)	
	<p>SN AAUN-00001</p> <p>2018-04-28</p> <p>GS1 (01) 04560141946453 (21) AAUN-00001</p>
KONICA MINOLTA, INC. MADE IN JAPAN	

AeroDR Battery Charger

AeroDR D-1	
	<p>AC100V- AC240V</p> <p>180VA</p> <p>50/60Hz</p>
<p>SER.NO.</p> <p>SN A3M4-00001</p> <p>2013 B</p>	
KONICA MINOLTA, INC. MADE IN JAPAN	

AeroDR Battery Charger2

AeroDR Battery Charger2 AeroDR 托架2	
	<p>AC100V- AC240V</p> <p>180VA</p> <p>50/60Hz</p>
<p>SER.NO. 产品批号</p> <p>SN A5TJ-00001</p> <p>产品生产日期 2016-05</p>	
KONICA MINOLTA, INC. 柯尼卡美能达株式会社 MADE IN JAPAN	

AeroDR Access Point

AeroDR C-1 AeroDR 接入点	
	<p>SN A46J-00001</p> <p>2016-05</p>
KONICA MINOLTA, INC. 柯尼卡美能达株式会社 MADE IN JAPAN	

7



KONICA MINOLTA

Konica Minolta Healthcare Americas, Inc.
411 Newark-Pompton Turnpike, Wayne, NJ 07470,
U.S.A.
TEL. 973-633-1500

EU Authorized Representative:

EC	REP
----	-----

**Konica Minolta Business Solutions
Europe GmbH**
Capellalaan 65,2132 JL, Hoofddorp,
The Netherlands
TEL. +31-20-658-4100

Konica Minolta Healthcare India Private Ltd.
Office No.201, 2nd Floor, Atrium 2,
Next to Courtyard Marriott Hotel, Andheri Kurla Road,
Chakala, Andheri (East), Mumbai - 400093, India
TEL. +91-22-61916900

**Konica Minolta Business Solutions (Canada)
Ltd.**
5875 Explorer Drive, Mississauga,
Ontario, L4W 0E1, Canada
TEL. 905-890-6600

**Konica Minolta Medical & Graphic (SHANGHAI)
Co., Ltd.**
Room1602, Tower B, Hongwell International Plaza,
1602 West Zhongshan Road, Xuhui District,
Shanghai 200235 China
TEL. 021-6422-2626

A45YBA01EN30

2020-01-24
(MA)