

FCC Test Report

FCC ID : YQMLLS090
Equipment : Focus Premium
Model No. : Focus Premium
Brand Name : FARO
Applicant : FARO Technologies, Inc.
Address : 250 Technology Park, Lake Mary, Florida,
United States, 32746
Standard : 47 CFR FCC Part 15.247
Received Date : Dec. 16, 2021
Tested Date : Dec. 29, 2021 ~ Feb. 22, 2022

We, International Certification Corporation, would like to declare that the tested sample has been evaluated and in compliance with the requirement of the above standards. The test results contained in this report refer exclusively to the product. It shall not be reproduced except in full without the written approval of our laboratory.

Reviewed by:

Approved by:

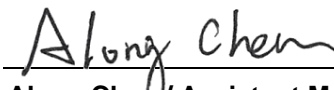

Along Chen / Assistant Manager



Gary Chang / Manager

Table of Contents

1	GENERAL DESCRIPTION	5
1.1	Information.....	5
1.2	Local Support Equipment List	8
1.3	Test Setup Chart	8
1.4	Test Equipment List and Calibration Data.....	9
1.5	Test Standards	10
1.6	Reference Guidance	10
1.7	Deviation from Test Standard and Measurement Procedure.....	10
1.8	Measurement Uncertainty	10
2	TEST CONFIGURATION.....	11
2.1	Testing Facility	11
2.2	The Worst Test Modes and Channel Details	11
3	TRANSMITTER TEST RESULTS	12
3.1	6dB and Occupied Bandwidth	12
3.2	RF Output Power.....	16
3.3	Power Spectral Density	18
3.4	Emissions in Restricted Frequency Bands.....	22
3.5	Emissions in non-restricted Frequency Bands.....	32
4	TEST LABORATORY INFORMATION	35

Release Record

Report No.	Version	Description	Issued Date
FR1D1602AE	Rev. 01	Initial issue	May 04, 2022
FR1D1602AE	Rev. 02	Corrected received date of test sample and company number of ISED	Jun. 14, 2022

Summary of Test Results

FCC Rules	Test Items	Measured	Result
15.207	AC Power Line Conducted Emissions	Note ¹	N/A
15.247(d) 15.209	Radiated Emissions	[dBuV/m at 3m]: 474.75MHz 43.55 (Margin -2.456dB) - QP	Pass
15.247(b)(3)	Maximum Output Power	Power [dBm]: 2.39	Pass
15.247(a)(2)	6dB Bandwidth	Meet the requirement of limit	Pass
15.247(e)	Power Spectral Density	Meet the requirement of limit	Pass
15.203	Antenna Requirement	Meet the requirement of limit	Pass

N/A means Not Applicable.
Note¹: The EUT consumes DC power, so the test is not required.

Declaration of Conformity:

The test results with all measurement uncertainty excluded are presented in accordance with the regulation limits or requirements declared by manufacturers.

Comments and Explanations:

The declared of product specification for EUT presented in the report are provided by the manufacturer, and the manufacturer takes all the responsibilities for the accuracy of product specification.

1 General Description

1.1 Information

1.1.1 Specification of the Equipment under Test (EUT)

RF General Information				
Frequency Range (MHz)	Bluetooth Mode	Ch. Freq. (MHz)	Channel Number	Data Rate
2400-2483.5	V5.0 LE	2402-2480	0-39 [40]	1 Mbps
Note 1: Bluetooth LE (Low energy) uses GFSK modulation.				

1.1.2 Antenna Details

Ant. No.	Type	Connector	Gain (dBi)
1	Dipole	UFL	2.55

1.1.3 Power Supply Type of Equipment under Test (EUT)

Power Supply Type	14.4Vdc from battery
--------------------------	----------------------

1.1.4 Accessories

Accessories		
No.	Equipment	Description
1	Battery	Brand: Akku Power GmbH Model: ACCS-PWR-0014 Power Rating: Nom. Voltage: 14.4V Capacity: 6.8Ah Watt Hour: 97.92Wh Serial Number: 01562
2	3D_AC_LS_SD Card Reader	Brand: Transcend Model: G23758
3	SD Card	Brand: SanDisk Extreme PRO (170MB/s) Capacity: 64GB
4	Status Indicator	Model: 900-000038-001

1.1.5 Test Sample Information

Serial Number of Test Sample	Radiated Emission: LLS092125011 Antenna Port Conducted: LLS092125011
-------------------------------------	---

1.1.6 Channel List

Frequency band (MHz)				2400~2483.5			
Channel	Frequency (MHz)	Channel	Frequency (MHz)	Channel	Frequency (MHz)	Channel	Frequency (MHz)
37	2402	9	2422	18	2442	28	2462
0	2404	10	2424	19	2444	29	2464
1	2406	38	2426	20	2446	30	2466
2	2408	11	2428	21	2448	31	2468
3	2410	12	2430	22	2450	32	2470
4	2412	13	2432	23	2452	33	2472
5	2414	14	2434	24	2454	34	2474
6	2416	15	2436	25	2456	35	2476
7	2418	16	2438	26	2458	36	2478
8	2420	17	2440	27	2460	39	2480

1.1.7 Test Tool and Duty Cycle

Test Tool	QRCT_CONN, Version: v30161	
Duty Cycle and Duty Factor	Duty Cycle (%)	Duty Factor (dB)
	68.52	1.64

1.1.8 Power Index of Test Tool

Modulation Mode	Test Frequency (MHz)		
	2402	2440	2480
BT LE-1Mbps	Default	Default	Default

1.2 Local Support Equipment List

Support Equipment List					
No.	Equipment	Brand	Model	FCC ID	Remarks
1	Notebook	DELL	Latitude 5400	DoC	---
2	USB to RJ45	---	---	---	Provided by applicant.
3	USB 3.1 Flash	pqi	Connect 313/16GB	---	---
4	SD Card	SanDisk	16GB	---	Provided by applicant.

1.3 Test Setup Chart

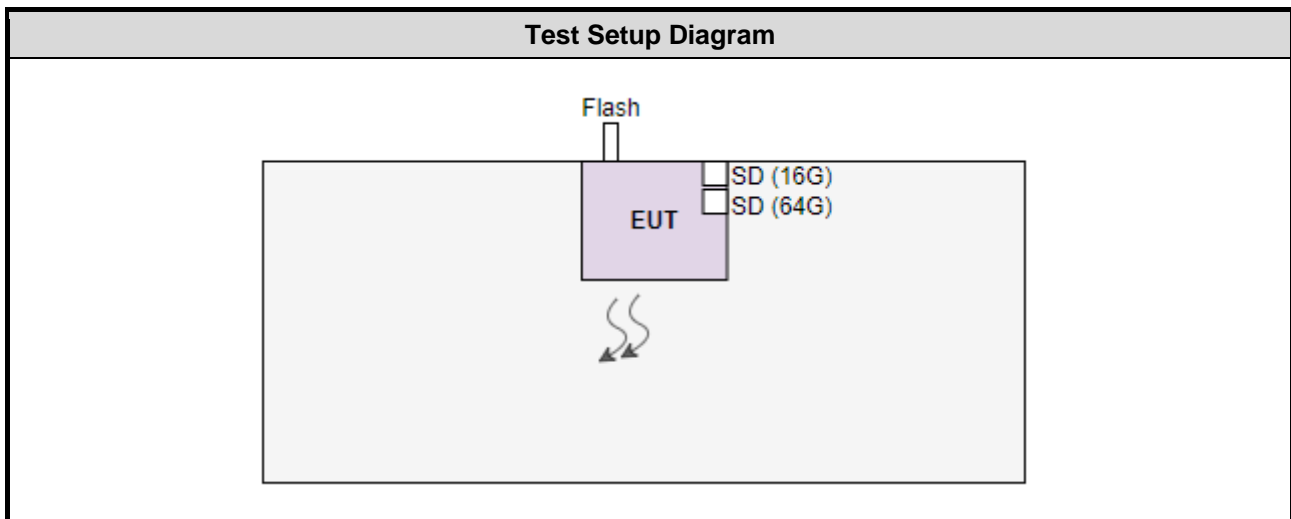

Note: The notebook & USB to RJ45 cable is disconnected from EUT and removed from test table when EUT is set to transmit continuously.

1.4 Test Equipment List and Calibration Data

Test Item	Radiated Emission Below 1GHz				
Test Site	966 chamber3 / (03CH03-WS)				
Tested Date	Dec. 29, 2021				
Instrument	Brand	Model No.	Serial No.	Calibration Date	Calibration Until
Receiver	R&S	ESR3	101657	Mar. 12, 2021	Mar. 11, 2022
Loop Antenna	R&S	HFH2-Z2	100330	Nov. 08, 2021	Nov. 07, 2022
Bilog Antenna	SCHWARZBECK	VULB9168	VULB9168-685	May 06, 2021	May 05, 2022
Preamplifier	EMC	EMC02325	980187	Jul. 26, 2021	Jul. 25, 2022
Loop Antenna Cable	KOAX KABEL	101354-BW	101354-BW	Oct. 05, 2021	Oct. 04, 2022
LF cable-0.8M	EMC	EMC8D-NM-NM-800	EMC8D-NM-NM-800-001	Sep. 24, 2021	Sep. 23, 2022
LF cable-3M	EMC	EMC8D-NM-NM-3000	131103	Sep. 24, 2021	Sep. 23, 2022
LF cable-13M	EMC	EMC8D-NM-NM-13000	131104	Sep. 24, 2021	Sep. 23, 2022
Measurement Software	AUDIX	e3	6.120210g	NA	NA

Note: Calibration Interval of instruments listed above is one year.

Test Item	Radiated Emission Above 1GHz				
Test Site	966 chamber3 / (03CH03-WS)				
Tested Date	Jan. 28, 2022				
Instrument	Brand	Model No.	Serial No.	Calibration Date	Calibration Until
Spectrum Analyzer	R&S	FSV40	101499	Mar. 02, 2021	Mar. 01, 2022
Horn Antenna 1G-18G	SCHWARZBECK	BBHA 9120 D	BBHA 9120 D 1206	Dec. 20, 2021	Dec. 19, 2022
Horn Antenna 18G-40G	SCHWARZBECK	BBHA 9170	BBHA 9170508	Jan. 11, 2022	Jan. 10, 2023
Preamplifier	Agilent	83017A	MY39501309	Sep. 06, 2021	Sep. 05, 2022
Preamplifier	EMC	EMC184045B	980192	Jul. 14, 2021	Jul. 13, 2022
RF cable-3M	HUBER+SUHNER	SUCOFLEX104	MY22620/4	Sep. 24, 2021	Sep. 23, 2022
RF cable-8M	EMC	EMC104-SM-SM-8000	181107	Sep. 24, 2021	Sep. 23, 2022
Measurement Software	AUDIX	e3	6.120210g	NA	NA

Note: Calibration Interval of instruments listed above is one year.

Test Item	RF Conducted				
Test Site	(TH01-WS)				
Tested Date	Feb. 22, 2022				
Instrument	Brand	Model No.	Serial No.	Calibration Date	Calibration Until
Spectrum Analyzer	R&S	FSV40	101498	Nov. 29, 2021	Nov. 28, 2022
Power Meter	Anritsu	ML2495A	1241002	Nov. 07, 2021	Nov. 06, 2022
Power Sensor	Anritsu	MA2411B	1207366	Nov. 07, 2021	Nov. 06, 2022
Measurement Software	Sporton	SENSE-15247_FS	V5.10.7.11	NA	NA
Note: Calibration Interval of instruments listed above is one year.					

1.5 Test Standards

47 CFR FCC Part 15.247
ANSI C63.10-2013

1.6 Reference Guidance

FCC KDB 558074 D01 15.247 Meas Guidance v05r02

1.7 Deviation from Test Standard and Measurement Procedure

None

1.8 Measurement Uncertainty

The measurement uncertainties given below are based on a 95% confidence level (based on a coverage factor ($k=2$)).

Measurement Uncertainty	
Parameters	Uncertainty
Bandwidth	± 34.130 Hz
Conducted power	± 0.808 dB
Power density	± 0.583 dB
AC conducted emission	± 2.92 dB
Radiated emission ≤ 1 GHz	± 3.96 dB
Radiated emission > 1 GHz	± 4.51 dB

2 Test Configuration

2.1 Testing Facility

Test Laboratory	International Certification Corporation
Test Site	TH01-WS
Address of Test Site	No.3-1, Lane 6, Wen San 3rd St., Kwei Shan Dist., Tao Yuan City 33381, Taiwan (R.O.C.)
Test Site	03CH03-WS
Address of Test Site	No.14-1, Lane 19, Wen San 3rd St., Kwei Shan Dist., Tao Yuan City 333, Taiwan (R.O.C.)

- FCC Designation No.: TW0009
- FCC site registration No.: 207696
- ISED#: 10807C
- CAB identifier: TW2732

2.2 The Worst Test Modes and Channel Details

Test item	Mode	Test Frequency (MHz)	Test Configuration
Radiated Emissions ≤ 1GHz	BT-LE(1Mbps)	2480	---
Maximum Output Power 6dB bandwidth Power spectral density Radiated Emissions > 1GHz	BT-LE(1Mbps)	2402, 2440, 2480	---

3 Transmitter Test Results

3.1 6dB and Occupied Bandwidth

3.1.1 Limit of 6dB Bandwidth

The minimum 6dB bandwidth shall be at least 500 kHz.

3.1.2 Test Procedures

6dB Bandwidth

1. Set resolution bandwidth (RBW) = 100 kHz, Video bandwidth = 300 kHz.
2. Detector = Peak, Trace mode = max hold.
3. Sweep = auto couple, Allow the trace to stabilize.
4. Measure the maximum width of the emission that is constrained by the frequencies associated with the two outermost amplitude points (upper and lower) that are attenuated by 6dB relative to the maximum level measured in the fundamental emission.

Occupied Bandwidth

1. Set resolution bandwidth (RBW) = 1% ~ 5 % of OBW, Video bandwidth = 3 x RBW
2. Detector = Sample, Trace mode = max hold.
3. Sweep = auto couple, Allow the trace to stabilize.
4. Use the OBW measurement function of spectrum analyzer to measure the occupied bandwidth.

3.1.3 Test Setup

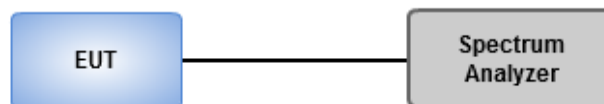

3.1.4 Test Result of 6dB and Occupied Bandwidth

Ambient Condition	22°C / 68%	Tested By	Aska Huang
--------------------------	------------	------------------	------------

Summary

Mode	Max-N dB (Hz)	Max-OBW (Hz)	ITU-Code	Min-N dB (Hz)	Min-OBW (Hz)
2.4-2.4835GHz	-	-	-	-	-
BT-LE(1Mbps)	666.667k	1.06M	1M06F1D	666.667k	1.053M

Max-N dB = Maximum 6dB down bandwidth; Max-OBW = Maximum 99% occupied bandwidth;
Min-N dB = Minimum 6dB down bandwidth; Min-OBW = Minimum 99% occupied bandwidth

Result

Mode	Result	Limit (Hz)	Port 1-N dB (Hz)	Port 1-OBW (Hz)
BT-LE(1Mbps)	-	-	-	-
2402MHz	Pass	500k	666.667k	1.06M
2440MHz	Pass	500k	666.667k	1.053M
2480MHz	Pass	500k	666.667k	1.053M

Port X-N dB = Port X 6dB down bandwidth;
Port X-OBW = Port X 99% occupied bandwidth

BT-LE(1Mbps)

EBW-DTS

2402MHz

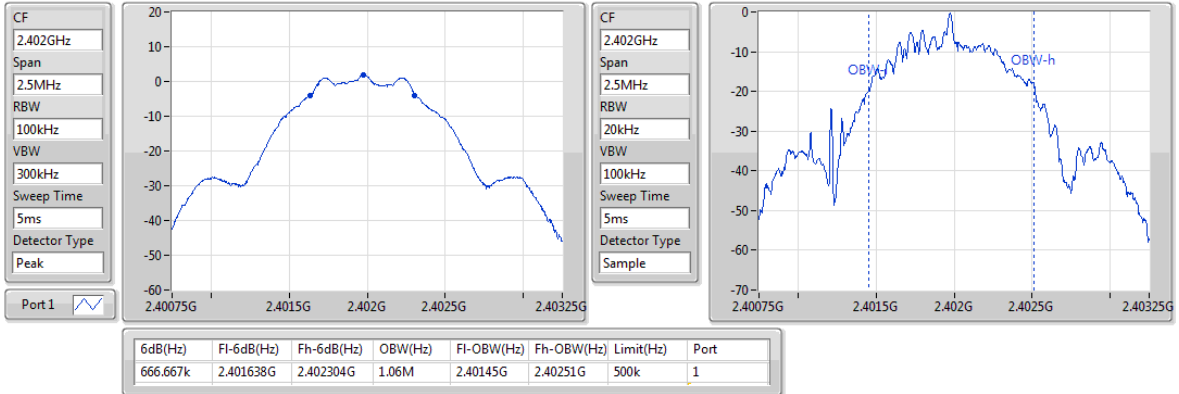

BT-LE(1Mbps)

EBW-DTS

2440MHz

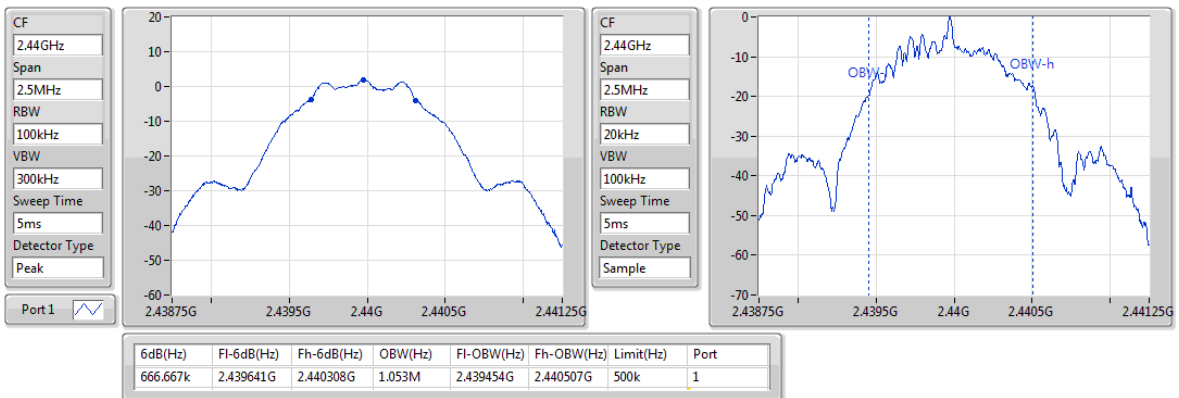

BT-LE(1Mbps)

2480MHz

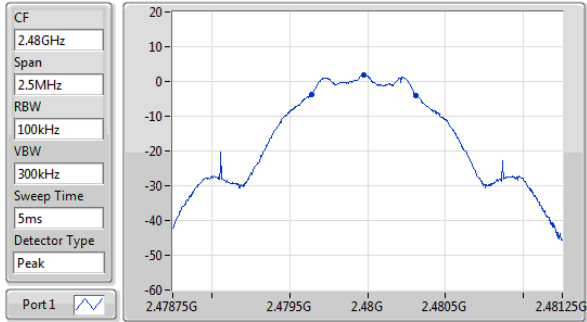

EBW-DTS

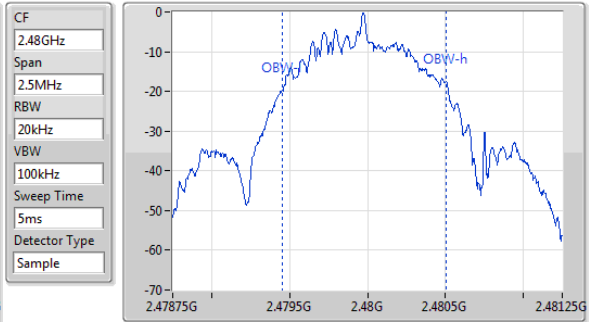

6dB(Hz)	F1-6dB(Hz)	Fh-6dB(Hz)	OBW(Hz)	F1-OBW(Hz)	Fh-OBW(Hz)	Limit(Hz)	Port
666.667k	2.479641G	2.480308G	1.053M	2.479454G	2.480507G	500k	1

3.2 RF Output Power

3.2.1 Limit of RF Output Power

Conducted power shall not exceed 1Watt.

Antenna gain $\leq 6\text{dBi}$, no any corresponding reduction is in output power limit.

3.2.2 Test Procedures

A broadband RF power meter is used for output power measurement. The video bandwidth of power meter is greater than DTS bandwidth of EUT. If duty cycle of test signal is not 100 %, trigger and gating function of power meter will be enabled to capture transmission burst for measuring output power.

3.2.3 Test Setup

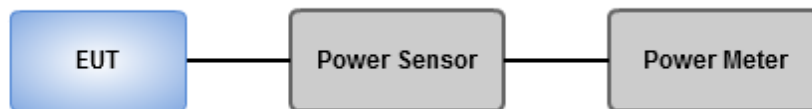

3.2.4 Test Result of Maximum Output Power

Ambient Condition	22°C / 68%	Tested By	Aska Huang
--------------------------	------------	------------------	------------

Summary of Peak Conducted Output Power

Mode	Power (dBm)	Power (W)
2.4-2.4835GHz	-	-
BT-LE(1Mbps)	2.39	0.00173

Result

Mode	Result	Antenna Gain (dBi)	Power (dBm)	Power Limit (dBm)
BT-LE(1Mbps)	-	-	-	-
2402MHz	Pass	2.55	2.24	30.00
2440MHz	Pass	2.55	2.30	30.00
2480MHz	Pass	2.55	2.39	30.00

Summary of Conducted (Average) Output Power

Mode	Power (dBm)	Power (W)
2.4-2.4835GHz	-	-
BT-LE(1Mbps)	2.21	0.00166

Result

Mode	Result	Antenna Gain (dBi)	Power (dBm)	Power Limit (dBm)
BT-LE(1Mbps)	-	-	-	-
2402MHz	Pass	2.55	2.03	-
2440MHz	Pass	2.55	2.12	-
2480MHz	Pass	2.55	2.21	-

Note: Average power is for reference only.

3.3 Power Spectral Density

3.3.1 Limit of Power Spectral Density

Power spectral density shall not be greater than 8 dBm in any 3 kHz band.

3.3.2 Test Procedures

1. Set the RBW = 3 kHz, VBW = 10 kHz.
2. Detector = Peak, Sweep time = auto couple.
3. Trace mode = max hold, allow trace to fully stabilize.
4. Use the peak marker function to determine the maximum amplitude level.

3.3.3 Test Setup

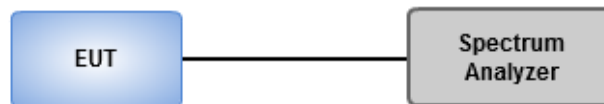

3.3.4 Test Result of Power Spectral Density

Ambient Condition	22°C / 68%	Tested By	Aska Huang
--------------------------	------------	------------------	------------

Summary

Mode	PD (dBm/3kHz)
2.4-2.4835GHz	-
BT-LE(1Mbps)	-12.62

Result

Mode	Result	Antenna Gain (dBi)	Power Density (dBm/3kHz)	Power Density Limit (dBm/3kHz)
BT-LE(1Mbps)	-	-	-	-
2402MHz	Pass	2.55	-12.78	8.00
2440MHz	Pass	2.55	-12.62	8.00
2480MHz	Pass	2.55	-12.73	8.00

BT-LE(1Mbps)

PSD

2402MHz

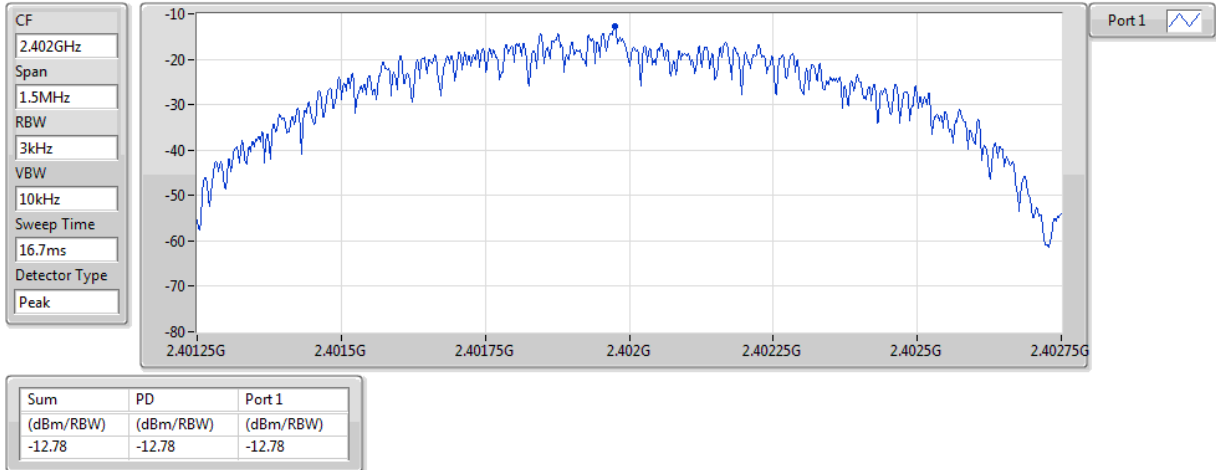

BT-LE(1Mbps)

PSD

2440MHz

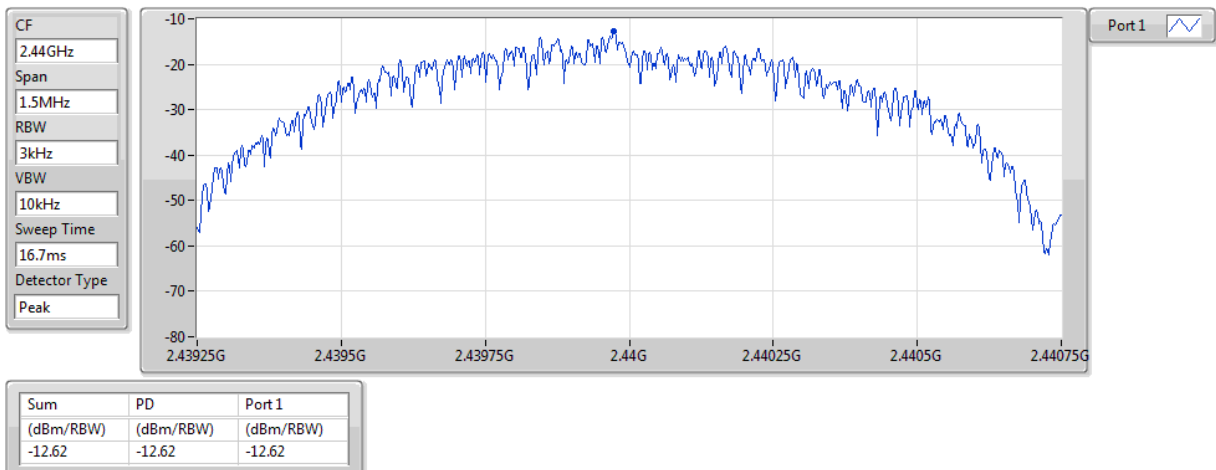

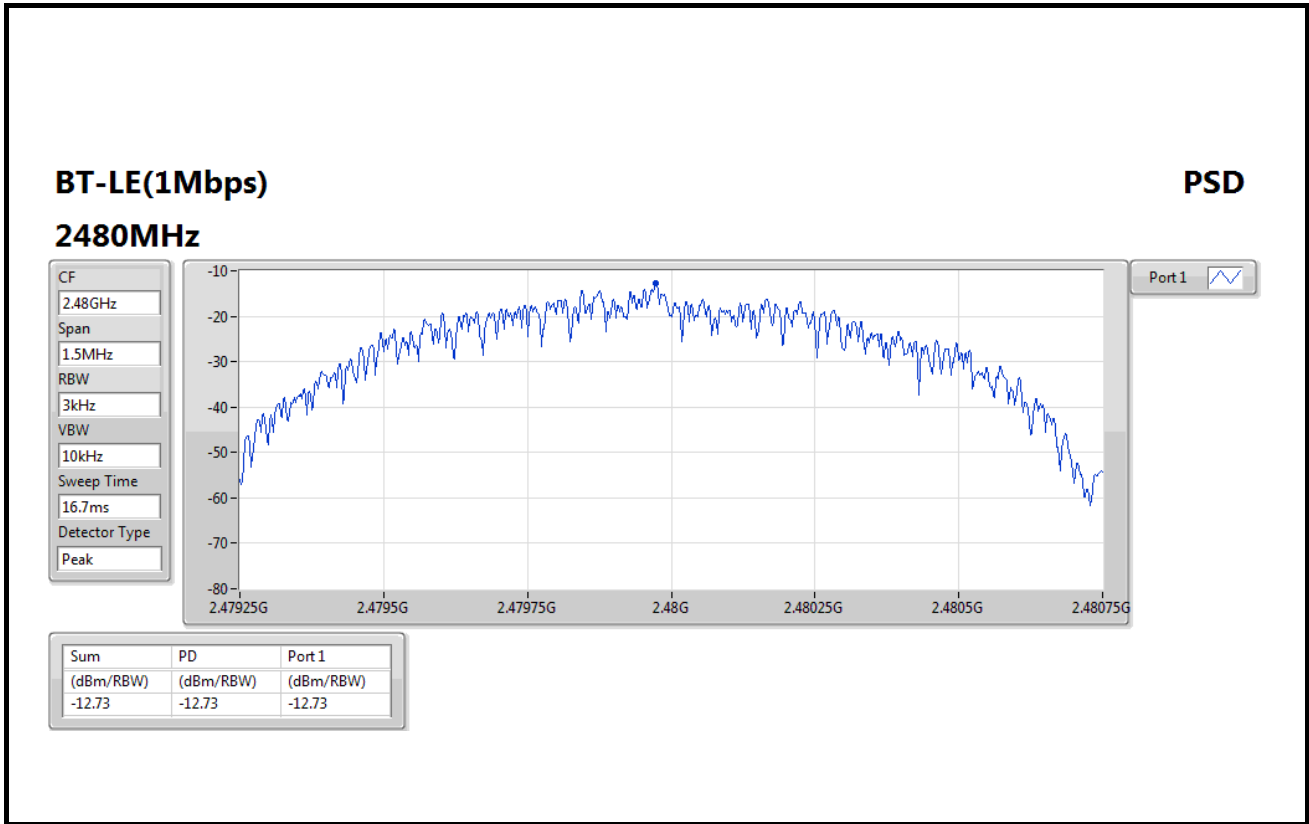

3.4 Emissions in Restricted Frequency Bands

3.4.1 Limit of Emissions in Restricted Frequency Bands

Restricted Band Emissions Limit			
Frequency Range (MHz)	Field Strength (uV/m)	Field Strength (dBuV/m)	Measure Distance (m)
0.009~0.490	2400/F(kHz)	48.5 - 13.8	300
0.490~1.705	24000/F(kHz)	33.8 - 23	30
1.705~30.0	30	29	30
30~88	100	40	3
88~216	150	43.5	3
216~960	200	46	3
Above 960	500	54	3

Note 1:
Qusai-Peak value is measured for frequency below 1GHz except for 9–90 kHz, 110–490 kHz frequency band. Peak and average value are measured for frequency above 1GHz. The limit on average radio frequency emission is as above table. The limit on peak radio frequency emissions is 20 dB above the maximum permitted average emission limit

Note 2:
Measurements may be performed at a distance other than what is specified provided. When performing measurements at a distance other than that specified, the results shall be extrapolated to the specified distance using an extrapolation factor as below, Frequency at or above 30 MHz: 20 dB/decade Frequency below 30 MHz: 40 dB/decade.

3.4.2 Test Procedures

1. Measurement is made at a semi-anechoic chamber that incorporates a turntable allowing a EUT rotation of 360°. A continuously-rotating, remotely-controlled turntable is installed at the test site to support the EUT and facilitate determination of the direction of maximum radiation for each EUT emission frequency. The EUT is placed at test table. For emissions testing at or below 1 GHz, the table height is 80 cm above the reference ground plane. For emission measurements above 1 GHz, the table height is 1.5 m
2. Measurement is made with the antenna positioned in both the horizontal and vertical planes of polarization. The measurement antenna is varied in height (1m ~ 4m) above the reference ground plane to obtain the maximum signal strength. Distance between EUT and antenna is 3 m.
3. This investigation is performed with the EUT rotated 360°, the antenna height scanned between 1 m and 4 m, and the antenna rotated to repeat the measurements for both the horizontal and vertical antenna polarizations.

Note:

1. 120kHz measurement bandwidth of test receiver and Quasi-peak detector is for radiated emission below 1GHz.
2. RBW=1MHz, VBW=3MHz and Peak detector is for peak measured value of radiated emission above 1GHz.
3. RBW=1MHz, VBW=1/T and Peak detector is for average measured value of radiated emission above 1GHz.

3.4.3 Test Setup

Radiated Emissions below 1 GHz

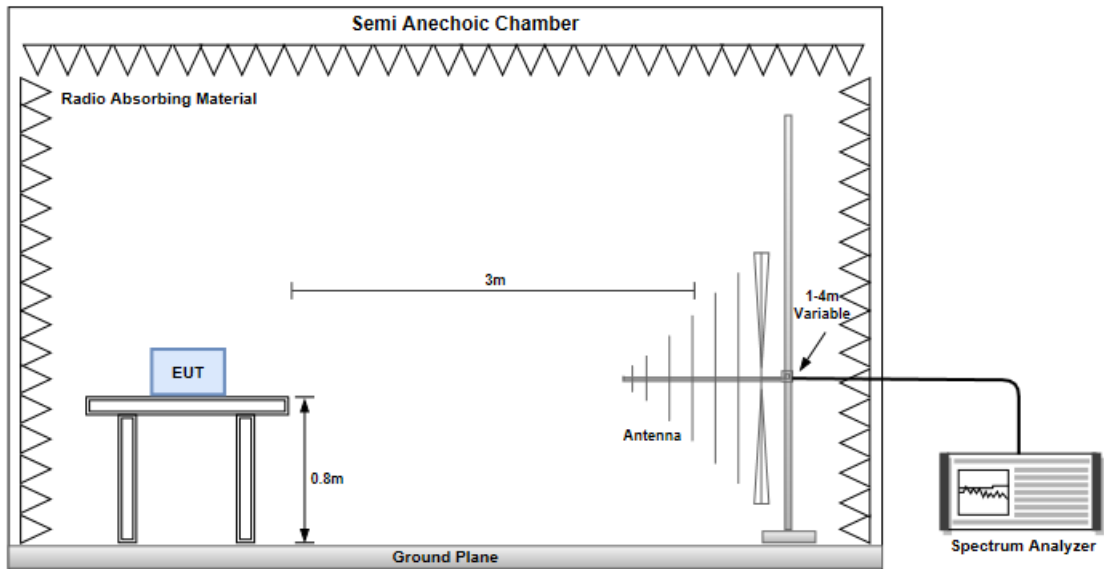

Radiated Emissions above 1 GHz

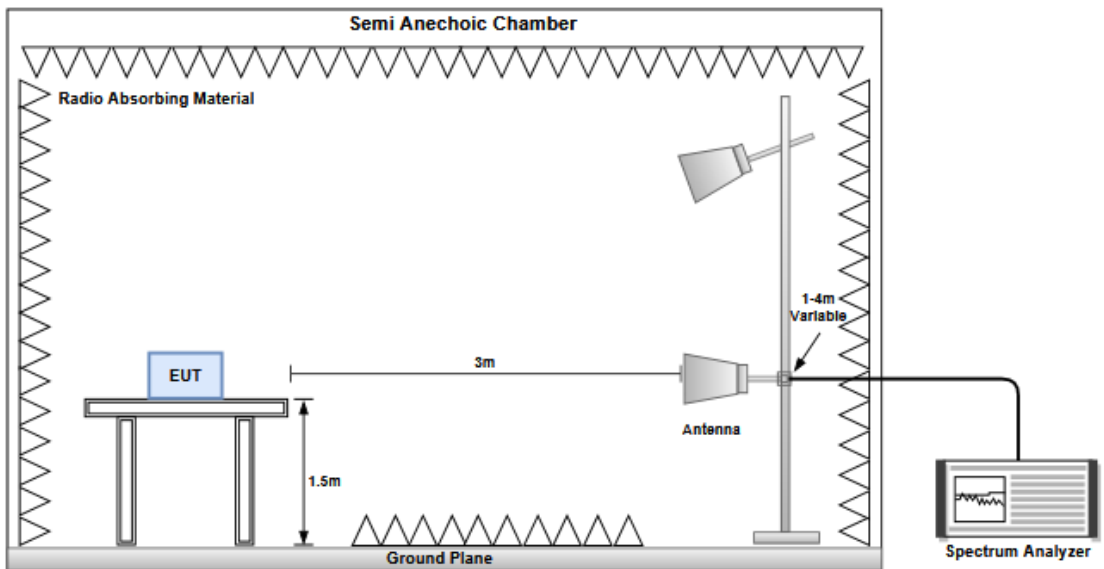

3.4.4 Transmitter Radiated Unwanted Emissions (Below 1GHz)

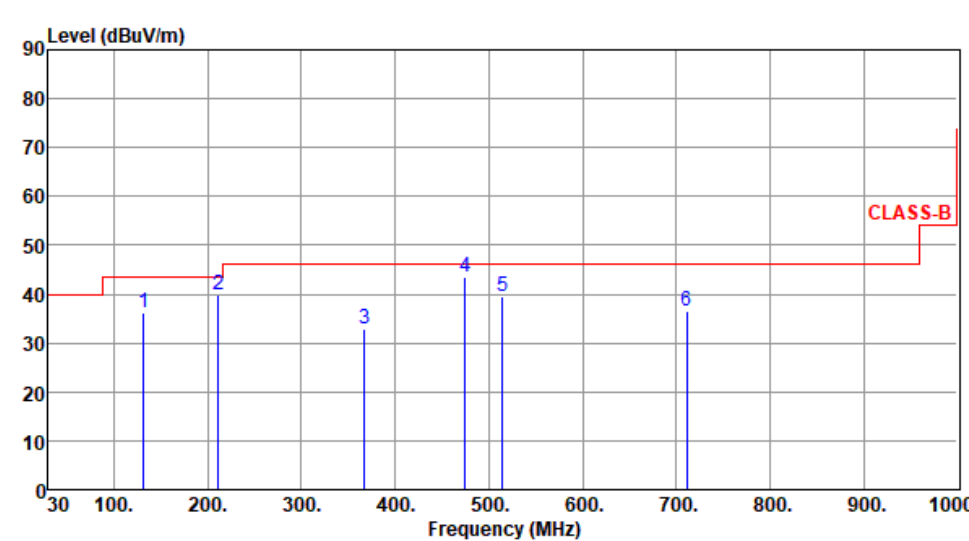
Modulation	BT LE-1Mbps	Test Freq. (MHz)	2480																																																																				
Polarization	Horizontal																																																																						
Test By : Akun Chung Temperature(°C):22 Humidity(%):65																																																																							
																																																																							
	<table border="1"> <thead> <tr> <th></th> <th>Freq. MHz</th> <th>Emission level dBuV/m</th> <th>Limit dBuV/m</th> <th>Margin dB</th> <th>SA reading dBuV</th> <th>Factor dB/m</th> <th>Remark</th> <th>ANT High cm</th> <th>Turn Table deg</th> </tr> </thead> <tbody> <tr> <td>1</td> <td>131.55</td> <td>36.18</td> <td>43.50</td> <td>-7.32</td> <td>45.84</td> <td>-9.66</td> <td>Peak</td> <td>---</td> <td>---</td> </tr> <tr> <td>2</td> <td>211.25</td> <td>39.95</td> <td>43.50</td> <td>-3.55</td> <td>51.65</td> <td>-11.70</td> <td>QP</td> <td>105</td> <td>252</td> </tr> <tr> <td>3</td> <td>367.54</td> <td>32.87</td> <td>46.00</td> <td>-13.13</td> <td>39.30</td> <td>-6.43</td> <td>Peak</td> <td>---</td> <td>---</td> </tr> <tr> <td>4</td> <td>474.75</td> <td>43.55</td> <td>46.00</td> <td>-2.45</td> <td>46.70</td> <td>-3.15</td> <td>QP</td> <td>180</td> <td>198</td> </tr> <tr> <td>5</td> <td>514.25</td> <td>39.56</td> <td>46.00</td> <td>-6.44</td> <td>41.86</td> <td>-2.30</td> <td>Peak</td> <td>---</td> <td>---</td> </tr> <tr> <td>6</td> <td>711.52</td> <td>36.45</td> <td>46.00</td> <td>-9.55</td> <td>34.80</td> <td>1.65</td> <td>Peak</td> <td>---</td> <td>---</td> </tr> </tbody> </table>		Freq. MHz	Emission level dBuV/m	Limit dBuV/m	Margin dB	SA reading dBuV	Factor dB/m	Remark	ANT High cm	Turn Table deg	1	131.55	36.18	43.50	-7.32	45.84	-9.66	Peak	---	---	2	211.25	39.95	43.50	-3.55	51.65	-11.70	QP	105	252	3	367.54	32.87	46.00	-13.13	39.30	-6.43	Peak	---	---	4	474.75	43.55	46.00	-2.45	46.70	-3.15	QP	180	198	5	514.25	39.56	46.00	-6.44	41.86	-2.30	Peak	---	---	6	711.52	36.45	46.00	-9.55	34.80	1.65	Peak	---	---
	Freq. MHz	Emission level dBuV/m	Limit dBuV/m	Margin dB	SA reading dBuV	Factor dB/m	Remark	ANT High cm	Turn Table deg																																																														
1	131.55	36.18	43.50	-7.32	45.84	-9.66	Peak	---	---																																																														
2	211.25	39.95	43.50	-3.55	51.65	-11.70	QP	105	252																																																														
3	367.54	32.87	46.00	-13.13	39.30	-6.43	Peak	---	---																																																														
4	474.75	43.55	46.00	-2.45	46.70	-3.15	QP	180	198																																																														
5	514.25	39.56	46.00	-6.44	41.86	-2.30	Peak	---	---																																																														
6	711.52	36.45	46.00	-9.55	34.80	1.65	Peak	---	---																																																														
Note 1: Emission Level (dBuV/m) = SA Reading (dBuV) + Factor* (dB/m) *Factor includes antenna factor , cable loss and amplifier gain Note 2: Margin (dB) = Emission level (dBuV/m) – Limit (dBuV/m). Note 3: All spurious emissions below 30MHz are more than 20 dB below the limit.																																																																							

Modulation	BT LE-1Mbps	Test Freq. (MHz)	2480
Polarization	Vertical		

Test By : Akun Chung Temperature(°C): 22 Humidity(%): 65

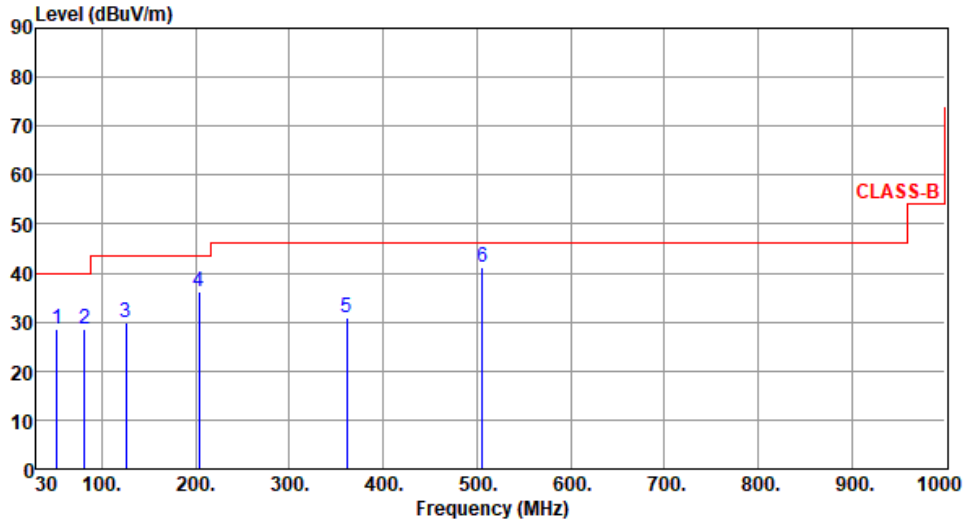

	Freq. MHz	Emission level dBUV/m	Limit dBUV/m	Margin dB	SA reading dBUV	Factor dB/m	Remark	ANT High cm	Turn Table deg
1	51.95	28.56	40.00	-11.44	37.63	-9.07	Peak	---	---
2	81.77	28.54	40.00	-11.46	42.25	-13.71	Peak	---	---
3	125.66	29.75	43.50	-13.75	40.05	-10.30	Peak	---	---
4	203.54	36.14	43.50	-7.36	47.87	-11.73	Peak	---	---
5	360.88	30.73	46.00	-15.27	37.36	-6.63	Peak	---	---
6	505.55	41.18	46.00	-4.82	43.69	-2.51	QP	101	323

Note 1: Emission Level (dBUV/m) = SA Reading (dBUV) + Factor* (dB/m)

*Factor includes antenna factor , cable loss and amplifier gain

Note 2: Margin (dB) = Emission level (dBUV/m) – Limit (dBUV/m).

Note 3: All spurious emissions below 30MHz are more than 20 dB below the limit.

3.4.5 Transmitter Radiated Unwanted Emissions (Above 1GHz)

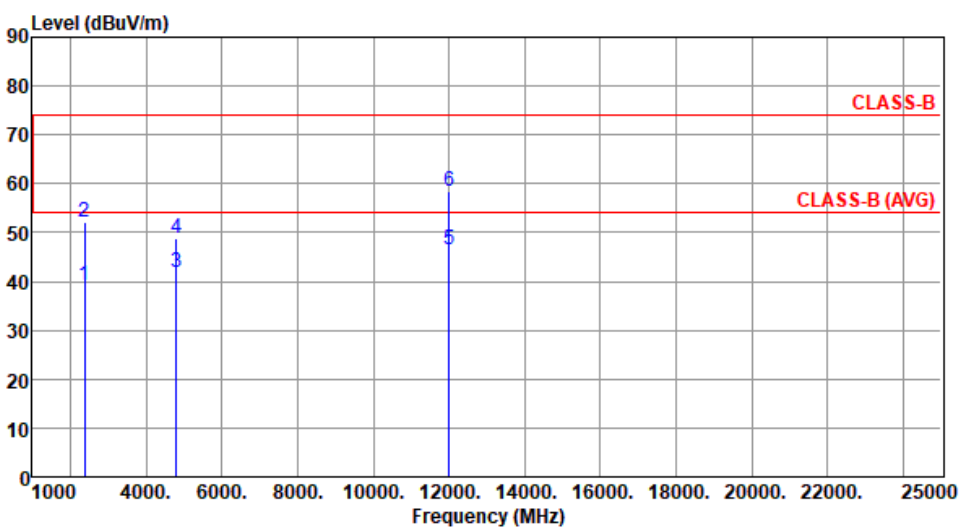
Modulation	BT LE-1Mbps	Test Freq. (MHz)	2402						
Polarization	Horizontal								
Test By : Akun Chung Temperature(°C): 23 Humidity(%): 63									
									
	Freq.	Emission level	Limit	Margin	SA reading	Factor	Remark	ANT High	Turn Table
	MHz	dBuV/m	dBuV/m	dB	dBuV	dB/m		cm	deg
1	2390.00	39.23	54.00	-14.77	40.72	-1.49	Average	160	155
2	2390.00	52.13	74.00	-21.87	53.62	-1.49	Peak	160	155
3	4804.00	41.88	54.00	-12.12	36.68	5.20	Average	108	140
4	4804.00	48.93	74.00	-25.07	43.73	5.20	Peak	108	140
5	12010.00	46.58	54.00	-7.42	31.84	14.74	Average	100	140
6	12010.00	58.51	74.00	-15.49	43.77	14.74	Peak	100	140

Note 1: Emission Level (dBuV/m) = SA Reading (dBuV) + Factor* (dB/m)
 *Factor includes antenna factor , cable loss and amplifier gain
 Note 2: Margin (dB) = Emission level (dBuV/m) – Limit (dBuV/m).

Modulation	BT LE-1Mbps	Test Freq. (MHz)	2402
Polarization	Vertical		

Test By :Akun Chung Temperature(°C):23 Humidity(%):63

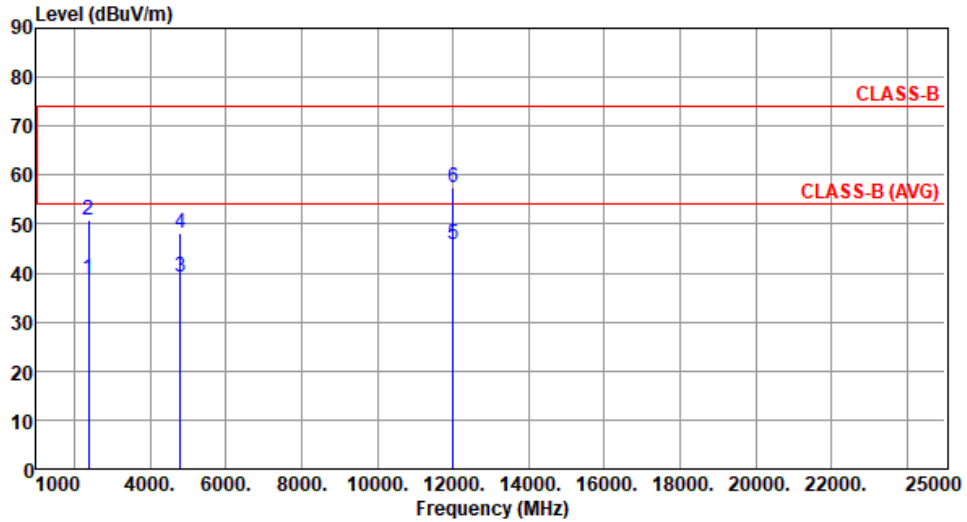

	Freq. MHz	Emission level dBuV/m	Limit dBuV/m	Margin dB	SA reading dBuV	Factor dB/m	Remark	ANT High cm	Turn Table deg
1	2390.00	38.75	54.00	-15.25	40.24	-1.49	Average	207	101
2	2390.00	50.82	74.00	-23.18	52.31	-1.49	Peak	207	101
3	4804.00	39.04	54.00	-14.96	33.84	5.20	Average	250	91
4	4804.00	48.24	74.00	-25.76	43.04	5.20	Peak	250	91
5	12010.00	45.79	54.00	-8.21	31.05	14.74	Average	100	102
6	12010.00	57.30	74.00	-16.70	42.56	14.74	Peak	100	102

Note 1: Emission Level (dBuV/m) = SA Reading (dBuV) + Factor* (dB/m)

*Factor includes antenna factor , cable loss and amplifier gain

Note 2: Margin (dB) = Emission level (dBuV/m) – Limit (dBuV/m).

Modulation	BT LE-1Mbps	Test Freq. (MHz)	2440
Polarization	Horizontal		

Test By :Akun Chung Temperature(°C):23 Humidity(%):63

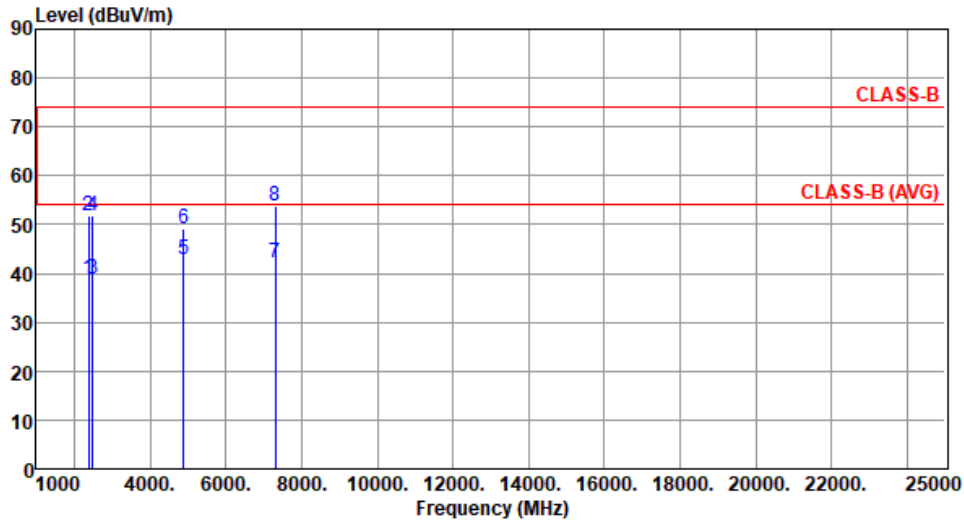

	Freq. MHz	Emission level dBuV/m	Limit dBuV/m	Margin dB	SA reading dBuV	Factor dB/m	Remark	ANT High cm	Turn Table deg
1	2390.00	38.79	54.00	-15.21	40.28	-1.49	Average	151	148
2	2390.00	51.84	74.00	-22.16	53.33	-1.49	Peak	151	148
3	2483.50	38.81	54.00	-15.19	40.39	-1.58	Average	151	148
4	2483.50	51.91	74.00	-22.09	53.49	-1.58	Peak	151	148
5	4880.00	42.86	54.00	-11.14	37.54	5.32	Average	101	136
6	4880.00	49.12	74.00	-24.88	43.80	5.32	Peak	101	136
7	7320.00	42.24	54.00	-11.76	31.41	10.83	Average	100	155
8	7320.00	53.91	74.00	-20.09	43.08	10.83	Peak	100	155

Note 1: Emission Level (dBuV/m) = SA Reading (dBuV) + Factor* (dB/m)

*Factor includes antenna factor , cable loss and amplifier gain

Note 2: Margin (dB) = Emission level (dBuV/m) – Limit (dBuV/m).

Modulation	BT LE-1Mbps	Test Freq. (MHz)	2440
Polarization	Vertical		

Test By : Akun Chung Temperature(°C): 23 Humidity(%): 63

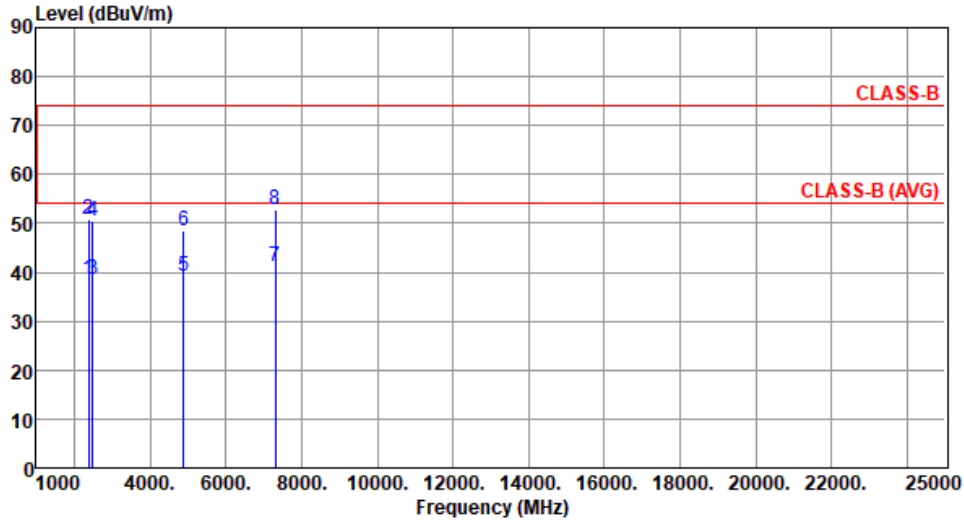

	Freq. MHz	Emission level dBuV/m	Limit dBuV/m	Margin dB	SA reading dBuV	Factor dB/m	Remark	ANT High cm	Turn Table deg
1	2390.00	38.61	54.00	-15.39	40.10	-1.49	Average	199	101
2	2390.00	50.66	74.00	-23.34	52.15	-1.49	Peak	199	101
3	2483.50	38.69	54.00	-15.31	40.27	-1.58	Average	199	101
4	2483.50	50.63	74.00	-23.37	52.21	-1.58	Peak	199	101
5	4880.00	39.24	54.00	-14.76	33.92	5.32	Average	244	89
6	4880.00	48.46	74.00	-25.54	43.14	5.32	Peak	244	89
7	7320.00	41.34	54.00	-12.66	30.51	10.83	Average	100	105
8	7320.00	52.80	74.00	-21.20	41.97	10.83	Peak	100	105

Note 1: Emission Level (dBuV/m) = SA Reading (dBuV) + Factor* (dB/m)

*Factor includes antenna factor , cable loss and amplifier gain

Note 2: Margin (dB) = Emission level (dBuV/m) – Limit (dBuV/m).

Modulation	BT LE-1Mbps	Test Freq. (MHz)	2480
Polarization	Horizontal		

Test By :Akun Chung Temperature(°C):23 Humidity(%):63

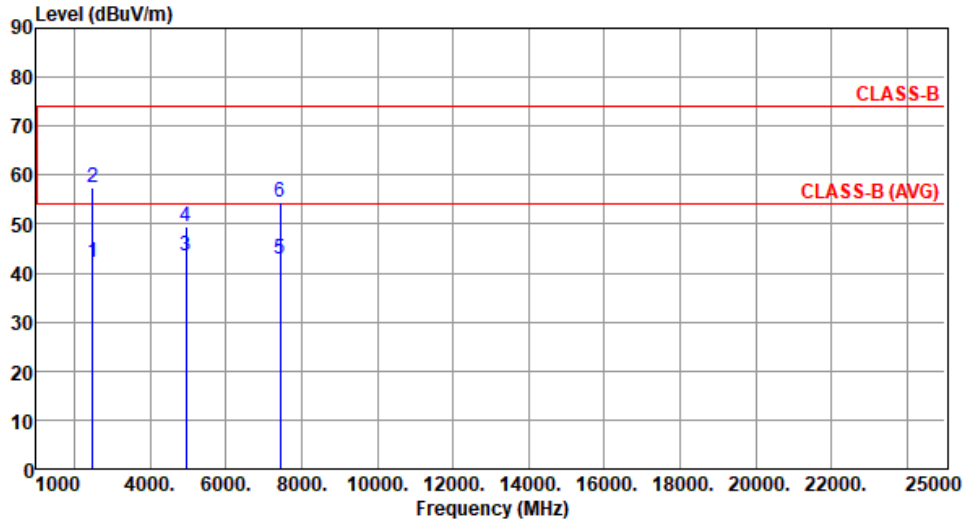

	Freq. MHz	Emission level dBuV/m	Limit dBuV/m	Margin dB	SA reading dBuV	Factor dB/m	Remark	ANT High cm	Turn Table deg
1	2483.50	42.27	54.00	-11.73	43.85	-1.58	Average	155	153
2	2483.50	57.31	74.00	-16.69	58.89	-1.58	Peak	155	153
3	4960.00	43.66	54.00	-10.34	37.95	5.71	Average	105	149
4	4960.00	49.53	74.00	-24.47	43.82	5.71	Peak	105	149
5	7440.00	42.70	54.00	-11.30	32.05	10.65	Average	100	147
6	7440.00	54.46	74.00	-19.54	43.81	10.65	Peak	100	147

Note 1: Emission Level (dBuV/m) = SA Reading (dBuV) + Factor* (dB/m)

*Factor includes antenna factor , cable loss and amplifier gain

Note 2: Margin (dB) = Emission level (dBuV/m) – Limit (dBuV/m).

Modulation	BT LE-1Mbps	Test Freq. (MHz)	2480
Polarization	Vertical		

Test By :Akun Chung Temperature(°C):23 Humidity(%):63

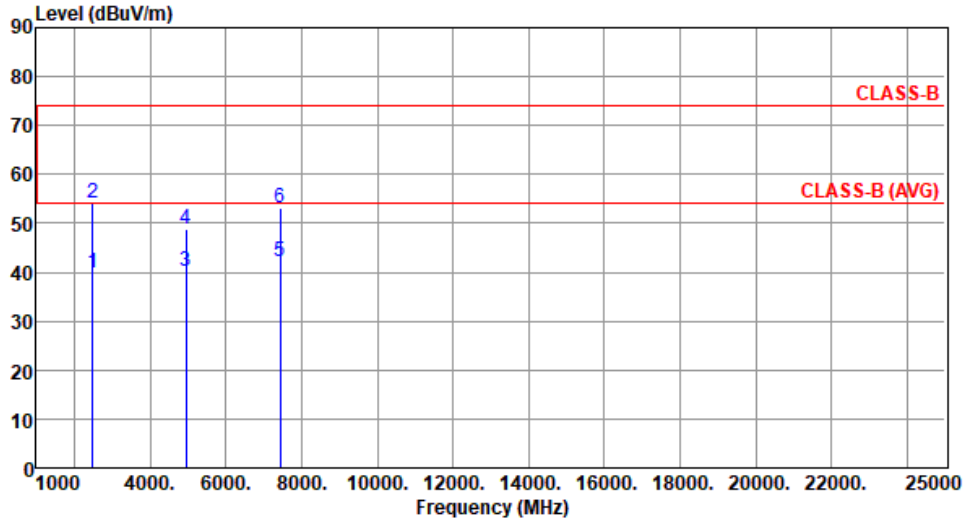

	Freq. MHz	Emission level dBuV/m	Limit dBuV/m	Margin dB	SA reading dBuV	Factor dB/m	Remark	ANT High cm	Turn Table deg
1	2483.50	39.87	54.00	-14.13	41.45	-1.58	Average	205	102
2	2483.50	54.20	74.00	-19.80	55.78	-1.58	Peak	205	102
3	4960.00	40.07	54.00	-13.93	34.36	5.71	Average	239	102
4	4960.00	48.88	74.00	-25.12	43.17	5.71	Peak	239	102
5	7440.00	42.18	54.00	-11.82	31.53	10.65	Average	100	99
6	7440.00	53.07	74.00	-20.93	42.42	10.65	Peak	100	99

Note 1: Emission Level (dBuV/m) = SA Reading (dBuV) + Factor* (dB/m)

*Factor includes antenna factor , cable loss and amplifier gain

Note 2: Margin (dB) = Emission level (dBuV/m) – Limit (dBuV/m).

3.5 Emissions in non-restricted Frequency Bands

3.5.1 Emissions in non-restricted frequency bands limit

Peak power in any 100 kHz bandwidth outside of the authorized frequency band shall be attenuated by at least 20 dB relative to the maximum in-band peak PSD level in 100 kHz.

3.5.2 Test Procedures

Reference level measurement

1. Set RBW=100kHz, VBW = 300kHz , Detector = Peak, Sweep time = Auto
2. Trace = max hold , Allow Trace to fully stabilize
3. Use the peak marker function to determine the maximum PSD level

Emission level measurement

1. Set RBW=100kHz, VBW = 300kHz , Detector = Peak, Sweep time = Auto
2. Trace = max hold , Allow Trace to fully stabilize
3. Scan Frequency range is up to 25GHz
4. Use the peak marker function to determine the maximum amplitude level

3.5.3 Test Setup

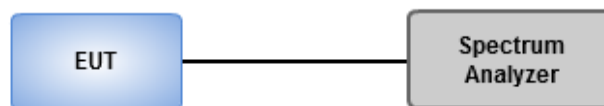

3.5.4 Test Result of Emissions in non-restricted Frequency Bands

Ambient Condition	22°C / 68%	Tested By	Aska Huang
--------------------------	------------	------------------	------------

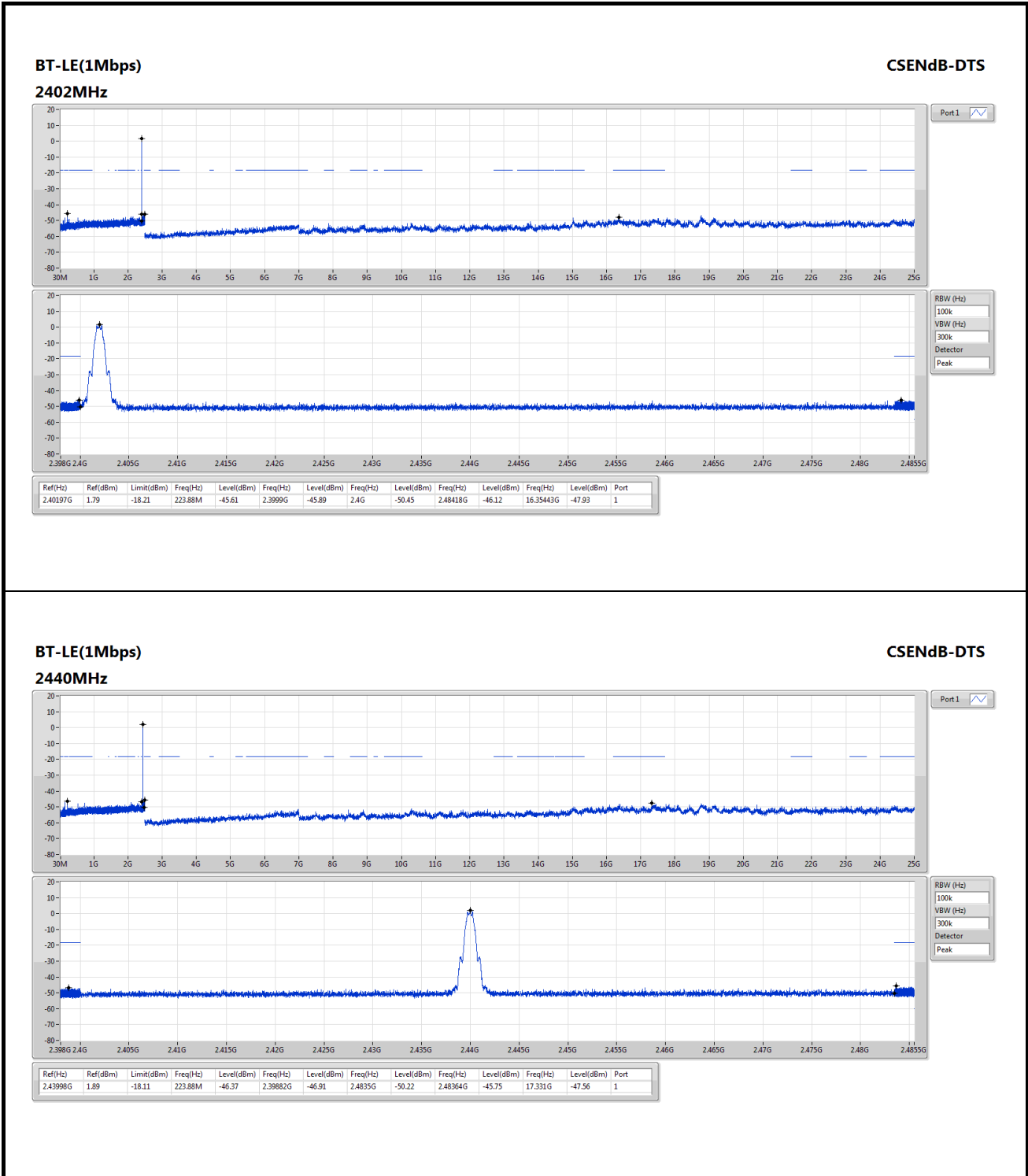

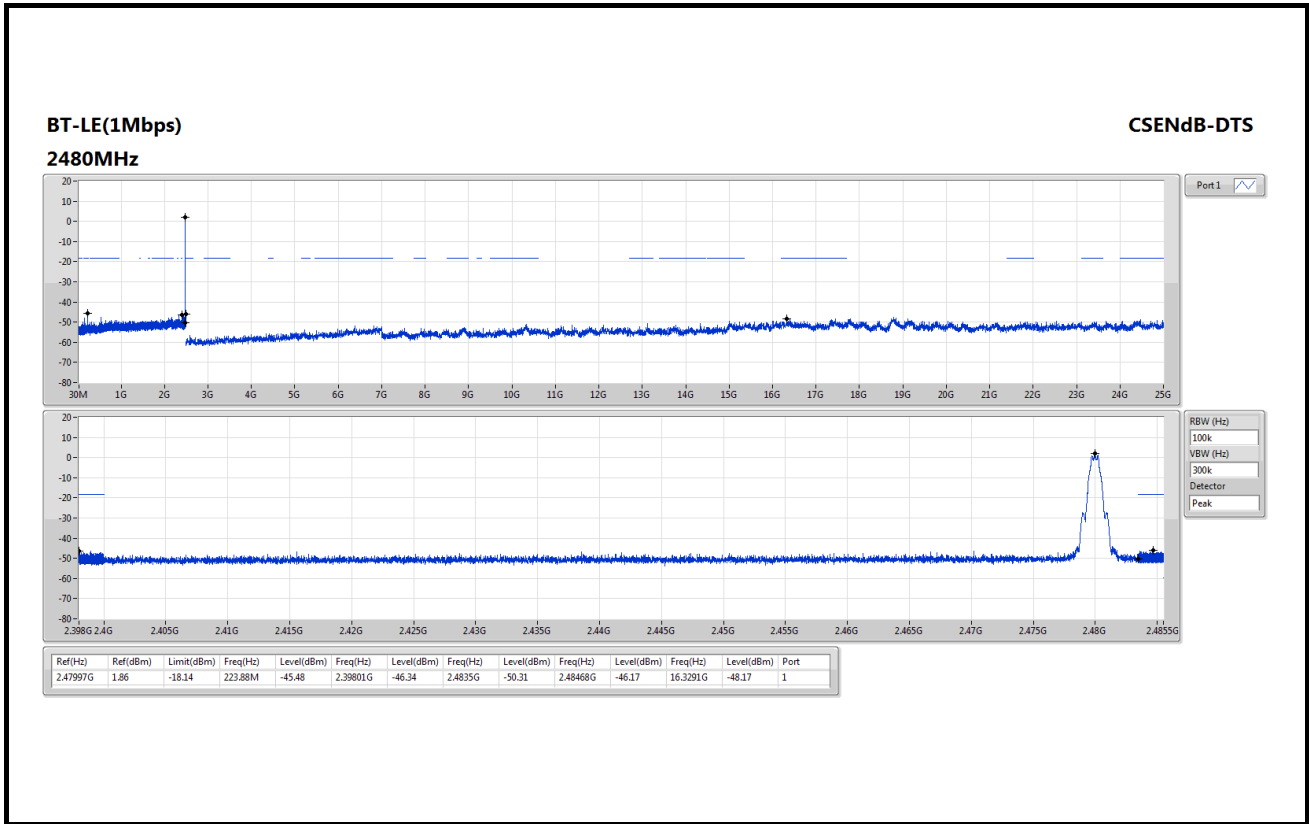

4 Test laboratory information

Established in 2012, ICC provides foremost EMC & RF Testing and advisory consultation services by our skilled engineers and technicians. Our services employ a wide variety of advanced edge test equipment and one of the widest certification extents in the business.

International Certification Corporation (EMC and Wireless Communication Laboratory), it is our definitive objective is to institute long term, trust-based associations with our clients. The expectation we set up with our clients is based on outstanding service, practical expertise and devotion to a certified value structure. Our passion is to grant our clients with best EMC / RF services by oriented knowledgeable and accommodating staff.

Our Test sites are located at Linkou District and Kwei Shan District. Location map can be found on our website <http://www.icertifi.com.tw>.

Linkou

Tel: 886-2-2601-1640

No.30-2, Ding Fwu Tsuen, Lin Kou
District, New Taipei City, Taiwan
(R.O.C.)

Kwei Shan

Tel: 886-3-271-8666

No.3-1, Lane 6, Wen San 3rd
St., Kwei Shan Dist., Tao Yuan
City 33381, Taiwan (R.O.C.)
No.2-1, Lane 6, Wen San 3rd
St., Kwei Shan Dist., Tao Yuan
City 33381, Taiwan (R.O.C.)

Kwei Shan Site II

Tel: 886-3-271-8640

No.14-1, Lane 19, Wen San 3rd
St., Kwei Shan Dist., Tao Yuan
City 333, Taiwan (R.O.C.)

If you have any suggestion, please feel free to contact us as below information.

Tel: 886-3-271-8666

Fax: 886-3-318-0155

Email: ICC_Service@icertifi.com.tw

==END==