



# GV600MA User Manual

## GPS Tracker

QSZTRACGV600UM0101

Version: 1.01

*International Telematics Solutions Innovator*

[www.queclink.com](http://www.queclink.com)

<b>Document Title</b>	GV600MA User Manual
<b>Version</b>	1.01
<b>Date</b>	Dec , 2018
<b>Status</b>	Released
<b>Document Control ID</b>	QSZTRACGV600UM0101

### **General Notes**

Queclink offers this information as a service to its customers, to support application and engineering efforts that use the products designed by Queclink. The information provided is based upon requirements specifically provided to Queclink by the customers. Queclink has not undertaken any independent search for additional relevant information, including any information that may be in the customer's possession. Furthermore, system validation of this product designed by Queclink within a larger electronic system remains the responsibility of the customer or the customer's system integrator. All specifications supplied herein are subject to change.

### **Copyright**

This document contains proprietary technical information which is the property of Queclink. Copying of this document, distribution to others or using or communication of the contents thereof is forbidden without express authority. Offenders are liable to the payment of damages. All rights are reserved in the event of a patent grant or registration of a utility model or design. All specifications supplied herein are subject to change without notice at any time.

***Copyright © Queclink Wireless Solutions Co., Ltd. 2018***

## Contents

0. Revision History .....	2
1. Introduction .....	3
1.1. Reference.....	3
1.2. Terms and Abbreviations .....	3
2. Product Overview .....	4
2.1. GV600MA Products .....	4
2.2. Parts List .....	4
2.3. Interface Definition .....	4
2.4. GV600MA Standard Cable Color .....	5
3. Getting Started .....	6
3.1. Open and Close the Case.....	6
3.2. Install a SIM Card.....	7
3.3. Install the Internal Backup Battery .....	7
3.4. Power Supply Connection .....	8
3.5. Ignition Detection.....	8
3.6. Digital Inputs .....	9
3.7. Analogue Inputs .....	10
3.8. Digital Outputs.....	10
3.9. Device Status and LED .....	12
3.10. Temperature Sensor Interface.....	13
3.11. Serial Port/UART Interface .....	14
4. Support Peripheral list.....	15
4.1. Bluetooth .....	15
5. GV600MA Certification .....	15
5.1. FCC Certification .....	15

## Table Index

Table 1. GV600MA Protocol Reference .....	3
Table 2. Terms and Abbreviations .....	3
Table 3. Product Model .....	4
Table 4. Parts List.....	4
Table 5. Description of 18-pin Connections .....	4
Table 6. GV600MA Standard Cable Color Definition .....	5
Table 7. Electrical Characteristics of Ignition Detection .....	8
Table 8. Electrical Characteristics of the Digital Inputs .....	9
Table 9. Electrical Characteristics of Digital Outputs .....	10
Table 10. Definition of Device Status and LED.....	12

## Figure Index

Figure 1. The 18-pin Connector on the GV600MA.....	4
Figure 2. Open the Case .....	6
Figure 3. SIM Card Installation .....	7
Figure 4. Backup Battery Installation .....	7
Figure 5. External Power Supply Connection .....	8
Figure 6. Typical Ignition Detection.....	8
Figure 7. Typical Digital Input Connection .....	9
Figure 8. Typical Analogue Input Connection .....	10
Figure 9. Digital Output Internal Drive Circuit.....	10
Figure 10. Typical Connection with a Relay.....	11
Figure 11. Typical Connection with a LED .....	11
Figure 12. Typical Connection with a Buzzer.....	11
Figure 13. Typical Connection with Other Devices.....	12
Figure 14. GV600MA LEDs on the Case.....	13
Figure 15. Typical Connection with a Temperature Sensor.....	13
Figure 16. Typical Connection with USB to TTL Serial Port .....	14

## 0. Revision History

Version	Date	Author	Description of Change
1.01	Dec,2018	Arry Wang	Initial

## 1. Introduction

The GV600MA compact waterproof GPS trackers designed for a wide variety of vehicle tracking applications. They have multiple I/O interfaces that can be used for monitoring or controlling external devices, including a 1-wire interface used for temperature monitoring. Bluetooth 4.0 is supported. Virtual ignition detection and i-Button function are both supported by GV600MA. Their built-in GPS receiver has superior sensitivity and fast initial positioning. Different models allow the GV600MA' location to be monitored in real time or periodically tracked by a backend server and mobile devices. System integration is straightforward as complete documentation is provided for the full featured @Track protocol. The @Track protocol supports a wide variety of reports such as emergency, geo-fence boundary crossings, and external power supply monitoring and scheduled GPS position reports. It built in BLE 4.0 communication unit as a Bluetooth device for more devices to interactively communicate and control.

### 1.1. Reference

Table 1. GV600MA Protocol Reference

SN	Document Name	Remark
[1]	GV600M Series @Track Air Interface Protocol	The air protocol interface between GV600M Series and backend server.

### 1.2. Terms and Abbreviations

Table 2. Terms and Abbreviations

Abbreviation	Description
AGND	Analogue Ground
AIN	Analogue Input
DIN	Digital Input
DOUT	Digital Output
GND	Ground
RXD	Receive Data
TXD	Transmit Data

## 2. Product Overview

### 2.1. GV600MA Products

Table 3. Product Model

Model No.	Region	Technology	Operating Band (MHz)
GV600MA	North America	LTE	LTE: B2/B4/B12/B13/B5

### 2.2. Parts List

Table 4. Parts List

Name	Description
GV600MA Locator	135*62*38 mm
User Cable	GV600MA standard cable
USB Configure Cable	USB to TTL serial port
Power & GND Cable	GV600MA Power &GND Cable
Temperature Sensor	GV600MA Temperature Sensor
Fuel Level Sensor	RS232 DUT-E

### 2.3. Interface Definition

The GV600MA Tracker has an 18-pin interface connector which contains the connections for power, I/O, TTL, etc. The sequence and definition of the 18-pin connector are shown in the following figure:

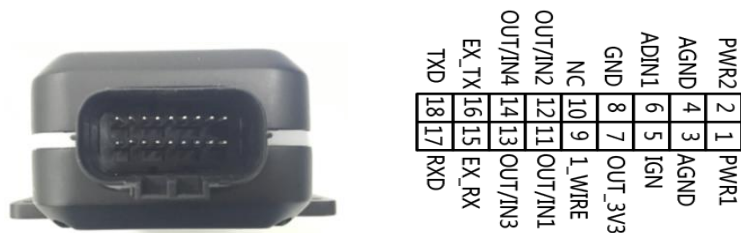

Figure 1. The 18-pin Connector on the GV600MA

Table 5. Description of 18-pin Connections

Index	Description	Comment
1	PWR1	Primary Power 8-32V
2	PWR2	Secondary Power 8-32V
3	AGND	Primary Analogue Ground
4	AGND	Secondary Analogue Ground
5	IGN	Ignition Detection Input, Positive Trigger
6	ADIN1	Analogue Input 0-32V
7	OUT_3V3	External Accessory Power 250mA Max



8	GND	External Accessory Ground
9	1_WIRE	Temperature Sensor Input
10	NC	NC
11	OUT/IN1	Negative trigger input1 for normal use or Open drain output1 150mA max drive current
12	OUT/IN2	Negative trigger input2 for normal use or Open drain output2 150mA max drive current
13	OUT/IN3	Negative trigger input3 for normal use or Open drain output3 150mA max drive current
14	OUT/IN4	Negative trigger input4 for normal use or Open drain output4 150mA max drive current
15	EX_RX	UART RXD RS232
16	EX_TX	UART TXD RS232
17	RXD	UART RXD TTL
18	TXD	UART TXD TTL

## 2.4. GV600MA Standard Cable Color

Table 6. GV600MA Standard Cable Color Definition

Definition	Color	Pin No.	Connector	Pin No.	Color	Definition
PWR1	Red	1		2	Red/Green	RWR2
AGNG	Black	3		4	Black	AGNG
IGN	White	5		6	Green	ADIN1
OUT-3V3	Red/White	7		8	Black/White	GND
1-WIRE	Gray	9		10	NC	NC
OUT/IN1	Blue	11		12	Yellow	OUT/IN2
OUT/IN3	Brown	13		14	Orange	OUT/IN4
EX_RX	Purple	15		16	Purple/White	EX_TX
RXD	Pink	17		18	White/Black	TXD

### Note:

The main color of the dual color cable is the first color, for example, Black/White means black is the main color, and white is the secondary color.

### 3. Getting Started

#### 3.1. Open and Close the Case

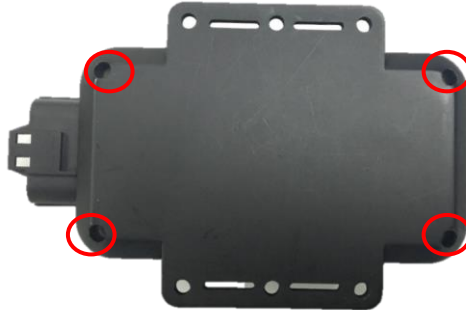

##### Open the Case

To open: Use a cross screwdriver to loosen the four screws and then lift the top case gently.

To close: Align the top case with the bottom case and then tighten the four screws.

##### Note:

Pay attention to the following details to close the case. Otherwise, the waterproof capability of the device may be deteriorated.

1. The positioning poles (total 11) on the top cover must be inserted into the holes of the rubber ring as shown below.

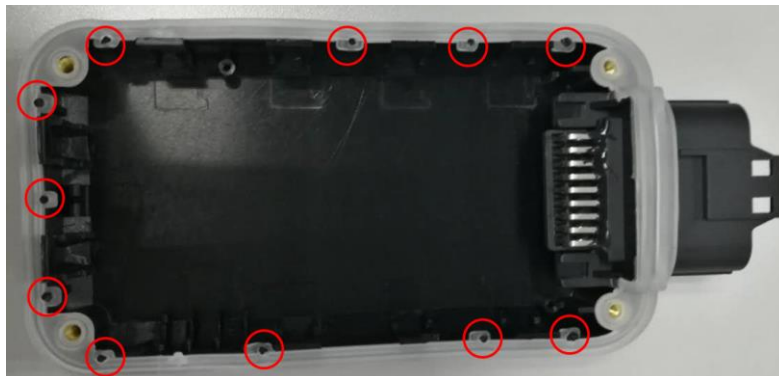

2. Tighten the screws sufficiently until the rubber ring is squeezed out as shown in the following figure 1.

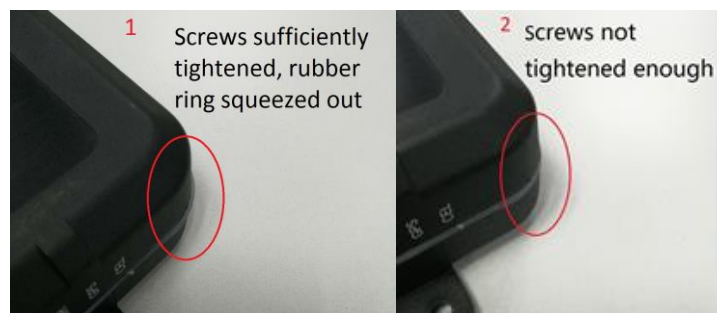

### 3.2. Install a SIM Card

Open the case and ensure the unit is powered off (unplug the 18-pin cable and switch the internal battery to the OFF position). Insert the SIM card into the holder. Take care to align the cut mark and ensure the SIM card is pushed into the SIM holder completely. Close the case.



Figure 2. SIM Card Installation

### 3.3. Install the Internal Backup Battery

GV600MA has an internal backup Li-ion battery (5200mAH).

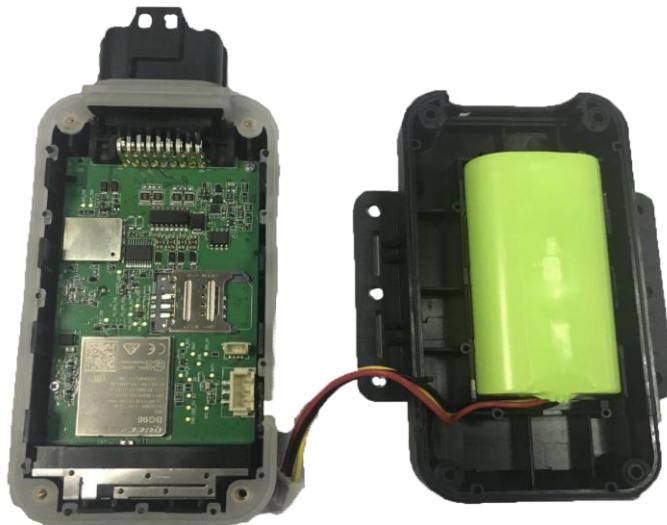

Figure 3. Backup Battery Installation

### 3.4. Power Supply Connection

PWR (pin 1 or pin 2)/GND (pin 3 or pin 4) are the power input pins. The input voltage range is from 8V to 32V. The device is designed to be installed in vehicles that operate on 12V or 24V systems without the need of external transformers.

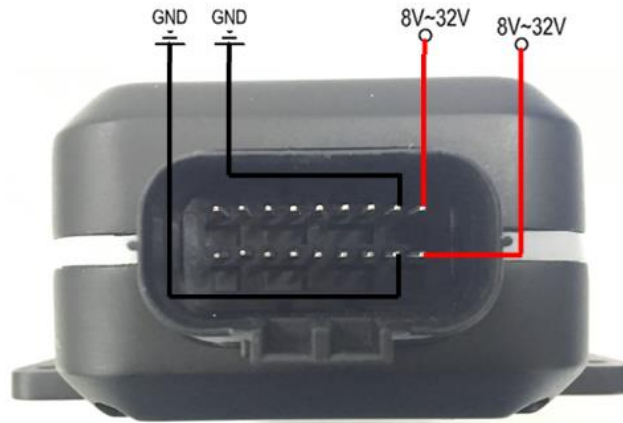

Figure 4. External Power Supply Connection

### 3.5. Ignition Detection

Table 7. Electrical Characteristics of Ignition Detection

Logical Status	Electrical Characteristics
Active	5.0V to 32V
Inactive	0V to 3V or open loop

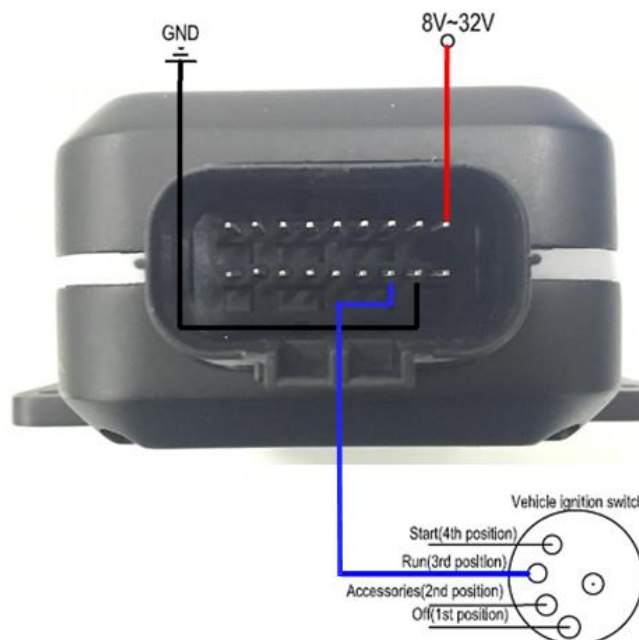

Figure 5. Typical Ignition Detection

IGN (pin 5) is used for ignition detection. It is recommended to connect this pin to the “RUN”

position of the vehicle ignition switch as shown above.

An alternative to connect to the ignition switch is to find a non-permanent power source that is only available when the vehicle is running, for example, the power source for the FM radio.

IGN signal can be configured to transmit information to the backend server when ignition is on and enter the power saving mode when ignition is off.

### 3.6. Digital Inputs

There are four general purpose digital inputs on GV600. They all are negative triggers.

Table 8. Electrical Characteristics of the Digital Inputs

Logical Status	Electrical Characteristics
Active	0V to 0.8V
Inactive	Open loop

The following picture shows the recommended connection of a digital input.

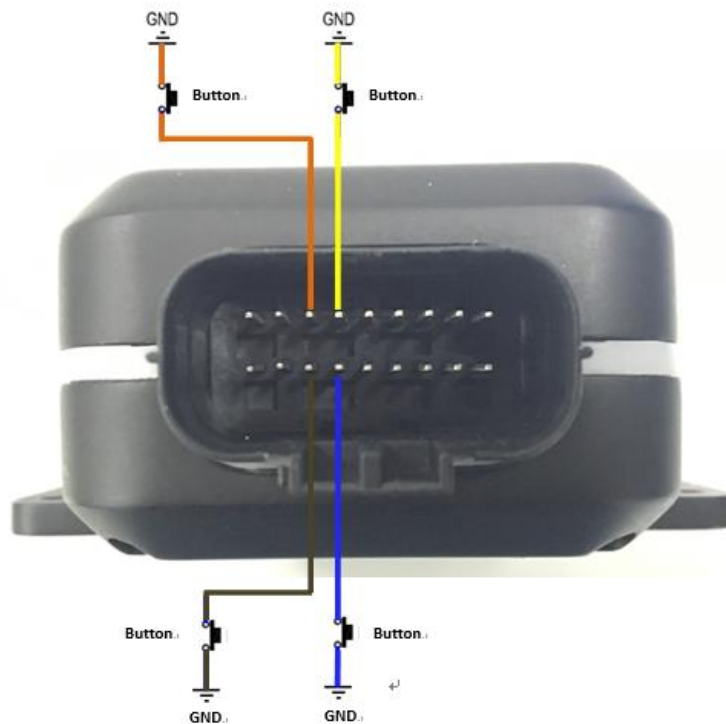

Figure 6. Typical Digital Input Connection

### 3.7. Analogue Inputs

There is one analogue input on GV600MA, and the analogue input voltage range is from 0 to 32V. The following picture shows the recommended connection.

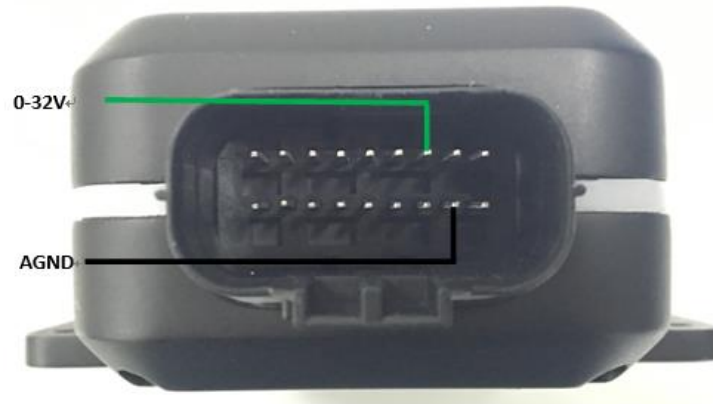

Figure 7. Typical Analogue Input Connection

**Note:**

Pin 6 is a multifunction pin: it can be configured as an analogue input.

### 3.8. Digital Outputs

There are four digital outputs on GV600MA. All are of open drain type and the maximum drain current is 150 mA. Each output has a built-in over current PTC resettable fuse.

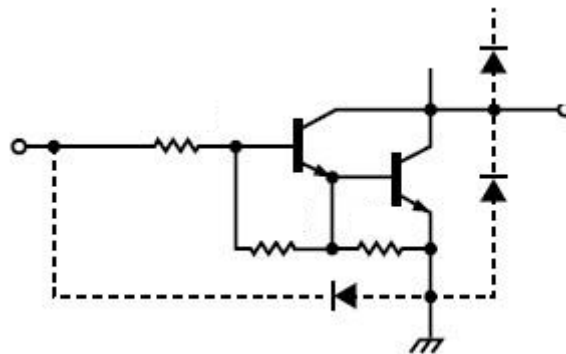

Figure 8. Digital Output Internal Drive Circuit

Table 9. Electrical Characteristics of Digital Outputs

Logical Status	Electrical Characteristics
Enable	<1.5V @150 mA
Disable	Open drain

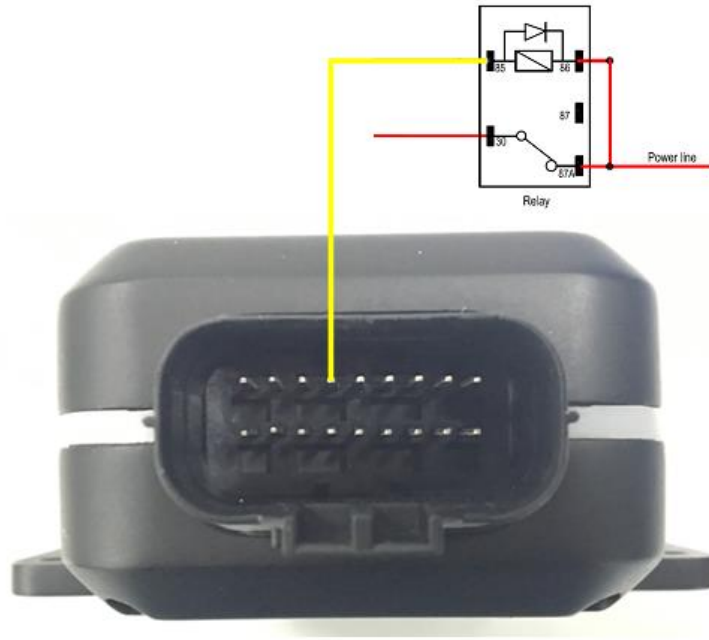

Figure 9. Typical Connection with a Relay



Figure 10. Typical Connection with a LED

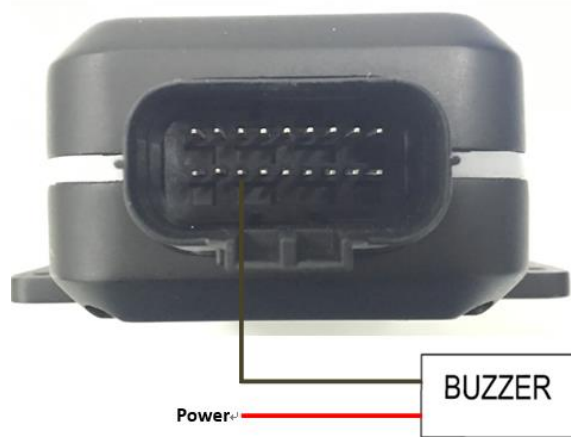

Figure 11. Typical Connection with a Buzzer

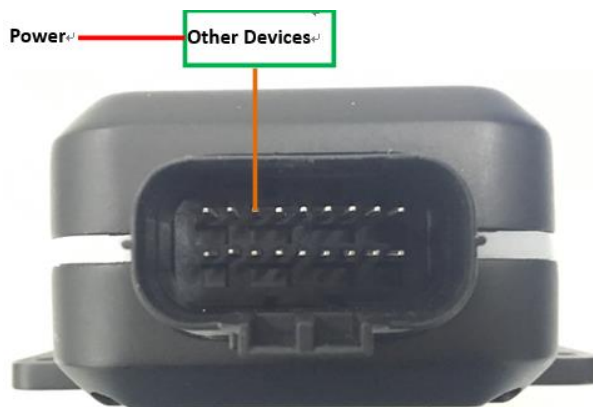

Figure 12. Typical Connection with Other Devices

**Note:**

1. OUT1 will latch the output state during reset.
2. Pay attention to the polarity of the relay if it is pre-installed with an internal flyback diode during connection. Install an additional diode externally if there is no pre-installed internal diode. A common diode such as a 1N4004 one will work in most circumstances.

**3.9. Device Status and LED**

Table 10. Definition of Device Status and LED

LED	Device Status	LED Status
CELL (Note 1)	Device is searching CELL network.	Fast flashing (Note 3)
	Device has registered to CELL network.	Slow flashing(Note 4)
	Device goes into sleep mode.	OFF
	SIM card needs pin code to unlock.	ON
GPS (Note 2)	GPS chip is powered off.	OFF
	GPS sends no data or data format error occurs.	Slow flashing
	GPS chip is searching GPS info.	Fast flashing
	GPS chip has gotten GPS info.	ON
PWR (Note 2)	No external power and internal battery voltage is lower than 3.46V.	OFF
	No external power and internal battery voltage is below 3.6V.	Slow flashing
	External power in and internal battery is charging.	Fast flashing
	External power in and internal battery is fully charged.	ON





Figure 13. GV600MA LEDs on the Case

**Note:**

1. CELL LED cannot be configured.
2. GPS LED and PWR LED can be configured to turn off by using the configuration tool.
3. Fast flashing: for CELL LED is about 100ms ON/800ms OFF; for GPS LED and PWR LED is about 100ms ON/100ms OFF.
4. Slow flashing: for CELL LED is about 100ms ON/2000ms OFF; for GPS LED and PWR LED is about 600ms ON/600ms OFF.

### 3.10. Temperature Sensor Interface

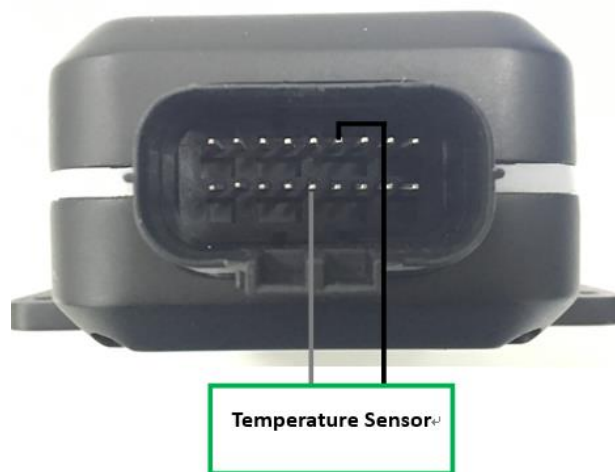

Figure 14. Typical Connection with a Temperature Sensor

### 3.11. Serial Port/UART Interface

There are two lines dedicated to the Serial Port/UART interface (TXD and RXD). TXD and RXD are standard TTL signal.

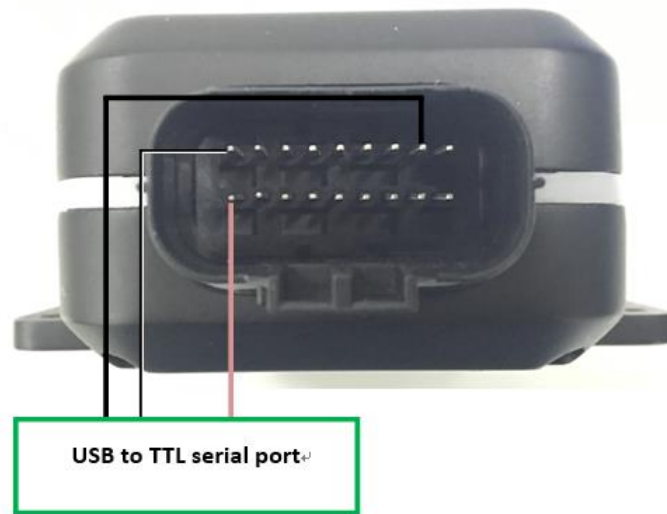

Figure 15. Typical Connection with USB to TTL Serial Port

## 4. Support Peripheral list

Name	Description
Temperature Sensor	GV600MA Temperature Sensor
Fuel level sensor	Digital RS232 (DUT-E COM Protocol)

### 4.1. Bluetooth

The device role of Bluetooth could be Master and Slave.

When the device role is Slave, the device will provide below services: device information service, battery information service, virtual serial port service. Other devices can read or use these services after connecting devices.

When the device role is Master, the device will provide below services: the others devices can read or use the above services after connecting devices, connect the designated device to read the data or related information of the designated Bluetooth devices. After reading the data, the server can be reported to the server by the corresponding message.

## 5. GV600MA Certification



### 5.1. FCC Certification

Any Changes or modifications not expressly approved by the party responsible for compliance could void the user's authority to operate the equipment. This device complies with part 15 of the FCC Rules. Operation is subject to the following two conditions:

- (1) This device may not cause harmful interference.
- (2) This device must accept any interference received, including interference that may cause undesired operation.

FCC Radiation Exposure Statement:

This equipment complies with FCC radiation exposure limits set forth for an uncontrolled environment. This equipment should be installed and Operated with minimum distance 20cm between the radiator & your body.