



# FCC RF Test Report

**APPLICANT** : Quealink Wireless Solutions Co., Ltd.  
**EQUIPMENT** : QLC300NA  
**BRAND NAME** : Quealink  
**MODEL NAME** : QLC300NA  
**FCC ID** : YQD-QLC300NA  
**STANDARD** : 47 CFR Part 2, 22(H), 24(E), 27(L), 27(H), 27(F)  
**CLASSIFICATION** : PCS Licensed Transmitter (PCB)  
**TEST DATE(S)** : Aug. 16, 2023 ~ Aug. 29, 2023

We, Sporton International Inc. (ShenZhen), would like to declare that the tested sample has been evaluated in accordance with the procedures given in ANSI C63.26-2015 and shown compliance with the applicable technical standards.

The test results in this report apply exclusively to the tested model / sample. Without written approval of Sporton International Inc. (ShenZhen), the test report shall not be reproduced except in full.

Jason Jia



Approved by: Jason Jia

**Sporton International Inc. (ShenZhen)**

1/F, 2/F, Bldg 5, Shiling Industrial Zone, Xinwei Village, Xili, Nanshan, Shenzhen, 518055

People's Republic of China



TABLE OF CONTENTS

REVISION HISTORY...3
SUMMARY OF TEST RESULT...4
1 GENERAL DESCRIPTION...6
1.1 Applicant...6
1.2 Manufacturer...6
1.3 Product Feature of Equipment Under Test...6
1.4 Product Specification of Equipment Under Test...6
1.5 Modification of EUT...7
1.6 Maximum Conducted Power and Emission Designator...7
1.7 Testing Location...8
1.8 Test Software...9
1.9 Applicable Standards...9
2 TEST CONFIGURATION OF EQUIPMENT UNDER TEST...10
2.1 Test Mode...10
2.2 Connection Diagram of Test System...12
2.3 Support Unit used in test configuration and system...12
2.4 Measurement Results Explanation Example...12
2.5 Frequency List of Low/Middle/High Channels...13
3 CONDUCTED TEST ITEMS...15
3.1 Measuring Instruments...15
3.2 Test Setup...15
3.3 Test Result of Conducted Test...15
3.4 Conducted Output Power and ERP/EIRP...16
3.5 Peak-to-Average Ratio...17
3.6 Occupied Bandwidth...18
3.7 Conducted Band Edge...19
3.8 Conducted Spurious Emission...21
3.9 Frequency Stability...22
4 RADIATED TEST ITEMS...23
4.1 Measuring Instruments...23
4.2 Test Setup...23
4.3 Test Result of Radiated Test...24
4.4 Radiated Spurious Emission...25
5 LIST OF MEASURING EQUIPMENT...26
6 MEASUREMENT UNCERTAINTY...27
APPENDIX A. TEST RESULTS OF CONDUCTED TEST
APPENDIX B. TEST RESULTS OF RADIATED TEST
APPENDIX C. TEST SETUP PHOTOGRAPHS





## SUMMARY OF TEST RESULT

Report Section	FCC Rule	Description	Limit	Result	Remark
3.4	§2.1046	Conducted Output Power	-	Report Only	-
	§22.913(a)(5)	Effective Radiated Power (Band 5)	ERP < 7 Watt	PASS	-
	§27.50(b)(10) §27.50(c)(10)	Effective Radiated Power (Band 12) (Band 13)	ERP < 3 Watt		-
	§24.232(c)	Equivalent Isotropic Radiated Power (Band 2)	EIRP < 2Watt		-
	§27.50(d)(4)	Equivalent Isotropic Radiated Power (Band 4)	EIRP < 1Watt		-
3.5	§24.232(d)	Peak-to-Average Ratio	<13 dB		PASS
3.6	§2.1049	Occupied Bandwidth	-	Report Only	-
3.7	§2.1051 §22.917(a) §24.238(a) §27.53(c)(2)(4) §27.53(g) §27.53(h)	Conducted Band Edge Measurement (Band 2) (Band 4) (Band 5) (Band 12) (Band 13)	< 43+10log10(P[Watts])	PASS	-
3.8	§2.1051 §22.917(a) §24.238(a) §27.53(c)(2) §27.53(g) §27.53(h)	Conducted Spurious Emission (Band 2) (Band 4) (Band 5) (Band 12) (Band 13)	< 43+10log10(P[Watts])	PASS	-
3.9	§2.1055 §22.355	Frequency Stability Temperature & Voltage	< 2.5 ppm for Part 22	PASS	-
	§2.1055 §24.235 §27.54		Within Authorized Band		



Report Section	FCC Rule	Description	Limit	Result	Remark
4.4	§2.1053 §22.917(a) §24.238(a) §27.53(c)(2) §27.53(f) §27.53(g) §27.53(h)	Radiated Spurious Emission (Band 2) (Band 4) (Band 5) (Band 12) (Band 13)	$< 43 + 10 \log_{10}(P[\text{Watts}])$	PASS	Under limit 17.75 dB at 1563.50 MHz

**Conformity Assessment Condition:**

1. The test results (PASS/FAIL) with all measurement uncertainty excluded are presented against the regulation limits or in accordance with the requirements stipulated by the applicant/manufacture who shall bear all the risks of non-compliance that may potentially occur if measurement uncertainty is taken into account.
2. The measurement uncertainty please refer to each test result in the section "Measurement Uncertainty"

**Disclaimer:**

The product specifications of the EUT presented in the test report that may affect the test assessments are declared by the manufacturer who shall take full responsibility for the authenticity.



# 1 General Description

## 1.1 Applicant

Queclink Wireless Solutions Co., Ltd.

No.30, Lane 500, Xinlong Road, Minhang District, Shanghai, China, 201101

## 1.2 Manufacturer

Queclink Wireless Solutions Co., Ltd.

No.30, Lane 500, Xinlong Road, Minhang District, Shanghai, China, 201101

## 1.3 Product Feature of Equipment Under Test

Product Feature	
Equipment	QLC300NA
Brand Name	Queclink
Model Name	QLC300NA
FCC ID	YQD-QLC300NA
IMEI Code	Conducted/Radiation: 868065060001306
HW Version	V1.02
SW Version	R00A01V08
EUT Stage	Identical Prototype

## 1.4 Product Specification of Equipment Under Test

Standards-related Product Specification	
Tx Frequency	LTE Band 2 : 1850 MHz ~ 1910 MHz LTE Band 4 : 1710 MHz ~ 1755 MHz LTE Band 5 : 824 MHz ~ 849 MHz LTE Band 12 : 699 MHz ~ 716 MHz LTE Band 13 : 777 MHz ~ 787 MHz
Rx Frequency	LTE Band 2 : 1930 MHz ~ 1990 MHz LTE Band 4 : 2110 MHz ~ 2155 MHz LTE Band 5 : 869 MHz ~ 894 MHz LTE Band 12 : 729 MHz ~ 746 MHz LTE Band 13 : 746 MHz ~ 756 MHz
Bandwidth	LTE Band 2 : 1.4MHz / 3MHz / 5MHz / 10MHz / 15MHz / 20MHz LTE Band 4 : 1.4MHz / 3MHz / 5MHz / 10MHz / 15MHz / 20MHz LTE Band 5 : 1.4MHz / 3MHz / 5MHz / 10MHz LTE Band 12 : 1.4MHz / 3MHz / 5MHz / 10MHz LTE Band 13 : 5MHz / 10MHz
Maximum Output Power to Antenna	LTE Band 2 : 23.31 dBm LTE Band 4 : 23.42 dBm LTE Band 5 : 23.23 dBm LTE Band 12 : 23.31 dBm LTE Band 13 : 23.15 dBm



Antenna Gain	LTE Band 2 : 2.56 dBi
	LTE Band 4 : 3.13 dBi
	LTE Band 5 : 0.85 dBi
	LTE Band 12 : 0.33 dBi
	LTE Band 13 : 1.49 dBi
Type of Modulation	QPSK / 16QAM

Remark: This device support LTE category 1 bis.

### 1.5 Modification of EUT

No modifications are made to the EUT during all test items.

### 1.6 Maximum Conducted Power and Emission Designator

LTE Band 2		QPSK		16QAM	
BW (MHz)	Frequency Range (MHz)	Maximum Conducted power (W)	Emission Designator (99%OBW)	Maximum Conducted power (W)	Emission Designator (99%OBW)
1.4	1850.7 ~ 1909.3	0.2075	1M09G7D	0.1710	1M09W7D
3	1851.5 ~ 1908.5	0.2104	2M72G7D	0.1811	2M70W7D
5	1852.5 ~ 1907.5	0.2113	4M50G7D	0.1816	4M48W7D
10	1855.0 ~ 1905.0	0.2084	9M03G7D	0.1854	5M03W7D
15	1857.5 ~ 1902.5	0.2080	13M4G7D	0.1837	5M00W7D
20	1860.0 ~ 1900.0	0.2143	17M9G7D	0.1875	5M11W7D
LTE Band 4		QPSK		16QAM	
BW (MHz)	Frequency Range (MHz)	Maximum Conducted power (W)	Emission Designator (99%OBW)	Maximum Conducted power (W)	Emission Designator (99%OBW)
1.4	1710.7 ~ 1754.3	0.2168	1M09G7D	0.1892	1M09W7D
3	1711.5 ~ 1753.5	0.2158	2M72G7D	0.1901	2M72W7D
5	1712.5 ~ 1752.5	0.2138	4M49G7D	0.1901	4M46W7D
10	1715.0 ~ 1750.0	0.2143	8M95G7D	0.1910	5M05W7D
15	1717.5 ~ 1747.5	0.2163	13M4G7D	0.1923	5M03W7D
20	1720.0 ~ 1745.0	0.2198	17M8G7D	0.1963	5M00W7D
LTE Band 5		QPSK		16QAM	
BW (MHz)	Frequency Range (MHz)	Maximum Conducted power (W)	Emission Designator (99%OBW)	Maximum Conducted power (W)	Emission Designator (99%OBW)
1.4	824.7 ~ 848.3	0.2099	1M09G7D	0.1746	1M09W7D
3	825.5 ~ 847.5	0.2056	2M72G7D	0.1656	2M71W7D
5	826.5 ~ 846.5	0.2065	4M48G7D	0.1648	4M48W7D
10	829.0 ~ 844.0	0.2104	8M99G7D	0.1683	5M05W7D



LTE Band 12		QPSK		16QAM	
BW (MHz)	Frequency Range (MHz)	Maximum Conducted power (W)	Emission Designator (99%OBW)	Maximum Conducted power (W)	Emission Designator (99%OBW)
1.4	699.7 ~ 715.3	0.2138	1M09G7D	0.1694	1M08W7D
3	700.5 ~ 714.5	0.2099	2M71G7D	0.1679	2M71W7D
5	701.5 ~ 713.5	0.2118	4M49G7D	0.1679	4M49W7D
10	704.0 ~ 711.0	0.2143	8M99G7D	0.1730	5M01W7D
LTE Band 13		QPSK		16QAM	
BW (MHz)	Frequency Range (MHz)	Maximum Conducted power (W)	Emission Designator (99%OBW)	Maximum Conducted power (W)	Emission Designator (99%OBW)
5	779.5 ~ 784.5	0.2051	4M49G7D	0.1690	4M51W7D
10	782.0	0.2065	8M99G7D	0.1710	4M96W7D

### 1.7 Testing Location

Sporton International Inc. (ShenZhen) is accredited to ISO/IEC 17025:2017 by American Association for Laboratory Accreditation with Certificate Number 5145.01.

<b>Test Firm</b>	Sporton International Inc. (ShenZhen)		
<b>Test Site Location</b>	1/F, 2/F, Bldg 5, Shiling Industrial Zone, Xinwei Village, Xili, Nanshan, Shenzhen, 518055 People's Republic of China TEL: +86-755-86379589 FAX: +86-755-86379595		
<b>Test Site No.</b>	<b>Sporton Site No.</b>	<b>FCC Designation No.</b>	<b>FCC Test Firm Registration No.</b>
	TH01-SZ	CN1256	421272

<b>Test Firm</b>	Sporton International Inc. (ShenZhen)		
<b>Test Site Location</b>	101, 1st Floor, Block B, Building 1, No. 2, Tengfeng 4th Road, Fenghuang Community, Fuyong Street, Baoan District, Shenzhen City, Guangdong Province 518103 People's Republic of China TEL: +86-755-86066985		
<b>Test Site No.</b>	<b>Sporton Site No.</b>	<b>FCC Designation No.</b>	<b>FCC Test Firm Registration No.</b>
	03CH01-SZ	CN1256	421272





### 1.8 Test Software

Item	Site	Manufacture	Name	Version
1.	03CH01-SZ	AUDIX	E3	6.2009-8-24

### 1.9 Applicable Standards

According to the specifications of the manufacturer, the EUT must comply with the requirements of the following standards:

- ♦ 47 CFR Part 2, 22(H), 24(E), 27(L), 27(H), 27(F)
- ♦ ANSI C63.26-2015
- ♦ FCC KDB 971168 D01 Power Meas License Digital Systems v03r01
- ♦ FCC KDB 412172 D01 Determining ERP and EIRP v01r01

**Remark:**

1. All test items were verified and recorded according to the standards and without any deviation during the test.
2. This EUT has also been tested and complied with the requirements of FCC Part 15, Subpart B, recorded in a separate test report.



## 2 Test Configuration of Equipment Under Test

### 2.1 Test Mode

Antenna port conducted and radiated test items listed below are performed according to KDB 971168 D01 Power Meas License Digital Systems v03r01 with maximum output power.

Radiated measurements are performed by rotating the EUT in three different orthogonal test planes to find the maximum emission. (X Plane)

Test Items	Band	Bandwidth (MHz)						Modulation			RB #			Test Channel		
		1.4	3	5	10	15	20	QPSK	16QAM	64QAM	1	Half	Full	L	M	H
Max. Output Power	2	v	v	v	v	v	v	v	v	-	v	v	v	v	v	v
	4	v	v	v	v	v	v	v	v	-	v	v	v	v	v	v
	5	v	v	v	v	-	-	v	v	-	v	v	v	v	v	v
	12	v	v	v	v	-	-	v	v	-	v	v	v	v	v	v
	13	-	-	v	v	-	-	v	v	-	v	v	v	v	v	v
Peak-to-Average Ratio	2						v	v		-			v		v	
	4						v	v		-			v		v	
	5				v	-	-	v		-			v		v	
	12				v	-	-	v		-			v		v	
	13	-	-		v	-	-	v		-			v		v	
26dB and 99% Bandwidth	2	v	v	v	v	v	v	v	v	-			v		v	
	4	v	v	v	v	v	v	v	v	-			v		v	
	5	v	v	v	v	-	-	v	v	-			v		v	
	12	v	v	v	v	-	-	v	v	-			v		v	
	13	-	-	v	v	-	-	v	v	-			v		v	
Conducted Band Edge	2	v	v	v	v	v	v	v	v	-	v		v	v		v
	4	v	v	v	v	v	v	v	v	-	v		v	v		v
	5	v	v	v	v	-	-	v	v	-	v		v	v		v
	12	v	v	v	v	-	-	v	v	-	v		v	v		v
	13	-	-	v	v	-	-	v	v	-	v		v	v		v
Conducted Spurious Emission	2	v	v	v	v	v	v	v		-	v			v	v	v
	4	v	v	v	v	v	v	v		-	v			v	v	v
	5	v	v	v	v	-	-	v		-	v			v	v	v
	12	v	v	v	v	-	-	v		-	v			v	v	v
	13	-	-	v	v	-	-	v		-	v			v	v	v



Test Items	Band	Bandwidth (MHz)						Modulation			RB #			Test Channel			
		1.4	3	5	10	15	20	QPSK	16QAM	64QAM	1	Half	Full	L	M	H	
Frequency Stability	2				v			v		-			v		v		
	4				v			v		-			v		v		
	5				v	-	-	v		-			v		v		
	12				v	-	-	v		-			v		v		
	13	-	-		v	-	-	v		-			v		v		
E.R.P / E.I.R.P	2	v	v	v	v	v	v	v	v	-	v	v	v	v	v	v	
	4	v	v	v	v	v	v	v	v	-	v	v	v	v	v	v	
	5	v	v	v	v	-	-	v	v	-	v	v	v	v	v	v	
	12	v	v	v	v	-	-	v	v	-	v	v	v	v	v	v	
	13	-	-	v	v	-	-	v	v	-	v	v	v	v	v	v	
Radiated Spurious Emission	2	Worst Case														v	
	4	Worst Case														v	
	5	Worst Case														v	
	12	Worst Case														v	
	13	Worst Case														v	
Note	<ol style="list-style-type: none"> <li>The mark "v" means that this configuration is chosen for testing</li> <li>The mark "-" means that this bandwidth is not supported.</li> <li>The device is investigated from 30MHz to 10 times of fundamental signal for radiated spurious emission test under different RB size/offset and modulations in exploratory test. Subsequently, only the worst case emissions are reported.</li> <li>All test items are based on engineering evaluation.</li> </ol>																

## 2.2 Connection Diagram of Test System

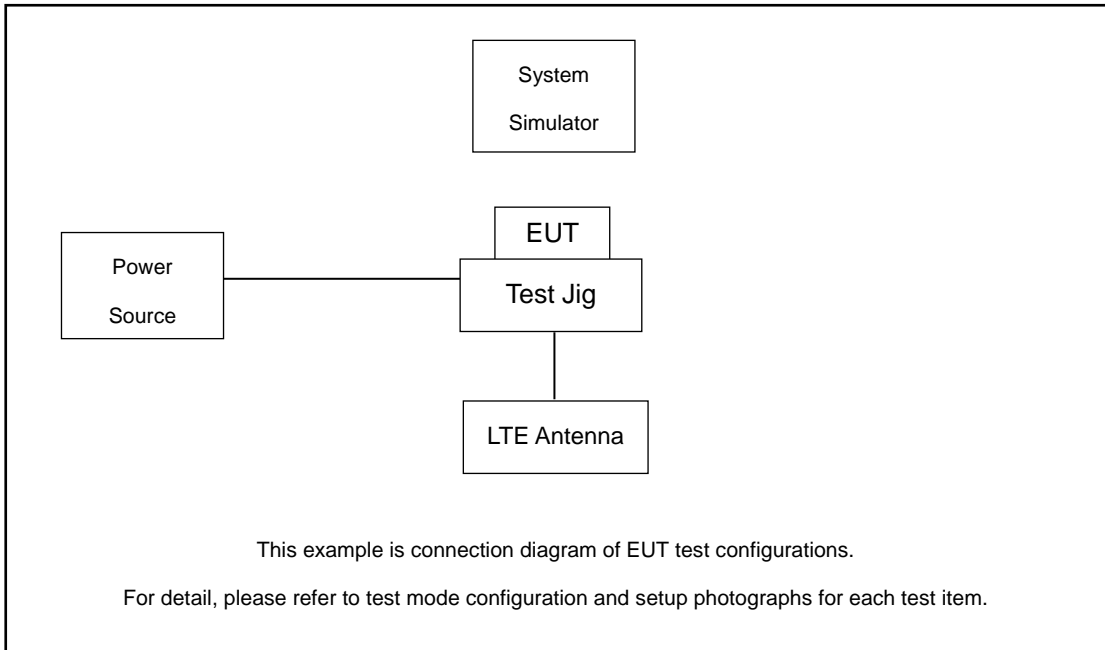

## 2.3 Support Unit used in test configuration and system

Item	Equipment	Trade Name	Model No.	FCC ID	Data Cable	Power Cord
1.	Power Supply	GWINSTEK	PSS-2002	N/A	N/A	Unshielded, 1.8 m
2.	LTE Base Station	Anritsu	MT8820C	N/A	N/A	Unshielded, 1.8 m
3.	Adapter	Queclink	N/A	N/A	N/A	N/A
4.	LTE Antenna	Saintenna	SAA31176A	N/A	N/A	N/A
5.	Test Jig	N/A	N/A	N/A	N/A	N/A

## 2.4 Measurement Results Explanation Example

### For all conducted test items:

The offset level is set in the spectrum analyzer to compensate the RF cable loss and attenuator factor between EUT conducted output port and spectrum analyzer. With the offset compensation, the spectrum analyzer reading level is exactly the EUT RF output level.

The spectrum analyzer offset is derived from RF cable loss and attenuator factor.

*Offset = RF cable loss + attenuator factor.*

Following shows an offset computation example with cable loss 4.5 dB and 10dB attenuator.

Example :

$$\begin{aligned} \text{Offset(dB)} &= \text{RF cable loss(dB)} + \text{attenuator factor(dB)} \\ &= 4.5 + 10 = 14.5 \text{ (dB)} \end{aligned}$$



### 2.5 Frequency List of Low/Middle/High Channels

LTE Band 2 Channel and Frequency List				
BW [MHz]	Channel/Frequency(MHz)	Lowest	Middle	Highest
20	Channel	18700	18900	19100
	Frequency	1860	1880	1900
15	Channel	18675	18900	19125
	Frequency	1857.5	1880	1902.5
10	Channel	18650	18900	19150
	Frequency	1855	1880	1905
5	Channel	18625	18900	19175
	Frequency	1852.5	1880	1907.5
3	Channel	18615	18900	19185
	Frequency	1851.5	1880	1908.5
1.4	Channel	18607	18900	19193
	Frequency	1850.7	1880	1909.3

LTE Band 4 Channel and Frequency List				
BW [MHz]	Channel/Frequency(MHz)	Lowest	Middle	Highest
20	Channel	20050	20175	20300
	Frequency	1720	1732.5	1745
15	Channel	20025	20175	20325
	Frequency	1717.5	1732.5	1747.5
10	Channel	20000	20175	20350
	Frequency	1715	1732.5	1750
5	Channel	19975	20175	20375
	Frequency	1712.5	1732.5	1752.5
3	Channel	19965	20175	20385
	Frequency	1711.5	1732.5	1753.5
1.4	Channel	19957	20175	20393
	Frequency	1710.7	1732.5	1754.3



LTE Band 5 Channel and Frequency List				
BW [MHz]	Channel/Frequency(MHz)	Lowest	Middle	Highest
10	Channel	20450	20525	20600
	Frequency	829	836.5	844
5	Channel	20425	20525	20625
	Frequency	826.5	836.5	846.5
3	Channel	20415	20525	20635
	Frequency	825.5	836.5	847.5
1.4	Channel	20407	20525	20643
	Frequency	824.7	836.5	848.3

LTE Band 12 Channel and Frequency List				
BW [MHz]	Channel/Frequency(MHz)	Lowest	Middle	Highest
10	Channel	23060	23095	23130
	Frequency	704	707.5	711
5	Channel	23035	23095	23155
	Frequency	701.5	707.5	713.5
3	Channel	23025	23095	23165
	Frequency	700.5	707.5	714.5
1.4	Channel	23017	23095	23173
	Frequency	699.7	707.5	715.3

LTE Band 13 Channel and Frequency List				
BW [MHz]	Channel/Frequency(MHz)	Lowest	Middle	Highest
10	Channel	-	23230	-
	Frequency	-	782	-
5	Channel	23205	23230	23255
	Frequency	779.5	782	784.5

### 3 Conducted Test Items

#### 3.1 Measuring Instruments

See list of measuring instruments of this test report.

#### 3.2 Test Setup

##### 3.2.1 Conducted Output Power



##### 3.2.2 Peak-to-Average Ratio, Occupied Bandwidth, Conducted Band-Edge and Conducted Spurious Emission

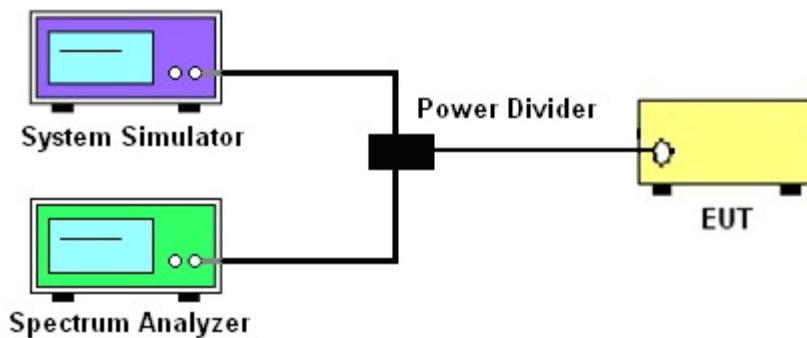

##### 3.2.3 Frequency Stability

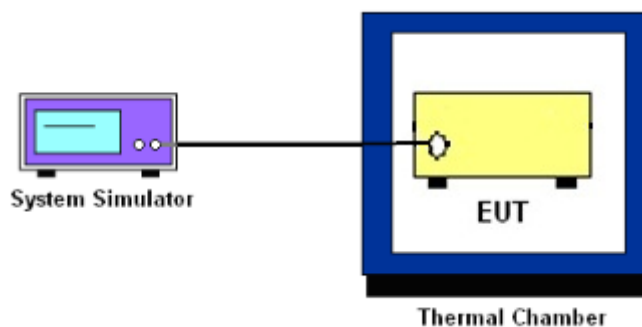

### 3.3 Test Result of Conducted Test

Please refer to Appendix A.



### 3.4 Conducted Output Power and ERP/EIRP

#### 3.4.1 Description of the Conducted Output Power Measurement and ERP/EIRP Measurement

A system simulator was used to establish communication with the EUT. Its parameters were set to force the EUT transmitting at maximum output power. The measured power in the radio frequency on the transmitter output terminals shall be reported.

The ERP of mobile transmitters must not exceed 7 Watts for LTE Band 5.

The ERP of mobile transmitters must not exceed 3 Watts for LTE Band 12 and Band 13.

The EIRP of mobile transmitters must not exceed 2 Watts for LTE Band 2.

The EIRP of mobile transmitters must not exceed 1 Watts for LTE Band 4.

According to KDB 412172 D01 Power Approach,

$EIRP = P_T + G_T - L_C$ ,  $ERP = EIRP - 2.15$ , where

$P_T$  = transmitter output power in dBm

$G_T$  = gain of the transmitting antenna in dBi

$L_C$  = signal attenuation in the connecting cable between the transmitter and antenna in dB

#### 3.4.2 Test Procedures

1. The testing follows ANSI C63.26 Section 5.2
2. The transmitter output port was connected to the system simulator.
3. Set EUT at maximum power through the system simulator.
4. Select lowest, middle, and highest channels for each band and different modulation.
5. Measure and record the power level from the system simulator.





## 3.5 Peak-to-Average Ratio

### 3.5.1 Description of the PAR Measurement

Power Complementary Cumulative Distribution Function (CCDF) curves provide a means for characterizing the power peaks of a digitally modulated signal on a statistical basis. A CCDF curve depicts the probability of the peak signal amplitude exceeding the average power level. Most contemporary measurement instrumentation include the capability to produce CCDF curves for an input signal provided that the instrument's resolution bandwidth can be set wide enough to accommodate the entire input signal bandwidth. In measuring transmissions in this band using an average power technique, the peak-to-average ratio (PAR) of the transmission may not exceed 13 dB.

### 3.5.2 Test Procedures

1. The testing follows ANSI C63.26 Section 5.2.3.4 (CCDF).
2. The EUT was connected to spectrum and system simulator via a power divider.
3. Set the CCDF (Complementary Cumulative Distribution Function) option in spectrum analyzer.
4. The highest RF powers were measured and recorded the maximum PAPR level associated with a probability of 0.1 %.
5. Record the deviation as Peak to Average Ratio.



### 3.6 Occupied Bandwidth

#### 3.6.1 Description of Occupied Bandwidth Measurement

The occupied bandwidth is the width of a frequency band such that, below the lower and above the upper frequency limits, the mean powers emitted are each equal to a specified percentage 0.5% of the total mean transmitted power.

The 26 dB emission bandwidth is defined as the frequency range between two points, one above and one below the carrier frequency, at which the spectral density of the emission is attenuated 26 dB below the maximum in-band spectral density of the modulated signal. Spectral density (power per unit bandwidth) is to be measured with a detector of resolution bandwidth equal to approximately 1.0% of the emission bandwidth.

#### 3.6.2 Test Procedures

1. The testing follows ANSI C63.26 Section 5.4
2. The EUT was connected to spectrum analyzer and system simulator via a power divider.
3. The spectrum analyzer center frequency is set to the nominal EUT channel center frequency. The span range for the spectrum analyzer shall be between two and five times the anticipated OBW.
4. The nominal resolution bandwidth (RBW) shall be in the range of 1 to 5 % of the anticipated OBW, and the VBW shall be at least 3 times the RBW.
5. Set the detection mode to peak, and the trace mode to max hold.
6. Determine the reference value: Set the EUT to transmit a modulated signal. Allow the trace to stabilize. Set the spectrum analyzer marker to the highest level of the displayed trace.  
(this is the reference value)
7. Determine the “-26 dB down amplitude” as equal to (Reference Value – X).
8. Place two markers, one at the lowest and the other at the highest frequency of the envelope of the spectral display such that each marker is at or slightly below the “-X dB down amplitude” determined in step 6. If a marker is below this “-X dB down amplitude” value it shall be placed as close as possible to this value. The OBW is the positive frequency difference between the two markers.
9. Use the 99 % power bandwidth function of the spectrum analyzer and report the measured bandwidth.



### 3.7 Conducted Band Edge

#### 3.7.1 Description of Conducted Band Edge Measurement

22.917(a)

For operations in the 824 – 849 MHz band, the FCC limit is  $43 + 10\log_{10}(P[\text{Watts}])$  dB below the transmitter power P(Watts) in a 100kHz bandwidth. However, in the 1MHz bands immediately outside and adjacent to the licensee's frequency block, a resolution bandwidth of at least one percent of the emission bandwidth of the fundamental emission of the transmitter may be employed.

24.238 (a)

For operations in the 1850-1910 and 1930-1990 MHz band, the FCC limit is  $43 + 10\log_{10}(P[\text{Watts}])$  dB below the transmitter power P(Watts) in a 1MHz bandwidth. However, in the 1 MHz bands immediately outside and adjacent to the frequency block a resolution bandwidth of at least one percent of the emission bandwidth of the fundamental emission of the transmitter may be employed.

27.53 (c)

For operations in the 776-788 MHz band, the FCC limit is  $43 + 10\log_{10}(P[\text{Watts}])$  dB below the transmitter power P(Watts) in a 100 kHz bandwidth. However, in the 100 kHz bands immediately outside and adjacent to the frequency block, a resolution bandwidth of at least 30 kHz may be employed. In addition, the power of any unwanted emissions in any 6.25 kHz bandwidth for all frequencies between 763-775 MHz and 793-806 MHz shall be attenuated below the transmitter power, P (dBW), by at least  $65 + 10 \log_{10} p(\text{watts})$ , dB, for mobile and portable equipment.

27.53 (g)

For operations in the 600MHz band and 698 -746 MHz band, the FCC limit is  $43 + 10\log_{10}(P[\text{Watts}])$  dB below the transmitter power P(Watts) in a 100 kHz bandwidth. However, in the 100 kilohertz bands immediately outside and adjacent to a licensee's frequency block, a resolution bandwidth of at least 30 kHz may be employed.

27.53 (h)

For operations in the 1710 – 1755 MHz band, the FCC limit is  $43 + 10\log_{10}(P[\text{Watts}])$  dB below the transmitter power P(Watts) in a 1 MHz bandwidth. However, in the 1MHz bands immediately outside and adjacent to the licensee's frequency block, a resolution bandwidth of at least one percent of the emission bandwidth of the fundamental emission of the transmitter may be employed.



### 3.7.2 Test Procedures

1. The testing follows ANSI C63.26 section 5.7
2. The EUT was connected to spectrum analyzer and system simulator via a power divider.
3. The band edges of low and high channels for the highest RF powers were measured.
4. Set RBW  $\geq$  1% EBW in the 1MHz band immediately outside and adjacent to the band edge.
5. Beyond the 1 MHz band from the band edge, RBW=1MHz was used.
6. Set spectrum analyzer with RMS detector.
7. The RF fundamental frequency should be excluded against the limit line in the operating frequency band.
8. Checked that all the results comply with the emission limit line.

Example:

The limit line is derived from  $43 + 10\log(P)$ dB below the transmitter power P(Watts)  
= P(W)- [43 + 10log(P)] (dB)  
= [30 + 10log(P)] (dBm) - [43 + 10log(P)] (dB) = -13dBm.

9. When using the integration method, the starting frequency of the integration shall be centered at one-half of the RBW away from the band edge.



### 3.8 Conducted Spurious Emission

#### 3.8.1 Description of Conducted Spurious Emission Measurement

The power of any emission outside of the authorized operating frequency ranges must be lower than the transmitter power (P) by a factor of at least  $43 + 10 \log (P)$  dB.

It is measured by means of a calibrated spectrum analyzer and scanned from 30 MHz up to a frequency including its 10<sup>th</sup> harmonic.

#### 3.8.2 Test Procedures

1. The testing follows ANSI C63.26 section 5.7
2. The EUT was connected to spectrum analyzer and system simulator via a power divider.
3. The RF output of EUT was connected to the spectrum analyzer by RF cable and attenuator. The path loss was compensated to the results for each measurement.
4. The middle channel for the highest RF power within the transmitting frequency was measured.
5. The conducted spurious emission for the whole frequency range was taken.
6. Make the measurement with the spectrum analyzer's RBW = 1MHz, VBW = 3MHz.
7. Set spectrum analyzer with RMS detector.
8. Taking the record of maximum spurious emission.
9. The RF fundamental frequency should be excluded against the limit line in the operating frequency band.
10. The limit line is derived from  $43 + 10\log(P)$ dB below the transmitter power P(Watts)  
= P(W)- [43 + 10log(P)] (dB)  
= [30 + 10log(P)] (dBm) - [43 + 10log(P)] (dB)  
= -13dBm.



## 3.9 Frequency Stability

### 3.9.1 Description of Frequency Stability Measurement

The frequency stability shall be measured by variation of ambient temperature and variation of primary supply voltage to ensure that the fundamental emission stays within the authorized frequency block. The frequency stability of the transmitter shall be maintained within  $\pm 0.00025\%$  ( $\pm 2.5\text{ppm}$ ) of the center frequency.

### 3.9.2 Test Procedures for Temperature Variation

1. The testing follows ANSI C63.26 section 5.6.4
2. The EUT was set up in the thermal chamber and connected with the system simulator.
3. With power OFF, the temperature was decreased to  $-30^{\circ}\text{C}$  and the EUT was stabilized before testing. Power was applied and the maximum change in frequency was recorded within one minute.
4. With power OFF, the temperature was raised in  $10^{\circ}\text{C}$  step up to  $50^{\circ}\text{C}$ . The EUT was stabilized at each step for at least half an hour. Power was applied and the maximum frequency change was recorded within one minute.

### 3.9.3 Test Procedures for Voltage Variation

1. The testing follows ANSI C63.26 section 5.6.5
2. The EUT was placed in a temperature chamber at  $20\pm 5^{\circ}\text{C}$  and connected with the system simulator.
3. The power supply voltage to the EUT was varied from 85% to 115% of the nominal value for other than hand carried battery equipment.
4. For hand carried, battery powered equipment, reduce the primary ac or dc supply voltage to the battery operating end point, which shall be specified by the manufacturer.
5. The variation in frequency was measured for the worst case.

## 4 Radiated Test Items

### 4.1 Measuring Instruments

See list of measuring instruments of this test report.

### 4.2 Test Setup

#### 4.2.1 For radiated test below 30MHz

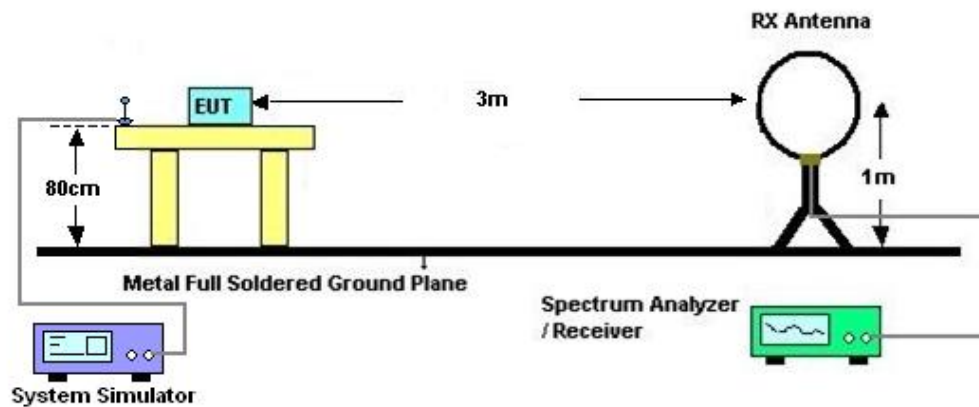

#### 4.2.2 For radiated test from 30MHz to 1GHz

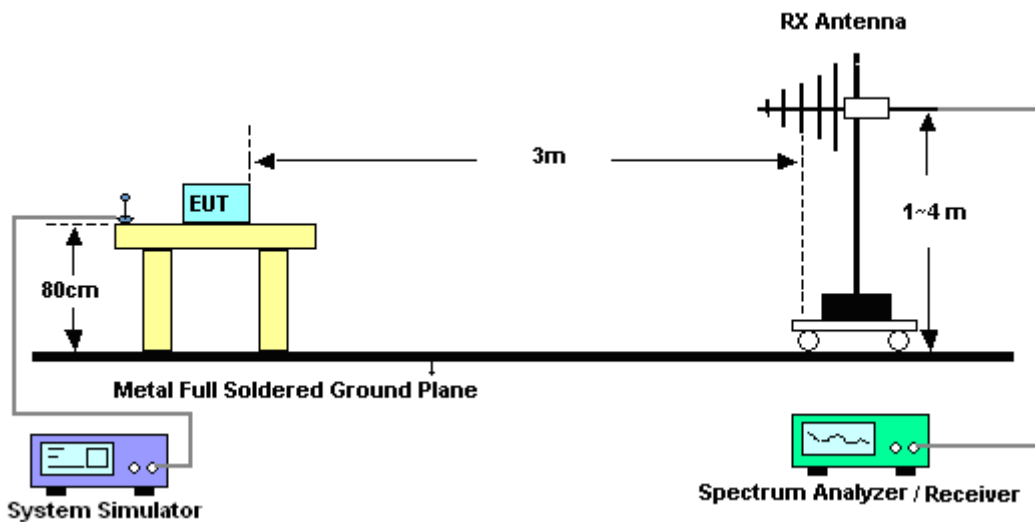

#### 4.2.3 For radiated test above 1GHz

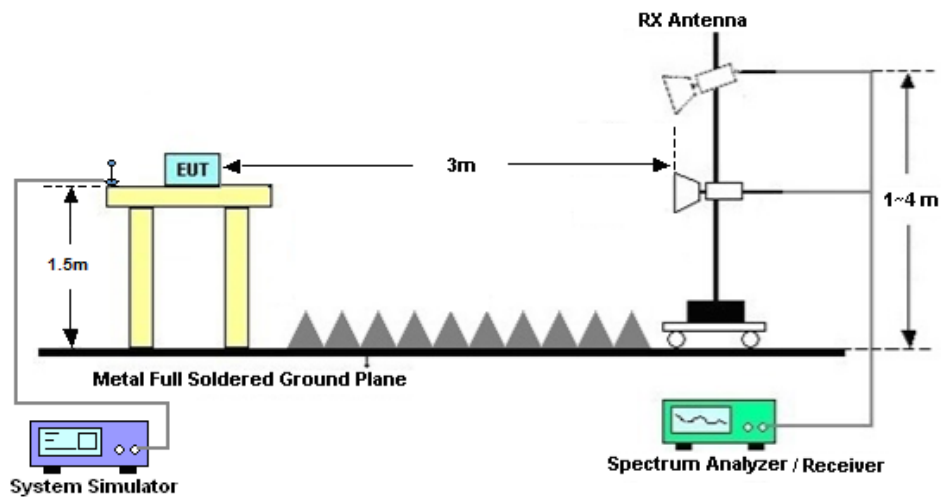

#### 4.3 Test Result of Radiated Test

The low frequency, which started from 9 kHz to 30MHz, was pre-scanned and the result which was 20dB lower than the limit line was not reported.

Please refer to Appendix B.





## 4.4 Radiated Spurious Emission

### 4.4.1 Description of Radiated Spurious Emission

The radiated spurious emission was measured by substitution method according to ANSI C63.26. The power of any emission outside of the authorized operating frequency ranges must be attenuated below the transmitter power (P) by a factor of at least  $43 + 10 \log (P)$  dB.

For LTE Band 13

For operations in the 746-758 MHz, 775-788 MHz, and 805-806 MHz bands, emissions in the band 1559-1610 MHz shall be limited to  $-70$  dBW/MHz equivalent isotropically radiated power (EIRP) for wideband signals, and  $-80$  dBW EIRP for discrete emissions of less than 700 Hz bandwidth.

The spectrum is scanned from 30 MHz up to a frequency including its 10th harmonic.

### 4.4.2 Test Procedures

1. The testing follows ANSI C63.26 Section 5.5
2. The EUT was placed on a turntable with 0.8 meter height for frequency below 1GHz and 1.5 meter height for frequency above 1GHz respectively above ground.
3. The EUT was set 3 meters from the receiving antenna mounted on the antenna tower.
4. The table was rotated 360 degrees to determine the position of the highest spurious emission.
5. The height of the receiving antenna is varied between 1m to 4m to search the maximum spurious emission for both horizontal and vertical polarizations.
6. During the measurement, the system simulator parameters were set to force the EUT transmitting at maximum output power.
7. Make the measurement with the spectrum analyzer's RBW = 1MHz, VBW = 3MHz, taking the record of maximum spurious emission.
8. A horn antenna was substituted in place of the EUT and was driven by a signal generator.
9. Tune the output power of signal generator to the same emission level with EUT maximum spurious emission.
10.  $EIRP (dBm) = S.G. Power - Tx Cable Loss + Tx Antenna Gain$
11.  $ERP (dBm) = EIRP - 2.15$
12. The RF fundamental frequency should be excluded against the limit line in the operating frequency band.

The limit line is derived from  $43 + 10\log(P)$ dB below the transmitter power P(Watts)  
 $= P(W) - [43 + 10\log(P)] (dB)$   
 $= [30 + 10\log(P)] (dBm) - [43 + 10\log(P)] (dB)$   
 $= -13dBm.$



## 5 List of Measuring Equipment

Instrument	Manufacturer	Model No.	Serial No.	Characteristics	Calibration Date	Test Date	Due Date	Remark
Spectrum Analyzer	R&S	FSV40	101078	10Hz~40GHz	Apr. 06, 2023	Aug. 16, 2023~ Aug. 29, 2023	Apr. 05, 2024	Conducted (TH01-SZ)
DC Power Supply	TTI	PL330P	290070	Max 32V , 3A	Oct. 17, 2022	Aug. 16, 2023~ Aug. 29, 2023	Oct. 16, 2023	Conducted (TH01-SZ)
Power Divider	TOJOIN	PS-2SM-04 265	60.06.020.007 7	0.4GHz~26.5GHz	Dec. 25, 2022	Aug. 16, 2023~ Aug. 29, 2023	Dec. 24, 2023	Conducted (TH01-SZ)
Thermal Chamber	Ten Billion Hongzhangroup	LP-150U	H2014081803	-40~+150°C	Jul. 05, 2023	Aug. 16, 2023~ Aug. 29, 2023	Jul. 04, 2024	Conducted (TH01-SZ)
EMI Test Receiver&SA	Agilent	N9038A	MY52260185	20Hz~26.5GHz	Dec. 26, 2022	Aug. 18, 2023	Dec. 25, 2023	Radiation (03CH01-SZ)
Loop Antenna	R&S	HFH2-Z2	100354	9kHz~30MHz	Jul. 28, 2022	Aug. 18, 2023	Jul. 27, 2024	Radiation (03CH01-SZ)
HF Amplifier	KEYSIGHT	83017A	MY53270105	0.5GHz~26.5Ghz	Oct. 19, 2022	Aug. 18, 2023	Oct. 18, 2023	Radiation (03CH01-SZ)
Bilog Antenna	TeseQ	CBL6112D	35407	30MHz-2GHz	Sep. 28, 2021	Aug. 18, 2023	Sep. 27, 2023	Radiation (03CH01-SZ)
Double Ridge Horn Antenna	ETS-Lindgren	3117	00119436	1GHz~18GHz	Jul. 08, 2023	Aug. 18, 2023	Jul. 07, 2024	Radiation (03CH01-SZ)
SHF-EHF Horn	com-power	AH-840	101071	18Ghz-40GHz	Apr. 08,2023	Aug. 18, 2023	Apr. 07,2024	Radiation (03CH01-SZ)
LF Amplifier	Burgeon	BPA-530	102209	0.01~3000Mhz	Apr. 04, 2023	Aug. 18, 2023	Apr. 03, 2024	Radiation (03CH01-SZ)
HF Amplifier	MITEQ	AMF-7D-00 101800-30-1 0P-R	1943528	1GHz~18GHz	Oct. 19, 2022	Aug. 18, 2023	Oct. 18, 2023	Radiation (03CH01-SZ)
HF Amplifier	MITEQ	TTA1840-35 -HG	1871923	18GHz~40GHz	Jul. 07, 2023	Aug. 18, 2023	Jul. 06, 2024	Radiation (03CH01-SZ)
AC Power Source	Chroma	61601	616010001985	N/A	Nov. 10, 2022	Aug. 18, 2023	Nov. 09, 2023	Radiation (03CH01-SZ)
Turn Table	EM	EM1000	N/A	0~360 degree	NCR	Aug. 18, 2023	NCR	Radiation (03CH01-SZ)
Antenna Mast	EM	EM1000	N/A	1 m~4 m	NCR	Aug. 18, 2023	NCR	Radiation (03CH01-SZ)

NCR: No Calibration Required



## 6 Measurement Uncertainty

The measurement uncertainties shown below were calculated in accordance with the requirements of ANSI 63.26-2015. All the measurement uncertainty value were shown with a coverage K=2 to indicate 95% level of confidence. The measurement data show herein meets or exceeds the CISPR measurement uncertainty values specified in CISPR 16-4-2 and can be compared directly to specified limit to determine compliance.

### Uncertainty of Conducted Measurement

Test Item	Uncertainty
Conducted Power	±1.34 dB
Conducted Emissions	±1.34 dB
Occupied Channel Bandwidth	±0.1 %

### Uncertainty of Radiated Emission Measurement (30 MHz ~ 1000 MHz)

Measuring Uncertainty for a Level of Confidence of 95% (U = 2Uc(y))	2.48 dB
---	---------

### Uncertainty of Radiated Emission Measurement (1 GHz ~ 18 GHz)

Measuring Uncertainty for a Level of Confidence of 95% (U = 2Uc(y))	3.53 dB
---	---------

### Uncertainty of Radiated Emission Measurement (18 GHz ~ 40 GHz)

Measuring Uncertainty for a Level of Confidence of 95% (U = 2Uc(y))	4.02 dB
---	---------



## Appendix A. Test Results of Conducted Test

Test Engineer :	Fly Liang	Temperature :	22~23°C
		Relative Humidity :	40~42%

### Conducted Output Power(Average power)

**LTE Band 2:**

BW [MHz]	Modulation	RB Size	RB Offset	Power Low Ch. / Freq.	Power Middle Ch. / Freq.	Power High Ch. / Freq.
Channel				18700	18900	19100
Frequency (MHz)				1860	1880	1900
20	QPSK	1	0	23.18	23.31	23.26
20	QPSK	1	49	23.07	23.12	23.06
20	QPSK	1	99	23.07	23.03	23.01
20	QPSK	50	0	22.46	22.43	22.38
20	QPSK	50	24	22.45	22.47	22.45
20	QPSK	50	50	22.26	22.23	22.24
20	QPSK	100	0	22.36	22.37	22.43
20	16QAM	1	0	22.41	22.73	22.36
20	16QAM	1	49	22.55	22.64	22.60
20	16QAM	1	99	22.61	22.58	22.53
Channel				18675	18900	19125
Frequency (MHz)				1857.5	1880	1902.5
15	QPSK	1	0	23.11	23.18	23.13
15	QPSK	1	37	23.11	23.13	23.09
15	QPSK	1	74	23.02	23.06	23.07
15	QPSK	36	0	22.38	22.28	22.31
15	QPSK	36	20	22.34	22.31	22.32
15	QPSK	36	39	22.16	22.07	22.10
15	QPSK	75	0	22.25	22.26	22.36
15	16QAM	1	0	22.33	22.64	22.29
15	16QAM	1	37	22.42	22.48	22.44
15	16QAM	1	74	22.45	22.42	22.39
Channel				18650	18900	19150
Frequency (MHz)				1855	1880	1905
10	QPSK	1	0	23.05	23.19	23.11
10	QPSK	1	25	23.13	23.15	23.11
10	QPSK	1	49	23.18	23.03	23.11
10	QPSK	25	0	22.35	22.30	22.23
10	QPSK	25	12	22.33	22.31	22.32
10	QPSK	25	25	22.17	22.10	22.11
10	QPSK	50	0	22.27	22.25	22.35
10	16QAM	1	0	22.36	22.68	22.31
10	16QAM	1	25	22.49	22.57	22.51
10	16QAM	1	49	22.51	22.50	22.38
10	16QAM	25	0	22.14	22.13	22.09
10	16QAM	25	12	21.89	21.85	21.97
10	16QAM	25	25	22.04	21.95	22.08
Channel				18625	18900	19175
Frequency (MHz)				1852.5	1880	1907.5
5	QPSK	1	0	23.05	23.25	23.20



5	QPSK	1	12	23.12	23.23	23.08
5	QPSK	1	24	23.14	23.07	23.05
5	QPSK	12	0	22.31	22.27	22.23
5	QPSK	12	7	22.40	22.39	22.35
5	QPSK	12	13	22.18	22.13	22.16
5	QPSK	25	0	22.25	22.25	22.34
5	16QAM	1	0	22.29	22.59	22.23
5	16QAM	1	12	22.46	22.56	22.52
5	16QAM	1	24	22.46	22.53	22.37
5	16QAM	12	0	22.12	22.12	22.17
5	16QAM	12	7	21.96	21.91	21.95
5	16QAM	12	13	22.02	21.97	22.00
5	16QAM	25	0	21.87	21.83	21.89
Channel				18615	18900	19185
Frequency (MHz)				1851.5	1880	1908.5
3	QPSK	1	0	23.03	23.23	23.12
3	QPSK	1	8	23.14	23.22	23.10
3	QPSK	1	14	23.12	23.10	23.07
3	QPSK	8	0	22.39	22.27	22.28
3	QPSK	8	4	22.33	22.33	22.32
3	QPSK	8	7	22.16	22.11	22.19
3	QPSK	15	0	22.22	22.28	22.30
3	16QAM	1	0	22.26	22.58	22.31
3	16QAM	1	8	22.39	22.48	22.46
3	16QAM	1	14	22.53	22.45	22.41
3	16QAM	8	0	22.15	22.10	22.16
3	16QAM	8	4	21.91	21.90	21.99
3	16QAM	8	7	21.99	21.96	22.00
3	16QAM	15	0	21.92	21.78	21.94
Channel				18607	18900	19193
Frequency (MHz)				1850.7	1880	1909.3
1.4	QPSK	1	0	23.11	23.17	23.05
1.4	QPSK	1	3	23.06	23.07	23.06
1.4	QPSK	1	5	23.06	23.06	23.07
1.4	QPSK	3	0	23.02	23.09	23.03
1.4	QPSK	3	1	23.04	23.06	23.05
1.4	QPSK	3	3	23.16	23.11	23.02
1.4	QPSK	6	0	22.22	22.42	22.26
1.4	16QAM	1	0	22.21	22.33	22.31
1.4	16QAM	1	3	22.10	22.16	22.12
1.4	16QAM	1	5	22.12	22.04	22.01
1.4	16QAM	3	0	22.05	22.22	22.23
1.4	16QAM	3	1	22.06	22.09	22.16
1.4	16QAM	3	3	22.06	22.10	22.15
1.4	16QAM	6	0	21.17	21.21	21.09



LTE Band 4:

BW [MHz]	Modulation	RB Size	RB Offset	Power Low Ch. / Freq.	Power Middle Ch. / Freq.	Power High Ch. / Freq.
Channel				20050	20175	20300
Frequency (MHz)				1720	1732.5	1745
20	QPSK	1	0	23.41	23.42	23.39
20	QPSK	1	49	23.07	23.22	23.11
20	QPSK	1	99	23.12	23.16	23.18
20	QPSK	50	0	22.42	22.37	22.45
20	QPSK	50	24	22.57	22.55	22.58
20	QPSK	50	50	22.42	22.42	22.44
20	QPSK	100	0	22.34	22.37	22.31
20	16QAM	1	0	22.91	22.93	22.88
20	16QAM	1	49	22.82	22.81	22.84
20	16QAM	1	99	22.52	22.56	22.50
Channel				20025	20175	20325
Frequency (MHz)				1717.5	1732.5	1747.5
15	QPSK	1	0	23.35	23.30	23.29
15	QPSK	1	37	23.11	23.07	23.03
15	QPSK	1	74	23.15	23.04	23.06
15	QPSK	36	0	22.27	22.24	22.40
15	QPSK	36	20	22.47	22.44	22.42
15	QPSK	36	39	22.35	22.32	22.29
15	QPSK	75	0	22.26	22.21	22.19
15	16QAM	1	0	22.84	22.83	22.74
15	16QAM	1	37	22.73	22.67	22.79
15	16QAM	1	74	22.37	22.49	22.45
Channel				20000	20175	20350
Frequency (MHz)				1715	1732.5	1750
10	QPSK	1	0	23.31	23.31	23.25
10	QPSK	1	25	23.09	23.11	23.02
10	QPSK	1	49	23.00	23.04	23.11
10	QPSK	25	0	22.32	22.28	22.40
10	QPSK	25	12	22.43	22.50	22.42
10	QPSK	25	25	22.35	22.34	22.30
10	QPSK	50	0	22.28	22.29	22.19
10	16QAM	1	0	22.76	22.81	22.73
10	16QAM	1	25	22.66	22.76	22.69
10	16QAM	1	49	22.44	22.47	22.41
10	16QAM	25	0	21.88	21.78	21.74
10	16QAM	25	12	21.86	21.79	21.85
10	16QAM	25	25	21.78	21.82	21.85
Channel				19975	20175	20375
Frequency (MHz)				1712.5	1732.5	1752.5
5	QPSK	1	0	23.30	23.28	23.25
5	QPSK	1	12	23.10	23.08	23.12
5	QPSK	1	24	23.03	23.03	23.05
5	QPSK	12	0	22.31	22.26	22.40
5	QPSK	12	7	22.52	22.41	22.47
5	QPSK	12	13	22.33	22.33	22.29
5	QPSK	25	0	22.23	22.27	22.21
5	16QAM	1	0	22.75	22.79	22.72
5	16QAM	1	12	22.72	22.76	22.68
5	16QAM	1	24	22.37	22.41	22.44
5	16QAM	12	0	21.84	21.77	21.72



5	16QAM	12	7	21.89	21.76	21.83
5	16QAM	12	13	21.71	21.74	21.78
5	16QAM	25	0	21.65	21.73	21.70
Channel				19965	20175	20385
Frequency (MHz)				1711.5	1732.5	1753.5
3	QPSK	1	0	23.25	23.34	23.33
3	QPSK	1	8	23.04	23.15	23.06
3	QPSK	1	14	23.06	23.04	23.06
3	QPSK	8	0	22.30	22.22	22.33
3	QPSK	8	4	22.43	22.39	22.46
3	QPSK	8	7	22.36	22.29	22.39
3	QPSK	15	0	22.20	22.26	22.16
3	16QAM	1	0	22.77	22.79	22.75
3	16QAM	1	8	22.67	22.67	22.69
3	16QAM	1	14	22.36	22.44	22.39
3	16QAM	8	0	21.82	21.85	21.74
3	16QAM	8	4	21.83	21.80	21.86
3	16QAM	8	7	21.75	21.76	21.78
3	16QAM	15	0	21.63	21.74	21.73
Channel				19957	20175	20393
Frequency (MHz)				1710.7	1732.5	1754.3
1.4	QPSK	1	0	23.34	23.36	23.23
1.4	QPSK	1	3	23.07	23.08	23.10
1.4	QPSK	1	5	23.07	23.10	23.02
1.4	QPSK	3	0	23.22	23.21	23.11
1.4	QPSK	3	1	23.06	23.02	23.02
1.4	QPSK	3	3	23.02	23.01	23.08
1.4	QPSK	6	0	22.25	22.26	22.22
1.4	16QAM	1	0	22.75	22.77	22.77
1.4	16QAM	1	3	22.71	22.76	22.73
1.4	16QAM	1	5	22.40	22.44	22.35
1.4	16QAM	3	0	22.67	22.69	22.68
1.4	16QAM	3	1	22.66	22.70	22.59
1.4	16QAM	3	3	22.27	22.38	22.22
1.4	16QAM	6	0	21.66	21.76	21.75



LTE Band 5:

BW [MHz]	Modulation	RB Size	RB Offset	Power Low Ch. / Freq.	Power Middle Ch. / Freq.	Power High Ch. / Freq.
Channel				20450	20525	20600
Frequency (MHz)				829	836.5	844
10	QPSK	1	0	23.06	23.21	23.04
10	QPSK	1	25	23.21	23.23	23.18
10	QPSK	1	49	23.14	23.17	23.20
10	QPSK	25	0	22.61	22.66	22.74
10	QPSK	25	12	22.43	22.48	22.42
10	QPSK	25	25	22.39	22.32	22.36
10	QPSK	50	0	22.37	22.42	22.26
10	16QAM	1	0	22.18	22.25	22.26
10	16QAM	1	25	22.25	22.19	22.25
10	16QAM	1	49	22.25	22.24	22.25
10	16QAM	25	0	21.20	21.22	21.18
10	16QAM	25	12	21.26	21.23	21.24
10	16QAM	25	25	21.26	21.24	21.29
Channel				20425	20525	20625
Frequency (MHz)				826.5	836.5	846.5
5	QPSK	1	0	23.00	23.07	23.02
5	QPSK	1	12	23.10	23.08	23.05
5	QPSK	1	24	23.04	23.06	23.15
5	QPSK	12	0	22.50	22.61	22.69
5	QPSK	12	7	22.37	22.40	22.34
5	QPSK	12	13	22.28	22.22	22.23
5	QPSK	25	0	22.32	22.33	22.16
5	16QAM	1	0	22.09	22.15	22.13
5	16QAM	1	12	22.14	22.09	22.10
5	16QAM	1	24	22.17	22.16	22.14
5	16QAM	12	0	21.07	21.13	21.08
5	16QAM	12	7	21.13	21.10	21.18
5	16QAM	12	13	21.10	21.09	21.19
5	16QAM	25	0	21.01	21.10	21.00
Channel				20415	20525	20635
Frequency (MHz)				825.5	836.5	847.5
3	QPSK	1	0	23.02	23.13	23.05
3	QPSK	1	8	23.05	23.07	23.03
3	QPSK	1	14	23.01	23.08	23.13
3	QPSK	8	0	22.46	22.61	22.58
3	QPSK	8	4	22.31	22.43	22.28
3	QPSK	8	7	22.30	22.21	22.25
3	QPSK	15	0	22.22	22.36	22.17
3	16QAM	1	0	22.05	22.14	22.11
3	16QAM	1	8	22.10	22.13	22.14
3	16QAM	1	14	22.15	22.08	22.19
3	16QAM	8	0	21.06	21.14	21.04
3	16QAM	8	4	21.14	21.12	21.09
3	16QAM	8	7	21.17	21.16	21.18
3	16QAM	15	0	21.01	21.12	21.01
Channel				20407	20525	20643
Frequency (MHz)				824.7	836.5	848.3
1.4	QPSK	1	0	23.16	23.11	23.02
1.4	QPSK	1	3	23.16	23.18	23.15
1.4	QPSK	1	5	23.09	23.09	23.22





1.4	QPSK	3	0	23.12	23.18	23.06
1.4	QPSK	3	1	23.18	23.17	23.16
1.4	QPSK	3	3	23.12	23.10	23.17
1.4	QPSK	6	0	22.34	22.43	22.36
1.4	16QAM	1	0	22.19	22.27	22.15
1.4	16QAM	1	3	22.18	22.27	22.20
1.4	16QAM	1	5	22.28	22.17	22.31
1.4	16QAM	3	0	22.34	22.42	22.42
1.4	16QAM	3	1	22.37	22.30	22.36
1.4	16QAM	3	3	22.35	22.36	22.31
1.4	16QAM	6	0	21.04	21.17	21.20



LTE Band 12:

BW [MHz]	Modulation	RB Size	RB Offset	Power Low Ch. / Freq.	Power Middle Ch. / Freq.	Power High Ch. / Freq.
Channel				23060	23095	23130
Frequency (MHz)				704	707.5	711
10	QPSK	1	0	23.18	23.31	23.07
10	QPSK	1	25	23.11	23.18	23.03
10	QPSK	1	49	23.16	23.21	23.20
10	QPSK	25	0	22.20	22.34	22.21
10	QPSK	25	12	22.17	22.32	22.19
10	QPSK	25	25	22.03	22.11	22.10
10	QPSK	50	0	22.20	22.11	22.22
10	16QAM	1	0	22.17	22.17	22.19
10	16QAM	1	25	22.12	22.13	22.11
10	16QAM	1	49	22.30	22.31	22.38
10	16QAM	25	0	21.01	21.00	21.08
10	16QAM	25	12	21.04	21.04	21.01
10	16QAM	25	25	21.22	21.21	21.13
Channel				23035	23095	23155
Frequency (MHz)				701.5	707.5	713.5
5	QPSK	1	0	23.06	23.26	23.02
5	QPSK	1	12	23.06	23.10	23.02
5	QPSK	1	24	23.03	23.09	23.09
5	QPSK	12	0	22.12	22.25	22.06
5	QPSK	12	7	22.04	22.25	22.11
5	QPSK	12	13	22.01	22.02	22.01
5	QPSK	25	0	22.13	22.03	22.17
5	16QAM	1	0	22.02	22.06	22.08
5	16QAM	1	12	22.00	22.04	22.03
5	16QAM	1	24	22.15	22.25	22.25
5	16QAM	12	0	21.07	21.14	21.03
5	16QAM	12	7	21.02	21.05	21.03
5	16QAM	12	13	21.17	21.12	21.00
5	16QAM	25	0	21.06	21.03	21.15
Channel				23025	23095	23165
Frequency (MHz)				700.5	707.5	714.5
3	QPSK	1	0	23.10	23.22	23.02
3	QPSK	1	8	23.01	23.03	23.01
3	QPSK	1	14	23.11	23.14	23.10
3	QPSK	8	0	22.04	22.21	22.16
3	QPSK	8	4	22.10	22.24	22.12
3	QPSK	8	7	22.06	22.07	22.04
3	QPSK	15	0	22.12	22.02	22.11
3	16QAM	1	0	22.05	22.04	22.03
3	16QAM	1	8	22.05	22.03	22.05
3	16QAM	1	14	22.20	22.20	22.25
3	16QAM	8	0	21.02	21.02	21.16
3	16QAM	8	4	21.05	21.03	21.00
3	16QAM	8	7	21.06	21.09	21.06
3	16QAM	15	0	21.08	21.03	21.07
Channel				23017	23095	23173
Frequency (MHz)				699.7	707.5	715.3
1.4	QPSK	1	0	23.11	23.16	23.12
1.4	QPSK	1	3	23.13	23.17	23.16
1.4	QPSK	1	5	23.23	23.22	23.26



1.4	QPSK	3	0	23.27	23.30	23.30
1.4	QPSK	3	1	23.04	23.07	23.02
1.4	QPSK	3	3	23.13	23.17	23.14
1.4	QPSK	6	0	22.02	22.01	22.03
1.4	16QAM	1	0	22.14	22.16	22.21
1.4	16QAM	1	3	22.13	22.22	22.27
1.4	16QAM	1	5	22.25	22.29	22.29
1.4	16QAM	3	0	22.04	22.08	22.13
1.4	16QAM	3	1	22.03	22.04	22.06
1.4	16QAM	3	3	22.19	22.14	22.17
1.4	16QAM	6	0	21.28	21.30	21.24



LTE Band 13:

BW [MHz]	Modulation	RB Size	RB Offset	Power Low Ch. / Freq.	Power Middle Ch. / Freq.	Power High Ch. / Freq.
Channel				23230		
Frequency (MHz)				782		
10	QPSK	1	0		23.15	
10	QPSK	1	25		23.02	
10	QPSK	1	49		23.01	
10	QPSK	25	0		22.02	
10	QPSK	25	12		22.15	
10	QPSK	25	25		22.33	
10	QPSK	50	0		22.21	
10	16QAM	1	0		22.24	
10	16QAM	1	25		22.33	
10	16QAM	1	49		22.27	
10	16QAM	25	0		21.12	
10	16QAM	25	12		21.31	
10	16QAM	25	25		21.39	
Channel				23205	23230	23255
Frequency (MHz)				779.5	782	784.5
5	QPSK	1	0	23.12	23.01	23.06
5	QPSK	1	12	23.07	23.06	23.06
5	QPSK	1	24	23.08	23.07	23.03
5	QPSK	12	0	22.03	22.06	22.04
5	QPSK	12	7	22.01	22.02	22.07
5	QPSK	12	13	22.25	22.28	22.20
5	QPSK	25	0	22.07	22.13	22.11
5	16QAM	1	0	22.18	22.16	22.19
5	16QAM	1	12	22.28	22.24	22.20
5	16QAM	1	24	22.17	22.12	22.19
5	16QAM	12	0	21.07	21.05	21.02
5	16QAM	12	7	21.18	21.17	21.26
5	16QAM	12	13	21.27	21.32	21.24
5	16QAM	25	0	21.33	21.25	21.26



**ERP/EIRP**

LTE Band 2 (GT - LC = 2.56 dB) QPSK									
Bandwidth	1.4M			3M			5M		
Channel	18607	18900	19193	18615	18900	19185	18625	18900	19175
	(Low)	(Mid)	(High)	(Low)	(Mid)	(High)	(Low)	(Mid)	(High)
Frequency	1850.7	1880	1909.3	1851.5	1880	1908.5	1852.5	1880	1907.5
(MHz)									
Conducted Power (dBm)	23.11	23.17	23.05	23.03	23.23	23.12	23.05	23.25	23.20
Conducted Power (Watts)	0.2046	0.2075	0.2018	0.2009	0.2104	0.2051	0.2018	0.2113	0.2089
EIRP(dBm)	25.67	25.73	25.61	25.59	25.79	25.68	25.61	25.81	25.76
EIRP(Watts)	0.3690	0.3741	0.3639	0.3622	0.3793	0.3698	0.3639	0.3811	0.3767

LTE Band 2 (GT - LC = 2.56 dB) QPSK									
Bandwidth	10M			15M			20M		
Channel	18650	18900	19150	18675	18900	19125	18650	18900	19100
	(Low)	(Mid)	(High)	(Low)	(Mid)	(High)	(Low)	(Mid)	(High)
Frequency	1855	1880	1905	1857.5	1880	1902.5	1860	1880	1900
(MHz)									
Conducted Power (dBm)	23.05	23.19	23.11	23.11	23.18	23.13	23.18	23.31	23.26
Conducted Power (Watts)	0.2018	0.2084	0.2046	0.2046	0.2080	0.2056	0.2080	0.2143	0.2118
EIRP(dBm)	25.61	25.75	25.67	25.67	25.74	25.69	25.74	25.87	25.82
EIRP(Watts)	0.3639	0.3758	0.3690	0.3690	0.3750	0.3707	0.3750	0.3864	0.3819



LTE Band 2 (GT - LC = 2.56 dB) 16QAM									
Bandwidth	1.4M			3M			5M		
Channel	18607	18900	19193	18615	18900	19185	18625	18900	19175
	(Low)	(Mid)	(High)	(Low)	(Mid)	(High)	(Low)	(Mid)	(High)
Frequency (MHz)	1850.7	1880	1909.3	1851.5	1880	1908.5	1852.5	1880	1907.5
Conducted Power (dBm)	22.21	22.33	22.31	22.26	22.58	22.31	22.29	22.59	22.23
Conducted Power (Watts)	0.1663	0.1710	0.1702	0.1683	0.1811	0.1702	0.1694	0.1816	0.1671
EIRP(dBm)	24.77	24.89	24.87	24.82	25.14	24.87	24.85	25.15	24.79
EIRP(Watts)	0.2999	0.3083	0.3069	0.3034	0.3266	0.3069	0.3055	0.3273	0.3013

LTE Band 2 (GT - LC = 2.56 dB) 16QAM									
Bandwidth	10M			15M			20M		
Channel	18650	18900	19150	18675	18900	19125	18650	18900	19100
	(Low)	(Mid)	(High)	(Low)	(Mid)	(High)	(Low)	(Mid)	(High)
Frequency (MHz)	1855	1880	1905	1857.5	1880	1902.5	1860	1880	1900
Conducted Power (dBm)	22.36	22.68	22.31	22.33	22.64	22.29	22.41	22.73	22.36
Conducted Power (Watts)	0.1722	0.1854	0.1702	0.1710	0.1837	0.1694	0.1742	0.1875	0.1722
EIRP(dBm)	24.92	25.24	24.87	24.89	25.20	24.85	24.97	25.29	24.92
EIRP(Watts)	0.3105	0.3342	0.3069	0.3083	0.3311	0.3055	0.3141	0.3381	0.3105



LTE Band 4 (GT - LC = 3.13 dB) QPSK									
Bandwidth	1.4M			3M			5M		
Channel	19957	20175	20393	19965	20175	20385	19975	20175	20375
	(Low)	(Mid)	(High)	(Low)	(Mid)	(High)	(Low)	(Mid)	(High)
Frequency (MHz)	1710.7	1732.5	1754.3	1711.5	1732.5	1753.5	1712.5	1732.5	1752.5
Conducted Power (dBm)	23.34	23.36	23.23	23.25	23.34	23.33	23.30	23.28	23.25
Conducted Power (Watts)	0.2158	0.2168	0.2104	0.2113	0.2158	0.2153	0.2138	0.2128	0.2113
EIRP(dBm)	26.47	26.49	26.36	26.38	26.47	26.46	26.43	26.41	26.38
EIRP(Watts)	0.4436	0.4457	0.4325	0.4345	0.4436	0.4426	0.4395	0.4375	0.4345

LTE Band 4 (GT - LC = 3.13 dB) QPSK									
Bandwidth	10M			15M			20M		
Channel	20000	20175	20350	20025	20175	20325	20050	20175	20300
	(Low)	(Mid)	(High)	(Low)	(Mid)	(High)	(Low)	(Mid)	(High)
Frequency (MHz)	1715	1732.5	1750	1717.5	1732.5	1747.5	1720	1732.5	1745
Conducted Power (dBm)	23.31	23.31	23.25	23.35	23.30	23.29	23.41	23.42	23.39
Conducted Power (Watts)	0.2143	0.2143	0.2113	0.2163	0.2138	0.2133	0.2193	0.2198	0.2183
EIRP(dBm)	26.44	26.44	26.38	26.48	26.43	26.42	26.54	26.55	26.52
EIRP(Watts)	0.4406	0.4406	0.4345	0.4446	0.4395	0.4385	0.4508	0.4519	0.4487



LTE Band 4 (GT - LC = 3.13 dB) 16QAM									
Bandwidth	1.4M			3M			5M		
Channel	19957	20175	20393	19965	20175	20385	19975	20175	20375
	(Low)	(Mid)	(High)	(Low)	(Mid)	(High)	(Low)	(Mid)	(High)
Frequency (MHz)	1710.7	1732.5	1754.3	1711.5	1732.5	1753.5	1712.5	1732.5	1752.5
Conducted Power (dBm)	22.75	22.77	22.77	22.77	22.79	22.75	22.75	22.79	22.72
Conducted Power (Watts)	0.1884	0.1892	0.1892	0.1892	0.1901	0.1884	0.1884	0.1901	0.1871
EIRP(dBm)	25.88	25.90	25.90	25.90	25.92	25.88	25.88	25.92	25.85
EIRP(Watts)	0.3873	0.3890	0.3890	0.3890	0.3908	0.3873	0.3873	0.3908	0.3846

LTE Band 4 (GT - LC = 3.13 dB) 16QAM									
Bandwidth	10M			15M			20M		
Channel	20000	20175	20350	20025	20175	20325	20050	20175	20300
	(Low)	(Mid)	(High)	(Low)	(Mid)	(High)	(Low)	(Mid)	(High)
Frequency (MHz)	1715	1732.5	1750	1717.5	1732.5	1747.5	1720	1732.5	1745
Conducted Power (dBm)	22.76	22.81	22.73	22.84	22.83	22.74	22.91	22.93	22.88
Conducted Power (Watts)	0.1888	0.1910	0.1875	0.1923	0.1919	0.1879	0.1954	0.1963	0.1941
EIRP(dBm)	25.89	25.94	25.86	25.97	25.96	25.87	26.04	26.06	26.01
EIRP(Watts)	0.3882	0.3926	0.3855	0.3954	0.3945	0.3864	0.4018	0.4036	0.3990





LTE Band 5 (GT - LC = 0.85 dB) QPSK									
Bandwidth	1.4M			3M			5M		
Channel	20407	20525	20643	20415	20525	20635	20425	20525	20625
	(Low)	(Mid)	(High)	(Low)	(Mid)	(High)	(Low)	(Mid)	(High)
Frequency (MHz)	824.7	836.5	848.3	825.5	836.5	847.5	826.5	836.5	846.5
Conducted Power (dBm)	23.09	23.09	23.22	23.02	23.13	23.05	23.04	23.06	23.15
Conducted Power (Watts)	0.2037	0.2037	0.2099	0.2004	0.2056	0.2018	0.2014	0.2023	0.2065
ERP(dBm)	21.79	21.79	21.92	21.72	21.83	21.75	21.74	21.76	21.85
ERP(Watts)	0.1510	0.1510	0.1556	0.1486	0.1524	0.1496	0.1493	0.1500	0.1531

LTE Band 5 (GT - LC = 0.85 dB) QPSK			
Bandwidth	10M		
Channel	20450	20525	20600
	(Low)	(Mid)	(High)
Frequency (MHz)	829	836.5	844
Conducted Power (dBm)	23.21	23.23	23.18
Conducted Power (Watts)	0.2094	0.2104	0.2080
ERP(dBm)	21.91	21.93	21.88
ERP(Watts)	0.1552	0.1560	0.1542



LTE Band 5 (GT - LC = 0.85 dB) 16QAM									
Bandwidth	1.4M			3M			5M		
Channel	20407	20525	20643	20415	20525	20635	20425	20525	20625
	(Low)	(Mid)	(High)	(Low)	(Mid)	(High)	(Low)	(Mid)	(High)
Frequency (MHz)	824.7	836.5	848.3	825.5	836.5	847.5	826.5	836.5	846.5
Conducted Power (dBm)	22.34	22.42	22.42	22.15	22.08	22.19	22.17	22.16	22.14
Conducted Power (Watts)	0.1714	0.1746	0.1746	0.1641	0.1614	0.1656	0.1648	0.1644	0.1637
ERP(dBm)	21.04	21.12	21.12	20.85	20.78	20.89	20.87	20.86	20.84
ERP(Watts)	0.1271	0.1294	0.1294	0.1216	0.1197	0.1227	0.1222	0.1219	0.1213

LTE Band 5 (GT - LC = 0.85 dB) 16QAM			
Bandwidth	10M		
Channel	20450	20525	20600
	(Low)	(Mid)	(High)
Frequency (MHz)	829	836.5	844
Conducted Power (dBm)	22.18	22.25	22.26
Conducted Power (Watts)	0.1652	0.1679	0.1683
ERP(dBm)	20.88	20.95	20.96
ERP(Watts)	0.1225	0.1245	0.1247



LTE Band 12 (GT - LC = 0.33 dB) QPSK									
Bandwidth	1.4M			3M			5M		
Channel	23017	23095	23173	23025	23095	23165	23035	23095	23155
	(Low)	(Mid)	(High)	(Low)	(Mid)	(High)	(Low)	(Mid)	(High)
Frequency (MHz)	699.7	707.5	715.3	700.5	707.5	714.5	701.5	707.5	713.5
Conducted Power (dBm)	23.27	23.30	23.30	23.10	23.22	23.02	23.06	23.26	23.02
Conducted Power (Watts)	0.2123	0.2138	0.2138	0.2042	0.2099	0.2004	0.2023	0.2118	0.2004
ERP(dBm)	21.45	21.48	21.48	21.28	21.40	21.20	21.24	21.44	21.20
ERP(Watts)	0.1396	0.1406	0.1406	0.1343	0.1380	0.1318	0.1330	0.1393	0.1318

LTE Band 12 (GT - LC = 0.33 dB) QPSK			
Bandwidth	10M		
Channel	23060	23095	23130
	(Low)	(Mid)	(High)
Frequency (MHz)	704	707.5	711
Conducted Power (dBm)	23.18	23.31	23.07
Conducted Power (Watts)	0.2080	0.2143	0.2028
ERP(dBm)	21.36	21.49	21.25
ERP(Watts)	0.1368	0.1409	0.1334



LTE Band 12 (GT - LC = 0.33 dB) 16QAM									
Bandwidth	1.4M			3M			5M		
Channel	23017	23095	23173	23025	23095	23165	23035	23095	23155
	(Low)	(Mid)	(High)	(Low)	(Mid)	(High)	(Low)	(Mid)	(High)
Frequency (MHz)	699.7	707.5	715.3	700.5	707.5	714.5	701.5	707.5	713.5
Conducted Power (dBm)	22.25	22.29	22.29	22.20	22.20	22.25	22.15	22.25	22.25
Conducted Power (Watts)	0.1679	0.1694	0.1694	0.1660	0.1660	0.1679	0.1641	0.1679	0.1679
ERP(dBm)	20.43	20.47	20.47	20.38	20.38	20.43	20.33	20.43	20.43
ERP(Watts)	0.1104	0.1114	0.1114	0.1091	0.1091	0.1104	0.1079	0.1104	0.1104

LTE Band 12 (GT - LC = 0.33 dB) 16QAM			
Bandwidth	10M		
Channel	23060	23095	23130
	(Low)	(Mid)	(High)
Frequency (MHz)	704	707.5	711
Conducted Power (dBm)	22.30	22.31	22.38
Conducted Power (Watts)	0.1698	0.1702	0.1730
ERP(dBm)	20.48	20.49	20.56
ERP(Watts)	0.1117	0.1119	0.1138



LTE Band 13 (GT - LC = 1.49 dB) QPSK						
Bandwidth	5M			10M		
Channel	23205	23230	23255	23230		
	(Low)	(Mid)	(High)	-	(Mid)	-
Frequency	779.5	782	784.5	-	782	-
(MHz)						
Conducted Power (dBm)	23.12	23.01	23.06		23.15	-
Conducted Power (Watts)	0.2051	0.2000	0.2023		0.2065	-
ERP(dBm)	22.46	22.35	22.40		22.49	-
ERP(Watts)	0.1762	0.1718	0.1738		0.1774	-

LTE Band 13 (GT - LC = 1.49 dB) 16QAM						
Bandwidth	5M			10M		
Channel	23205	23230	23255	23230		
	(Low)	(Mid)	(High)	-	(Mid)	-
Frequency	779.5	782	784.5	-	782	-
(MHz)						
Conducted Power (dBm)	22.28	22.24	22.20		22.33	-
Conducted Power (Watts)	0.1690	0.1675	0.1660		0.1710	-
ERP(dBm)	21.62	21.58	21.54		21.67	-
ERP(Watts)	0.1452	0.1439	0.1426		0.1469	-



# LTE Band 2

## Peak-to-Average Ratio

Mode	LTE Band 2 / 20MHz			
Mod.	QPSK			Limit: 13dB
RB Size	Full RB			Result
Middle CH	5.54			PASS

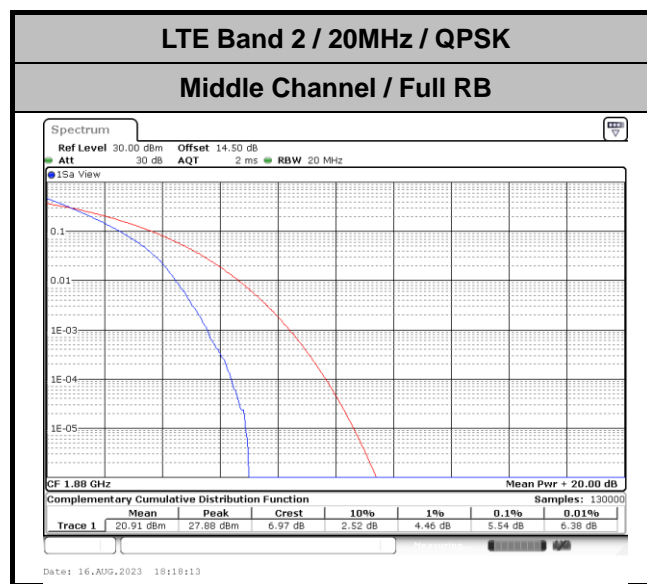



## 26dB Bandwidth

Mode	LTE Band 2 : 26dB BW(MHz)											
	1.4MHz		3MHz		5MHz		10MHz		15MHz		20MHz	
Mod.	QPSK	16QAM	QPSK	16QAM	QPSK	16QAM	QPSK	16QAM	QPSK	16QAM	QPSK	16QAM
Middle CH	1.26	1.24	2.97	2.97	4.87	4.86	9.81	5.63	14.15	5.63	18.74	5.79



LTE Band 2

Middle Channel / 1.4MHz / QPSK

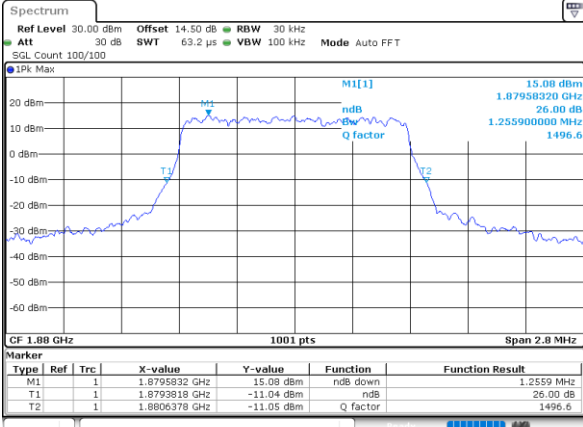

Date: 16\_AUG.2023 16:37:13

Middle Channel / 1.4MHz / 16QAM

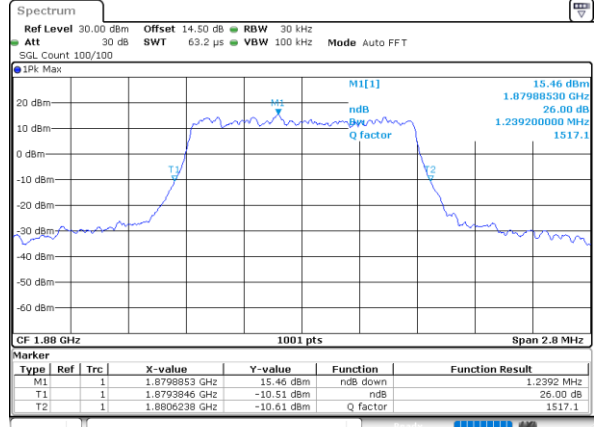

Date: 16\_AUG.2023 16:37:58

Middle Channel / 3MHz / QPSK

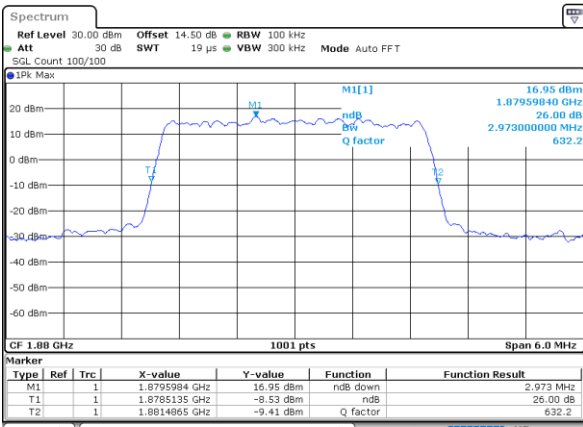

Date: 16\_AUG.2023 16:59:58

Middle Channel / 3MHz / 16QAM

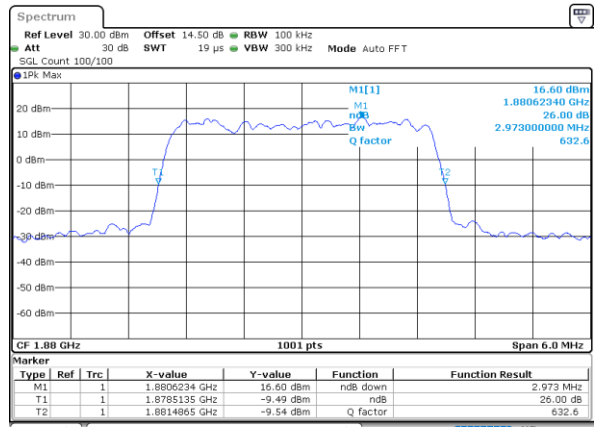

Date: 16\_AUG.2023 17:00:48

Middle Channel / 5MHz / QPSK

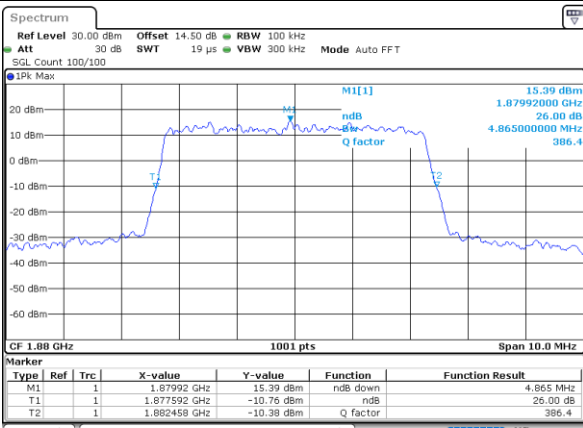

Date: 16\_AUG.2023 17:18:37

Middle Channel / 5MHz / 16QAM

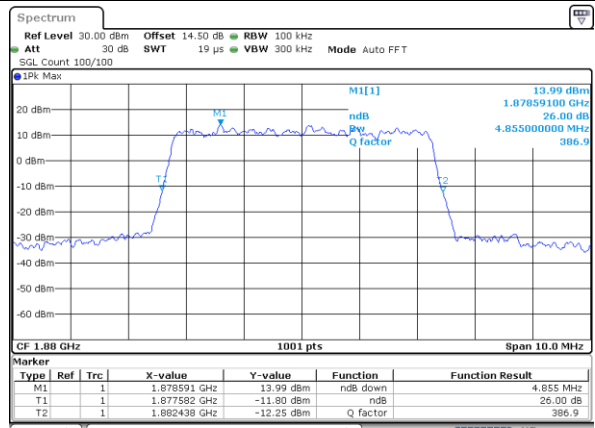

Date: 16\_AUG.2023 17:19:27





LTE Band 2

Middle Channel / 10MHz / QPSK

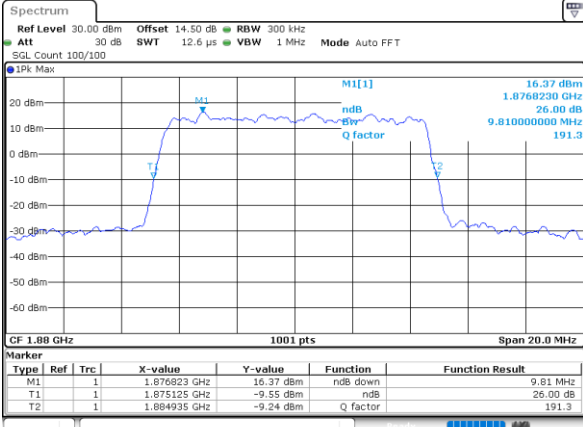

Date: 16.AUG.2023 17:34:03

Middle Channel / 10MHz / 16QAM

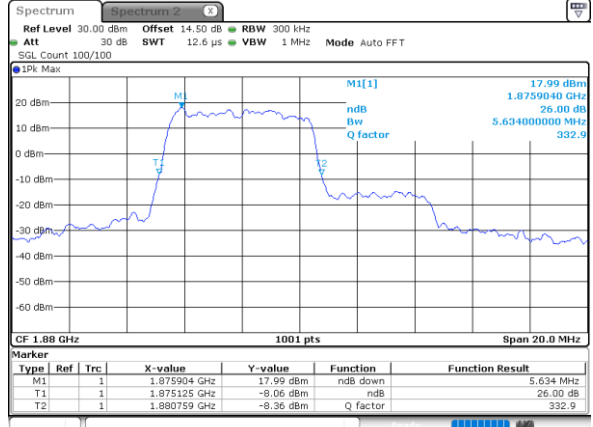

Date: 29.AUG.2023 16:18:30

Middle Channel / 15MHz / QPSK

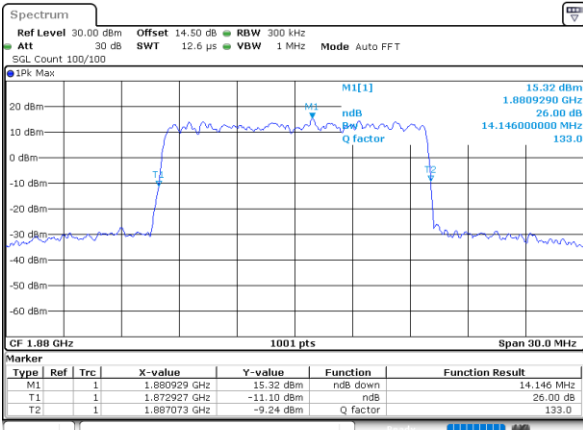

Date: 16.AUG.2023 17:54:49

Middle Channel / 15MHz / 16QAM

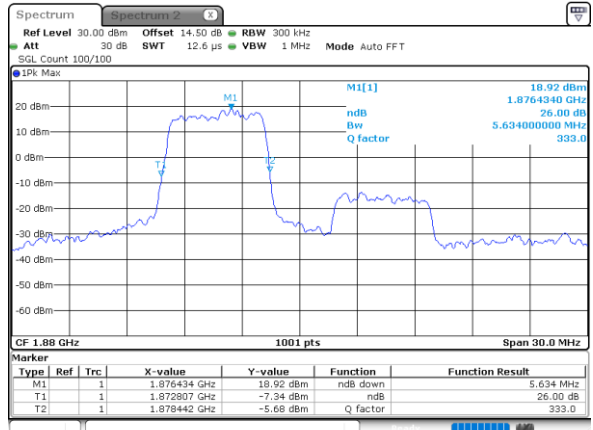

Date: 29.AUG.2023 16:24:12

Middle Channel / 20MHz / QPSK

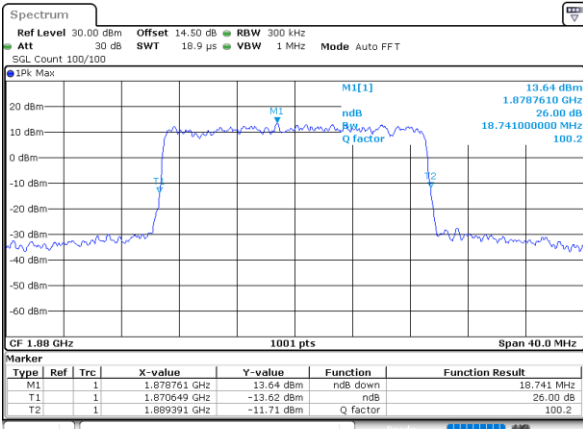

Date: 16.AUG.2023 18:14:36

Middle Channel / 20MHz / 16QAM

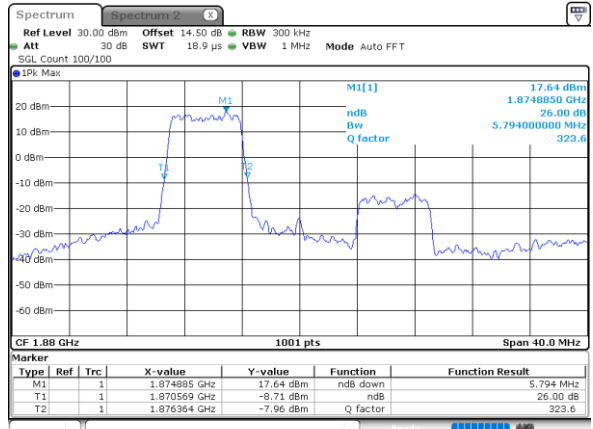

Date: 29.AUG.2023 16:26:12



### Occupied Bandwidth

Mode	LTE Band 2 : 99%OBW(MHz)											
	1.4MHz		3MHz		5MHz		10MHz		15MHz		20MHz	
Mod.	QPSK	16QAM	QPSK	16QAM	QPSK	16QAM	QPSK	16QAM	QPSK	16QAM	QPSK	16QAM
Middle CH	1.09	1.09	2.72	2.70	4.50	4.48	9.03	5.03	13.43	5.00	17.86	5.11



LTE Band 2

Middle Channel / 1.4MHz / QPSK

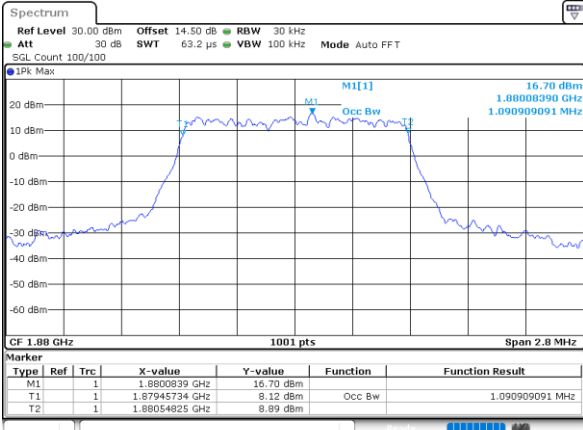

Date: 16.AUG.2023 16:36:58

Middle Channel / 1.4MHz / 16QAM

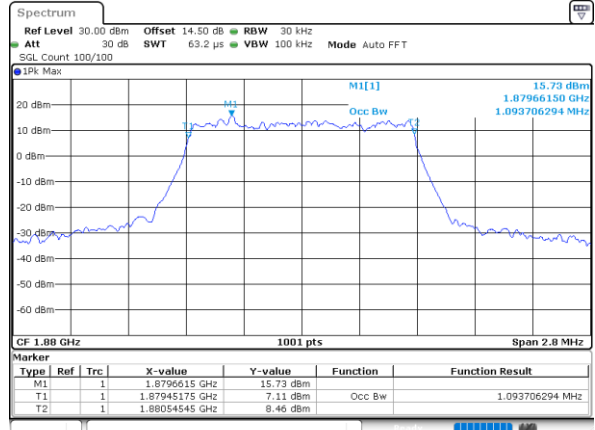

Date: 16.AUG.2023 16:37:44

Middle Channel / 3MHz / QPSK

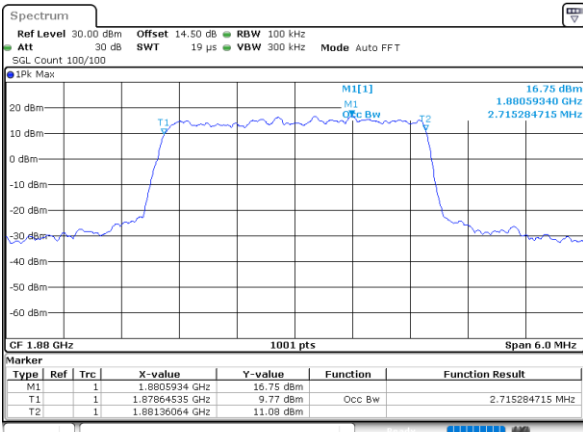

Date: 16.AUG.2023 16:59:44

Middle Channel / 3MHz / 16QAM

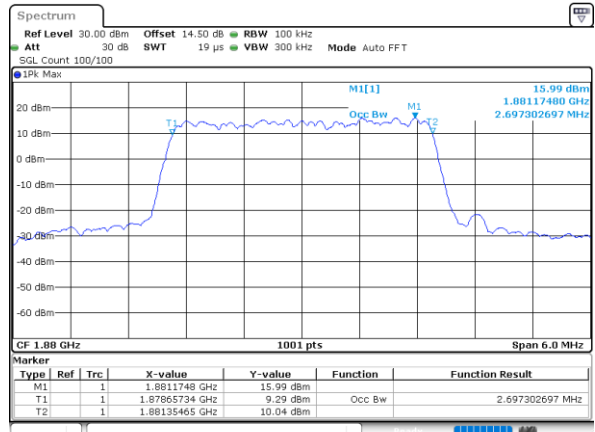

Date: 16.AUG.2023 17:00:34

Middle Channel / 5MHz / QPSK

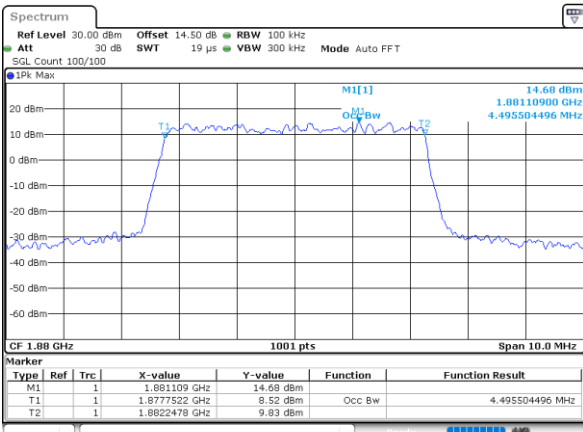

Date: 16.AUG.2023 17:18:23

Middle Channel / 5MHz / 16QAM

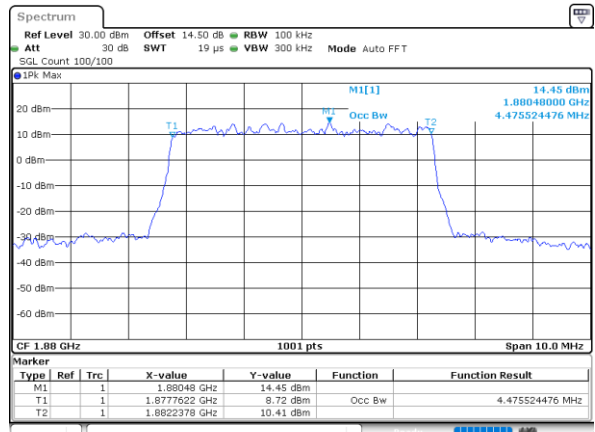

Date: 16.AUG.2023 17:19:13



LTE Band 2

Middle Channel / 10MHz / QPSK

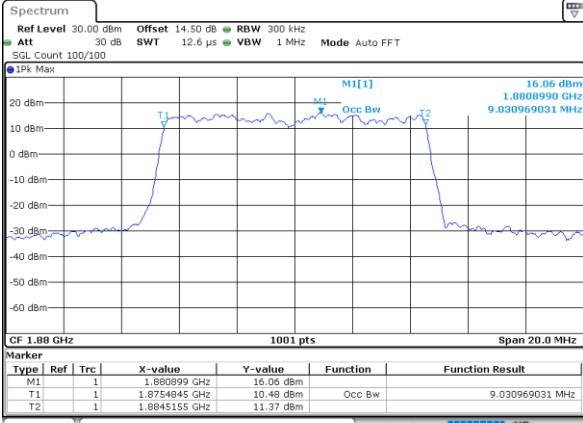

Date: 16\_AUG.2023 17:33:49

Middle Channel / 10MHz / 16QAM

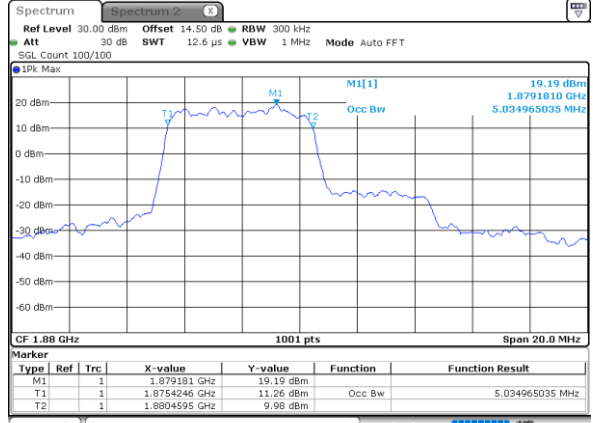

Date: 29\_AUG.2023 16:18:09

Middle Channel / 15MHz / QPSK

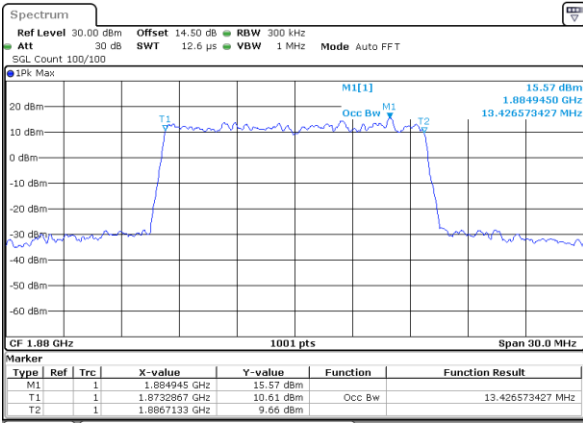

Date: 16\_AUG.2023 17:54:05

Middle Channel / 15MHz / 16QAM

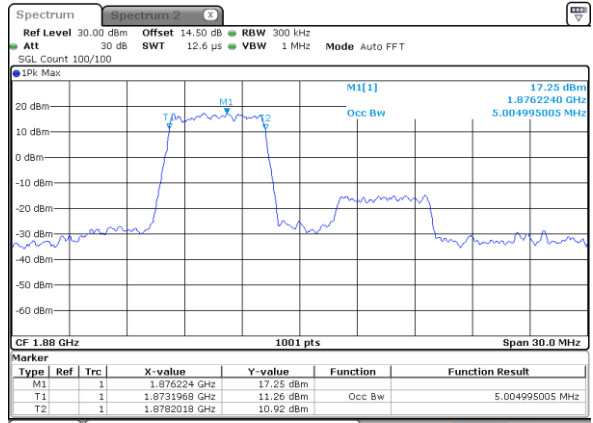

Date: 29\_AUG.2023 16:23:54

Middle Channel / 20MHz / QPSK

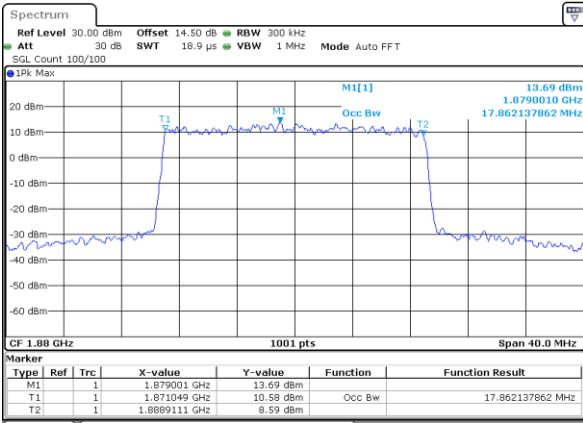

Date: 16\_AUG.2023 18:14:22

Middle Channel / 20MHz / 16QAM

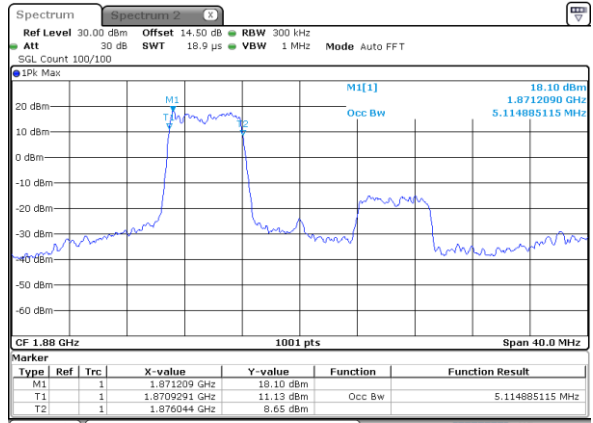

Date: 29\_AUG.2023 16:26:03



# Conducted Band Edge

## LTE Band 2 / 1.4MHz / QPSK

### Lowest Band Edge / 1RB

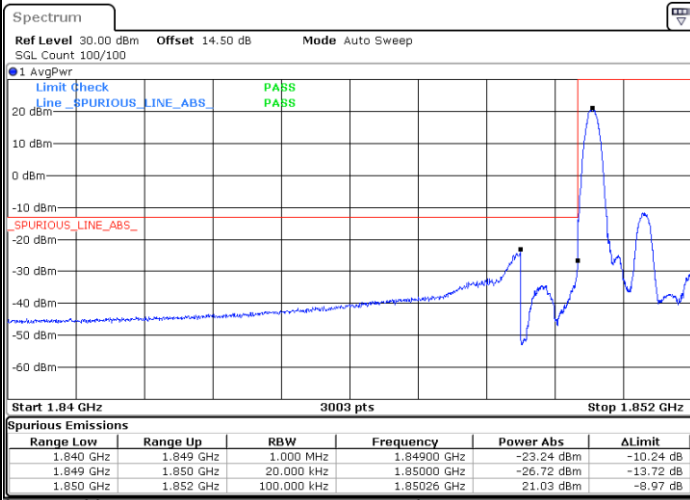

Date: 16.AUG.2023 16:27:34

### Highest Band Edge / 1RB



Date: 16.AUG.2023 16:39:13

### Lowest Band Edge / Full RB

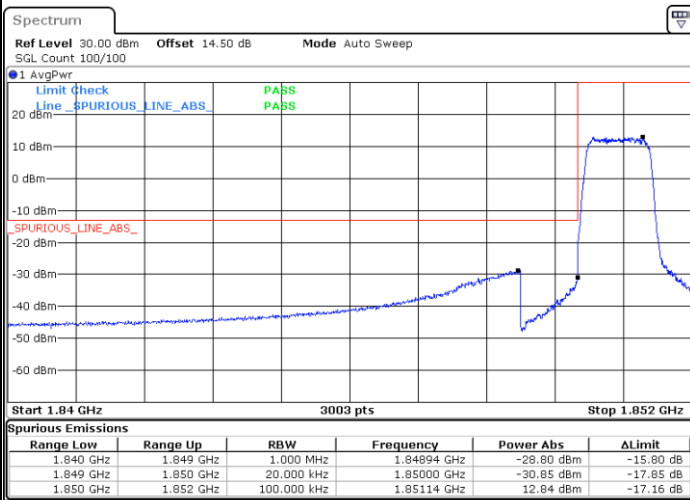

Date: 16.AUG.2023 16:32:39

### Highest Band Edge / Full RB

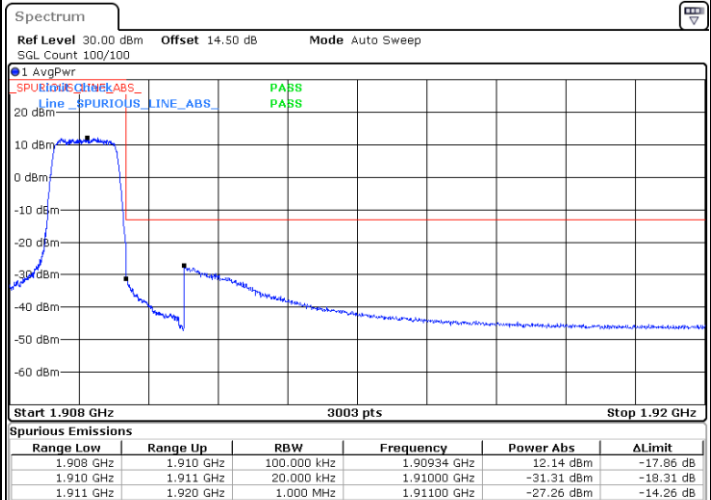

Date: 16.AUG.2023 16:44:17



LTE Band 2 / 1.4MHz / 16QAM

Lowest Band Edge / 1 RB

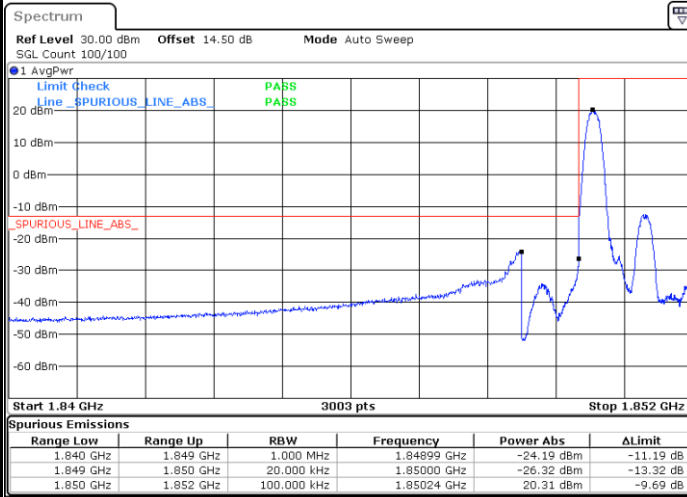

Date: 16.AUG.2023 16:28:50

Highest Band Edge / 1 RB



Date: 16.AUG.2023 16:40:29

Lowest Band Edge / Full RB

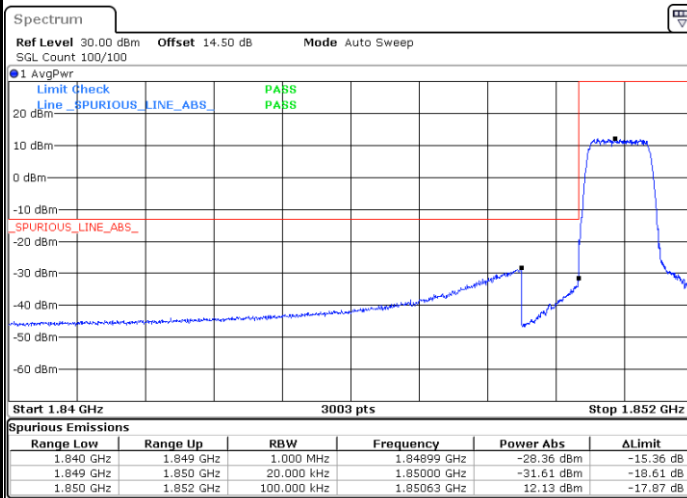

Date: 16.AUG.2023 16:33:55

Highest Band Edge / Full RB

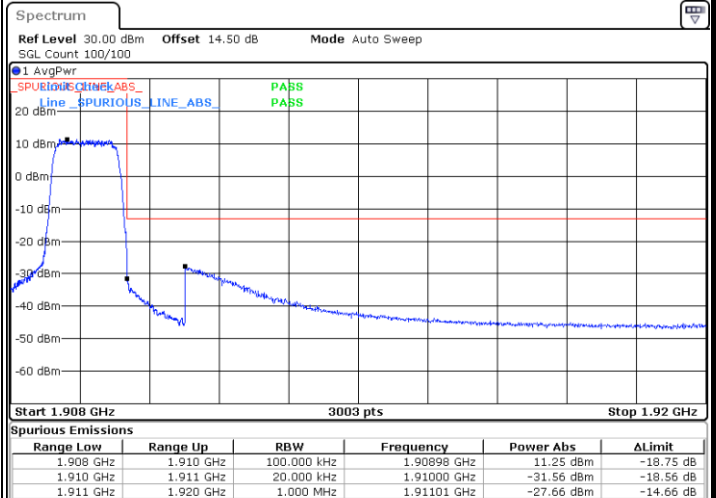

Date: 16.AUG.2023 16:45:33



LTE Band 2 / 3MHz / QPSK

Lowest Band Edge / 1RB

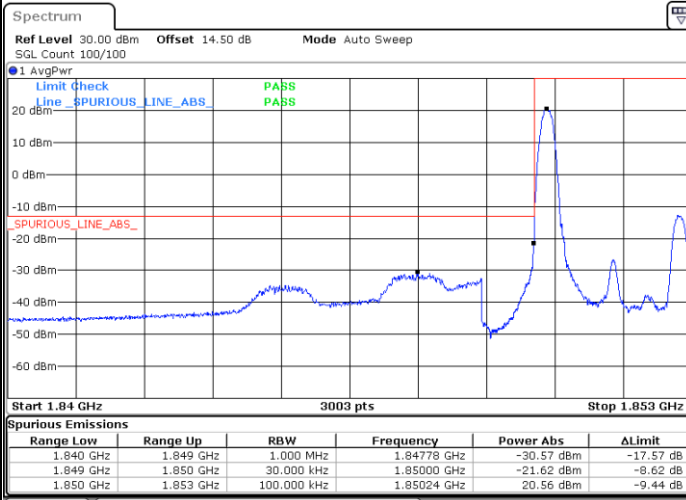

Date: 16.AUG.2023 16:48:11

Highest Band Edge / 1RB

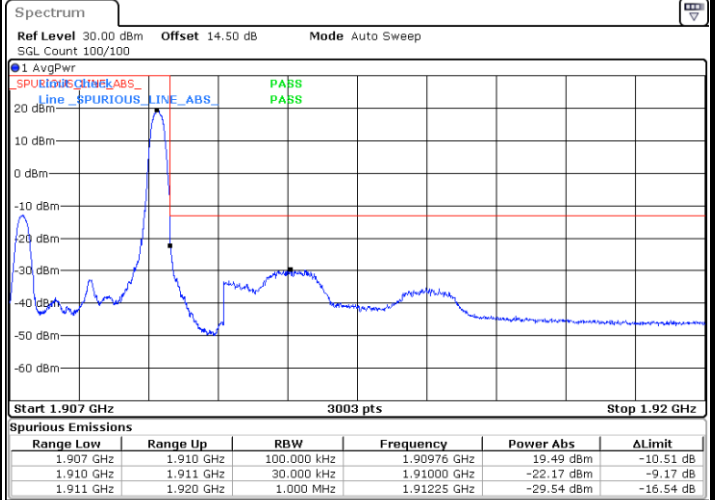

Date: 16.AUG.2023 17:01:43

Lowest Band Edge / Full RB

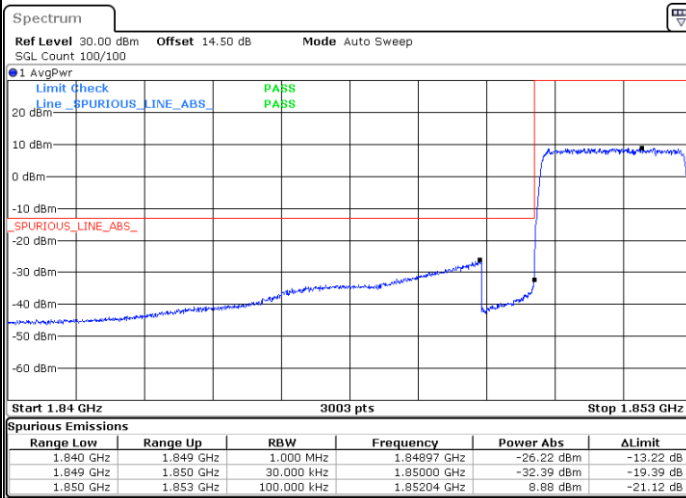

Date: 16.AUG.2023 16:53:16

Highest Band Edge / Full RB

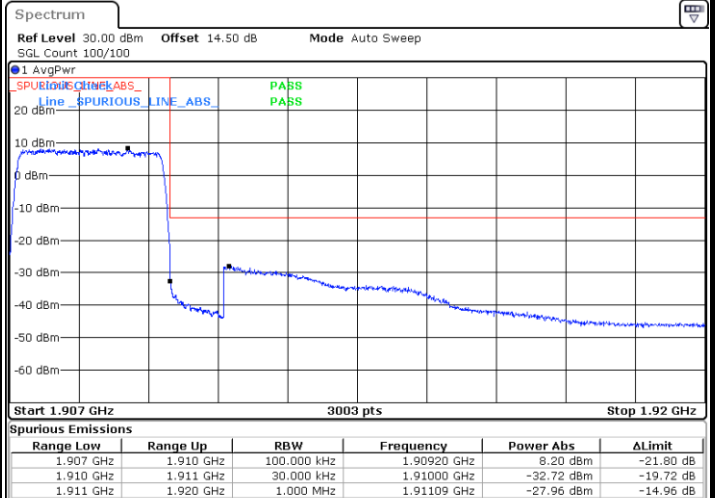

Date: 16.AUG.2023 17:04:32



LTE Band 2 / 3MHz / 16QAM

Lowest Band Edge / 1 RB

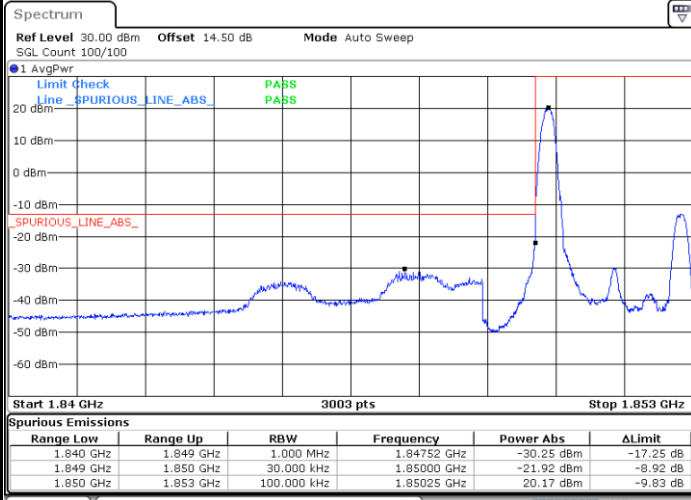

Highest Band Edge / 1 RB

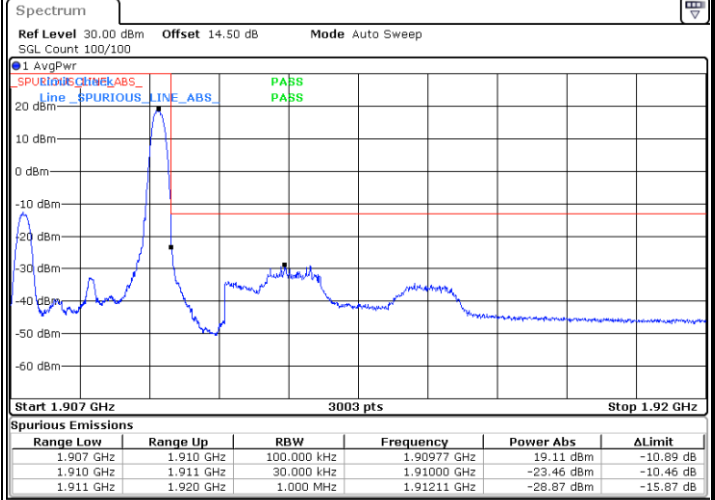

Lowest Band Edge / Full RB

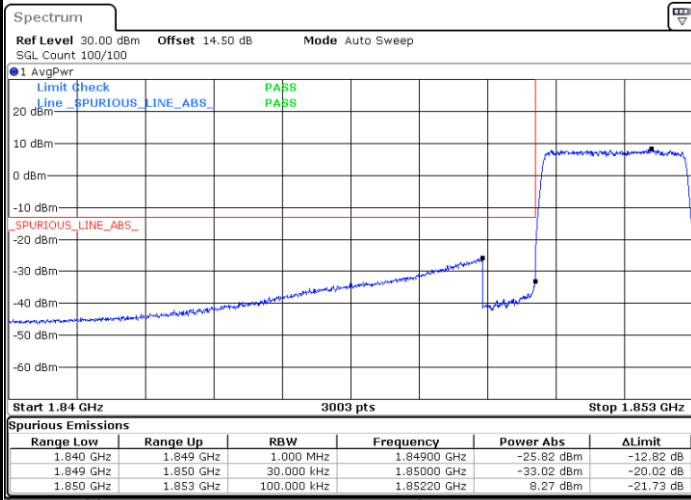

Highest Band Edge / Full RB

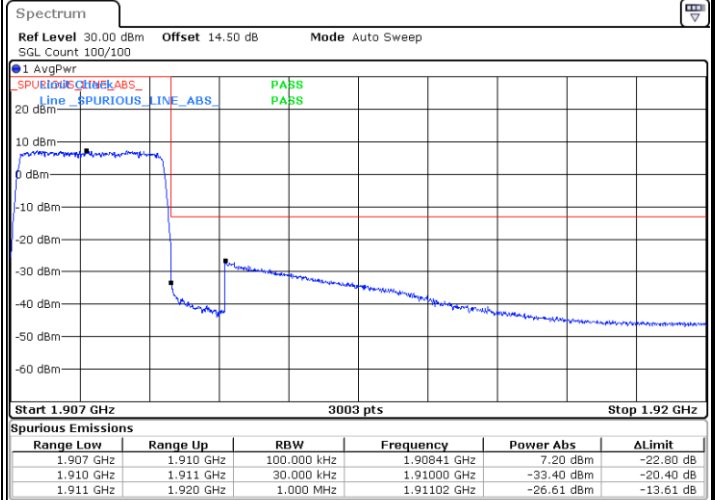





LTE Band 2 / 5MHz / QPSK

Lowest Band Edge / 1RB

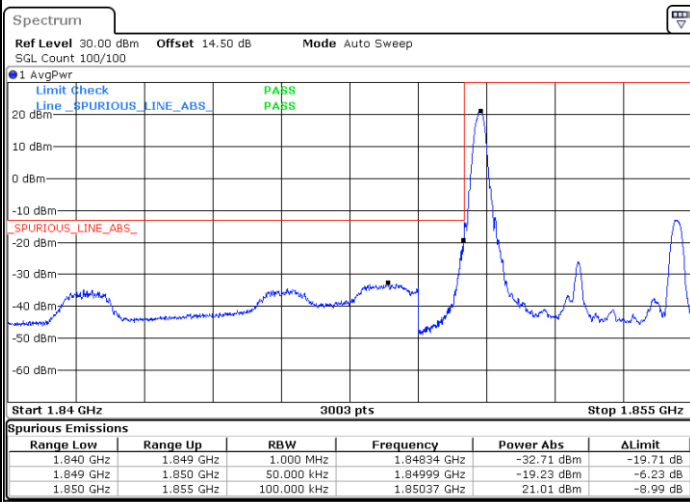

Date: 16.AUG.2023 17:12:16

Highest Band Edge / 1RB

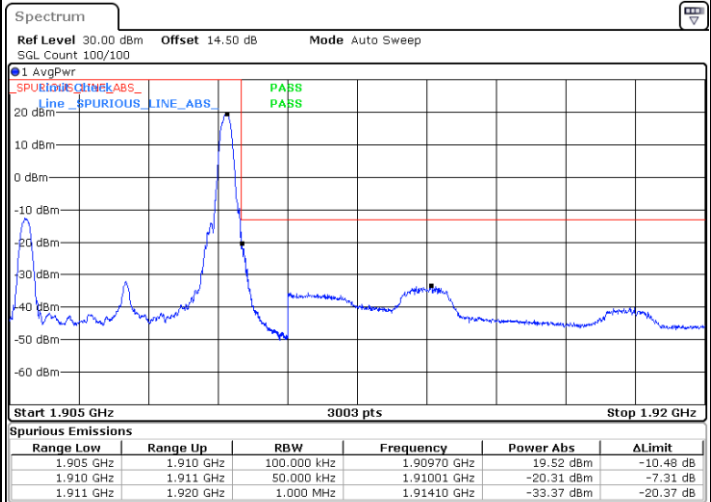

Date: 16.AUG.2023 17:20:22

Lowest Band Edge / Full RB

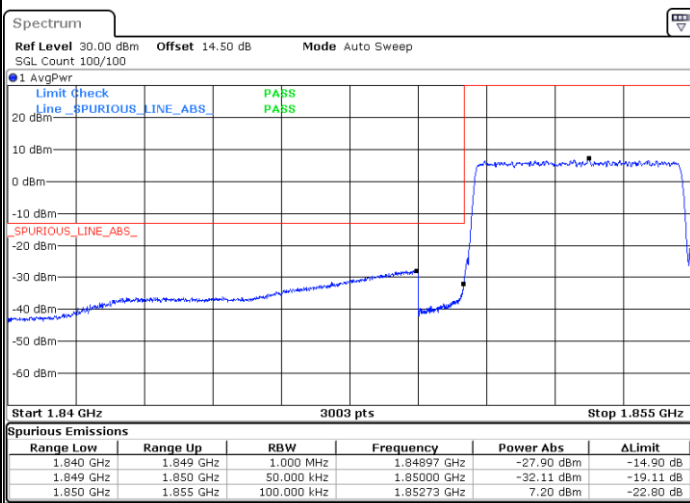

Date: 16.AUG.2023 17:15:29

Highest Band Edge / Full RB

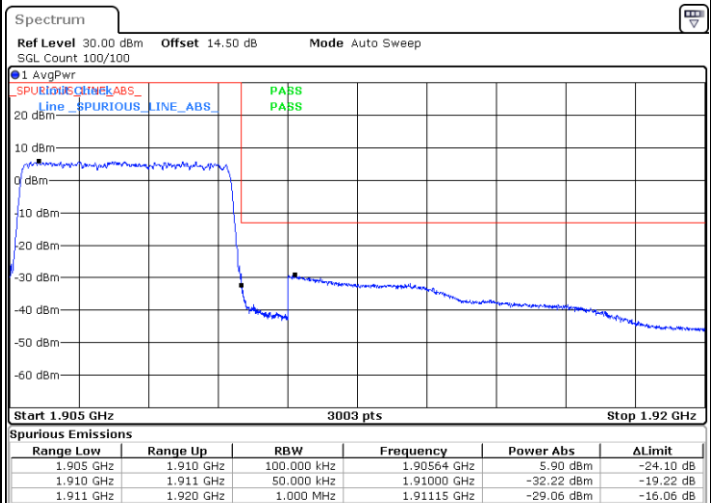

Date: 16.AUG.2023 17:22:14



LTE Band 2 / 5MHz / 16QAM

Lowest Band Edge / 1 RB

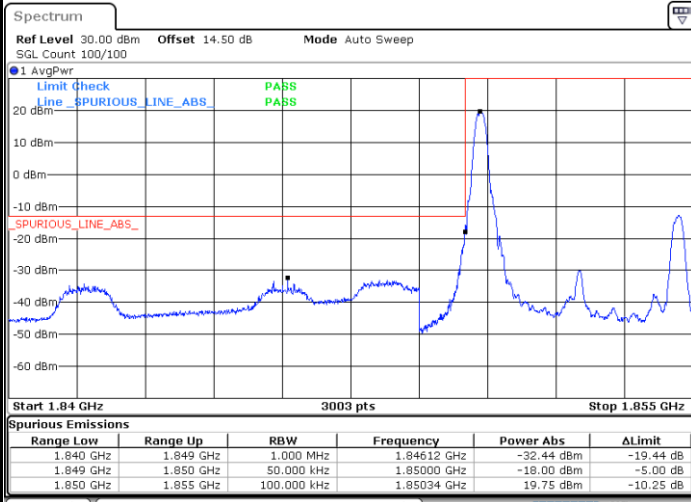

Date: 16.AUG.2023 17:13:13

Highest Band Edge / 1 RB

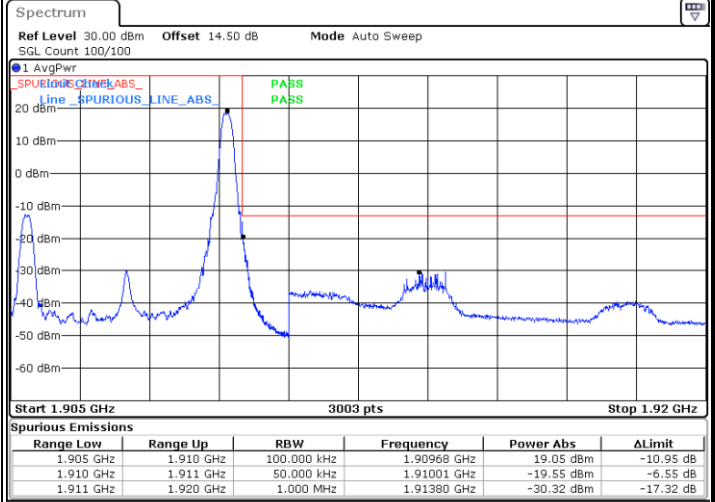

Date: 16.AUG.2023 17:21:18

Lowest Band Edge / Full RB

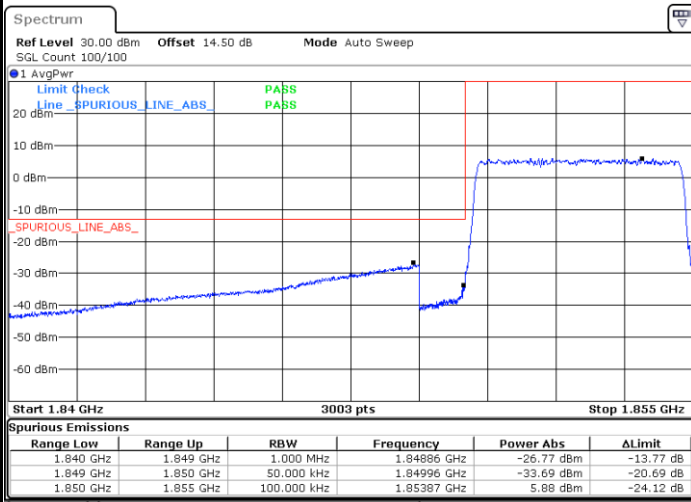

Date: 16.AUG.2023 17:16:26

Highest Band Edge / Full RB

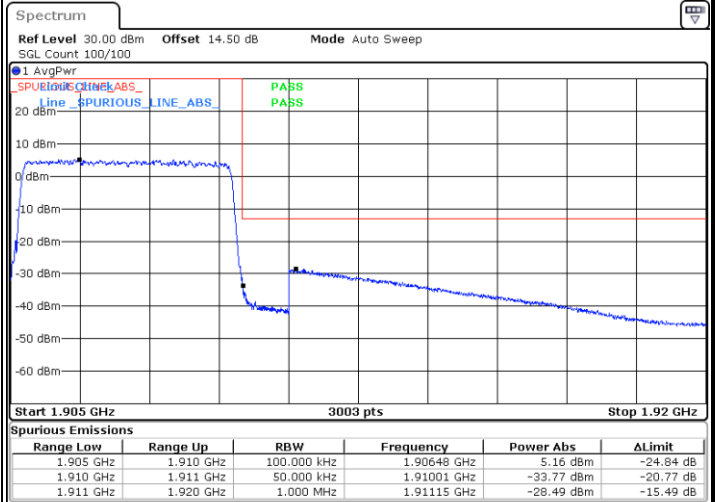

Date: 16.AUG.2023 17:23:10



LTE Band 2 / 10MHz / QPSK

Lowest Band Edge / 1RB

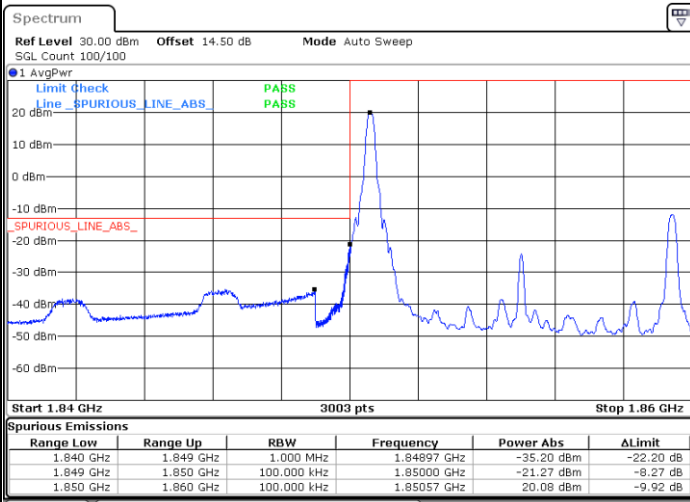

Date: 16.AUG.2023 17:25:32

Highest Band Edge / 1RB

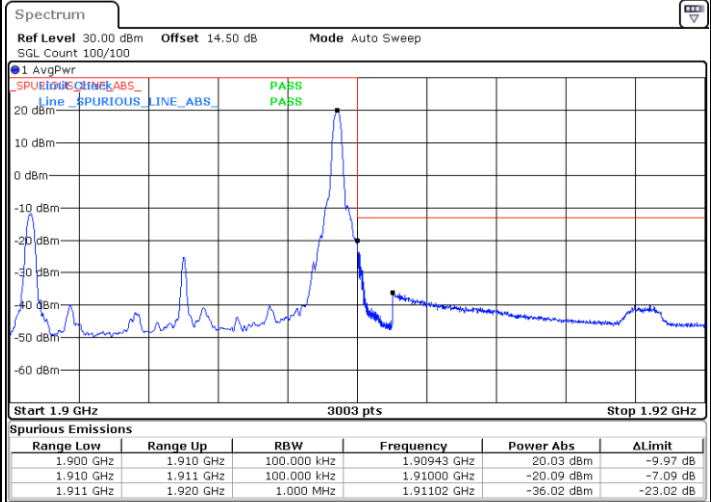

Date: 16.AUG.2023 17:37:59

Lowest Band Edge / Full RB

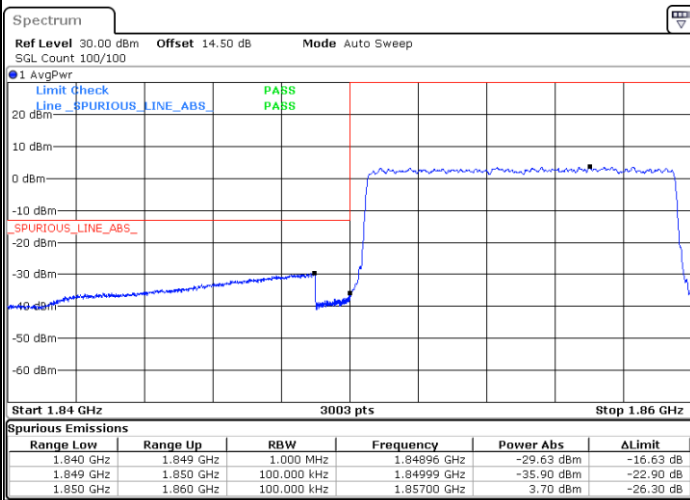

Date: 16.AUG.2023 17:27:25

Highest Band Edge / Full RB

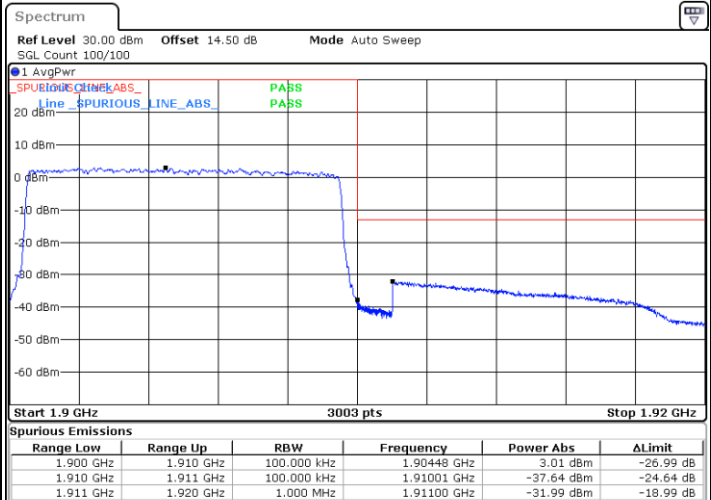

Date: 16.AUG.2023 17:39:53



LTE Band 2 / 10MHz / 16QAM

Lowest Band Edge / 1 RB

Highest Band Edge / 1 RB

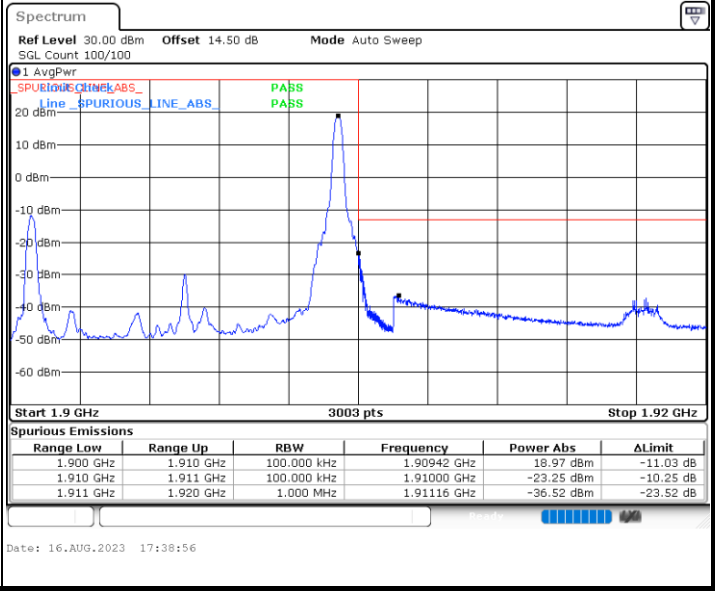
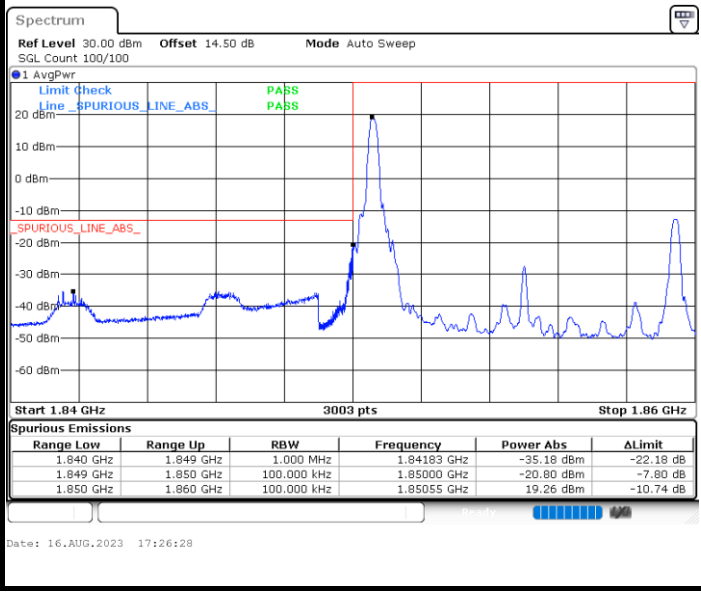



LTE Band 2 / 15MHz / QPSK

Lowest Band Edge / 1RB

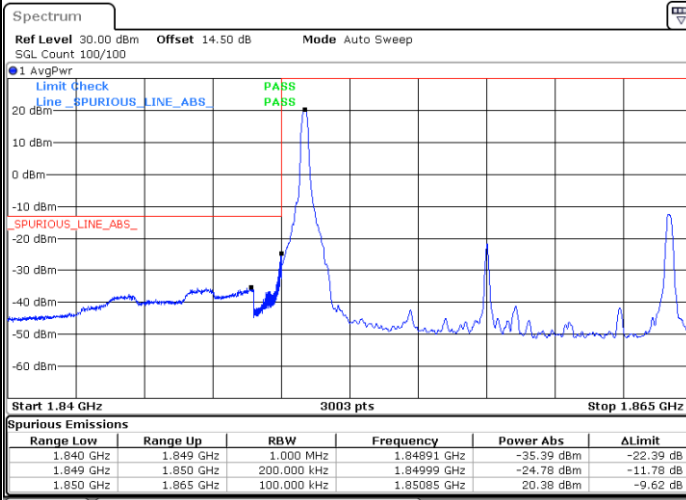

Date: 16.AUG.2023 17:45:22

Highest Band Edge / 1RB

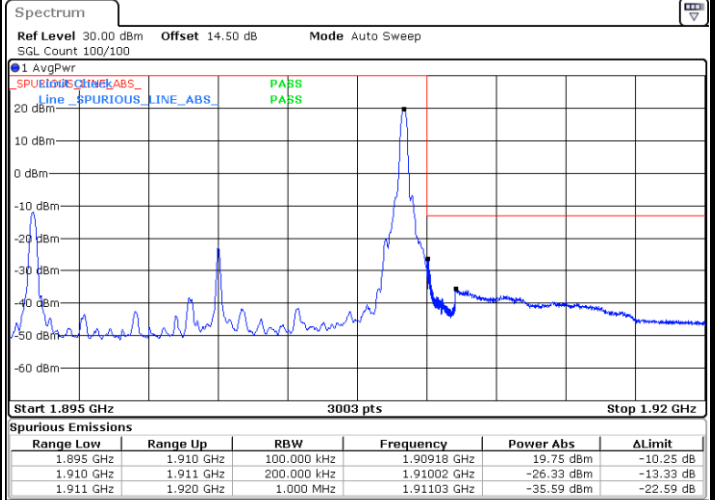

Date: 16.AUG.2023 17:58:44

Lowest Band Edge / Full RB

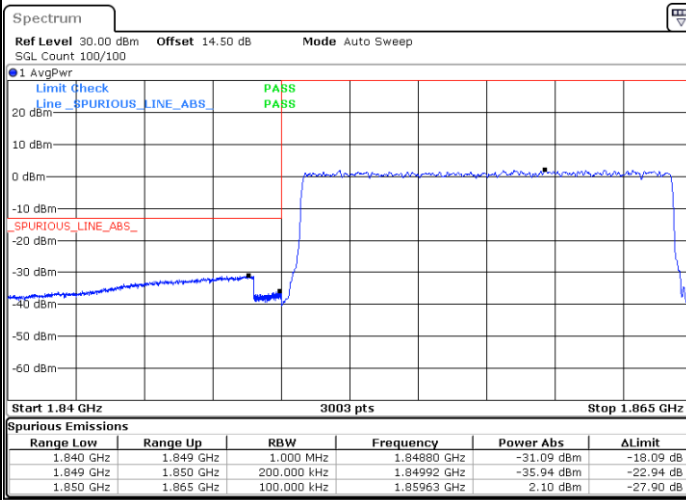

Date: 16.AUG.2023 17:48:11

Highest Band Edge / Full RB

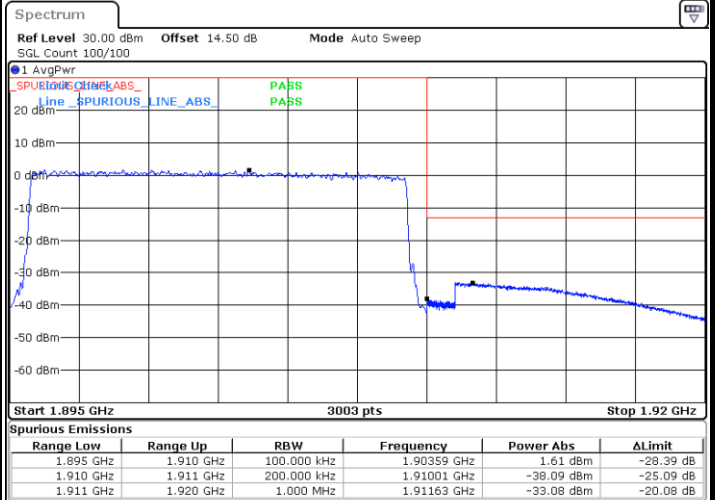

Date: 16.AUG.2023 18:00:37



LTE Band 2 / 15MHz / 16QAM

Lowest Band Edge / 1 RB

Highest Band Edge / 1 RB

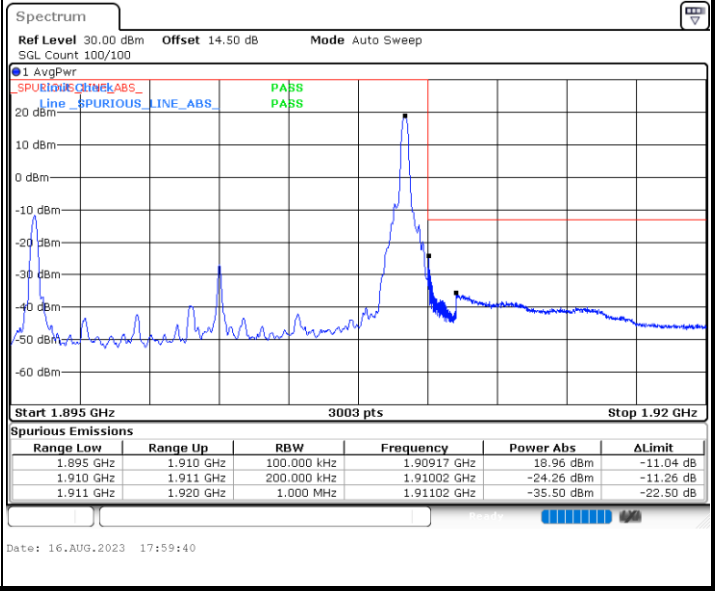
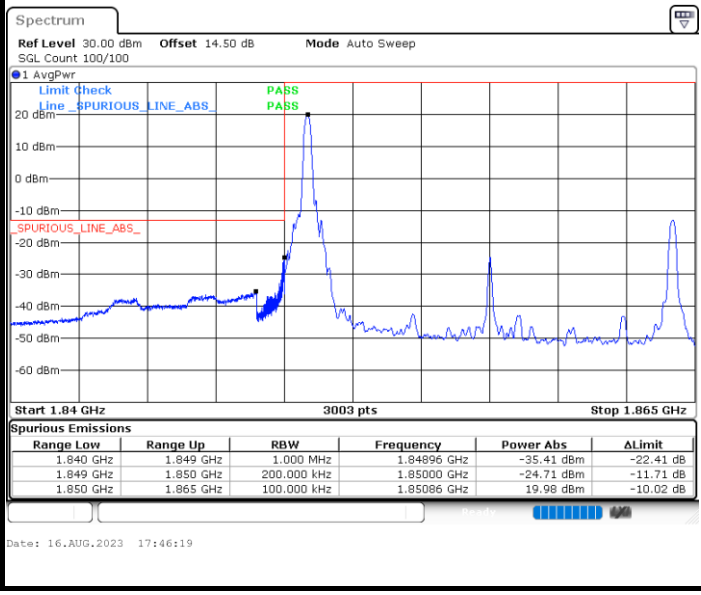



LTE Band 2 / 20MHz / QPSK

Lowest Band Edge / 1RB

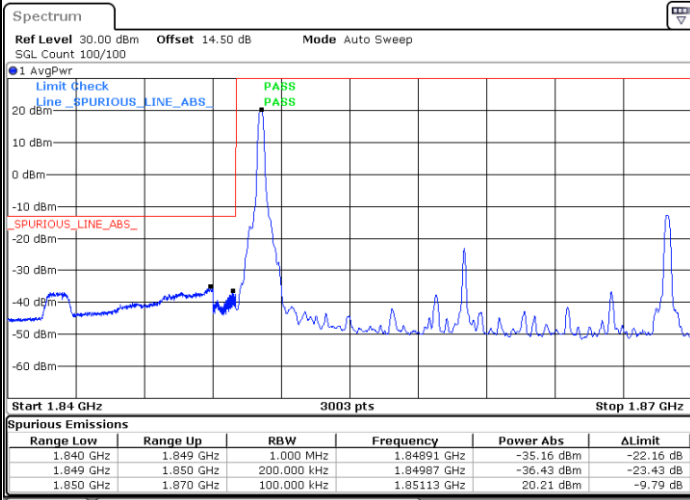

Date: 16.AUG.2023 18:06:05

Highest Band Edge / 1RB

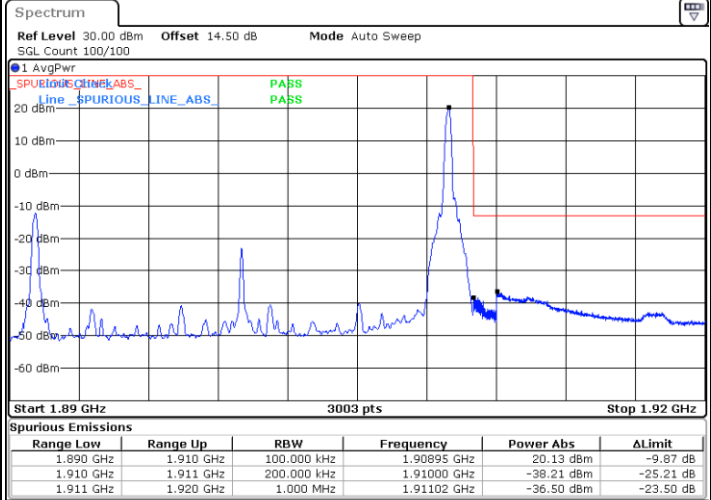

Date: 16.AUG.2023 18:21:55

Lowest Band Edge / Full RB

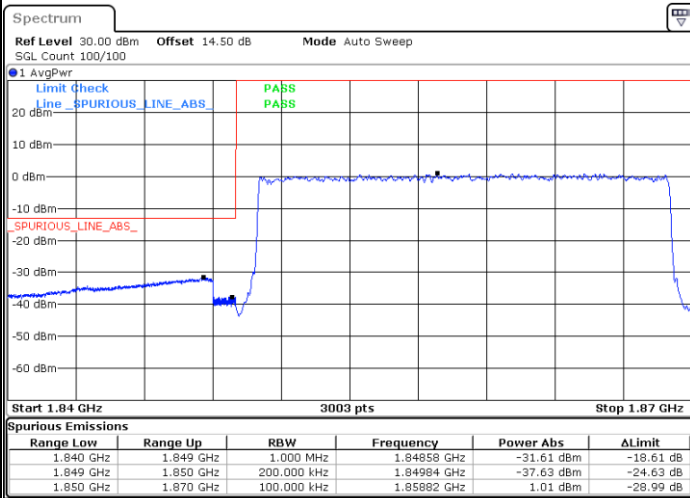

Date: 16.AUG.2023 18:07:58

Highest Band Edge / Full RB

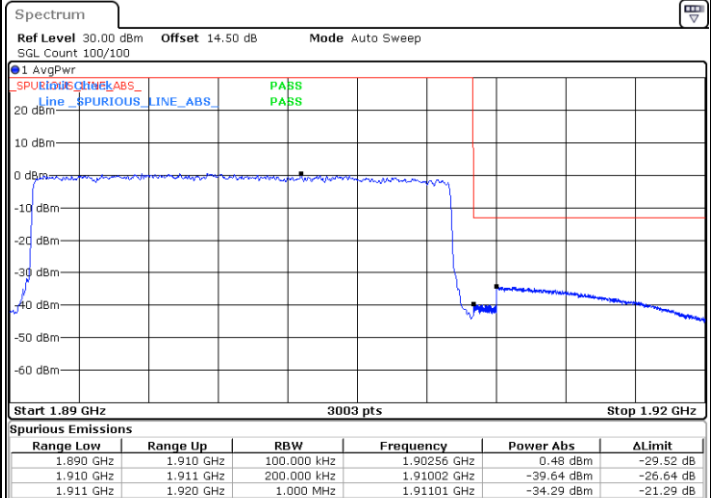

Date: 16.AUG.2023 18:23:47



LTE Band 2 / 20MHz / 16QAM

Lowest Band Edge / 1 RB

Highest Band Edge / 1 RB

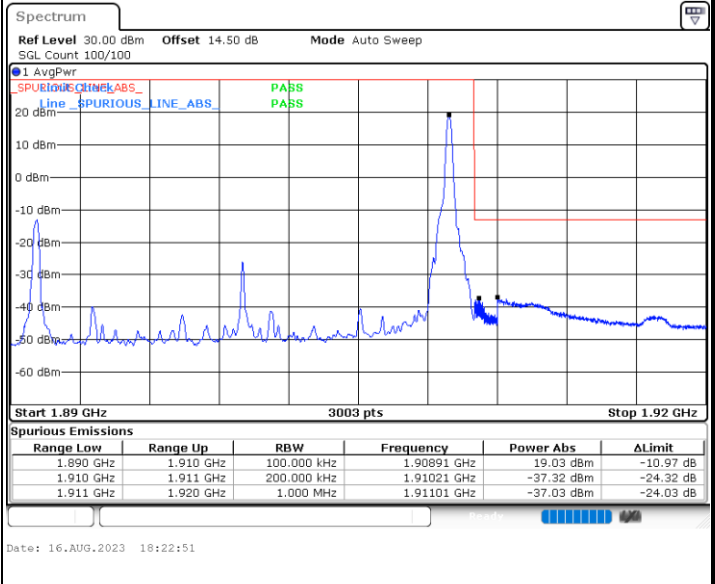
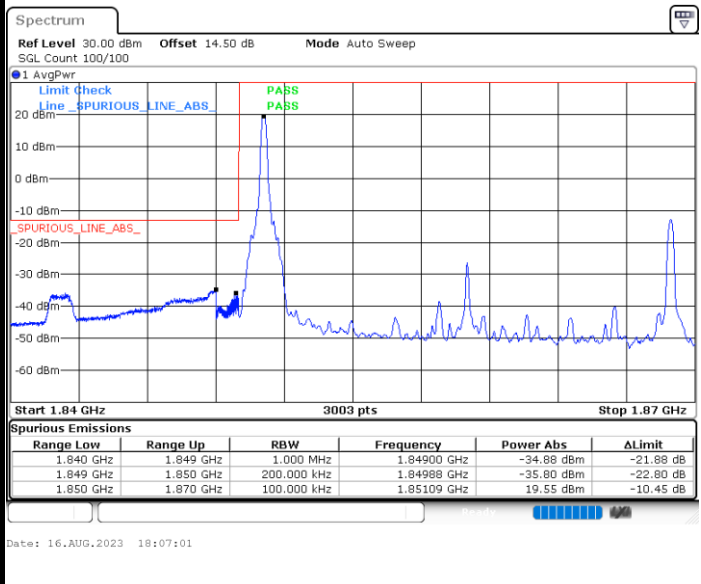





# Conducted Spurious Emission

## LTE Band 2 / 1.4MHz

### Lowest Channel / QPSK

### Middle Channel / QPSK

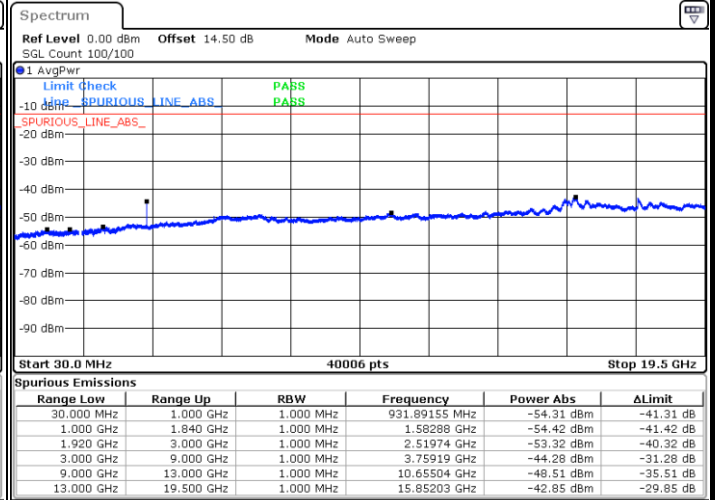
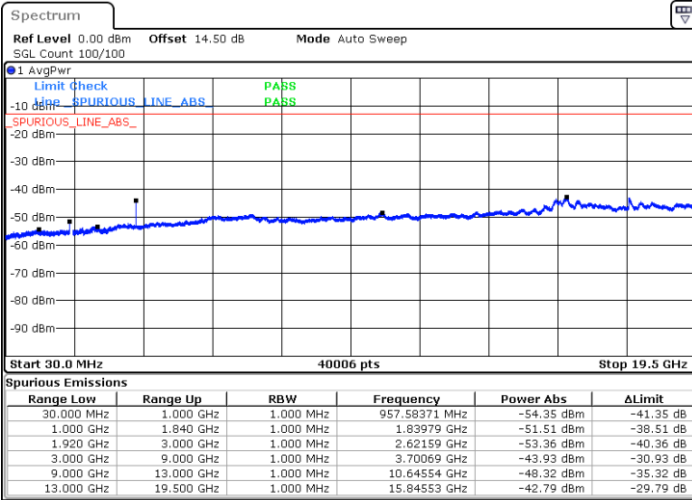

Date: 16.AUG.2023 16:31:22

Date: 16.AUG.2023 16:36:27

### Highest Channel / QPSK

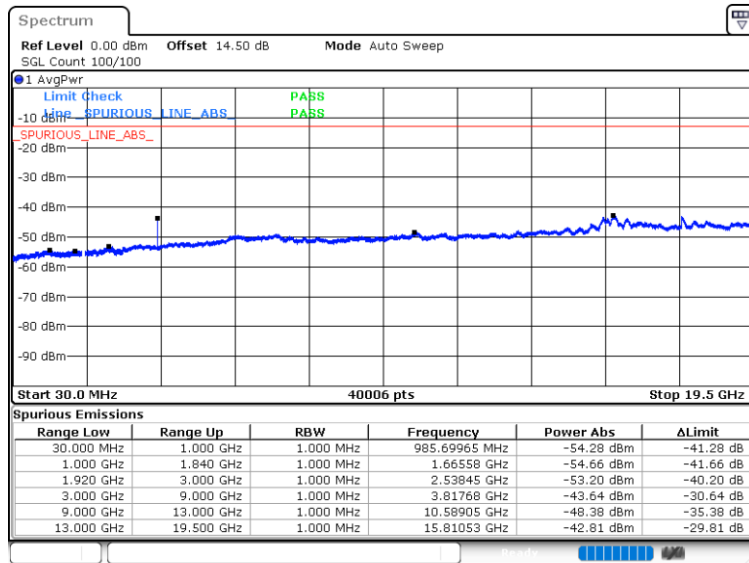

Date: 16.AUG.2023 16:43:01



LTE Band 2 / 3MHz

Lowest Channel / QPSK

Middle Channel / QPSK

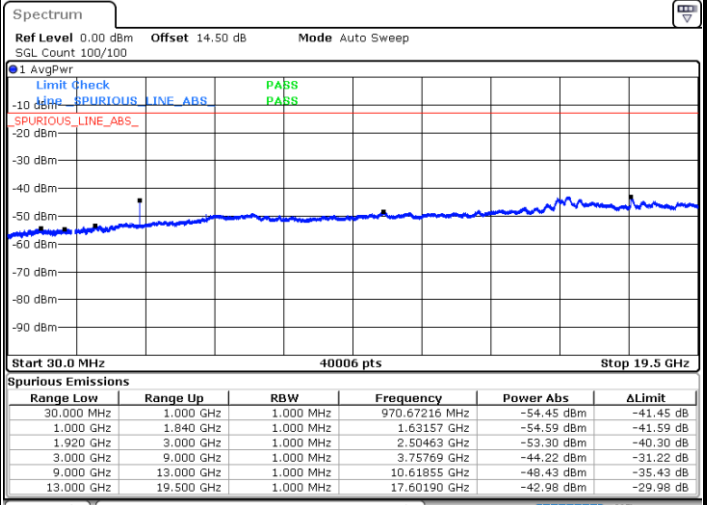
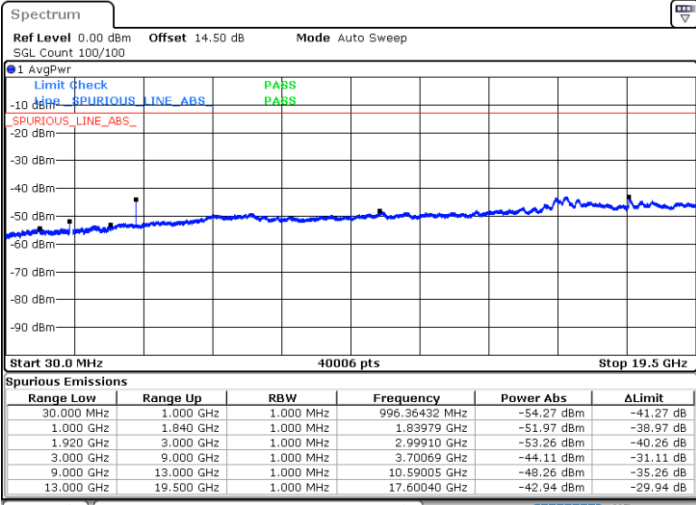

Date: 16.AUG.2023 16:51:59

Date: 16.AUG.2023 16:59:07

Highest Channel / QPSK

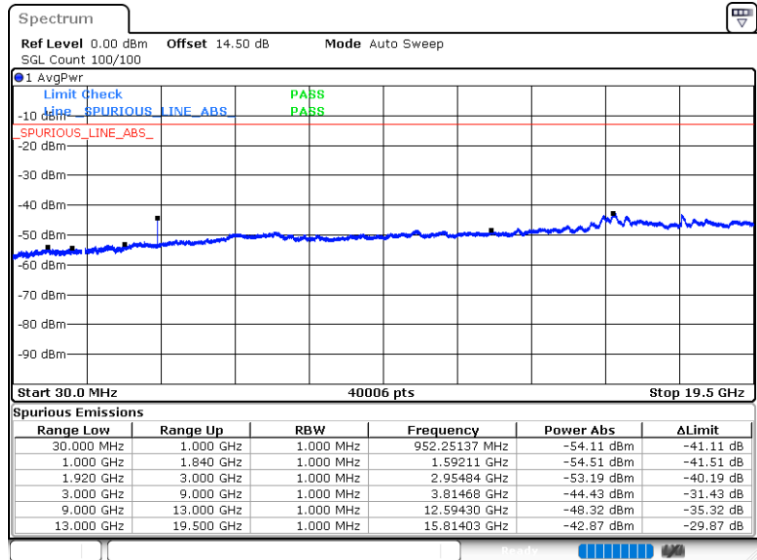

Date: 16.AUG.2023 17:11:15



LTE Band 2 / 5MHz

Lowest Channel / QPSK

Middle Channel / QPSK

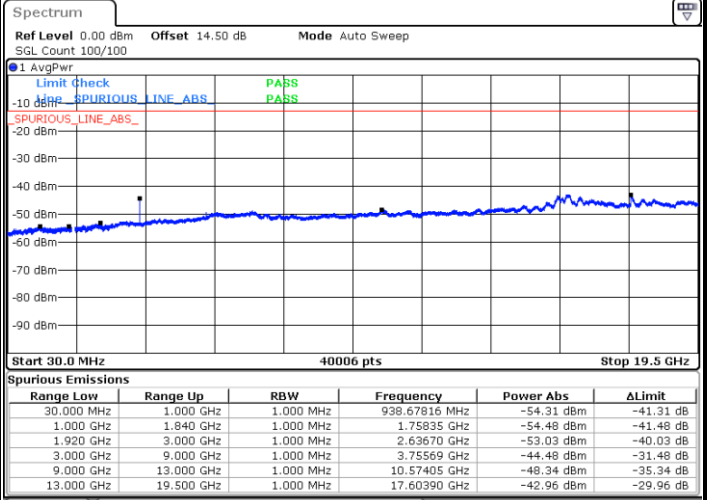
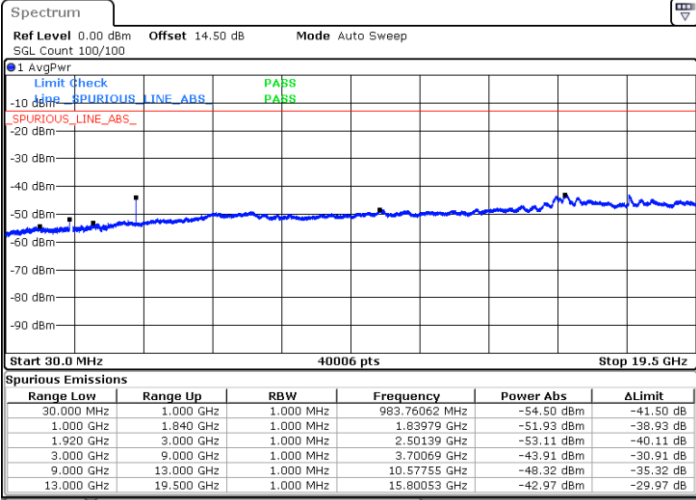

Date: 16.AUG.2023 17:14:33

Date: 16.AUG.2023 17:17:46

Highest Channel / QPSK

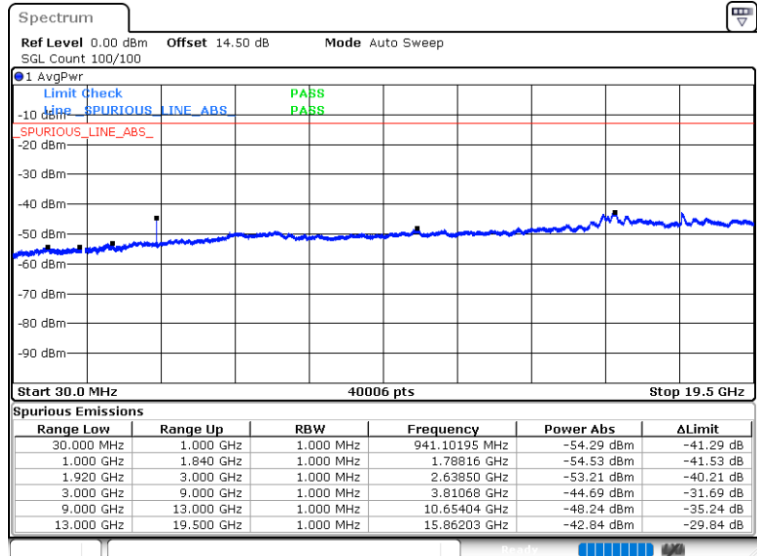

Date: 16.AUG.2023 17:24:31



LTE Band 2 / 10MHz

Lowest Channel / QPSK

Middle Channel / QPSK

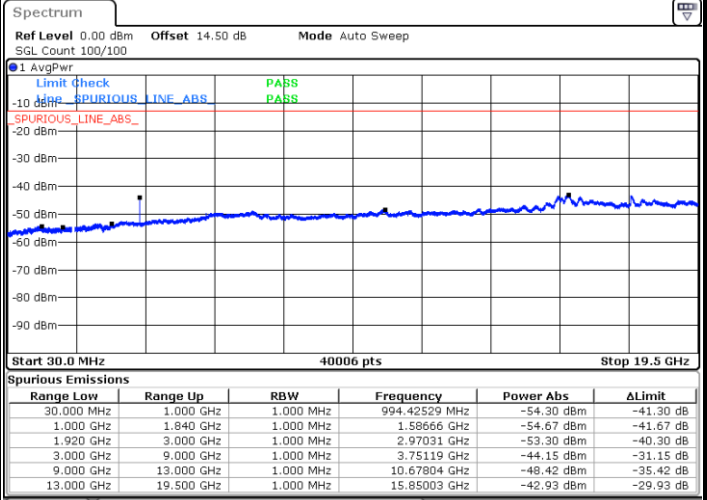
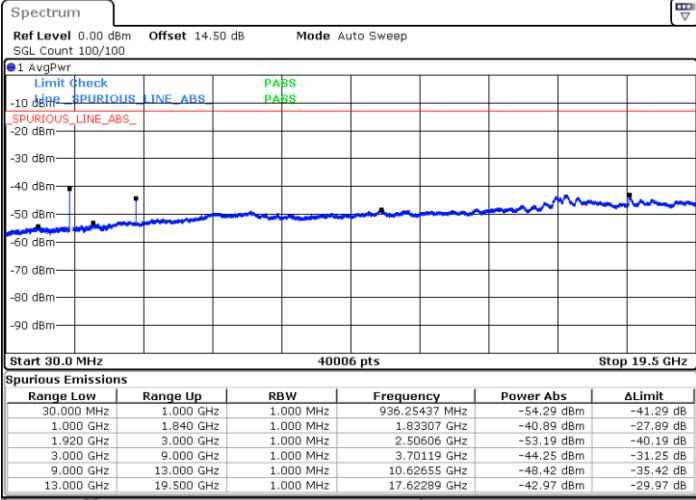

Date: 16.AUG.2023 17:31:52

Date: 16.AUG.2023 17:33:12

Highest Channel / QPSK

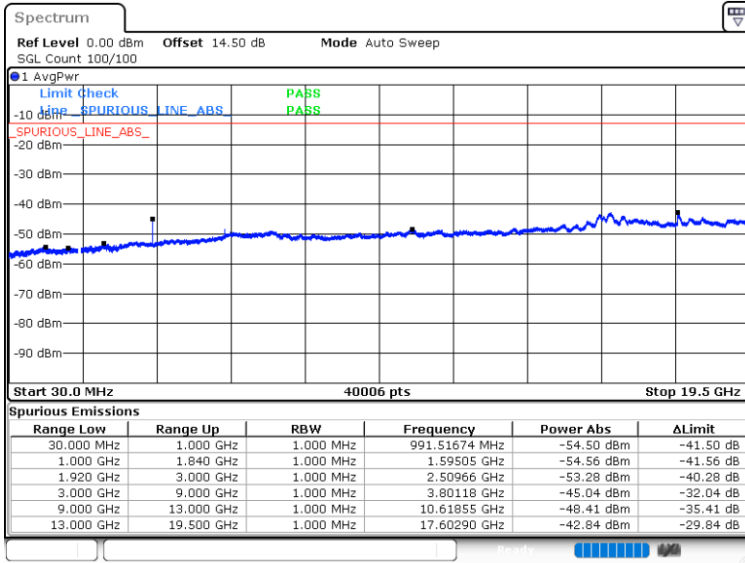

Date: 16.AUG.2023 17:44:21



LTE Band 2 / 15MHz

Lowest Channel / QPSK

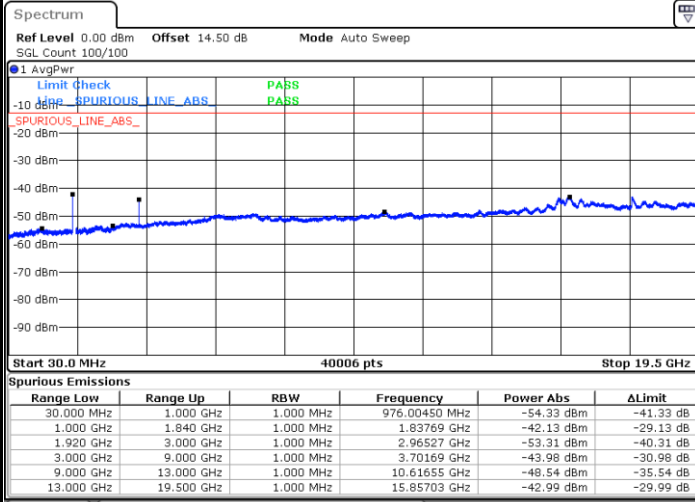

Date: 16.AUG.2023 17:52:38

Middle Channel / QPSK

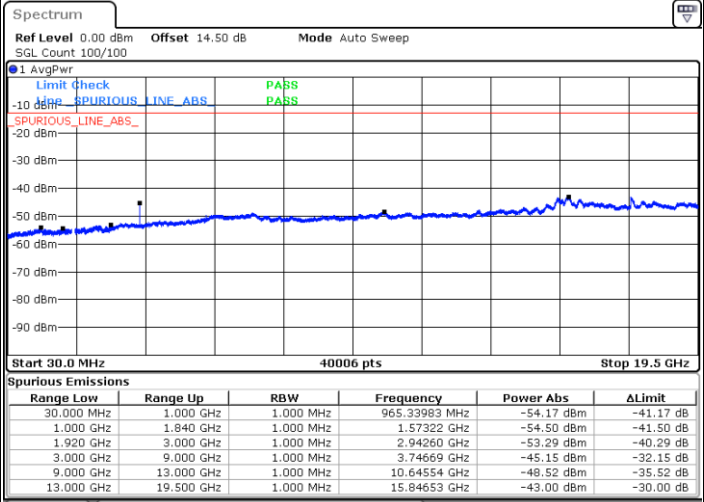

Date: 16.AUG.2023 17:53:58

Highest Channel / QPSK

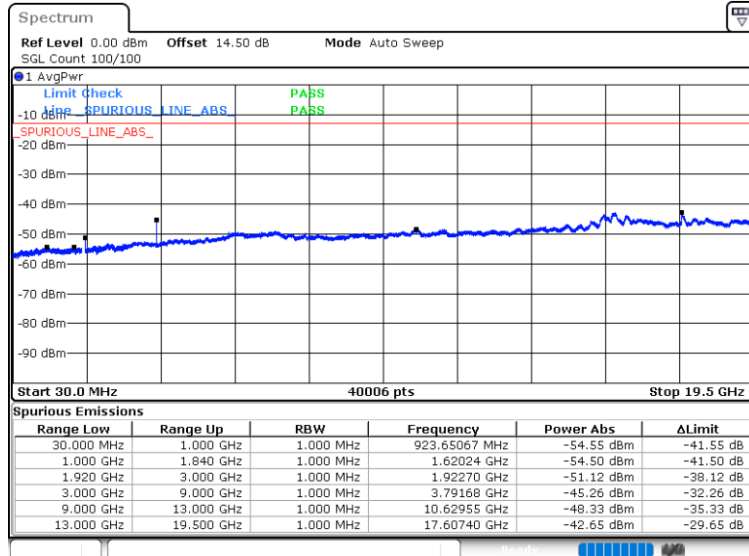

Date: 16.AUG.2023 18:05:04



LTE Band 2 / 20MHz

Lowest Channel / QPSK

Middle Channel / QPSK

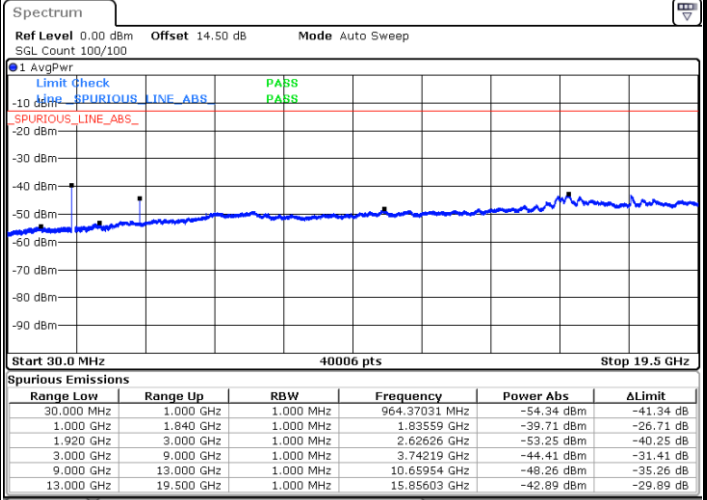
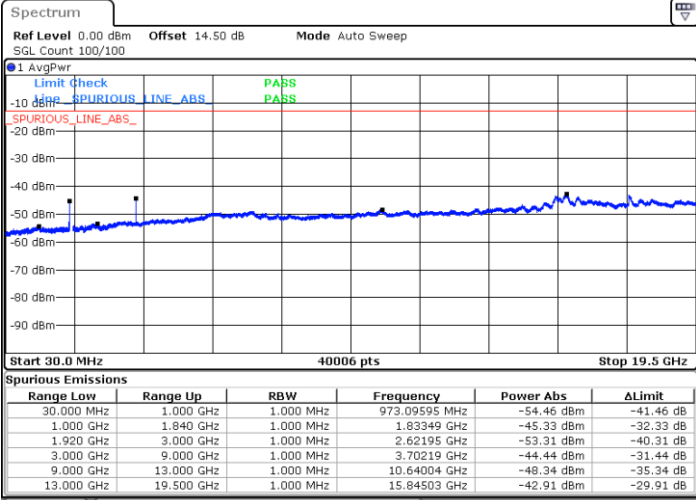

Date: 16.AUG.2023 18:12:25

Date: 16.AUG.2023 18:13:45

Highest Channel / QPSK

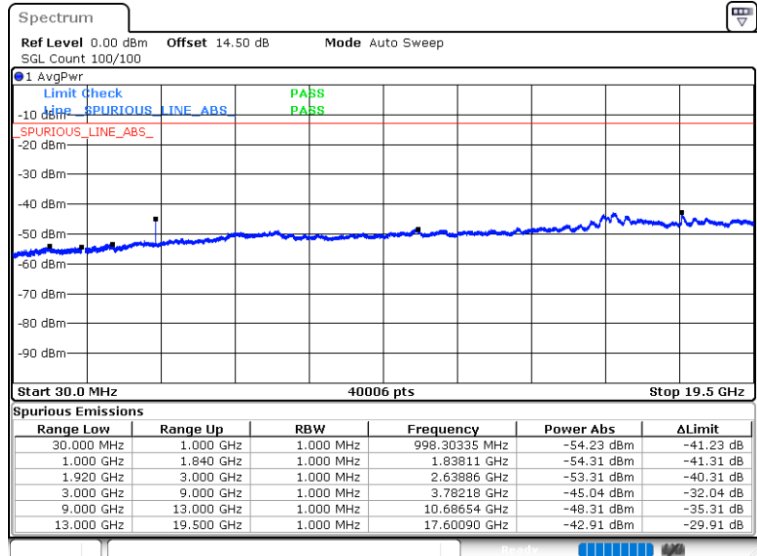

Date: 16.AUG.2023 18:28:14



### Frequency Stability

Test Conditions		LTE Band 2 (QPSK) / Middle Channel	Limit
Temperature (°C)	Voltage (Volt)	BW 10MHz	Note 2.
		Deviation (ppm)	Result
50	Normal Voltage	0.0007	PASS
40	Normal Voltage	0.0074	
30	Normal Voltage	0.0000	
20(Ref.)	Normal Voltage	0.0000	
10	Normal Voltage	0.0002	
0	Normal Voltage	0.0076	
-10	Normal Voltage	0.0000	
-20	Normal Voltage	0.0075	
-30	Normal Voltage	0.0072	
20	Maximum Voltage	0.0002	
20	Normal Voltage	0.0000	
20	Minimum Voltage	0.0073	

**Note:**

1. Normal Voltage = 3.8 V. ; Minimum Voltage = 3.4 V. ; Maximum Voltage = 4.2 V.
2. The frequency fundamental emissions stay within the authorized frequency block.



# LTE Band 4

## Peak-to-Average Ratio

Mode	LTE Band 4 / 20MHz			
Mod.	QPSK			Limit: 13dB
RB Size	Full RB			Result
Middle CH	5.77			PASS

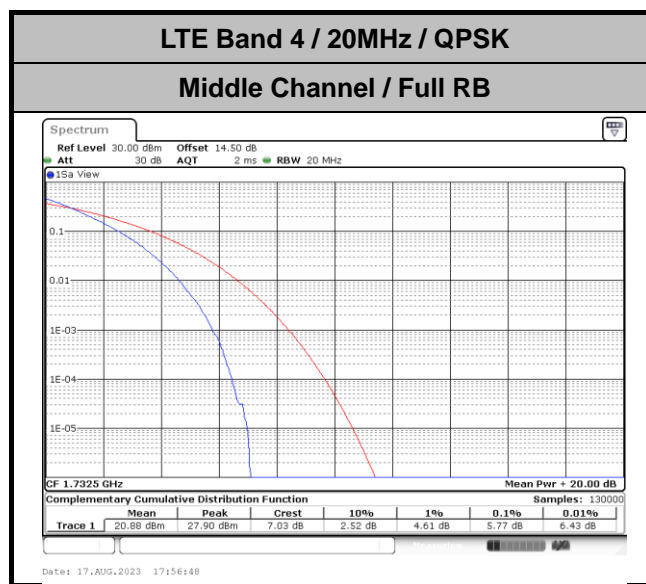





## 26dB Bandwidth

Mode	LTE Band 4 : 26dB BW(MHz)											
	1.4MHz		3MHz		5MHz		10MHz		15MHz		20MHz	
Mod.	QPSK	16QAM	QPSK	16QAM	QPSK	16QAM	QPSK	16QAM	QPSK	16QAM	QPSK	16QAM
Middle CH	1.26	1.25	2.98	2.99	4.85	4.89	9.69	5.67	14.42	5.78	18.78	5.67



LTE Band 4

Middle Channel / 1.4MHz / QPSK

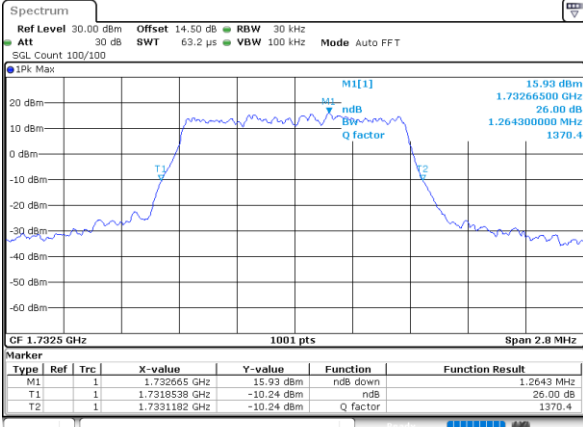

Date: 16\_AUG.2023 18:52:41

Middle Channel / 1.4MHz / 16QAM

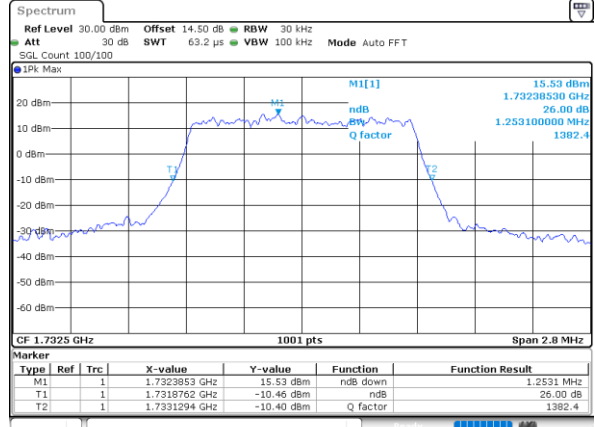

Date: 16\_AUG.2023 18:53:27

Middle Channel / 3MHz / QPSK

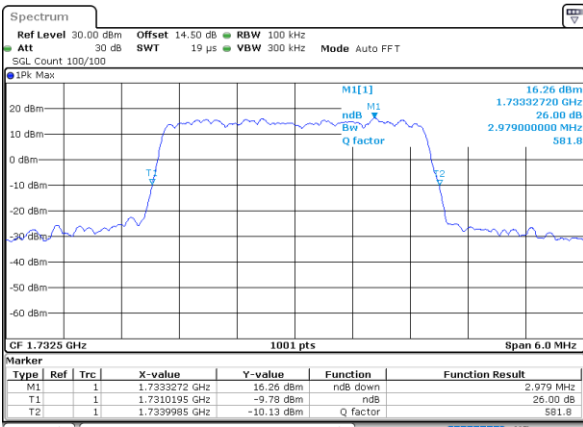

Date: 16\_AUG.2023 19:16:00

Middle Channel / 3MHz / 16QAM

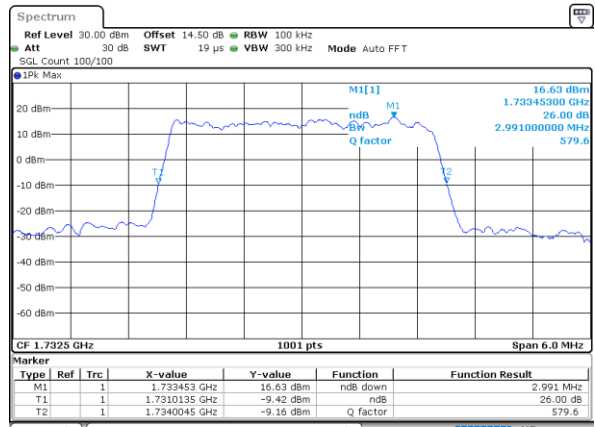

Date: 16\_AUG.2023 19:16:50

Middle Channel / 5MHz / QPSK

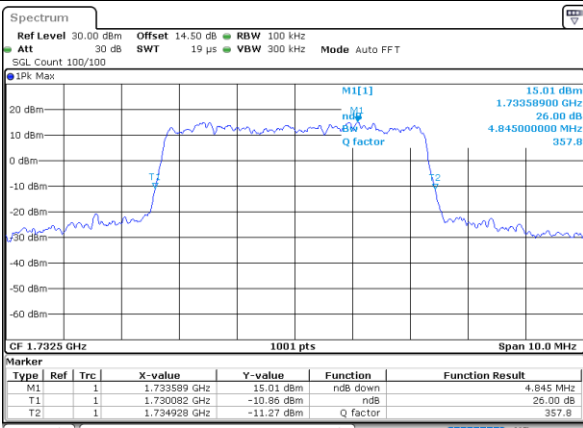

Date: 17\_AUG.2023 18:11:47

Middle Channel / 5MHz / 16QAM

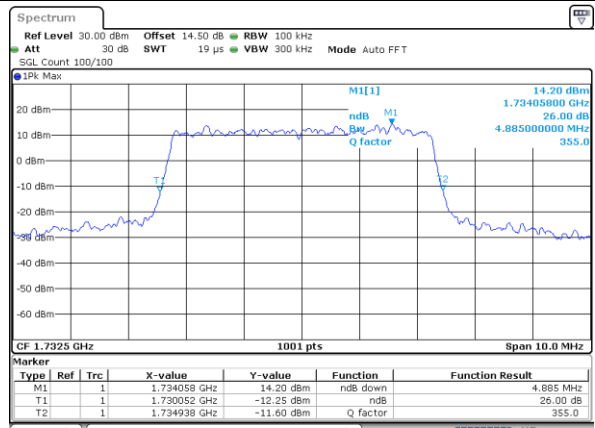

Date: 17\_AUG.2023 18:12:30