

RF Test Report

Test in accordance with
Federal Communications Commission(FCC)
CFR TITLE 47, Parts 2,27

Product Name: GPS Locator
Model No. : GV50LTA
FCC ID: YQD-GV50LTA

Applicant : Queclink Wireless Solutions Co.,Ltd.
Address : Room 501, Building 9, No. 99 Tianzhou Road,
Xuhui District, Shanghai, China.

Date of Receipt : 01-20-2017
Test Date : 02-09-2017~03-02-2017
Issued Date : 03-02-2017
Report No. : UL12620170120FCC001-1
Report Version : V1.0

Notes:

The test results only relate to these samples which have been tested.
Partly using this report will not be admitted unless been allowed by Unilab.
Unilab is only responsible for the complete report with the reported stamp of Unilab.

Test Report Certification

Issued Date : 03-02-2017
ReportNo. :UL12620170120FCC001-1

Product Name : GPS Locator
Applicant : Queclink Wireless Solutions Co.,Ltd.
Address : Room 501, Building 9, No. 99 Tianzhou Road, Xuhui District, Shanghai, China.
Manufacturer : Queclink Wireless Solutions Co.,Ltd.
Address : Room 501, Building 9, No. 99 Tianzhou Road, Xuhui District, Shanghai, China.
Model No. : GV50LTA
EUT Voltage : MIN: 8.0V, NOR:12Vor24V, MAX:32V (DC)
Brand Name : QUECLINK
FCC ID: YQD-GV50LTA

Applicable Standard : ANSI/TIA-603-D-2010;FCC KDB 971168D01 Power Meas License Digital Systems v02r02;FCC CFR Title 47 Part 2;FCCCFR Title 47 Part 27

Test Result : Complied

Performed Location : Unilab (Shanghai) Co., Ltd.
FCC 2.948 register number is 714465
No. 1350, Lianxi Rd. Pudong New District, Shanghai, China
TEL: +86-21-50275125FAX: +86-21-50277862

Prepared by : Wayne Wu
(Technical Engineer: Wayne Wu)

Reviewed by : Forest Cao
(Senior Engineer: Forest Cao)

Approved by : Eva Wang
(SupervisorEngineer: Eva Wang)

TABLE OF CONTENTS

SUMMARY OF TEST RESULT.....	4
1. General Information.....	5
1.1. EUT Description	5
1.2. Mode of Operation	5
1.3. Tested System Details	10
1.4. Configuration of Tested System.....	10
1.5. EUT Exercise Software	10
2. Technical Test.....	11
2.1. Test Environment	11
3. Peak Output Power	12
3.1. Test Equipment	12
3.2. Test Setup.....	12
3.3. Limit.....	13
3.4. Test Procedure	14
3.5. Uncertainty	14
3.6. Test Result	15
4. Occupied Bandwidth	22
4.1. Test Equipment	22
4.2. Test Setup	22
4.3. Limit.....	22
4.4. Test Procedure	23
4.5. Uncertainty	23
4.6. Test Result	23
5. Spurious Emission At Antenna Terminals (+/- 1MHz)	51
5.1. Test Equipment	51
5.2. Test Setup	51
5.3. Limit.....	51
5.4. Test Procedure	52
5.5. Uncertainty	52
5.6. Test Result	53
6. Spurious Emission.....	86
6.1. Test Equipment	86
6.2. Test Setup	87
6.3. Limit.....	88
6.4. Test Procedure	88
6.5. Uncertainty	89
6.6. Test Result	90
7. Frequency Stability Under Temperature & Voltage Variations	132
7.1. Test Equipment	132
7.2. Test Setup	132
7.3. Limit.....	132
7.4. Test Procedure	133
7.5. Uncertainty	133
7.6. Test Result	134
8. Peak to Average	142
8.1. Test Equipment	142
8.2. Test Setup	142
8.3. Limit.....	142
8.4. Test Procedure	142
8.5. Uncertainty	143
8.6. Test Result	143
9. Attachment.....	165

SUMMARY OF TEST RESULT

Report Section	SPECIFICATION	Description	Limit	Result
	FCC CFR 47			
3	part2.1046	Conducted Output Power	N/A	PASS
3	part 27.50(d)(4) part 27.50(b)(10)	Effective Radiated Power Equivalent Isotropic Radiated Power	<1 Watts <3 Watts	PASS
4	part 2.1047	Modulation Characteristic	N/A	PASS
4	part 2.1049 part 27.53 (g)(h)	Occupied Bandwidth	N/A	PASS
5	part 2.1051 part 27.53(g)(h)	Band Edge Measurement	<43+10lg(P[Watts])	PASS
6	part 2.1051 part 27.53 (g)(h)	Conducted Spurious Emission	<43+10lg(P[Watts])	PASS
6	part 2.1053 part 27.53(g)(h)	Field Strength of Spurious Radiation	<43+10lg(P[Watts])	PASS
7	part 2.1055 part 27.54	Frequency Stability for Temperature & Voltage	N/A	PASS

1.General Information

1.1. EUT Description

Product Name:	GPS Locator
Model Name:	GV50LTA
Hardware Version:	GV50LTA_V1.02
Software Version:	GV50LTAR00A01V18
RF Exposure Environment:	Uncontrolled
LTE	
Support Band:	LTE Band 4& LTE Band 13
Tx FrequencyRange:	LTE Band 4: 1710 MHz -1755 MHz LTE Band 13: 777 MHz -787 MHz
Rx FrequencyRange:	LTE Band 4: 2110 MHz -2155 MHz LTE Band 13: 746 MHz -756 MHz
Type of modulation:	LTE: QPSK,16-QAM
Antenna Type:	Connector
AntennaPeak Gain:	Band4:1.42dBi Band13:-0.39dBi

This EUT is a GPS locator,which is supports LTE Band 4 and LTE Band 13.

1.2. Mode of Operation

Unilab has verified the construction and function in typical operation. EUT is inlink mode with base station emulator at maximum power level. All the test modes were carried out with the EUT in normal operation, which was shown in this test report is the worst test modeand defined as:

12V DC:

Mode	Band Width (MHz)	QPSK		16-QAM	
		RB Size	RB Offset	RB Size	RB Offset
LTE Band 4	5	1	0	1	0
	10	1	49	1	0
LTE Band 13	5	1	0	1	0
	10	1	0	1	0

24V DC:

Mode	Band Width (MHz)	QPSK		16-QAM	
		RB Size	RB Offset	RB Size	RB Offset
LTE Band 4	5	1	24	1	24
	10	1	0	1	0
LTE Band 13	5	1	0	1	24
	10	1	0	1	0

Note:

1. Regards to the frequency band operation: the lowest, middle and highest frequency of channel

were selected to perform the test, then shown on this report.
 2.For the ERP/EIRP and radiated emission test, every axis (X, Y, Z) was verified, and show the worst (Z axis) result on this report.
 3.For conducted test, both two Modulations(QPSK and 16-QAM) are tested for radiated test, only the maximum RF output power level are chosen.

**The conducted power table is as follows:
 12V DC:**

Mode	Band Width	Channel	Frequency (MHz)	Modulation	RB Configuration		Average Power (dBm)	Average Power (Watts)
					RB Size	RB Offset		
LTE Band 4	5 MHz	19975	1712.5	QPSK	1	0	22.01	0.16
					1	24	21.97	0.16
					8	17	21.77	0.15
				25	0	20.81	0.12	
				16-QAM	1	0	21.64	0.15
					1	24	21.58	0.14
		8	17		21.22	0.13		
		25	0	19.98	0.10			
		20175	1732.5	QPSK	1	0	21.98	0.16
					1	24	21.73	0.15
					8	17	21.62	0.15
				25	0	20.67	0.12	
	16-QAM			1	0	21.24	0.13	
				1	24	21.10	0.13	
		8	17	20.66	0.12			
	25	0	19.68	0.09				
	20375	1752.5	QPSK	1	0	21.67	0.15	
				1	24	22.01	0.16	
				8	17	22.00	0.16	
			25	0	20.89	0.12		
			16-QAM	1	0	20.31	0.11	
				1	24	20.38	0.11	
	8	17		20.71	0.12			
	25	0	19.94	0.10				
	10 MHz	20000	1715.0	QPSK	1	0	22.04	0.16
					1	49	22.10	0.16
					16	34	21.01	0.13
				50	0	20.96	0.12	
				16-QAM	1	0	22.07	0.16
					1	49	22.01	0.16
		16	34		20.04	0.10		
		50	0	19.92	0.10			
		20175	1732.5	QPSK	1	0	21.88	0.15
					1	49	21.43	0.14
					16	34	20.43	0.11
				50	0	20.66	0.12	
16-QAM	1	0	21.65	0.15				

					1	49	20.59	0.11
					16	34	19.46	0.08
					50	0	19.56	0.09
		20350	1750.0	QPSK	1	0	21.46	0.14
					1	49	22.17	0.16
					16	34	21.01	0.13
					50	0	20.79	0.12
				16-QAM	1	0	21.46	0.14
					1	49	22.07	0.16
					16	34	20.07	0.10
					50	0	19.76	0.09

Mode	Band Width	Channel	Frequency (MHz)	Modulation	RB Configuration		Average Power (dBm)	Average Power (Watts)
					RB Size	RB Offset		
LTE Band 13	5 MHz	23205	779.5	QPSK	1	0	22.51	0.18
					1	24	22.31	0.17
					8	17	22.18	0.17
					25	0	21.30	0.13
		16-QAM	1	0	22.11	0.16		
			1	24	21.87	0.15		
			8	17	21.55	0.14		
			25	0	20.33	0.11		
		23230	782.0	QPSK	1	0	22.55	0.18
					1	24	22.50	0.18
					8	17	22.48	0.18
					25	0	21.32	0.14
	16-QAM	1	0	21.81	0.15			
		1	24	21.89	0.15			
		8	17	21.49	0.14			
		25	0	20.34	0.10			
	23255	784.5	QPSK	1	0	22.23	0.17	
				1	24	21.78	0.15	
				8	17	21.99	0.16	
				25	0	21.19	0.13	
			16-QAM	1	0	21.01	0.13	
				1	24	20.56	0.11	
				8	17	20.98	0.13	
				25	0	20.09	0.10	
10 MHz	23230	QPSK	1	0	22.26	0.17		
			1	49	22.06	0.16		
			16	34	21.07	0.13		
			50	0	21.11	0.13		
		16-QAM	1	0	22.08	0.16		
			1	49	21.79	0.15		
			16	34	20.04	0.10		
			50	0	20.23	0.11		

24VDC:

Mode	Band Width	Channel	Frequency (MHz)	Modulation	RB Configuration		Average Power (dBm)	Average Power (Watts)		
					RB Size	RB Offset				
LTE Band 4	5 MHz	19975	1712.5	QPSK	1	0	22.01	0.16		
					1	24	22.01	0.16		
					8	17	21.88	0.15		
					25	0	20.89	0.12		
				16-QAM	1	0	20.49	0.11		
					1	24	20.73	0.12		
					8	17	20.90	0.12		
					25	0	19.79	0.10		
		20175	1732.5	QPSK	1	0	21.37	0.14		
					1	24	21.22	0.13		
					8	17	21.46	0.14		
					25	0	20.54	0.11		
				16-QAM	1	0	20.15	0.10		
					1	24	20.03	0.10		
					8	17	20.43	0.11		
					25	0	19.36	0.09		
		20375	1752.5	QPSK	1	0	21.92	0.16		
					1	24	22.42	0.17		
					8	17	22.22	0.17		
					25	0	21.04	0.13		
				16-QAM	1	0	21.28	0.13		
					1	24	21.64	0.15		
					8	17	21.22	0.13		
					25	0	20.05	0.10		
	10 MHz	20000	1715.0	QPSK	1	0	22.25	0.17		
					1	49	22.22	0.17		
					16	34	21.10	0.13		
					50	0	21.12	0.13		
				16-QAM	1	0	22.14	0.16		
					1	49	22.13	0.16		
					16	34	20.16	0.10		
					50	0	20.08	0.10		
				20175	1732.5	QPSK	1	0	21.88	0.15
							1	49	21.52	0.14
							16	34	20.44	0.11
							50	0	20.67	0.12
		16-QAM	1			0	21.71	0.15		
			1			49	20.64	0.12		
			16			34	19.42	0.09		
			50			0	19.61	0.09		
		20350	1750.0			QPSK	1	0	21.20	0.13
							1	49	22.12	0.16
							16	34	21.02	0.13

					50	0	20.83	0.12
				16-QAM	1	0	19.86	0.10
					1	49	20.57	0.11
					16	34	19.84	0.10
					50	0	19.79	0.10

Mode	Band Width	Channel	Frequency (MHz)	Modulation	RB Configuration		Average Power (dBm)	Average Power (Watts)
					RB Size	RB Offset		
LTE Band 13	5 MHz	23205	779.5	QPSK	1	0	22.27	0.17
					1	24	22.23	0.17
					8	17	22.10	0.16
					25	0	21.23	0.13
				16-QAM	1	0	20.81	0.12
					1	24	20.74	0.12
					8	17	21.19	0.13
					25	0	20.20	0.10
		23230	782.0	QPSK	1	0	22.41	0.17
					1	24	22.35	0.17
					8	17	22.36	0.17
					25	0	21.22	0.13
				16-QAM	1	0	21.62	0.15
					1	24	21.67	0.15
					8	17	21.35	0.14
					25	0	20.12	0.10
	23255	784.5	QPSK	1	0	22.13	0.16	
				1	24	21.58	0.14	
				8	17	21.92	0.16	
				25	0	21.08	0.13	
			16-QAM	1	0	20.91	0.12	
				1	24	20.45	0.11	
				8	17	20.89	0.12	
				25	0	19.98	0.10	
	10 MHz	23230	QPSK	1	0	22.50	0.18	
				1	49	22.20	0.17	
				16	34	21.12	0.13	
				50	0	21.31	0.14	
			16-QAM	1	0	22.43	0.17	
				1	49	22.07	0.16	
				16	34	20.00	0.10	
				50	0	20.24	0.11	

1.3. Tested System Details

The types for all equipments, plus descriptions of all cables used in the tested system (including inserted cards) are:

Product	Manufacturer	Model	Serial No.	Power Cord
Radio Communication Tester	R&S	CMW500	147483	N/A

1.4. Configuration of Tested System

Connection Diagram

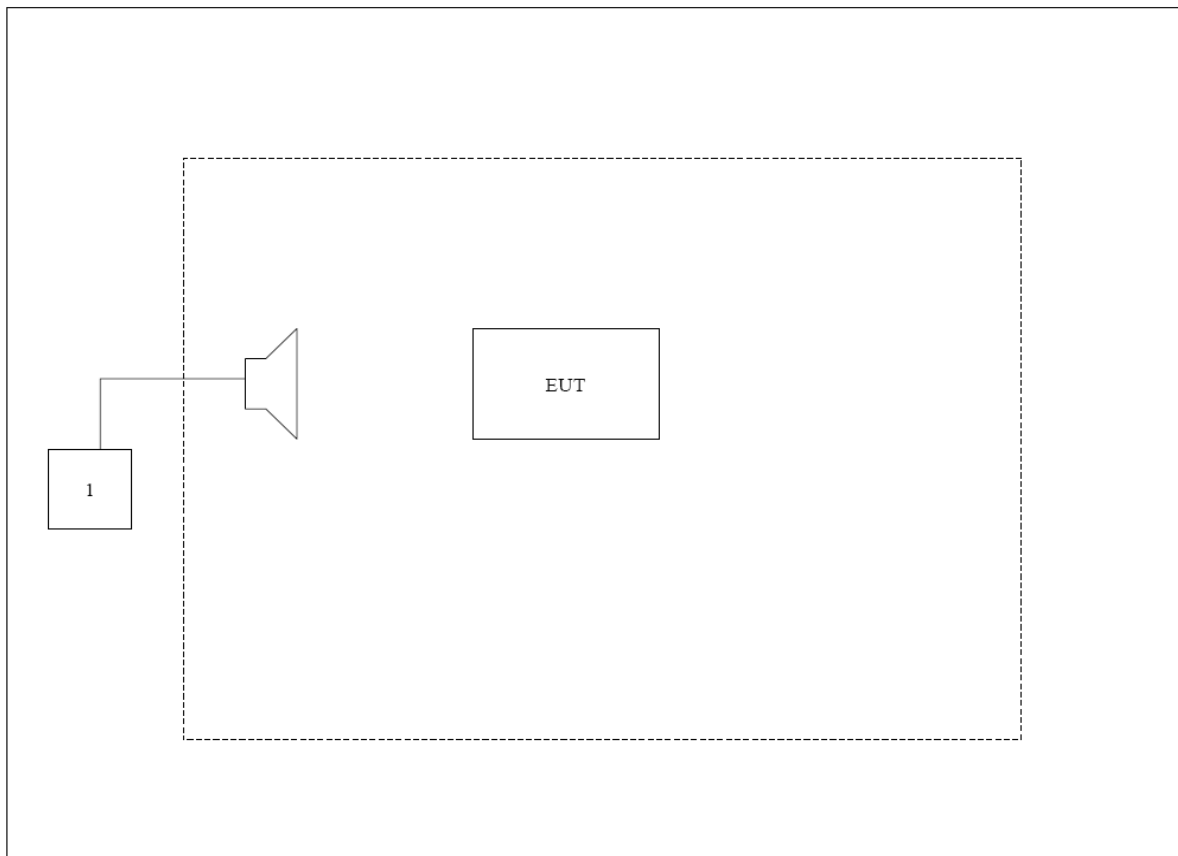

1.5. EUT Exercise Software

1	Setup the EUT and simulators as shown on above.
2	Turn on the power of all equipment.
3	EUT Communicate with CMW500, then select channel to test.

2. Technical Test

2.1. Test Environment

Items	Required (IEC 68-1)	Actual
Temperature (°C)	15-35	22
Humidity (%RH)	25-75	53
Barometric pressure (mbar)	860-1060	950-1000

3. Peak Output Power

3.1. Test Equipment

Instrument	Manufacturer	Model	Serial No.	Due Date
SpectrumAnalyzer	Agilent	N9038A	MY51210142	11/04/2017
RadioCommunicationTester	R&S	CMW500	147483	11/07/2017
SignalGenerator	Agilent	N5183A	MY50140938	01/02/2018
Preamplifier	CEM	EM30180	3008A0245	02/25/2018
DC Power Supply	Agilent	6612C	MY43002989	03/24/2017
Bilog Antenna	Schwarzbeck	VULB9160	9160-3316	09/18/2017
VHF-UHF-Biconical Antenna	Schwarzbeck	VUBA9117	9117-263	09/18/2017
Broad-Band Horn Antenna	Schwarzbeck	BBHA9120D	9120D-942	09/18/2017
Broad-Band Horn Antenna	Schwarzbeck	BBHA9120D	9120D-943	09/18/2017

The measureequipment had been calibrated once a year.

3.2. Test Setup

Conducted Power Measurement:

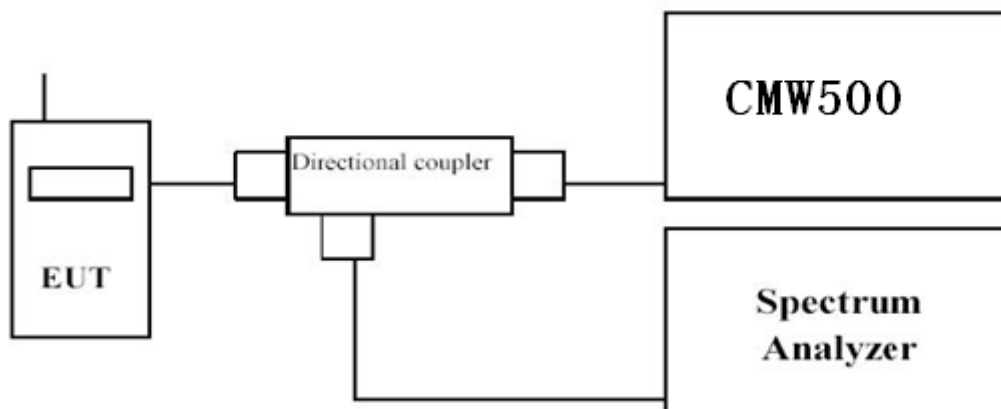

Radiated Spurious Measurement: below 1GHz

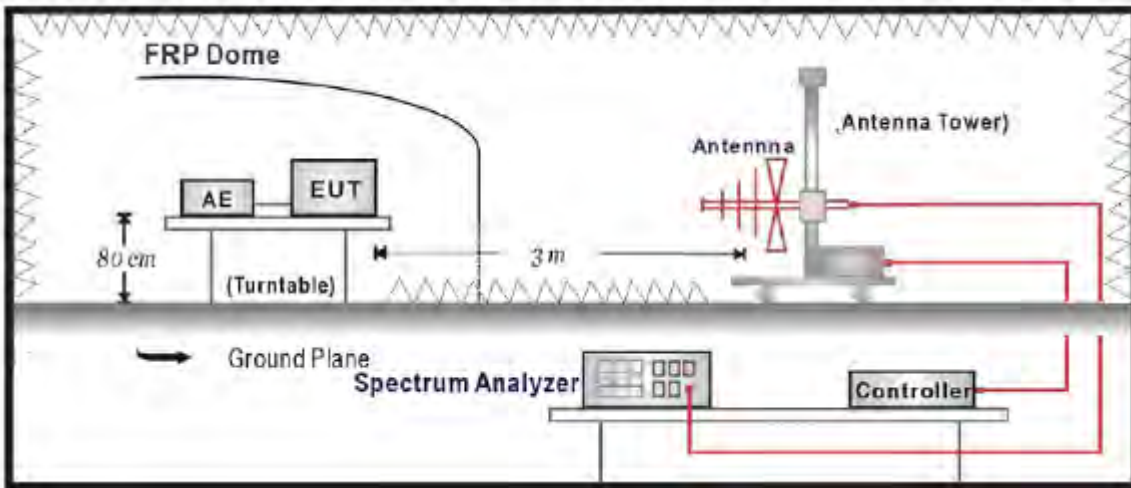

Radiated Spurious Measurement: above 1GHz

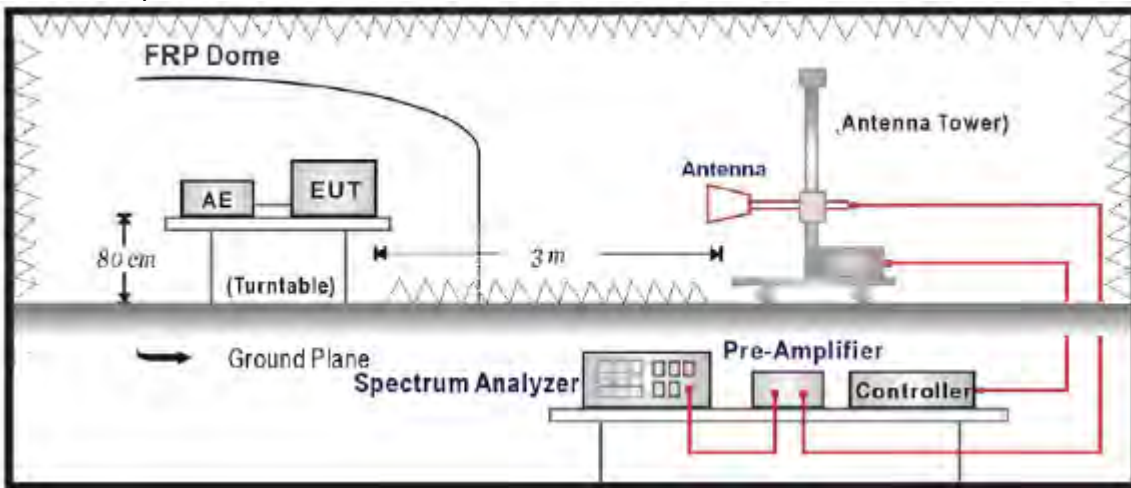

3.3. Limit

For FCC Part 27.50(d):

The EIRP of mobile transmitters and auxiliary test transmitters must not exceed 1 Watt.

For FCC Part 27.50(b):

The ERP of mobile transmitters and auxiliary test transmitters must not exceed 3 Watts.

3.4. Test Procedure

Conducted Power Measurement:

- a. Place the EUT on a bench and set it in transmitting mode.
- b. Connect a low loss RF cable from the antenna port to a spectrum analyzer and CMW500 by a Directional Couple.
- c. EUT Communicate with CMW500, then selects a channel for testing.
- d. Add a correction factor to the display of spectrum, and then test.

Radiated Power Measurement:

- a. The EUT shall be placed at the specified height on a support, and in the position closest to normal use as declared by provider.
- b. The test antenna shall be oriented initially for vertical polarization and shall be chosen to correspond to the frequency of the transmitter
- c. The output of the test antenna shall be connected to the measuring receiver.
- d. The transmitter shall be switched on and the measuring receiver shall be tuned to the frequency of the transmitter under test.
- e. The test antenna shall be raised and lowered through the specified range of height until a maximum signal level is detected by the measuring receiver.
- f. The transmitter shall then be rotated through 360° in the horizontal plane, until the maximum signal level is detected by the measuring receiver.
- g. The test antenna shall be raised and lowered again through the specified range of height until a maximum signal level is detected by the measuring receiver.
- h. The maximum signal level detected by the measuring receiver shall be noted.
- i. The transmitter shall be replaced by a substitution antenna.
- j. The substitution antenna shall be orientated for vertical polarization and the length of the substitution antenna shall be adjusted to correspond to the frequency of the transmitter.
- k. The substitution antenna shall be connected to a calibrated signal generator.
- l. If necessary, the input attenuator setting of the measuring receiver shall be adjusted in order to increase the sensitivity of the measuring receiver.
- m. The test antenna shall be raised and lowered through the specified range of height to ensure that the maximum signal is received.
- n. The input signal to the substitution antenna shall be adjusted to the level that produces a level detected by the measuring receiver, that is equal to the level noted while the transmitter radiated power was measured, corrected for the change of input attenuator setting of the measuring receiver.
- o. The measurement shall be repeated with the test antenna and the substitution antenna orientated for horizontal polarization.
- p. The measure of the effective radiated power is the larger of the two levels recorded at the input to the substitution antenna, corrected for gain of the substitution antenna if necessary.
- q. Test site anechoic chamber refer to ANSI C63.4: 2014.

3.5. Uncertainty

The measurement uncertainty is defined as for Conducted Power Measurement ± 1.1 dB,
for Radiated Power Measurement ± 3.1 dB

3.6. Test Result

The following table shows the two modes of modulation (QPSK&16-QAM) in different channels under the different RB configuration the largest conducted power measured result:

12V DC:

Mode	Band Width	Channel	Frequency (MHz)	Modulation	RB Configuration		Average Power (dBm)	Average Power (Watts)
					RB Size	RB Offset		
LTE Band 4	5 MHz	19975	1712.5	QPSK	1	0	22.01	0.16
				16-QAM	1	0	21.64	0.15
		20175	1732.5	QPSK	1	0	21.98	0.16
				16-QAM	1	0	21.24	0.13
		20375	1752.5	QPSK	1	24	22.01	0.16
				16-QAM	8	17	20.71	0.12
	10 MHz	20000	1715.0	QPSK	1	49	22.10	0.16
				16-QAM	1	0	22.07	0.16
		20175	1732.5	QPSK	1	0	21.88	0.15
				16-QAM	1	0	21.65	0.15
		20350	1750.0	QPSK	1	49	22.17	0.16
				16-QAM	1	49	22.07	0.16
LTE Band 13	5MHz	23205	779.5	QPSK	1	0	22.51	0.18
				16-QAM	1	0	22.11	0.16
		23230	782.0	QPSK	1	0	22.55	0.18
				16-QAM	1	24	21.89	0.15
		23255	784.5	QPSK	1	0	22.23	0.17
				16-QAM	1	0	21.01	0.13
	10MHz	23230	782.0	QPSK	1	0	22.26	0.17
				16-QAM	1	0	22.08	0.16

24V DC:

Mode	Band Width	Channel	Frequency (MHz)	Modulation	RB Configuration		Average Power (dBm)	Average Power (Watts)
					RB Size	RB Offset		
LTE Band 4	5 MHz	19975	1712.5	QPSK	1	0	22.01	0.16
				16-QAM	8	17	20.90	0.12
		20175	1732.5	QPSK	8	17	21.46	0.14
				16-QAM	8	17	20.43	0.11
		20375	1752.5	QPSK	1	24	22.42	0.17
				16-QAM	1	24	21.64	0.15
	10 MHz	20000	1715.0	QPSK	1	0	22.25	0.17
				16-QAM	1	0	22.14	0.16
		20175	1732.5	QPSK	1	0	21.88	0.15
				16-QAM	1	0	21.71	0.15
		20350	1750.0	QPSK	1	49	22.12	0.16

				16-QAM	1	49	20.57	0.11
LTE Band 13	5MHz	23205	779.5	QPSK	1	0	22.27	0.17
				16-QAM	8	17	21.19	0.13
		23230	782.0	QPSK	1	0	22.41	0.17
				16-QAM	1	24	21.67	0.15
	10MHz	23255	784.5	QPSK	1	0	22.13	0.16
				16-QAM	1	0	20.91	0.12
		23230	782.0	QPSK	1	0	22.50	0.18
				16-QAM	1	0	22.43	0.17

The following table shows the Radiated power measured :

12V DC:

LTE Band 4 (QPSK, Band Width 5MHz, RB Size 1 RB Offset 0)

Frequency(MHz)	Ant. Pol. (H/V)	SG Reading(dBm)	Cable Loss(dB)	Gain (dBd)	ERP (dBm)	ERP (W)
Low Channel 19975(1712.5MHz)						
1712.5	H	18.98	6.15	9.42	22.25	0.17
1712.5	V	18.90	6.15	9.42	22.17	0.16
Middle Channel 20175 (1732.5MHz)						
1732.5	H	19.04	6.19	9.44	22.29	0.17
1732.5	V	18.96	6.19	9.44	22.21	0.17
High Channel 20375 (1752.5MHz)						
1752.5	H	19.06	6.2	9.47	22.33	0.17
1752.5	V	18.91	6.2	9.47	22.18	0.17

LTE Band 4 (16-QAM, Band Width 5MHz, RB Size 1 RB Offset 0)

Frequency(MHz)	Ant. Pol. (H/V)	SG Reading(dBm)	Cable Loss(dB)	Gain (dBd)	ERP (dBm)	ERP (W)
Low Channel 19975(1712.5MHz)						
1712.5	H	18.91	6.15	9.42	22.18	0.17
1712.5	V	18.82	6.15	9.42	22.09	0.16
Middle Channel 20175 (1732.5MHz)						
1732.5	H	18.53	6.19	9.44	21.78	0.15
1732.5	V	18.50	6.19	9.44	21.75	0.15
High Channel 20375 (1752.5MHz)						
1752.5	H	18.27	6.2	9.47	21.54	0.14
1752.5	V	18.12	6.2	9.47	21.39	0.14

LTE Band 4 (QPSK, Band Width 10MHz, RB Size 1 RB Offset 49)

Frequency(MHz)	Ant. Pol. (H/V)	SG Reading(dBm)	Cable Loss(dB)	Gain (dBd)	ERP (dBm)	ERP (W)
Low Channel 20000(1715.0MHz)						
1715.0	H	19.21	6.15	9.42	22.48	0.18
1715.0	V	19.15	6.15	9.42	22.42	0.17
Middle Channel 20175 (1732.5MHz)						
1732.5	H	19.14	6.19	9.44	22.39	0.17
1732.5	V	18.93	6.19	9.44	22.18	0.17
High Channel 20350 (1750.0MHz)						
1750.0	H	19.30	6.2	9.47	22.57	0.18
1750.0	V	19.17	6.2	9.47	22.44	0.18

LTE Band 4 (16-QAM, Band Width 10MHz, RB Size 1 RB Offset 0)

Frequency(MHz)	Ant. Pol. (H/V)	SG Reading(dBm)	Cable Loss(dB)	Gain (dBd)	ERP (dBm)	ERP (W)
Low Channel 20000(1715.0MHz)						
1715.0	H	19.20	6.15	9.42	22.47	0.18
1715.0	V	19.11	6.15	9.42	22.38	0.17
Middle Channel 20175 (1732.5MHz)						
1732.5	H	19.11	6.19	9.44	22.36	0.17
1732.5	V	19.08	6.19	9.44	22.33	0.17
High Channel 20350 (1750.0MHz)						
1750.0	H	19.24	6.2	9.47	22.51	0.18
1750.0	V	19.12	6.2	9.47	22.39	0.17

LTE Band 13 (QPSK, Band Width 5MHz, RB Size 1 RB Offset 0)

Frequency(MHz)	Ant. Pol. (H/V)	SG Reading(dBm)	Cable Loss(dB)	Gain (dBd)	ERP (dBm)	ERP (W)
Low Channel 23205(779.5MHz)						
779.5	H	29.82	3.33	-3.55	22.94	0.20
779.5	V	29.63	3.33	-3.55	22.75	0.19
Middle Channel 23230 (782.0MHz)						
782.0	H	29.82	3.46	-3.48	22.88	0.19
782.0	V	29.59	3.46	-3.48	22.65	0.18
High Channel 23255 (784.5MHz)						
784.5	H	29.51	3.49	-3.41	22.61	0.18
784.5	V	29.35	3.49	-3.41	22.45	0.18

LTE Band 13 (16-QAM, Band Width 5MHz, RB Size 1 RB Offset 0)

Frequency(MHz)	Ant. Pol. (H/V)	SG Reading(dBm)	Cable Loss(dB)	Gain (dBd)	ERP (dBm)	ERP (W)
Low Channel 23205(779.5MHz)						
779.5	H	29.44	3.33	-3.55	22.56	0.18
779.5	V	29.35	3.33	-3.55	22.47	0.18
Middle Channel 23230 (782.0MHz)						
782.0	H	29.40	3.46	-3.48	22.46	0.18
782.0	V	29.32	3.46	-3.48	22.38	0.17
High Channel 23255 (784.5MHz)						
784.5	H	28.68	3.49	-3.41	21.78	0.15
784.5	V	28.61	3.49	-3.41	21.71	0.15

LTE Band 13 (QPSK, Band Width 10MHz, RB Size 1 RB Offset 0)

Frequency(MHz)	Ant. Pol. (H/V)	SG Reading(dBm)	Cable Loss(dB)	Gain (dBd)	ERP (dBm)	ERP (W)
Middle Channel 23230 (782.0MHz)						
782.0	H	29.69	3.46	-3.48	22.75	0.19
782.0	V	29.40	3.46	-3.48	22.46	0.18

LTE Band 13 (16-QAM, Band Width 10MHz, RB Size 1 RB Offset 0)

Frequency(MHz)	Ant. Pol. (H/V)	SG Reading(dBm)	Cable Loss(dB)	Gain (dBd)	ERP (dBm)	ERP (W)
Middle Channel 23230 (782.0MHz)						
782.0	H	29.42	3.46	-3.48	22.48	0.18
782.0	V	29.35	3.46	-3.48	22.41	0.17

24V DC:

LTE Band 4 (QPSK, Band Width 5MHz, RB Size 1 RB Offset 24)

Frequency(MHz)	Ant. Pol. (H/V)	SG Reading(dBm)	Cable Loss(dB)	Gain (dBd)	ERP (dBm)	ERP (W)
Low Channel 19975(1712.5MHz)						
1712.5	H	19.21	6.15	9.42	22.48	0.18
1712.5	V	19.12	6.15	9.42	22.39	0.17
Middle Channel 20175 (1732.5MHz)						
1732.5	H	18.87	6.19	9.44	22.12	0.16
1732.5	V	18.79	6.19	9.44	22.04	0.16
High Channel 20375 (1752.5MHz)						
1752.5	H	19.60	6.2	9.47	22.87	0.19
1752.5	V	19.29	6.2	9.47	22.56	0.18

LTE Band 4 (16-QAM, Band Width 5MHz, RB Size 1 RB Offset 24)

Frequency(MHz)	Ant. Pol. (H/V)	SG Reading(dBm)	Cable Loss(dB)	Gain (dBd)	ERP (dBm)	ERP (W)
Low Channel 19975(1712.5MHz)						
1712.5	H	18.28	6.15	9.42	21.55	0.14
1712.5	V	18.21	6.15	9.42	21.48	0.14
Middle Channel 20175 (1732.5MHz)						
1732.5	H	17.88	6.19	9.44	21.13	0.13
1732.5	V	17.82	6.19	9.44	21.07	0.13
High Channel 20375 (1752.5MHz)						
1752.5	H	18.87	6.2	9.47	22.14	0.16
1752.5	V	18.70	6.2	9.47	21.97	0.16

LTE Band 4 (QPSK, Band Width 10MHz, RB Size 1 RB Offset 0)

Frequency(MHz)	Ant. Pol. (H/V)	SG Reading(dBm)	Cable Loss(dB)	Gain (dBd)	ERP (dBm)	ERP (W)
Low Channel 20000(1715.0MHz)						
1715.0	H	19.41	6.15	9.42	22.68	0.19
1715.0	V	19.21	6.15	9.42	22.48	0.18
Middle Channel 20175 (1732.5MHz)						
1732.5	H	19.11	6.19	9.44	22.36	0.17
1732.5	V	19.08	6.19	9.44	22.33	0.17
High Channel 20350 (1750.0MHz)						
1750.0	H	19.21	6.2	9.47	22.48	0.18
1750.0	V	19.14	6.2	9.47	22.41	0.17

LTE Band 4 (16-QAM, Band Width 10MHz, RB Size 1 RB Offset 0)

Frequency(MHz)	Ant. Pol. (H/V)	SG Reading(dBm)	Cable Loss(dB)	Gain (dBd)	ERP (dBm)	ERP (W)
Low Channel 20000(1715.0MHz)						
1715.0	H	19.38	6.15	9.42	22.65	0.18
1715.0	V	19.24	6.15	9.42	22.51	0.18
Middle Channel 20175 (1732.5MHz)						
1732.5	H	19.09	6.19	9.44	22.34	0.17
1732.5	V	18.93	6.19	9.44	22.18	0.17
High Channel 20350 (1750.0MHz)						
1750.0	H	18.41	6.2	9.47	21.68	0.15
1750.0	V	18.28	6.2	9.47	21.55	0.14

LTE Band 13 (QPSK, Band Width 5MHz, RB Size 1 RB Offset 0)

Frequency(MHz)	Ant. Pol. (H/V)	SG Reading(dBm)	Cable Loss(dB)	Gain (dBd)	ERP (dBm)	ERP (W)
Low Channel 23205(779.5MHz)						
779.5	H	29.55	3.33	-3.55	22.67	0.18
779.5	V	29.44	3.33	-3.55	22.56	0.18
Middle Channel 23230 (782.0MHz)						
782.0	H	29.76	3.46	-3.48	22.82	0.19
782.0	V	29.57	3.46	-3.48	22.63	0.18
High Channel 23255 (784.5MHz)						
784.5	H	29.45	3.49	-3.41	22.55	0.18
784.5	V	29.37	3.49	-3.41	22.47	0.18

LTE Band 13 (16-QAM, Band Width 5MHz, RB Size 1 RB Offset 24)

Frequency(MHz)	Ant. Pol. (H/V)	SG Reading(dBm)	Cable Loss(dB)	Gain (dBd)	ERP (dBm)	ERP (W)
Low Channel 23205(779.5MHz)						
779.5	H	28.57	3.33	-3.55	21.69	0.15
779.5	V	28.52	3.33	-3.55	21.64	0.15
Middle Channel 23230 (782.0MHz)						
782.0	H	29.39	3.46	-3.48	22.45	0.18
782.0	V	29.31	3.46	-3.48	22.37	0.17
High Channel 23255 (784.5MHz)						
784.5	H	28.46	3.49	-3.41	21.56	0.14
784.5	V	28.38	3.49	-3.41	21.48	0.14

LTE Band 13 (QPSK, Band Width 10MHz, RB Size 1 RB Offset 0)

Frequency(MHz)	Ant. Pol. (H/V)	SG Reading(dBm)	Cable Loss(dB)	Gain (dBd)	ERP (dBm)	ERP (W)
Middle Channel 23230 (782.0MHz)						
782.0	H	29.83	3.46	-3.48	22.89	0.19
782.0	V	29.62	3.46	-3.48	22.68	0.19

LTE Band 13 (16-QAM, Band Width 10MHz, RB Size 1 RB Offset 0)

Frequency(MHz)	Ant. Pol. (H/V)	SG Reading(dBm)	Cable Loss(dB)	Gain (dBd)	ERP (dBm)	ERP (W)
Middle Channel 23230 (782.0MHz)						
782.0	H	29.77	3.46	-3.48	22.83	0.19
782.0	V	29.66	3.46	-3.48	22.72	0.19

4. Occupied Bandwidth

4.1. Test Equipment

Occupied Bandwidth

Instrument	Manufacturer	Model	Serial No	Due Date
Radio Communication Tester	R&S	CMW500	147483	11/09/2017
SpectrumAnalyzer	Agilent	N9038A	MY51210142	11/04/2017
DC Power Supply	Agilent	6612C	MY43002989	02/28/2018

The measure equipment had been calibrated once a year.

4.2. Test Setup

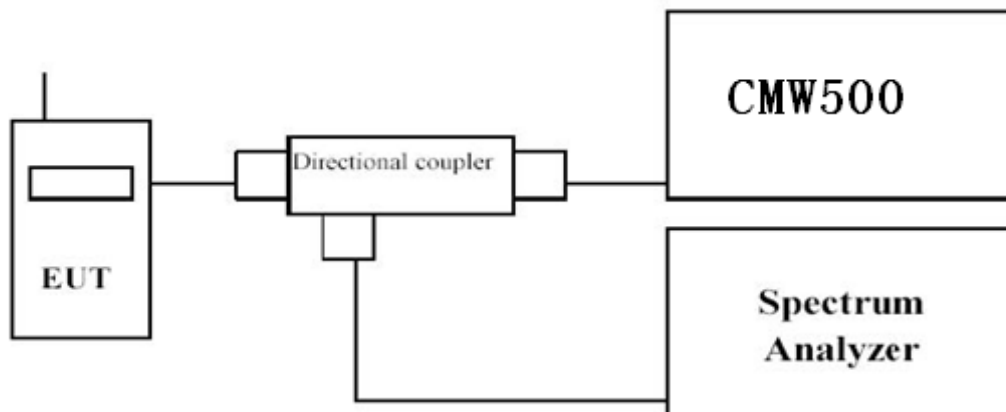

4.3. Limit

N/A

4.4. Test Procedure

1. The testing follows FCC KDB 971168 v02v02 Section 4.2;
2. Using Occupied Bandwidth measurement function of spectrum analyzer. In the Occupied Bandwidth measurement a resolution bandwidth of at least one percent of the emission bandwidth of the fundamental emission of the transmitter may be employed.

4.5. Uncertainty

The measurement uncertainty is defined as ± 10 Hz

4.6. Test Result

12V DC:

LTE Band 4 (QPSK, Band Width 5MHz,RB Size 25,RB Offset 0)

Channel No.	Frequency (GHz)	-26dB Occupied Bandwidth (MHz)	99% Occupied Bandwidth (MHz)
19975	1.713	4.886	4.4950
20175	1.733	4.892	4.4926
20375	1.753	4.891	4.4971

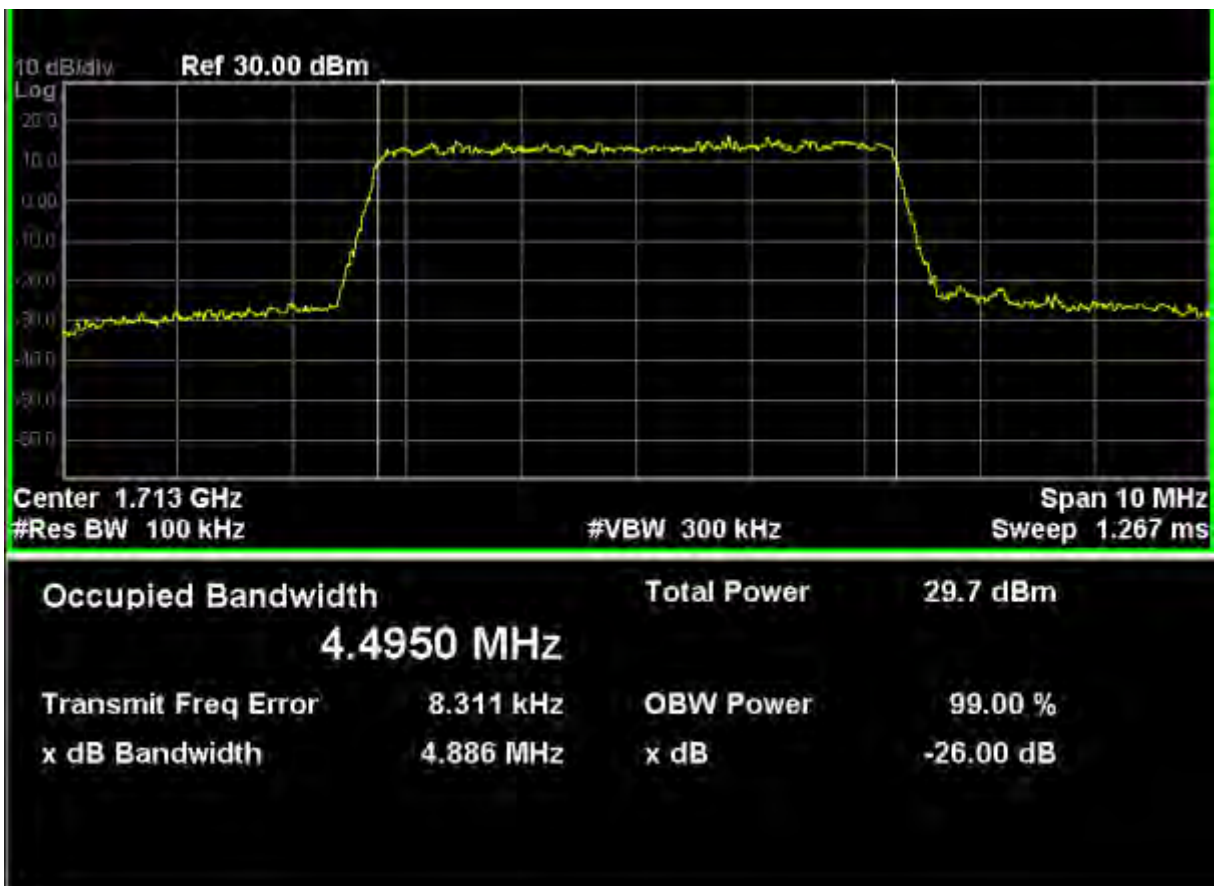

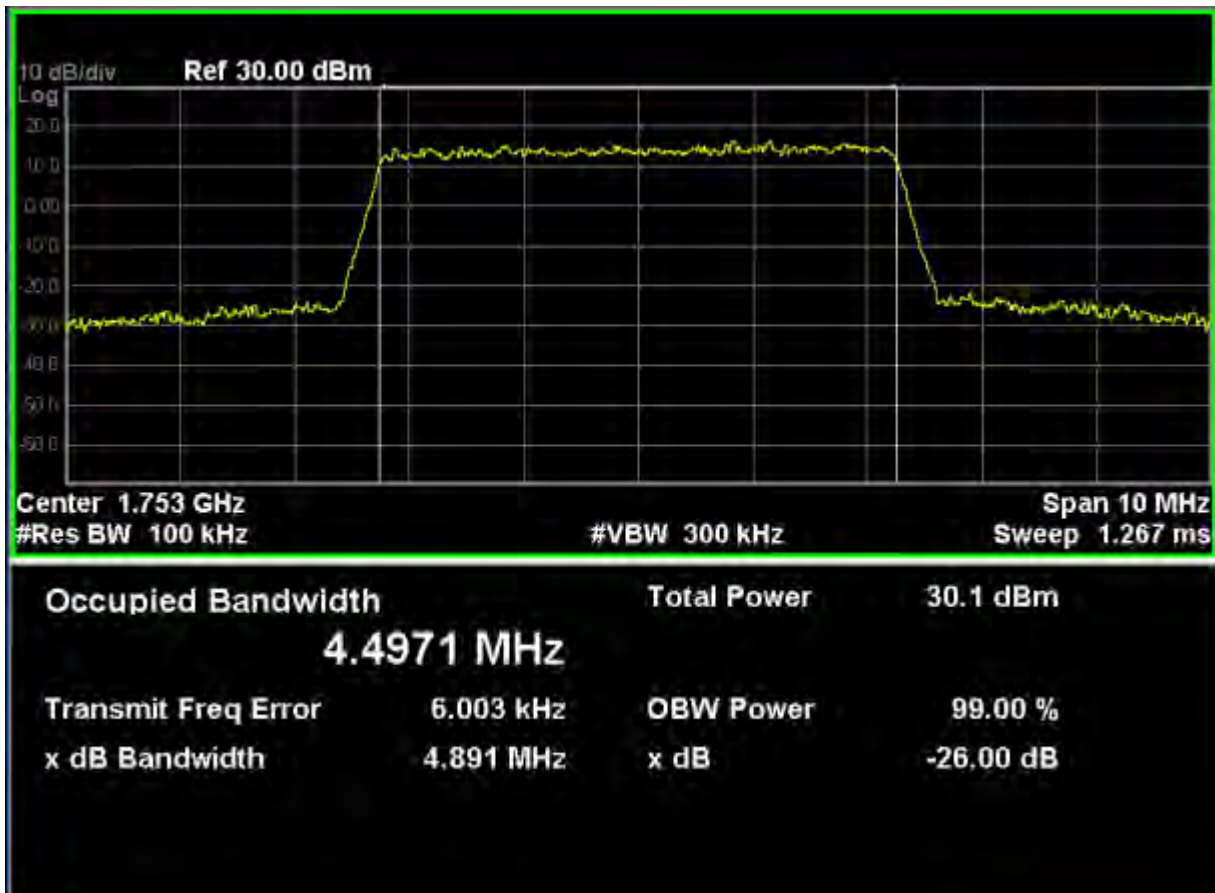
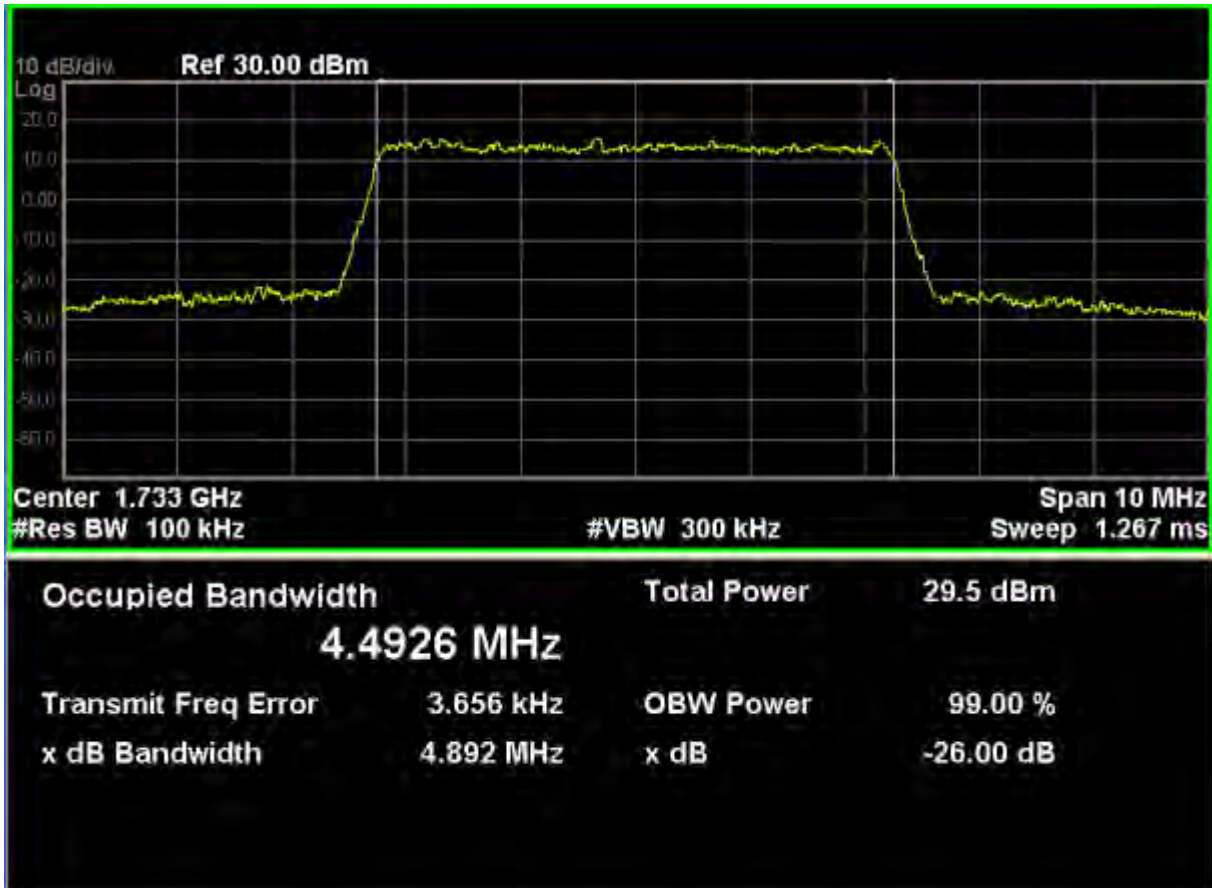

LTE Band 4 (16-QAM, Band Width 5MHz, RB Size 25, RB Offset 0)

Channel No.	Frequency (GHz)	-26dB Occupied Bandwidth (MHz)	99% Occupied Bandwidth (MHz)
19975	1.713	4.945	4.5042
20175	1.733	4.902	4.4892
20375	1.753	4.912	4.5044

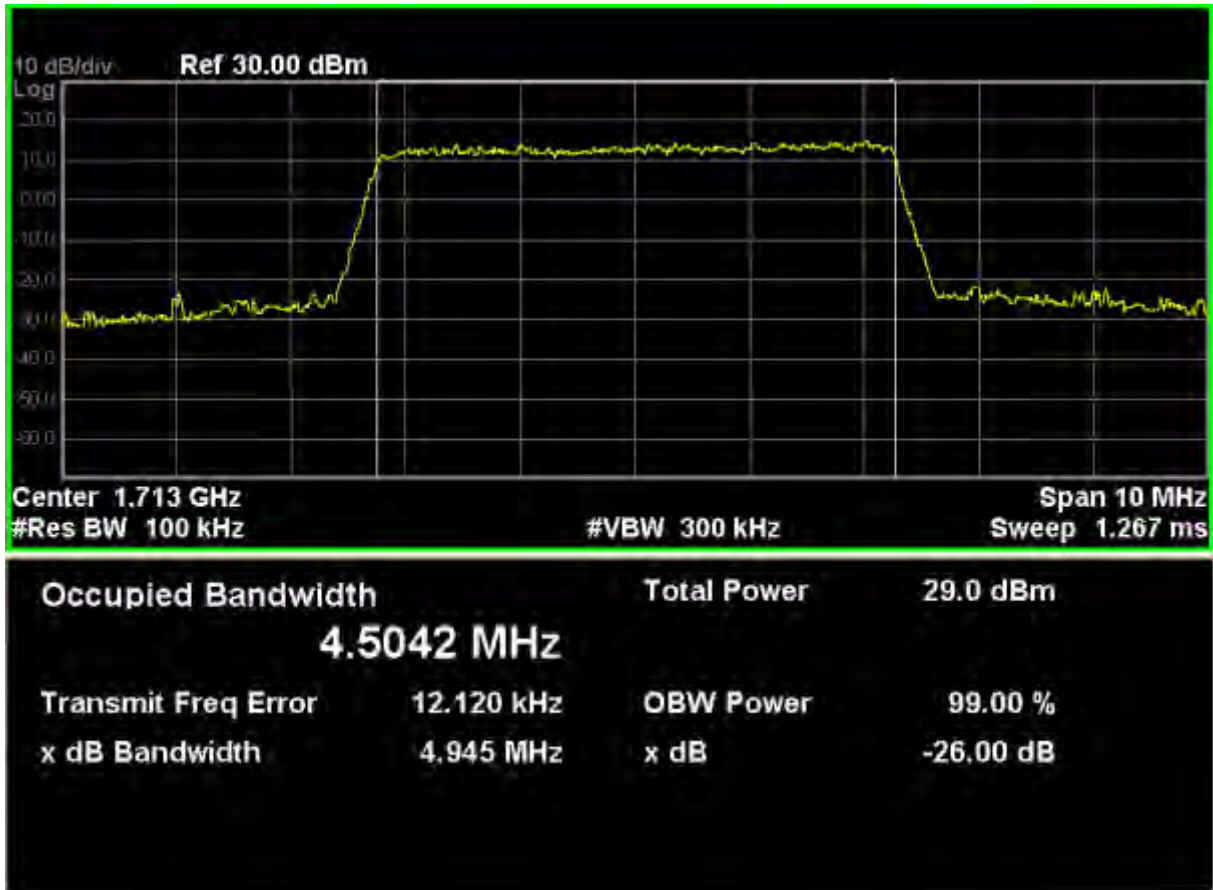

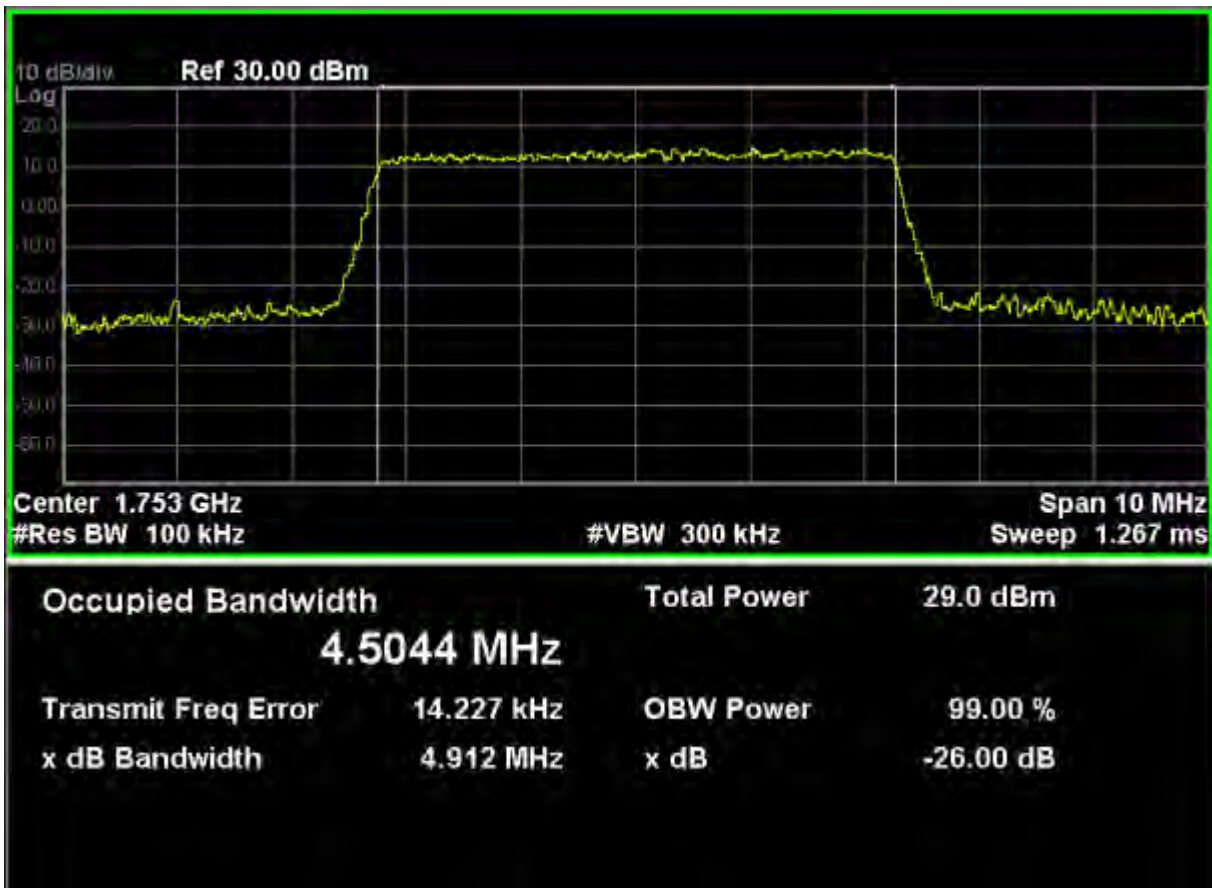
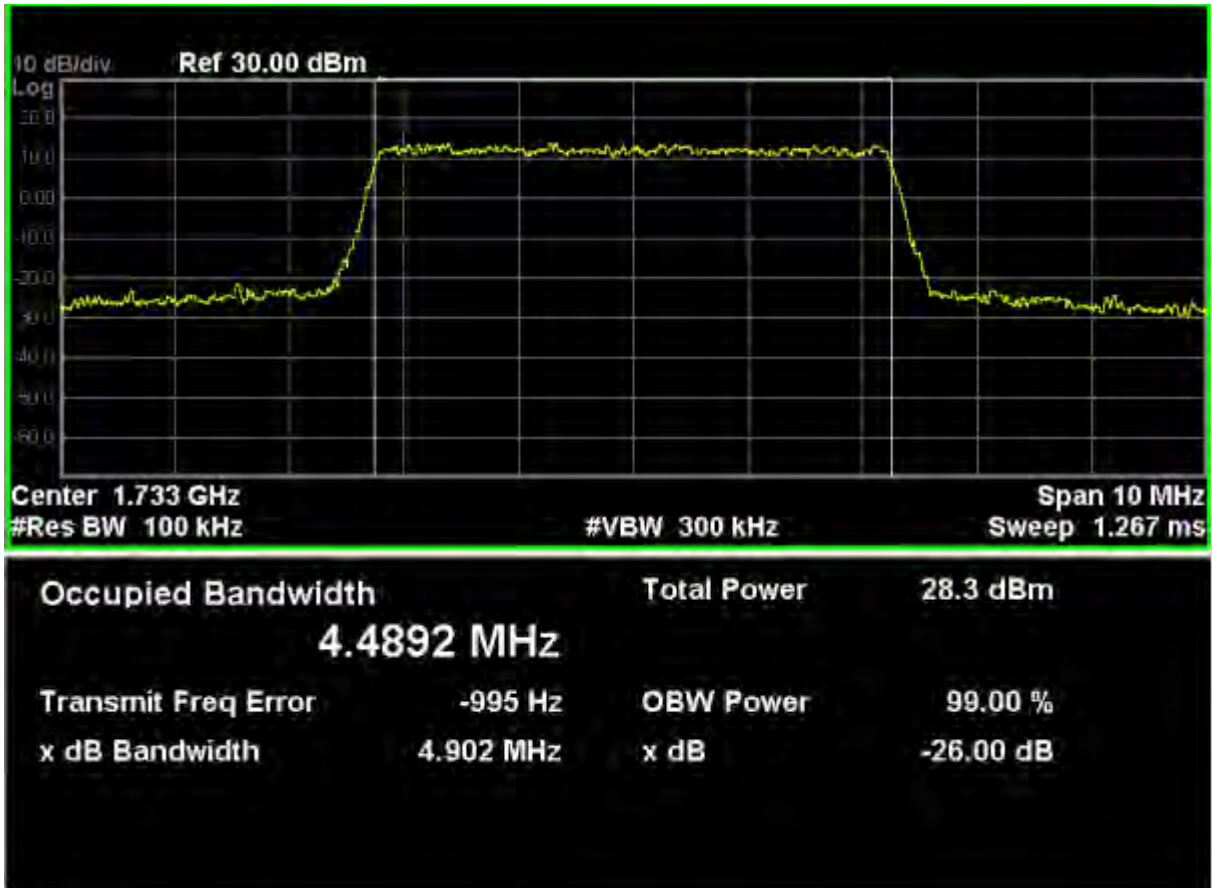

LTE Band 4 (QPSK, Band Width 10MHz, RB Size 50, RB Offset 0)

Channel No.	Frequency (GHz)	-26dB Occupied Bandwidth (MHz)	99% Occupied Bandwidth (MHz)
20000	1.715	9.872	9.0117
20175	1.733	9.944	9.0763
20350	1.750	9.917	9.0606

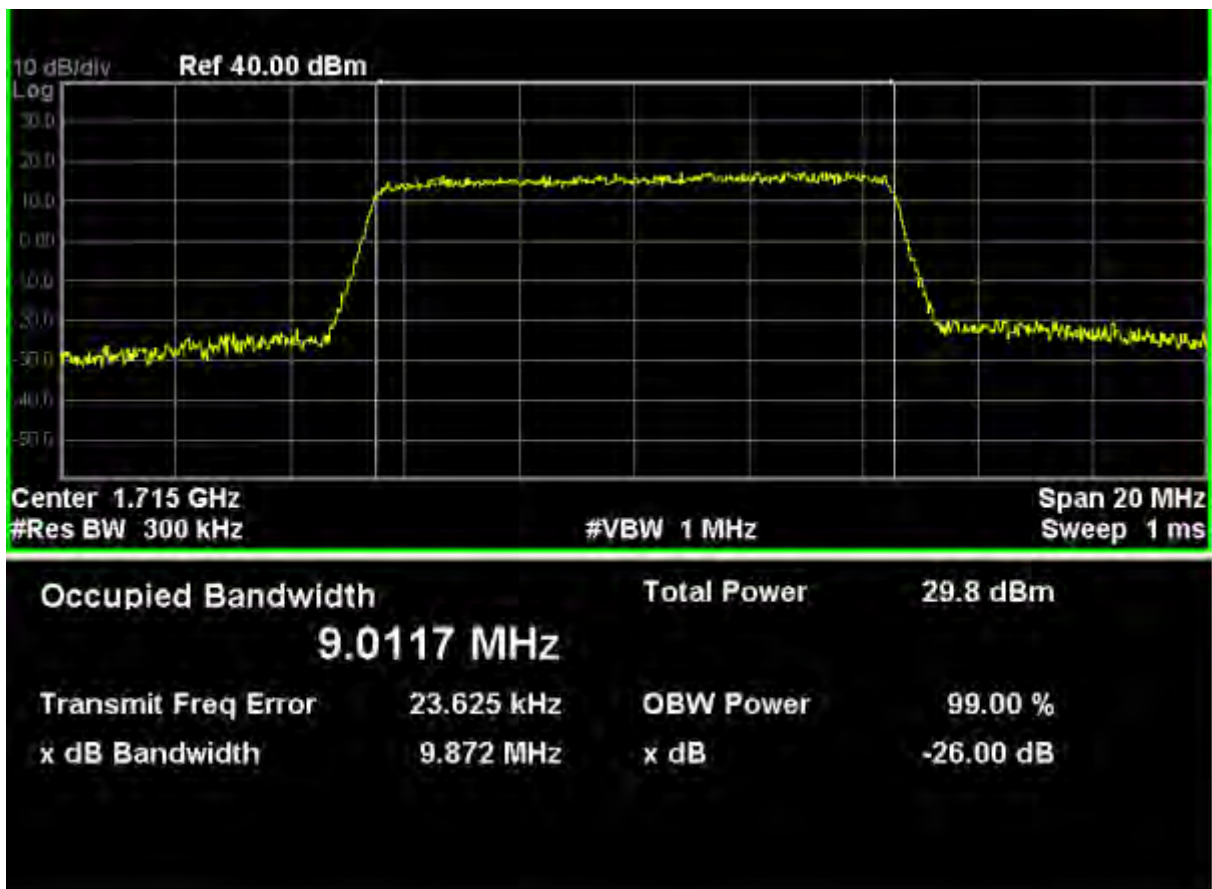

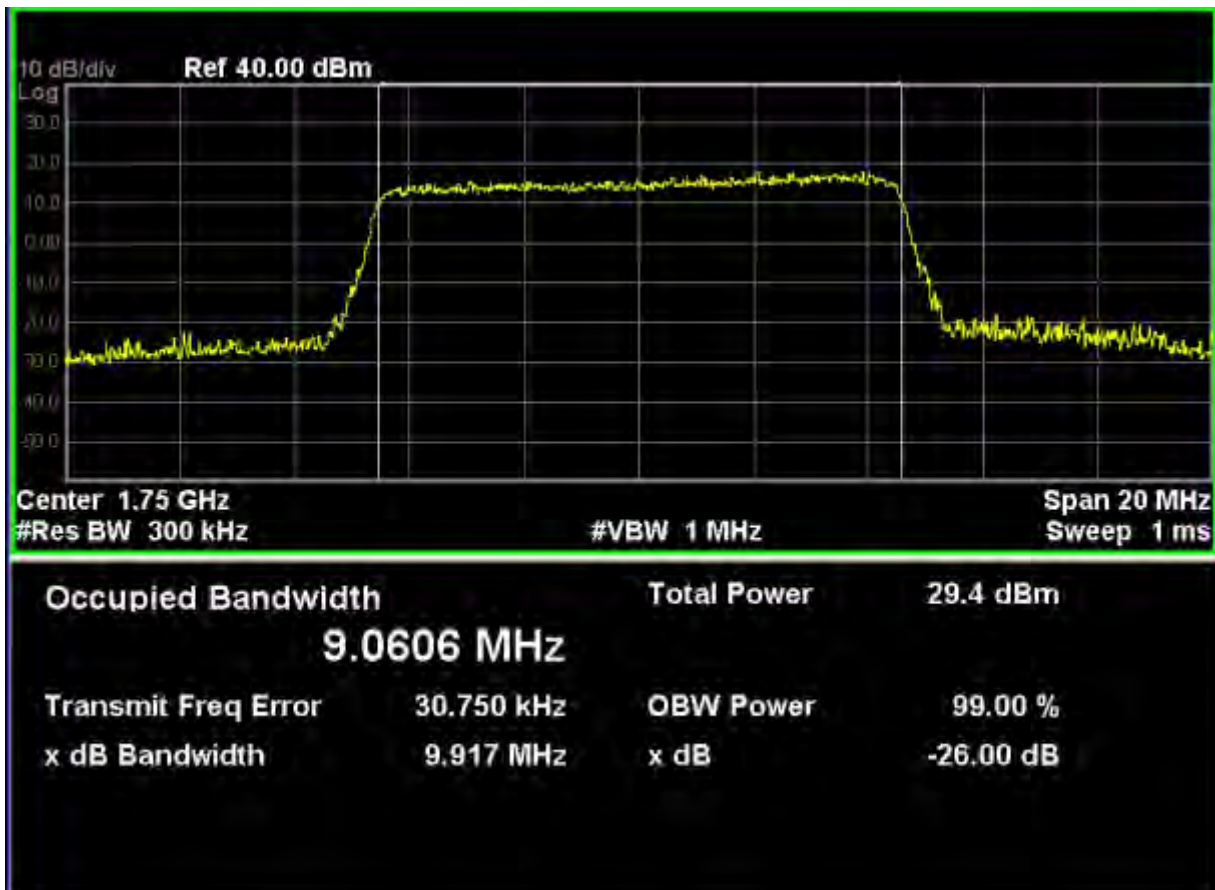

LTE Band 4 (16-QAM, Band Width 10MHz, RB Size 50, RB Offset 0)

Channel No.	Frequency (GHz)	-26dB Occupied Bandwidth (MHz)	99% Occupied Bandwidth (MHz)
20000	1.715	9.843	9.0145
20175	1.733	9.904	9.0328
20350	1.750	9.865	9.0382

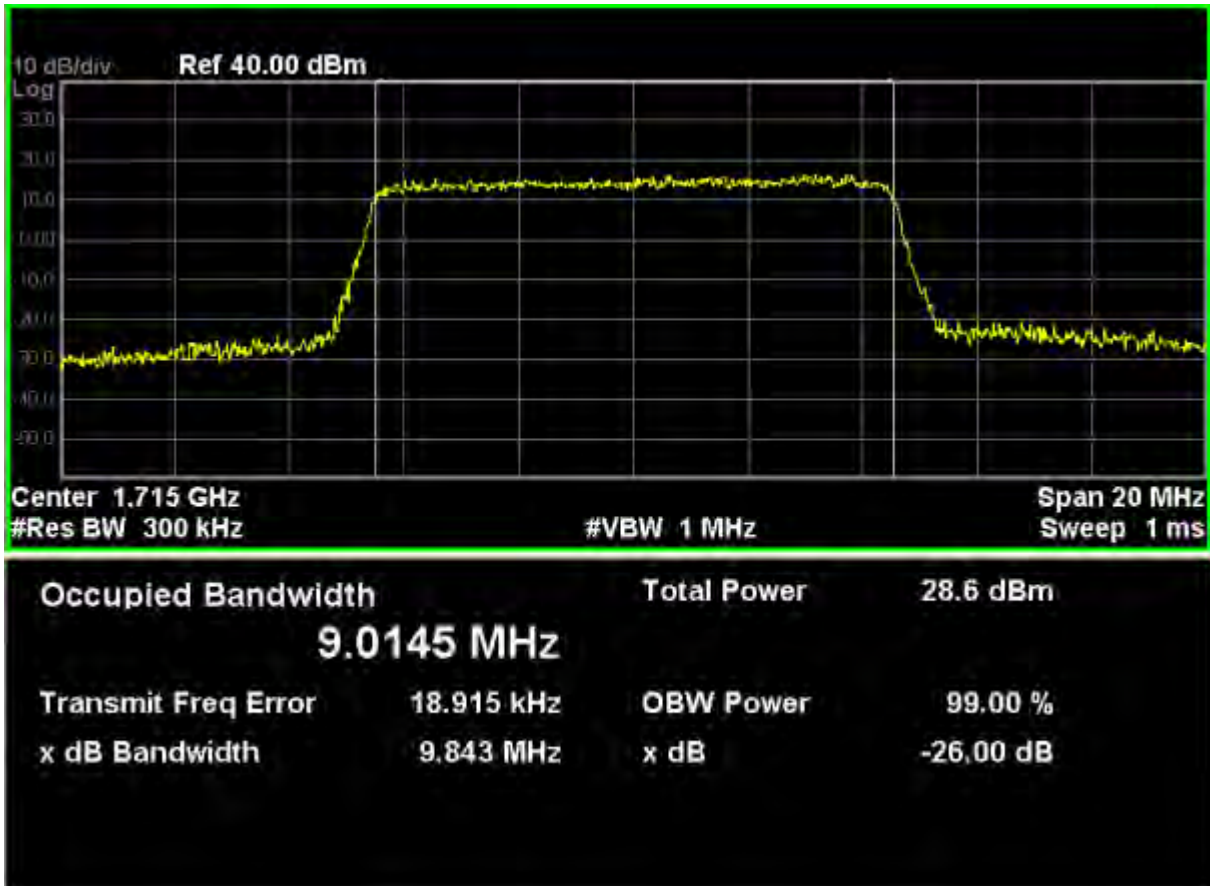

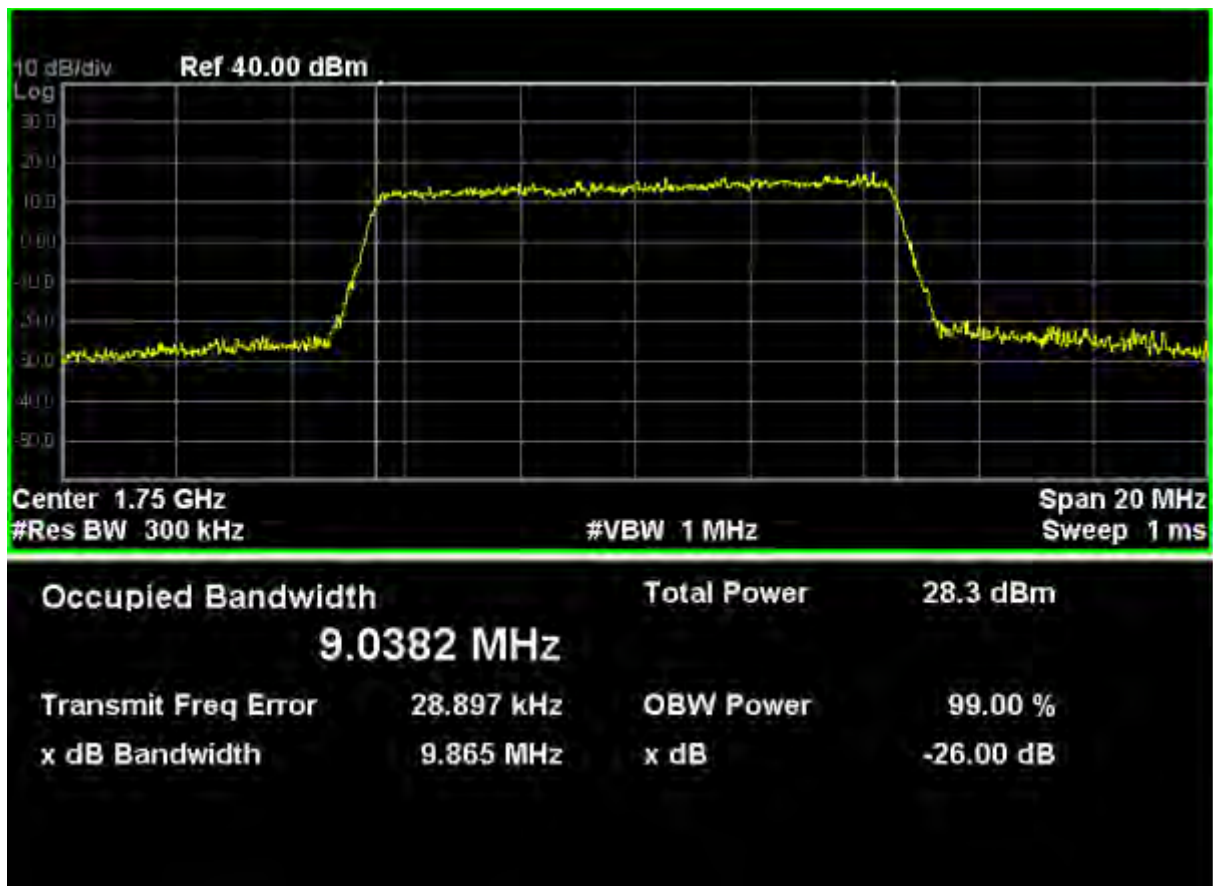
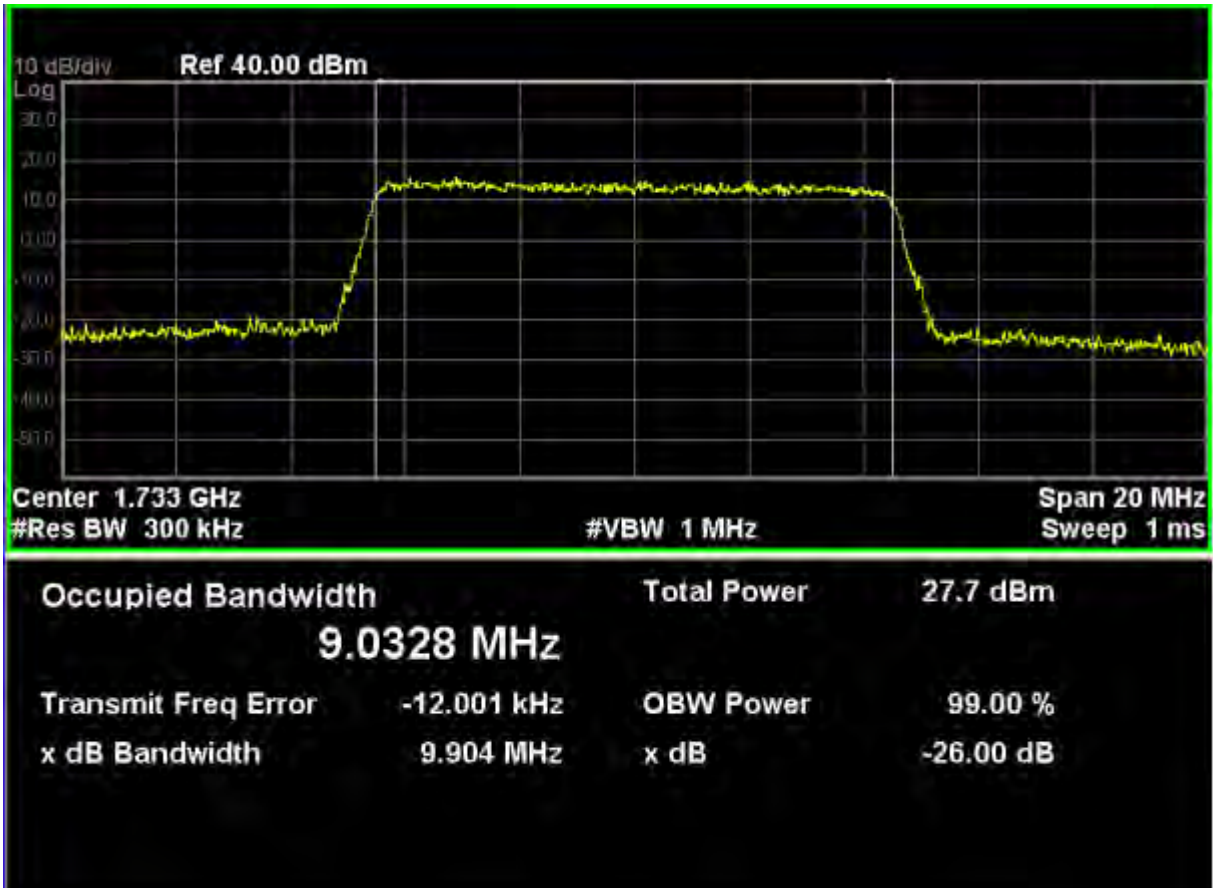

LTE Band 13 (QPSK, Band Width 5MHz,RB Size 25,RB Offset 0)

Channel No.	Frequency (MHz)	-26dB Occupied Bandwidth (MHz)	99% Occupied Bandwidth (MHz)
23205	779.5	4.889	4.4958
23230	782.0	4.895	4.4932
23255	784.5	4.910	4.5013

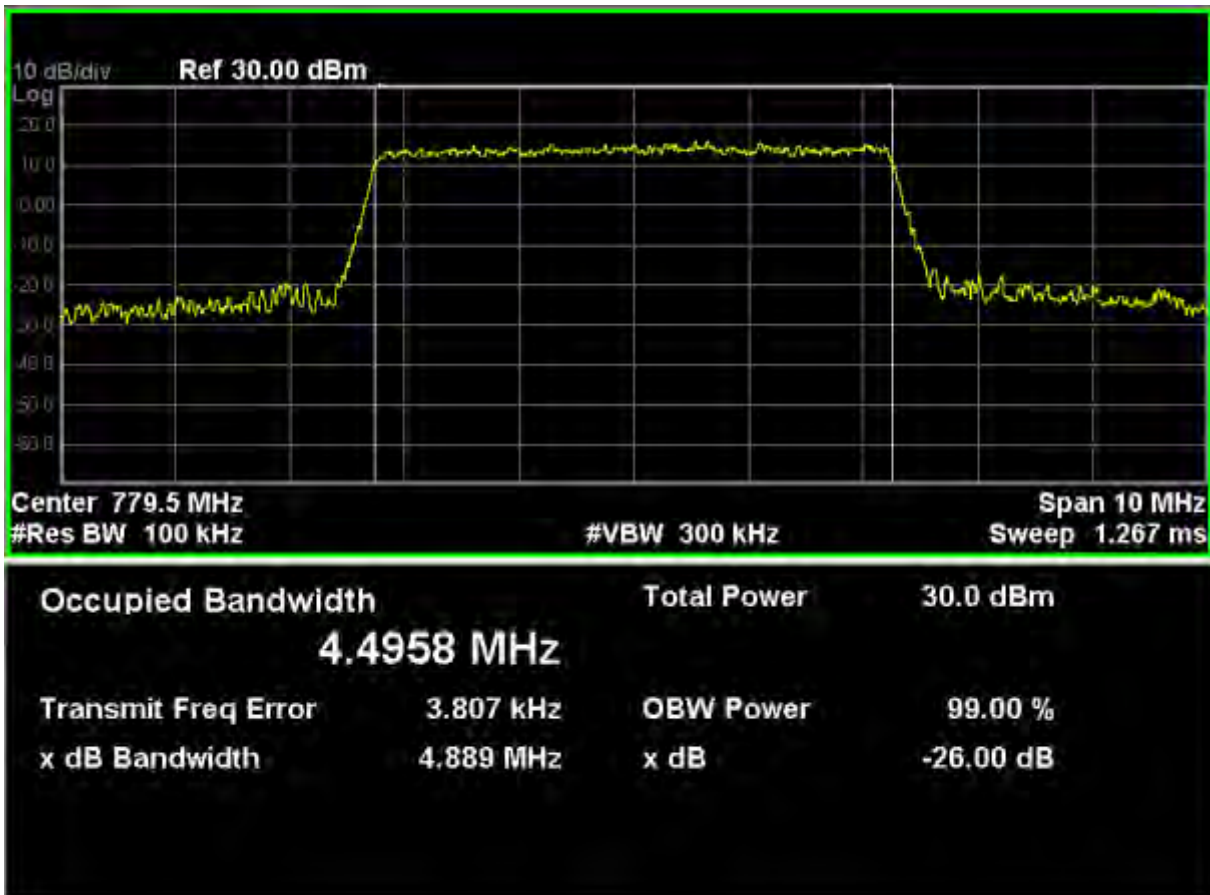

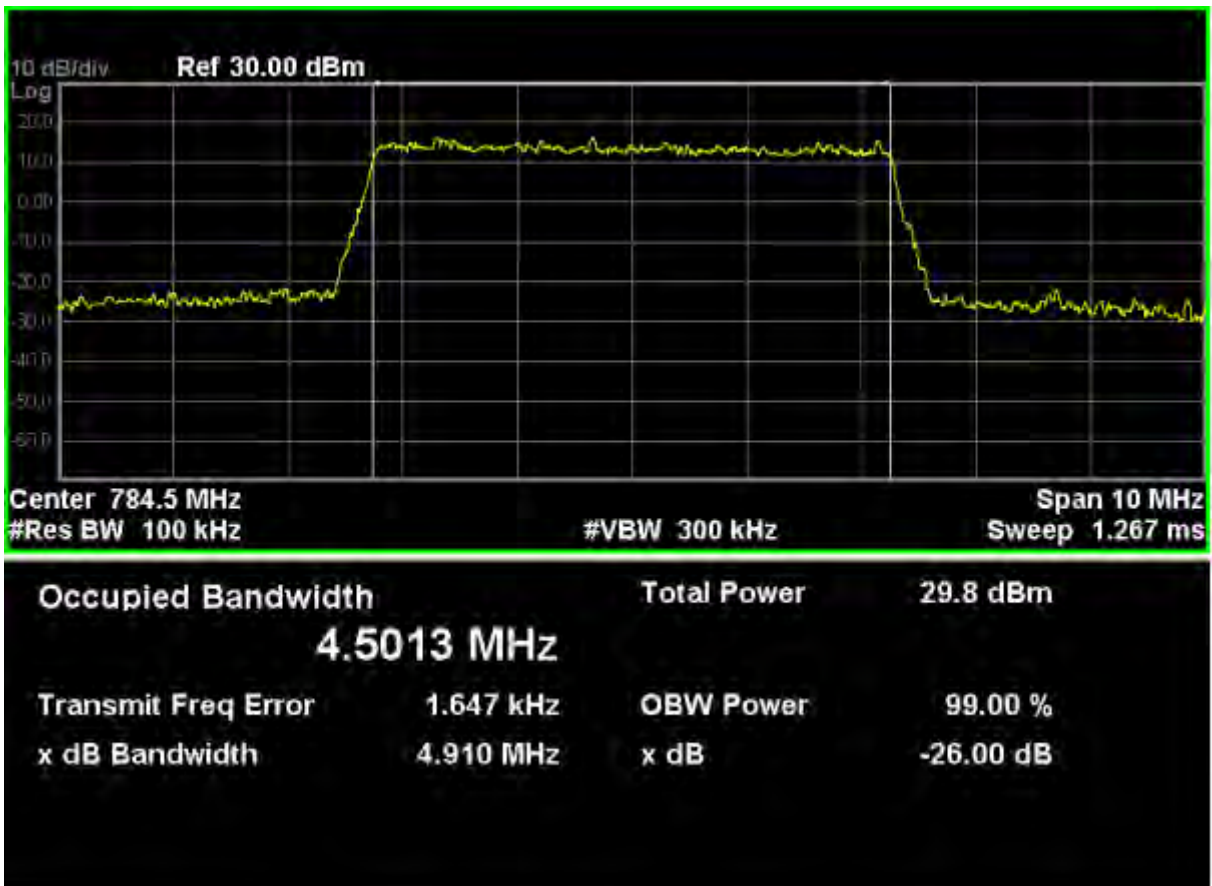
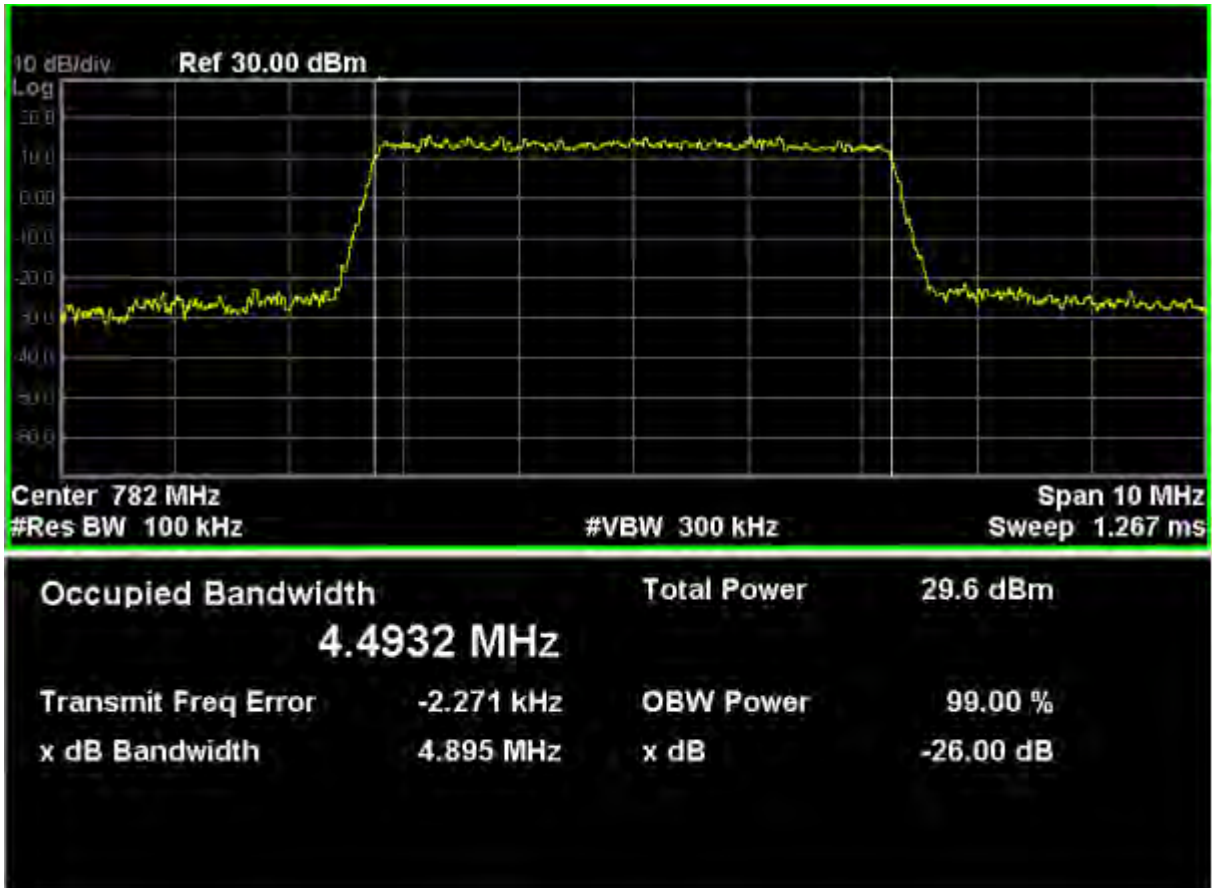

LTE Band 13 (16-QAM, Band Width 5MHz, RB Size 25, RB Offset 0)

Channel No.	Frequency (MHz)	-26dB Occupied Bandwidth (MHz)	99% Occupied Bandwidth (MHz)
23205	779.5	4.867	4.4855
23230	782.0	4.881	4.4854
23255	784.5	4.924	4.5038

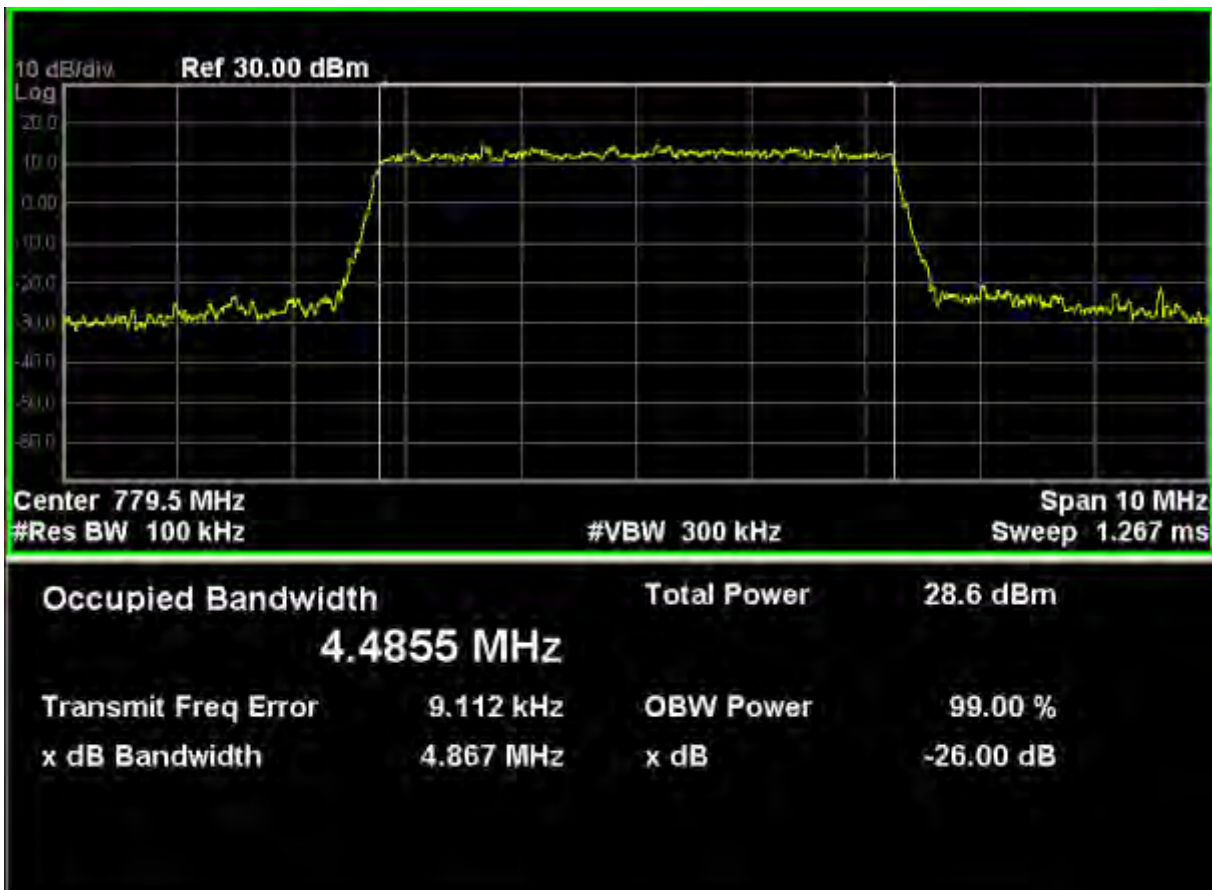

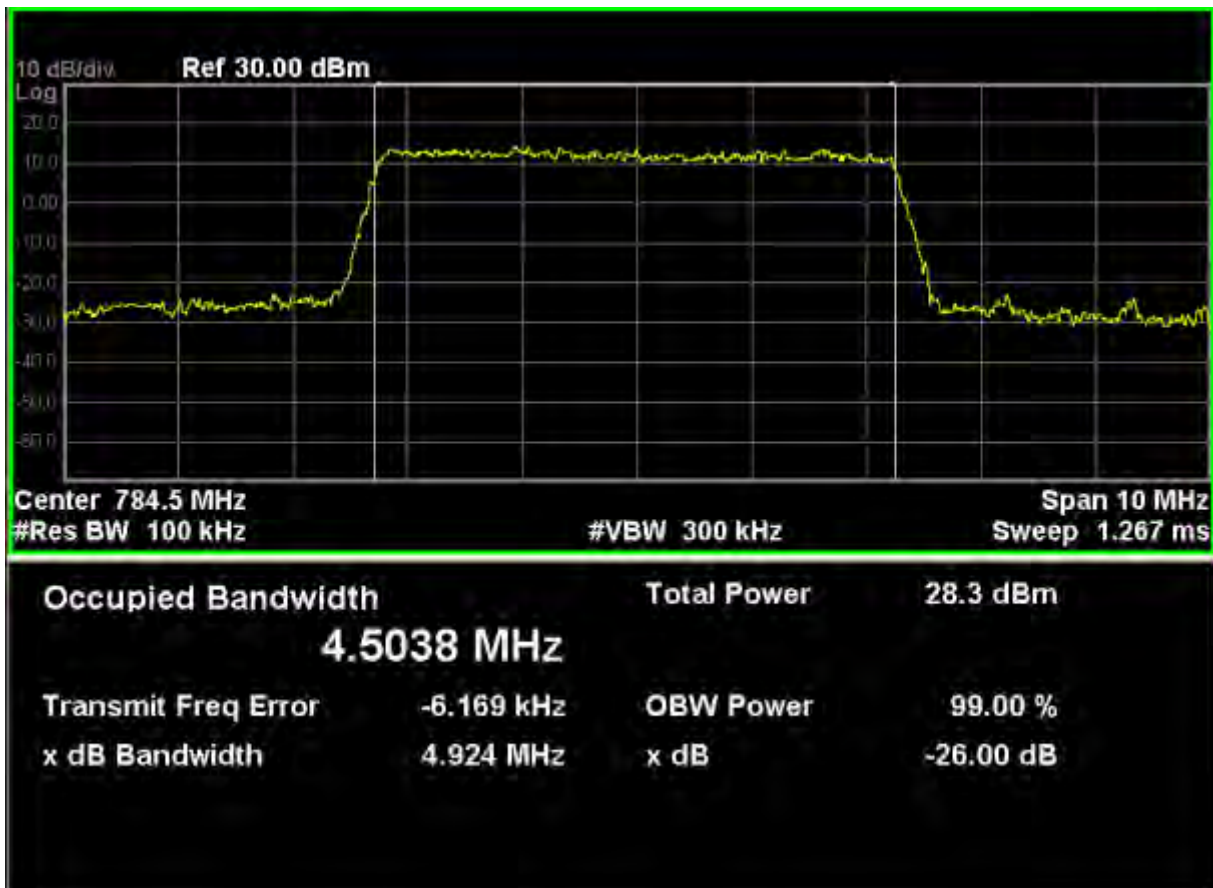
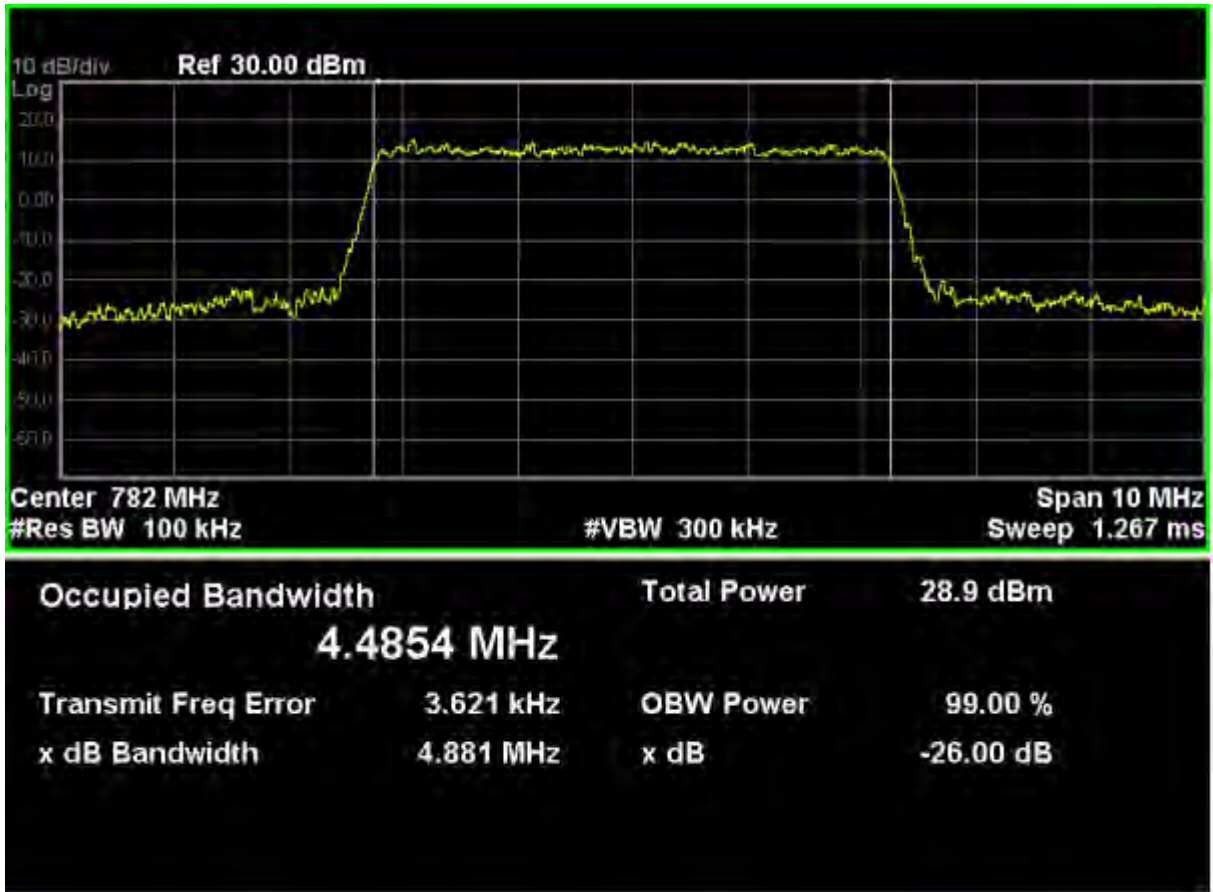

LTE Band 13 (QPSK&16-QAM, Band Width 10MHz, RB Size 50, RB Offset 0)

Channel No.	Frequency (MHz)	-26dB Occupied Bandwidth (MHz)	99% Occupied Bandwidth (MHz)
23230	782.0	9.865	9.0081
23230	782.0	9.861	9.0014

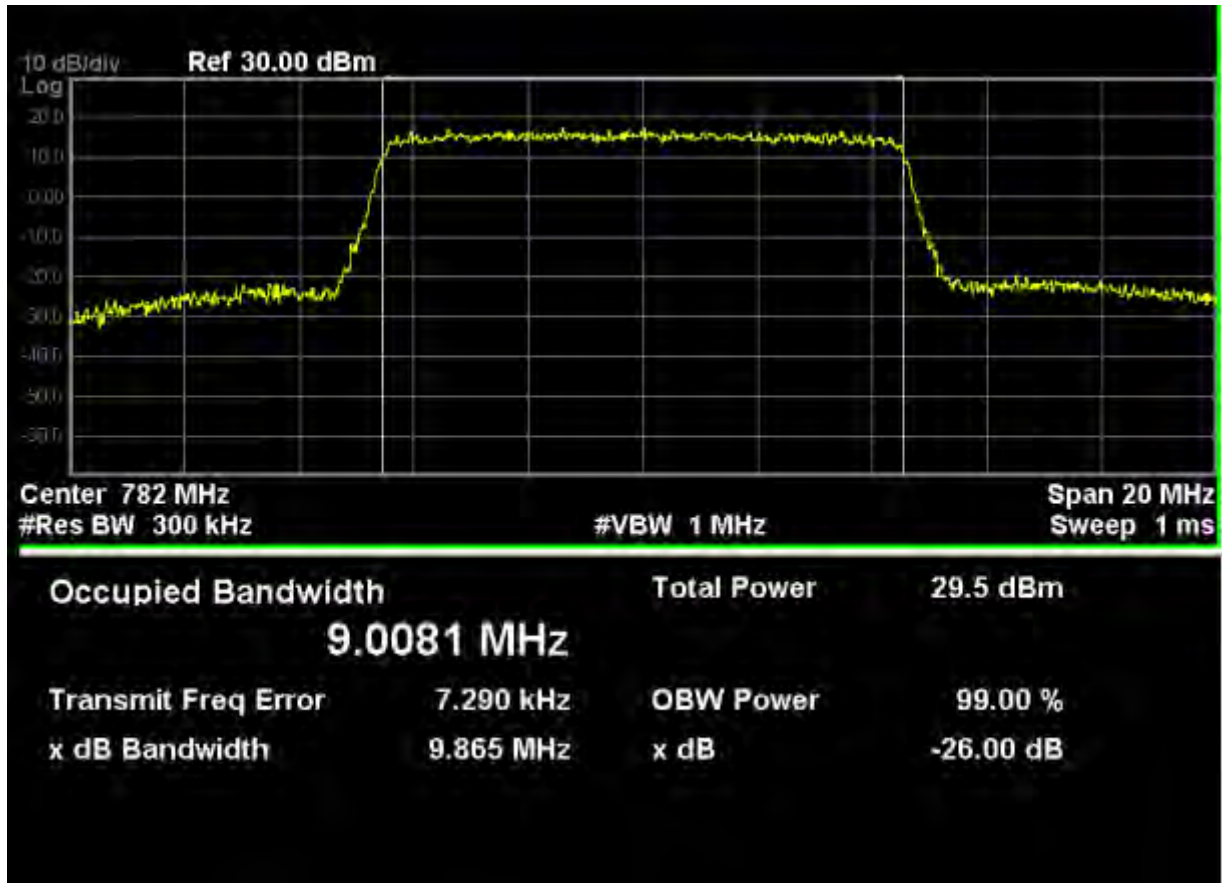

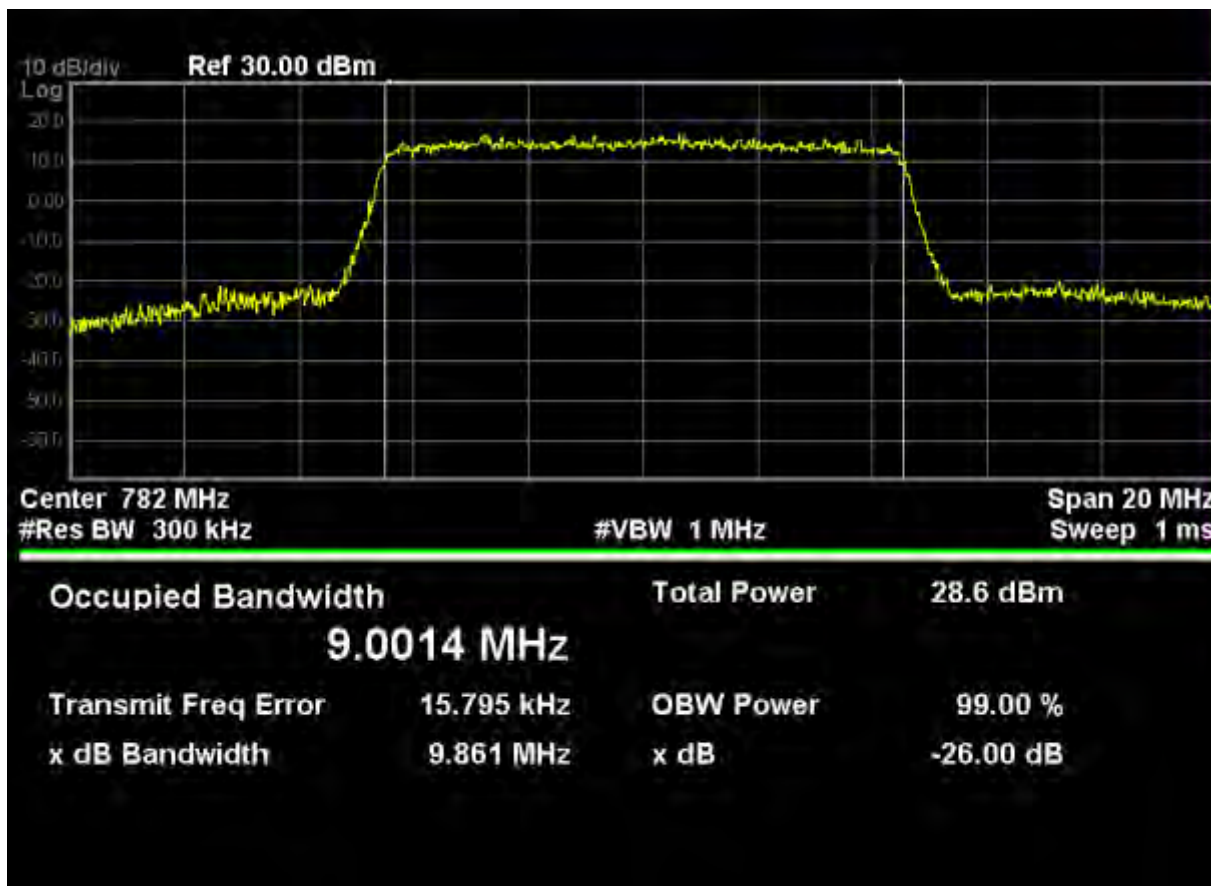

24V DC:
LTE Band 4 (QPSK, Band Width 5MHz, RB Size 25, RB Offset 0)

Channel No.	Frequency (GHz)	-26dB Occupied Bandwidth (MHz)	99% Occupied Bandwidth (MHz)
19975	1.713	4.907	4.5027
20175	1.733	4.880	4.5143
20375	1.753	4.855	4.4906

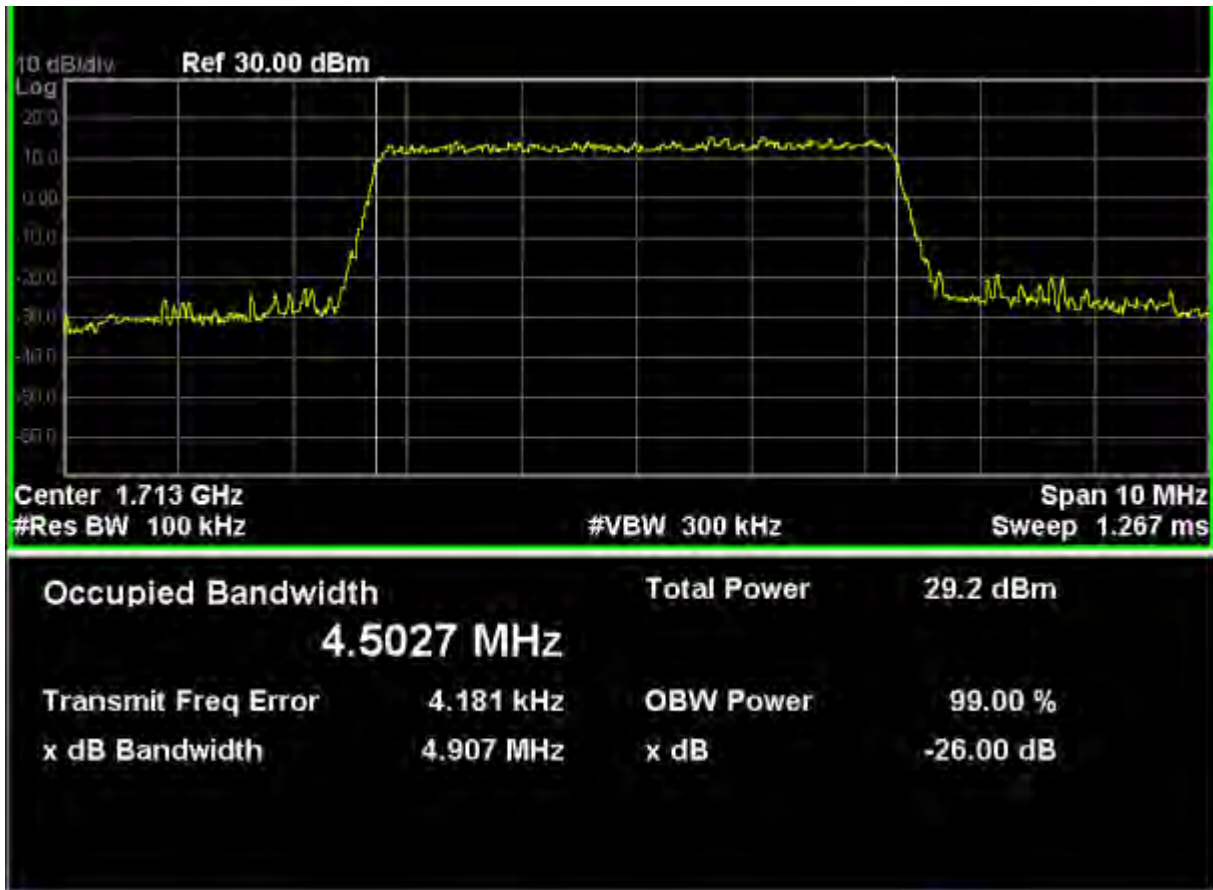

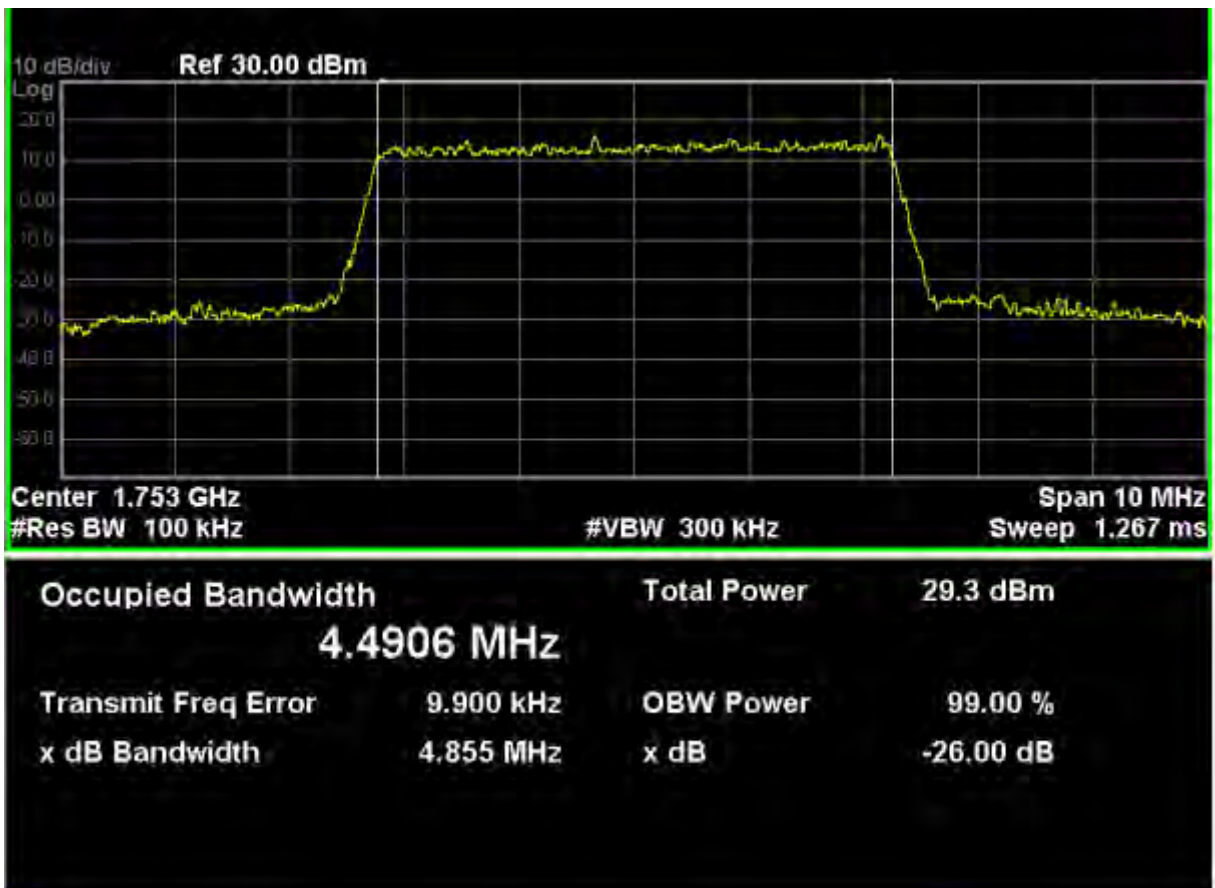

LTE Band 4 (16-QAM, Band Width 5MHz, RB Size 25, RB Offset 0)

Channel No.	Frequency (GHz)	-26dB Occupied Bandwidth (MHz)	99% Occupied Bandwidth (MHz)
19975	1.713	4.927	4.4885
20175	1.733	4.896	4.5059
20375	1.753	4.861	4.4950

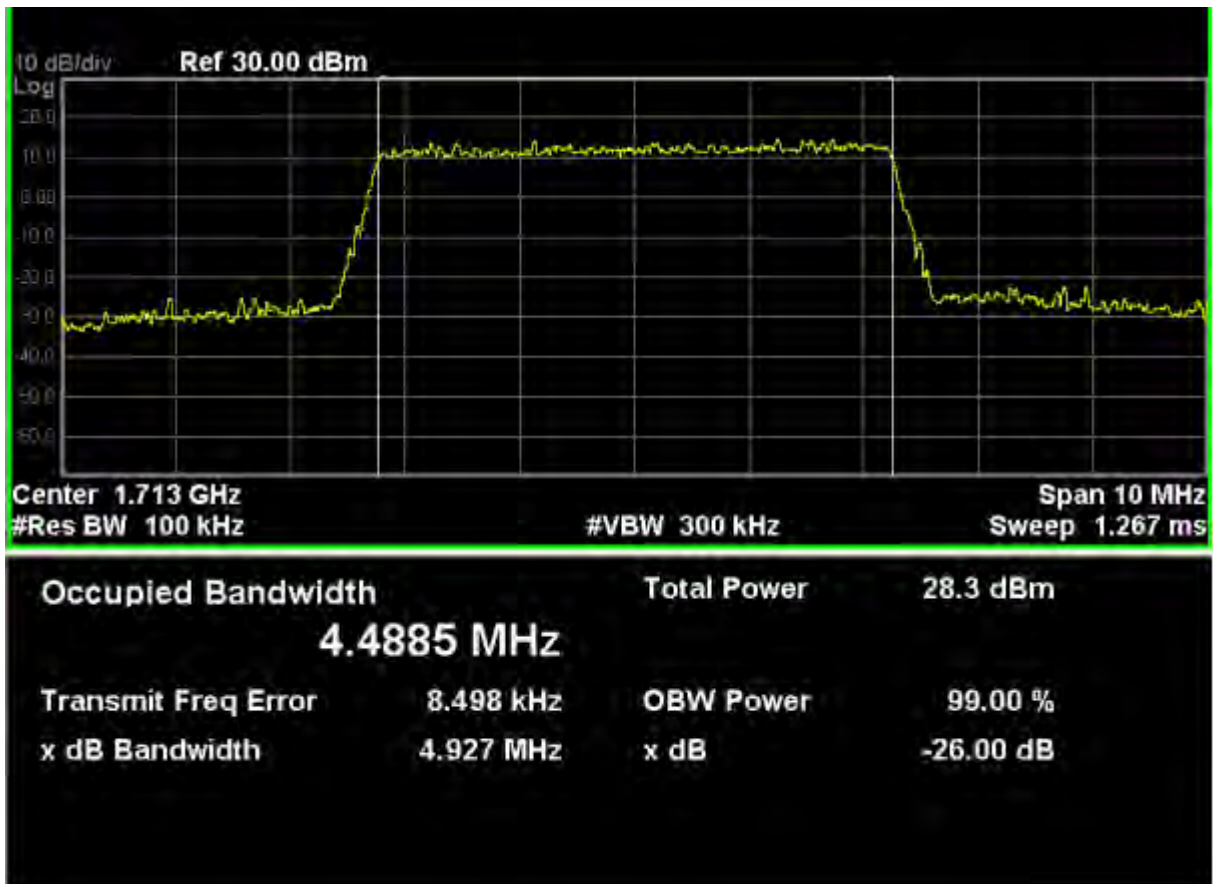

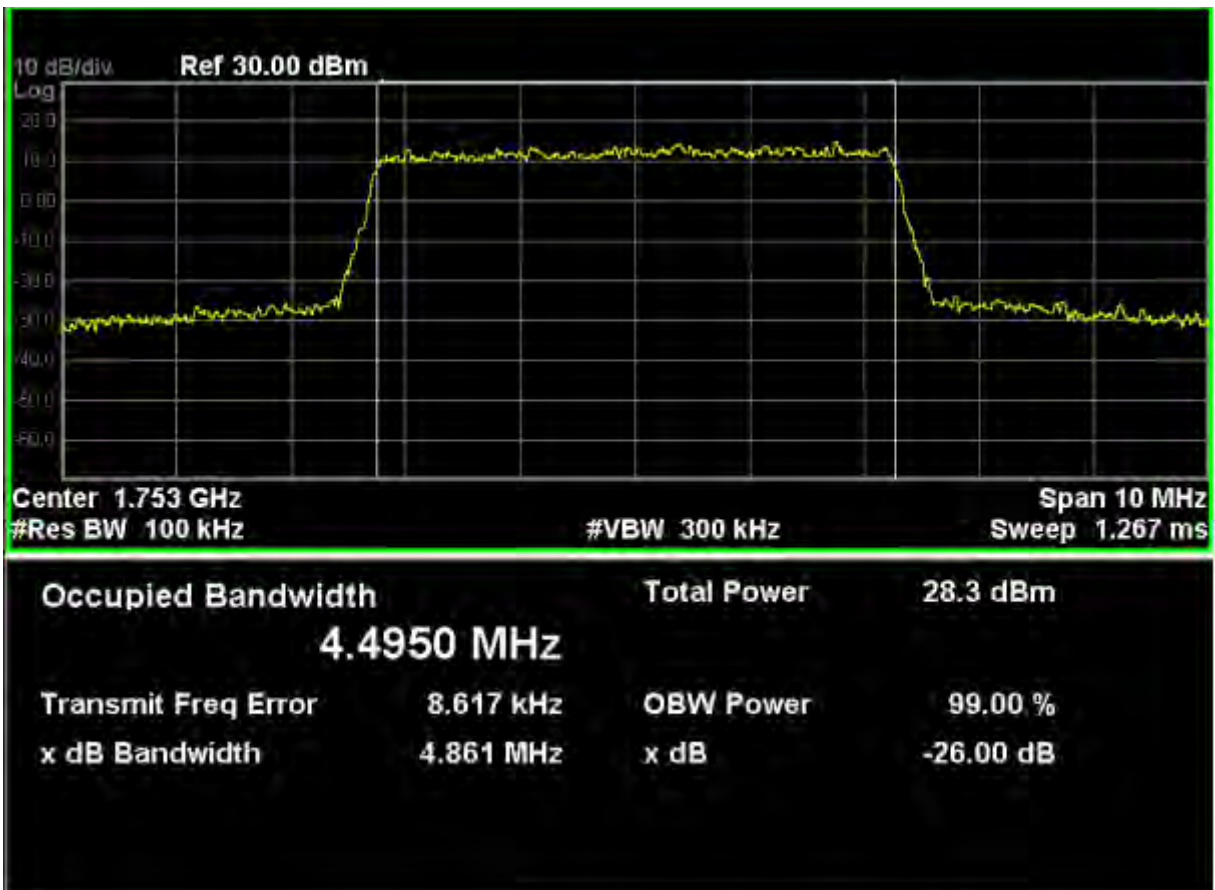
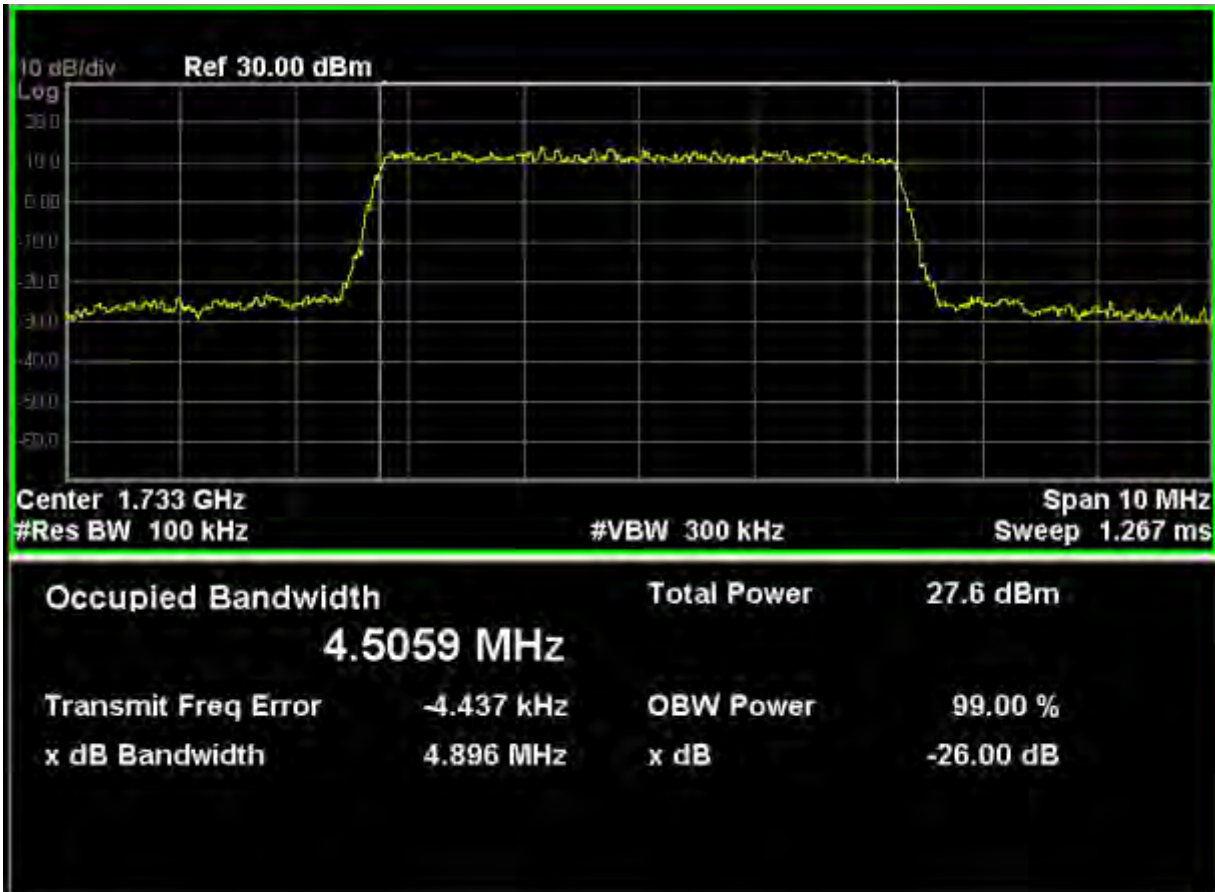

LTE Band 4 (QPSK, Band Width 10MHz, RB Size 50, RB Offset 0)

Channel No.	Frequency (GHz)	-26dB Occupied Bandwidth (MHz)	99% Occupied Bandwidth (MHz)
20000	1.715	9.905	9.0137
20175	1.733	9.958	9.0505
20230	1.750	9.715	9.0277

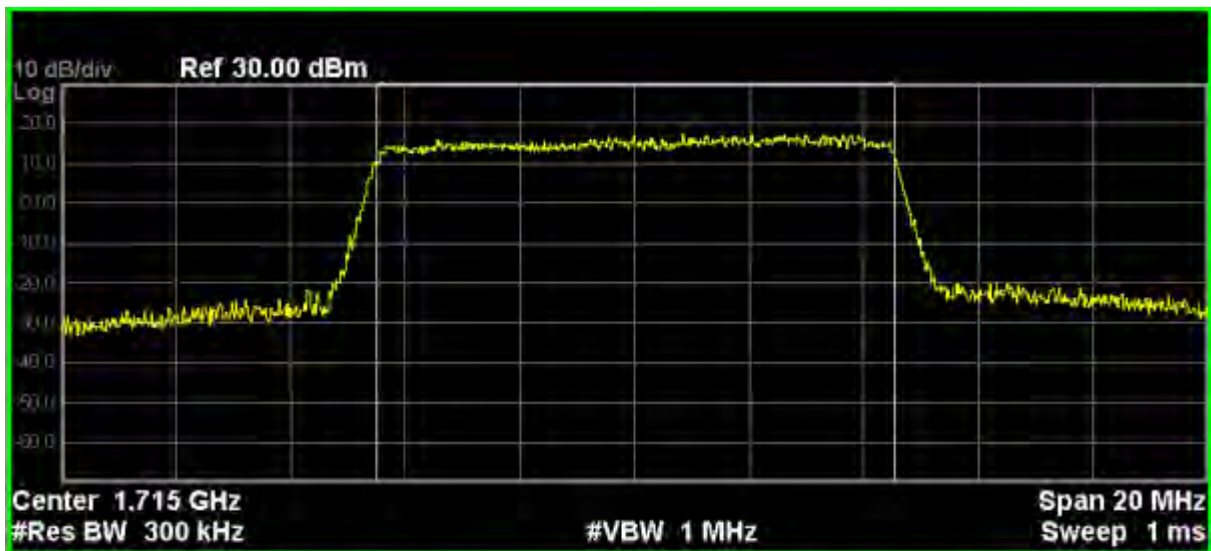

Occupied Bandwidth	Total Power	29.4 dBm
9.0137 MHz		
Transmit Freq Error	OBW Power	99.00 %
26.540 kHz	x dB	-26.00 dB
x dB Bandwidth		
9.905 MHz		

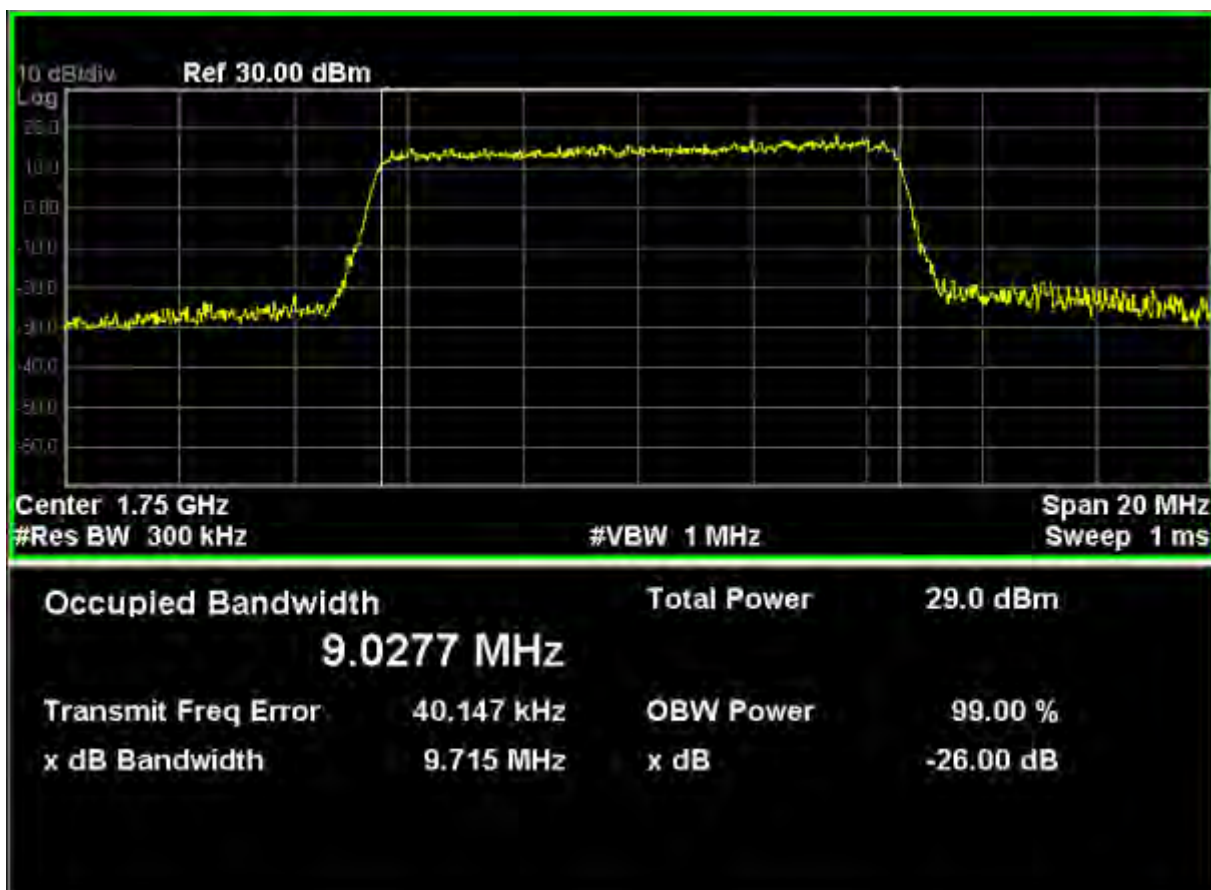
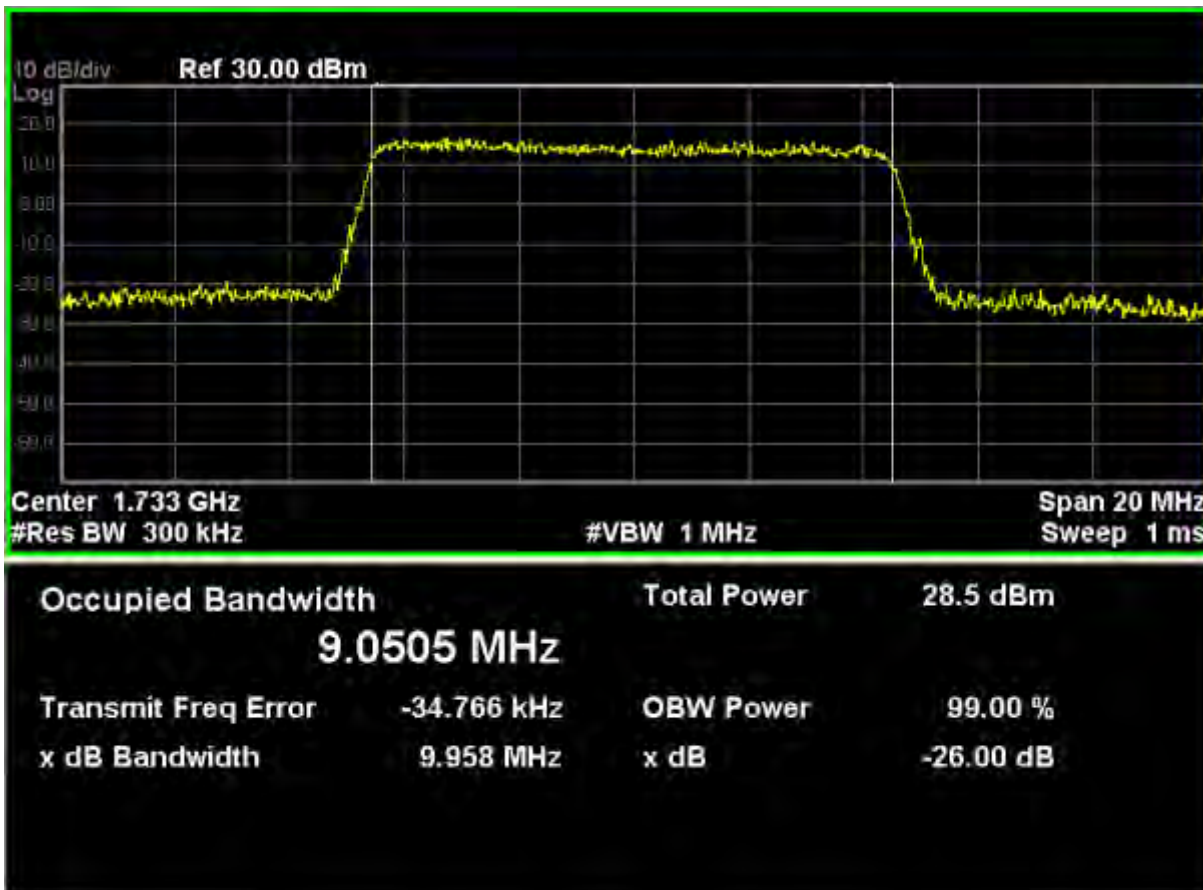

LTE Band 4 (16-QAM, Band Width 10MHz, RB Size 50, RB Offset 0)

Channel No.	Frequency (GHz)	-26dB Occupied Bandwidth (MHz)	99% Occupied Bandwidth (MHz)
20000	1.715	9.840	9.0207
20175	1.733	9.954	9.0488
20230	1.750	9.873	9.0315

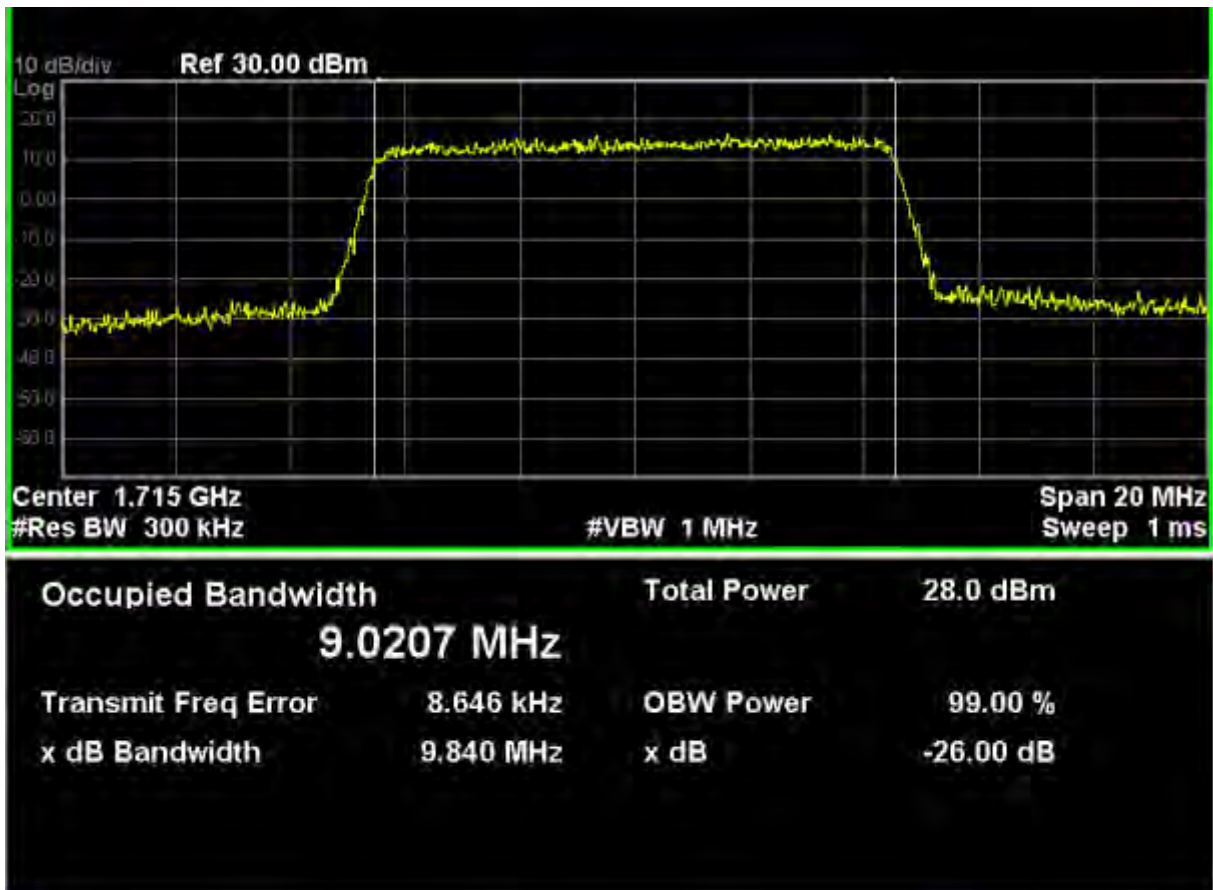

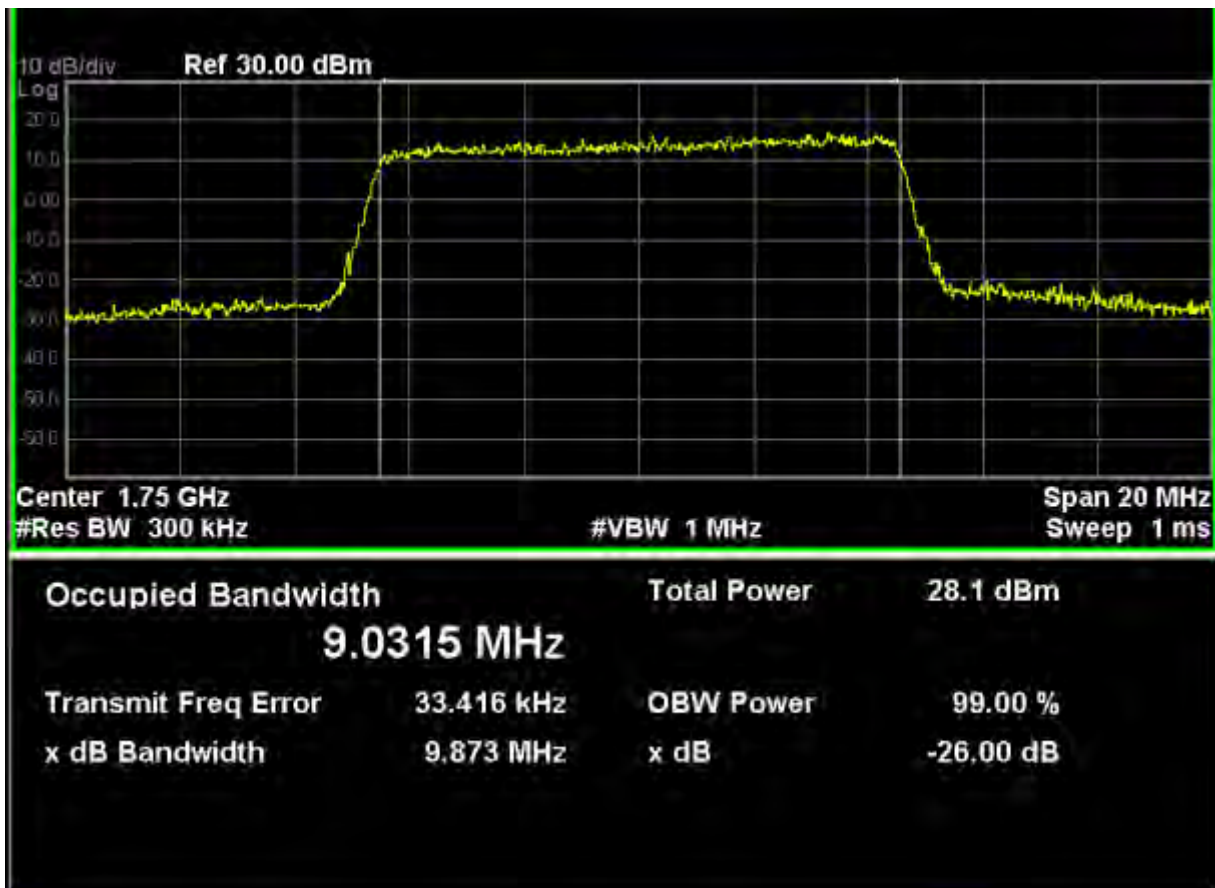
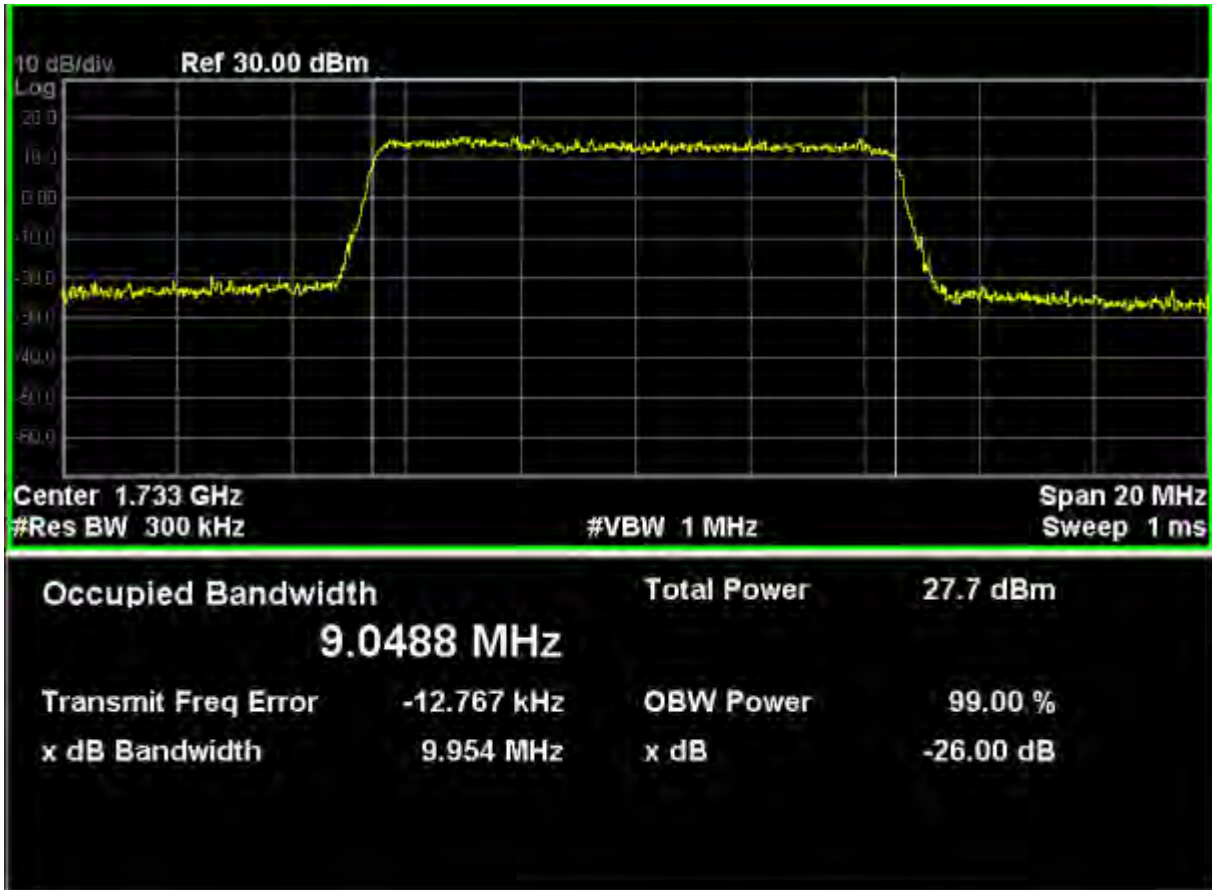

LTE Band 13 (QPSK, Band Width 5MHz, RB Size 25, RB Offset 0)

Channel No.	Frequency (MHz)	-26dB Occupied Bandwidth (MHz)	99% Occupied Bandwidth (MHz)
23205	779.5	4.899	4.4831
23230	782.0	4.877	4.4834
23255	784.5	4.859	4.4965

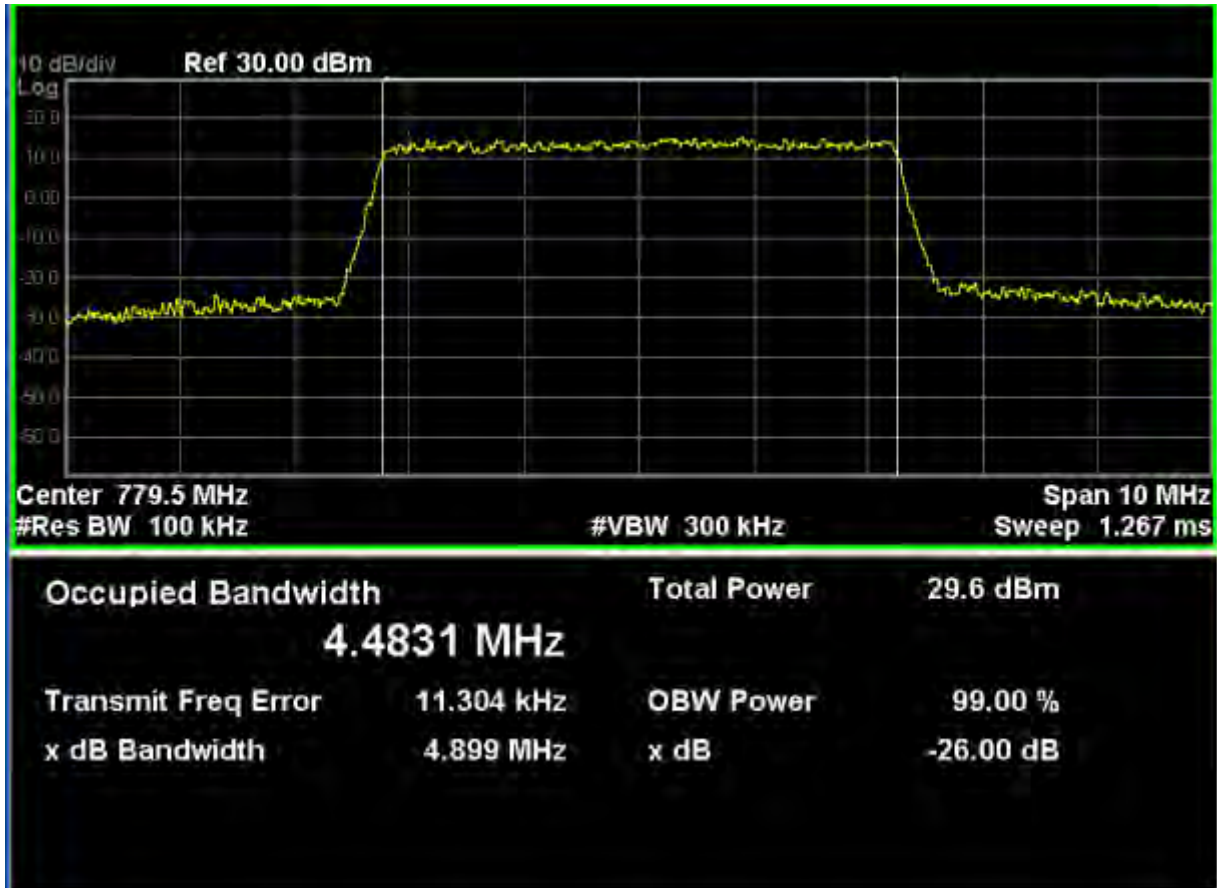

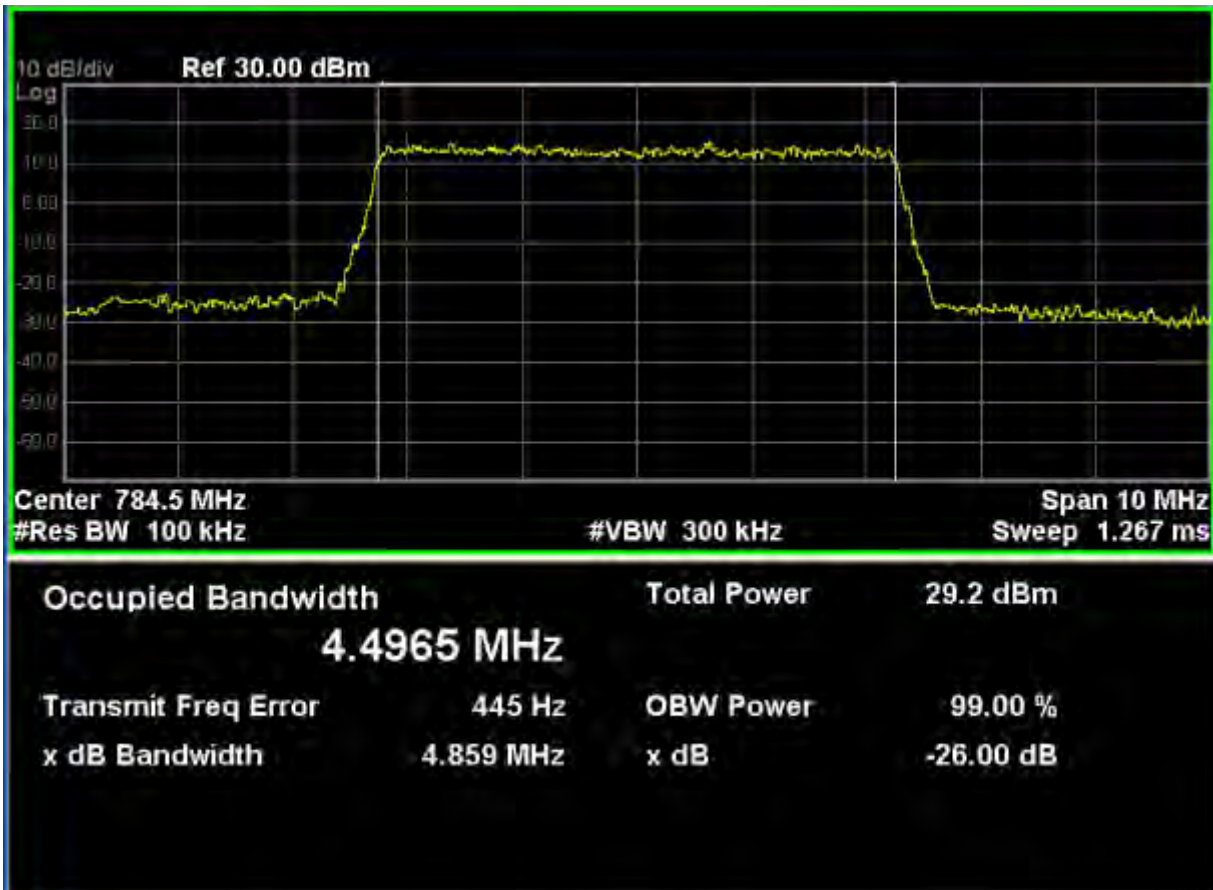
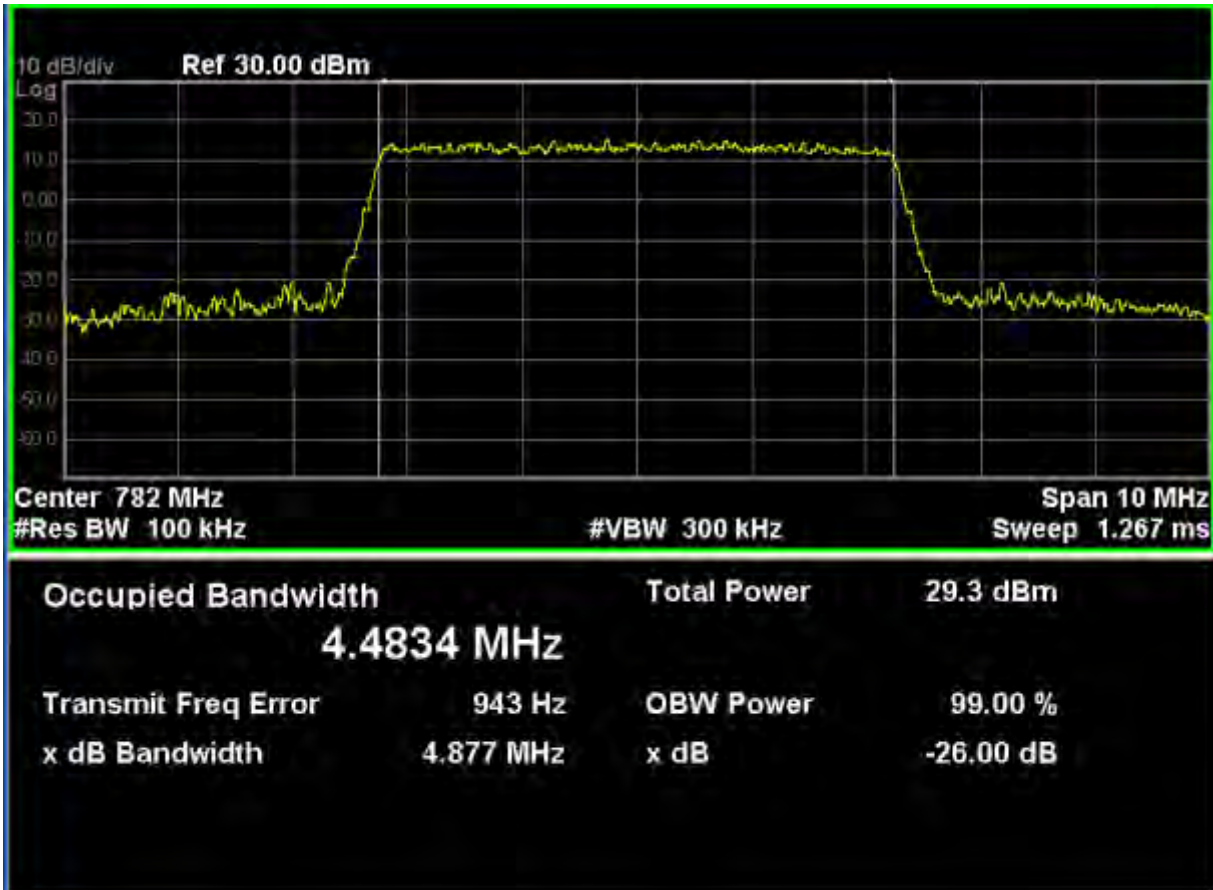

LTE Band 13 (16-QAM, Band Width 5MHz, RB Size 25, RB Offset 0)

Channel No.	Frequency (MHz)	-26dB Occupied Bandwidth (MHz)	99% Occupied Bandwidth (MHz)
23205	779.5	4.858	4.4903
23230	782.0	4.889	4.4980
23255	784.5	4.902	4.4946

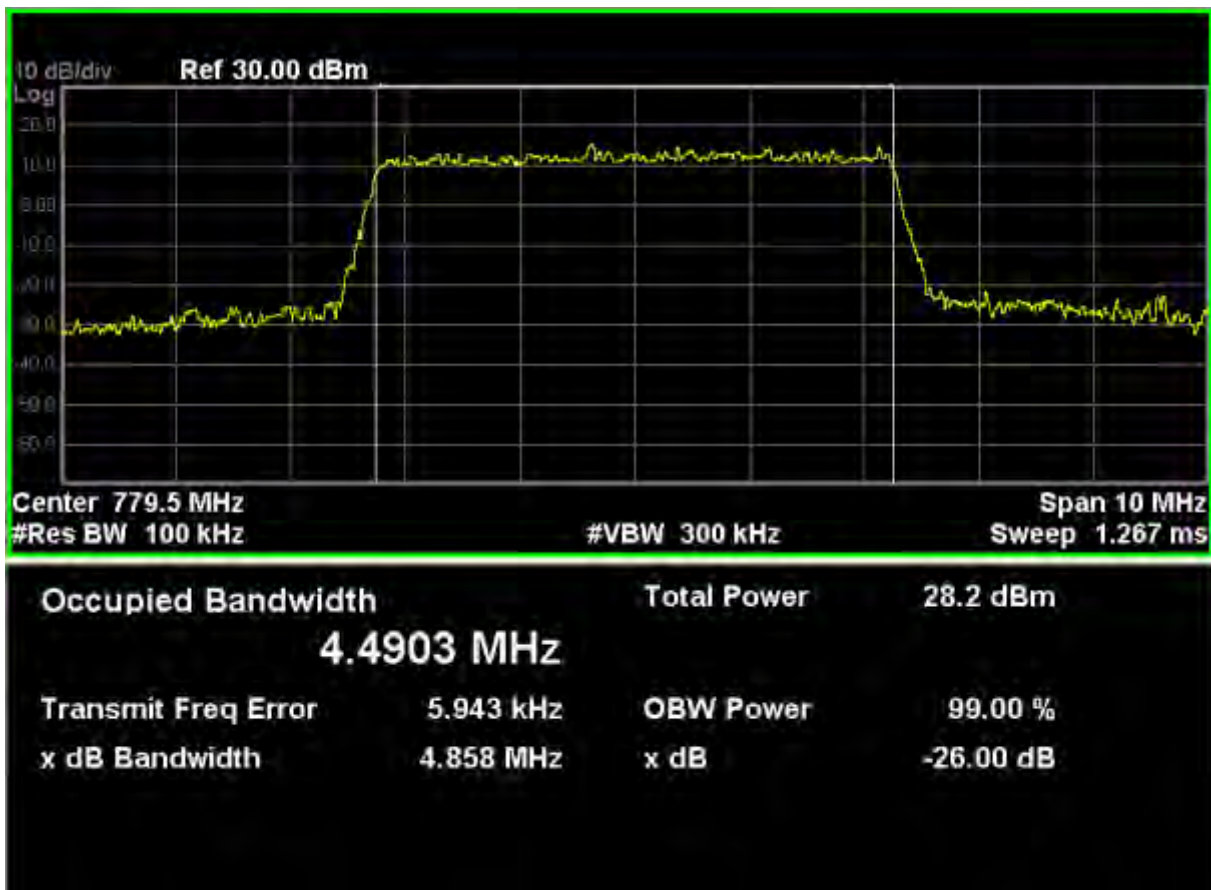

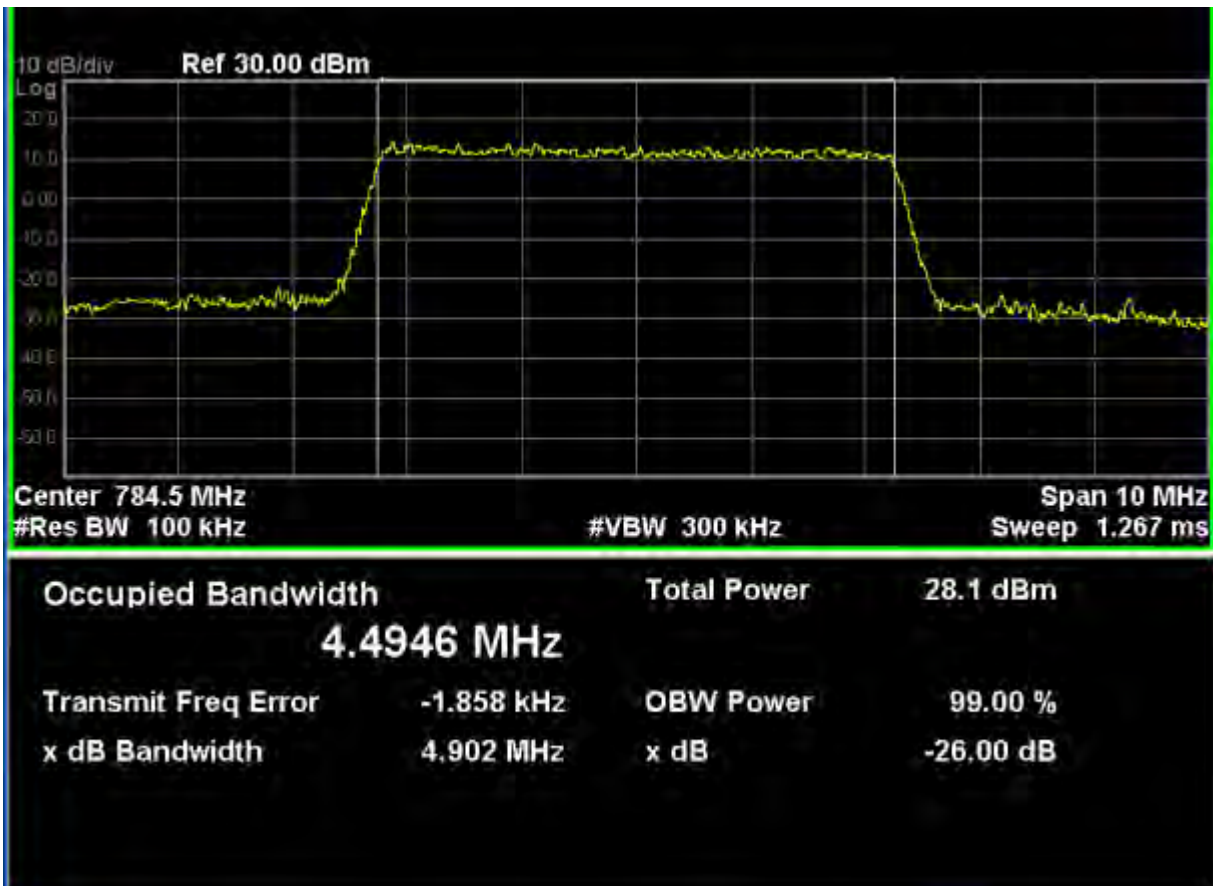
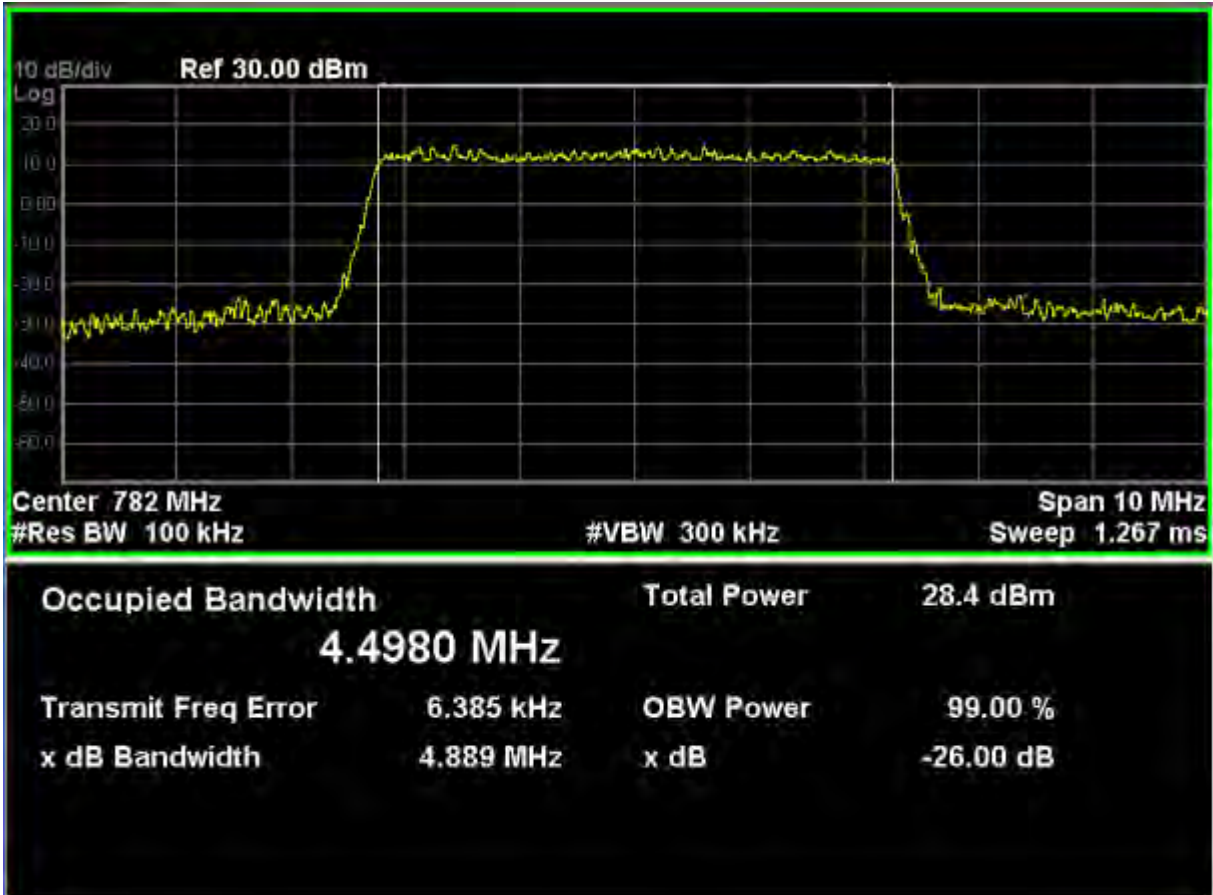

LTE Band 13 (QPSK&16-QAM, Band Width 10MHz, RB Size 50, RB Offset 0)

Channel No.	Frequency (MHz)	-26dB Occupied Bandwidth (MHz)	99% Occupied Bandwidth (MHz)
23230	782.0	9.813	9.0082
23230	782.0	9.772	8.9963





5. Spurious Emission At Antenna Terminals (+/- 1MHz)

5.1. Test Equipment

Instrument	Manufacturer	Model	Serial No	Due. Date
Radio Communication Tester	R&S	CMW500	147483	11/07/2017
SpectrumAnalyzer	Agilent	N9038A	MY51210142	11/04/2017
DC Power Supply	Agilent	6612C	MY43002989	02/28/2018

The measure equipment had been calibrated once a year.

5.2. Test Setup

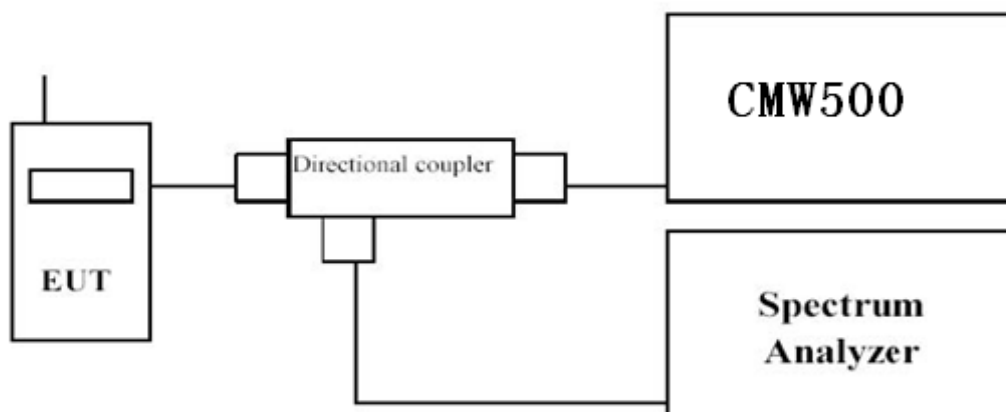

5.3. Limit

The power of any emission outside of the authorized operating frequency ranges must be attenuated below the transmitting power (P) by a factor of at least $43 + 10\log(P)$ dB.

5.4. Test Procedure

In the 1MHz bands immediately outside and adjacent to the frequency block a resolution bandwidth of at least one percent of the emission bandwidth of the fundamental emission of the transmitter may be employed to measure the out of band Emissions.

Procedure:

1. The testing follows FCC KDB 971168 v02v02 Section 6.0;
2. The EUT was connected to spectrum analyzer and the CMW500;
3. The band edges of low and high channels for the highest RF powers were measured. Set $RBW \geq 1\%OBW$ in the 1MHz band immediately outside and adjacent to the band edge.
4. Set spectrum analyzer with RMS detector.

5.5. Uncertainty

The measurement uncertainty is defined as ± 1.2 dB.

5.6. Test Result

12V DC:

LTE Band 4 (QPSK, Band Width 5MHz, RB Size 1, RB Offset 0, Channel 19975, Frequency 1712.5MHz)

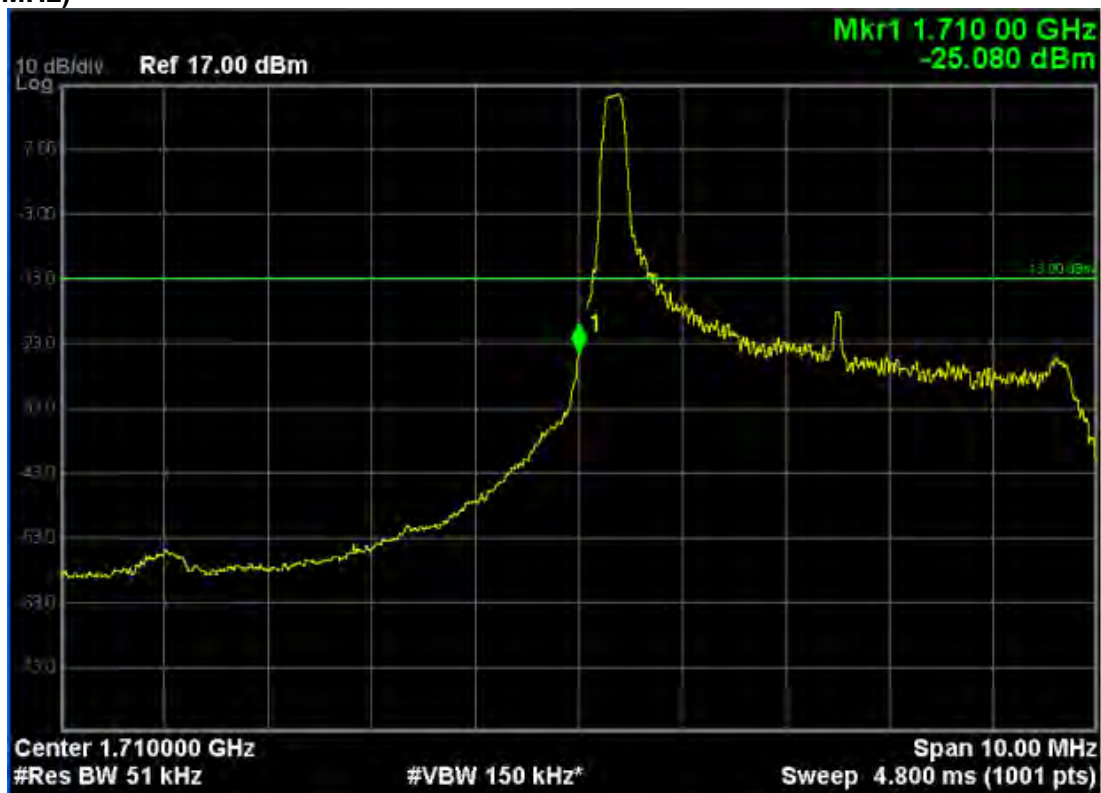

LTE Band 4 (QPSK, Band Width 5MHz, RB Size 25, RB Offset 0, Channel 19975, Frequency 1712.5MHz)

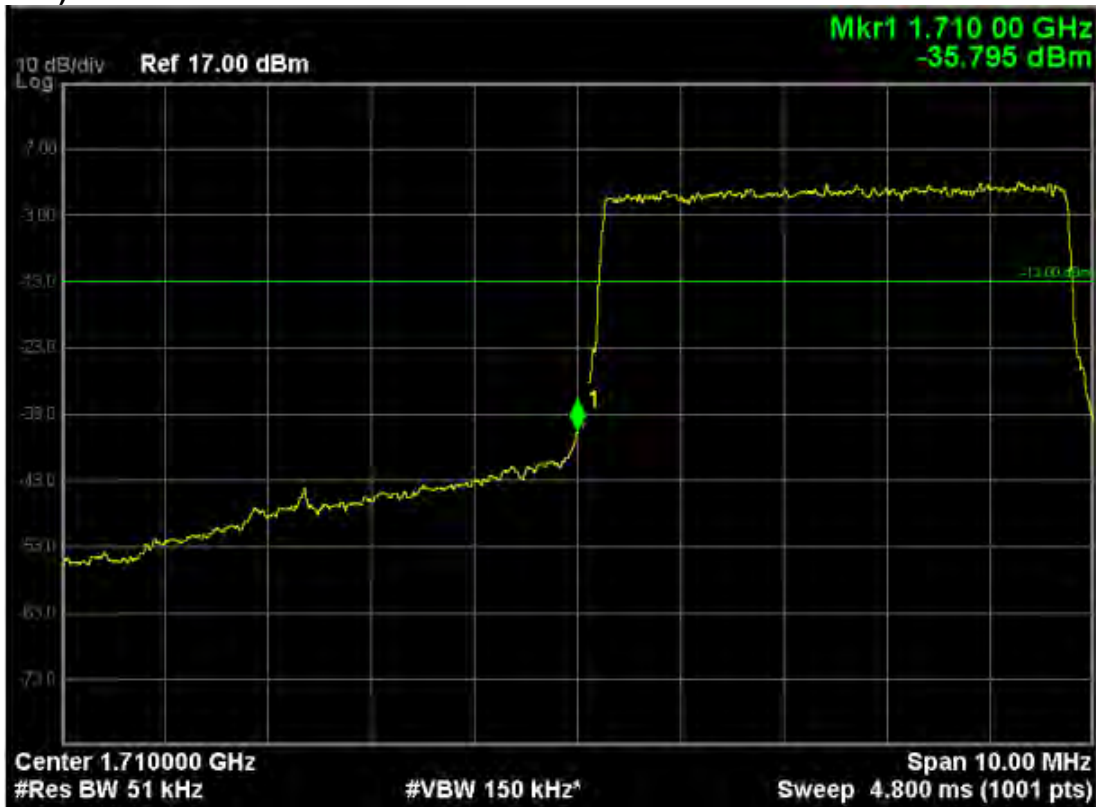

LTE Band 4 (QPSK, Band Width 5MHz, RB Size 1, RB Offset 24, Channel 20375, Frequency 1752.5MHz)

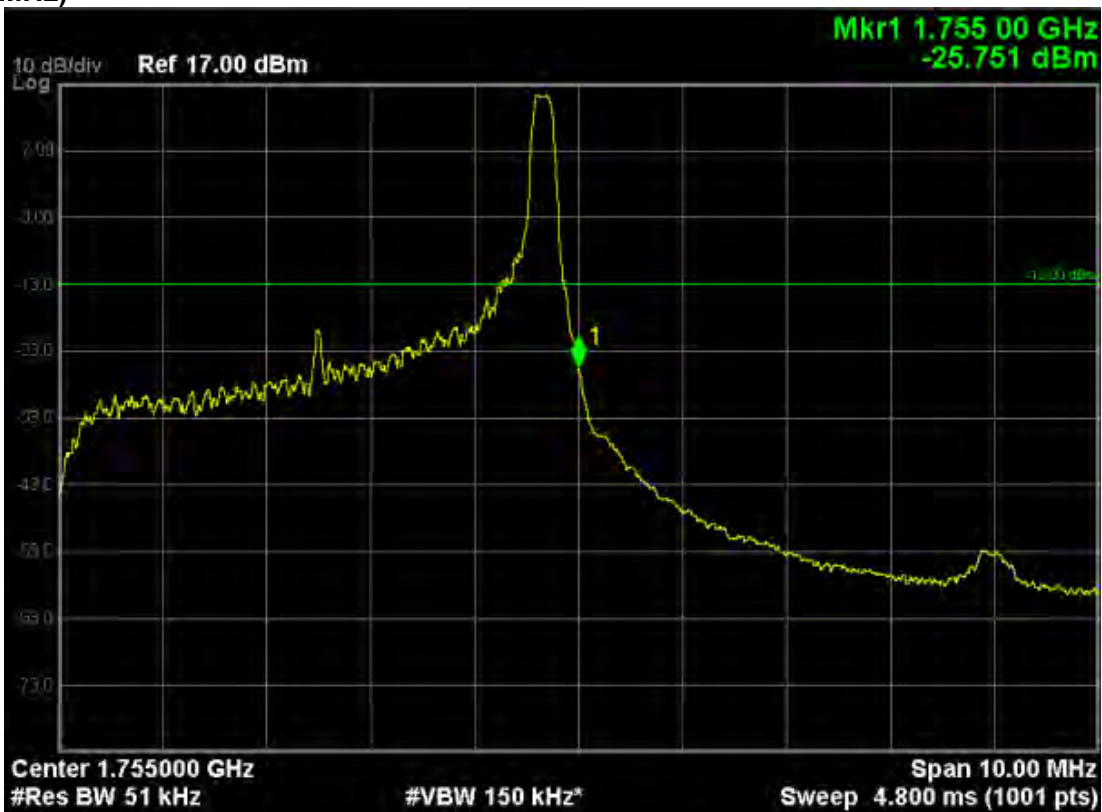

LTE Band 4 (QPSK, Band Width 5MHz, RB Size 25, RB Offset 0, Channel 20375, Frequency 1752.5MHz)



LTE Band 4 (16-QAM, Band Width 5MHz, RB Size 1, RB Offset 0, Channel 19975, Frequency 1712.5MHz)

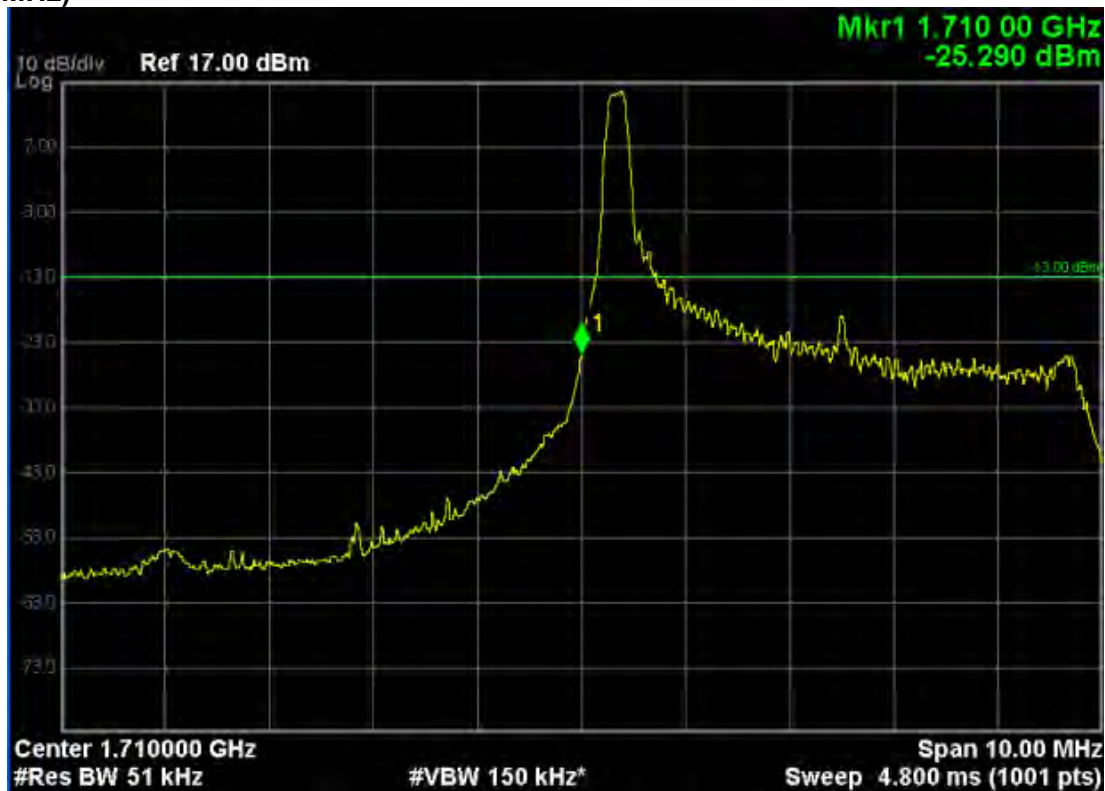

LTE Band 4 (16-QAM, Band Width 5MHz, RB Size 25, RB Offset 0, Channel 19975, Frequency 1712.5MHz)

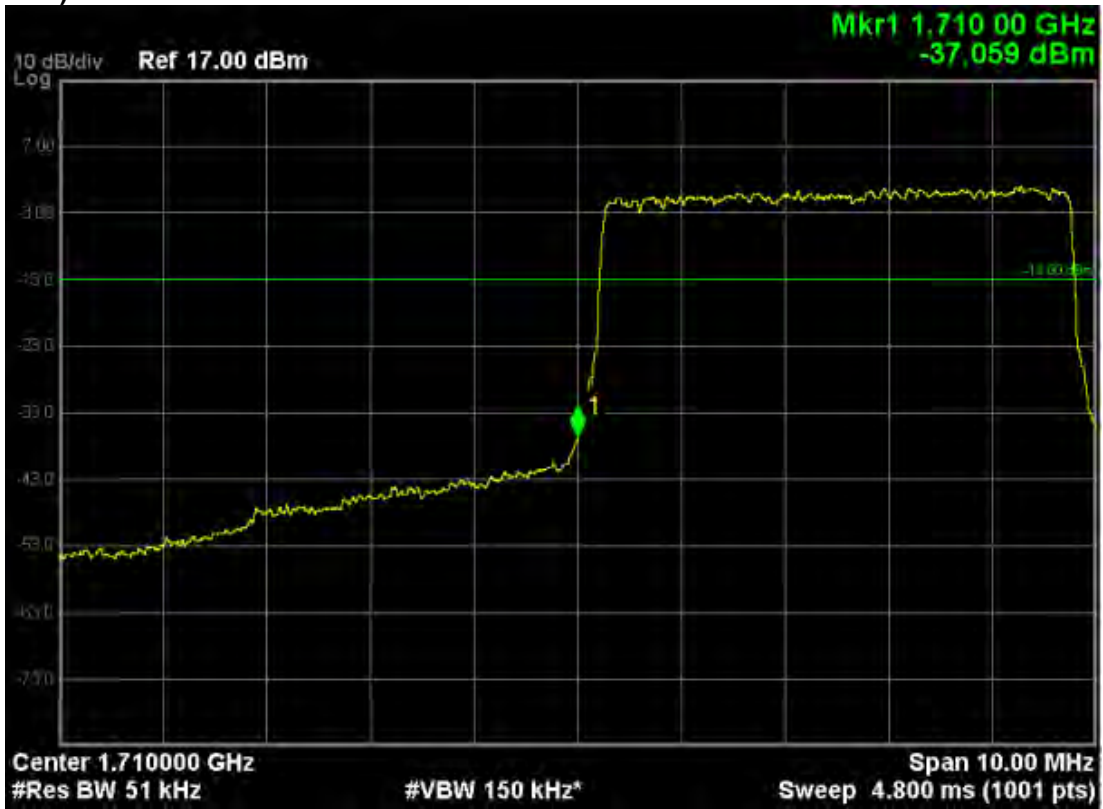

LTE Band 4 (16-QAM, Band Width 5MHz, RB Size 1, RB Offset 24, Channel 20375, Frequency 1752.5MHz)

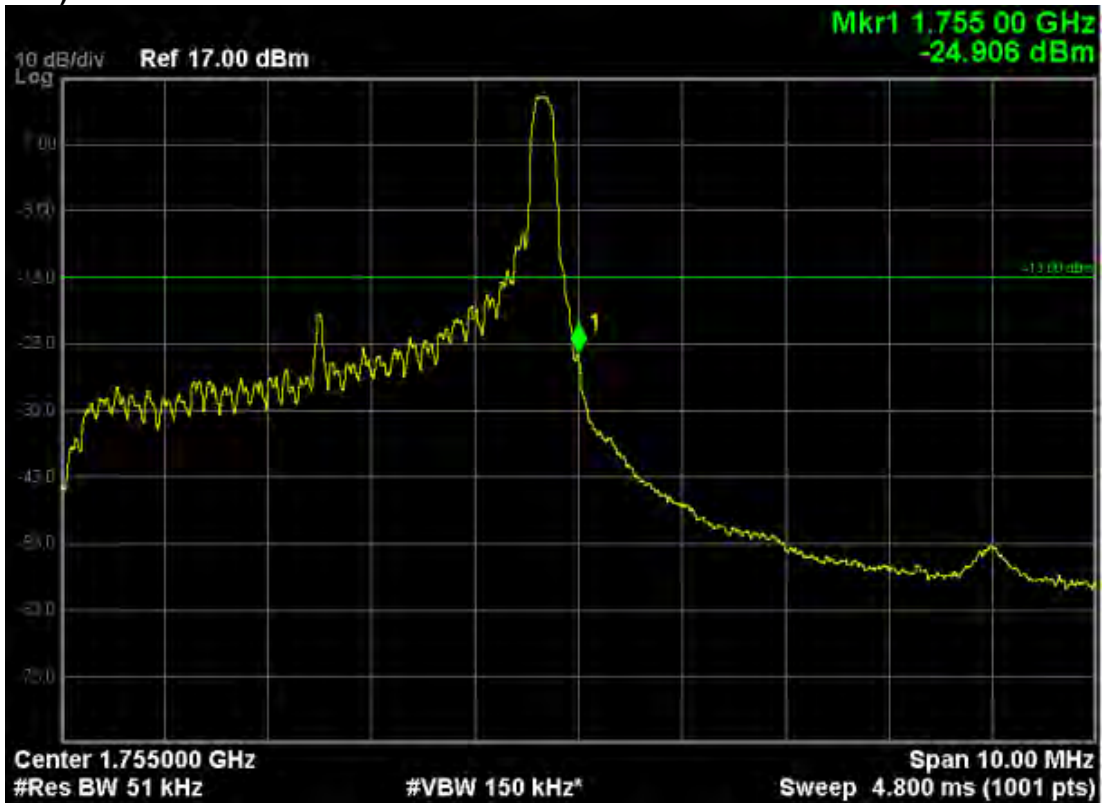

LTE Band 4 (16-QAM, Band Width 5MHz, RB Size 25, RB Offset 0, Channel 20375, Frequency 1752.5MHz)



LTE Band 4 (QPSK, Band Width 10MHz, RB Size 1, RB Offset 0, Channel 20000, Frequency 1715.0MHz)

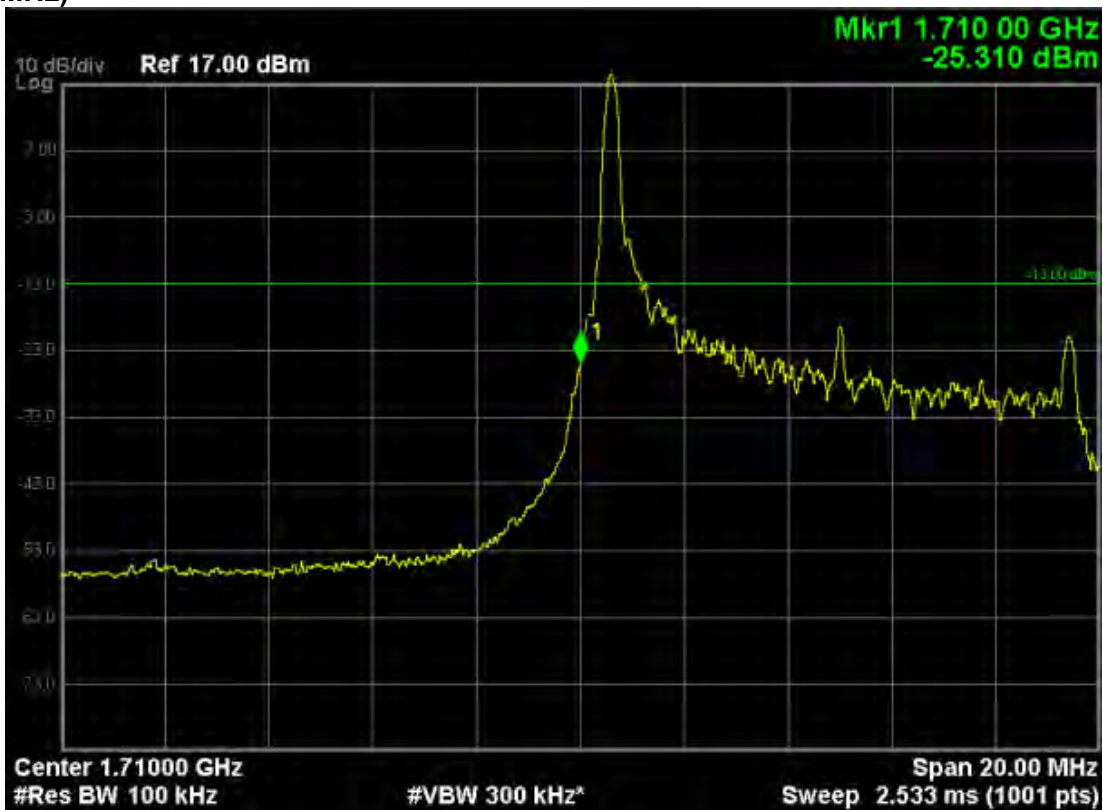

LTE Band 4 (QPSK, Band Width 10MHz, RB Size 50, RB Offset 0, Channel 20000, Frequency 1715.0MHz)

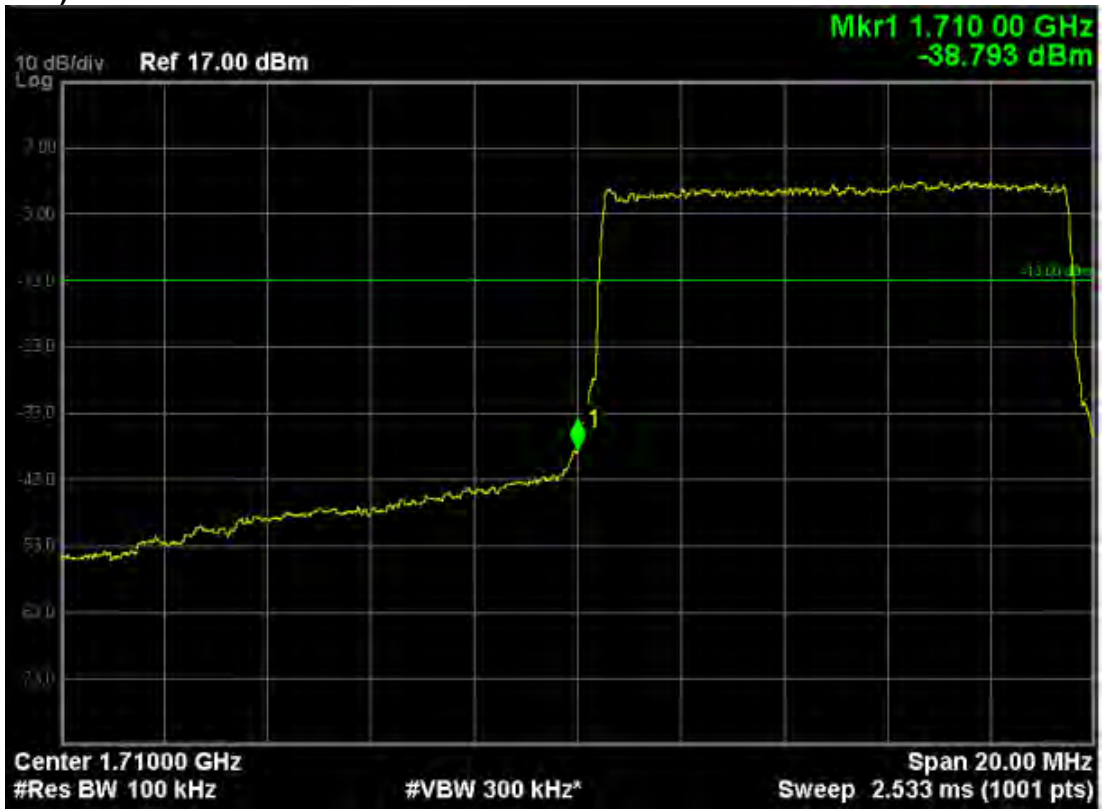

LTE Band 4 (QPSK, Band Width 10MHz, RB Size 1, RB Offset 49, Channel 20350, Frequency 1750.0MHz)

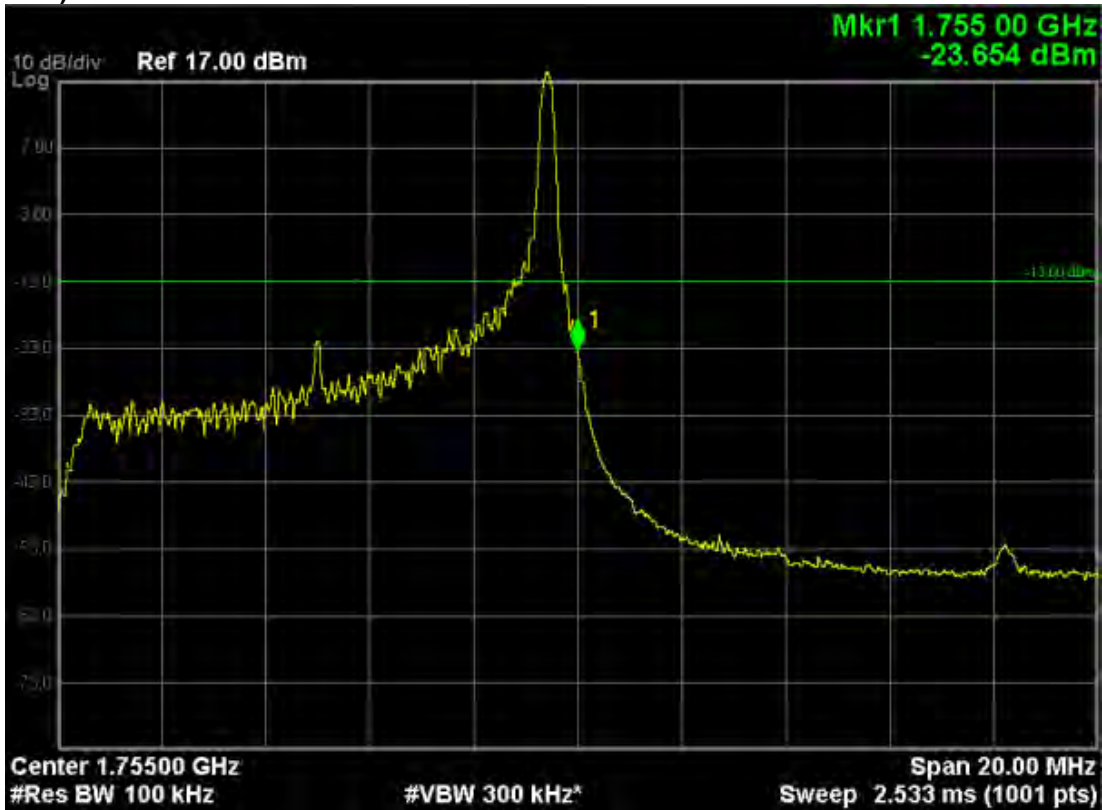

LTE Band 4 (QPSK, Band Width 10MHz, RB Size 50, RB Offset 0, Channel 20350, Frequency 1750.0MHz)

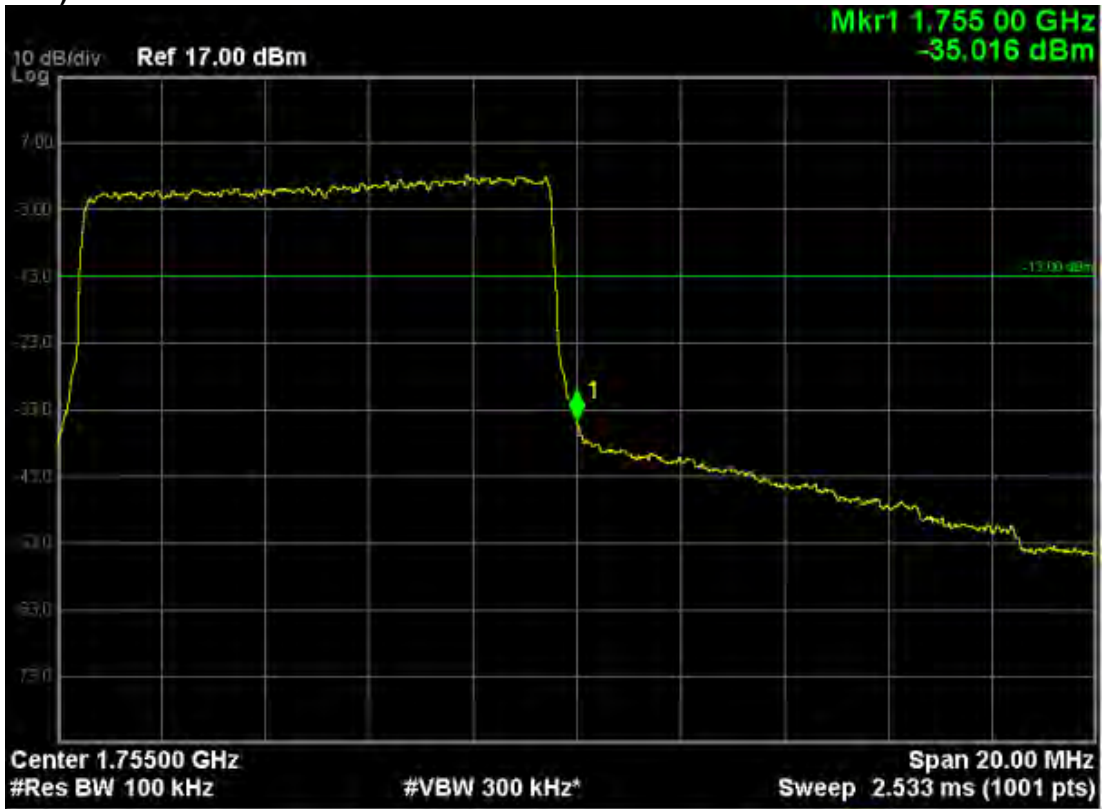

LTE Band 4 (16-QAM, Band Width 10MHz, RB Size 1, RB Offset 0, Channel 20000, Frequency 1715.0MHz)

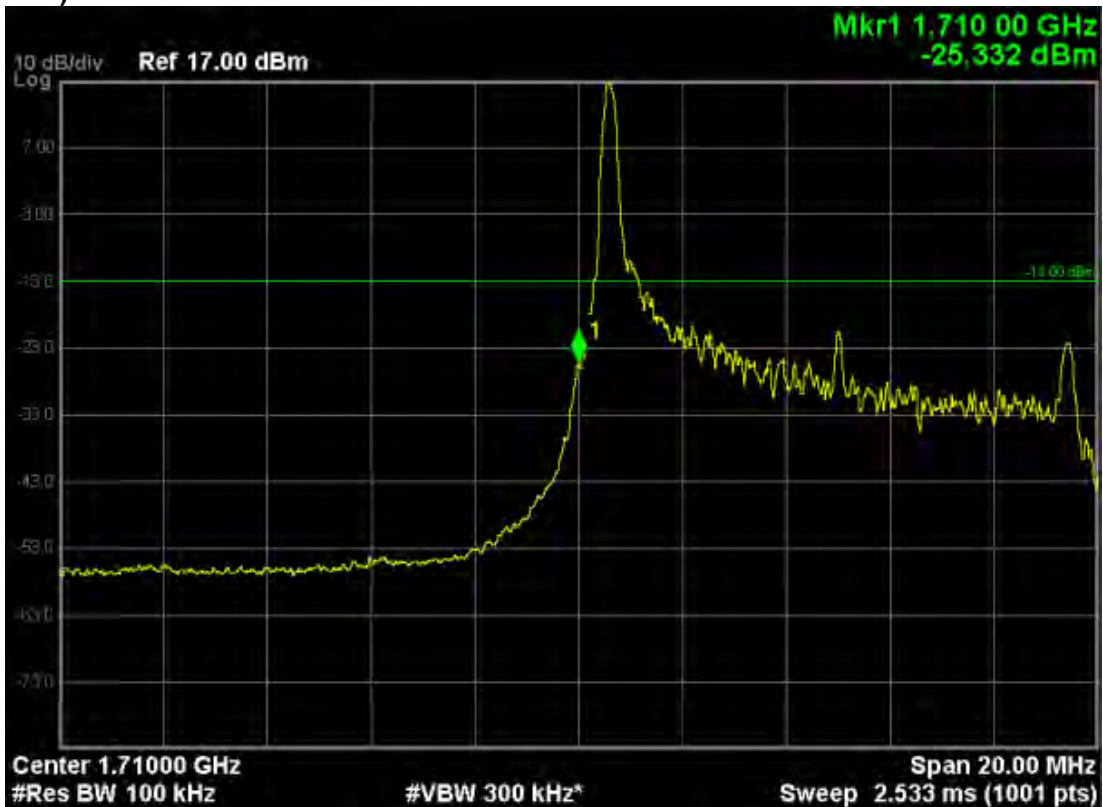

LTE Band 4 (16-QAM, Band Width 10MHz, RB Size 50, RB Offset 0, Channel 20000, Frequency 1715.0MHz)

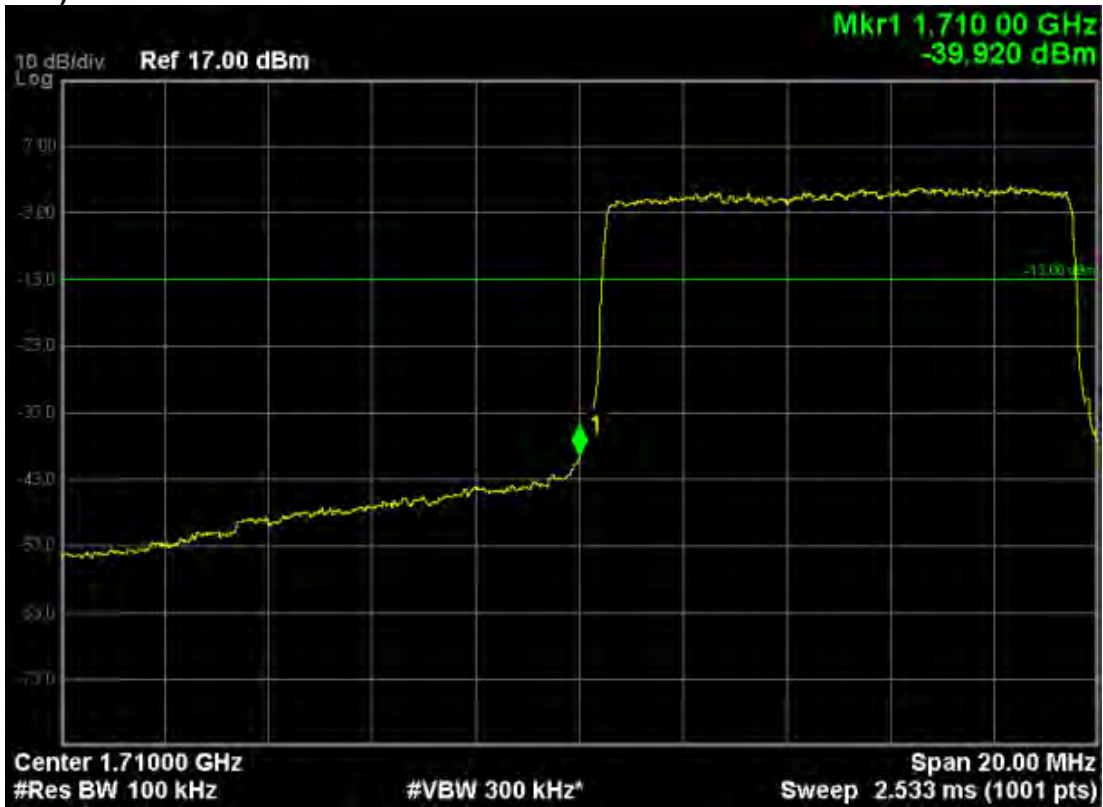

LTE Band 4 (16-QAM, Band Width 10MHz, RB Size 1, RB Offset 49, Channel 20350, Frequency 1755.0MHz)

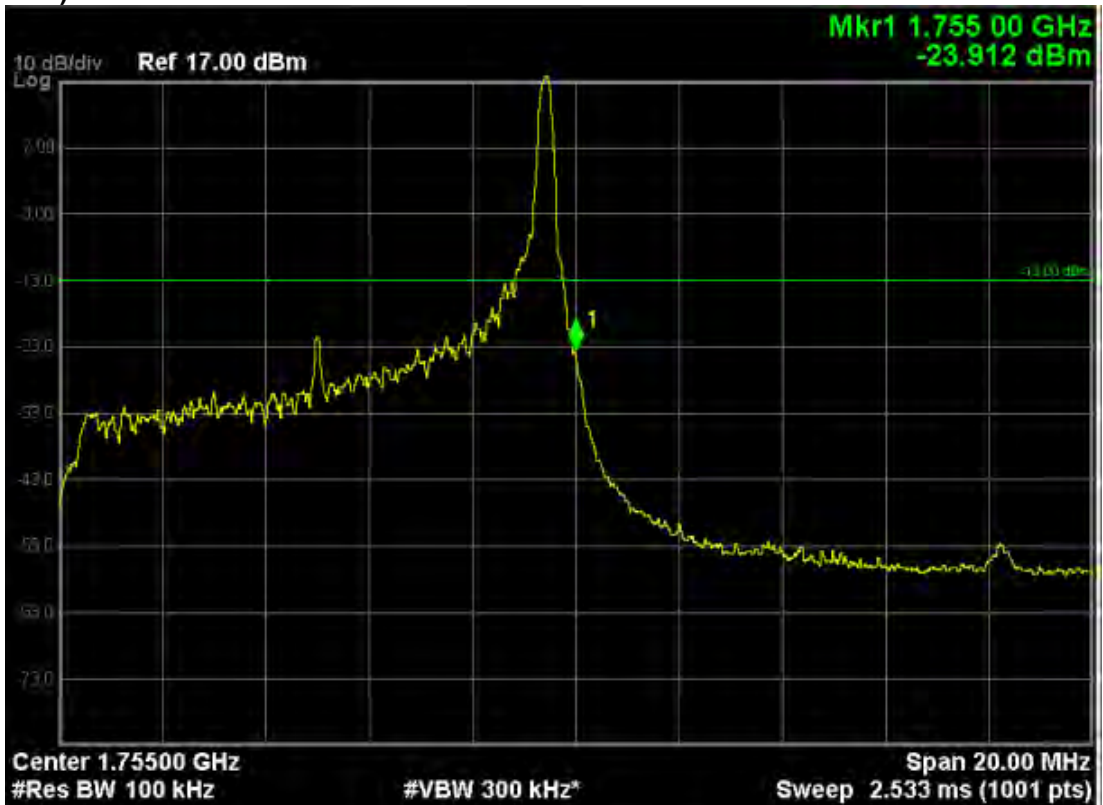

LTE Band 4 (16-QAM, Band Width 10MHz, RB Size 50, RB Offset 0, Channel 20350, Frequency 1755.0MHz)



LTE Band 13 (QPSK, Band Width 5MHz, RB Size 1, RB Offset 0, Channel 23205, Frequency 779.5MHz)

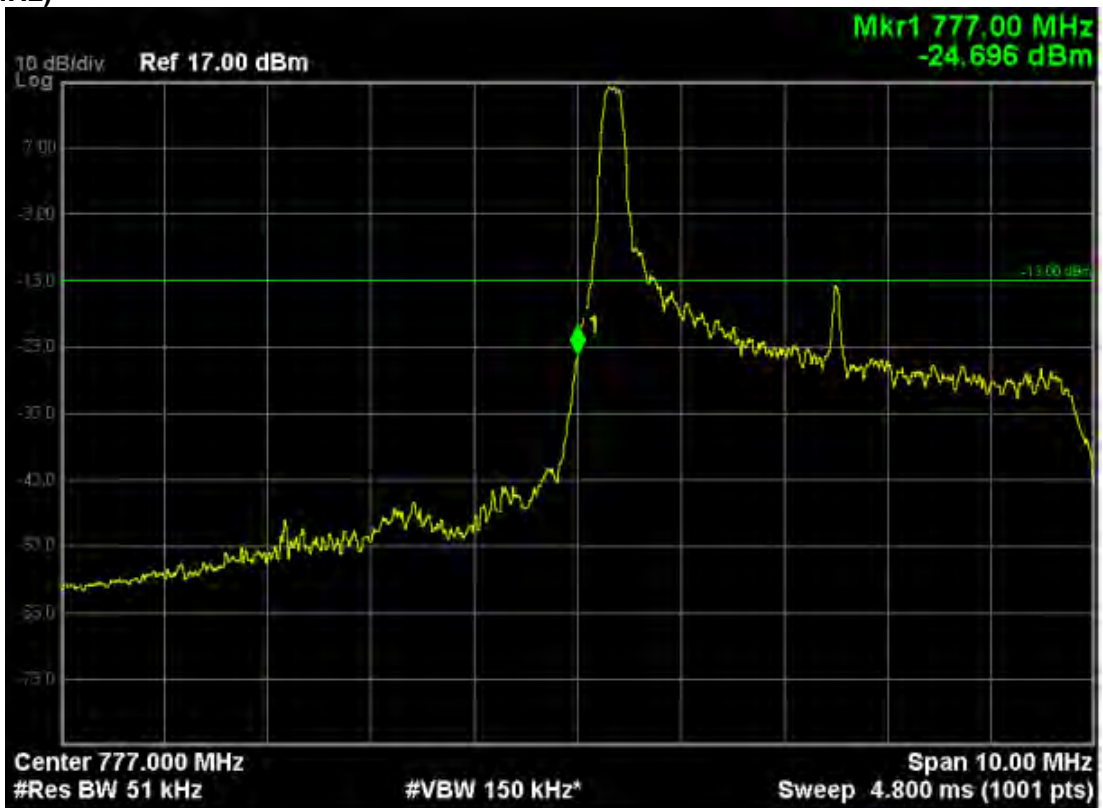

LTE Band 13 (QPSK, Band Width 5MHz, RB Size 25, RB Offset 0, Channel 23205, Frequency 779.5MHz)

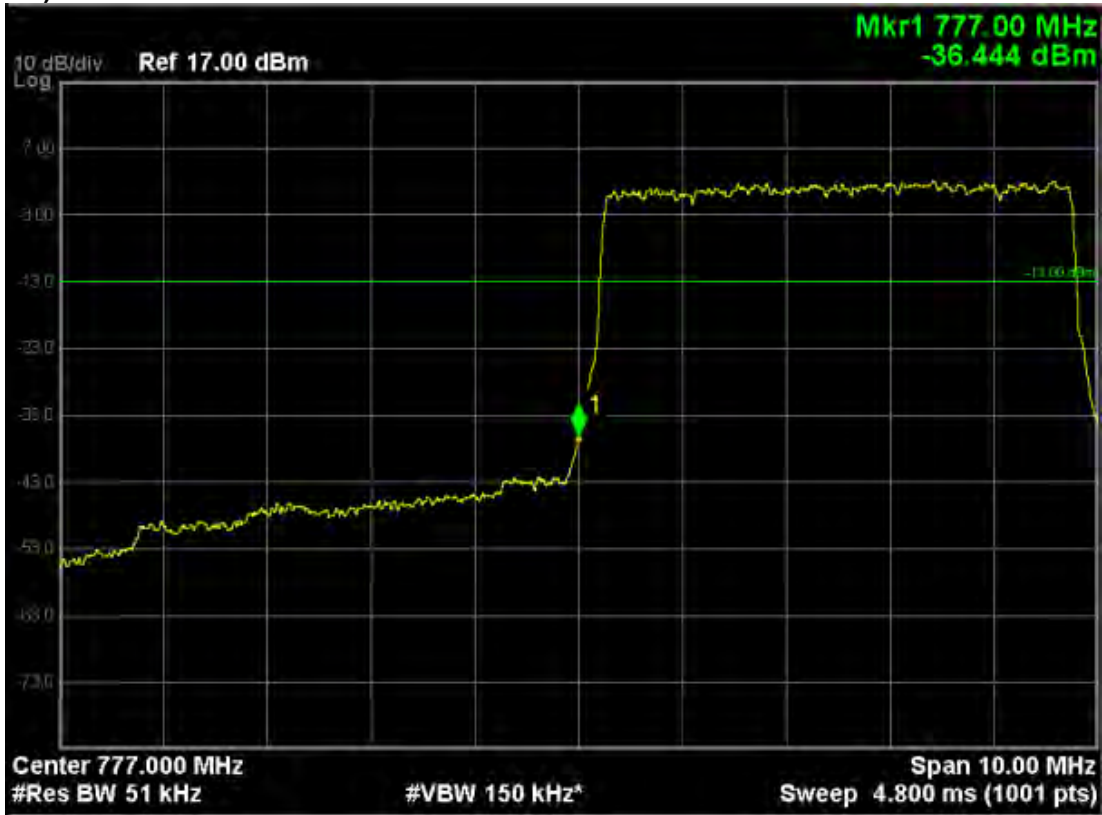

LTE Band 13 (QPSK, Band Width 5MHz, RB Size 1, RB Offset 24, Channel 23255, Frequency 784.5MHz)

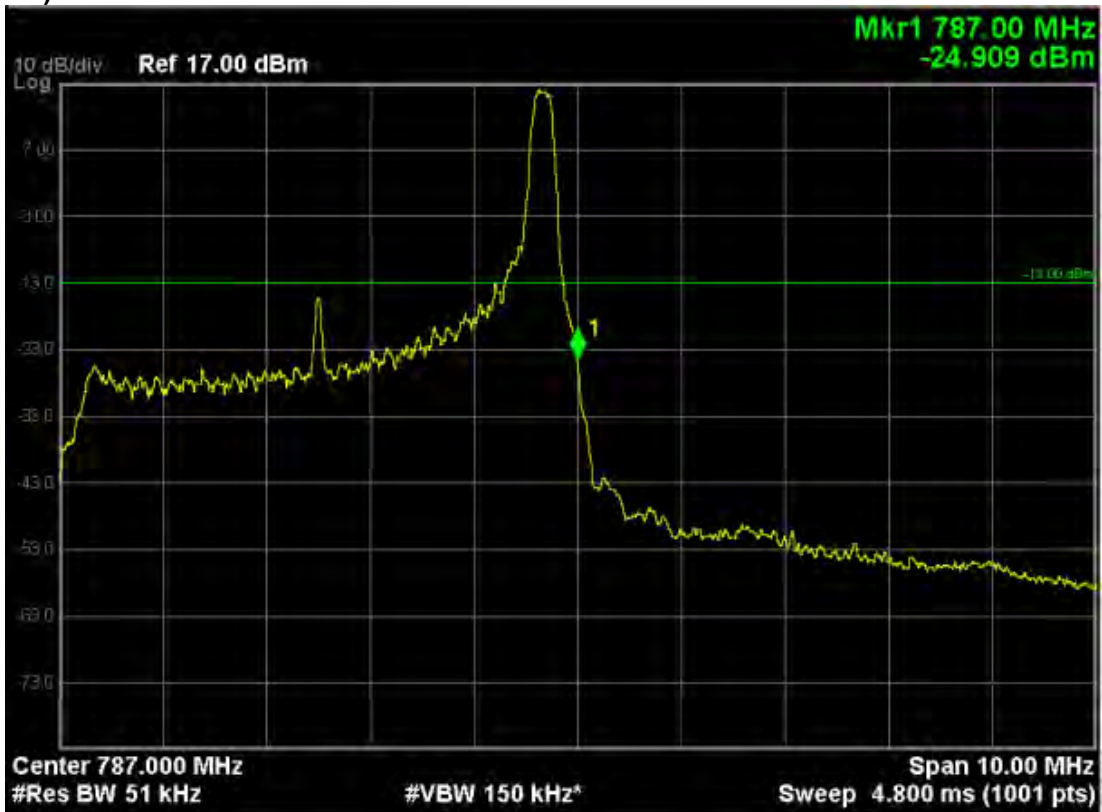

LTE Band 13 (QPSK, Band Width 5MHz, RB Size 25, RB Offset 0, Channel 23255, Frequency 784.5MHz)



LTE Band 13 (16-QAM, Band Width 5MHz, RB Size 1, RB Offset 0, Channel 23205, Frequency 779.5MHz)

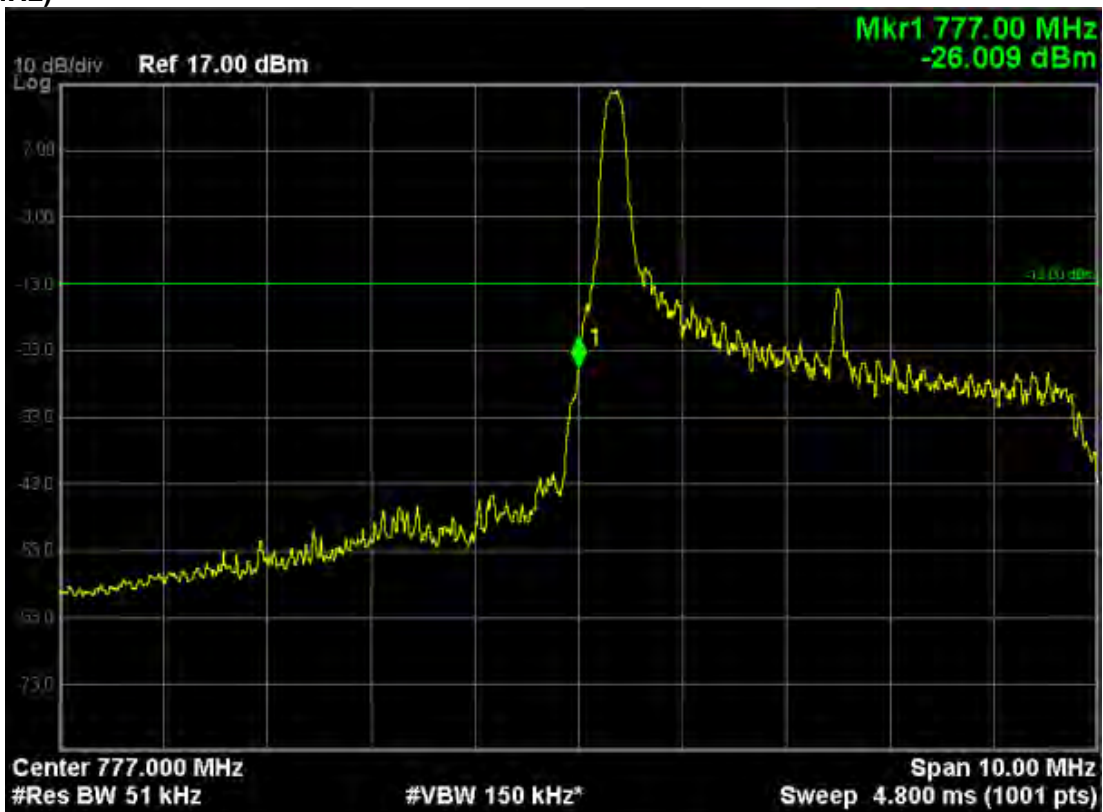

LTE Band 13 (16-QAM, Band Width 5MHz, RB Size 25, RB Offset 0, Channel 23205, Frequency 779.5MHz)

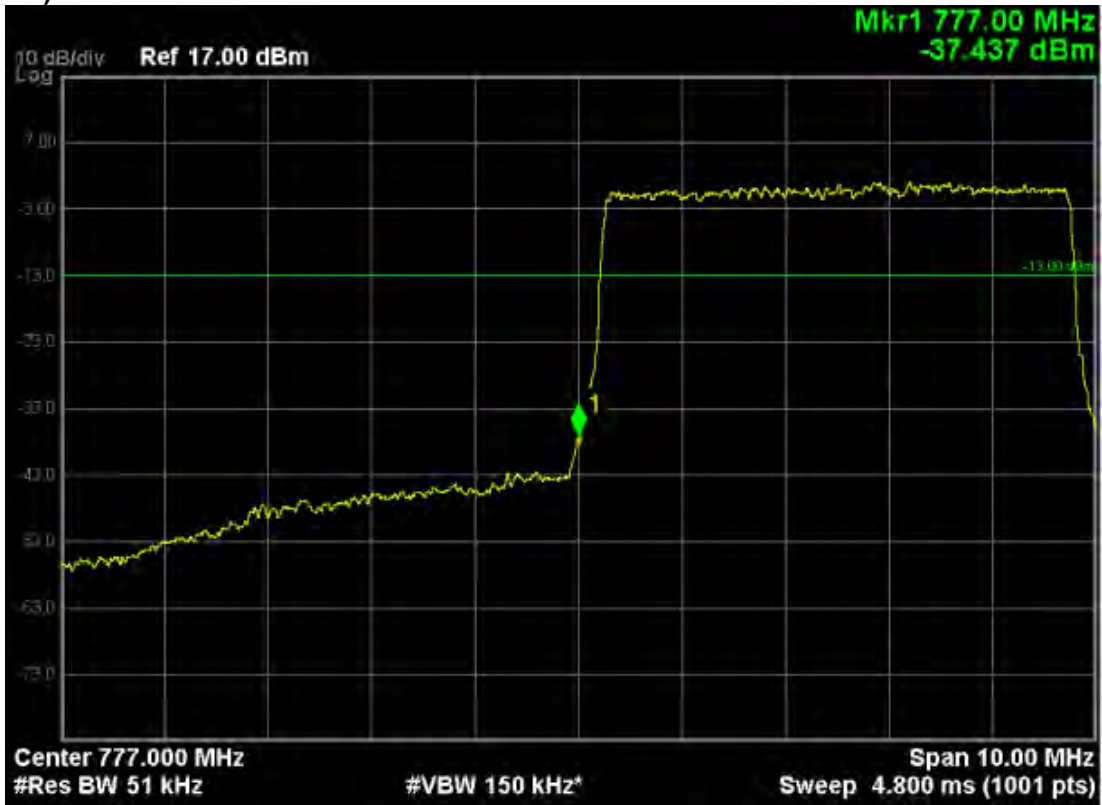

LTE Band 13 (16-QAM, Band Width 5MHz, RB Size 1, RB Offset 24, Channel 23255, Frequency 784.5MHz)

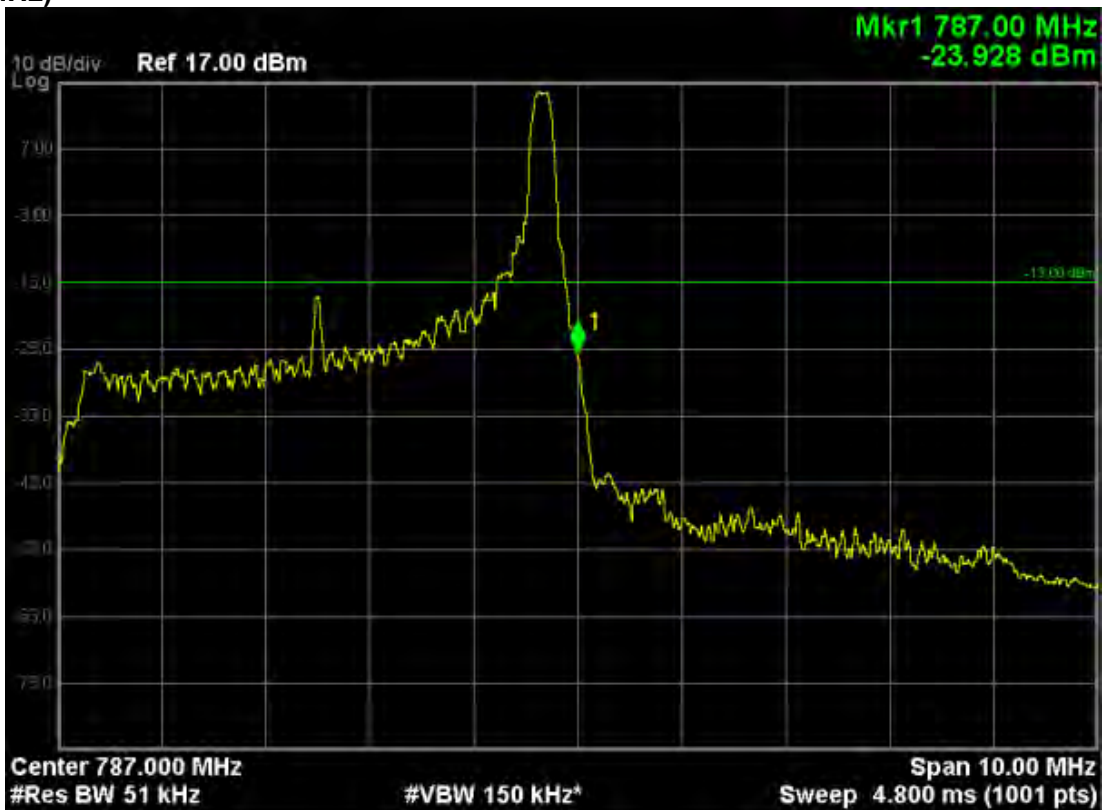

LTE Band 13 (16-QAM, Band Width 5MHz, RB Size 25, RB Offset 0, Channel 23255, Frequency 784.5MHz)

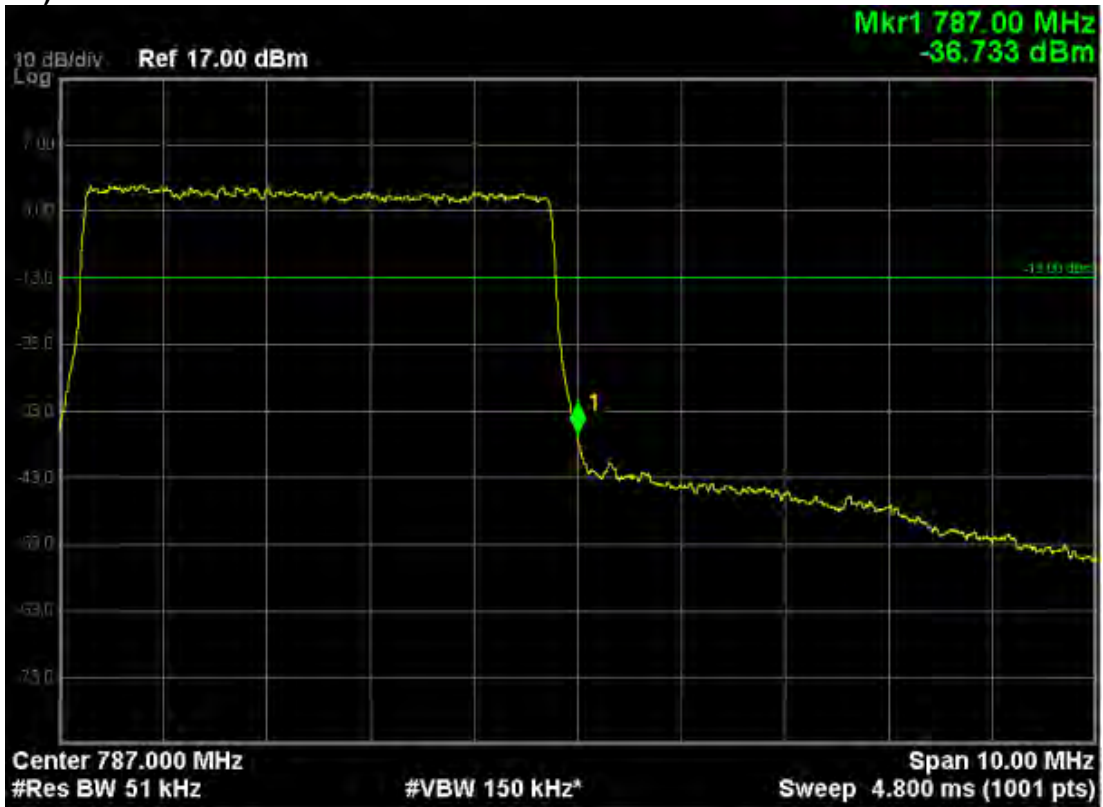

LTE Band 13 (QPSK, Band Width 10MHz, RB Size 1, RB Offset 0, Channel 23230, Frequency 782.0MHz)



LTE Band 13 (QPSK, Band Width 10MHz, RB Size 50, RB Offset 0, Channel 23230, Frequency 782.0MHz)

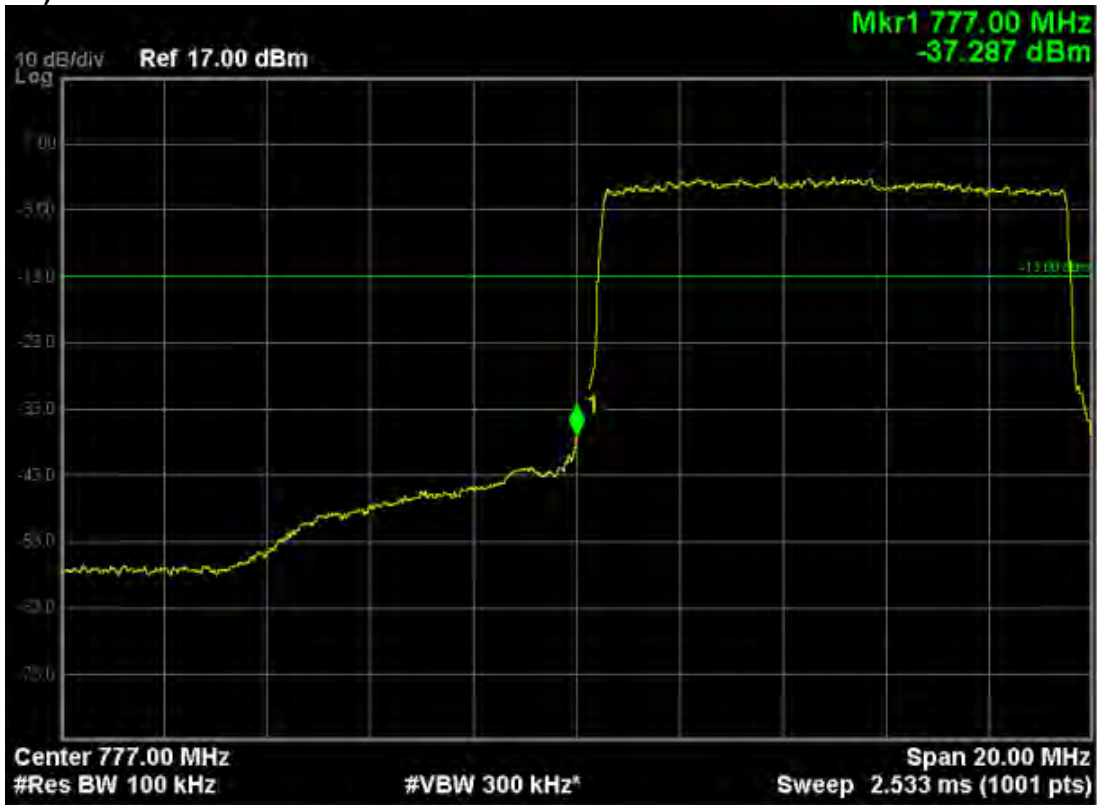

LTE Band 13 (QPSK, Band Width 10MHz, RB Size 1, RB Offset 49, Channel 23230, Frequency 782.0MHz)

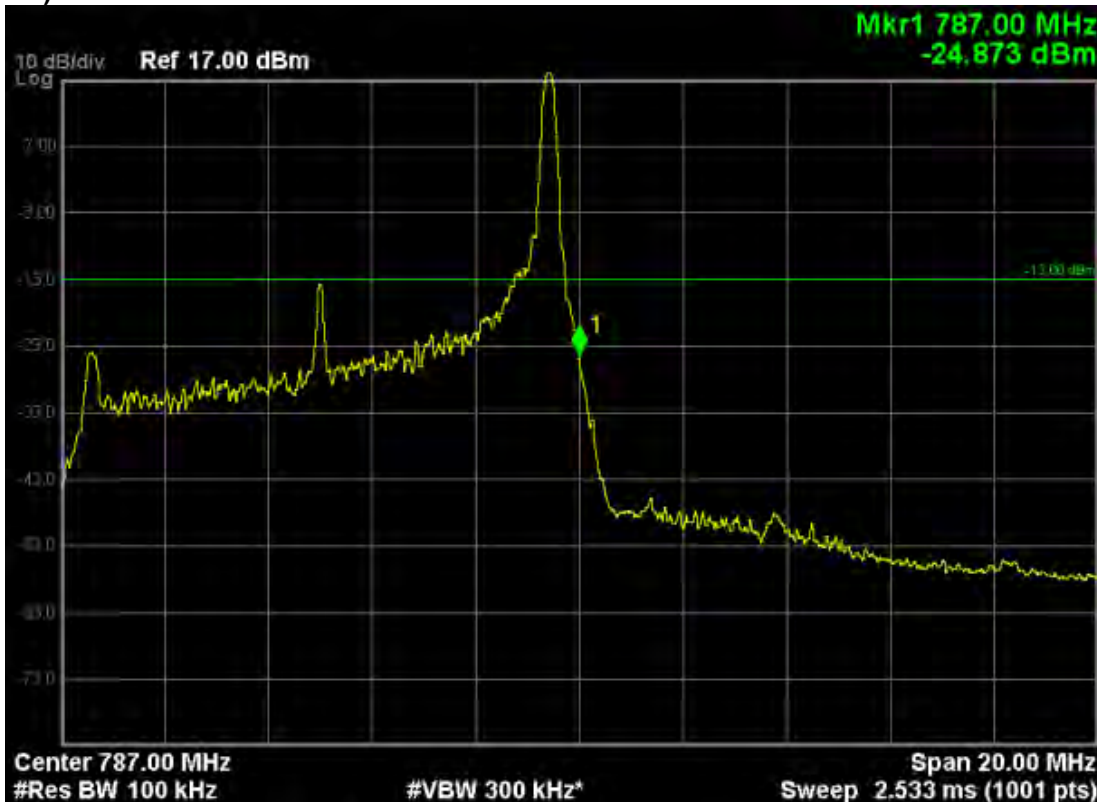

LTE Band 13 (QPSK, Band Width 10MHz, RB Size 50, RB Offset 0, Channel 23230, Frequency 782.0MHz)



LTE Band 13 (QPSK, Band Width 10MHz, RB Size 1, RB Offset 0, Channel 23230, Frequency 782.0MHz)

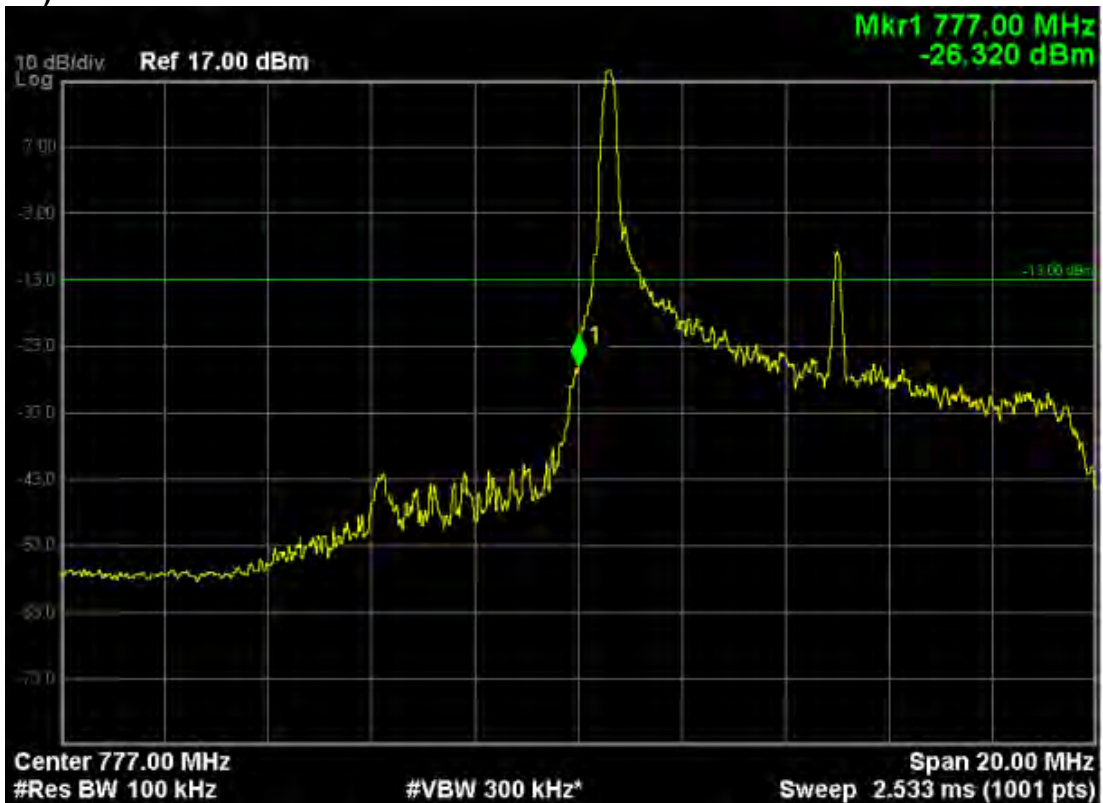

LTE Band 13 (QPSK, Band Width 10MHz, RB Size 50, RB Offset 0, Channel 23230, Frequency 782.0MHz)

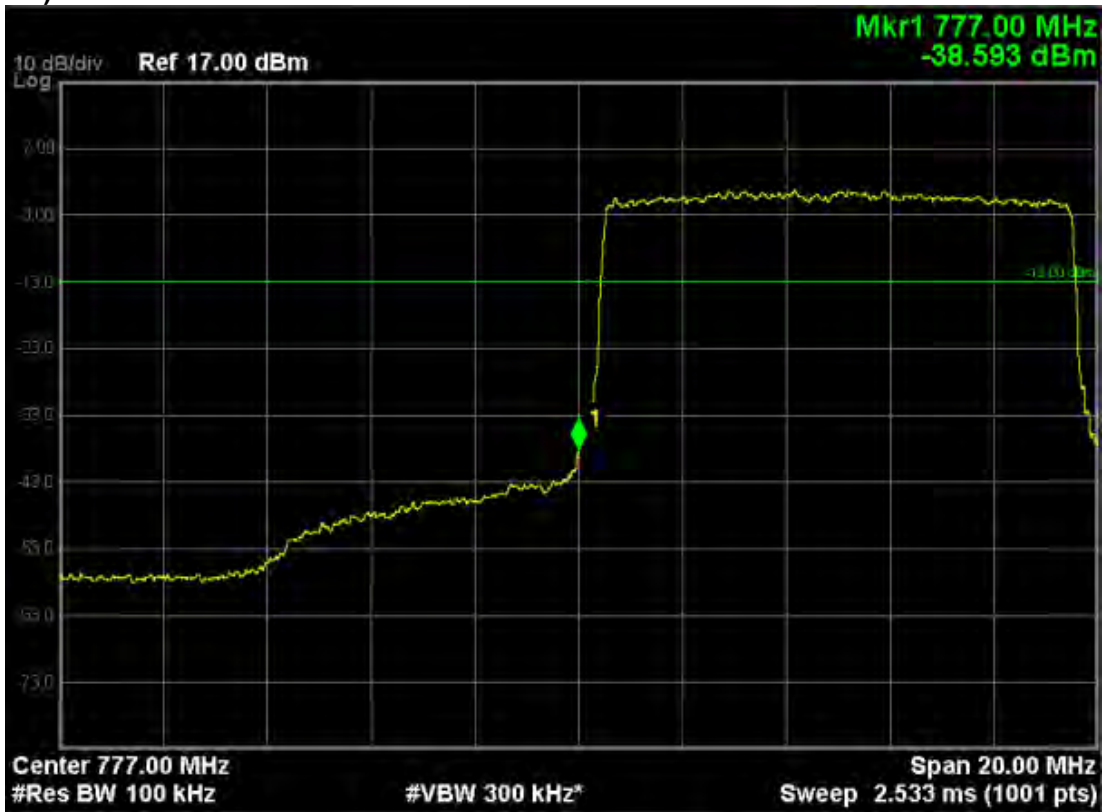

LTE Band 13 (QPSK, Band Width 10MHz, RB Size 1, RB Offset 49, Channel 23230, Frequency 782.0MHz)

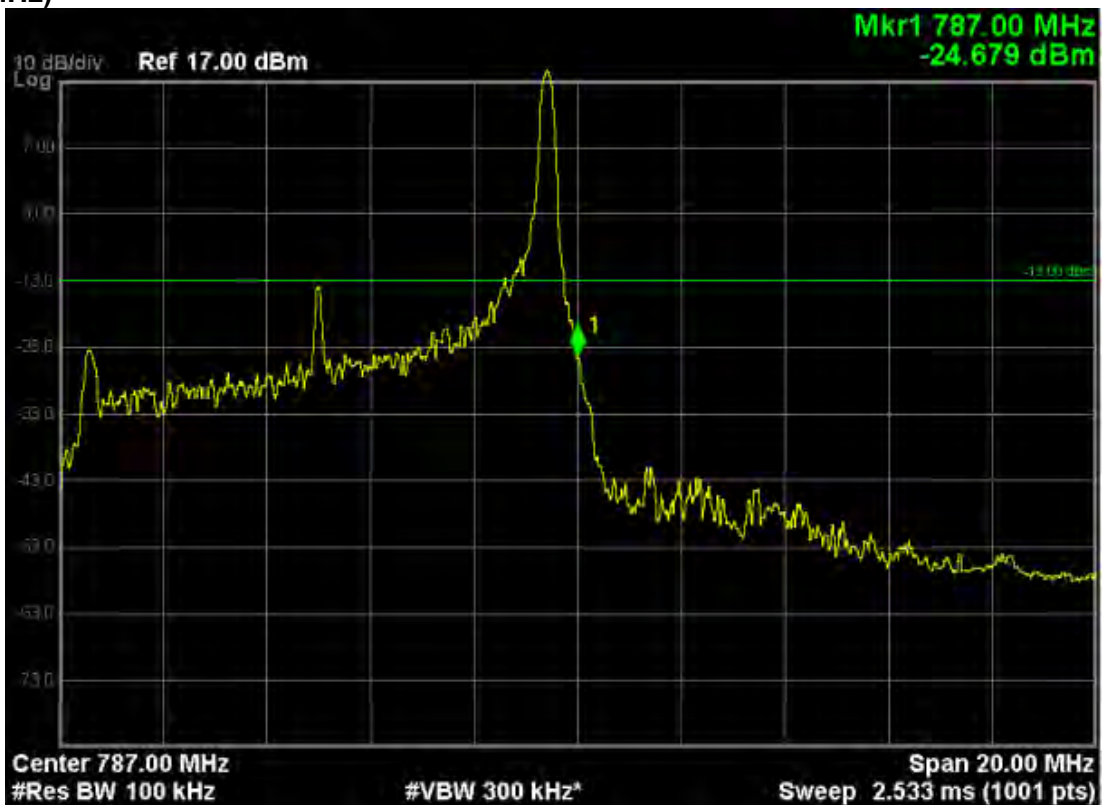

LTE Band 13 (QPSK, Band Width 10MHz, RB Size 50, RB Offset 0, Channel 23230, Frequency 782.0MHz)

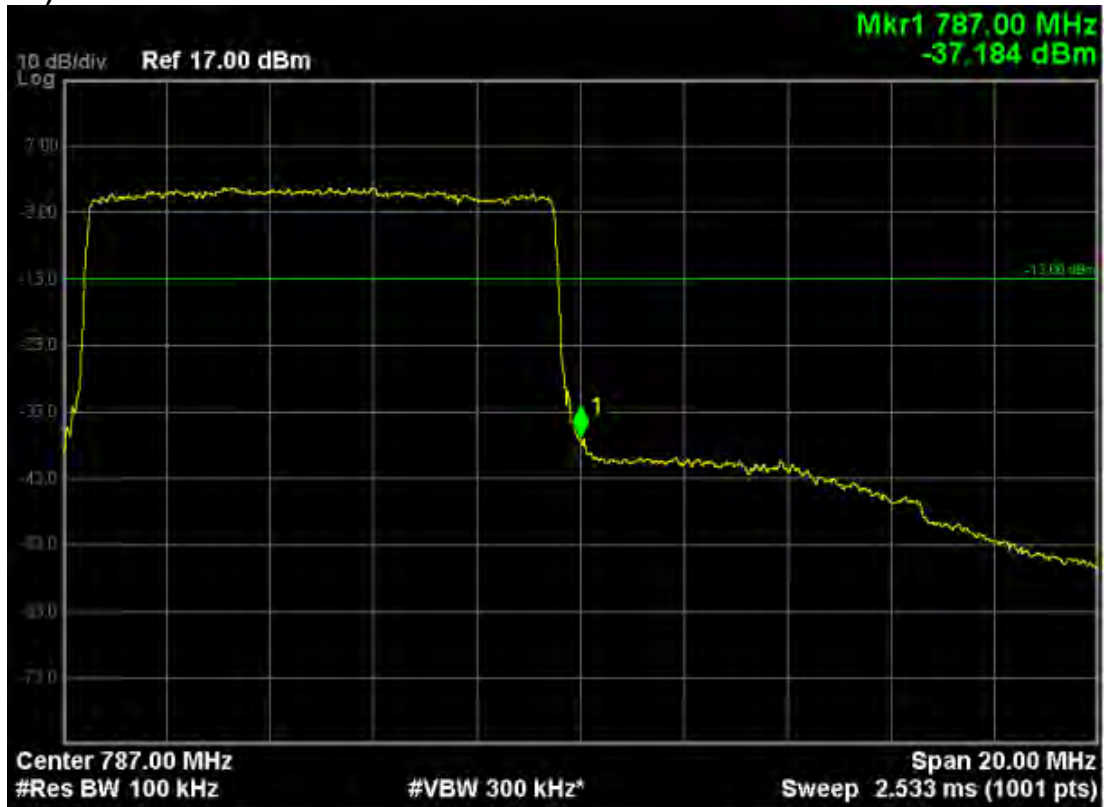

24V DC:

LTE Band 4 (QPSK, Band Width 5MHz, RB Size 1, RB Offset 0, Channel 19975, Frequency 1712.5MHz)

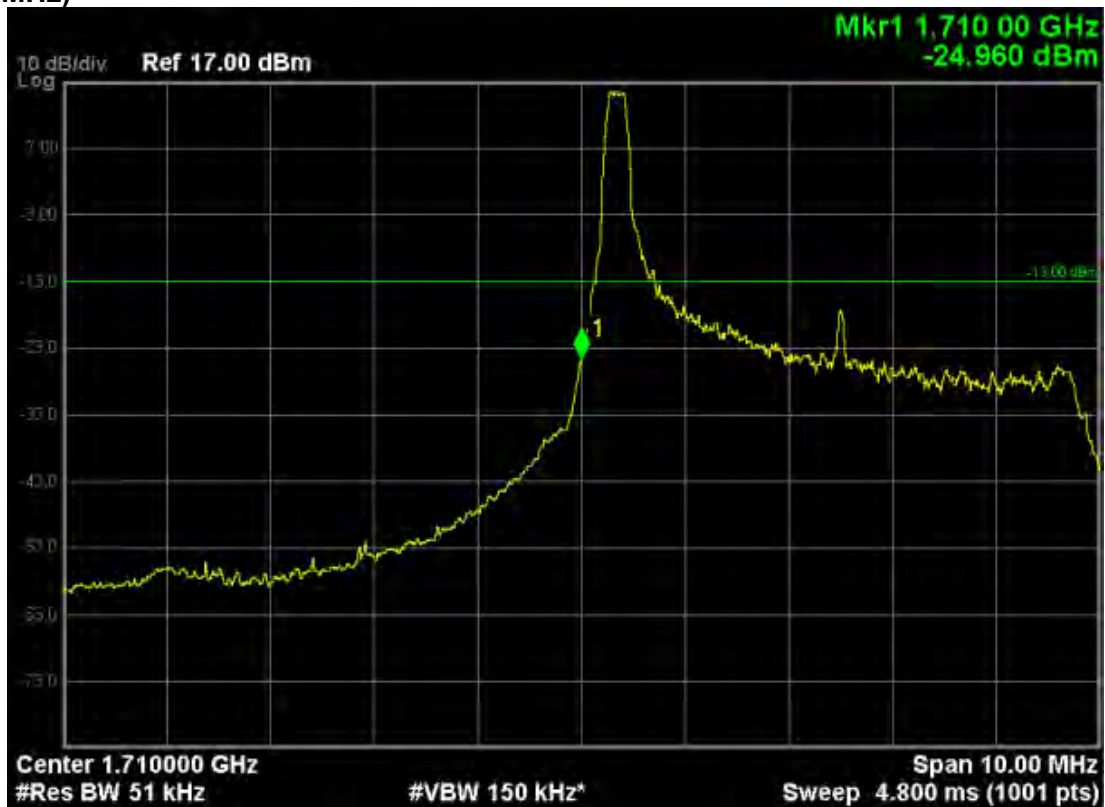

LTE Band 4 (QPSK, Band Width 5MHz, RB Size 25, RB Offset 0, Channel 19975, Frequency 1712.5MHz)

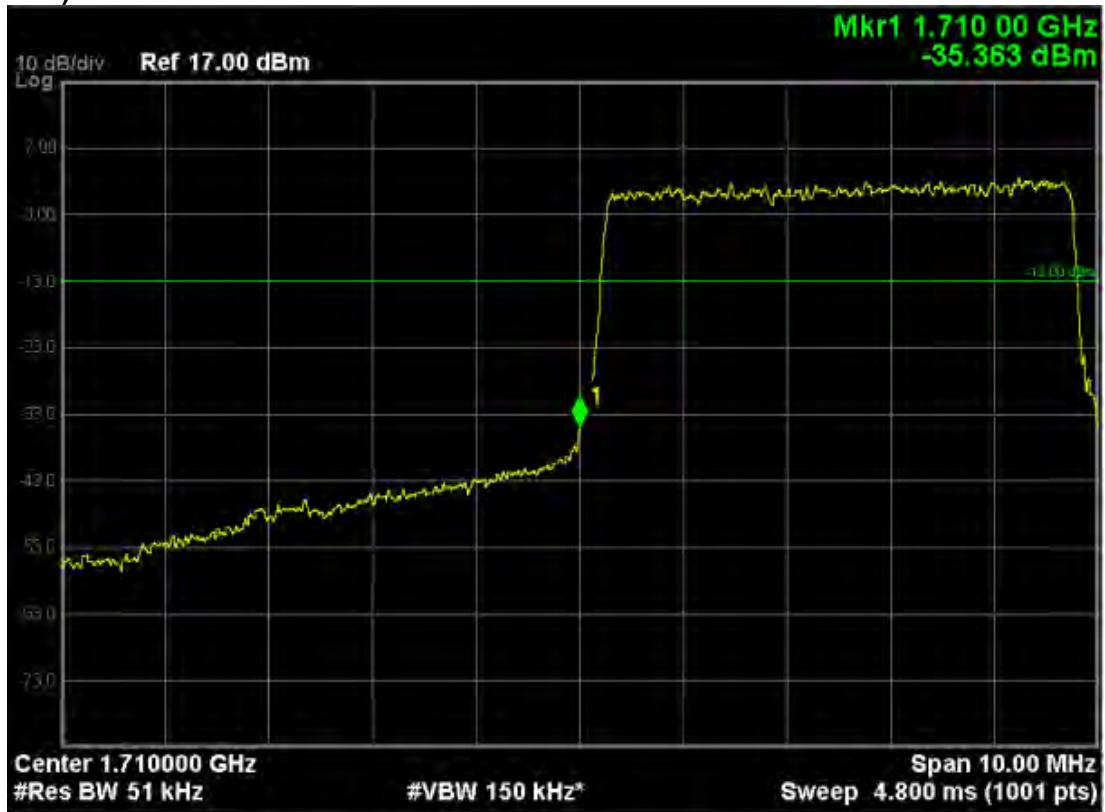

LTE Band 4 (QPSK, Band Width 5MHz, RB Size 1, RB Offset 24, Channel 20375, Frequency 1752.5MHz)

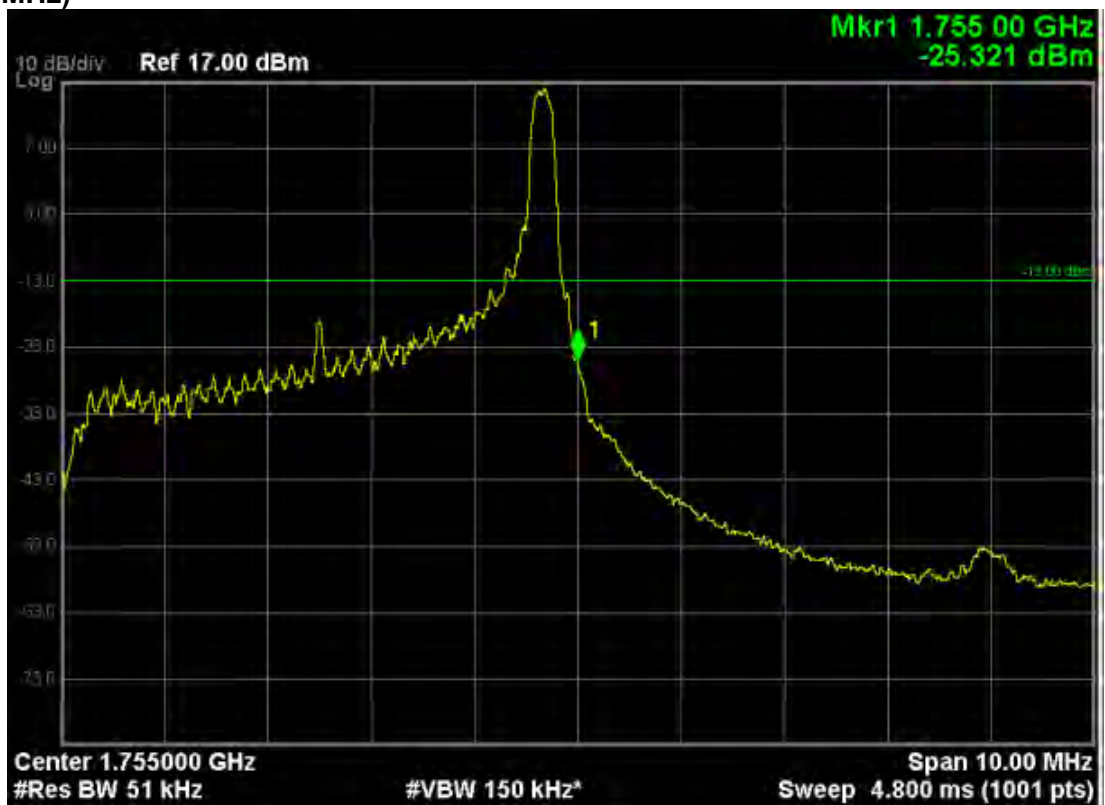

LTE Band 4 (QPSK, Band Width 5MHz, RB Size 25, RB Offset 0, Channel 20375, Frequency 1752.5MHz)

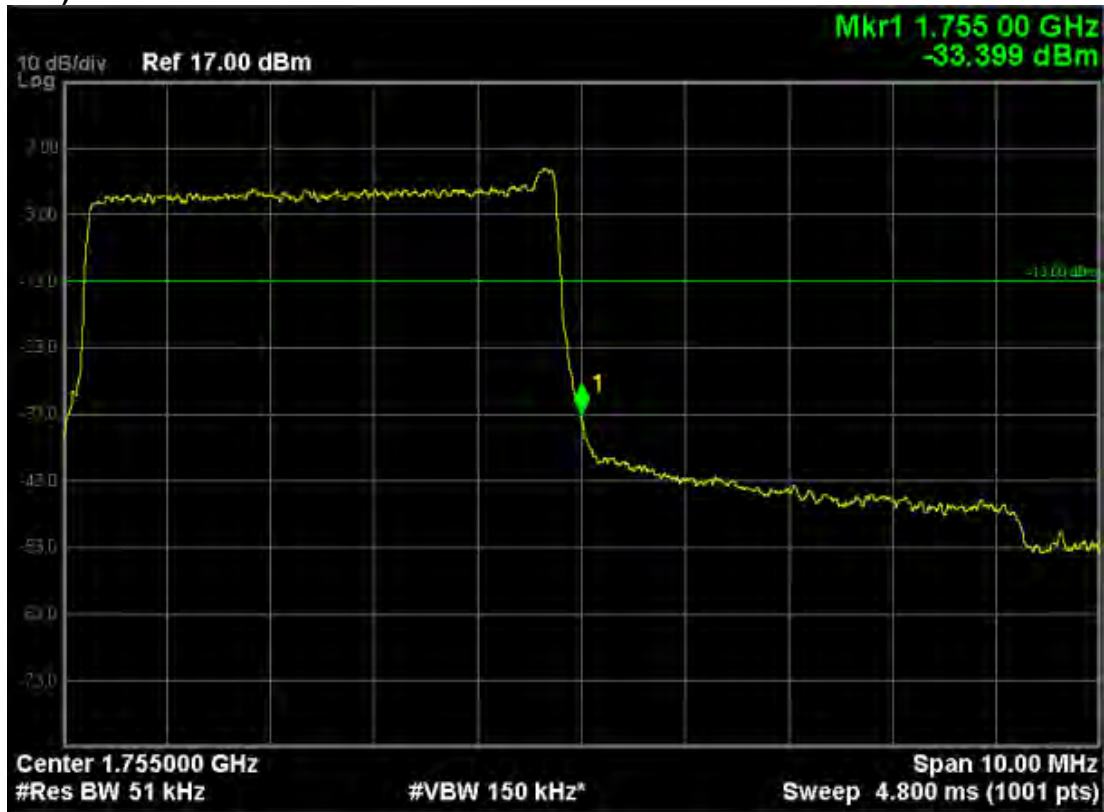

LTE Band 4 (16-QAM, Band Width 5MHz, RB Size 1, RB Offset 0, Channel 19975, Frequency 1712.5MHz)

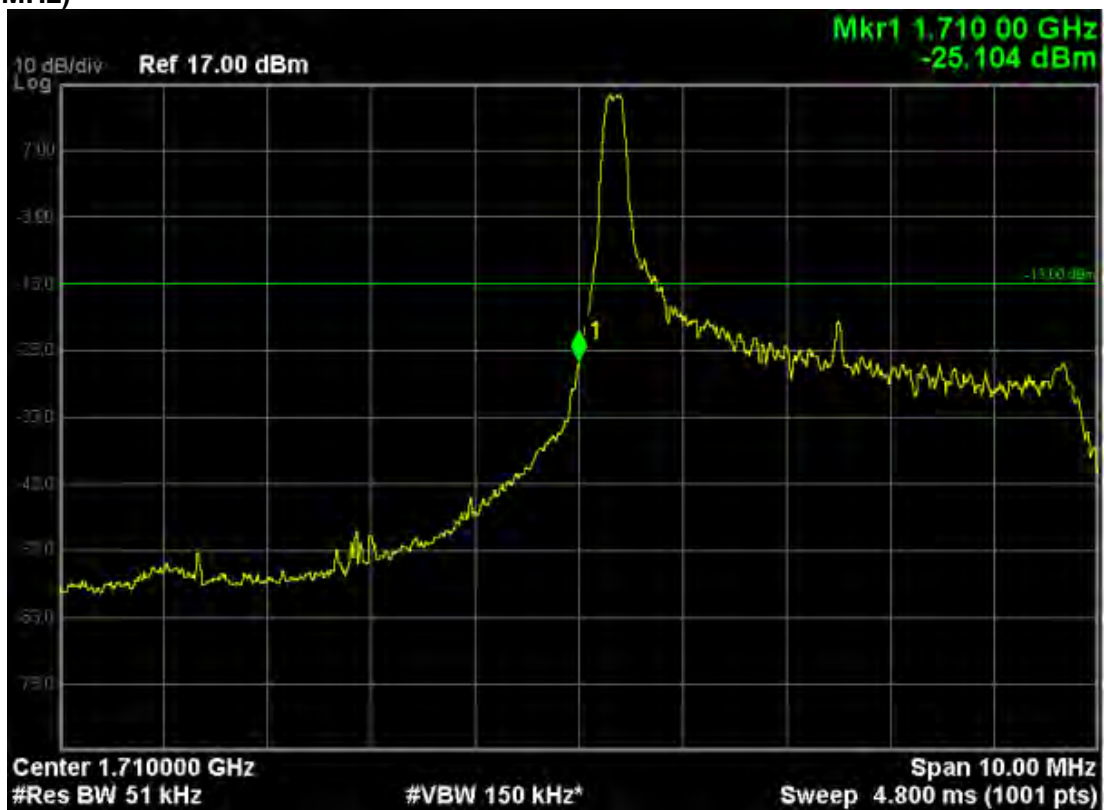

LTE Band 4 (16-QAM, Band Width 5MHz, RB Size 25, RB Offset 0, Channel 19975, Frequency 1712.5MHz)

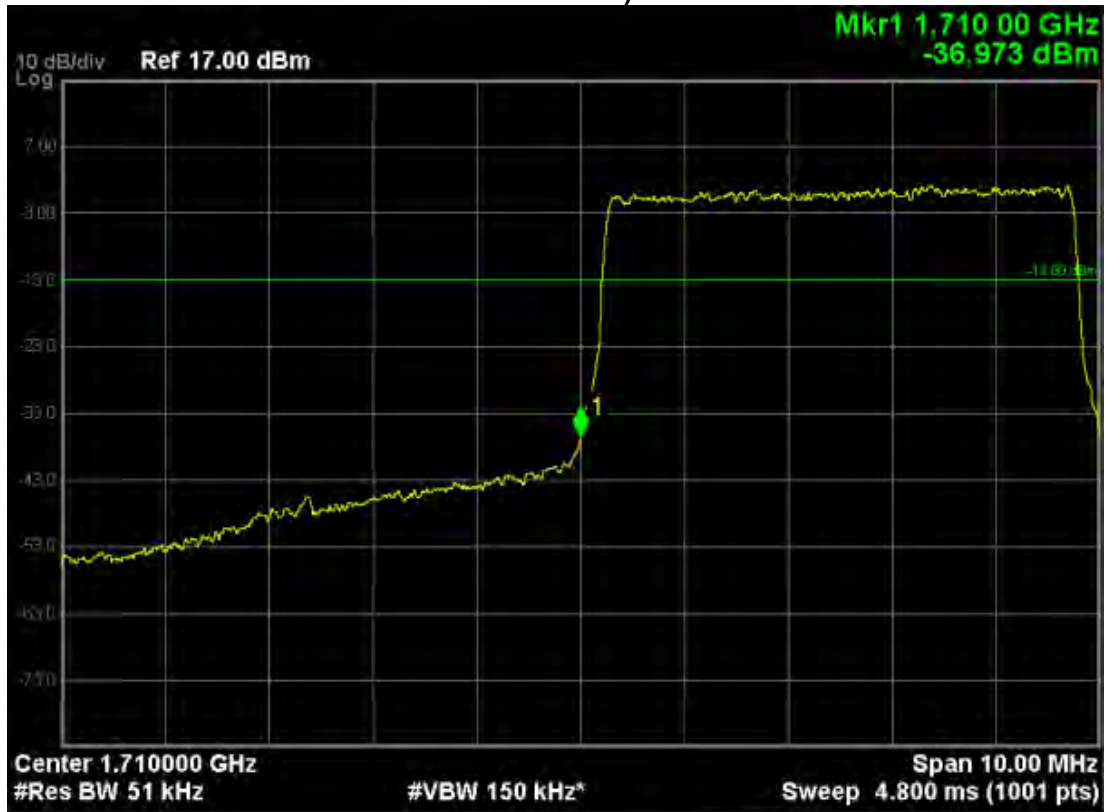

LTE Band 4 (16-QAM, Band Width 5MHz, RB Size 1, RB Offset 24, Channel 20375, Frequency 1752.5MHz)

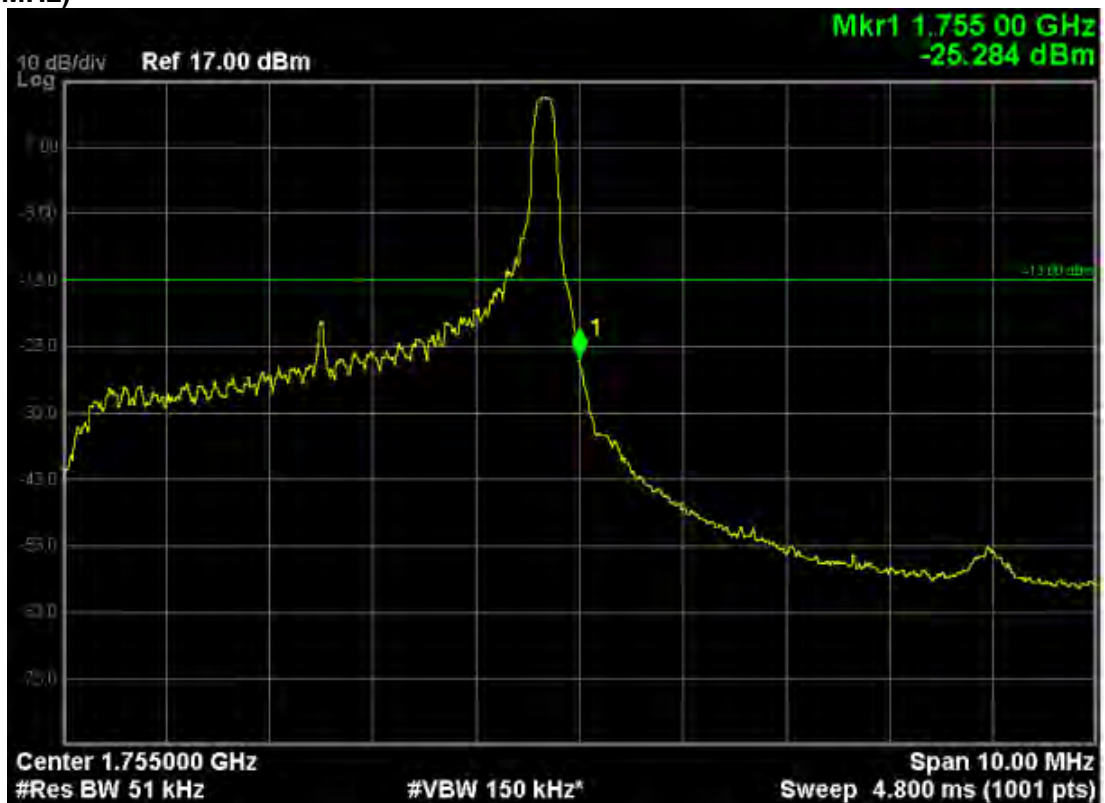

LTE Band 4 (16-QAM, Band Width 5MHz, RB Size 25, RB Offset 0, Channel 20375, Frequency 1752.5MHz)

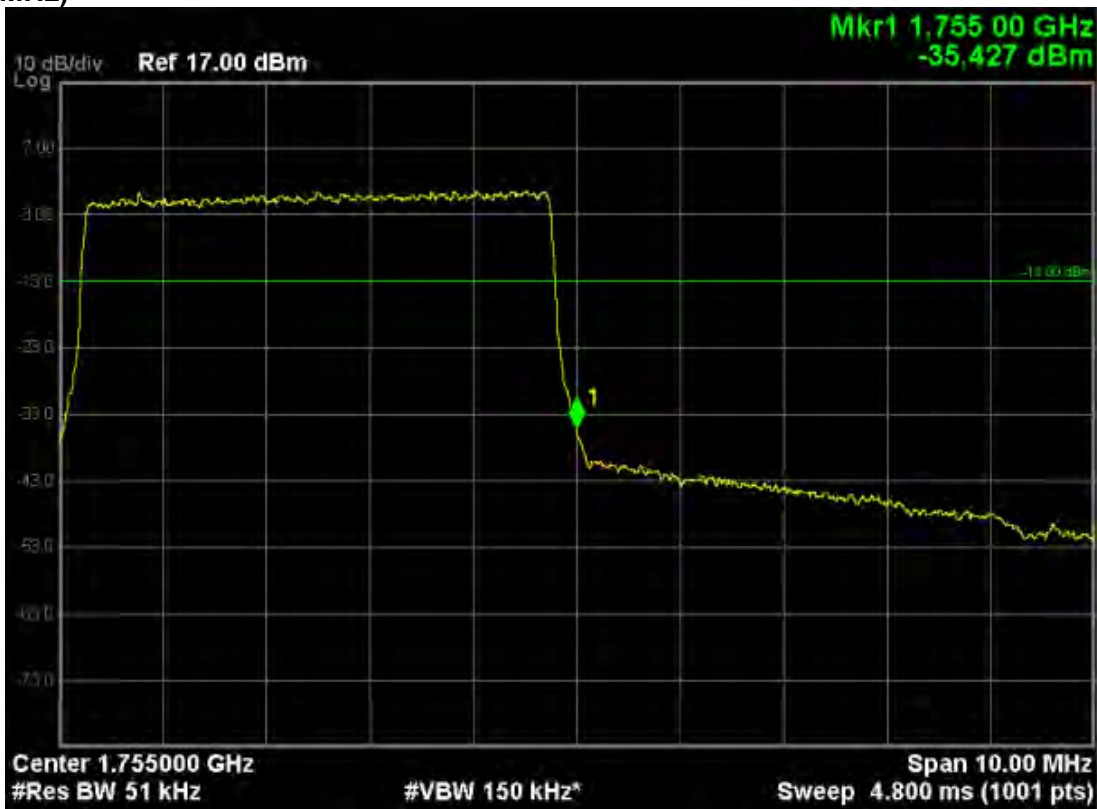

LTE Band 4 (QPSK, Band Width 10MHz, RB Size 1, RB Offset 0, Channel 20000, Frequency 1715.0MHz)

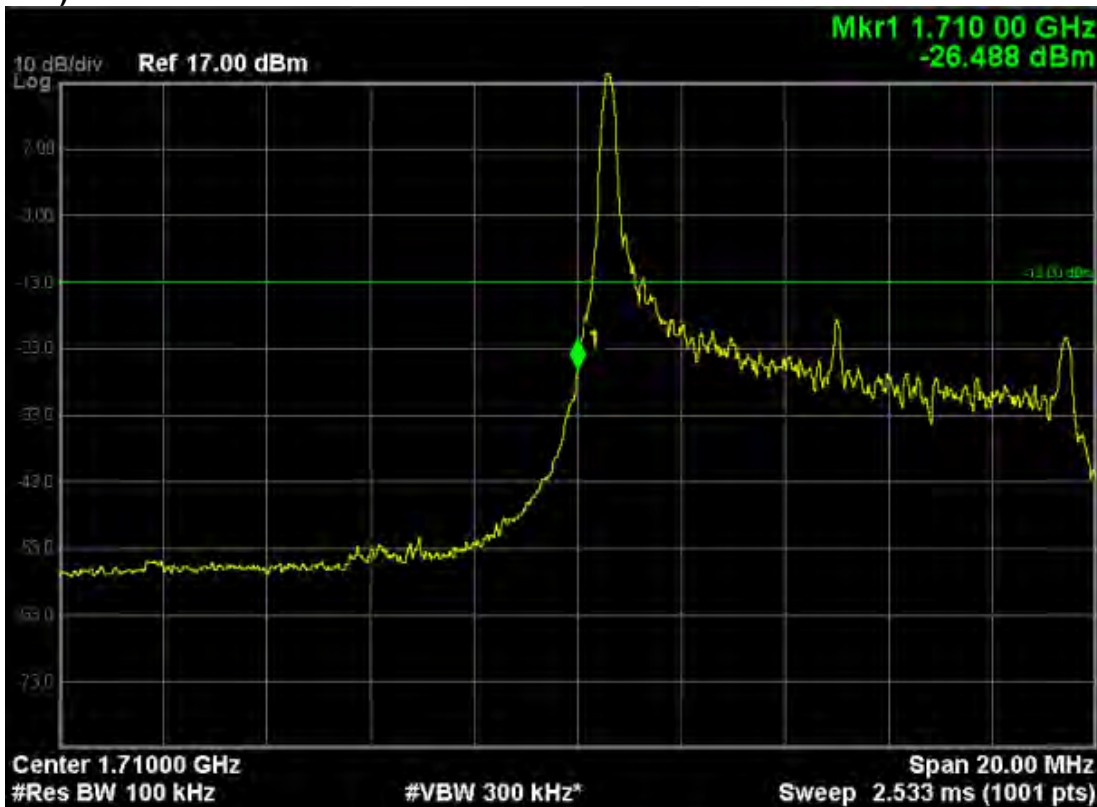

LTE Band 4 (QPSK, Band Width 10MHz, RB Size 50, RB Offset 0, Channel 20000, Frequency 1715.0MHz)

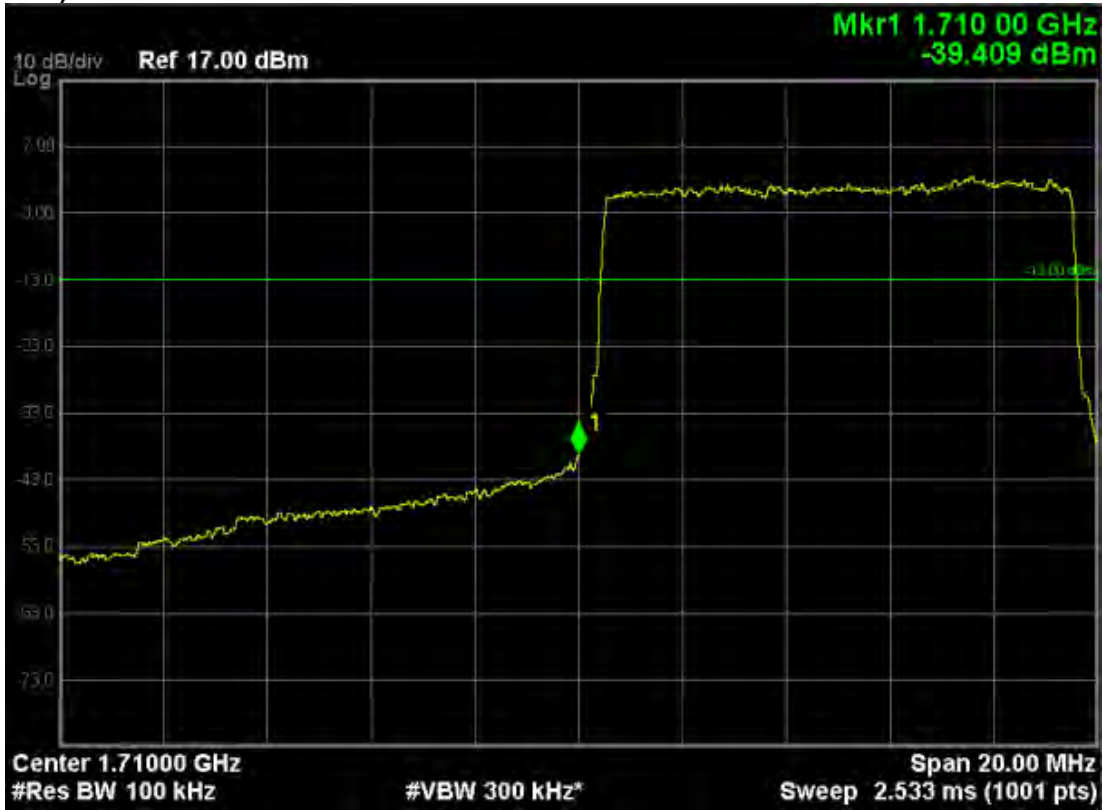

LTE Band 4 (QPSK, Band Width 10MHz, RB Size 1, RB Offset 49, Channel 20350, Frequency 1750.0MHz)

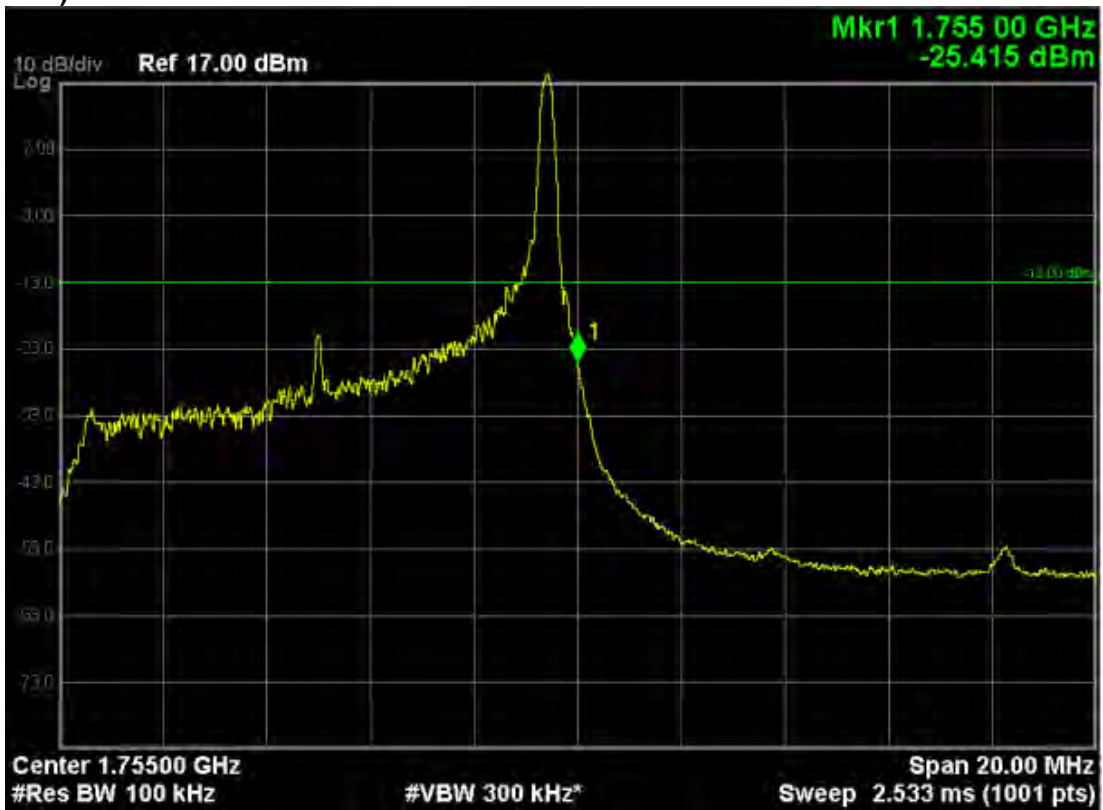

LTE Band 4 (QPSK, Band Width 10MHz, RB Size 50, RB Offset 0, Channel 20350, Frequency 1750.0MHz)



LTE Band 4 (16-QAM, Band Width 10MHz, RB Size 1, RB Offset 0, Channel 20000, Frequency 1715.0MHz)

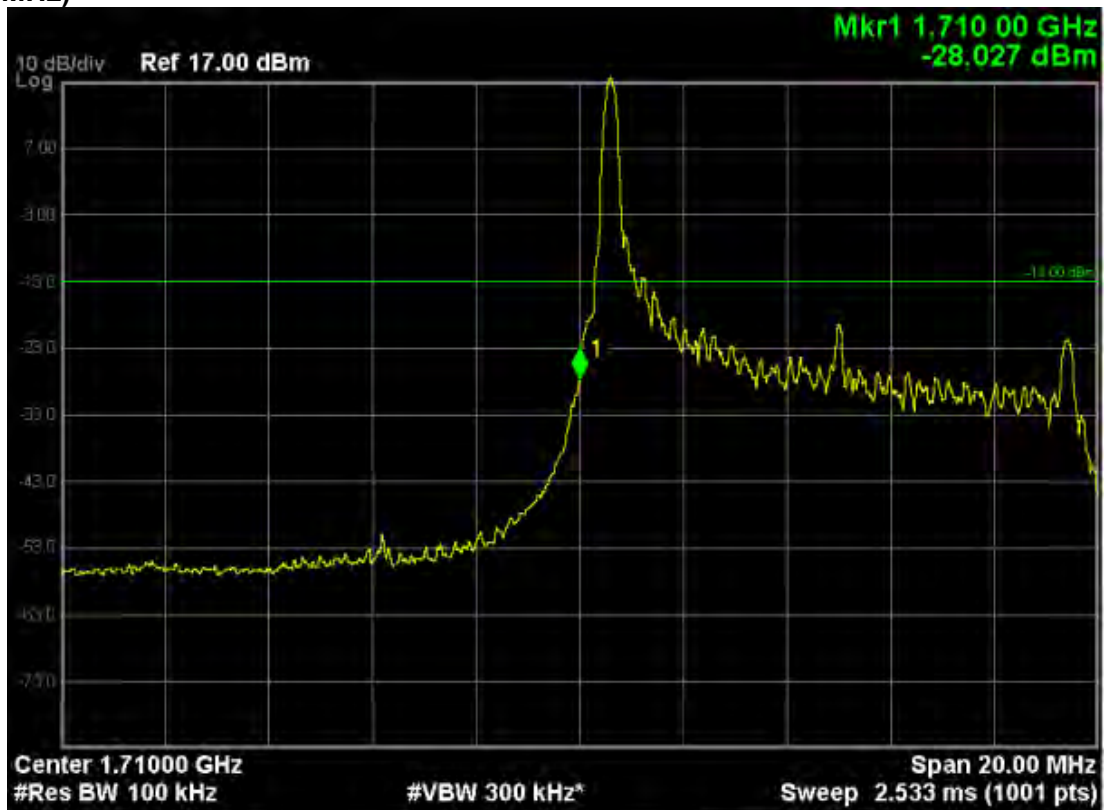

LTE Band 4 (16-QAM, Band Width 10MHz, RB Size 50, RB Offset 0, Channel 20000, Frequency 1715.0MHz)

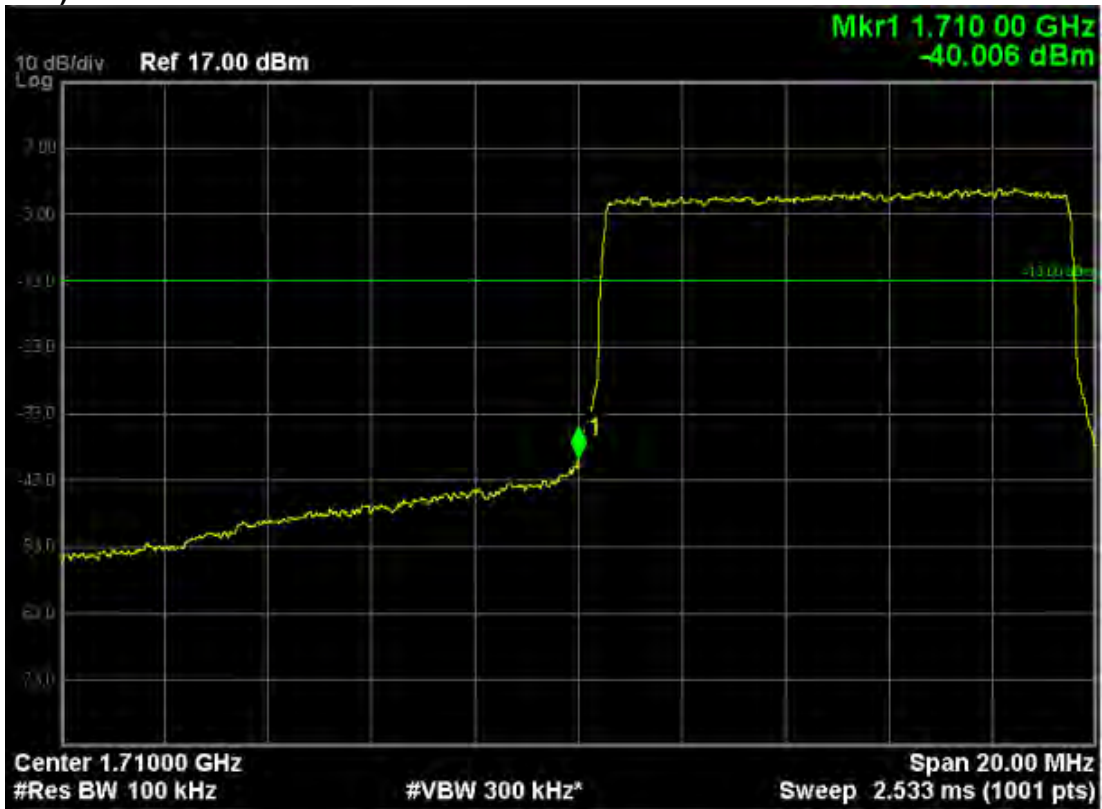

LTE Band 4 (16-QAM, Band Width 10MHz, RB Size 1, RB Offset 49, Channel 20350, Frequency 1755.0MHz)

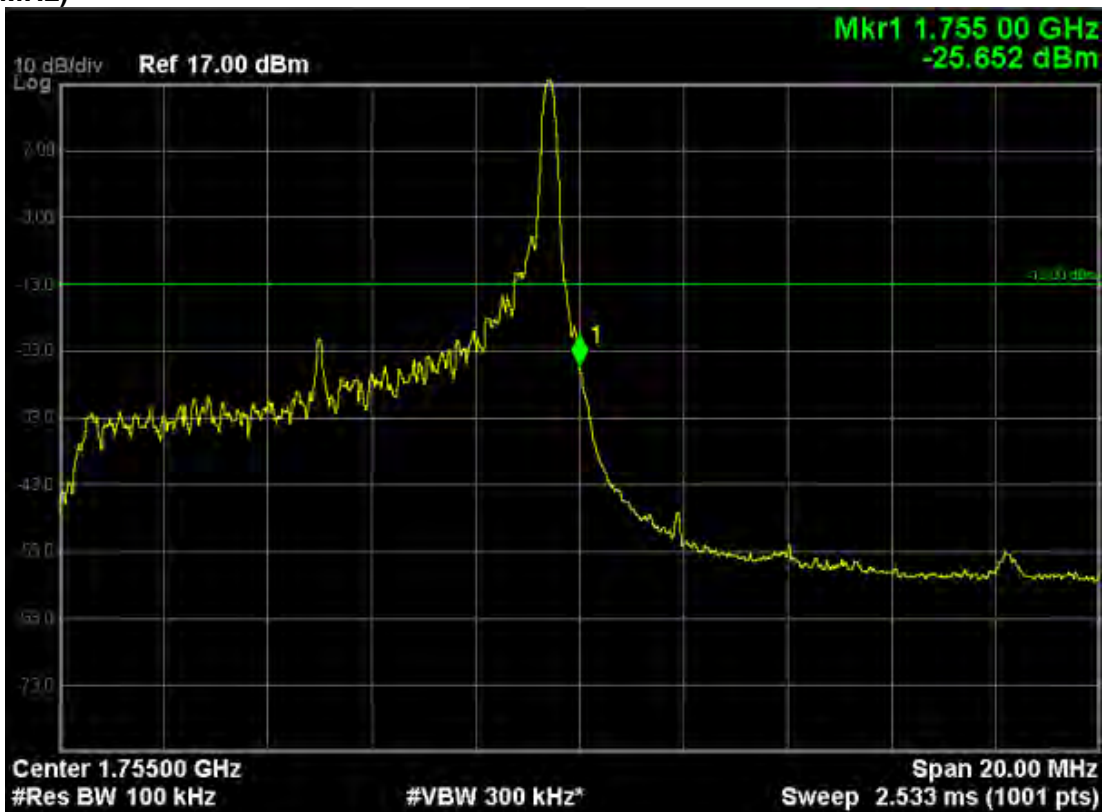

LTE Band 4 (16-QAM, Band Width 10MHz, RB Size 50, RB Offset 0, Channel 20350, Frequency 1755.0MHz)



LTE Band 13 (QPSK, Band Width 5MHz, RB Size 1, RB Offset 0, Channel 23205, Frequency 779.5MHz)

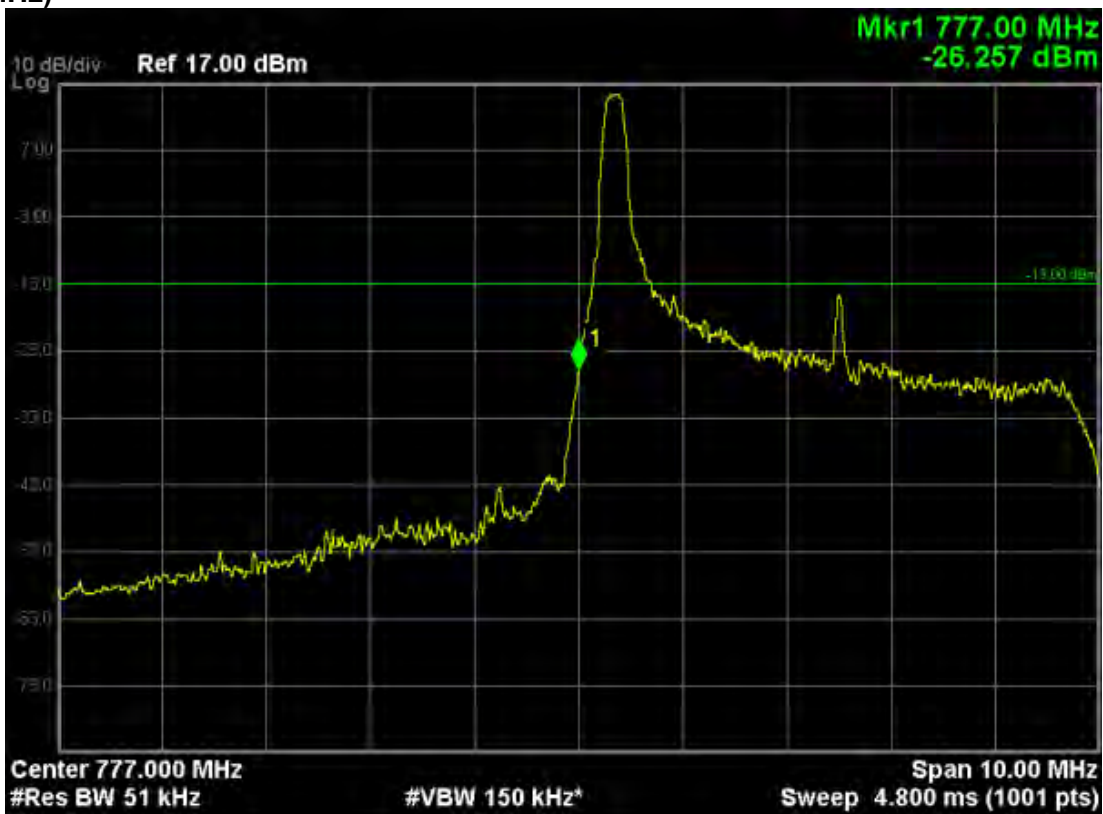

LTE Band 13 (QPSK, Band Width 5MHz, RB Size 25, RB Offset 0, Channel 23205, Frequency 779.5MHz)

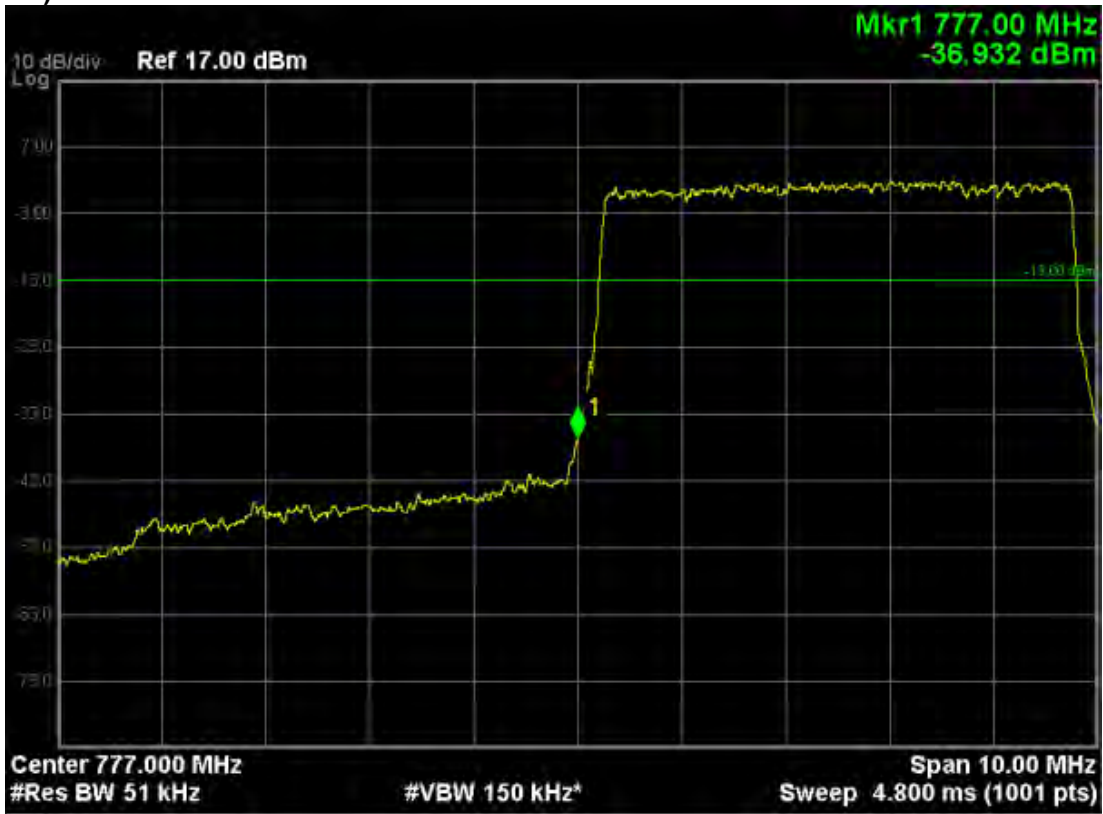

LTE Band 13 (QPSK, Band Width 5MHz, RB Size 1, RB Offset 24, Channel 23255, Frequency 784.5MHz)

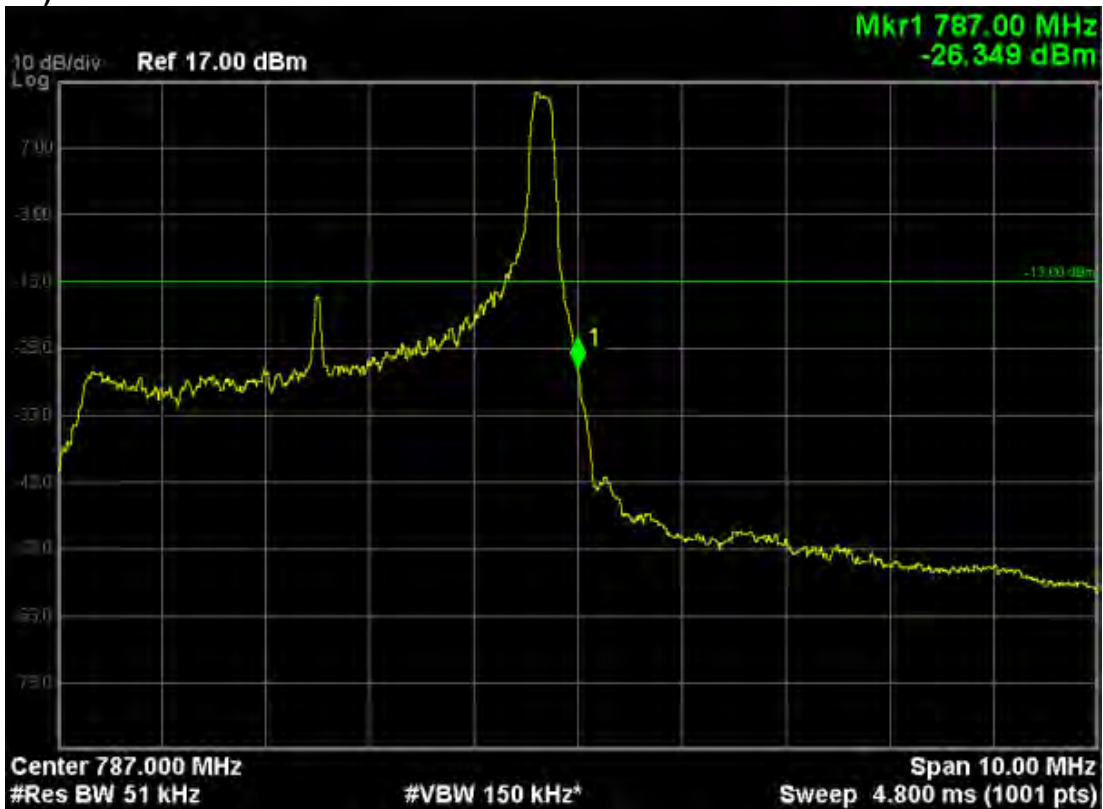

LTE Band 13 (QPSK, Band Width 5MHz, RB Size 25, RB Offset 0, Channel 23255, Frequency 784.5MHz)

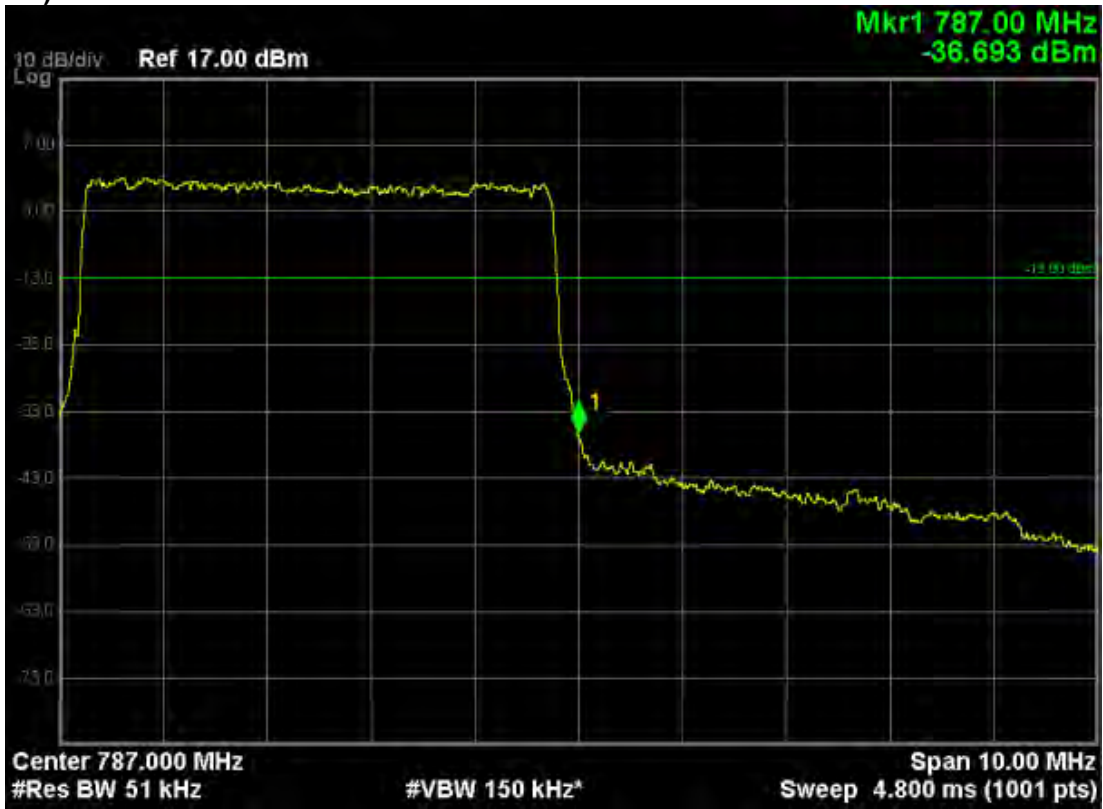

LTE Band 13 (16-QAM, Band Width 5MHz, RB Size 1, RB Offset 0, Channel 23205, Frequency 779.5MHz)

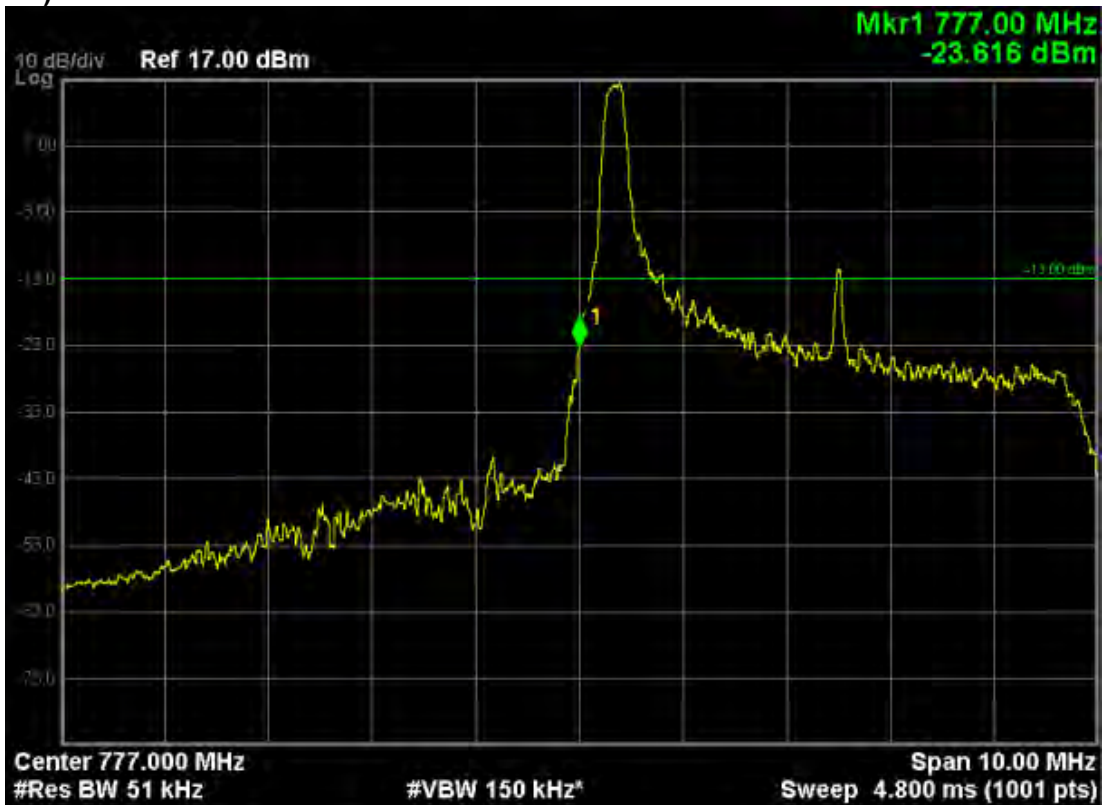

LTE Band 13 (16-QAM, Band Width 5MHz,RB Size 25,RB Offset 0,Channel 23205,Frequency 779.5MHz)

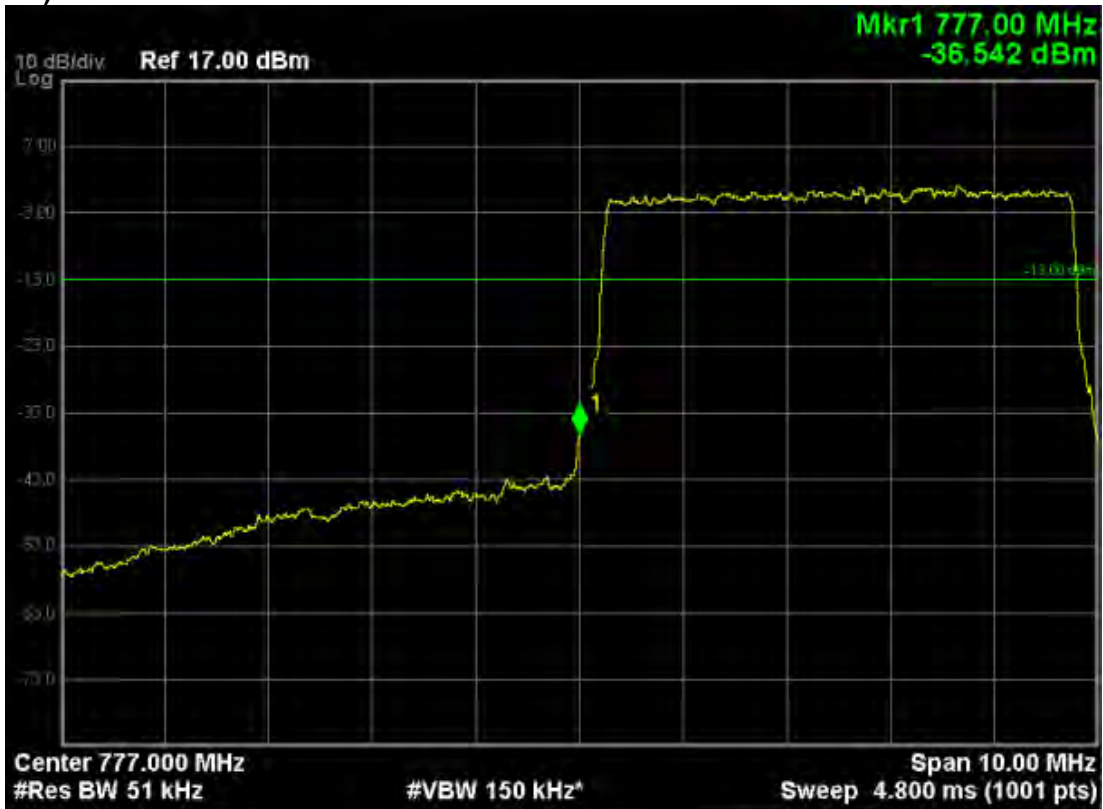

LTE Band 13 (16-QAM, Band Width 5MHz,RB Size 1,RB Offset 24,Channel 23255,Frequency 784.5MHz)

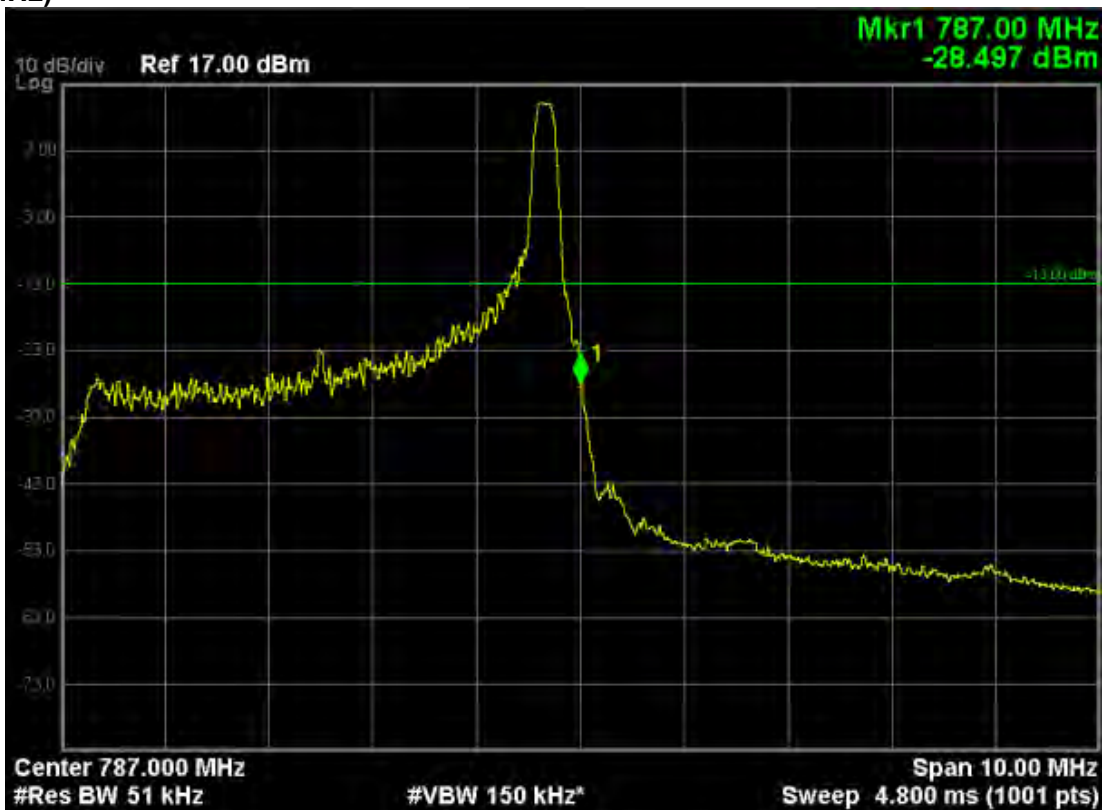

LTE Band 13 (16-QAM, Band Width 5MHz,RB Size 25,RB Offset 0,Channel 23255,Frequeny 784.5MHz)

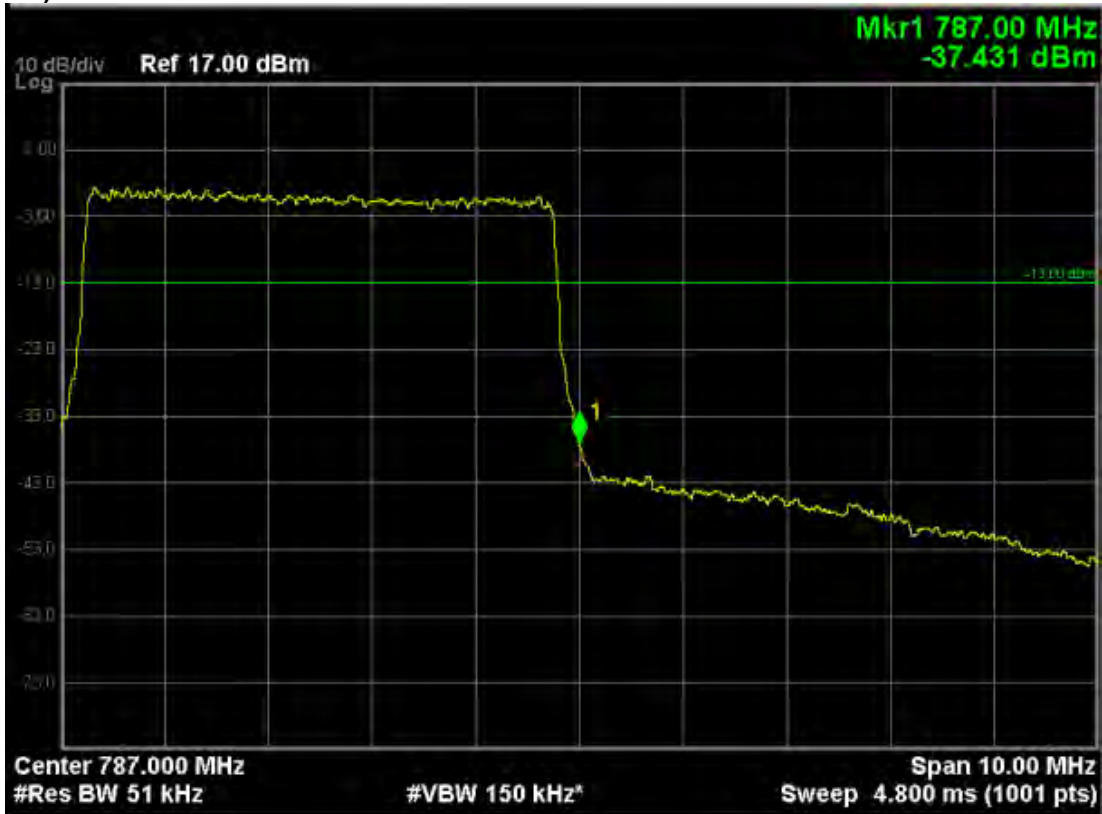

LTE Band 13 (QPSK, Band Width 10MHz,RB Size 1,RB Offset 0,Channel 23230,Frequeny 782.0MHz)

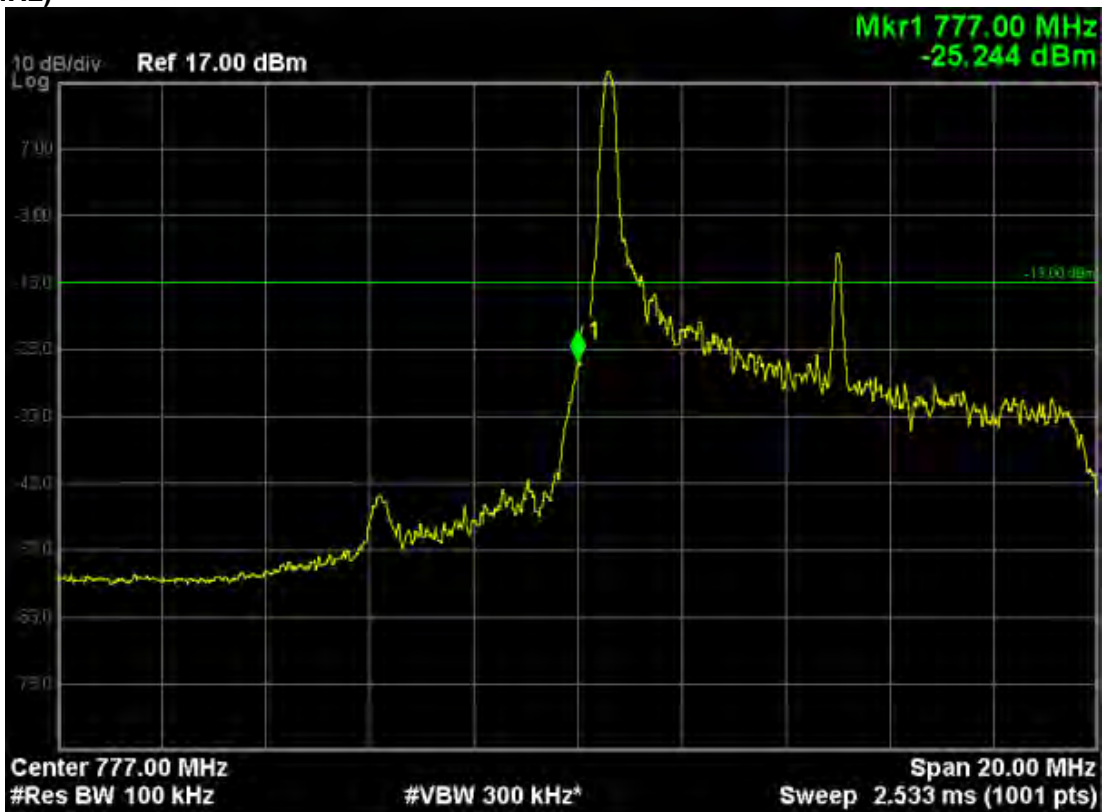

LTE Band 13 (QPSK, Band Width 10MHz, RB Size 50, RB Offset 0, Channel 23230, Frequency 782.0MHz)

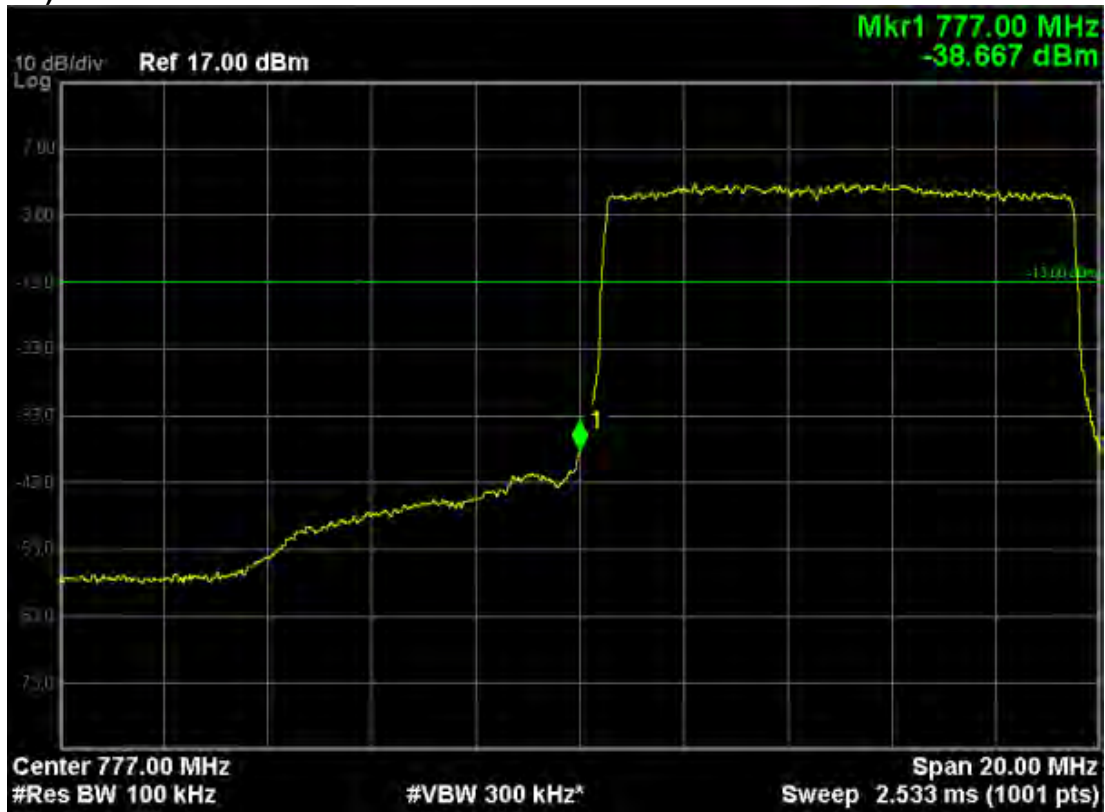

LTE Band 13 (QPSK, Band Width 10MHz, RB Size 1, RB Offset 49, Channel 23230, Frequency 782.0MHz)

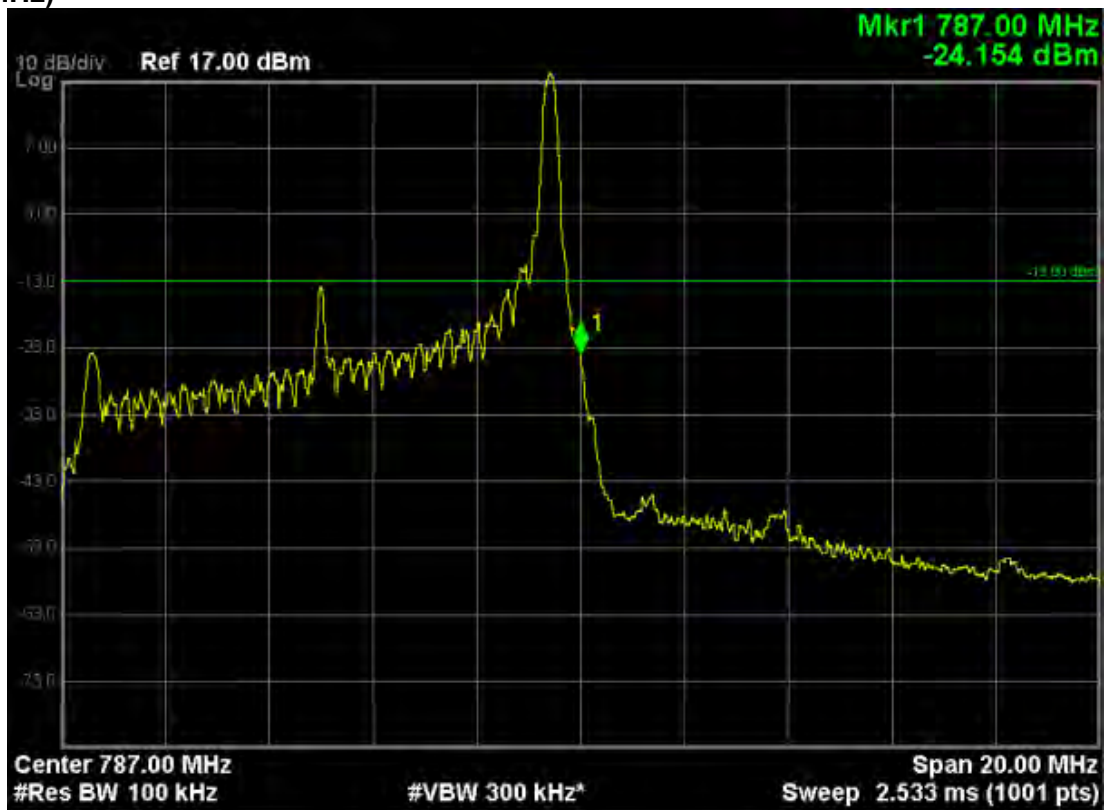

LTE Band 13 (QPSK, Band Width 10MHz, RB Size 50, RB Offset 0, Channel 23230, Frequency 782.0MHz)



LTE Band 13 (QPSK, Band Width 10MHz, RB Size 1, RB Offset 0, Channel 23230, Frequency 782.0MHz)

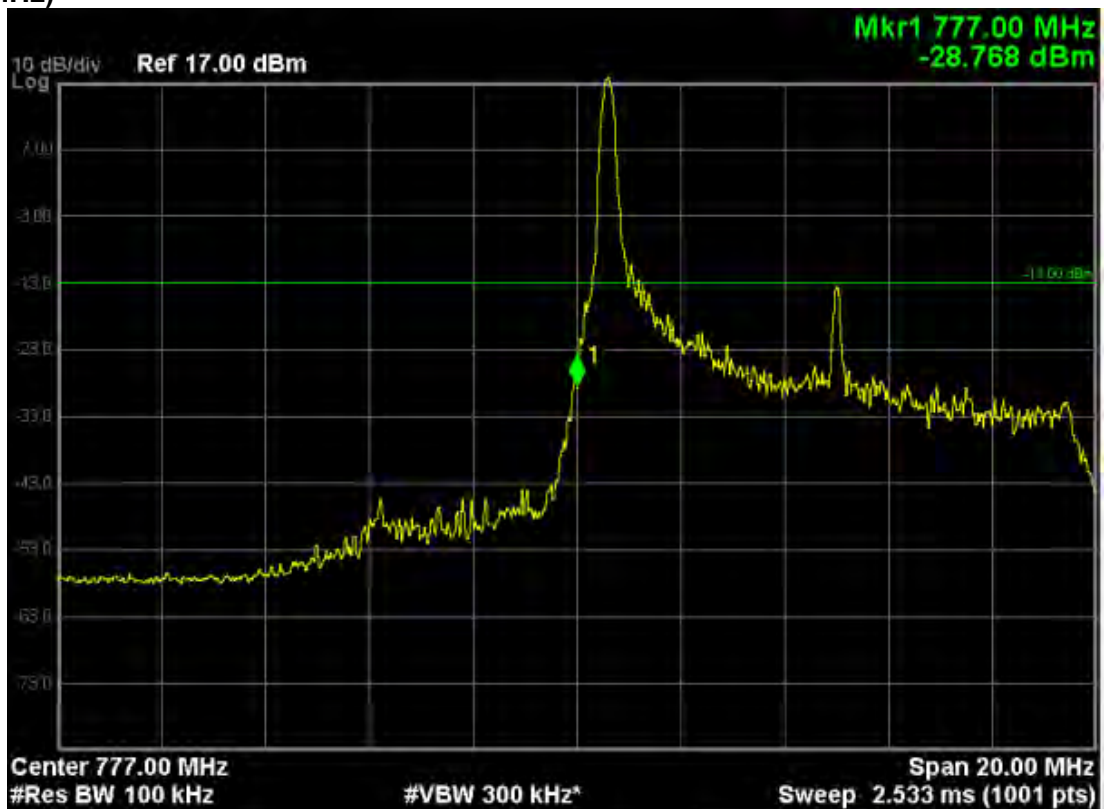

LTE Band 13 (QPSK, Band Width 10MHz, RB Size 50, RB Offset 0, Channel 23230, Frequency 782.0MHz)

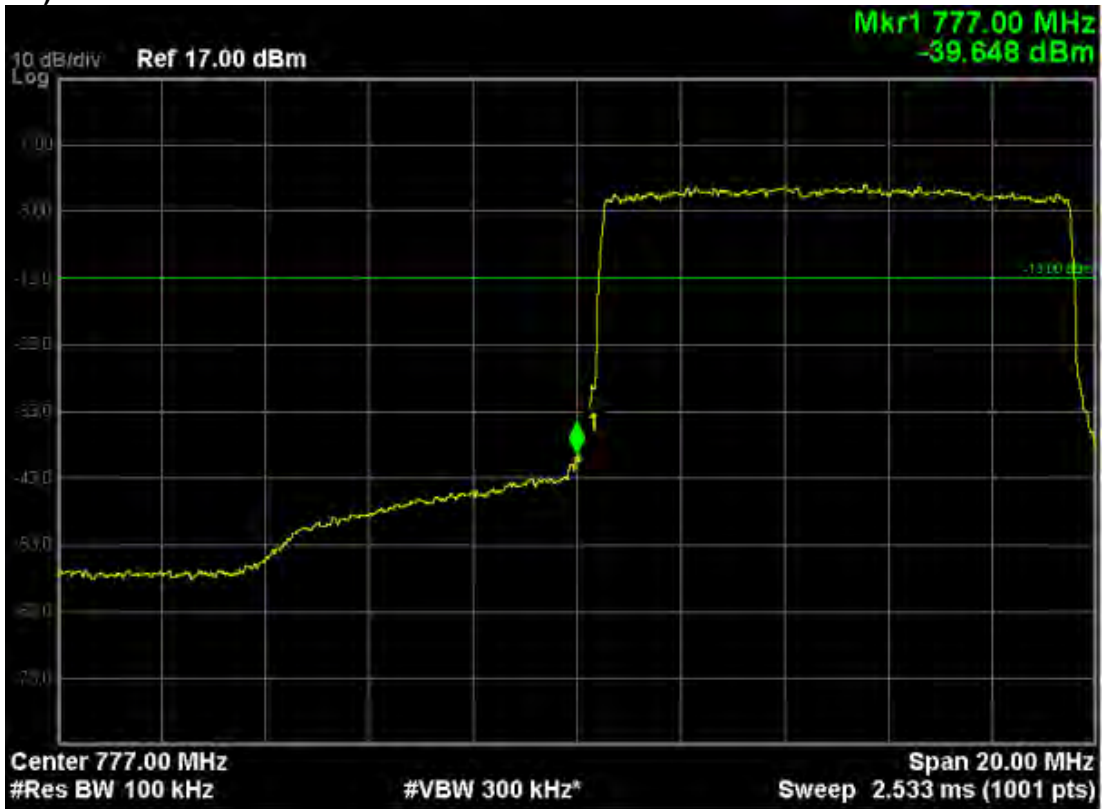

LTE Band 13 (QPSK, Band Width 10MHz, RB Size 1, RB Offset 49, Channel 23230, Frequency 782.0MHz)

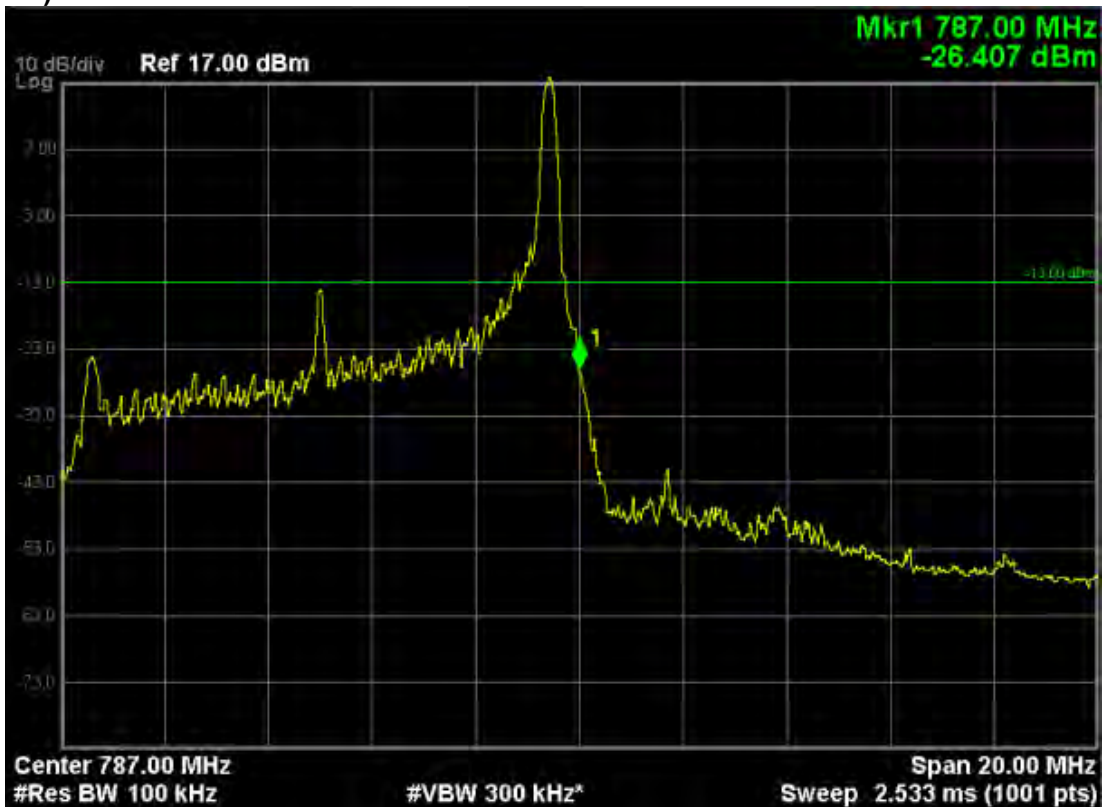

LTE Band 13 (QPSK, Band Width 10MHz, RB Size 50, RB Offset 0, Channel 23230, Frequency 782.0MHz)

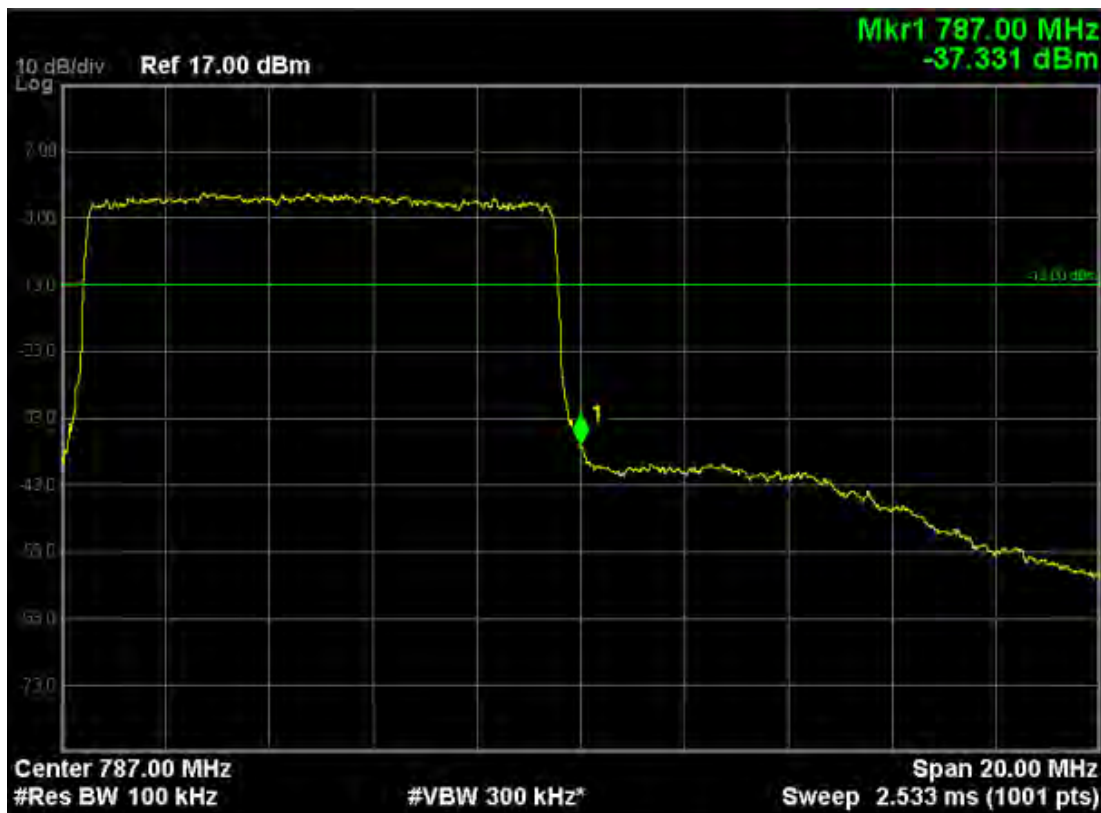

6.Spurious Emission

6.1. Test Equipment

Instrument	Manufacturer	Model	Serial No.	Due Date
SpectrumAnalyzer	Agilent	N9038A	MY51210142	11/04/2017
Radio Communication Tester	R&S	CMW500	147483	11/07/2017
SignalGenerator	Agilent	N5183A	MY50140938	01/02/2018
Preamplifier	CEM	EM30180	3008A0245	02/25/2018
Loop Antenna	Schwarzbeck	FMZB1519	1519-020	03/24/2017
Bilog Antenna	Schwarzbeck	VULB9160	9160-3316	09/18/2017
VHF-UHF-Biconical Antenna	Schwarzbeck	VUBA9117	9117-263	09/18/2017
Broad-Band Horn Antenna	Schwarzbeck	BBHA9120D	9120D-942	09/18/2017
Broad-Band Horn Antenna	Schwarzbeck	BBHA9120D	9120D-943	09/18/2017

The measure equipment had been calibrated once a year.

6.2. Test Setup

Conducted Spurious Emission Measurement:

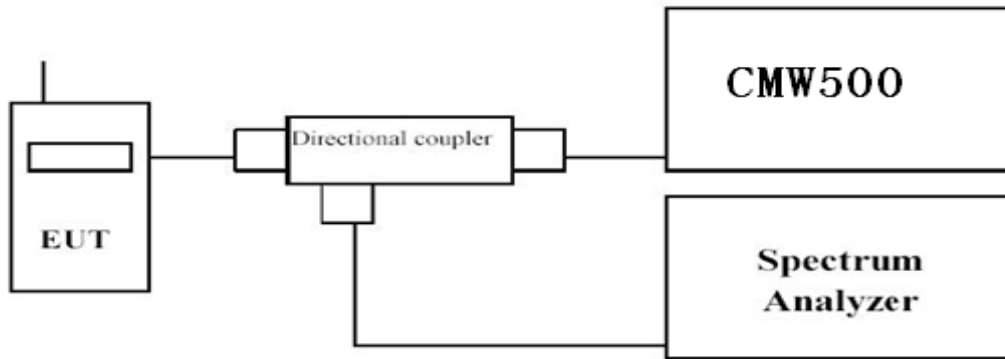

Radiated Spurious Measurement: below 30MHz

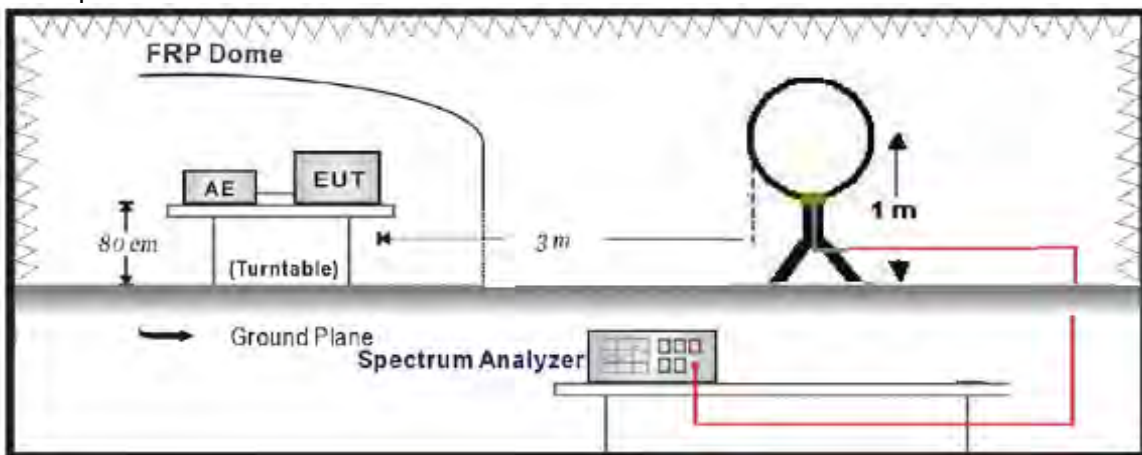

Radiated Spurious Measurement: 30MHz to 1GHz

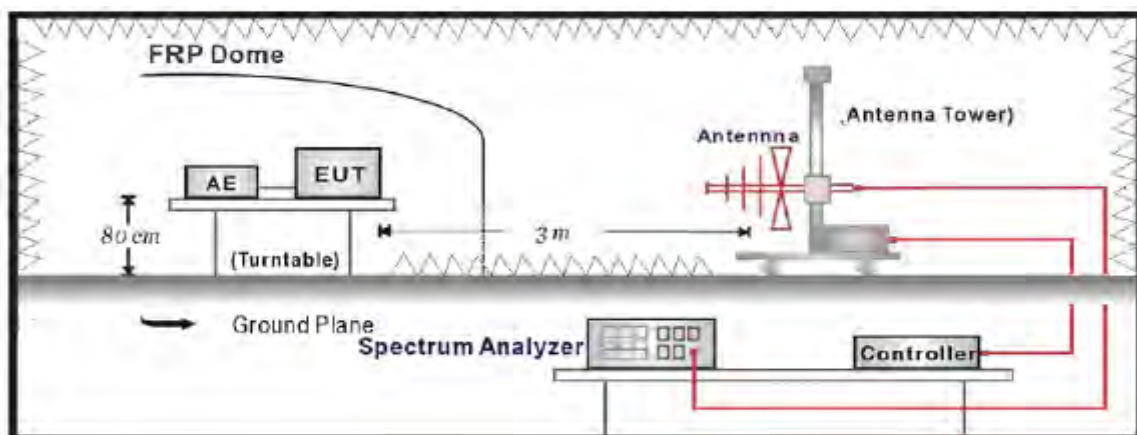

Radiated Spurious Measurement: above 1GHz

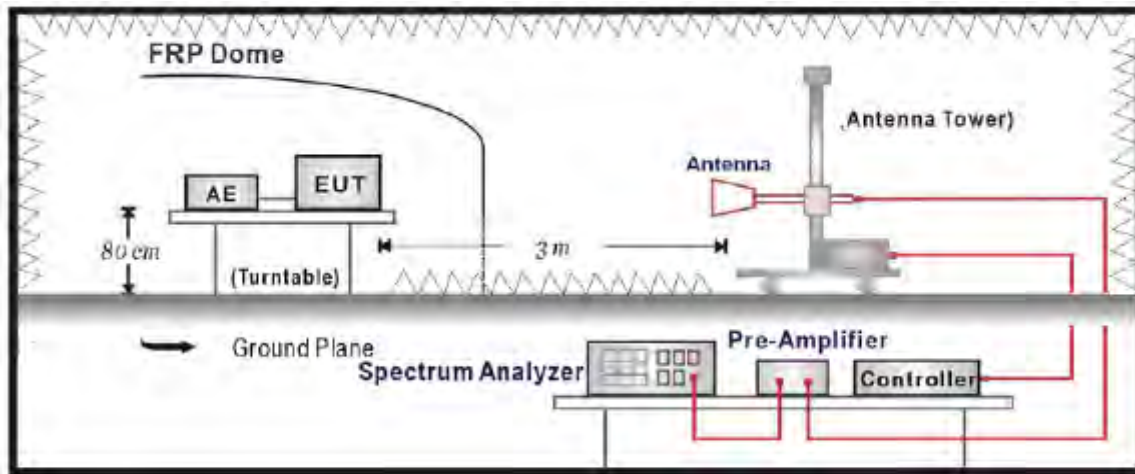

6.3. Limit

The power of any emission outside of the authorized operating frequency ranges must be attenuated below the transmitting power (P) by a factor of at least $43 + 10\log(P)$ dB.

6.4. Test Procedure

Conducted Spurious Measurement:

- The testing follows FCC KDB 971168 v02v02 Section 6.0;
- Place the EUT on a bench and set it in transmitting mode.
- Connect a low loss RF cable from the antenna port to a spectrum analyzer and CMW500 by a Directional Coupler.
- EUT Communicate with CMW500, then select a channel for testing.
- Add a correction factor to the display of spectrum, and then test.
- The resolution bandwidth of the spectrum analyzer was set at 1 MHz, sufficient scans were taken to show the out of band Emission if any up to 10th harmonic.

Radiated Spurious Measurement:

- The testing follows FCC KDB 971168 v02v02 Section 5.8 and ANSI/TIA-603-D-2010 Section 2.2.12;
- The EUT shall be placed at the specified height on a support, and in the position closest to normal use as declared by provider.
- The test antenna shall be oriented initially for vertical polarization and shall be chosen to correspond to the frequency of the transmitter
- The output of the test antenna shall be connected to the measuring receiver. The transmitter shall be switched on and the measuring receiver shall be tuned to the frequency of the transmitter under test.
- The test antenna shall be raised and lowered through the specified range of height until a maximum signal level is detected by the measuring receiver.

- f. The transmitter shall then be rotated through 360° in the horizontal plane, until the maximum signal level is detected by the measuring receiver.
- g. The test antenna shall be raised and lowered again through the specified range of height until a maximum signal level is detected by the measuring receiver.
- h. The maximum signal level detected by the measuring receiver shall be noted.
- i. The transmitter shall be replaced by a substitution antenna.
- j. The substitution antenna shall be orientated for vertical polarization and the length of the substitution antenna shall be adjusted to correspond to the frequency of the transmitter.
- k. The substitution antenna shall be connected to a calibrated signal generator.
- l. If necessary, the input attenuator setting of the measuring receiver shall be adjusted in order to increase the sensitivity of the measuring receiver.
- m. The test antenna shall be raised and lowered through the specified range of height to ensure that the maximum signal is received.
- n. The input signal to the substitution antenna shall be adjusted to the level that produces a level detected by the measuring receiver, that is equal to the level noted while the transmitter radiated power was measured, corrected for the change of input attenuator setting of the measuring receiver.
- o. The measurement shall be repeated with the test antenna and the substitution antenna orientated for horizontal polarization.
- p. The measure of the effective radiated power is the larger of the two levels recorded at the input to the substitution antenna, corrected for gain of the substitution antenna if necessary.
- q. The frequency range was checked up to 10^{th} harmonic.

6.5. Uncertainty

The measurement uncertainty is defined as 3.2 dB for Radiated Power Measurement.

6.6. Test Result

Conducted Spurious Measurement:

12V DC:

LTE Band 4 (QPSK, Band Width 5MHz, RB Size 1, RB Offset 0, Channel 19975, Frequency 1712.5MHz)

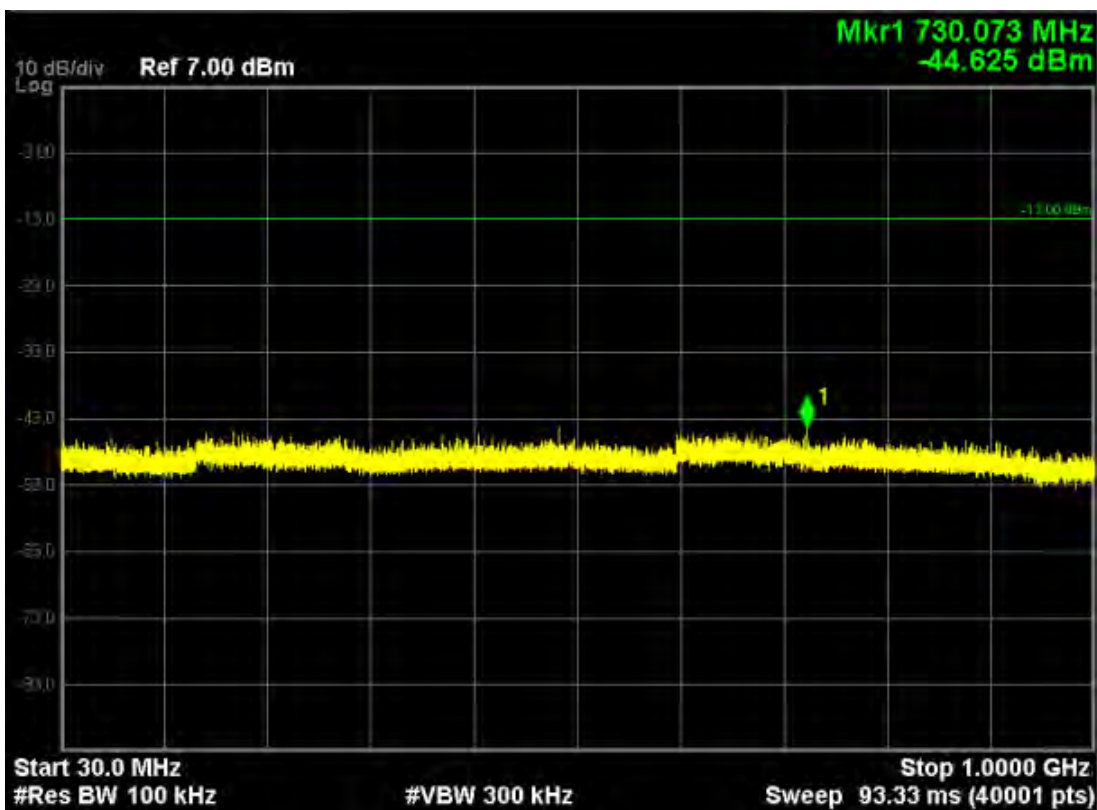
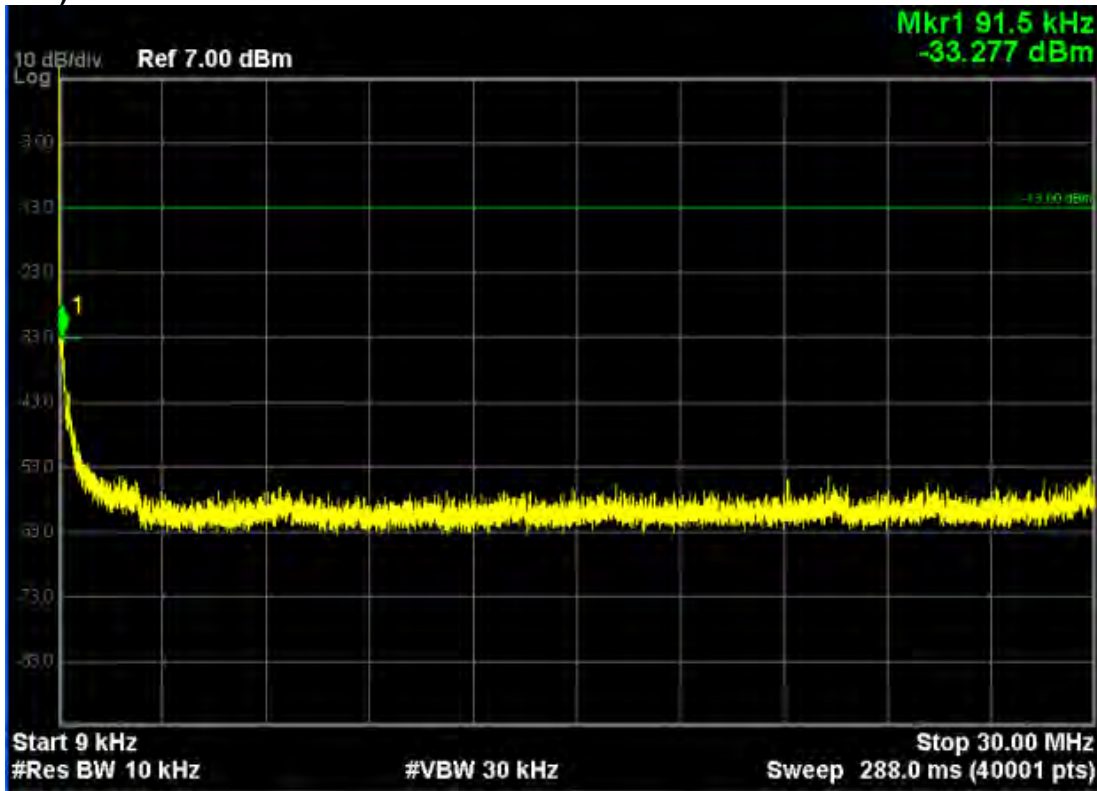

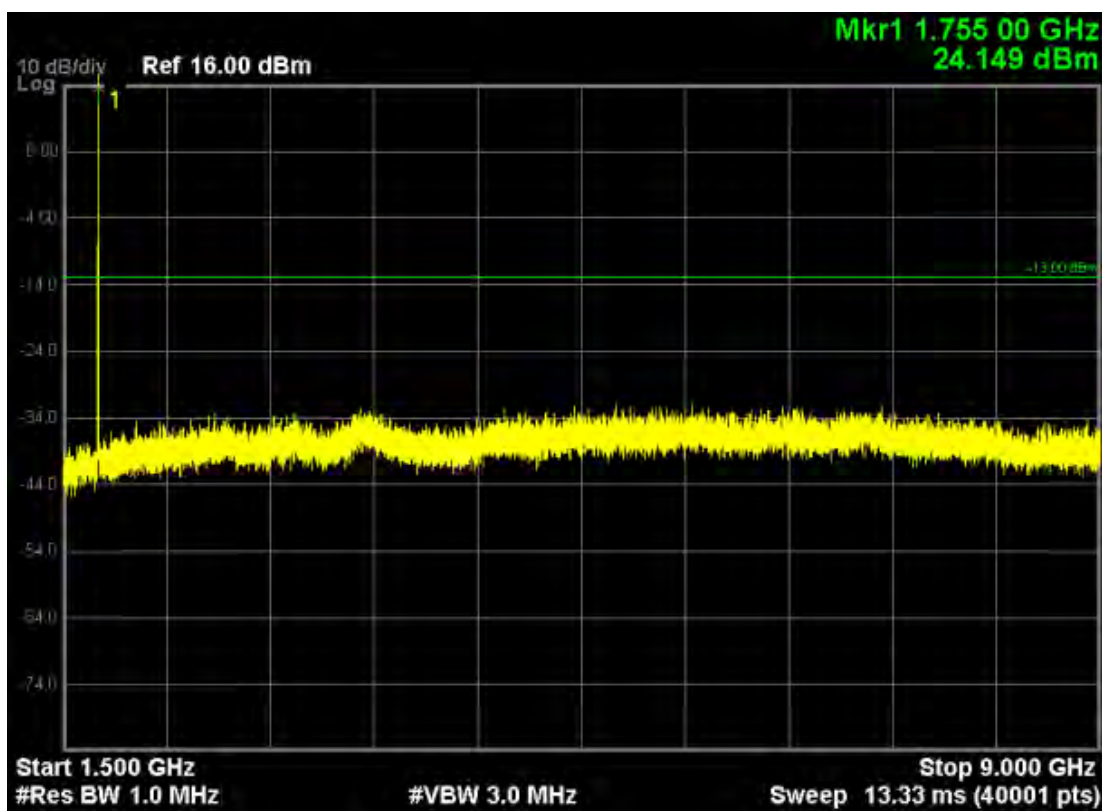
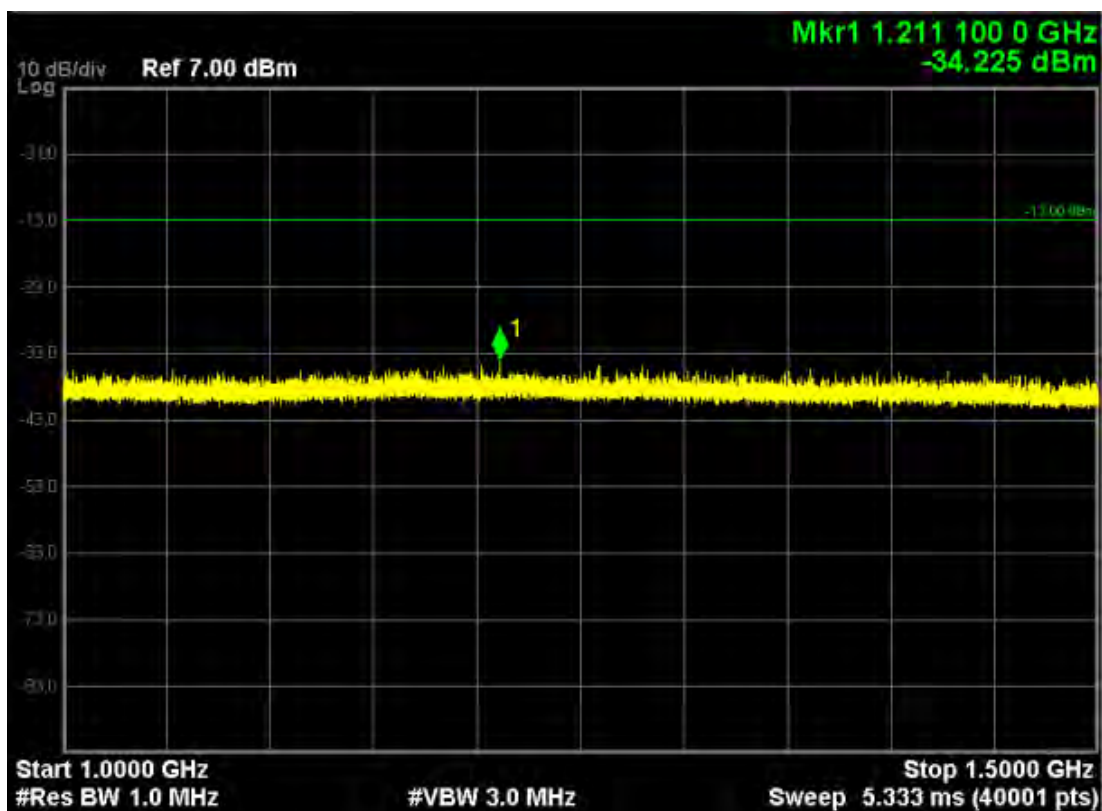

Note: The signal at point 1 is carrier

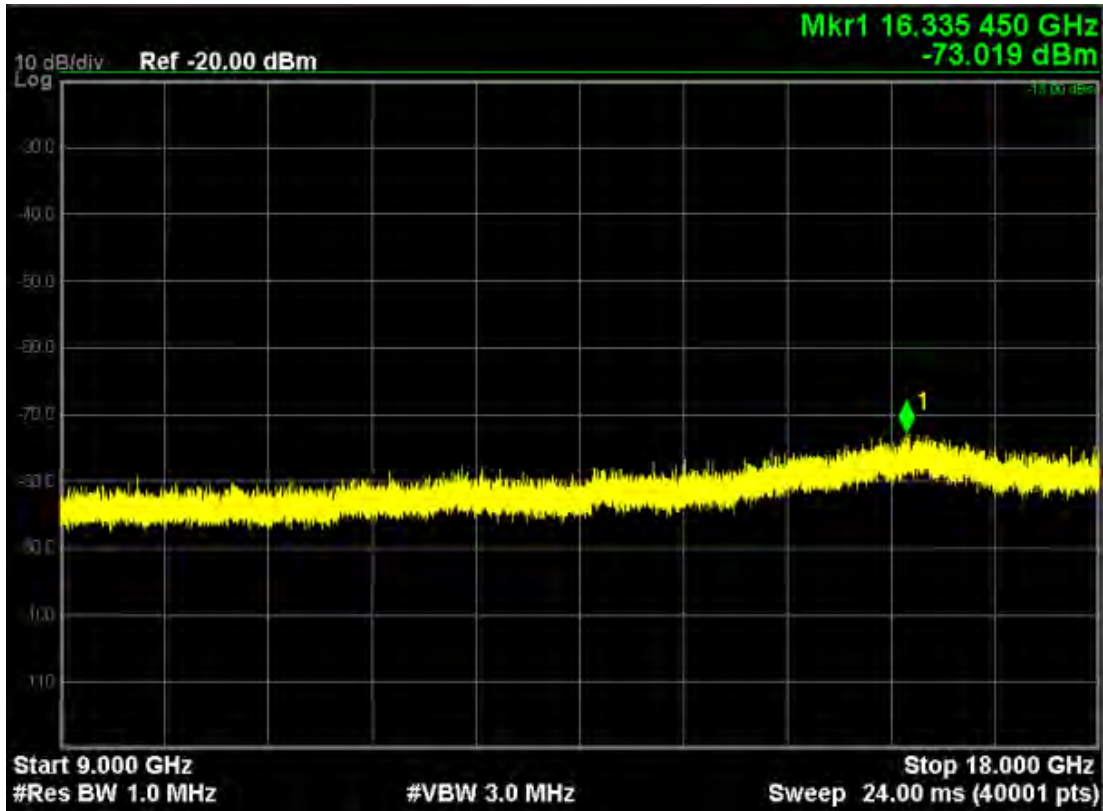

LTE Band 4 (16-QAM, Band Width 5MHz, RB Size 1, RB Offset 0, Channel 19975, Frequency 1712.5MHz)

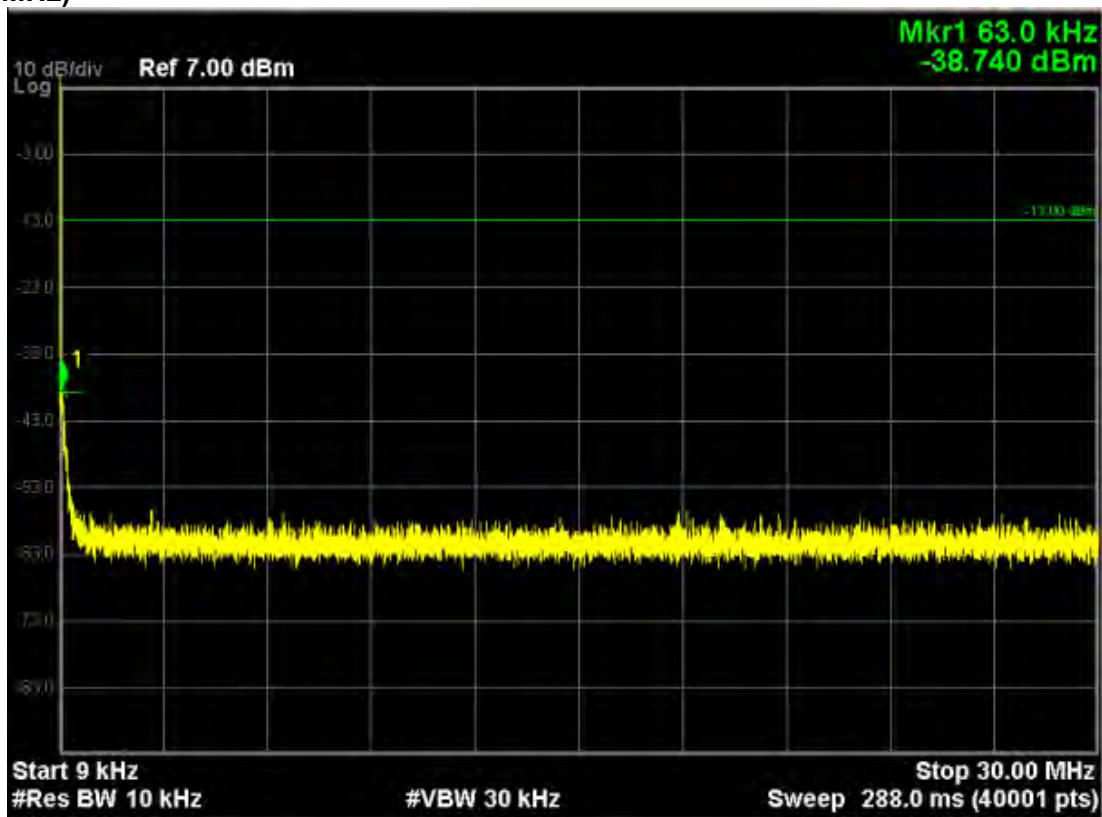

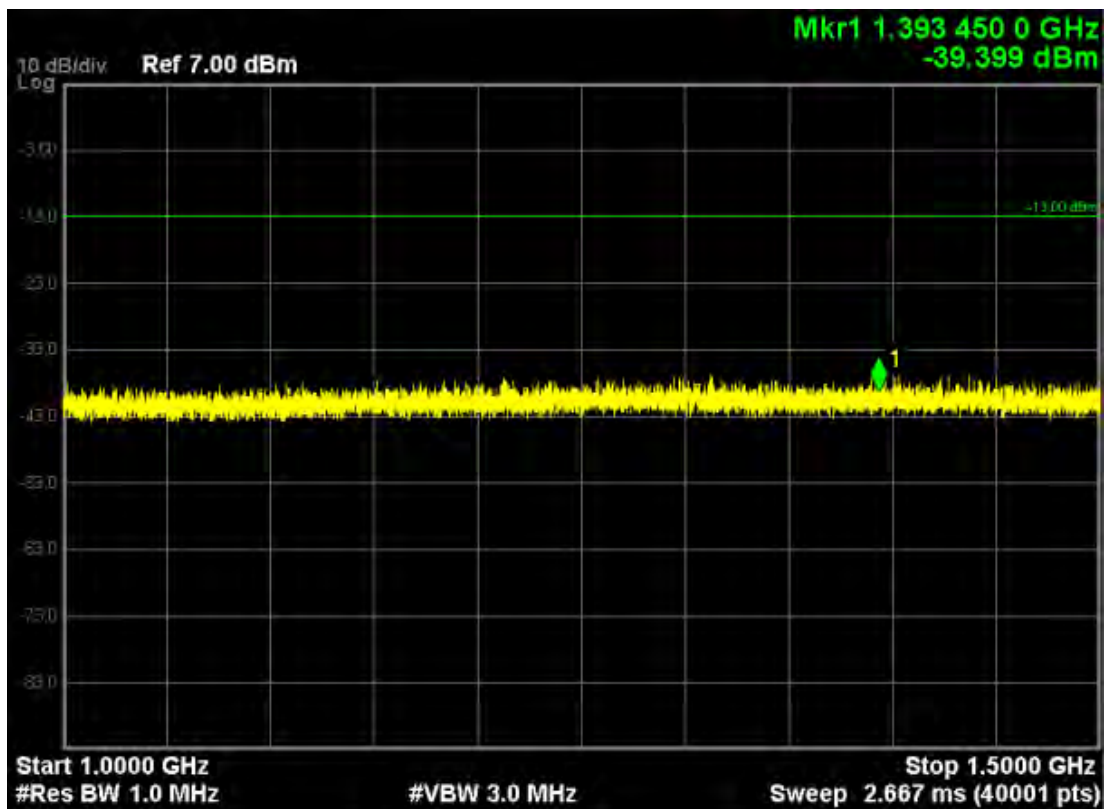
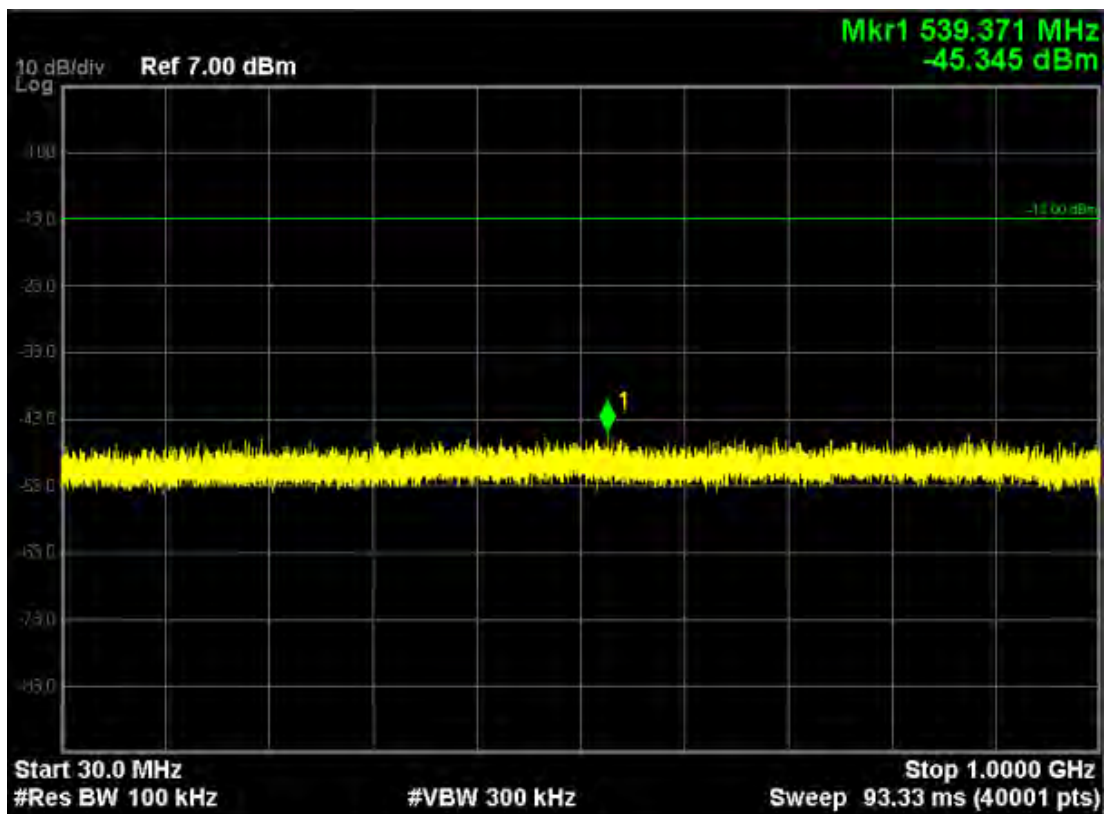



Note: The signal at point 1 is carrier

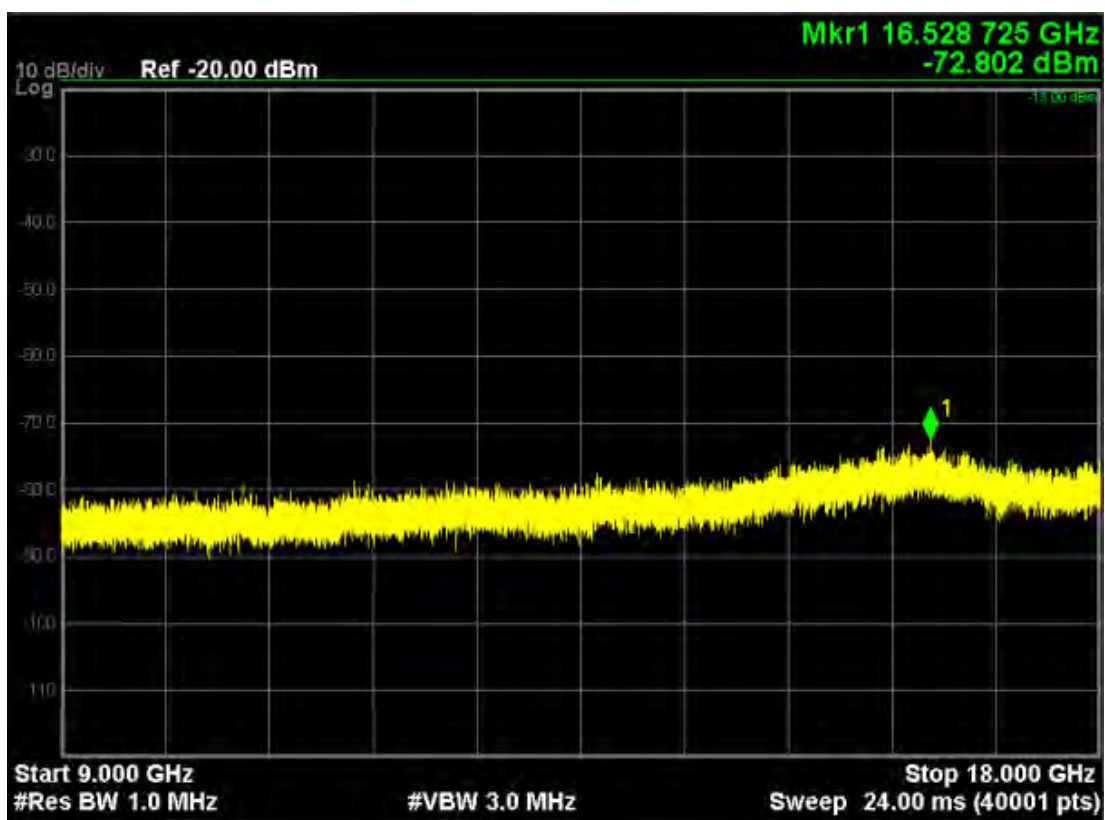

LTE Band 4 (QPSK, Band Width 10MHz, RB Size 1, RB Offset 49, Channel 20350, Frequency 1750.0MHz)

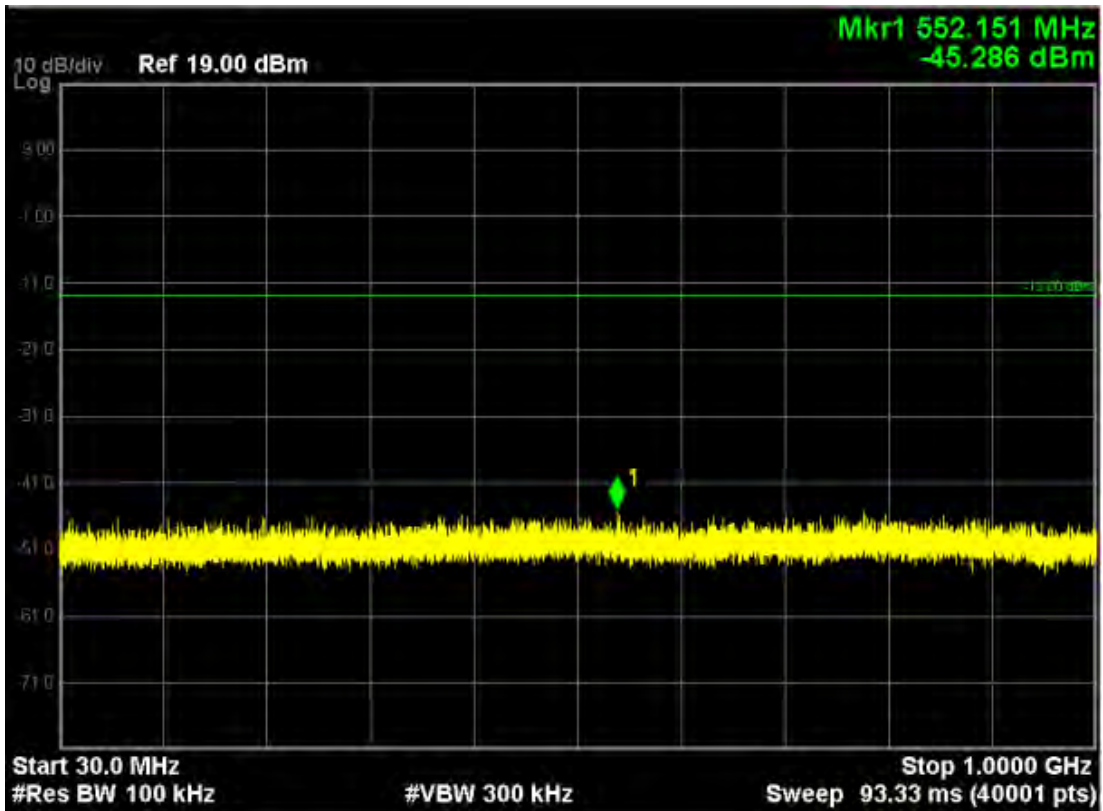
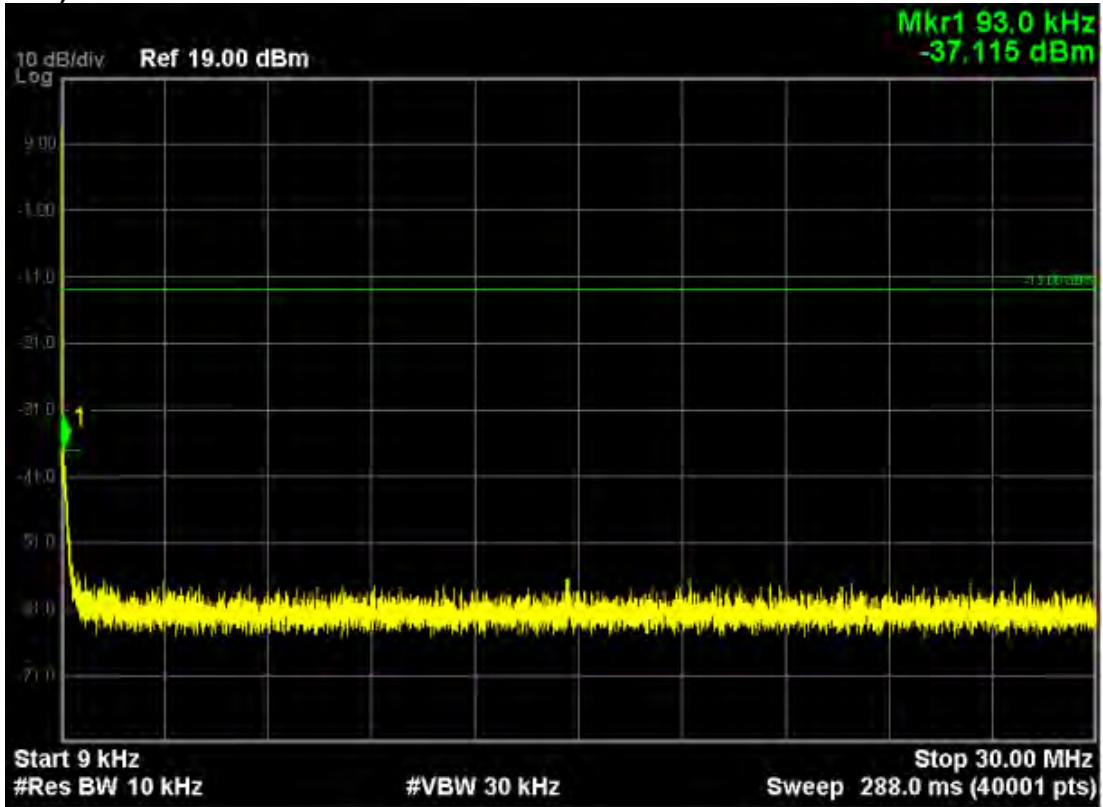

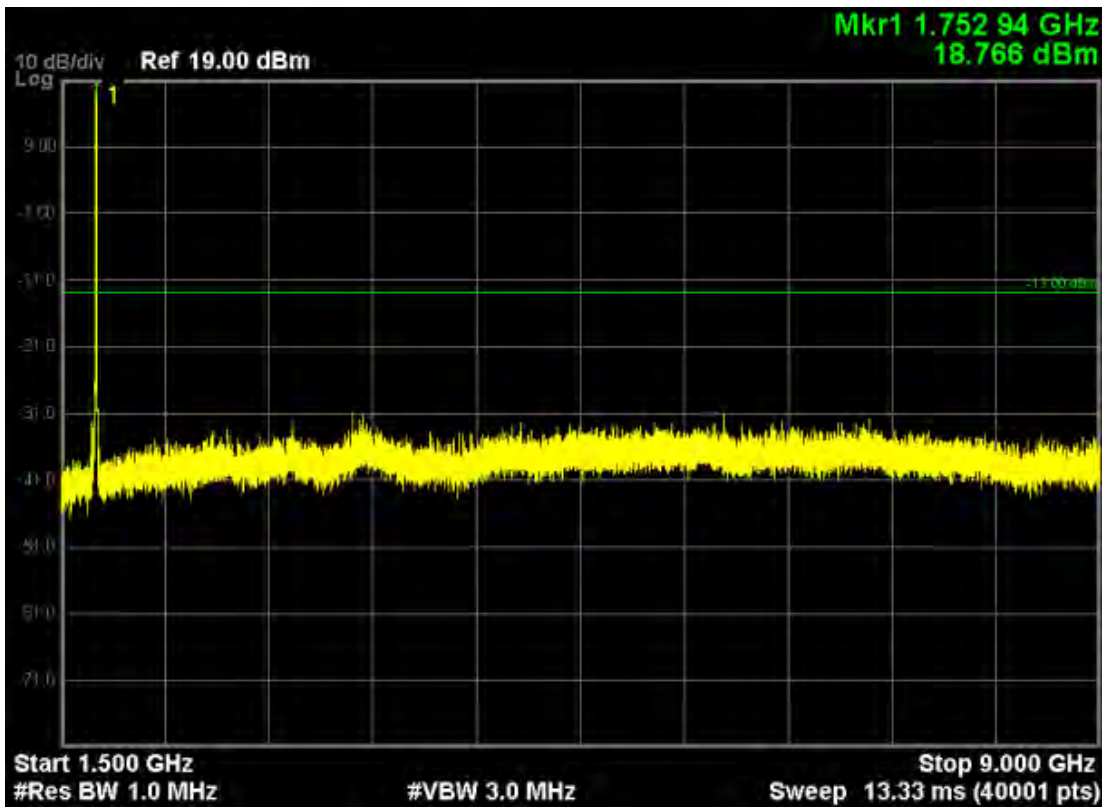
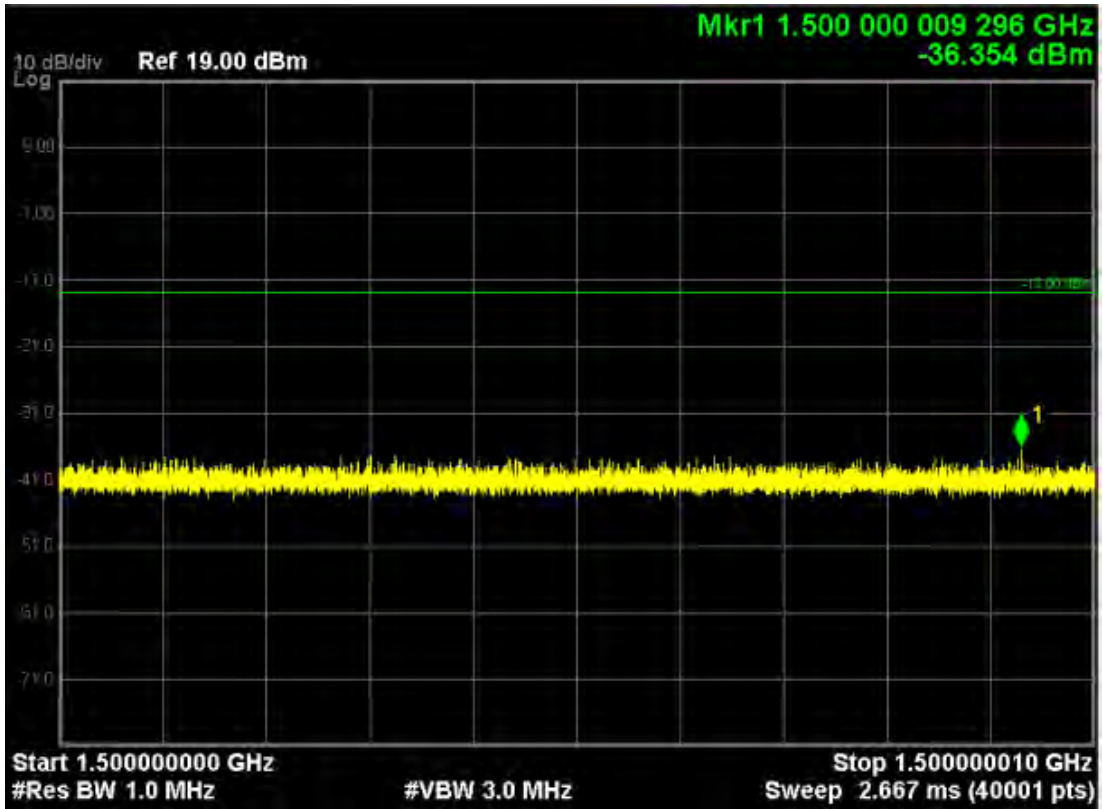

Note: The signal at point 1 is carrier

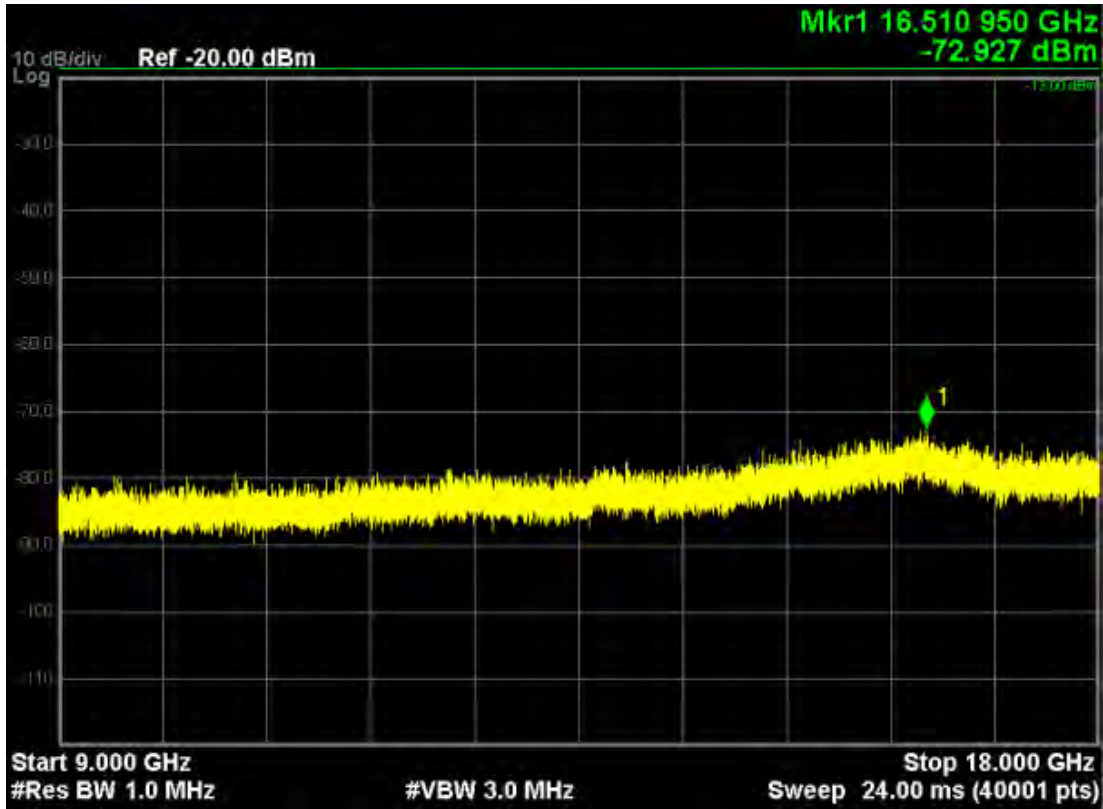

LTE Band 4 (16-QAM, Band Width 10MHz, RB Size 1, RB Offset 0, Channel 20000, Frequency 1715.0MHz)

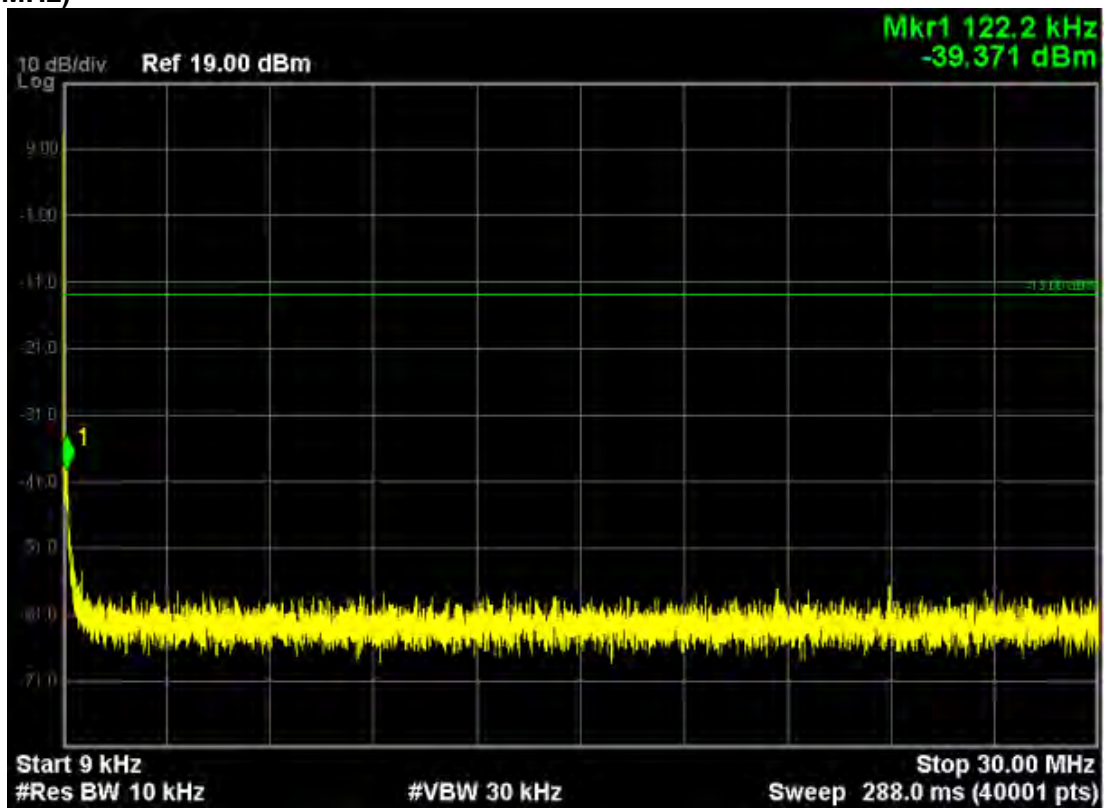

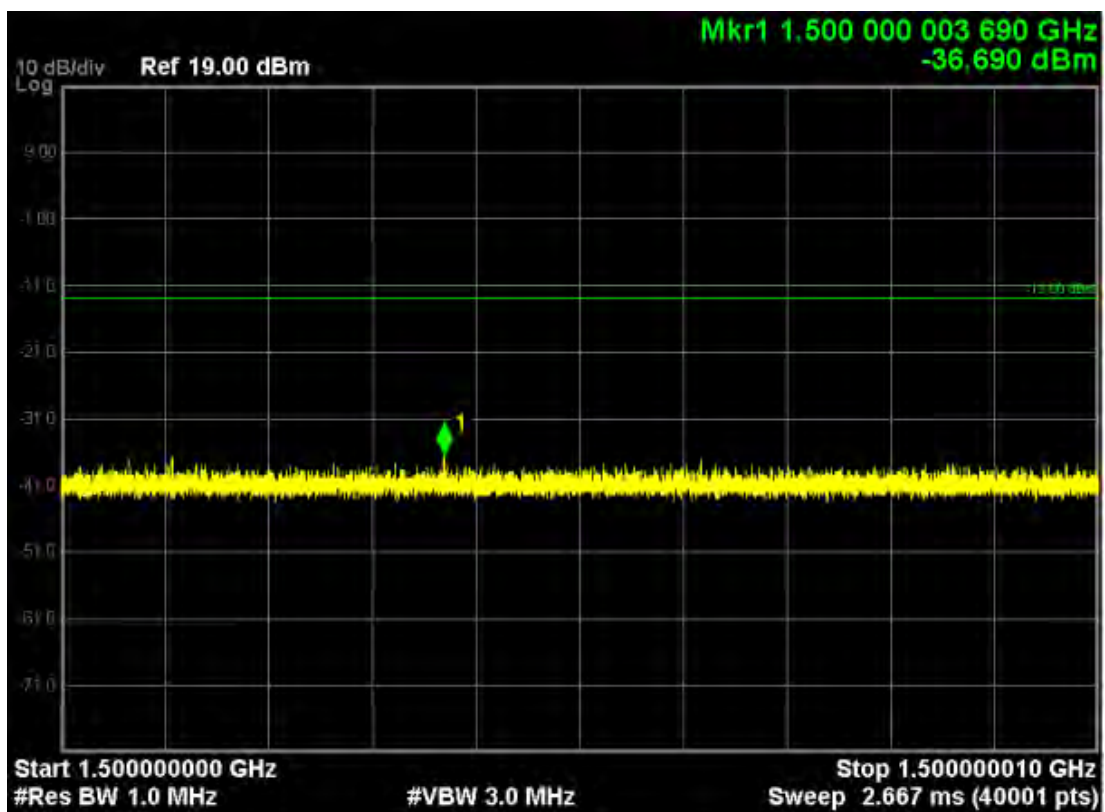
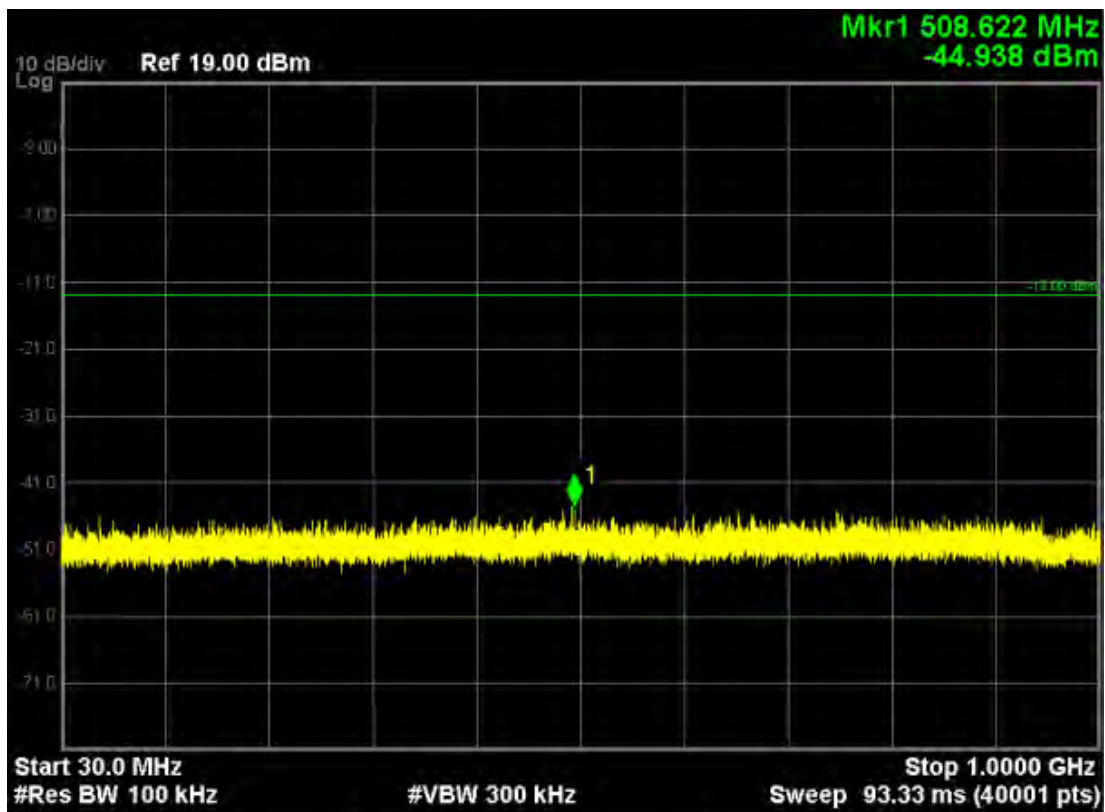

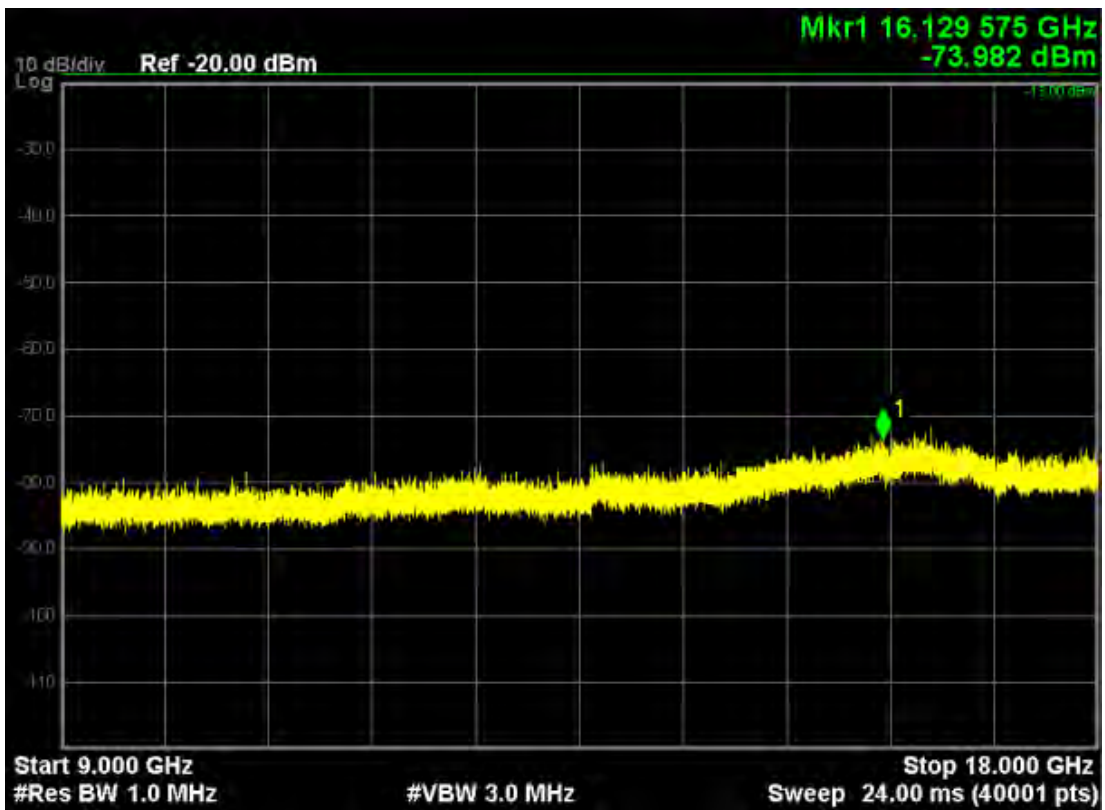
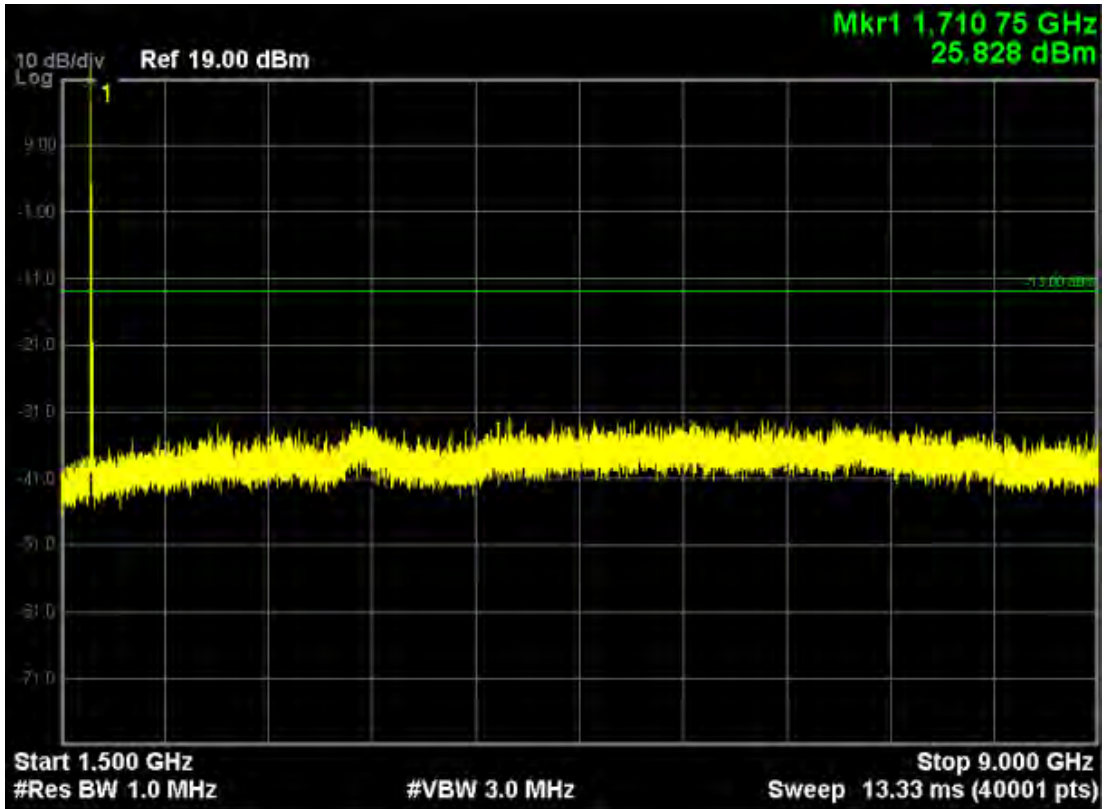

LTE Band 13 (QPSK, Band Width 5MHz, RB Size 1, RB Offset 0, Channel 23230, Frequency 782.0MHz)

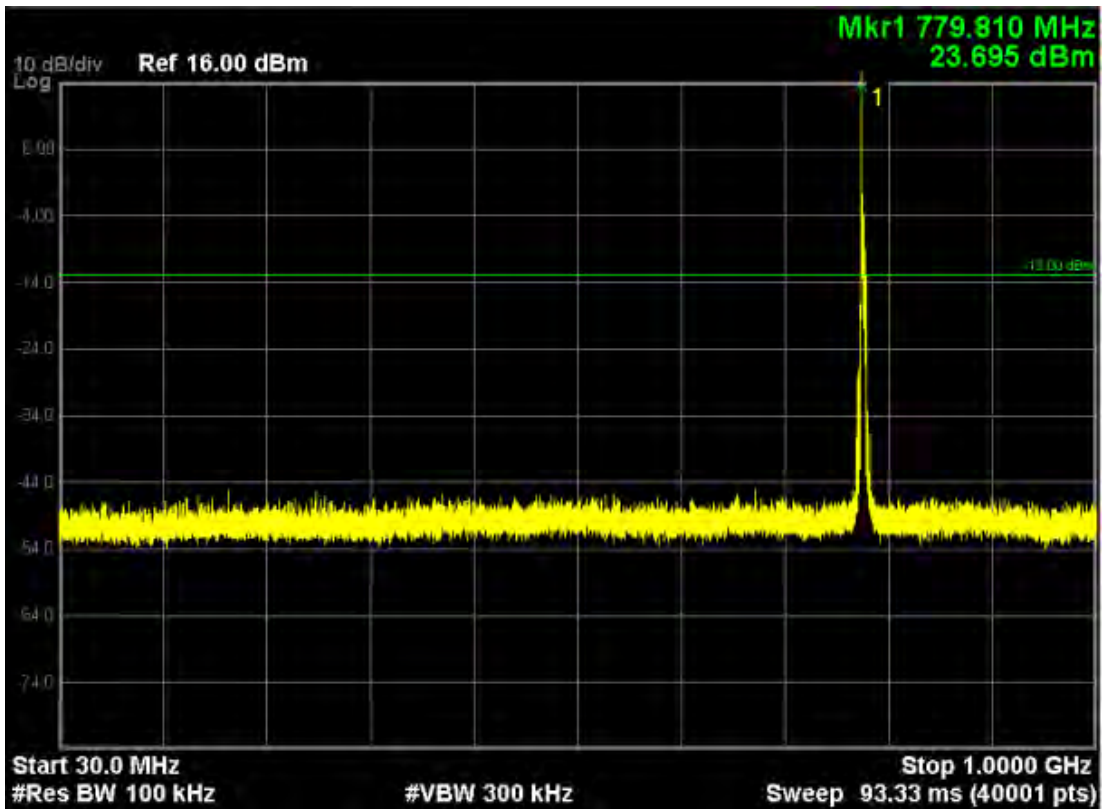
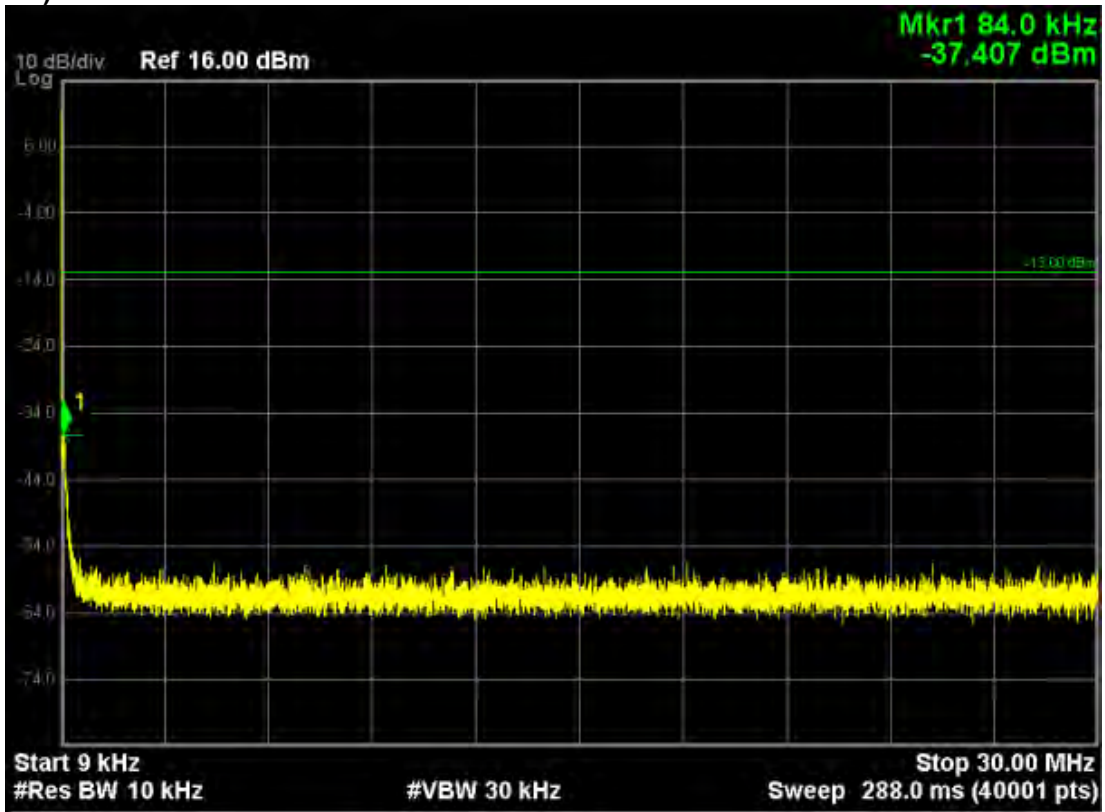

Note: The signal at point 1 is carrier

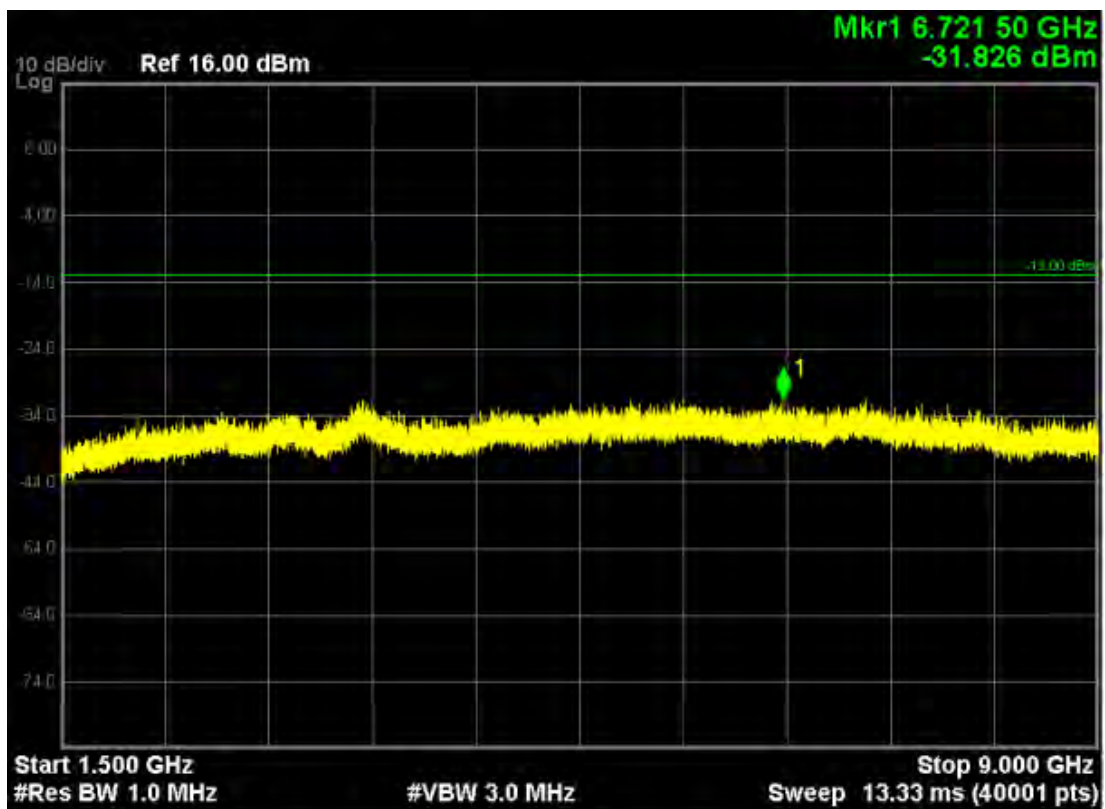
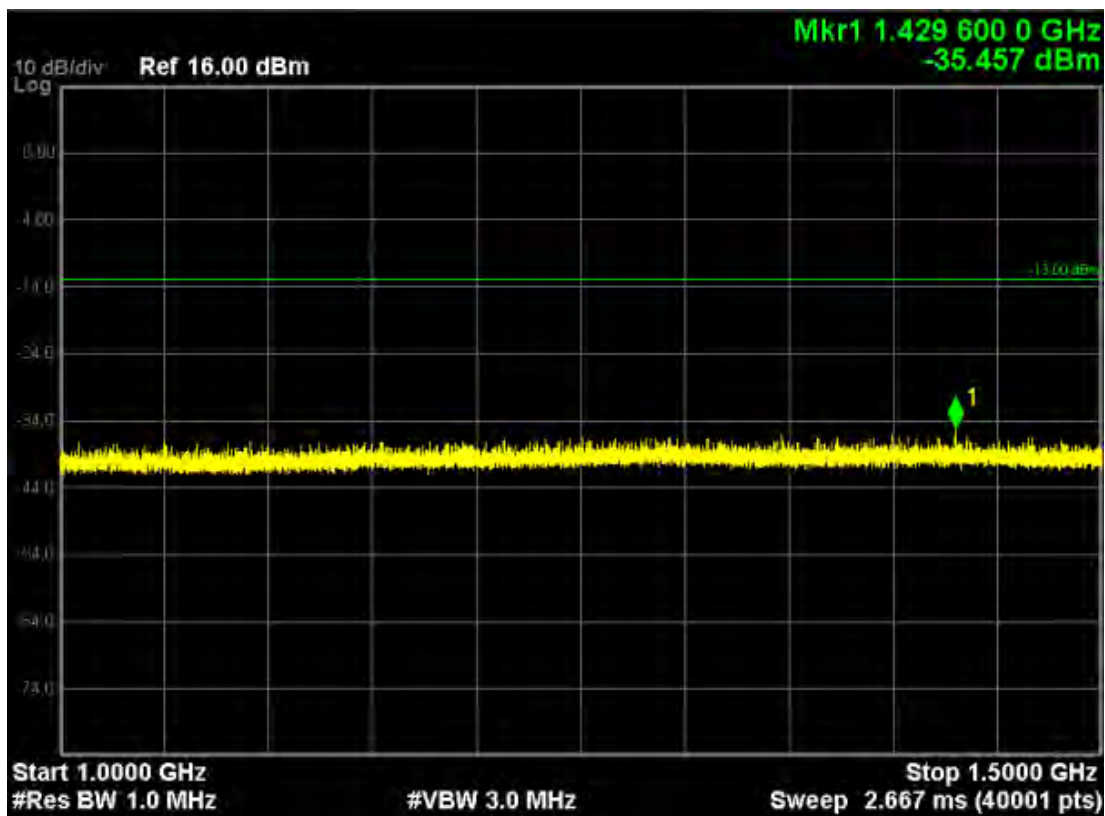

LTE Band 13 (16-QAM, Band Width 5MHz, RB Size 1, RB Offset 0, Channel 23205, Frequency 779.5MHz)

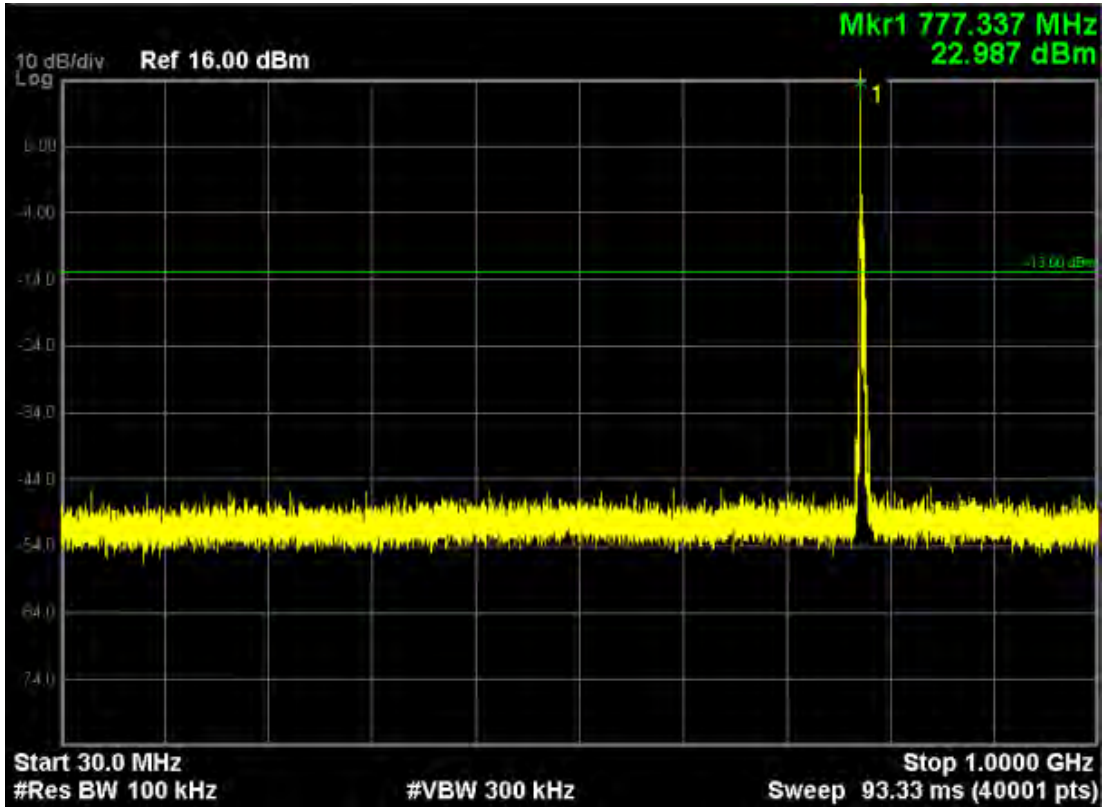
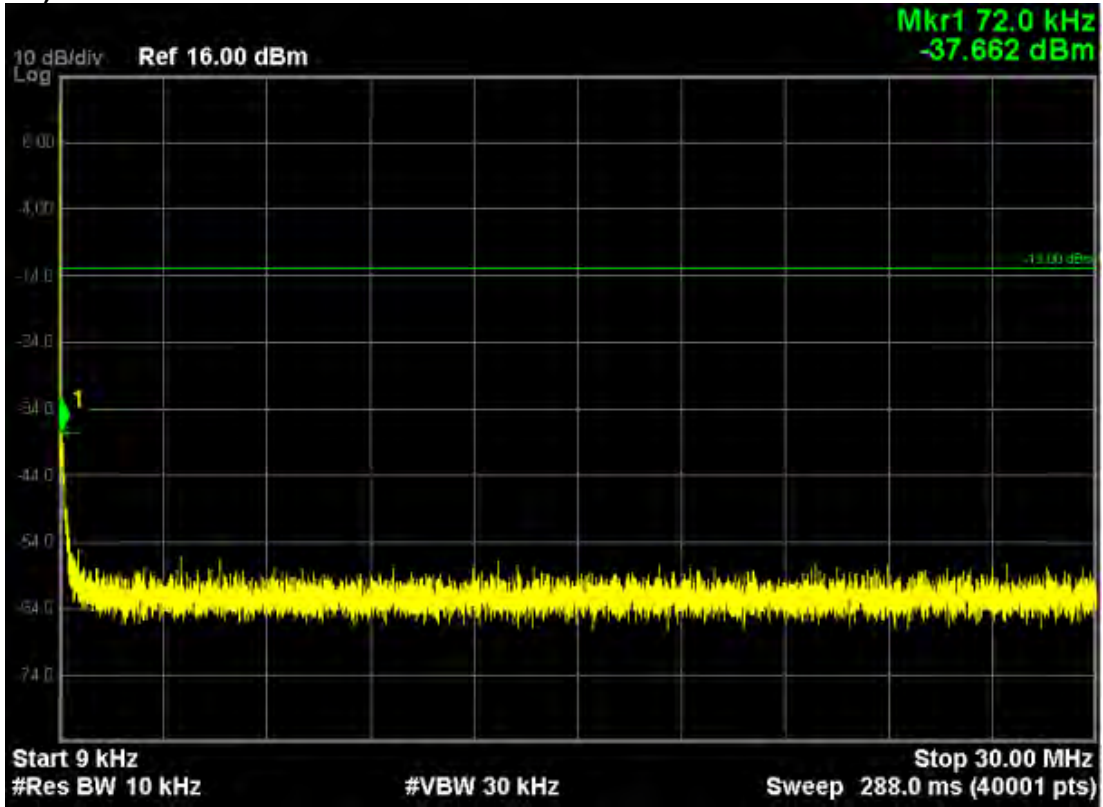

Note: The signal at point 1 is carrier

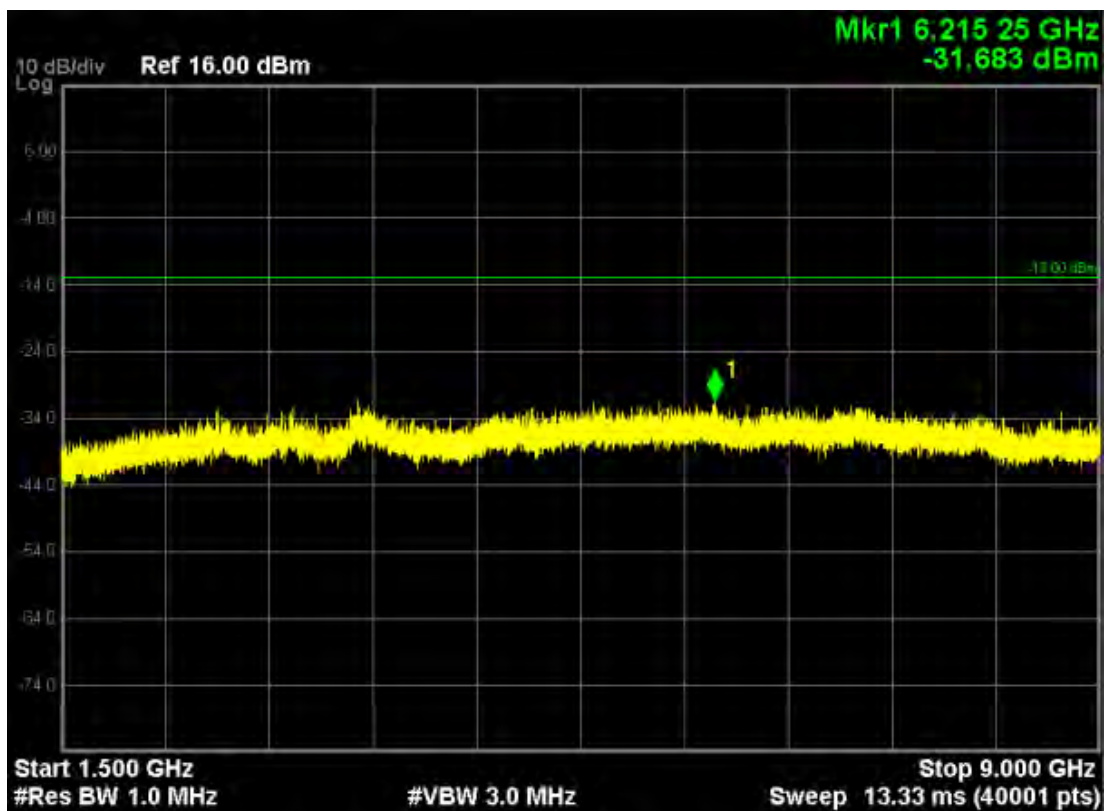
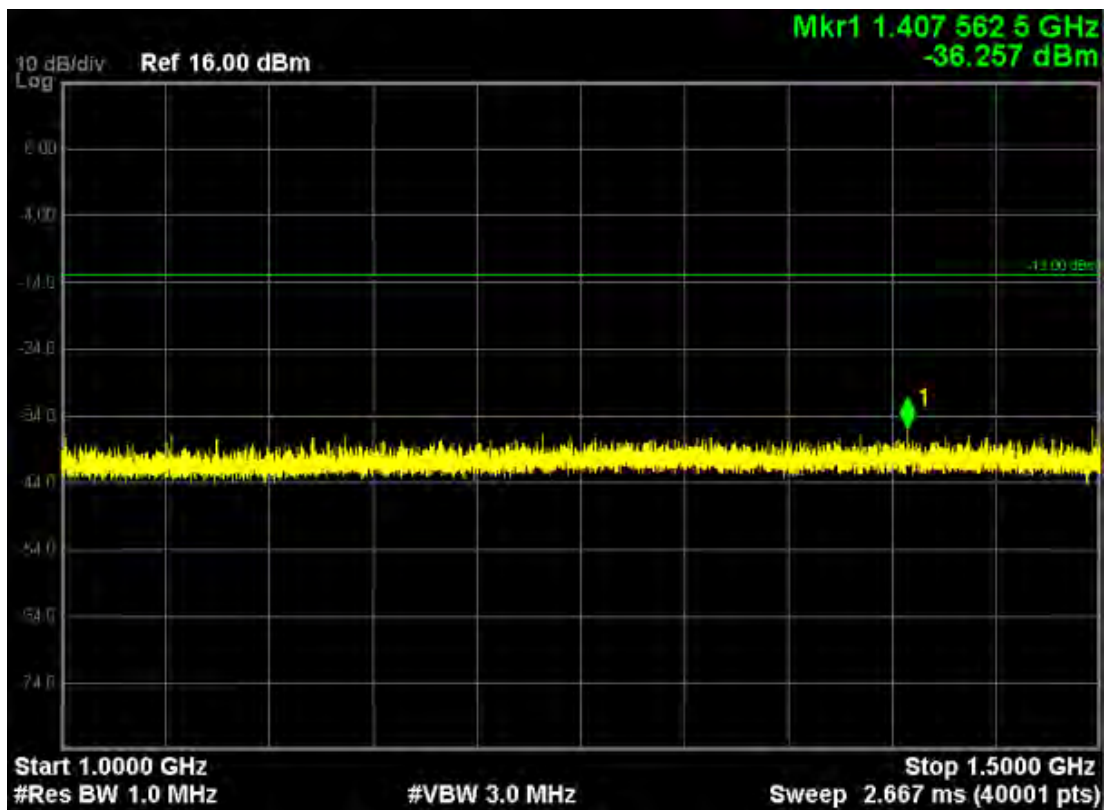

LTE Band 13 (QPSK, Band Width 10MHz, RB Size 1, RB Offset 0, Channel 23230, Frequency 782.0MHz)

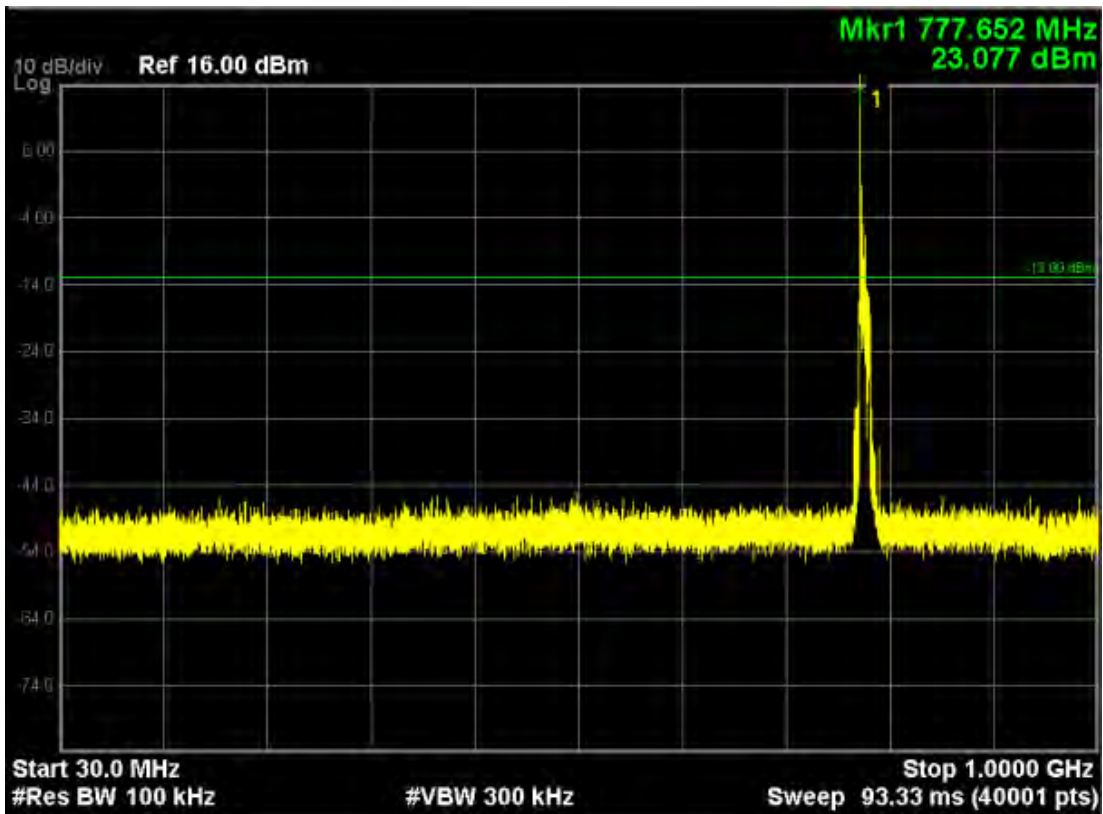
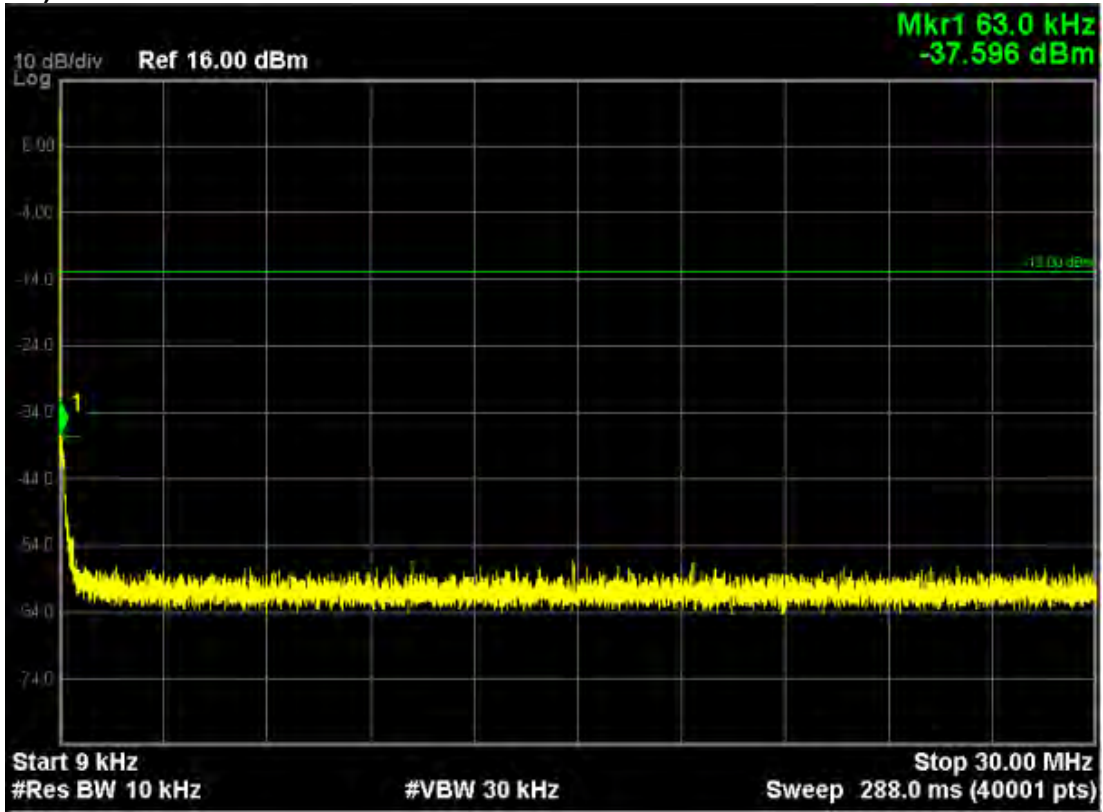

Note: The signal at point 1 is carrier

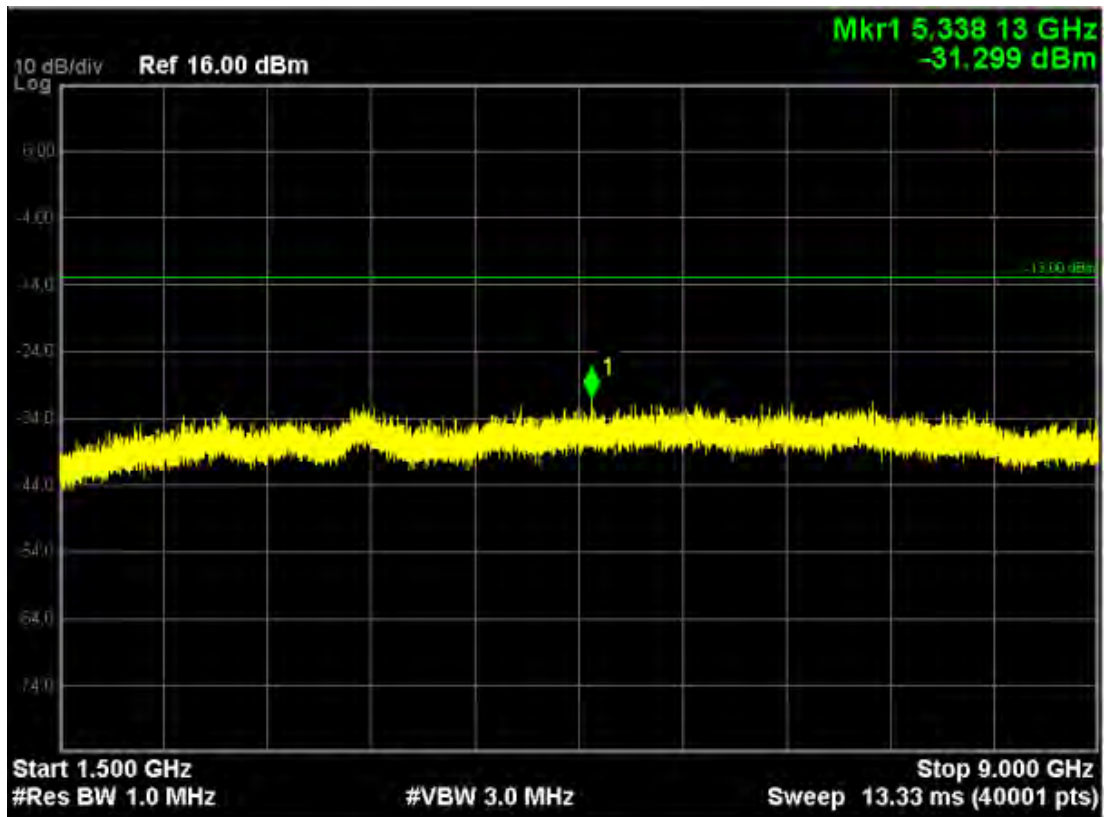
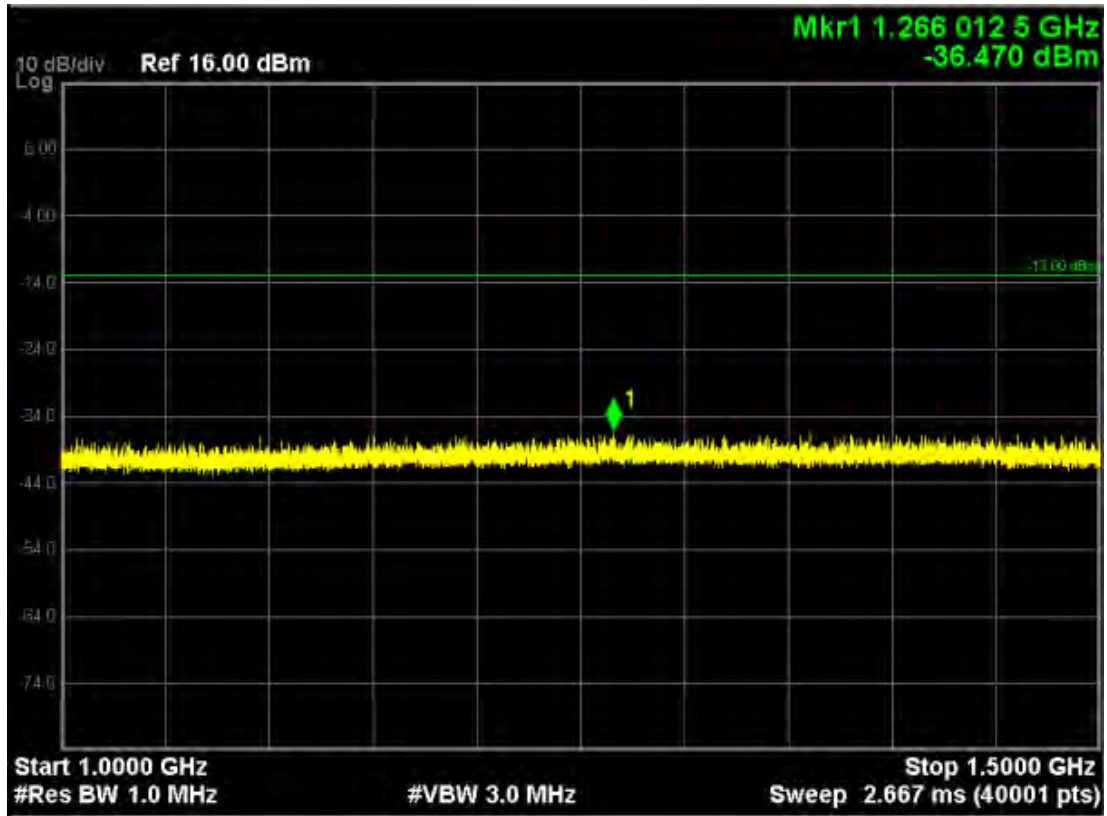

LTE Band 13 (16-QAM, Band Width 10MHz, RB Size 1, RB Offset 0, Channel 23230, Frequency 782.0MHz)

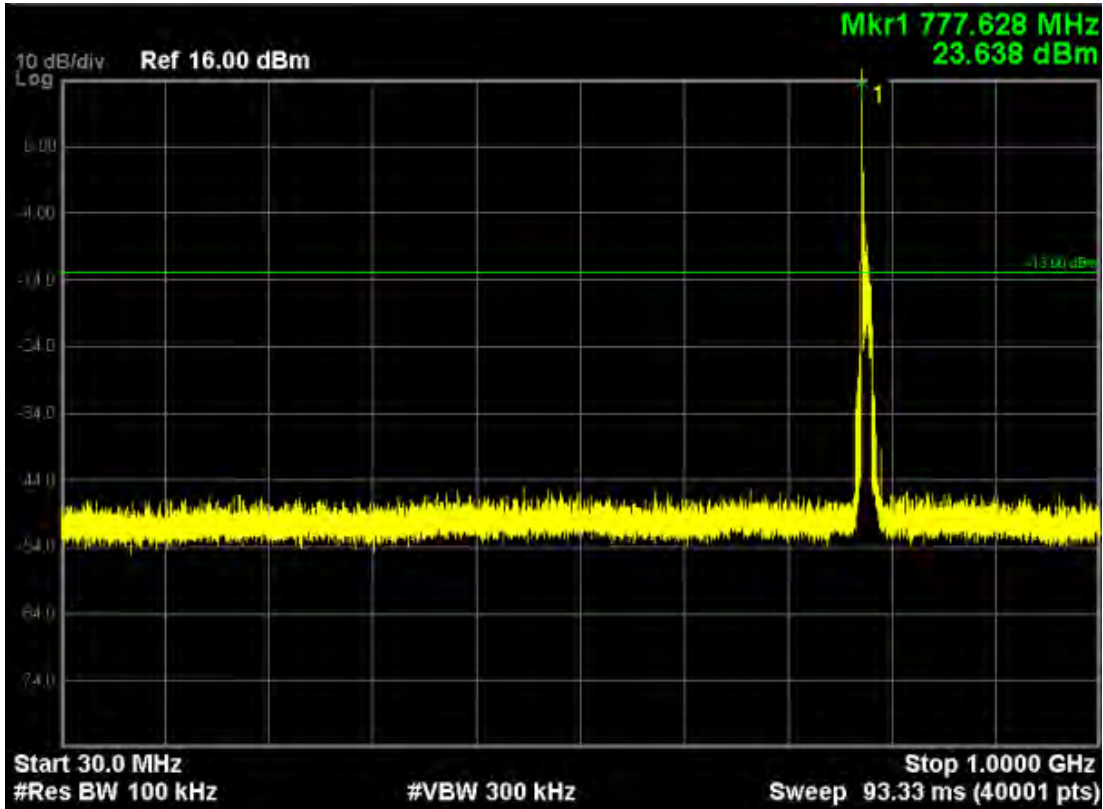
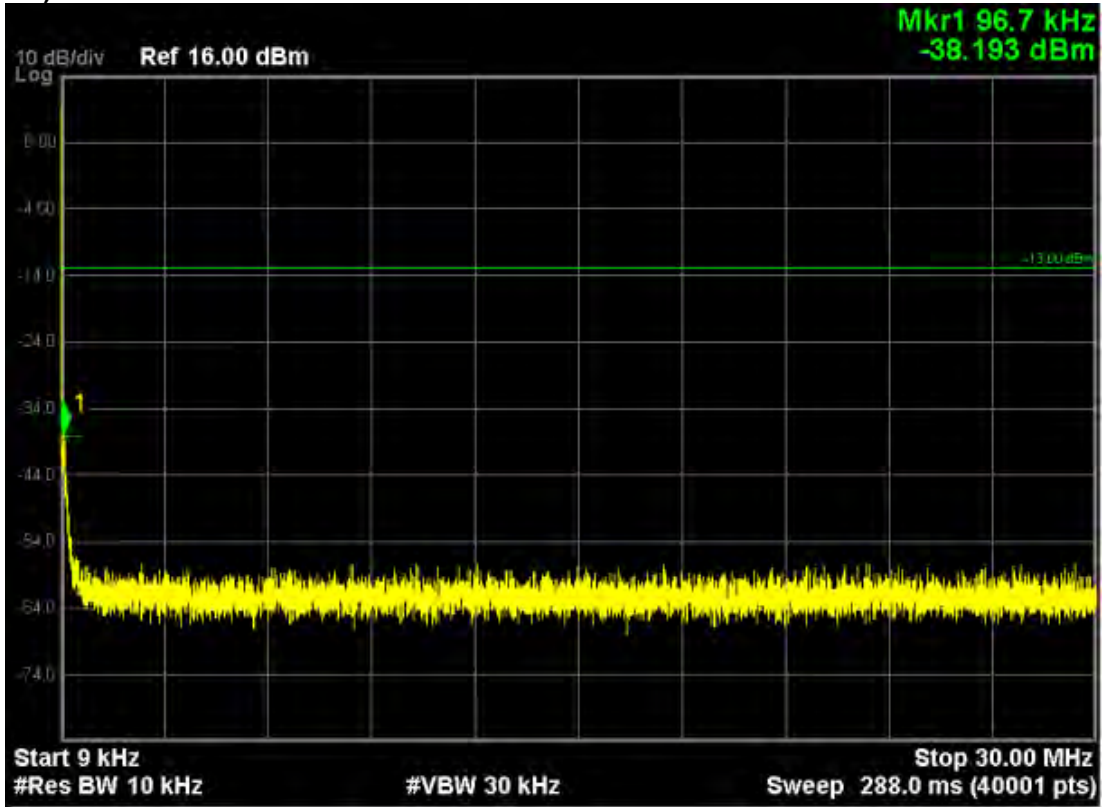

Note: The signal at point 1 is carrier

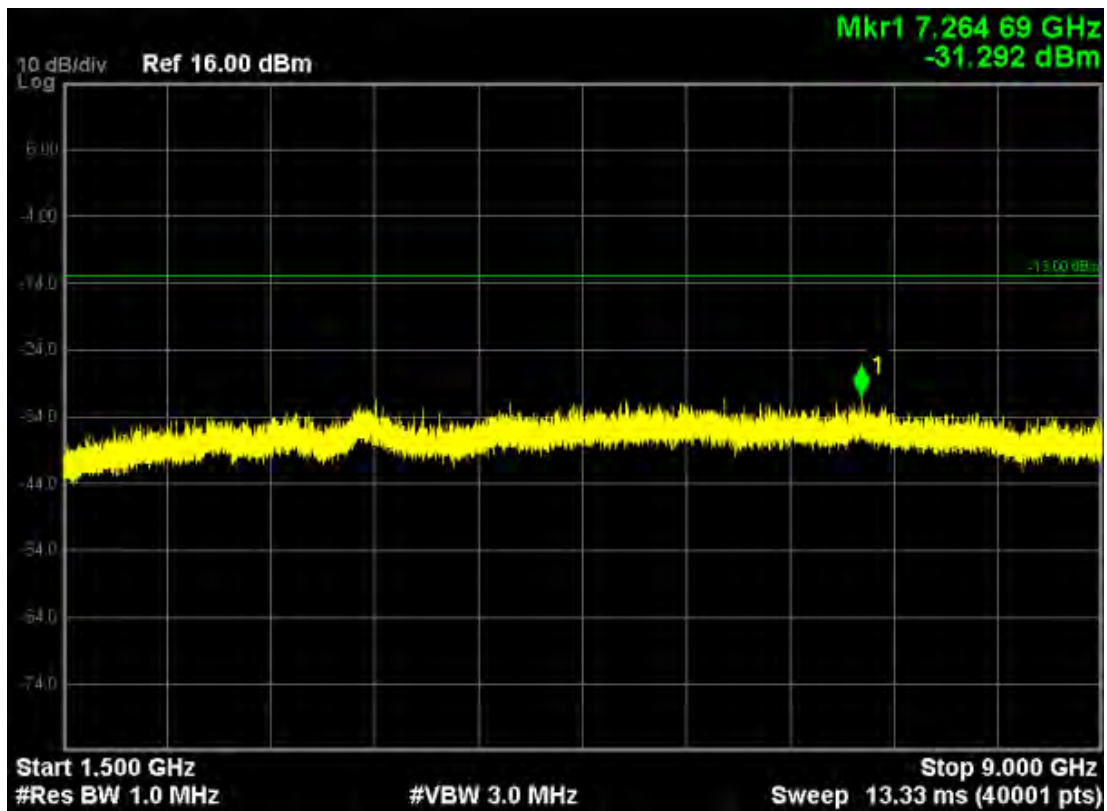
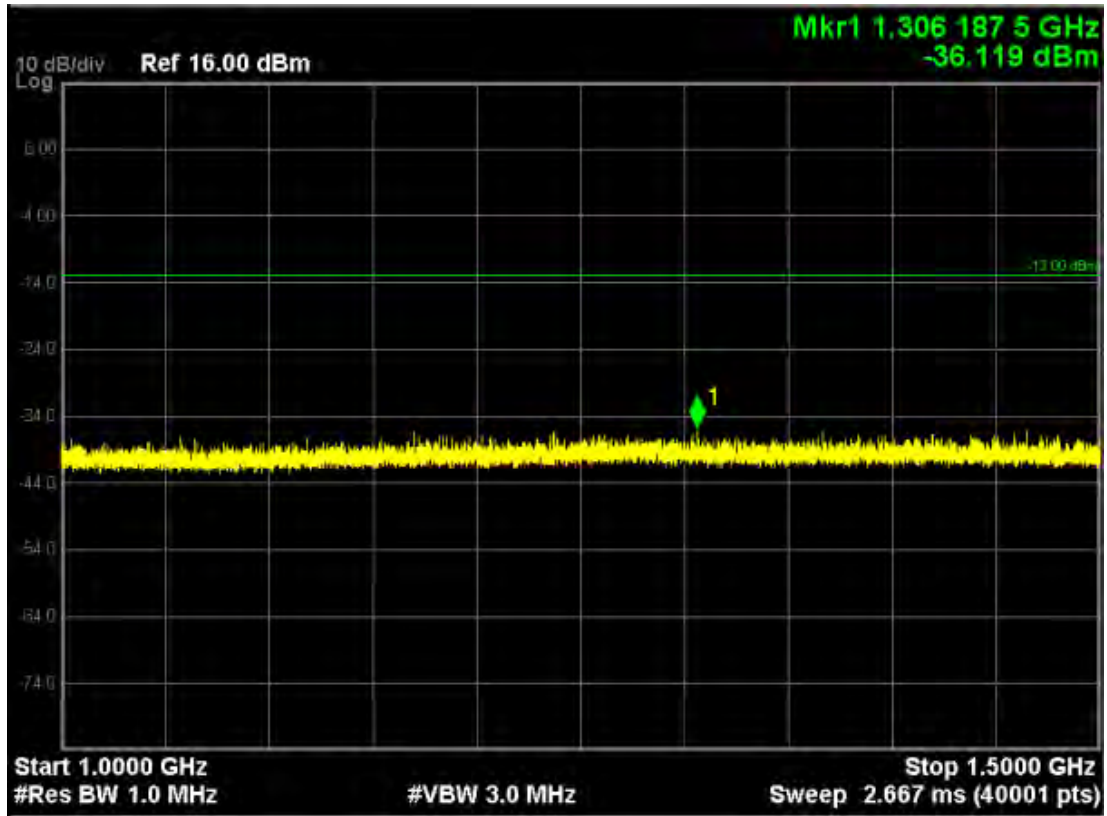

24V DC:

LTE Band 4 (QPSK, Band Width 5MHz, RB Size 1, RB Offset 24, Channel 20375, Frequency 1752.5MHz)

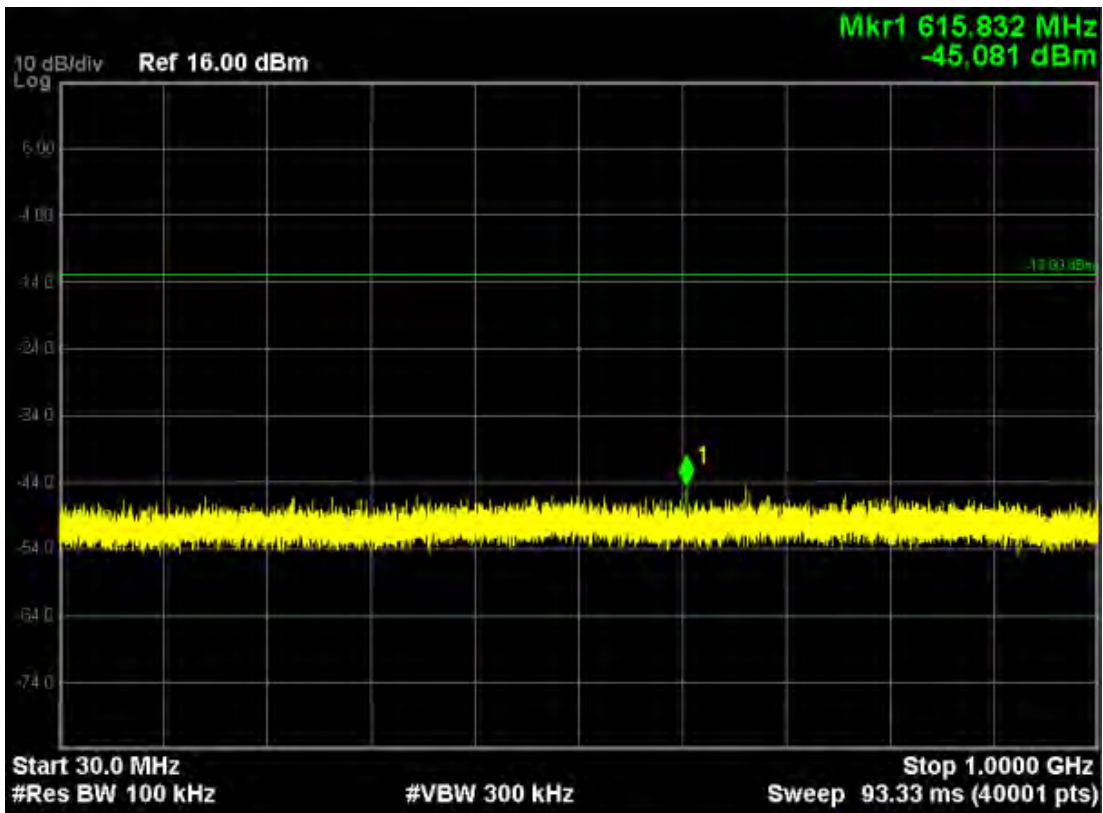
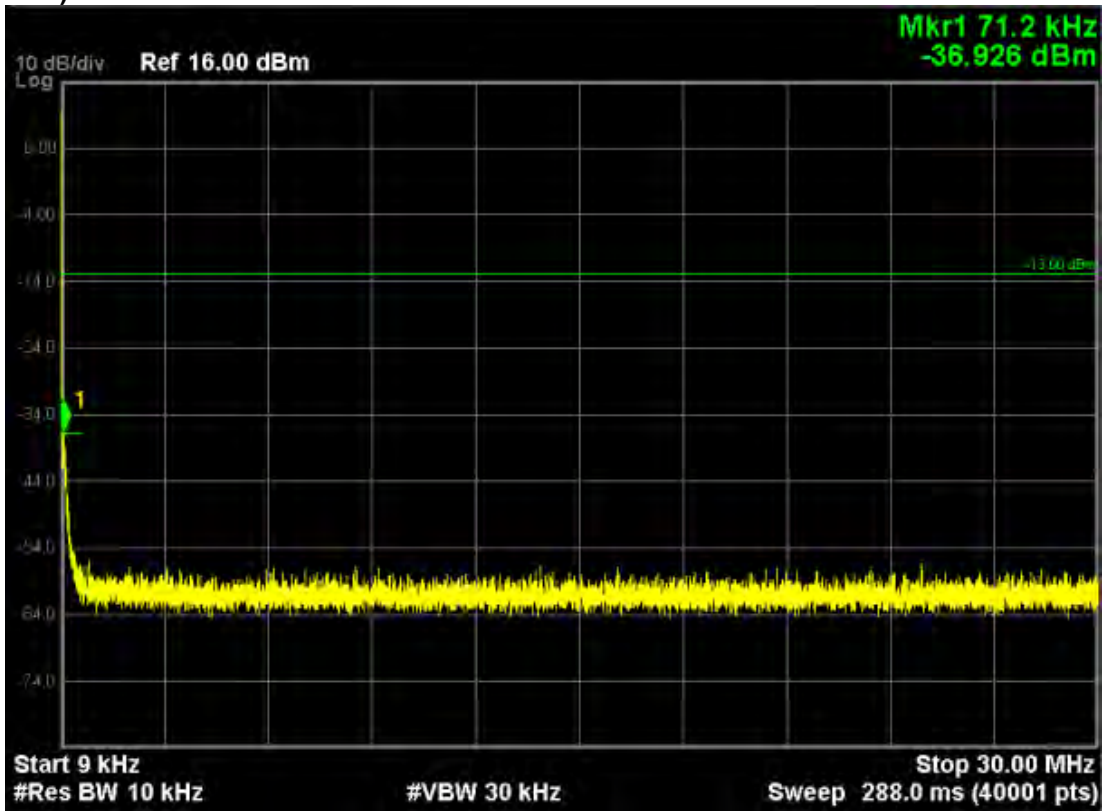

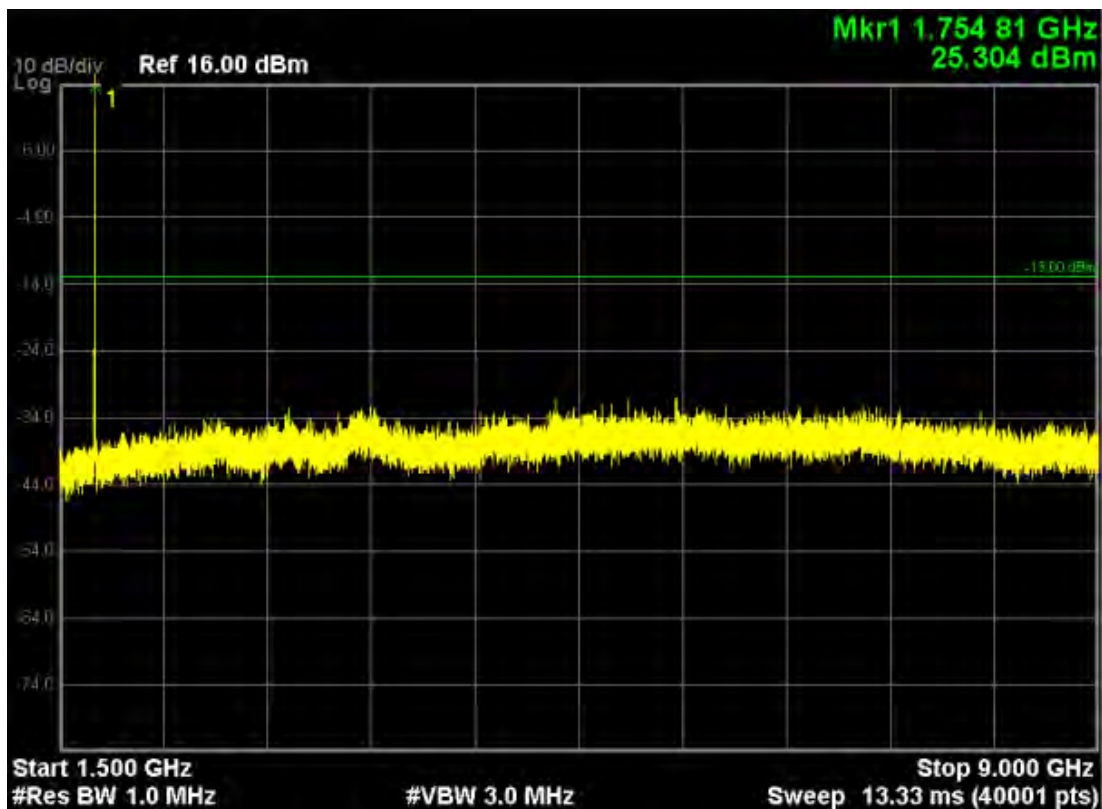
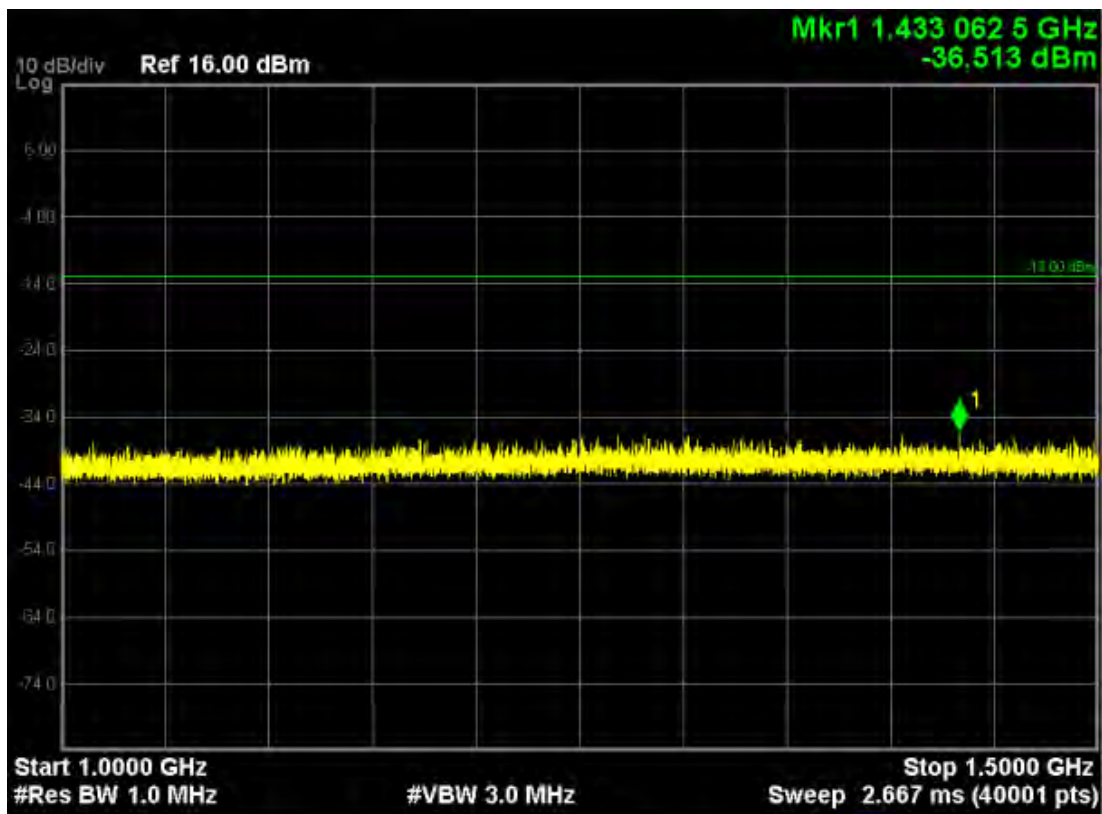

Note: The signal at point 1 is carrier

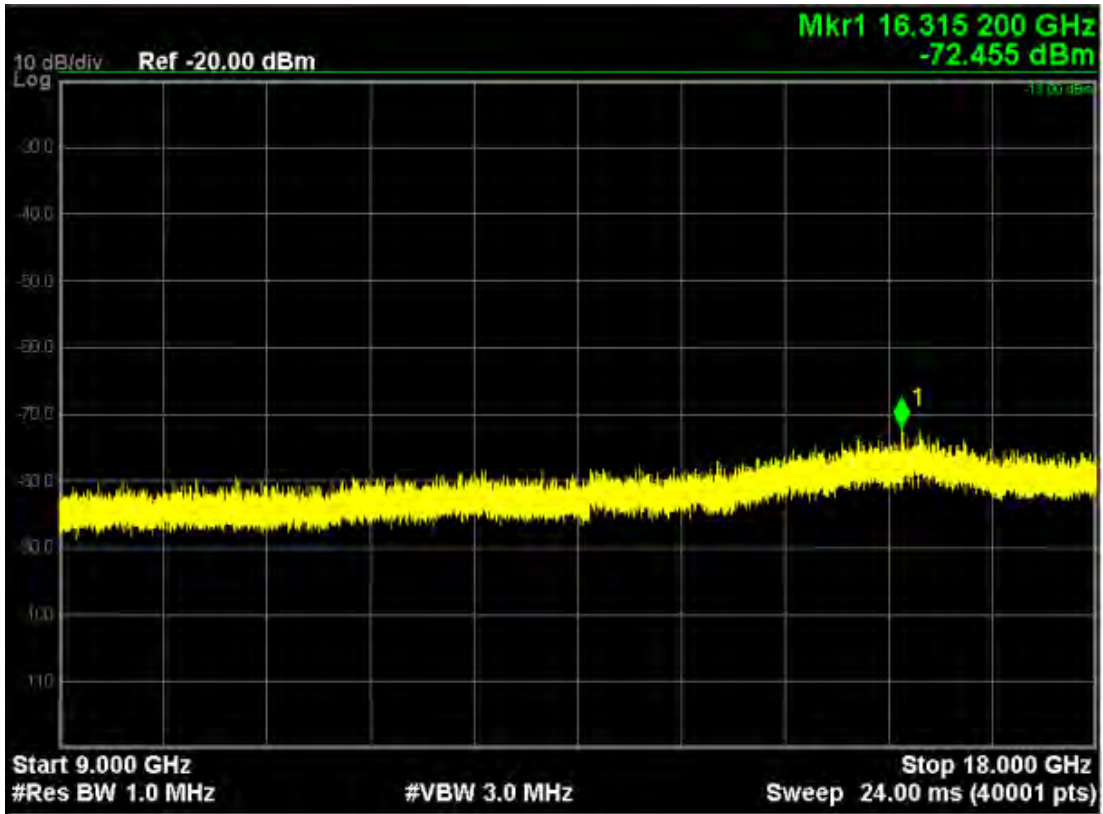

LTE Band 4 (16-QAM, Band Width 5MHz, RB Size 1, RB Offset 24, Channel 20375, Frequency 1752.5MHz)

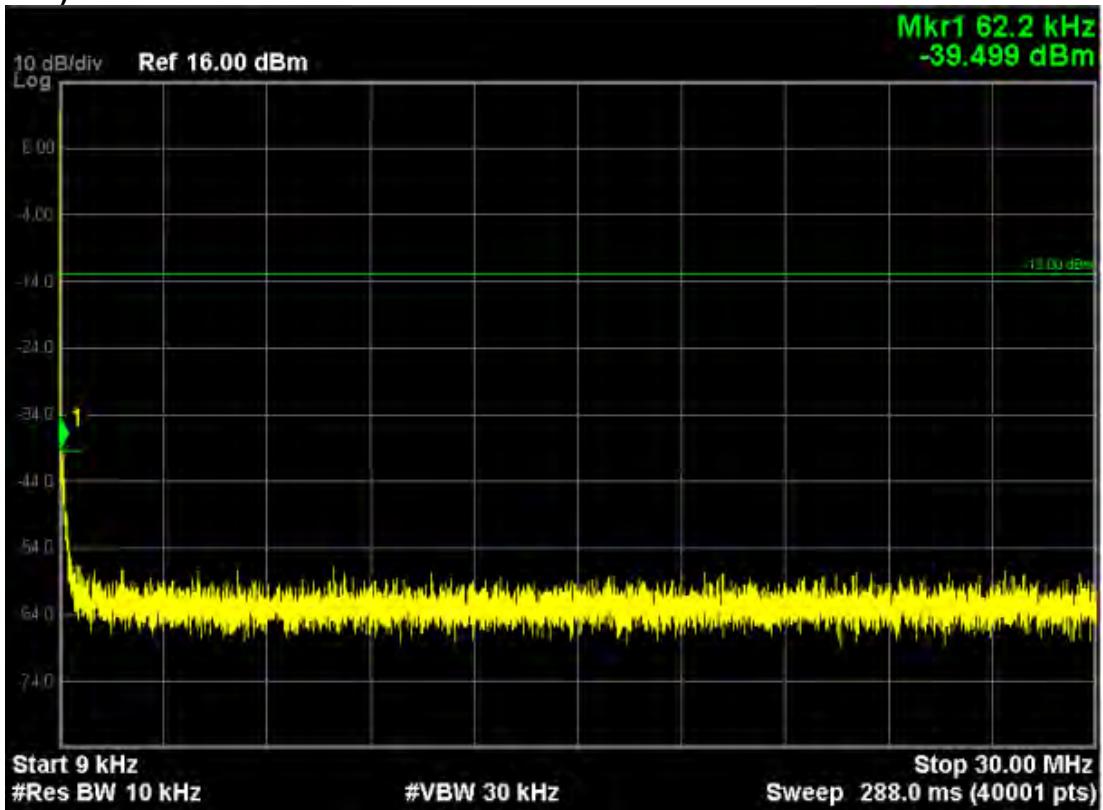

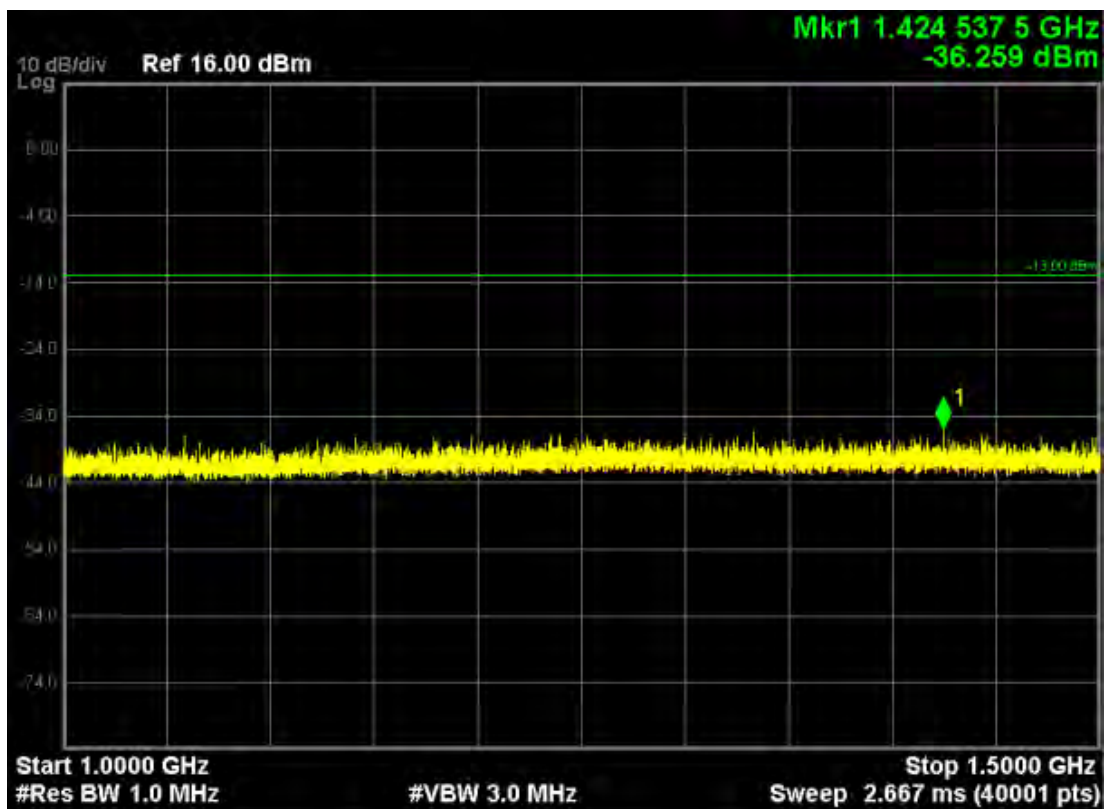
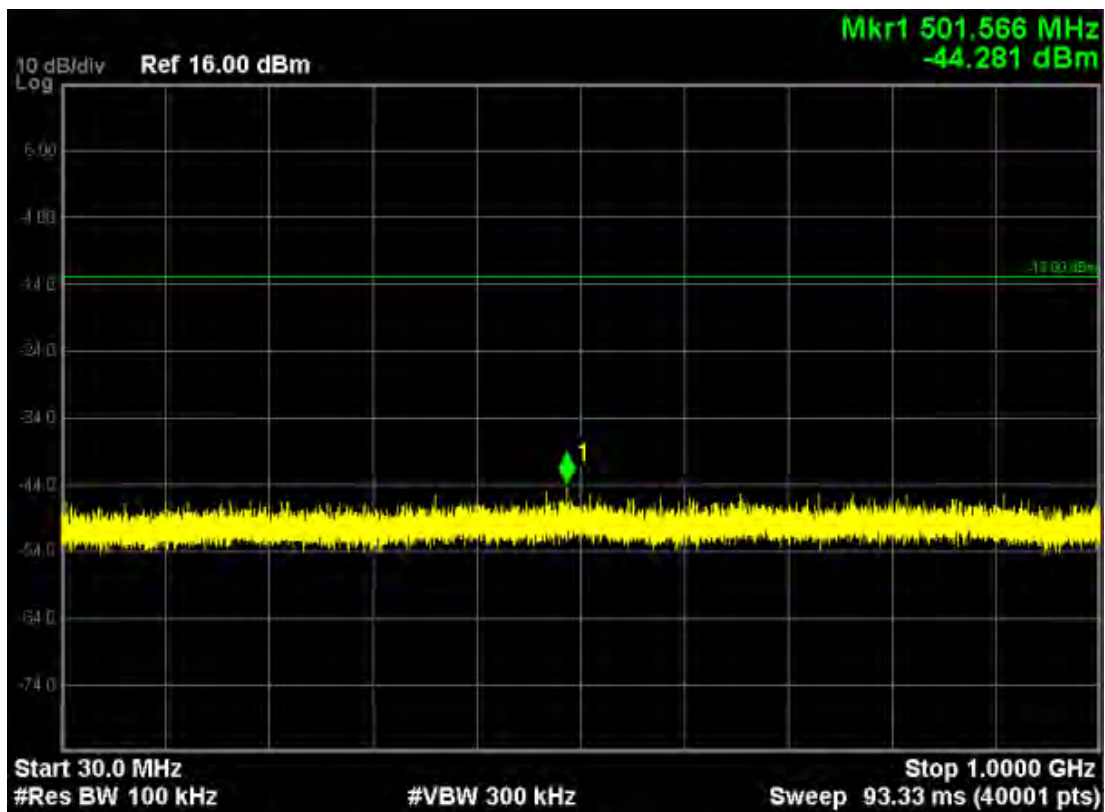

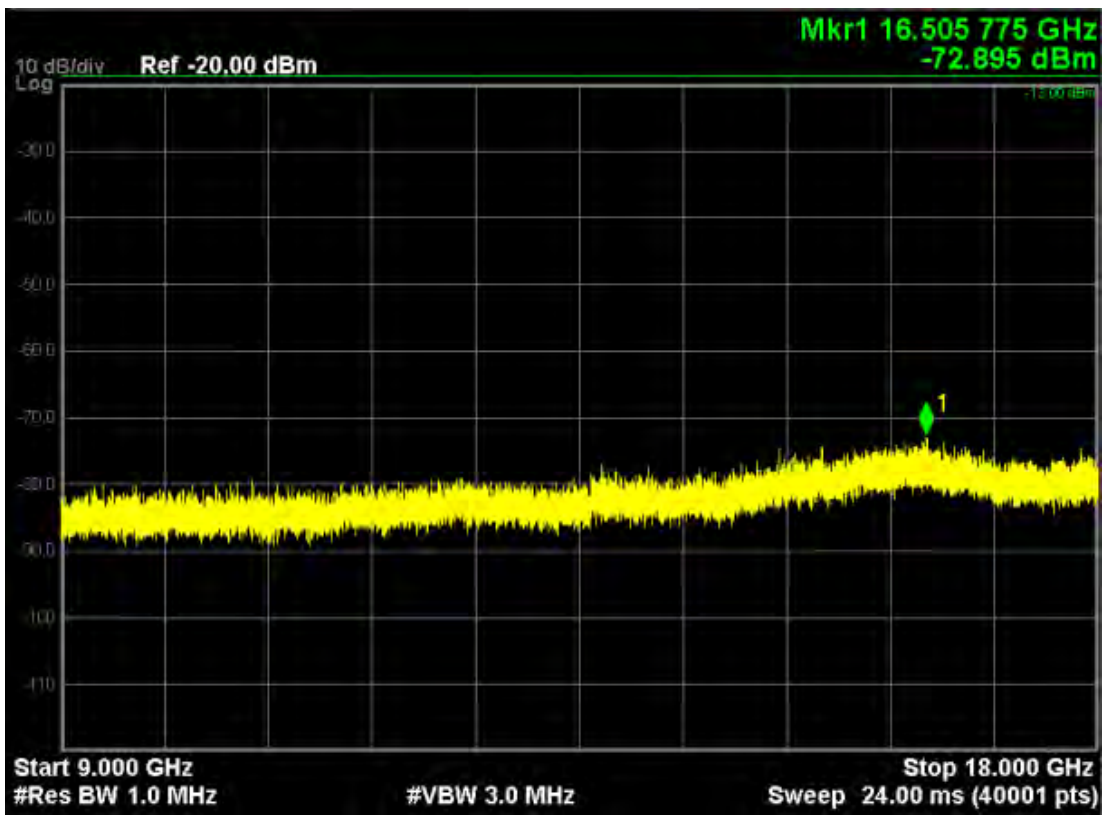
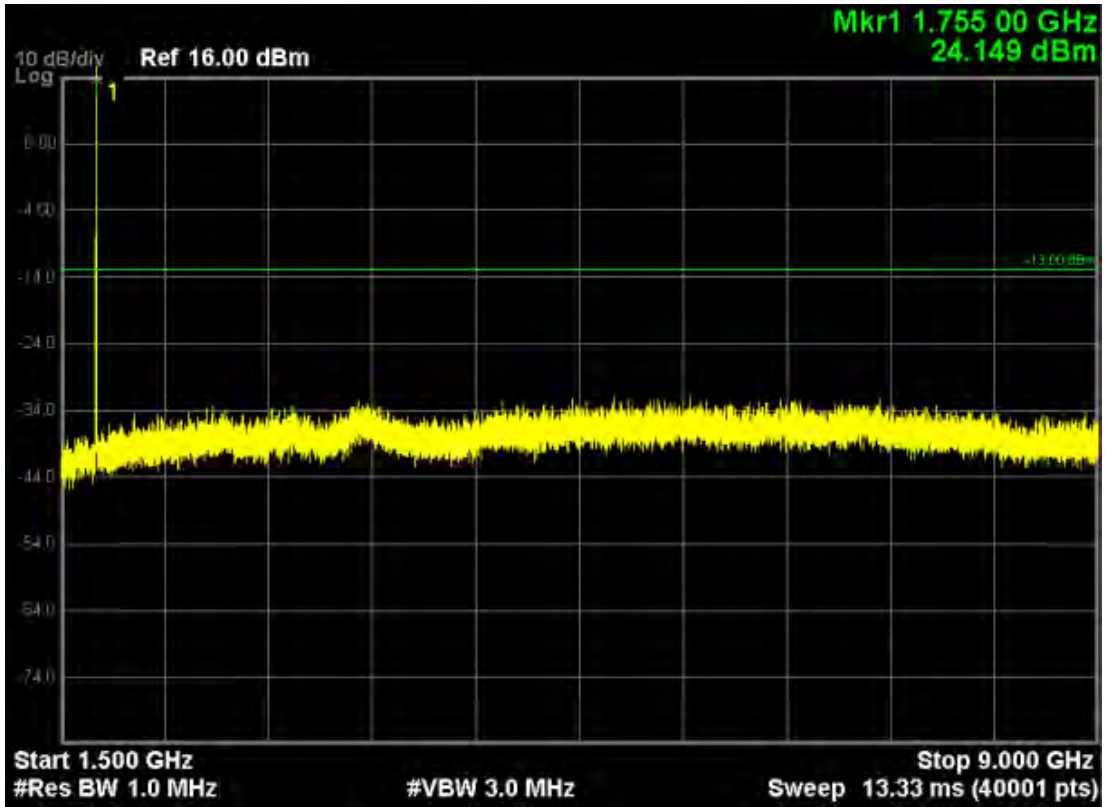

LTE Band 4 (QPSK, Band Width 10MHz, RB Size 1, RB Offset 0, Channel 20000, Frequency 1715.0MHz)

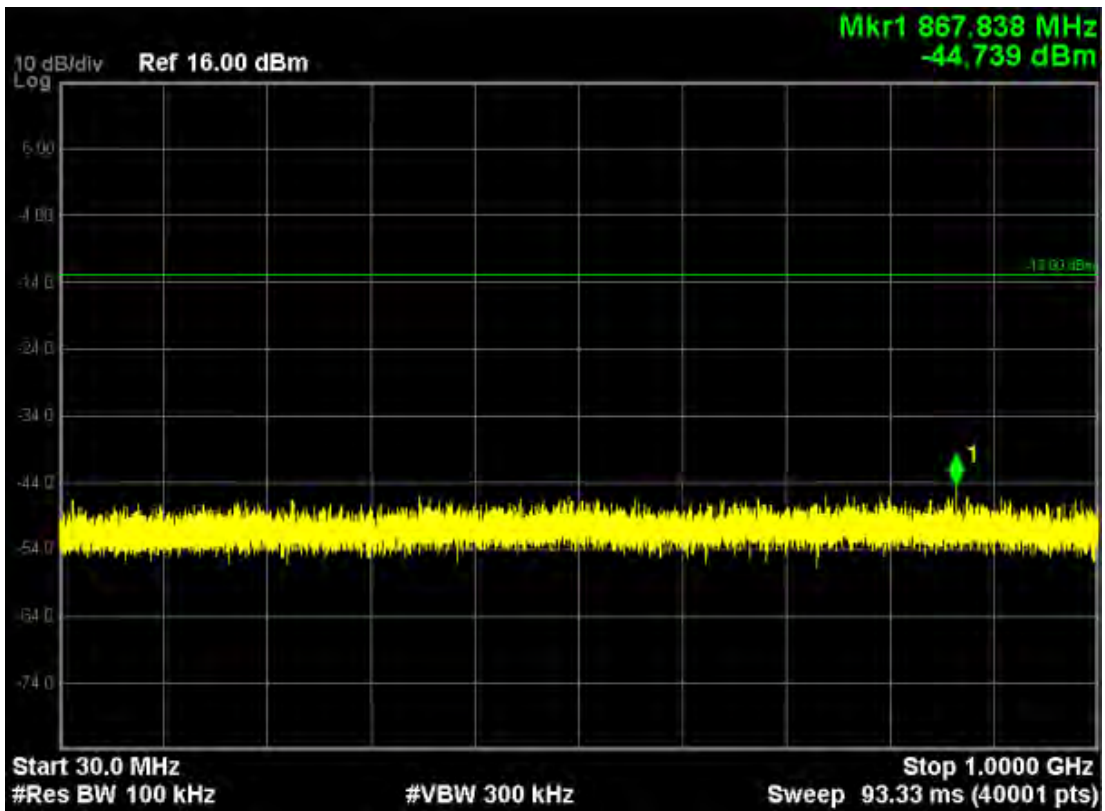
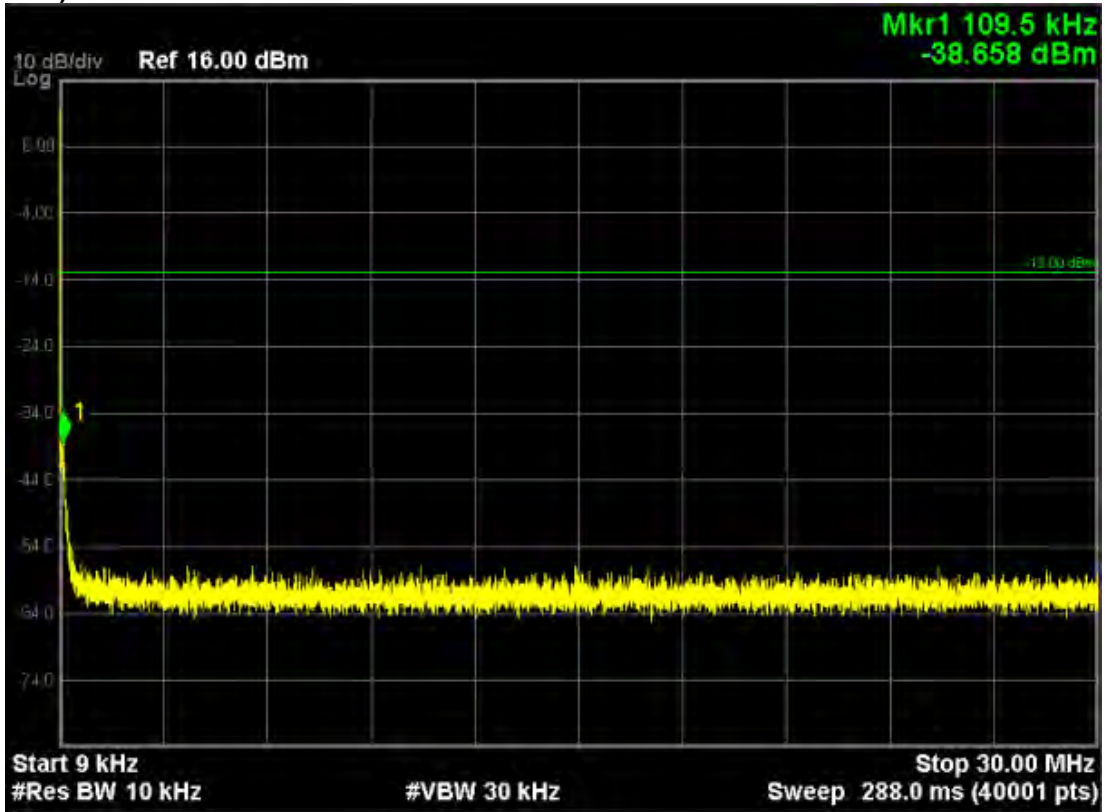

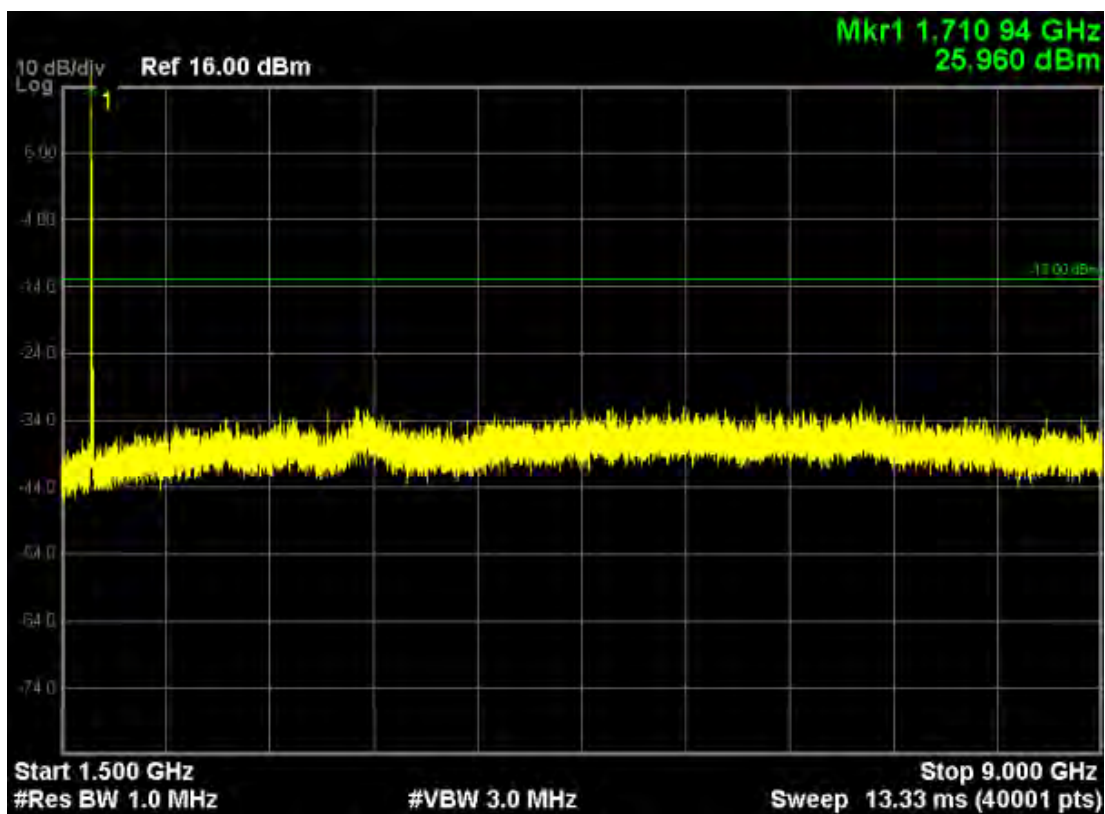
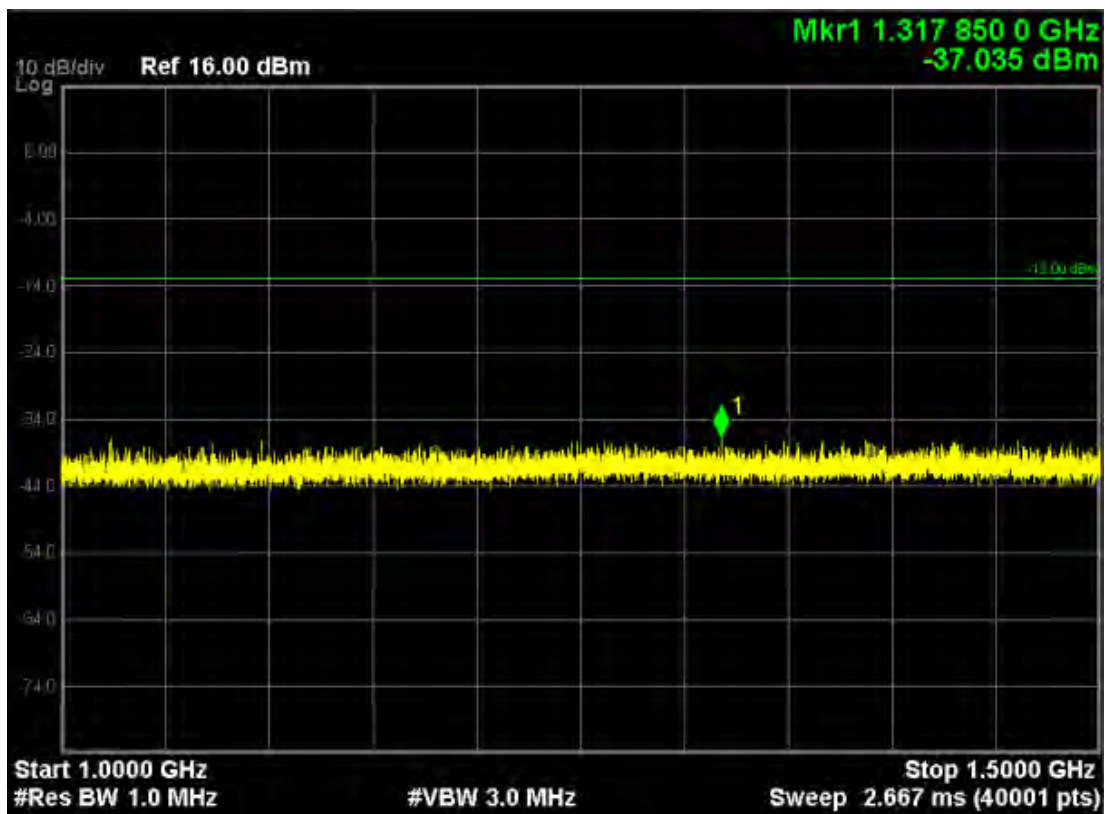

Note: The signal at point 1 is carrier

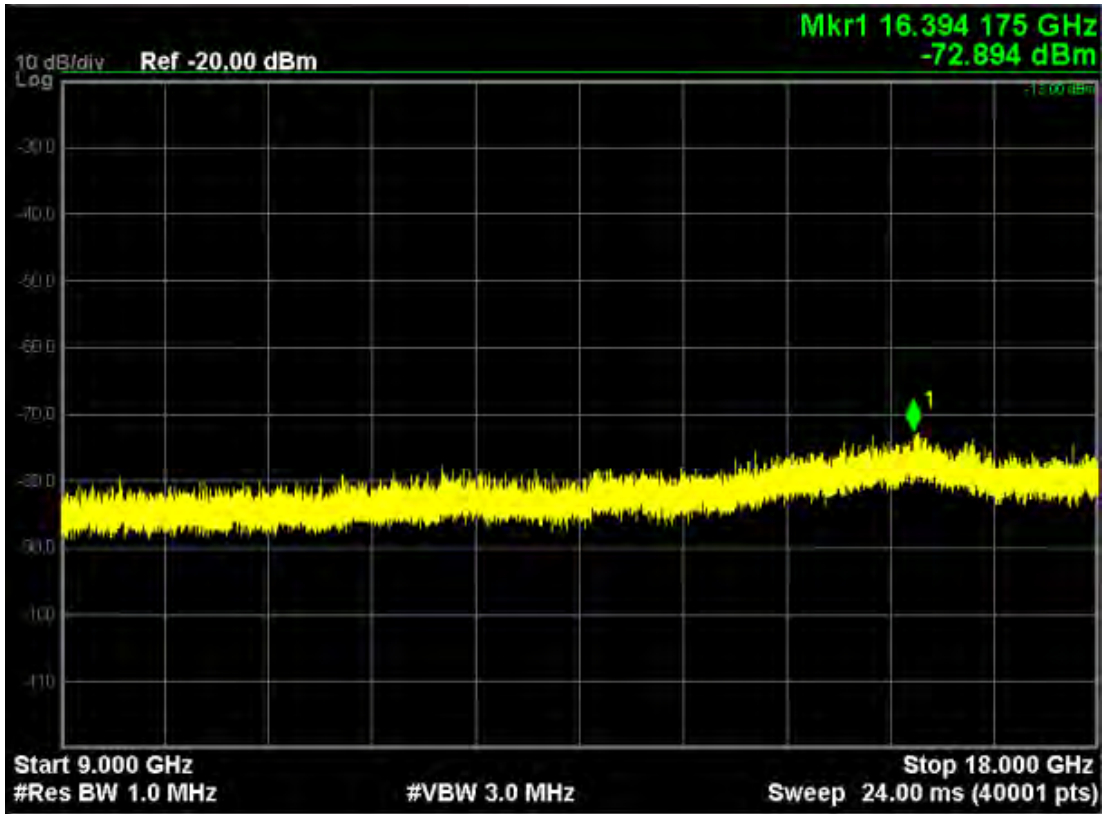

LTE Band 4 (16-QAM, Band Width 10MHz, RB Size 1, RB Offset 0, Channel 20000, Frequency 1715.0MHz)

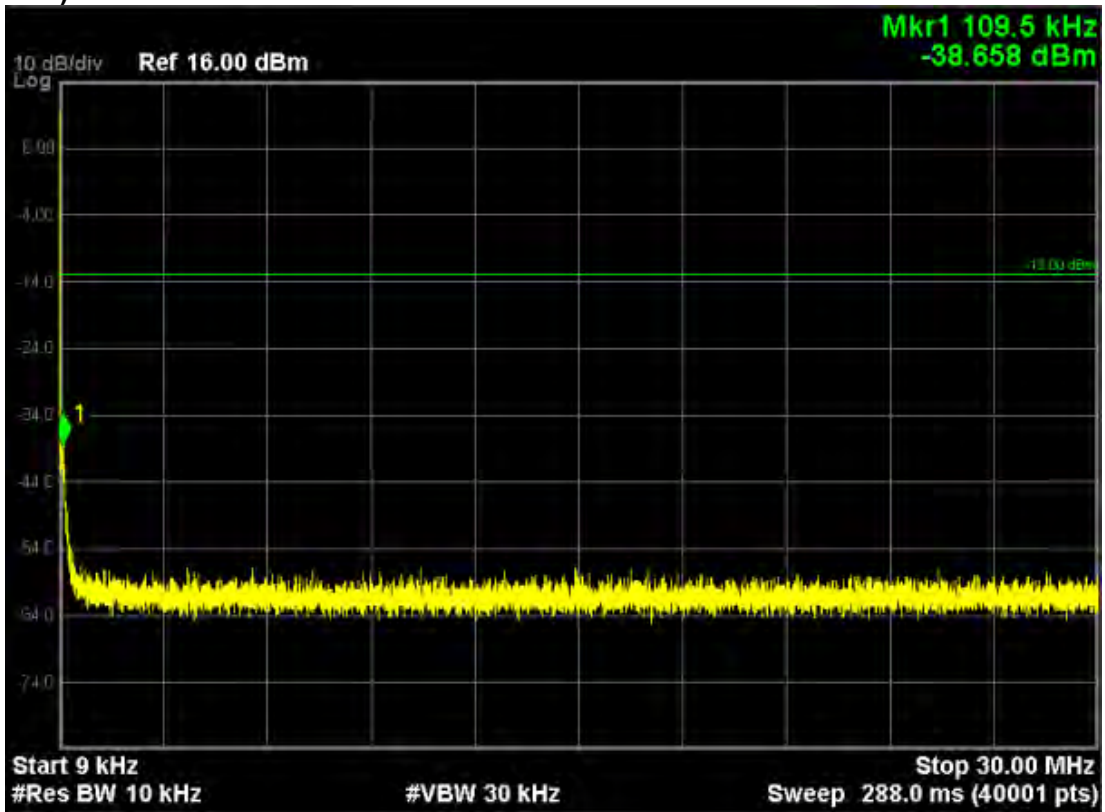

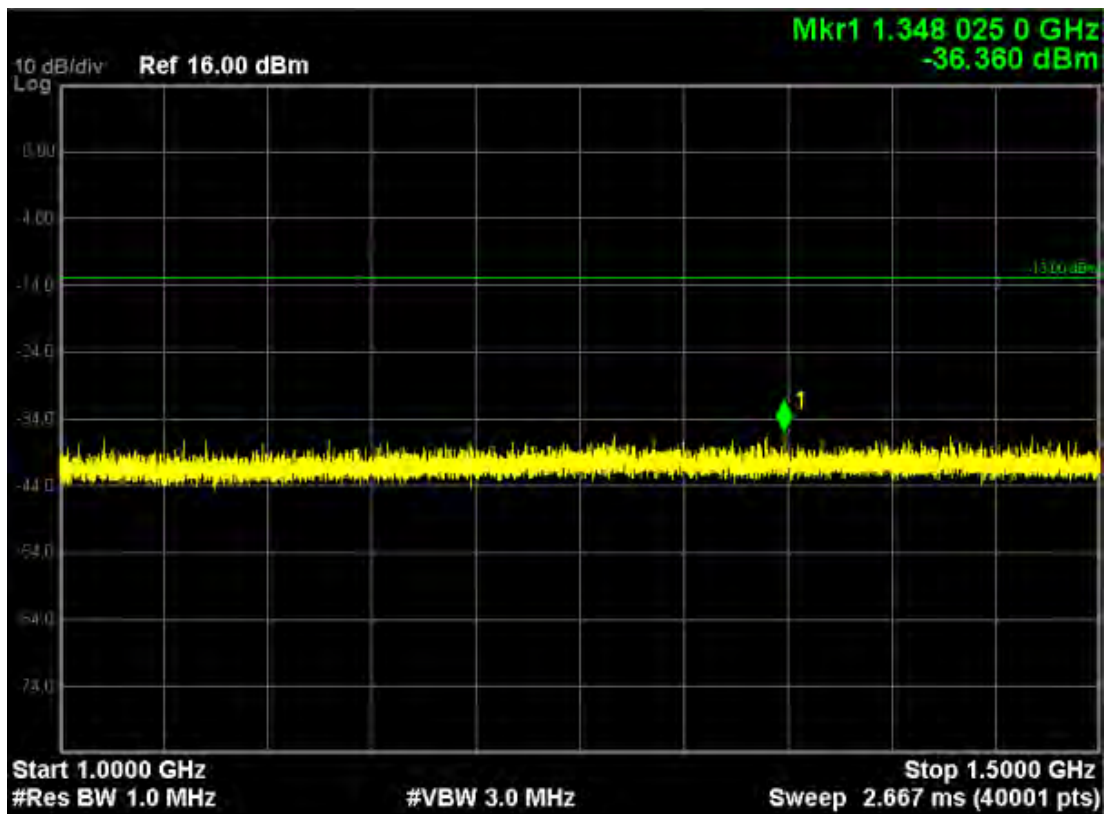
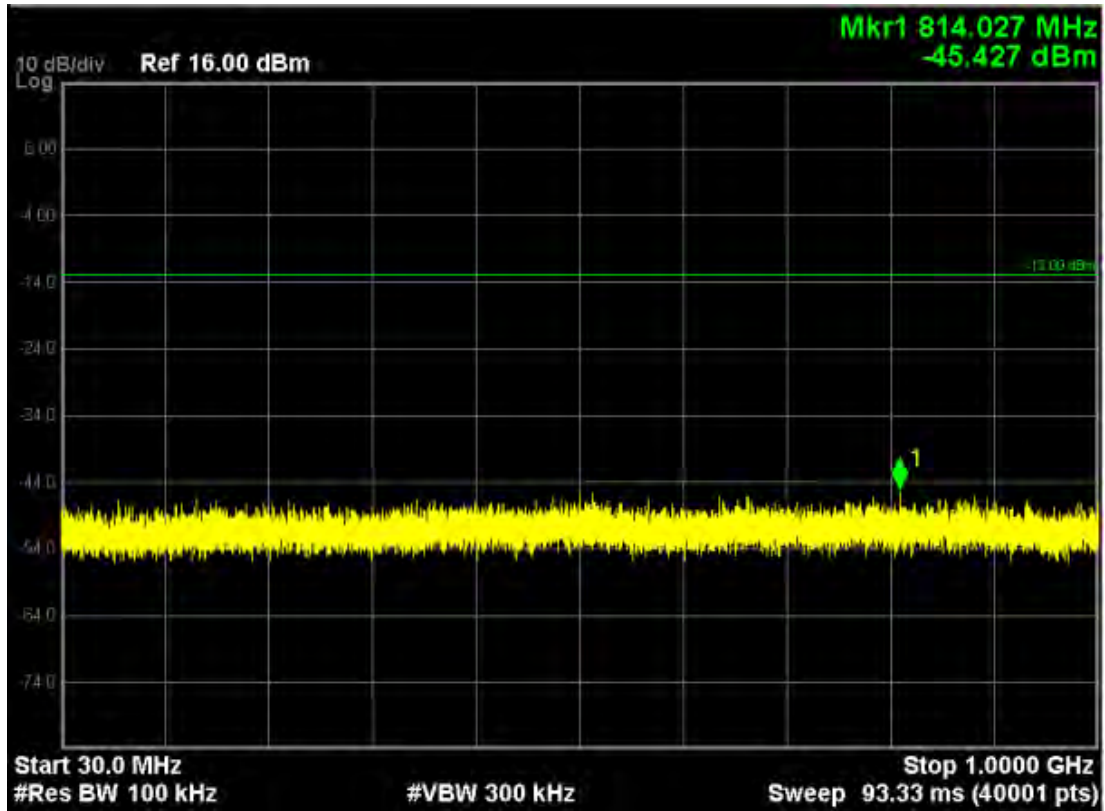

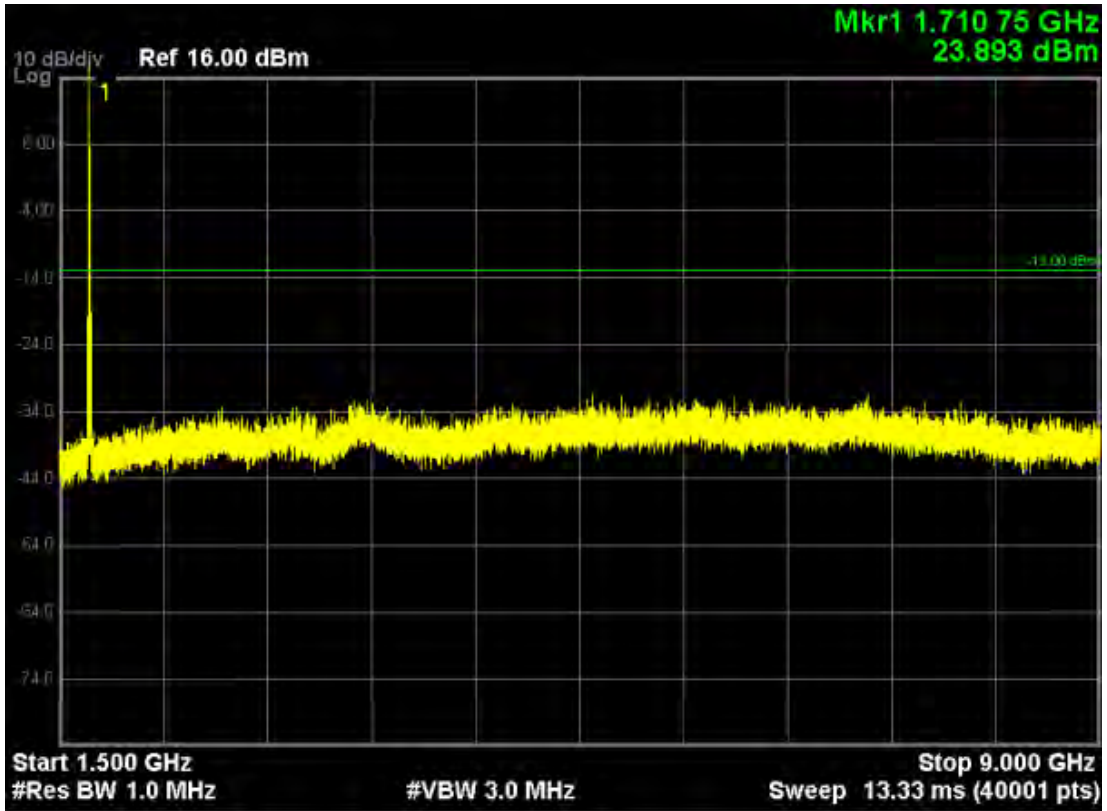

Note: The signal at point 1 is carrier

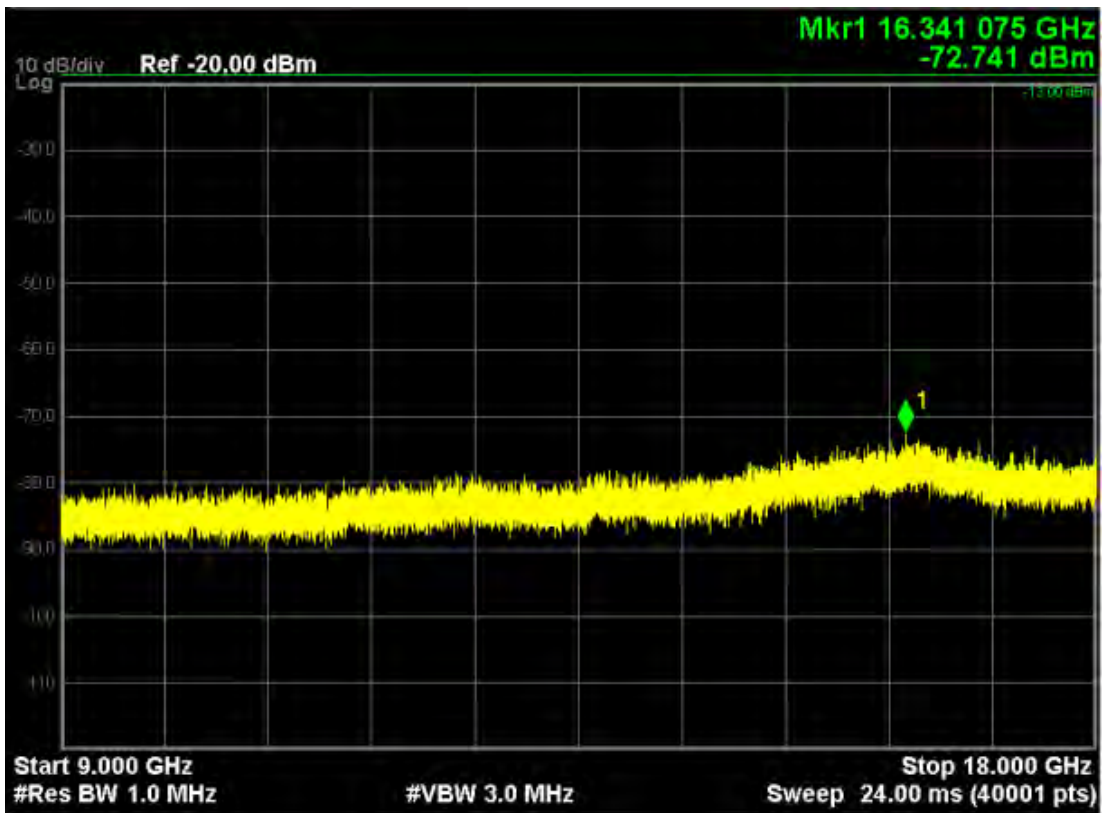

LTE Band 13 (QPSK, Band Width 5MHz, RB Size 1, RB Offset 0, Channel 23230, Frequency 782.0MHz)

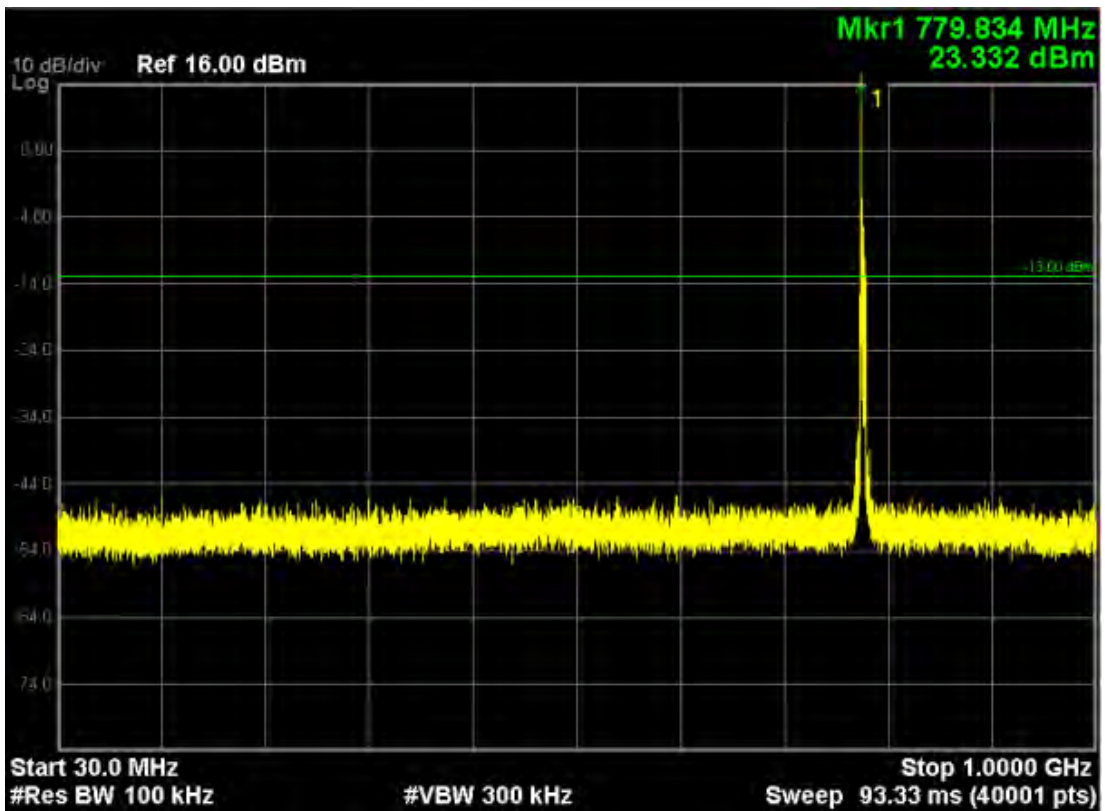
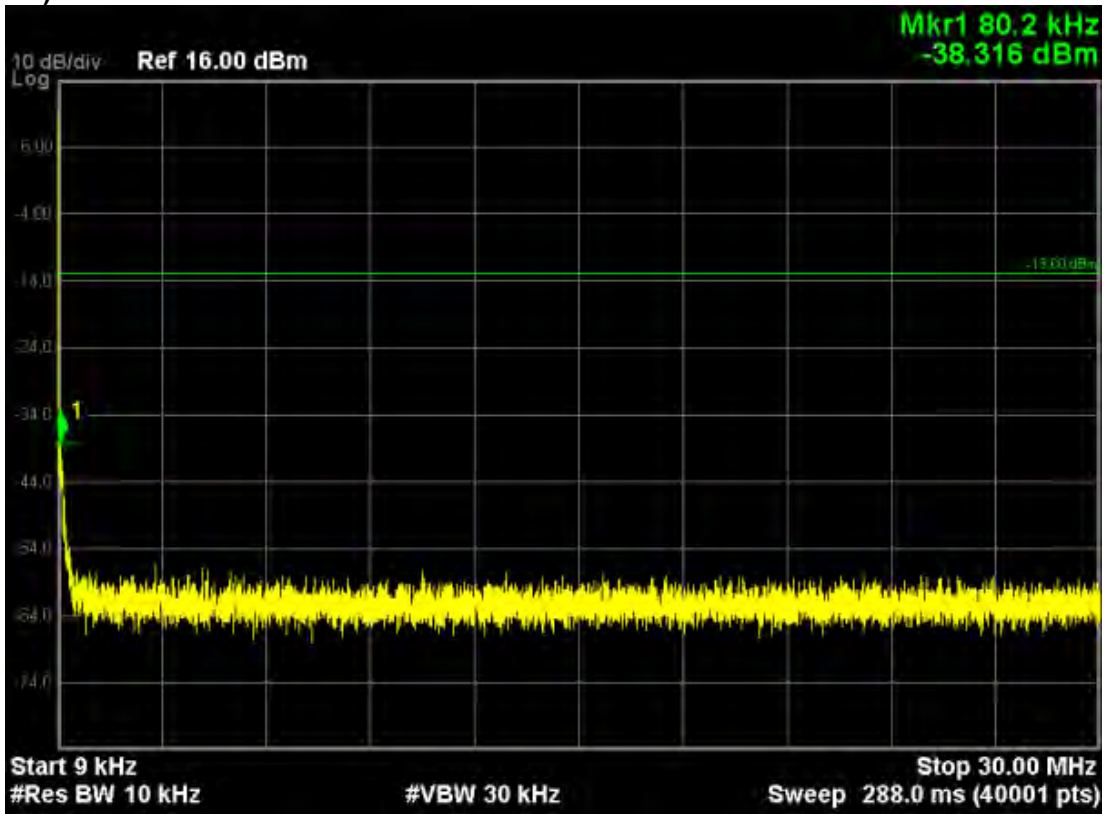

Note: The signal at point 1 is carrier

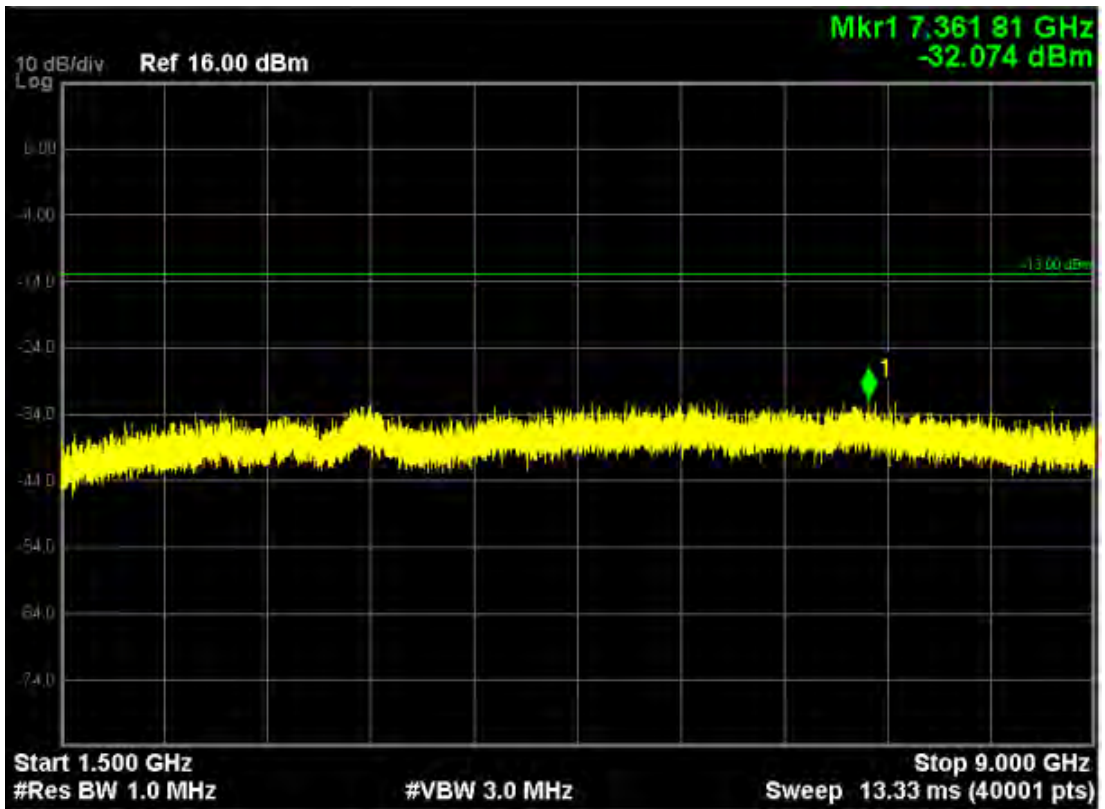
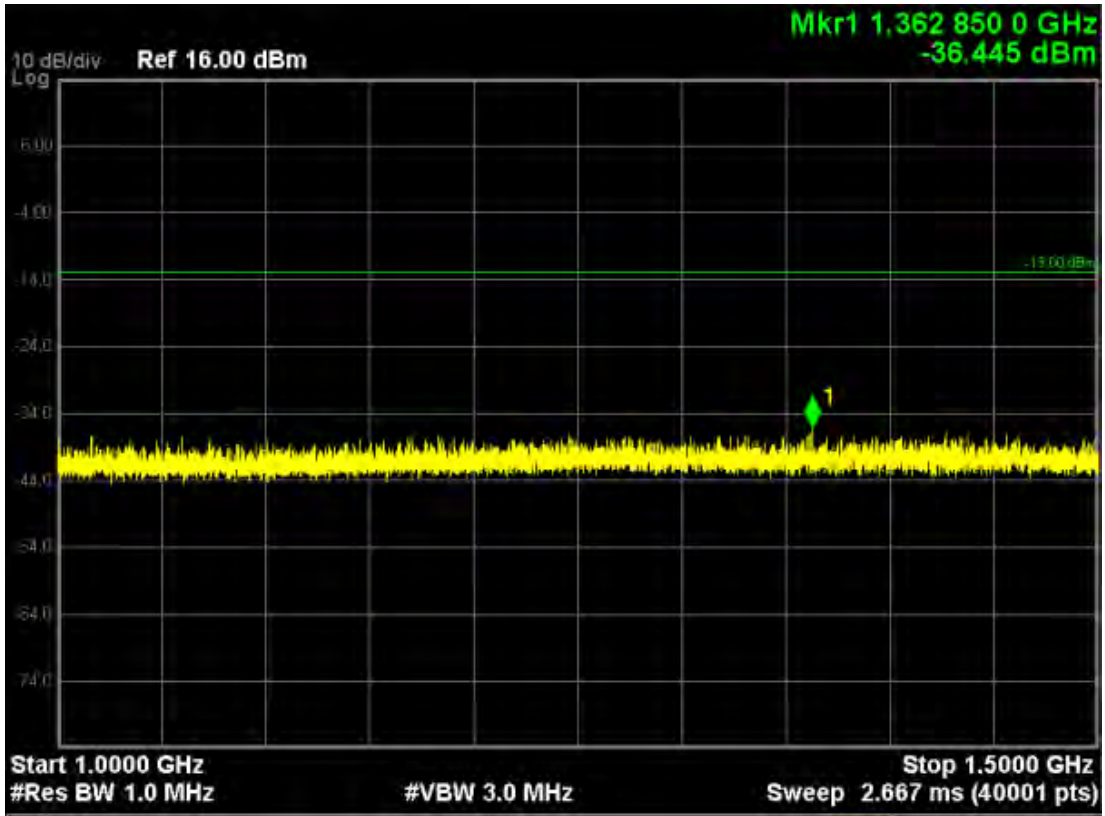

LTE Band 13 (16-QAM, Band Width 5MHz, RB Size 1, RB Offset 24, Channel 23230, Frequency 782.0MHz)

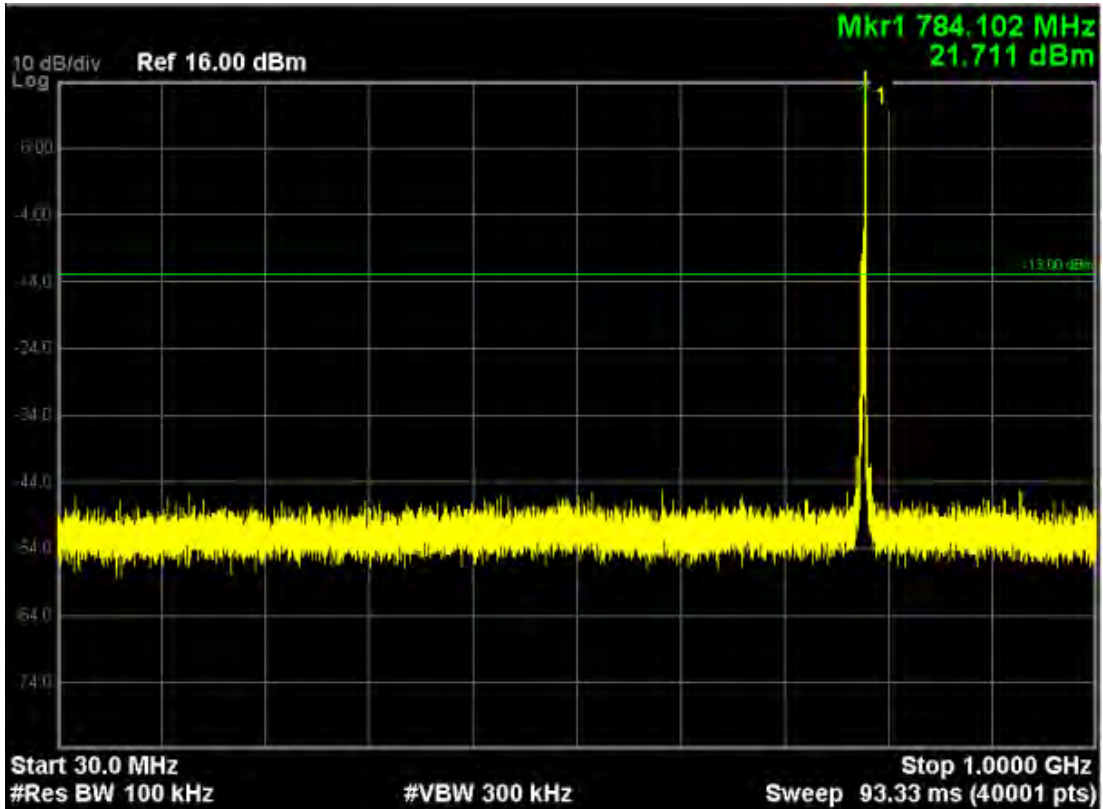
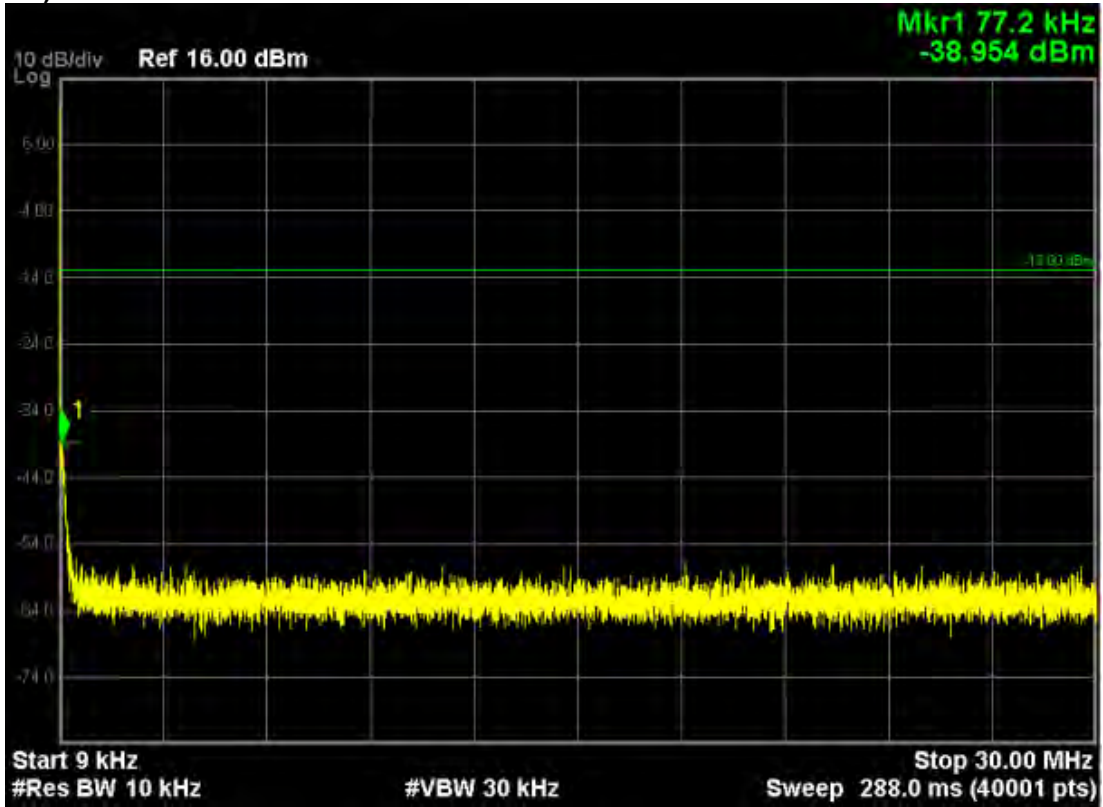

Note: The signal at point 1 is carrier

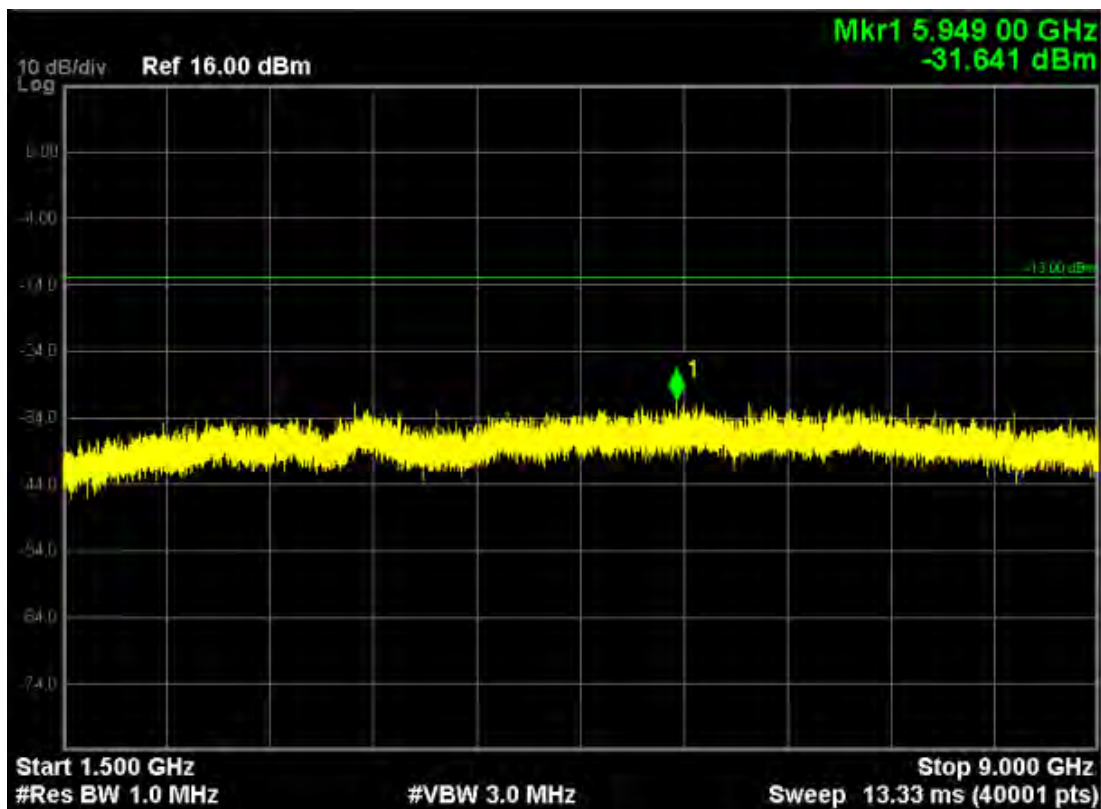
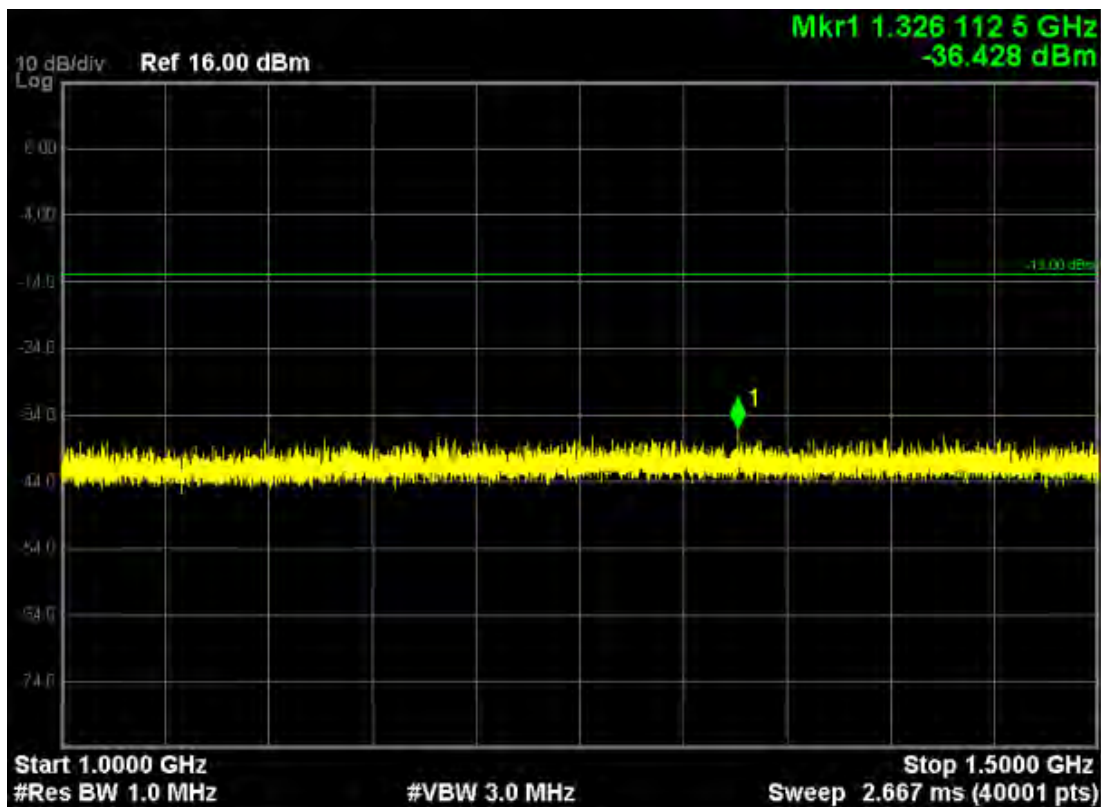

LTE Band 13 (QPSK, Band Width 10MHz, RB Size 1, RB Offset 0, Channel 23230, Frequency 782.0MHz)

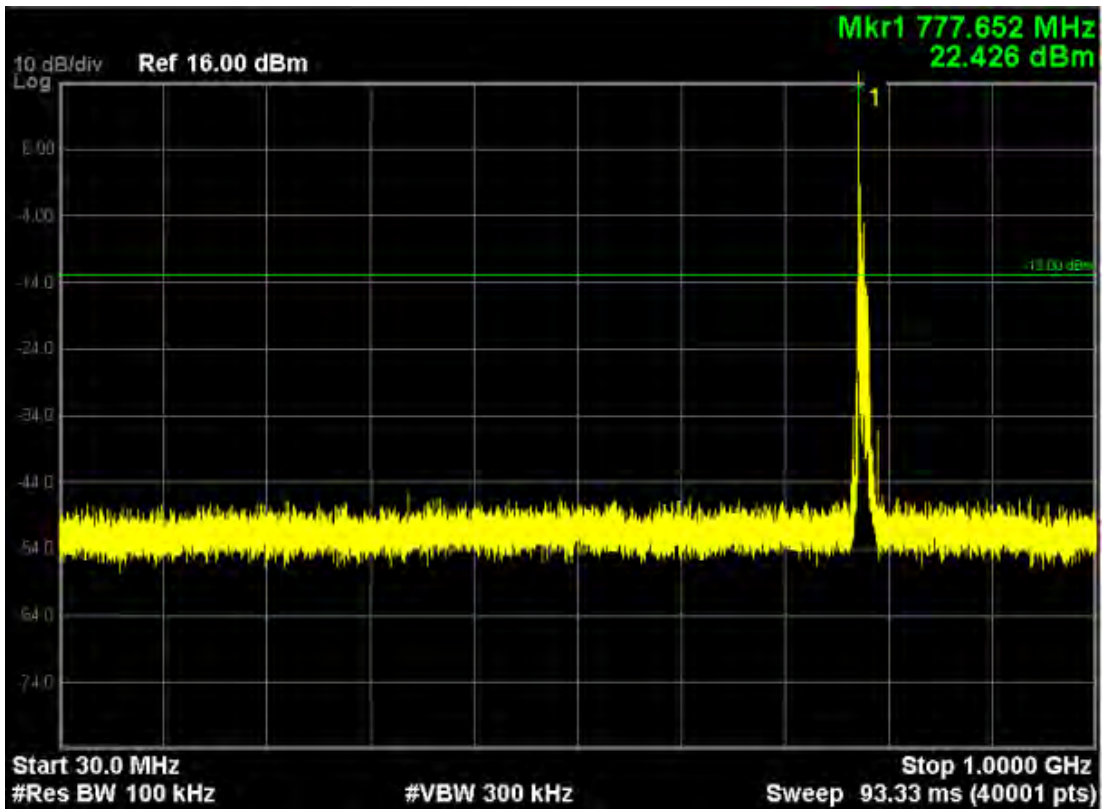
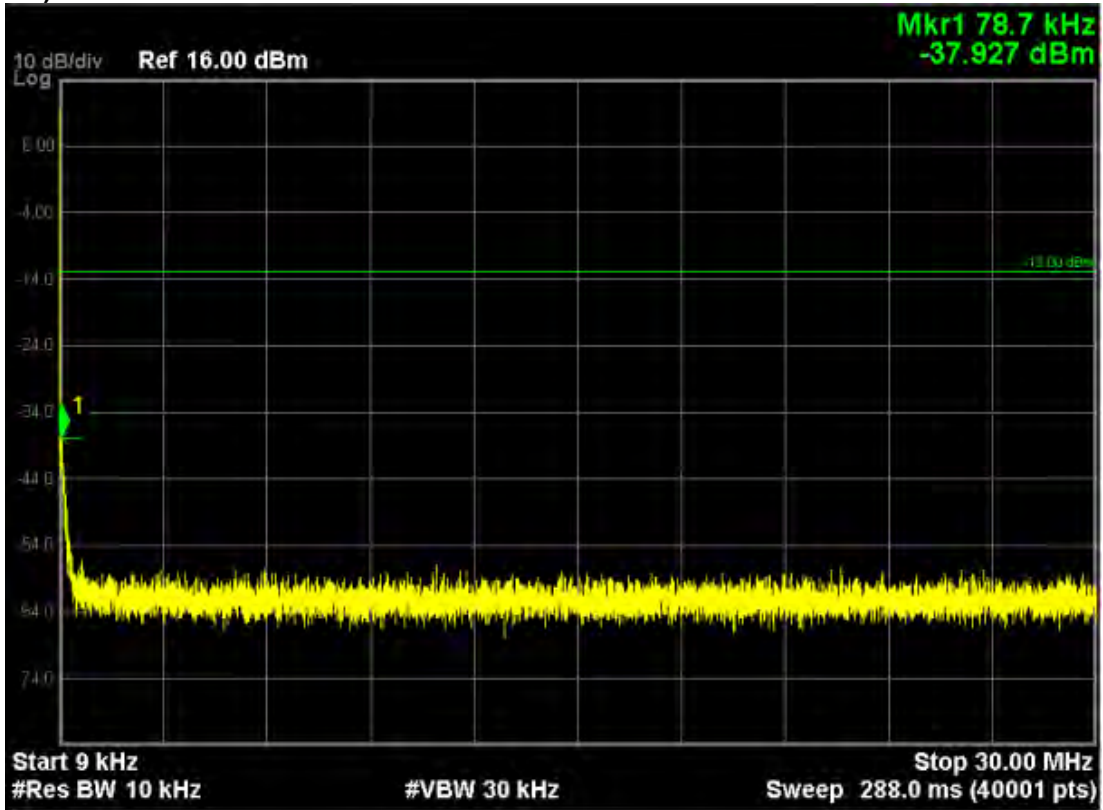

Note: The signal at point 1 is carrier

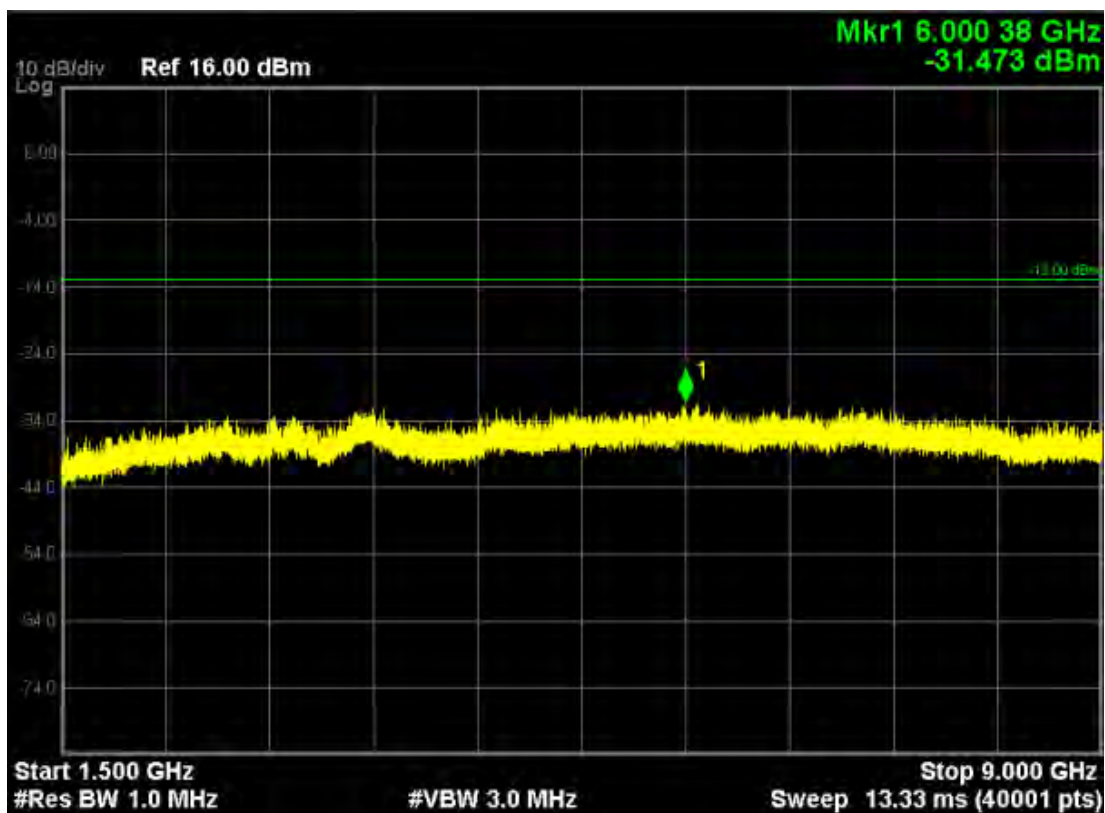
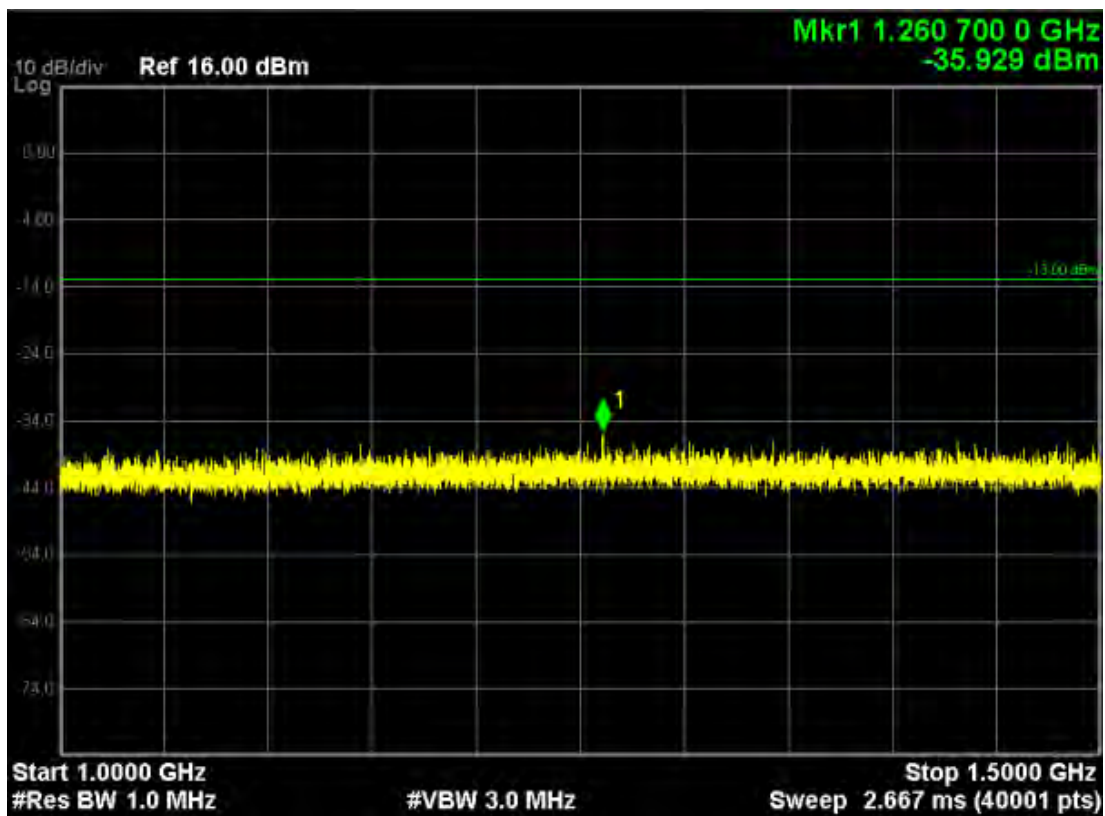

LTE Band 13 (16-QAM, Band Width 10MHz, RB Size 1, RB Offset 0, Channel 23230, Frequency 782.0MHz)

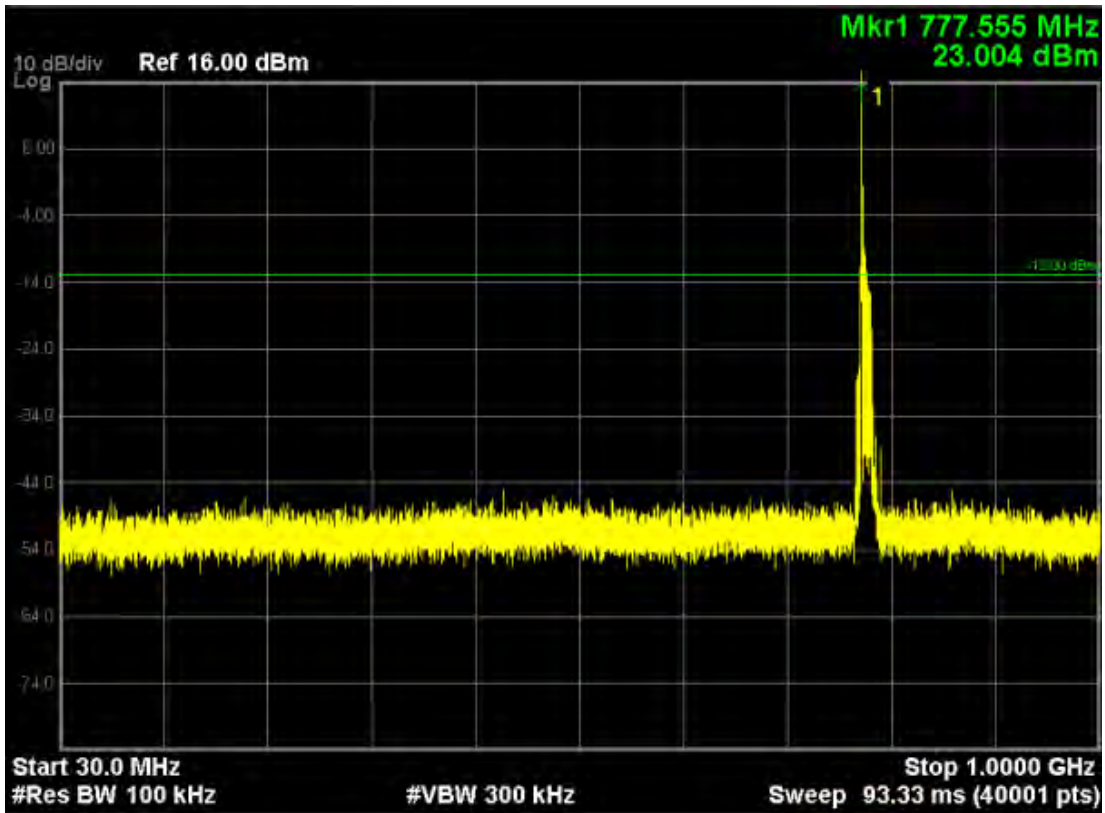
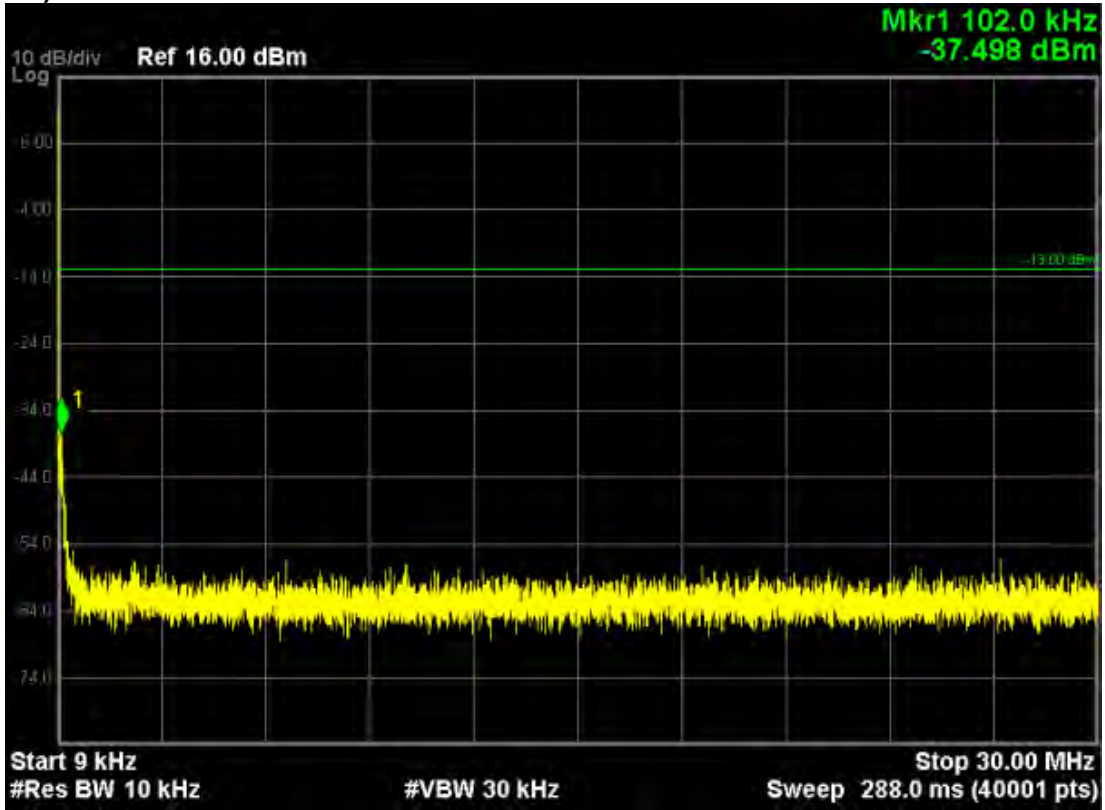

Note: The signal at point 1 is carrier

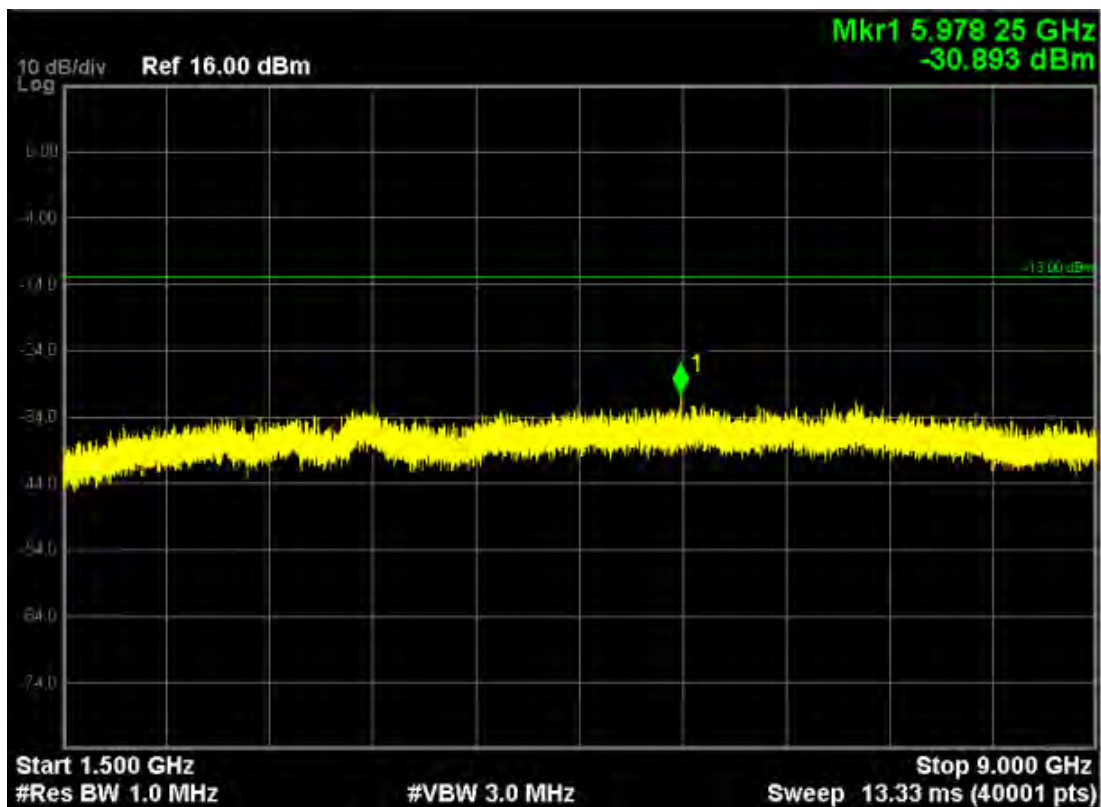
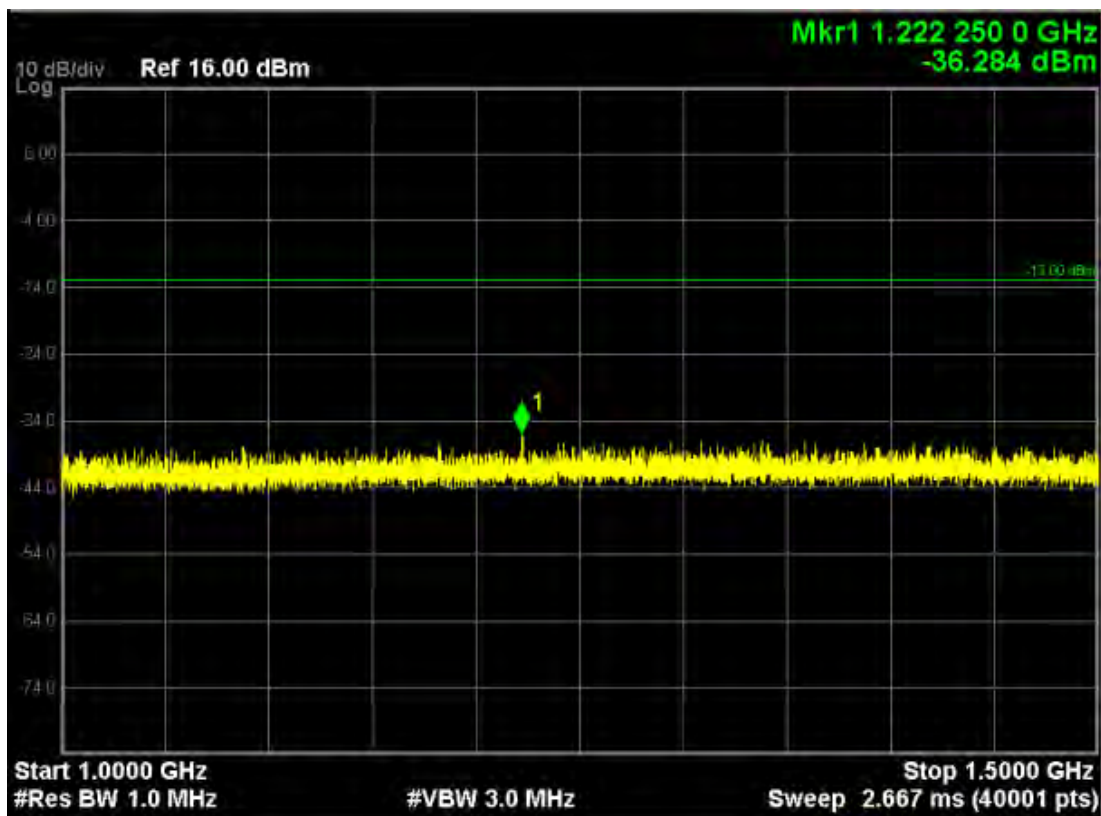

12V DC:

LTE Band 4 (QPSK, Band Width 5MHz, RB Size 1, RB Offset 0, Channel 19975, Frequency 1712.5MHz)

9KHz to 30MHz

The low frequency, which started from 9KHz to 30MHz, was pre-scanned and the result which was 20dB lower than the limit line, and that was not reported per 2.1057 (c).

30MHz to 1GHz

Frequency (MHz)	Ant. Pol. (H/V)	SG Reading (dBm)	Cable Loss (dB)	Gain (dBi)	EIRP (dBm)	Limit (dBm)	Margin (dB)
Channel 19975 (1712.5MHz)							
730.6	H	-48.65	3.42	-2.56	-54.63	-13	-41.63
730.6	V	-47.77	3.42	-2.56	-53.75	-13	-40.63

Above 1GHz

Frequency (MHz)	Ant. Pol. (H/V)	SG Reading (dBm)	Cable Loss (dB)	Gain (dBi)	EIRP (dBm)	Limit (dBm)	Margin (dB)
Channel 19975 (1712.5MHz)							
3425	H	-48.39	8.56	11.53	-45.42	-13	-32.42
3425	V	-47.32	8.56	11.53	-44.35	-13	-31.35
5137.5	H	-50.66	9.68	12.8	-47.54	-13	-34.54
5137.5	V	-49.46	9.68	12.8	-46.34	-13	-33.34

LTE Band 4 (QPSK, Band Width 10MHz, RB Size 1, RB Offset 49, Channel 20350, Frequency 1750.0MHz)

9KHz to 30MHz

The low frequency, which started from 9KHz to 30MHz, was pre-scanned and the result which was 20dB lower than the limit line, and that was not reported per 2.1057 (c).

30MHz to 1GHz

Frequency (MHz)	Ant. Pol. (H/V)	SG Reading (dBm)	Cable Loss (dB)	Gain (dBi)	EIRP (dBm)	Limit (dBm)	Margin (dB)
Channel 20350 (1750.0MHz)							
727.3	H	-48.37	3.42	-2.56	-54.35	-13	-41.35
727.3	V	-47.58	3.42	-2.56	-53.56	-13	-40.56

Above 1GHz

Frequency (MHz)	Ant. Pol. (H/V)	SG Reading (dBm)	Cable Loss (dB)	Gain (dBi)	EIRP (dBm)	Limit (dBm)	Margin (dB)
Channel 20350 (1750.0MHz)							
3465	H	-48.61	8.56	11.53	-45.64	-13	-32.64
3465	V	-47.42	8.56	11.53	-44.45	-13	-31.45

5197.5	H	-50.87	9.68	12.8	-47.75	-13	-34.75
5197.5	V	-49.37	9.68	12.8	-46.25	-13	-33.25

**LTE Band 13 (QPSK, Band Width 5MHz, RB Size 1, RB Offset 0, Channel 23230, Frequency 782.0MHz)
9KHz to 30MHz**

The low frequency, which started from 9KHz to 30MHz, was pre-scanned and the result which was 20dB lower than the limit line, and that was not reported per 2.1057 (c).

30MHz to 1GHz

Frequency (MHz)	Ant. Pol. (H/V)	SG Reading (dBm)	Cable Loss (dB)	Gain (dBi)	EIRP (dBm)	Limit (dBm)	Margin (dB)
Channel 23230 (782.0MHz)							
738.2	H	-48.74	3.42	-2.56	-54.72	-13	-41.72
738.2	V	-47.29	3.42	-2.56	-53.27	-13	-40.27

Above 1GHz

Frequency (MHz)	Ant. Pol. (H/V)	SG Reading (dBm)	Cable Loss (dB)	Gain (dBi)	EIRP (dBm)	Limit (dBm)	Margin (dB)
Channel 23230 (782.0MHz)							
3465	H	-48.40	8.56	11.53	-45.43	-13	-32.43
3465	V	-47.31	8.56	11.53	-44.34	-13	-31.34
5197.5	H	-50.97	9.68	12.8	-47.85	-13	-34.85
5197.5	V	-49.27	9.68	12.8	-46.15	-13	-33.15

**LTE Band 13 (QPSK, Band Width 10MHz, RB Size 1, RB Offset 0, Channel 23230, Frequency 782.0MHz)
9KHz to 30MHz**

The low frequency, which started from 9KHz to 30MHz, was pre-scanned and the result which was 20dB lower than the limit line, and that was not reported per 2.1057 (c).

30MHz to 1GHz

Frequency (MHz)	Ant. Pol. (H/V)	SG Reading (dBm)	Cable Loss (dB)	Gain (dBi)	EIRP (dBm)	Limit (dBm)	Margin (dB)
Channel 23230 (782.0MHz)							
730.2	H	-48.77	3.42	-2.56	-54.75	-13	-41.75
730.2	V	-47.56	3.42	-2.56	-53.54	-13	-40.54

Above 1GHz

Frequency (MHz)	Ant. Pol. (H/V)	SG Reading (dBm)	Cable Loss (dB)	Gain (dBi)	EIRP (dBm)	Limit (dBm)	Margin (dB)
Channel 23230 (782.0MHz)							
3465	H	-48.85	8.56	11.53	-45.88	-13	-32.88

3465	V	-47.69	8.56	11.53	-44.72	-13	-31.72
5197.5	H	-50.68	9.68	12.8	-47.56	-13	-34.56
5197.5	V	-49.57	9.68	12.8	-46.45	-13	-33.45

24V DC:

LTE Band 4 (QPSK, Band Width 5MHz, RB Size 1, RB Offset 0, Channel 19975, Frequency 1712.5MHz)

9KHz to 30MHz

The low frequency, which started from 9KHz to 30MHz, was pre-scanned and the result which was 20dB lower than the limit line, and that was not reported per 2.1057 (c).

30MHz to 1GHz

Frequency (MHz)	Ant. Pol. (H/V)	SG Reading (dBm)	Cable Loss (dB)	Gain (dBi)	EIRP (dBm)	Limit (dBm)	Margin (dB)
Channel 19975 (1712.5MHz)							
730.6	H	-48.60	3.42	-2.56	-54.58	-13	-41.58
730.6	V	-47.28	3.42	-2.56	-53.26	-13	-40.26

Above 1GHz

Frequency (MHz)	Ant. Pol. (H/V)	SG Reading (dBm)	Cable Loss (dB)	Gain (dBi)	EIRP (dBm)	Limit (dBm)	Margin (dB)
Channel 19975 (1712.5MHz)							
3425	H	-48.69	8.56	11.53	-45.72	-13	-32.72
3425	V	-47.36	8.56	11.53	-44.39	-13	-31.39
5137.5	H	-50.74	9.68	12.8	-47.62	-13	-34.62
5137.5	V	-49.64	9.68	12.8	-46.52	-13	-33.52

LTE Band 4 (QPSK, Band Width 10MHz, RB Size 1, RB Offset 49, Channel 20350, Frequency 1750.0MHz)

9KHz to 30MHz

The low frequency, which started from 9KHz to 30MHz, was pre-scanned and the result which was 20dB lower than the limit line, and that was not reported per 2.1057 (c).

30MHz to 1GHz

Frequency (MHz)	Ant. Pol. (H/V)	SG Reading (dBm)	Cable Loss (dB)	Gain (dBi)	EIRP (dBm)	Limit (dBm)	Margin (dB)
Channel 20350 (1750.0MHz)							
727.3	H	-48.79	3.42	-2.56	-54.77	-13	-41.77
727.3	V	-47.44	3.42	-2.56	-53.42	-13	-40.42

Above 1GHz

Frequency (MHz)	Ant. Pol. (H/V)	SG Reading (dBm)	Cable Loss (dB)	Gain (dBi)	EIRP (dBm)	Limit (dBm)	Margin (dB)
-----------------	-----------------	------------------	-----------------	------------	------------	-------------	-------------

Channel 20350 (1750.0MHz)							
3465	H	-48.65	8.56	11.53	-45.68	-13	-32.68
3465	V	-47.30	8.56	11.53	-44.33	-13	-31.33
5197.5	H	-50.81	9.68	12.8	-47.69	-13	-34.69
5197.5	V	-49.33	9.68	12.8	-46.21	-13	-33.21

**LTE Band 13 (QPSK, Band Width 5MHz, RB Size 1, RB Offset 0, Channel 23230, Frequency 782.0MHz)
9KHz to 30MHz**

The low frequency, which started from 9KHz to 30MHz, was pre-scanned and the result which was 20dB lower than the limit line, and that was not reported per 2.1057 (c).

30MHz to 1GHz

Frequency (MHz)	Ant. Pol. (H/V)	SG Reading (dBm)	Cable Loss (dB)	Gain (dBi)	EIRP (dBm)	Limit (dBm)	Margin (dB)
Channel 23230 (782.0MHz)							
738.2	H	-48.80	3.42	-2.56	-54.78	-13	-41.78
738.2	V	-47.48	3.42	-2.56	-53.46	-13	-40.46

Above 1GHz

Frequency (MHz)	Ant. Pol. (H/V)	SG Reading (dBm)	Cable Loss (dB)	Gain (dBi)	EIRP (dBm)	Limit (dBm)	Margin (dB)
Channel 23230 (782.0MHz)							
3465	H	-48.69	8.56	11.53	-45.72	-13	-32.72
3465	V	-47.40	8.56	11.53	-44.43	-13	-31.43
5197.5	H	-50.67	9.68	12.8	-47.55	-13	-44.55
5197.5	V	-49.74	9.68	12.8	-46.62	-13	-43.62

**LTE Band 13 (QPSK, Band Width 10MHz, RB Size 1, RB Offset 0, Channel 23230, Frequency 782.0MHz)
9KHz to 30MHz**

The low frequency, which started from 9KHz to 30MHz, was pre-scanned and the result which was 20dB lower than the limit line, and that was not reported per 2.1057 (c).

30MHz to 1GHz

Frequency (MHz)	Ant. Pol. (H/V)	SG Reading (dBm)	Cable Loss (dB)	Gain (dBi)	EIRP (dBm)	Limit (dBm)	Margin (dB)
Channel 23230 (782.0MHz)							
730.2	H	-48.84	3.42	-2.56	-54.82	-13	-41.82
730.2	V	-47.69	3.42	-2.56	-53.67	-13	-40.67

Above 1GHz

Frequency (MHz)	Ant. Pol. (H/V)	SG Reading (dBm)	Cable Loss (dB)	Gain (dBi)	EIRP (dBm)	Limit (dBm)	Margin (dB)
Channel 23230 (782.0MHz)							
3465	H	-48.73	8.56	11.53	-45.76	-13	-32.76
3465	V	-47.32	8.56	11.53	-44.35	-13	-31.35
5197.5	H	-51.07	9.68	12.8	-47.95	-13	-34.95
5197.5	V	-49.84	9.68	12.8	-46.72	-13	-33.72

7. Frequency Stability Under Temperature & Voltage Variations

7.1. Test Equipment

Instrument	Manufacturer	Model	Serial No.	Due Date
Spectrum Analyzer	Agilent	N9038A	MY51210142	11/04/2017
Radio Communication Tester	R&S	CMW500	147483	11/07/2017
DC Power Supply	Agilent	6612C	MY43002989	02/28/2018
Temperature Chamber	WEISS	DU/20/40	58226017340050	01/02/2018

The measure equipment had been calibrated once a year.

7.2. Test Setup

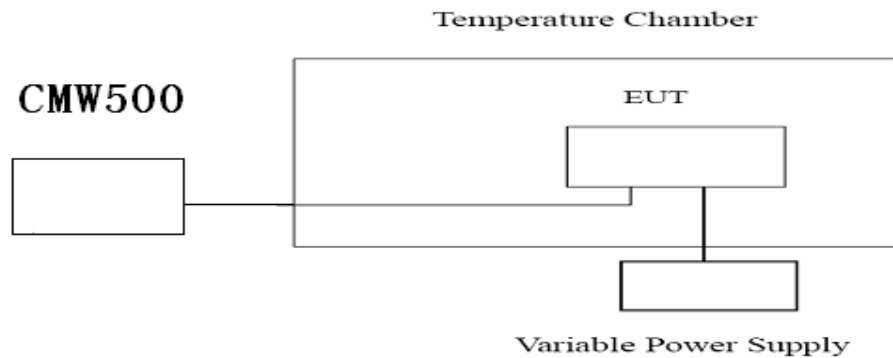

7.3. Limit

N/A

7.4. Test Procedure

1. The testing follows FCC KDB 971168 v02v02 Section 9.0;

2. Frequency Stability Under Temperature Variations:

The equipment under test was connected to an external AC or DC power supply and input rated voltage. RF output was connected to a frequency counter or CMW500. The EUT was placed inside the temperature chamber.

EUT 20°C operating frequency as reference frequency. Turn EUT off and set the chamber temperature to -30°C. After the temperature stabilized for approximately 30 minutes recorded the frequency. Repeat step measure with 10°C increased per stage until the highest temperature of +50°C reached.

3. Frequency Stability Under Voltage Variations:

Set chamber temperature to 20°C. Use a variable AC power supply / DC power source to power the EUT and set the voltage to rated voltage.

Reduce the input voltage to specify extreme voltage variation ($\pm 15\%$) and endpoint, record the maximum frequency change.

7.5. Uncertainty

The measurement uncertainty is defined as ± 10 Hz.

7.6. Test Result

12V DC:

LTE Band 4 (QPSK, Band Width 5MHz,RB Size 1,RB Offset 0,Channel 19975)

Frequency Stability under Temperature

Temperature Interval (°C)	Test Frequency (MHz)	Deviation (Hz)	Limit(Hz)
-30	1712.5	-41.78	±4281.25
-20	1712.5	-40.88	±4281.25
-10	1712.5	-40.24	±4281.25
0	1712.5	-39.16	±4281.25
10	1712.5	-34.92	±4281.25
20	1712.5	-37.46	±4281.25
30	1712.5	-41.89	±4281.25
40	1712.5	-43.56	±4281.25
50	1712.5	-45.77	±4281.25

Frequency Stability under Voltage

DC Voltage (V)	Test Frequency (MHz)	Deviation (Hz)	Limit(Hz)
8	1712.5	-42.58	±4281.25
12	1712.5	-36.48	±4281.25
24	1712.5	-38.77	±4281.25
32	1712.5	-46.87	±4281.25

LTE Band 4 (16-QAM, Band Width 5MHz,RB Size 1,RB Offset 0,Channel 19975)

Frequency Stability under Temperature

Temperature Interval (°C)	Test Frequency (MHz)	Deviation (Hz)	Limit(Hz)
-30	1712.5	-45.68	±4281.25
-20	1712.5	-43.58	±4281.25
-10	1712.5	-42.26	±4281.25
0	1712.5	-39.93	±4281.25
10	1712.5	-36.84	±4281.25
20	1712.5	-34.24	±4281.25
30	1712.5	-38.56	±4281.25
40	1712.5	-40.77	±4281.25
50	1712.5	-42.84	±4281.25

Frequency Stability under Voltage

DC Voltage (V)	Test Frequency (MHz)	Deviation (Hz)	Limit(Hz)
8	1712.5	-44.76	±4281.25

12	1712.5	-37.59	±4281.25
24	1712.5	-38.42	±4281.25
32	1712.5	-42.79	±4281.25

LTE Band 4(QPSK, Band Width 10MHz, RB Size 1, RB Offset 49, Channel 20350)

Frequency Stability under Temperature

Temperature Interval (°C)	Test Frequency (MHz)	Deviation (Hz)	Limit(Hz)
-30	1750.0	-40.89	±4375.00
-20	1750.0	-38.81	±4375.00
-10	1750.0	-39.75	±4375.00
0	1750.0	-38.44	±4375.00
10	1750.0	-37.67	±4375.00
20	1750.0	-38.22	±4375.00
30	1750.0	-39.94	±4375.00
40	1750.0	-41.34	±4375.00
50	1750.0	-44.42	±4375.00

Frequency Stability under Voltage

DC Voltage (V)	Test Frequency (MHz)	Deviation (Hz)	Limit(Hz)
8	1750.0	-39.45	±4375.00
12	1750.0	-36.66	±4375.00
24	1750.0	-38.88	±4375.00
32	1750.0	-40.25	±4375.00

LTE Band 4(16-QAM, Band Width 10MHz, RB Size 1, RB Offset 0, Channel 20000)

Frequency Stability under Temperature

Temperature Interval (°C)	Test Frequency (MHz)	Deviation (Hz)	Limit(Hz)
-30	1715.0	-44.24	±4287.50
-20	1715.0	-42.46	±4287.50
-10	1715.0	-41.34	±4287.50
0	1715.0	-39.75	±4287.50
10	1715.0	-37.59	±4287.50
20	1715.0	-37.48	±4287.50
30	1715.0	-38.79	±4287.50
40	1715.0	-40.56	±4287.50
50	1715.0	-41.96	±4287.50

Frequency Stability under Voltage

DC Voltage (V)	Test Frequency (MHz)	Deviation (Hz)	Limit(Hz)
8	1715.0	-41.69	± 4287.50
12	1715.0	-38.58	± 4287.50
24	1715.0	-37.07	± 4287.50
32	1715.0	-41.59	± 4287.50

LTE Band 13(QPSK, Band Width 5MHz, RB Size 1, RB Offset 0, Channel 23230)

Frequency Stability under Temperature

Temperature Interval (°C)	Test Frequency (MHz)	Deviation (Hz)	Limit(Hz)
-30	782.0	-4.47	± 1955.00
-20	782.0	-3.17	± 1955.00
-10	782.0	-2.46	± 1955.00
0	782.0	-0.89	± 1955.00
10	782.0	0.26	± 1955.00
20	782.0	-0.54	± 1955.00
30	782.0	2.57	± 1955.00
40	782.0	-3.67	± 1955.00
50	782.0	-4.26	± 1955.00

Frequency Stability under Voltage

DC Voltage (V)	Test Frequency (MHz)	Deviation (Hz)	Limit(Hz)
8	782.0	-3.46	± 1955.00
12	782.0	-1.56	± 1955.00
24	782.0	-2.23	± 1955.00
32	782.0	-4.25	± 1955.00

LTE Band 13(16-QAM, Band Width 5MHz, RB Size 1, RB Offset 0, Channel 23205)

Frequency Stability under Temperature

Temperature Interval (°C)	Test Frequency (MHz)	Deviation (Hz)	Limit(Hz)
-30	779.5	-4.56	± 1948.75
-20	779.5	-3.59	± 1948.75
-10	779.5	-2.57	± 1948.75
0	779.5	-0.89	± 1948.75
10	779.5	0.57	± 1948.75
20	779.5	1.32	± 1948.75
30	779.5	-2.46	± 1948.75
40	779.5	-3.57	± 1948.75
50	779.5	-3.98	± 1948.75

Frequency Stability under Voltage

DC Voltage (V)	Test Frequency (MHz)	Deviation (Hz)	Limit(Hz)
8	779.5	-5.46	± 1948.75
12	779.5	-1.74	± 1948.75
24	779.5	-1.38	± 1948.75
32	779.5	-3.86	± 1948.75

LTE Band 13(QPSK, Band Width 10MHz, RB Size 1, RB Offset 0, Channel 23230)

Frequency Stability under Temperature

Temperature Interval (°C)	Test Frequency (MHz)	Deviation (Hz)	Limit(Hz)
-30	782.0	3.85	± 1955.00
-20	782.0	2.47	± 1955.00
-10	782.0	1.69	± 1955.00
0	782.0	0.68	± 1955.00
10	782.0	-0.48	± 1955.00
20	782.0	-0.92	± 1955.00
30	782.0	-2.43	± 1955.00
40	782.0	3.86	± 1955.00
50	782.0	4.28	± 1955.00

Frequency Stability under Voltage

DC Voltage (V)	Test Frequency (MHz)	Deviation (Hz)	Limit(Hz)
8	782.0	3.12	± 1955.00
12	782.0	1.57	± 1955.00
24	782.0	0.86	± 1955.00
32	782.0	3.19	± 1955.00

LTE Band 13(16-QAM, Band Width 10MHz, RB Size 1, RB Offset 0, Channel 23230)

Frequency Stability under Temperature

Temperature Interval (°C)	Test Frequency (MHz)	Deviation (Hz)	Limit(Hz)
-30	782.0	3.40	± 1955.00
-20	782.0	3.12	± 1955.00
-10	782.0	2.89	± 1955.00
0	782.0	2.13	± 1955.00
10	782.0	1.87	± 1955.00
20	782.0	0.84	± 1955.00
30	782.0	1.88	± 1955.00

40	782.0	2.14	± 1955.00
50	782.0	2.84	± 1955.00

Frequency Stability under Voltage

DC Voltage (V)	Test Frequency (MHz)	Deviation (Hz)	Limit(Hz)
8	782.0	2.58	± 1955.00
12	782.0	1.65	± 1955.00
24	782.0	1.80	± 1955.00
32	782.0	2.35	± 1955.00

24V DC:

LTE Band 4(QPSK, Band Width 5MHz, RB Size1, RB Offset 24, Channel 20375)

Frequency Stability under Temperature

Temperature Interval (°C)	Test Frequency (MHz)	Deviation (Hz)	Limit(Hz)
-30	1752.5	-46.26	± 4381.25
-20	1752.5	-44.26	± 4381.25
-10	1752.5	-43.24	± 4381.25
0	1752.5	-40.33	± 4381.25
10	1752.5	-38.85	± 4381.25
20	1752.5	-39.12	± 4381.25
30	1752.5	-41.34	± 4381.25
40	1752.5	-43.45	± 4381.25
50	1752.5	-46.88	± 4381.25

Frequency Stability under Voltage

DC Voltage (V)	Test Frequency (MHz)	Deviation (Hz)	Limit(Hz)
8	1752.5	-45.24	± 4381.25
12	1752.5	-40.34	± 4381.25
24	1752.5	-41.21	± 4381.25
32	1752.5	-44.77	± 4381.25

LTE Band 4(16-QAM, Band Width 5MHz, RB Size1, RB Offset 24, Channel 20375)

Frequency Stability under Temperature

Temperature Interval (°C)	Test Frequency (MHz)	Deviation (Hz)	Limit(Hz)
-30	1752.5	-43.89	± 4381.25
-20	1752.5	-42.79	± 4381.25
-10	1752.5	-43.67	± 4381.25
0	1752.5	-39.12	± 4381.25

10	1752.5	-38.65	±4381.25
20	1752.5	-35.93	±4381.25
30	1752.5	-39.30	±4381.25
40	1752.5	-41.30	±4381.25
50	1752.5	-42.90	±4381.25

Frequency Stability under Voltage

DC Voltage (V)	Test Frequency (MHz)	Deviation (Hz)	Limit(Hz)
8	1752.5	-40.34	±4381.25
12	1752.5	-37.86	±4381.25
24	1752.5	-39.07	±4381.25
32	1752.5	-42.78	±4381.25

LTE Band 4(QPSK, Band Width 10MHz, RB Size1, RB Offset 0, Channel 20000)

Frequency Stability under Temperature

Temperature Interval (°C)	Test Frequency (MHz)	Deviation (Hz)	Limit(Hz)
-30	1715.0	-47.23	±4287.50
-20	1715.0	-46.43	±4287.50
-10	1715.0	-45.24	±4287.50
0	1715.0	-39.83	±4287.50
10	1715.0	-41.45	±4287.50
20	1715.0	-42.34	±4287.50
30	1715.0	-43.13	±4287.50
40	1715.0	-44.67	±4287.50
50	1715.0	-45.93	±4287.50

Frequency Stability under Voltage

DC Voltage (V)	Test Frequency (MHz)	Deviation (Hz)	Limit(Hz)
8	1715.0	-44.24	±4287.50
12	1715.0	-40.69	±4287.50
24	1715.0	-39.74	±4287.50
32	1715.0	-43.57	±4287.50

LTE Band 4(16-QAM, Band Width 10MHz, RB Size1, RB Offset 0, Channel 20000)

Frequency Stability under Temperature

Temperature Interval (°C)	Test Frequency (MHz)	Deviation (Hz)	Limit(Hz)
-30	1715.0	-41.31	±4287.50
-20	1715.0	-40.41	±4287.50

-10	1715.0	-39.68	±4287.50
0	1715.0	-37.12	±4287.50
10	1715.0	-36.94	±4287.50
20	1715.0	-39.11	±4287.50
30	1715.0	-40.54	±4287.50
40	1715.0	-41.46	±4287.50
50	1715.0	-42.03	±4287.50

Frequency Stability under Voltage

DC Voltage (V)	Test Frequency (MHz)	Deviation (Hz)	Limit(Hz)
8	1715.0	-39.56	±4287.50
12	1715.0	-36.23	±4287.50
24	1715.0	-37.95	±4287.50
32	1715.0	-40.11	±4287.50

LTE Band 13(QPSK, Band Width 5MHz, RB Size1, RB Offset 0, Channel 23230)

Frequency Stability under Temperature

Temperature Interval (°C)	Test Frequency (MHz)	Deviation (Hz)	Limit(Hz)
-30	782.0	-5.24	±1955.00
-20	782.0	-3.54	±1955.00
-10	782.0	-2.86	±1955.00
0	782.0	-1.57	±1955.00
10	782.0	-0.46	±1955.00
20	782.0	0.27	±1955.00
30	782.0	-3.13	±1955.00
40	782.0	-4.32	±1955.00
50	782.0	-6.12	±1955.00

Frequency Stability under Voltage

DC Voltage (V)	Test Frequency (MHz)	Deviation (Hz)	Limit(Hz)
8	782.0	-4.13	±1955.00
12	782.0	-1.43	±1955.00
24	782.0	-0.79	±1955.00
32	782.0	-3.87	±1955.00

LTE Band 13(16-QAM, Band Width 5MHz, RB Size1, RB Offset 24, Channel 23230)

Frequency Stability under Temperature

Temperature Interval (°C)	Test Frequency (MHz)	Deviation (Hz)	Limit(Hz)
---------------------------	----------------------	----------------	-----------

-30	782.0	-3.89	± 1955.00
-20	782.0	-2.89	± 1955.00
-10	782.0	-2.35	± 1955.00
0	782.0	-1.85	± 1955.00
10	782.0	-0.86	± 1955.00
20	782.0	-0.09	± 1955.00
30	782.0	-2.56	± 1955.00
40	782.0	-2.98	± 1955.00
50	782.0	-4.25	± 1955.00

Frequency Stability under Voltage

DC Voltage (V)	Test Frequency (MHz)	Deviation (Hz)	Limit(Hz)
8	782.0	-2.89	± 1955.00
12	782.0	0.64	± 1955.00
24	782.0	-1.12	± 1955.00
32	782.0	-3.18	± 1955.00

LTE Band 13(QPSK, Band Width 10MHz,RB Size1,RB Offset 0,Channel 23230)

Frequency Stability under Temperature

Temperature Interval (°C)	Test Frequency (MHz)	Deviation (Hz)	Limit(Hz)
-30	782.0	-6.53	± 1955.00
-20	782.0	-4.58	± 1955.00
-10	782.0	-3.75	± 1955.00
0	782.0	-2.83	± 1955.00
10	782.0	-0.67	± 1955.00
20	782.0	1.23	± 1955.00
30	782.0	2.34	± 1955.00
40	782.0	-2.78	± 1955.00
50	782.0	-5.36	± 1955.00

Frequency Stability under Voltage

DC Voltage (V)	Test Frequency (MHz)	Deviation (Hz)	Limit(Hz)
8	782.0	-3.12	± 1955.00
12	782.0	-1.78	± 1955.00
24	782.0	-1.29	± 1955.00
32	782.0	-2.68	± 1955.00

LTE Band 13(16-QAM, Band Width 10MHz,RB Size1,RB Offset 0,Channel 23230)

Frequency Stability under Temperature

Temperature Interval (°C)	Test Frequency (MHz)	Deviation (Hz)	Limit(Hz)
-30	782.0	2.21	± 1955.00
-20	782.0	1.89	± 1955.00
-10	782.0	2.03	± 1955.00
0	782.0	1.12	± 1955.00
10	782.0	0.13	± 1955.00
20	782.0	-0.02	± 1955.00
30	782.0	0.24	± 1955.00
40	782.0	1.65	± 1955.00
50	782.0	2.02	± 1955.00

Frequency Stability under Voltage

DC Voltage (V)	Test Frequency (MHz)	Deviation (Hz)	Limit(Hz)
8	782.0	1.35	± 1955.00
12	782.0	0.58	± 1955.00
24	782.0	0.43	± 1955.00
32	782.0	1.92	± 1955.00

8. Peak to Average

8.1. Test Equipment

Instrument	Manufacturer	Model	Serial No.	Cali. Due Date
SpectrumAnalyzer	Agilent	N9038A	MY51210142	11/05/2016
Radio Communication Tester	R&S	CMW500	147483	11/08/2016
SignalGenerator	Agilent	N5183A	MY50140938	01/04/2016
Preamplifier	CEM	EM30180	3008A0245	02/27/2016
DC Power Supply	Agilent	6612C	MY43002989	03/02/2016

8.2. Test Setup

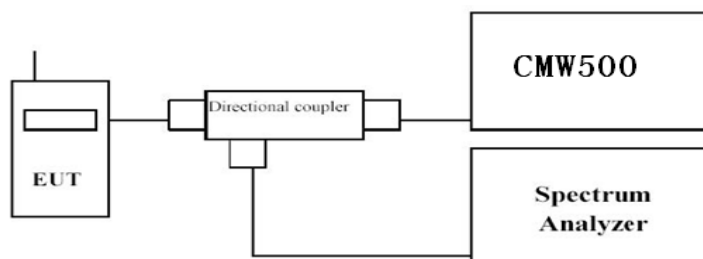

8.3. Limit

In addition, the transmitter's peak-to-average power ratio (PAPR) shall not exceed 13 dB for more than 0.1% of the time using a signal corresponding to the highest PAPR during periods of continuous transmission.

8.4. Test Procedure

A peak to average ratio measurement is performed at the conducted port of the EUT. For LTE signals, the spectrum analyzers Complementary Cumulative Distribution Function (CCDF) measurement profile is used to determine the largest deviation between the average and the peak power of the EUT in a given bandwidth. The CCDF curve shows how much time the peak waveform spends at or above a given average power level. The percent of time the signal spends at or above the level defines the probability for that particular power level.

Procedure:

1. The testing follows FCC KDB 971168 v02v02 Section 5.7.1;
2. Place the EUT on a bench and set it in transmitting mode.
3. Connect a low loss RF cable from the antenna port to a spectrum analyzer and CMW500 by a Directional Coupler.
4. EUT Communicate with CMW500, then select a channel for testing.
5. Add a correction factor to the display of spectrum, and then test.
6. Set resolution/measurement bandwidth \geq signal's occupied bandwidth;

8.5. Uncertainty

The measurement uncertainty is defined as ± 1.2 dB.

8.6. Test Result

DC 12V:

Band	Band Width (MHz)	Channel	Frequency (MHz)	Modulation	RB Configuration		Test Result	Limit (dB)
					RB Size	RB Offset		
LTE Band 4	5	19975	1712.5	QPSK	1	0	1.97	<13
		19975	1712.5	16-QAM	1	0	2.24	
		20175	1732.5	QPSK	1	0	2.06	
		20175	1732.5	16-QAM	1	0	2.38	
		20375	1752.5	QPSK	1	24	1.95	
		20375	1752.5	16-QAM	8	17	2.58	
	10	20000	1715.0	QPSK	1	49	1.28	
		20000	1715.0	16-QAM	1	0	1.77	
		20175	1732.5	QPSK	1	0	1.39	
		20175	1732.5	16-QAM	1	0	1.51	
		20350	1750.0	QPSK	1	49	1.30	
		20350	1750.0	16-QAM	1	49	1.40	
LTE Band 13	5	23205	779.5	QPSK	1	0	1.98	
		23205	779.5	16-QAM	1	0	2.36	
		23230	782.0	QPSK	1	0	2.08	
		23230	782.0	16-QAM	1	24	2.42	
		23255	784.5	QPSK	1	0	1.94	
		23255	784.5	16-QAM	1	0	1.99	
	10	23230	782.0	QPSK	1	0	1.88	
		23230	782.0	16-QAM	1	0	1.80	

LTE Band 4(QPSK, Band Width 5MHz, RB Size1, RB Offset 0, Channel 19975)



LTE Band 4(16-QAM, Band Width 5MHz, RB Size1, RB Offset 0, Channel 19975)



LTE Band 4(QPSK, Band Width 5MHz, RB Size1, RB Offset 0, Channel 20175)



LTE Band 4(16-QAM, Band Width 5MHz, RB Size1, RB Offset 0, Channel 20175)



LTE Band 4(QPSK, Band Width 5MHz, RB Size1, RB Offset 24, Channel 20375)

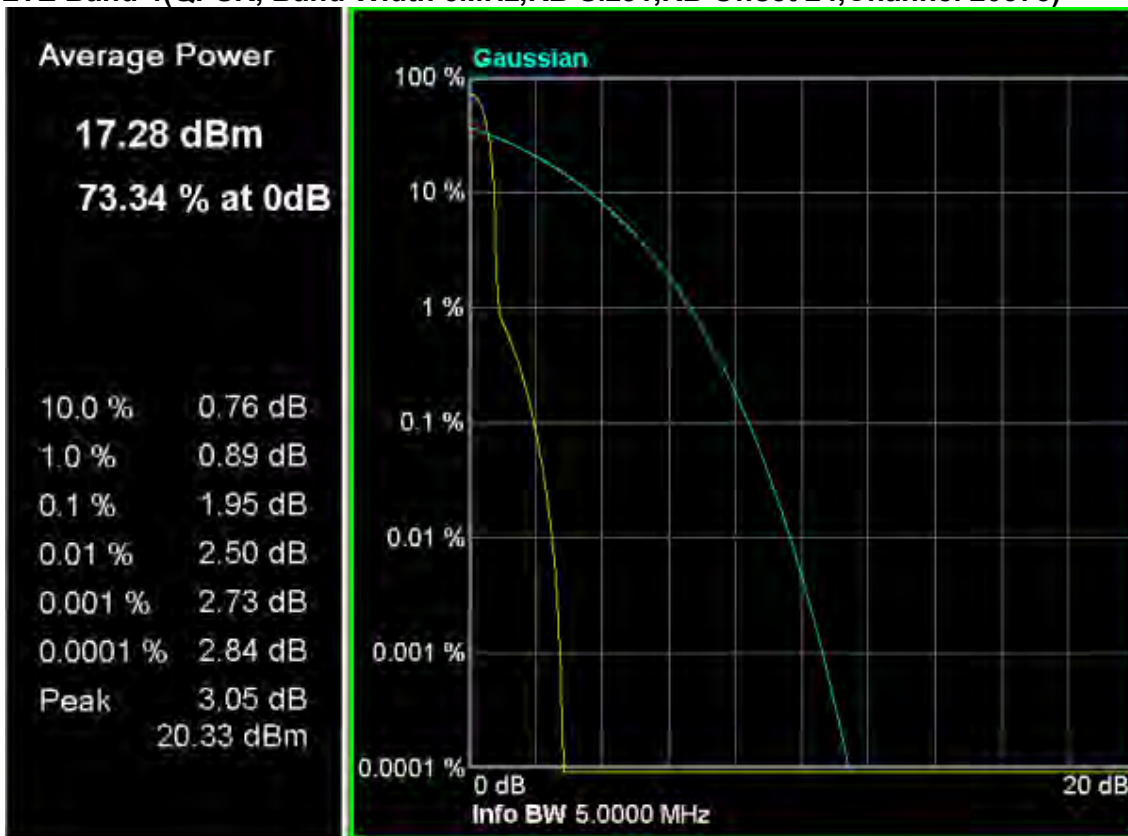

LTE Band 4(16-QAM, Band Width 5MHz, RB Size8, RB Offset 17, Channel 20375)



LTE Band 4(QPSK, Band Width 10MHz, RB Size1, RB Offset 49, Channel 20000)



LTE Band 4(16-QAM, Band Width 10MHz, RB Size8, RB Offset 17, Channel 20000)



LTE Band 4(QPSK, Band Width 10MHz, RB Size1, RB Offset 0, Channel 20175)



LTE Band 4(16-QAM, Band Width 10MHz, RB Size1, RB Offset 0, Channel 20175)

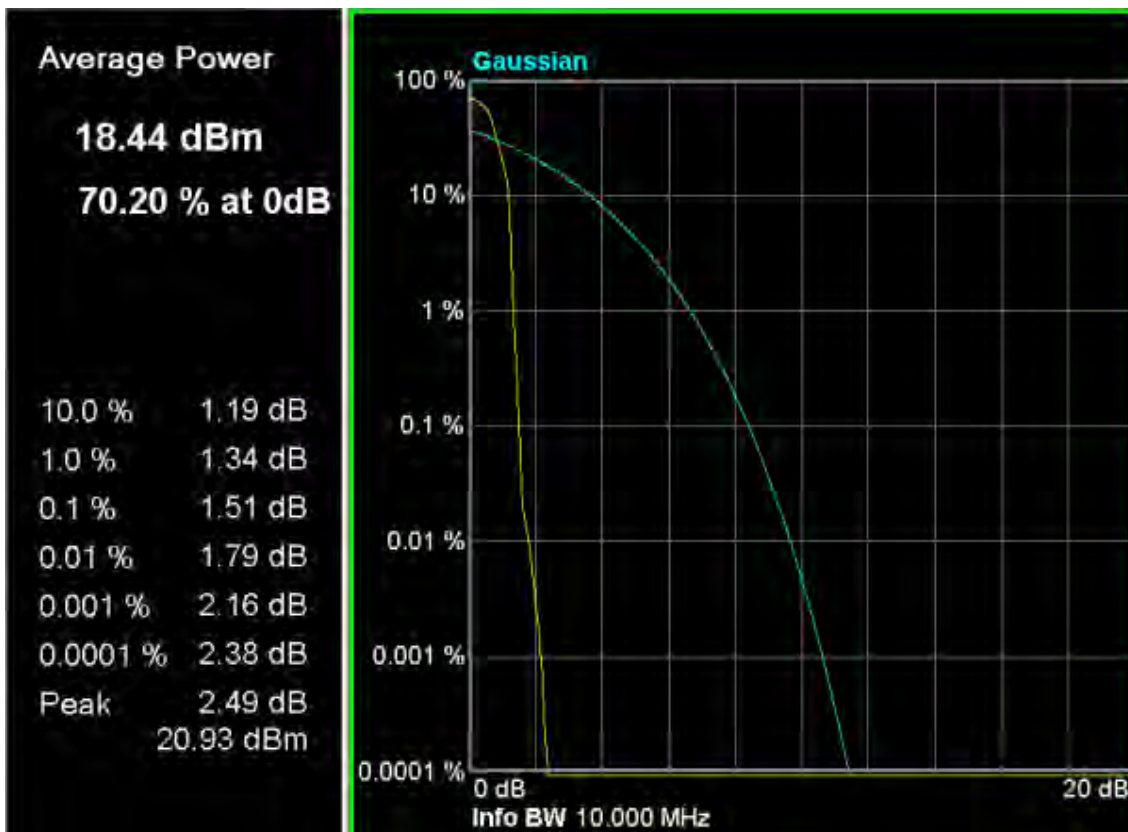

LTE Band 4(QPSK, Band Width 10MHz, RB Size1, RB Offset 49, Channel 20375)



LTE Band 4(16-QAM, Band Width 10MHz, RB Size1, RB Offset 49, Channel 20375)



LTE Band 13(QPSK, Band Width 5MHz, RB Size1, RB Offset 0, Channel 23205)

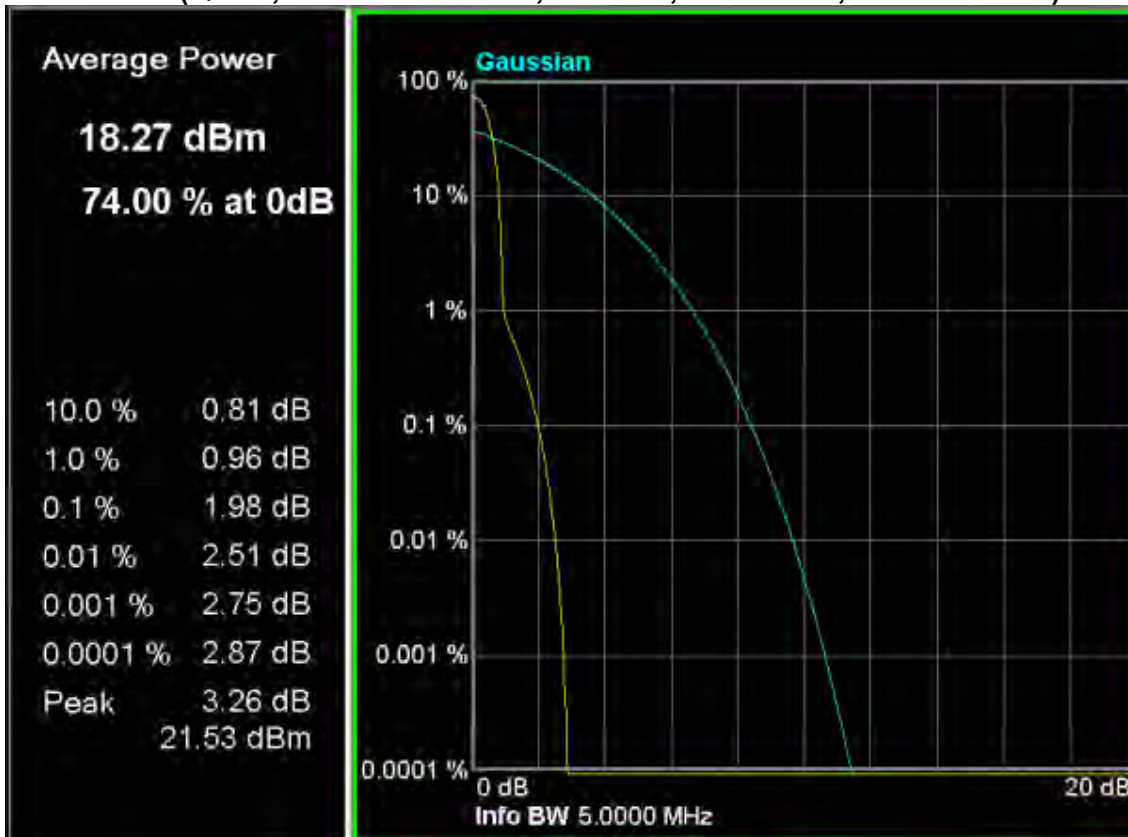

LTE Band 13(16-QAM, Band Width 5MHz, RB Size1, RB Offset 0, Channel 23205)



LTE Band 13(QPSK, Band Width 5MHz, RB Size1, RB Offset 0, Channel 23230)

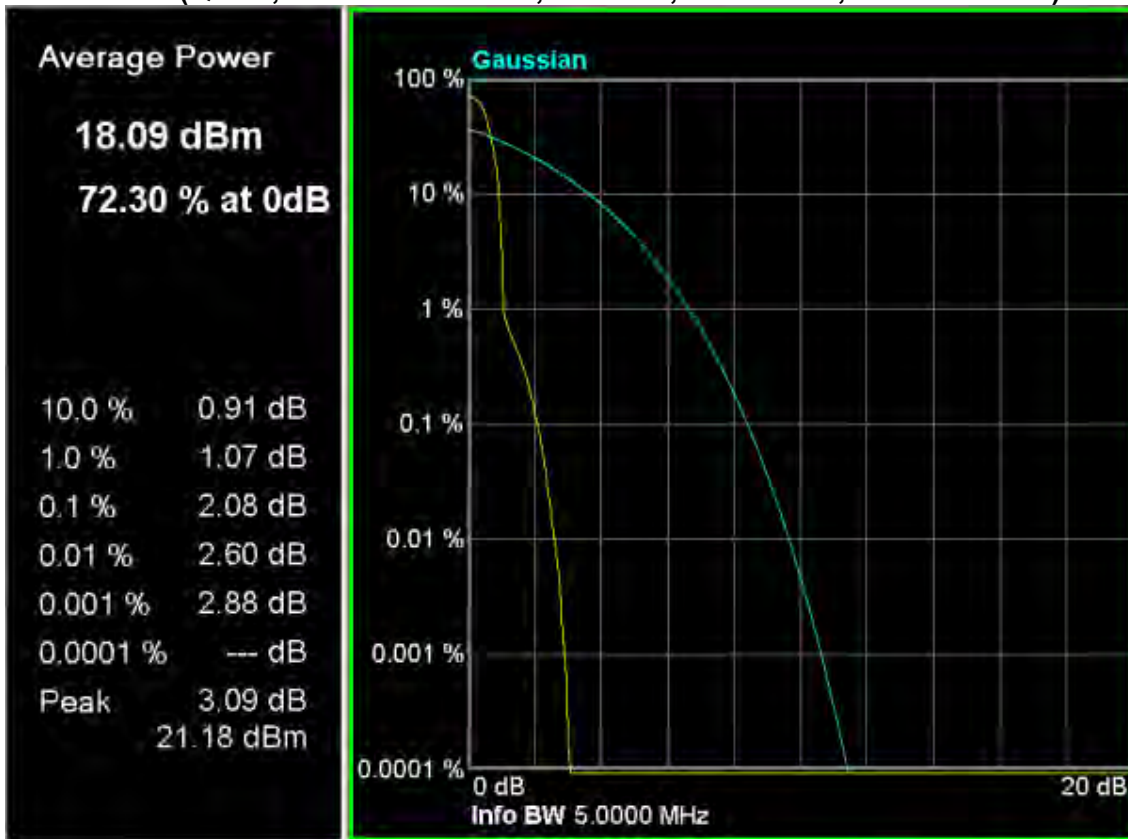

LTE Band 13(16-QAM, Band Width 5MHz, RB Size1, RB Offset 24, Channel 23230)



LTE Band 13(QPSK, Band Width 5MHz, RB Size1, RB Offset 0, Channel 23255)



LTE Band 13(16-QAM, Band Width 5MHz, RB Size1, RB Offset 0, Channel 23255)



LTE Band 13(QPSK, Band Width 10MHz, RB Size1, RB Offset 0, Channel 23230)



LTE Band 13(16-QAM, Band Width 10MHz, RB Size1, RB Offset 0, Channel 23230)



DC 24V:

Band	Band Width (MHz)	Channel	Frequency (MHz)	Modulation	RB Configuration		Test Result	Limit (dB)
					RB Size	RB Offset		
LTE Band 4	5	19975	1712.5	QPSK	1	0	1.98	< 13
		19975	1712.5	16-QAM	8	17	1.82	
		20175	1732.5	QPSK	8	17	2.23	
		20175	1732.5	16-QAM	8	17	2.45	
		20375	1752.5	QPSK	1	24	1.95	
		20375	1752.5	16-QAM	1	24	2.29	
	10	20000	1715.0	QPSK	1	0	1.40	
		20000	1715.0	16-QAM	1	0	1.92	
		20175	1732.5	QPSK	1	0	1.46	
		20175	1732.5	16-QAM	1	0	1.53	
		20350	1750.0	QPSK	1	49	1.30	
		20350	1750.0	16-QAM	1	49	1.40	
LTE Band 13	5	23205	779.5	QPSK	1	0	1.98	
		23205	779.5	16-QAM	8	17	2.54	
		23230	782.0	QPSK	1	0	1.99	
		23230	782.0	16-QAM	1	24	2.20	
		23255	784.5	QPSK	1	0	2.00	
		23255	784.5	16-QAM	1	0	2.36	
	10	23230	782.0	QPSK	1	0	1.35	
		23230	782.0	16-QAM	1	0	1.48	

LTE Band 4(QPSK, Band Width 5MHz,RB Size1,RB Offset 0,Channel 19975)



LTE Band 4(16-QAM, Band Width 5MHz, RB Size 8, RB Offset 17, Channel 19975)

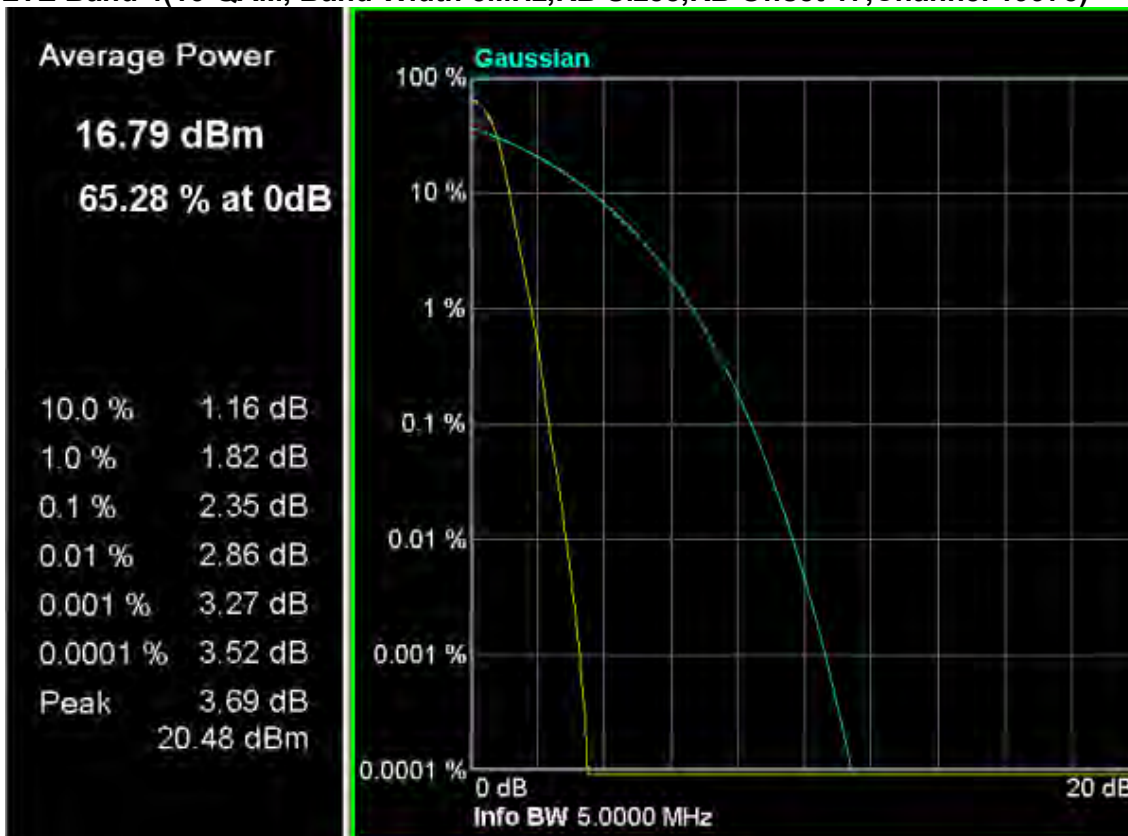

LTE Band 4(QPSK, Band Width 5MHz, RB Size 8, RB Offset 17, Channel 20175)



LTE Band 4(16-QAM, Band Width 5MHz,RB Size8,RB Offset 17,Channel 20175)



LTE Band 4(QPSK, Band Width 5MHz,RB Size1,RB Offset 24,Channel 20375)



LTE Band 4(16-QAM, Band Width 5MHz, RB Size1, RB Offset 24, Channel 20375)



LTE Band 4(QPSK, Band Width 10MHz, RB Size1, RB Offset 0, Channel 20000)



LTE Band 4(16-QAM, Band Width 10MHz, RB Size1, RB Offset 0, Channel 20000)



LTE Band 4(QPSK, Band Width 10MHz, RB Size1, RB Offset 0, Channel 20175)



LTE Band 4(16-QAM, Band Width 10MHz, RB Size1, RB Offset 0, Channel 20175)

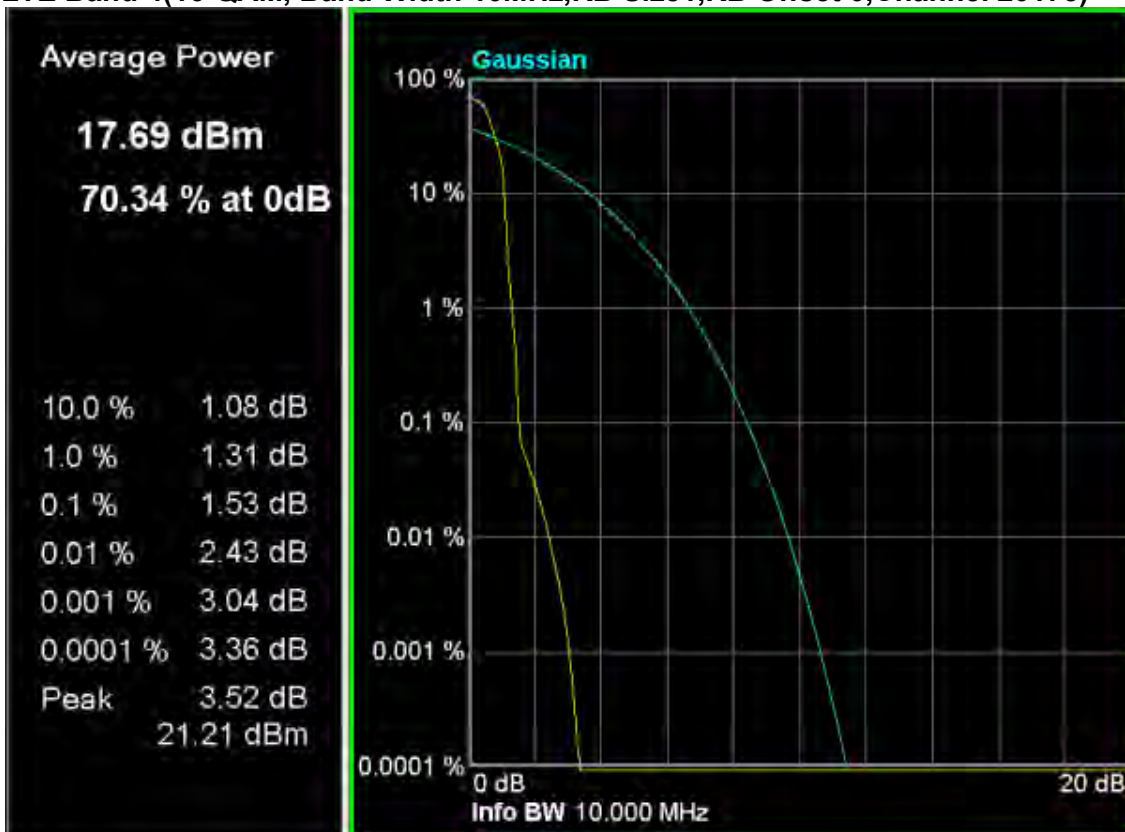

LTE Band 4(QPSK, Band Width 10MHz, RB Size1, RB Offset 49, Channel 20375)



LTE Band 4(16-QAM, Band Width 10MHz, RB Size1, RB Offset 49, Channel 20375)



LTE Band 13(QPSK, Band Width 5MHz, RB Size1, RB Offset 0, Channel 23205)



LTE Band 13(16-QAM, Band Width 5MHz, RB Size8, RB Offset 17, Channel 23205)



LTE Band 13(QPSK, Band Width 5MHz, RB Size1, RB Offset 0, Channel 23230)

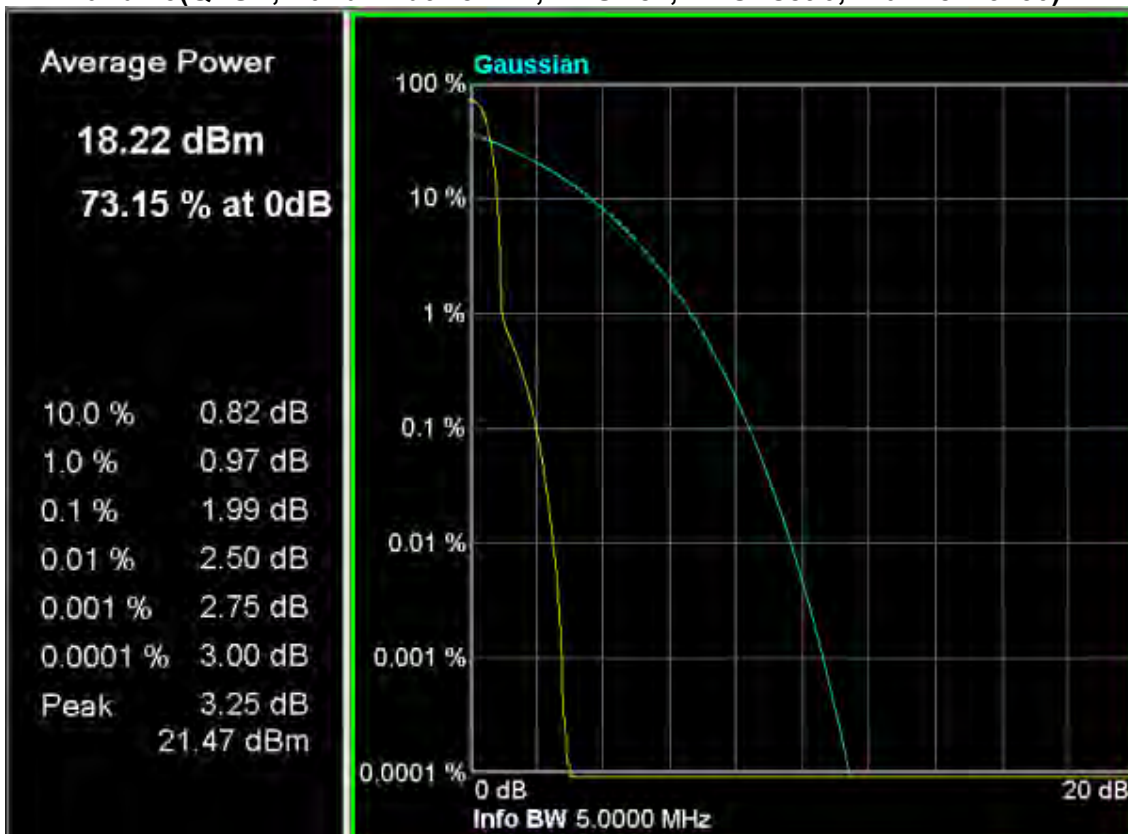

LTE Band 13(16-QAM, Band Width 5MHz, RB Size1, RB Offset 24, Channel 23230)



LTE Band 13(QPSK, Band Width 5MHz, RB Size1, RB Offset 0, Channel 23255)



LTE Band 13(16-QAM, Band Width 5MHz, RB Size1, RB Offset 0, Channel 23255)



LTE Band 13(QPSK, Band Width 10MHz, RB Size1, RB Offset 0, Channel 23230)



LTE Band 13(16-QAM, Band Width 10MHz, RB Size1, RB Offset 0, Channel 23230)

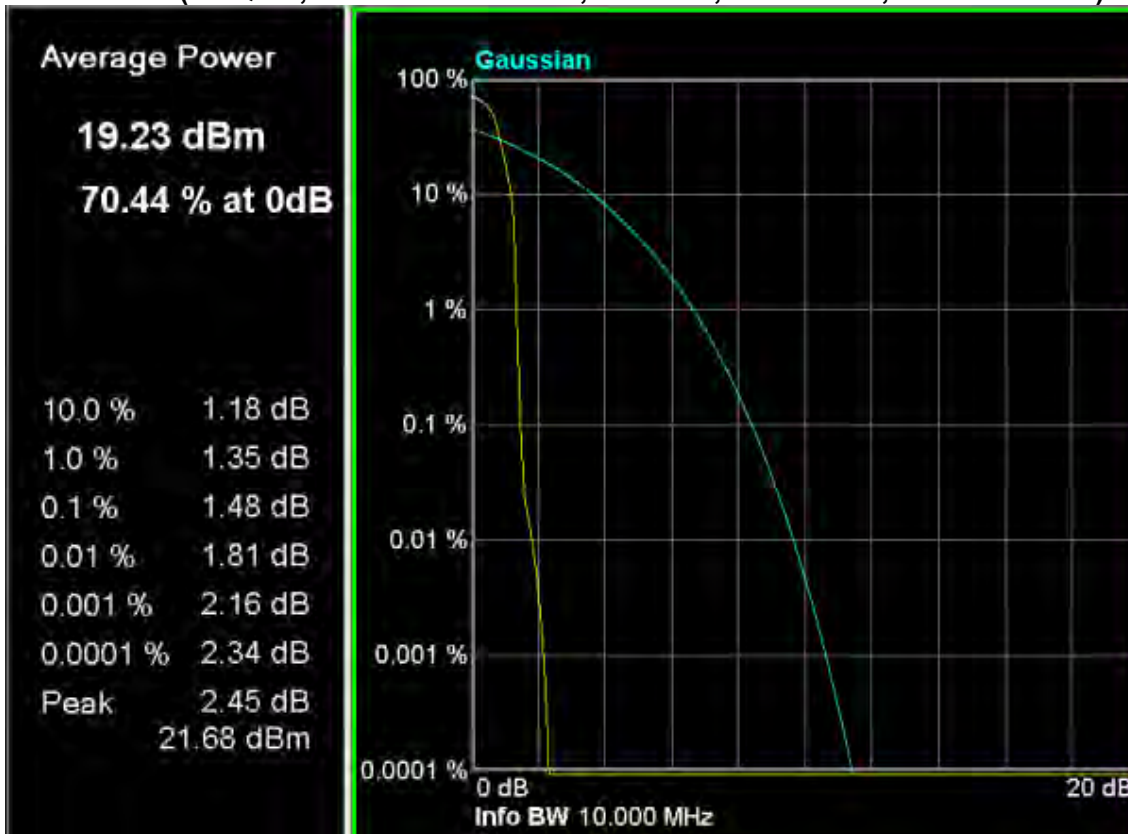

9.Attachment

PHOTOGRAPHS OF TEST SETUP

Please refer to the file named "RF Setup Photos".

PHOTOGRAPHS OF EUT

Please refer to the two files named "External Photos" and " Internal Photos" .

----End of the report----