



FCC Part22H&24E Test Report

Product Name : GPS Locator
Model No. : GV35
FCC ID : YQD-GV35

Applicant : Queclink Wireless Solutions Co., Ltd
Address : Room 501, Building 9, No 99, TianZhou Road,
Shanghai, China

Date of Receipt : 16/05/2012
Test Date : 16/05/2012~23/05/2012
Issued Date : 25/05/2012
Report No. : 125S045R-HP-US-P07V01
Report Version : V 1.1

The test results relate only to the samples tested.

The test results shown in the test report are traceable to the national/international standard through the calibration of the equipment and evaluated measurement uncertainty herein.

This report must not be used to claim product endorsement by TAF, CNAS or any agency of the Government.

The test report shall not be reproduced except in full without the written approval of QueTek Corporation.

Test Report Certification

Issued Date : 25/05/2012

Report No. : 125S045R-HP-US-P07V01



Product Name : GPS Locator
Applicant : Queclink Wireless Solutions Co., Ltd
Address : Room 501, Building 9, No 99, TianZhou Road, Shanghai,
China
Manufacturer : Queclink Wireless Solutions Co., Ltd
Address : Room 501, Building 9, No 99, TianZhou Road, Shanghai,
China
Model No. : GV35
FCC ID : YQD-GV35
EUT Voltage : 10-16V
Brand Name : Queclink
Applicable Standard : FCC CFR Title 47 Part 2, TIA/EIA 603-C
FCC Part22 Subpart H, FCC Part24 Subpart E
Test Result : Complied
Performed Location : Suzhou EMC Laboratory
No.99 Hongye Rd., Suzhou Industrial Park Loufeng Hi-Tech
Development Zone., Suzhou, China
TEL: +86-512-6251-5088 / FAX: +86-512-6251-5098
FCC Registration Number: 800392

Documented By : Alice Ni
(Engineering ADM: Alice Ni)
Reviewed By : Robin Wu
(Engineering Supervisor: Robin Wu)
Approved By : Marlin Chen
(Engineering Manager: Marlin Chen)

Laboratory Information

We, **Quietek Corporation**, are an independent EMC and safety consultancy that was established the whole facility in our laboratories. The test facility has been accredited/accepted(audited or listed) by the following related bodies in compliance with ISO 17025, EN 45001 and specified testing scope:

Taiwan R.O.C.	:	BSMI, NCC, TAF
Germany	:	TUV Rheinland
Norway	:	Nemko, DNV
USA	:	FCC, NVLAP
Japan	:	VCCI
China	:	CNAS

The related certificate for our laboratories about the test site and management system can be downloaded from Quietek Corporation's Web Site : <http://www.quietek.com/tw/ctg/cts/accreditations.htm>

The address and introduction of Quietek Corporation's laboratories can be founded in our Web site : <http://www.quietek.com/>

If you have any comments, Please don't hesitate to contact us. Our contact information is as below:

HsinChu Testing Laboratory :

No.75-2, 3rd Lin, Wangye Keng, Yongxing Tsuen, Qionglin Shiang, Hsinchu County 307, Taiwan, R.O.C.
 TEL:+886-3-592-8858 / FAX:+886-3-592-8859 E-Mail : service@quietek.com

LinKou Testing Laboratory :

No.5-22, Ruishukeng, Linkou Dist., New Taipei City 24451, Taiwan, R.O.C.
 TEL : 886-2-8601-3788 / FAX : 886-2-8601-3789 E-Mail : service@quietek.com

Suzhou Testing Laboratory :

No.99 Hongye Rd., Suzhou Industrial Park Loufeng Hi-Tech Development Zone., SuZhou, China
 TEL : +86-512-6251-5088 / FAX : 86-512-6251-5098 E-Mail : service@quietek.com

TABLE OF CONTENTS

Description	Page
1. General Information.....	6
1.1. EUT Description	6
1.2. Mode of Operation.....	7
1.3. Tested System Details	8
1.4. Configuration of Tested System.....	9
1.5. EUT Exercise Software.....	10
2. Technical Test.....	11
2.1. Summary of Test Result.....	11
2.2. Test Environment.....	12
3. Peak Output Power	13
3.1. Test Equipment.....	13
3.2. Test Setup.....	14
3.3. Limit.....	14
3.4. Test Procedure	15
3.5. Uncertainty	16
3.6. Test Result.....	17
3.7. Test Photograph	19
4. Modulation Characteristic	21
4.1. Test Equipment.....	21
4.2. Test Setup.....	21
4.3. Limit.....	22
4.4. Test Procedure	22
4.5. Uncertainty	22
4.6. Test Result.....	23
5. Occupied Bandwidth.....	24
5.1. Test Equipment.....	24
5.2. Test Setup.....	24
5.3. Limit.....	25
5.4. Test Procedure	25
5.5. Uncertainty	25
5.6. Test Result.....	26
6. Spurious Emission At Antenna Terminals (+/- 1MHz).....	30
6.1. Test Equipment.....	30
6.2. Test Setup.....	30
6.3. Limit.....	31
6.4. Test Procedure	31

6.5. Uncertainty	31
6.6. Test Result.....	32
7. Spurious Emission	34
7.1. Test Equipment.....	34
7.2. Test Setup.....	35
7.3. Limit.....	36
7.4. Test Procedure	36
7.5. Uncertainty	37
7.6. Test Result.....	38
7.7. Test Photograph	50
8. Frequency Stability Under Temperature & Voltage Variations.....	52
8.1. Test Equipment.....	52
8.2. Test Setup.....	52
8.3. Limit.....	53
8.4. Test Procedure	53
8.5. Uncertainty	53
8.6. Test Result.....	54
9. Attachment	56
EUT Photograph.....	56

1. General Information

1.1. EUT Description

Product Name	GPS Locator
Model No.	GV35
RF Exposure Environment	Uncontrolled
Hardware Version	1.02
Software Version	NMX
GPS	
Operate Frequency	1575.42MHz
Type of modulation	BPSK
2G	
Support Band	GSM850/PCS1900
GPRS Type	Class B
GPRS Class	Class 10
Uplink	GSM 850: 824~849MHz PCS 1900: 1850~1910MHz
Downlink	GSM 850: 869~894MHz PCS 1900: 1930~1990MHz
Release Version	R99
Type of modulation	GMSK
Antenna type	Internal
Antenna Gain	-2.9dBi for GSM 850 2.2dBi for PCS 1900 1.8dBi for GPS

1.2. Mode of Operation

Quietek has verified the construction and function in typical operation. All the test modes were carried out with the EUT in normal operation, which was shown in this test report and defined as:

Test Mode
Mode 1: GPRS 850 Link
Mode 2: GPRS 1900 Link

Note:

1. Regards to the frequency band operation: the lowest, middle and highest frequency of channel were selected to perform the test, then shown on this report.
2. For the ERP/EIRP and radiated emission test, every axis (X, Y, Z) was verified, and show the worst result on this report.

1.3. Tested System Details

The types for all equipments, plus descriptions of all cables used in the tested system (including inserted cards) are:

Product		Manufacturer	Model No.	Serial No.	Power Cord
1	CMU200	R&S	CMU200	N/A	N/A

1.4. Configuration of Tested System

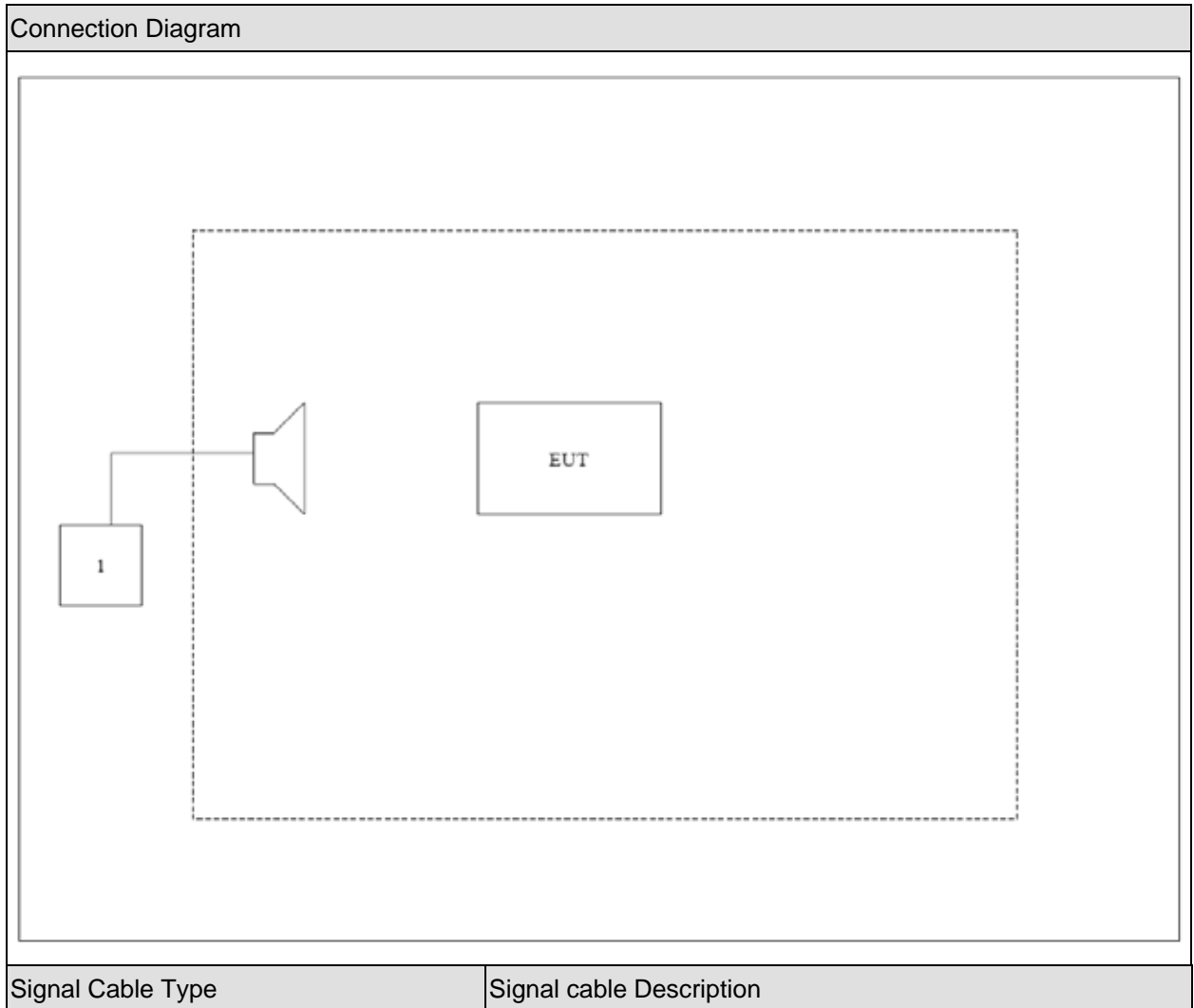

1.5. EUT Exercise Software

1	Setup the EUT and simulators as shown on above.
2	Turn on the power of all equipment.
3	EUT Communicate with CMU200, then select channel to test.

2. Technical Test

2.1. Summary of Test Result

- No deviations from the test standards
- Deviations from the test standards as below description:

For GSM 850 (FCC Part 22H & Part 2)

Performed Item	Section in CFR 47	Test Performed	Deviation
Peak Output Power	FCC Part 22.913(a)(2) and Part 2.1046	Yes	No
Modulation Characteristic	FCC Part 2.1047(d)	Yes	No
Occupied Bandwidth	FCC Part 2.1049	Yes	No
Spurious Emission At Antenna Terminals (+/- 1MHz)	FCC Part 22.917(a) and Part 2.1049	Yes	No
Spurious Emission	FCC Part 22.917(b) and Part 2.1051, 2.1053	Yes	No
Frequency Stability Under Temperature & Voltage Variations	FCC Part 22.355 and 2.1055	Yes	No

For PCS 1900 (FCC Part 24E & Part 2)

Performed Item	Section in CFR 47	Test Performed	Deviation
Peak Output Power	FCC Part 24.232(b) and Part 2.1046	Yes	No
Modulation Characteristic	FCC Part 2.1047(d)	Yes	No
Occupied Bandwidth	FCC Part 24.238(b) and Part 2.1049	Yes	No
Spurious Emission At Antenna Terminals (+/- 1MHz)	FCC Part 24.238(a) and Part 2.1049	Yes	No
Spurious Emission	FCC Part 24.238(b) and Part 2.1051, 2.1053	Yes	No
Frequency Stability Under Temperature & Voltage Variations	FCC Part 24.235 and 2.1055	Yes	No

2.2. Test Environment

Items	Required (IEC 68-1)	Actual
Temperature (°C)	15-35	23
Humidity (%RH)	25-75	52
Barometric pressure (mbar)	860-1060	950-1000

3. Peak Output Power

3.1. Test Equipment

Peak Output Power / AC-5

Instrument	Manufacturer	Type No.	Serial No	Cali. Due Date
PSA Series Spectrum Analyzer	Agilent	E4440A	MY49420184	2013.04.10
Radio Communication Tester	R&S	CMU 200	117088	2013.04.18
Dual Directional Coupler	Agilent	778D	20160	2013.04.18
10dB Coaxial Coupler	Agilent	87300C	MY44300299	2013.04.18
PSG Analog Signal Generator	Agilent	E8257D	MY44321116	2013.04.18
Preamplifier	QuieTek	AP-025C	CHM-0503006	2013.05.04
Preamplifier	Miteq	NSP1800-25	1364185	2013.05.04
Bilog Antenna	Teseq GmbH	CBL6112D	27612	2012.10.18
Half Wave Tuned Dipole Antenna	COM-POWER	AD-100	40137	2013.11.24
Broad-Band Horn Antenna	Schwarzbeck	BBHA9120D	737	2013.11.24
Broad-Band Horn Antenna	Schwarzbeck	BBHA9120D	499	2012.06.11
Temperature/Humidity Meter	Zhicheng	ZC1-2	AC5-TH	2013.01.10

3.2. Test Setup

Conducted Power Measurement:

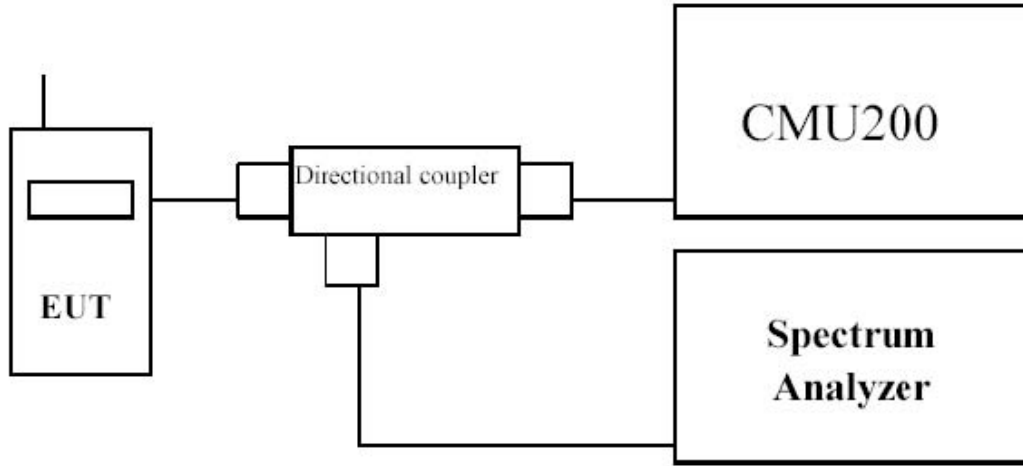

Radiated Power Measurement:

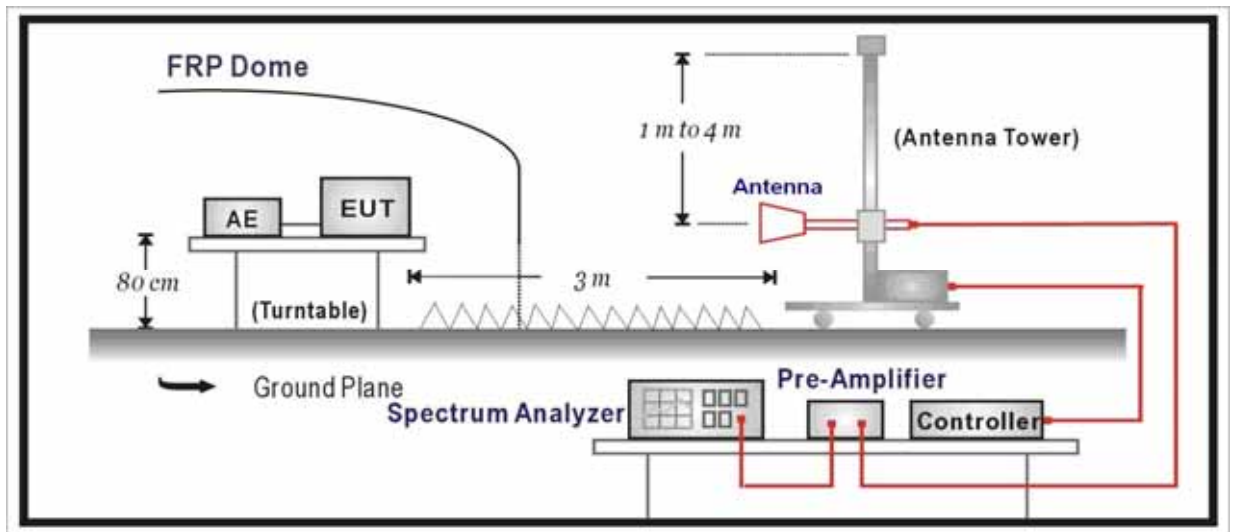

3.3. Limit

For FCC Part 22.913(a)(2):

The ERP of mobile transmitters and auxiliary test transmitters must not exceed 7 Watts.

For FCC Part 24.232(b):

The EIRP of mobile transmitters and auxiliary test transmitters must not exceed 2 Watts.

3.4. Test Procedure

Conducted Power Measurement:

- a) Place the EUT on a bench and set it in transmitting mode.
- b) Connect a low loss RF cable from the antenna port to a spectrum analyzer and CMU200 by a Directional Couple.
- c) EUT Communicate with CMU200, then selects a channel for testing.
- d) Add a correction factor to the display of spectrum, and then test.

Radiated Power Measurement:

- e) The EUT shall be placed at the specified height on a support, and in the position closest to normal use as declared by provider.
- f) The test antenna shall be oriented initially for vertical polarization and shall be chosen to correspond to the frequency of the transmitter
- g) The output of the test antenna shall be connected to the measuring receiver.
- h) The transmitter shall be switched on and the measuring receiver shall be tuned to the frequency of the transmitter under test.
- i) The test antenna shall be raised and lowered through the specified range of height until a maximum signal level is detected by the measuring receiver.
- j) The transmitter shall then be rotated through 360° in the horizontal plane, until the maximum signal level is detected by the measuring receiver.
- k) The test antenna shall be raised and lowered again through the specified range of height until a maximum signal level is detected by the measuring receiver.
- l) The maximum signal level detected by the measuring receiver shall be noted.
- m) The transmitter shall be replaced by a substitution antenna.
- n) The substitution antenna shall be orientated for vertical polarization and the length of the substitution antenna shall be adjusted to correspond to the frequency of the transmitter.
- o) The substitution antenna shall be connected to a calibrated signal generator.
- p) If necessary, the input attenuator setting of the measuring receiver shall be adjusted in order to increase the sensitivity of the measuring receiver.
- q) The test antenna shall be raised and lowered through the specified range of height to ensure that the maximum signal is received.
- r) The input signal to the substitution antenna shall be adjusted to the level that produces a level detected by the measuring receiver, that is equal to the level noted while the transmitter radiated power was measured, corrected for the change of input attenuator setting of the measuring receiver.
- s) The measurement shall be repeated with the test antenna and the substitution antenna orientated for horizontal polarization.

- t) The measure of the effective radiated power is the larger of the two levels recorded at the input to the substitution antenna, corrected for gain of the substitution antenna if necessary.
- u) Test site anechoic chamber refer to ANSI C63.4: 2009.

3.5. Uncertainty

The measurement uncertainty is defined as for Conducted Power Measurement ± 1.2 dB,
for Radiated Power Measurement ± 3.2 dB

3.6. Test Result

GPRS 850

Channel No.	Frequency (MHz)	Modulation	Conducted Power (dBm)	ERP (dBm)	Limit (dBm)
128	824.2	GMSK	32.88	29.26	38.50
189	836.4	GMSK	32.95	28.88	38.50
251	848.8	GMSK	32.96	30.06	38.50

GPRS1900

Channel No.	Frequency (MHz)	Modulation	Conducted Power (dBm)	EIRP (dBm)	Limit (dBm)
512	1850.2	GMSK	30.41	32.40	33.00
661	1880.0	GMSK	30.44	32.59	33.00
810	1909.8	GMSK	30.45	31.58	33.00

Radiated Measurement

GPRS 850

Frequency (MHz)	SA Reading (dBm)	Ant. Pol. (H/V)	SG Reading (dBm)	Cable Loss (dB)	Gain (dBd)	ERP (dBm)	Limit (dBm)	Margin (dB)
Low Channel 128 (824.20MHz)								
824.2	-12.31	H	21.44	1.76	-0.02	19.66	38.50	-18.84
824.2	-3.45	V	31.04	1.76	-0.02	29.26	38.50	-9.24
Middle Channel 189 (836.40MHz)								
836.4	-13.20	H	20.69	1.75	0.10	19.04	38.50	-19.46
836.4	-4.23	V	30.53	1.75	0.10	28.88	38.50	-9.62
High Channel 251 (848.80MHz)								
848.8	-12.08	H	21.93	1.78	0.13	20.28	38.50	-18.22
848.8	-2.89	V	31.71	1.78	0.13	30.06	38.50	-8.44

GPRS1900

Frequency (MHz)	SA Reading (dBm)	Ant. Pol. (H/V)	SG Reading (dBm)	Cable Loss (dB)	Gain (dBi)	EIRP (dBm)	Limit (dBm)	Margin (dB)
Low Channel 512 (1850.20MHz)								
1850.2	21.78	H	20.38	2.68	10.40	28.10	33.00	-4.90
1850.2	26.28	V	24.68	2.68	10.40	32.40	33.00	-0.60
Middle Channel 661 (1880.00MHz)								
1880.0	22.61	H	21.11	2.68	10.43	28.86	33.00	-4.14
1880.0	26.68	V	24.84	2.68	10.43	32.59	33.00	-0.41
High Channel 810 (1909.80MHz)								
1909.8	21.98	H	20.63	2.70	10.44	28.37	33.00	-4.63
1909.8	25.63	V	23.84	2.70	10.44	31.58	33.00	-1.42

3.7. Test Photograph

Description: ERP Test Setup



Description: Substitution Antenna for ERP Test

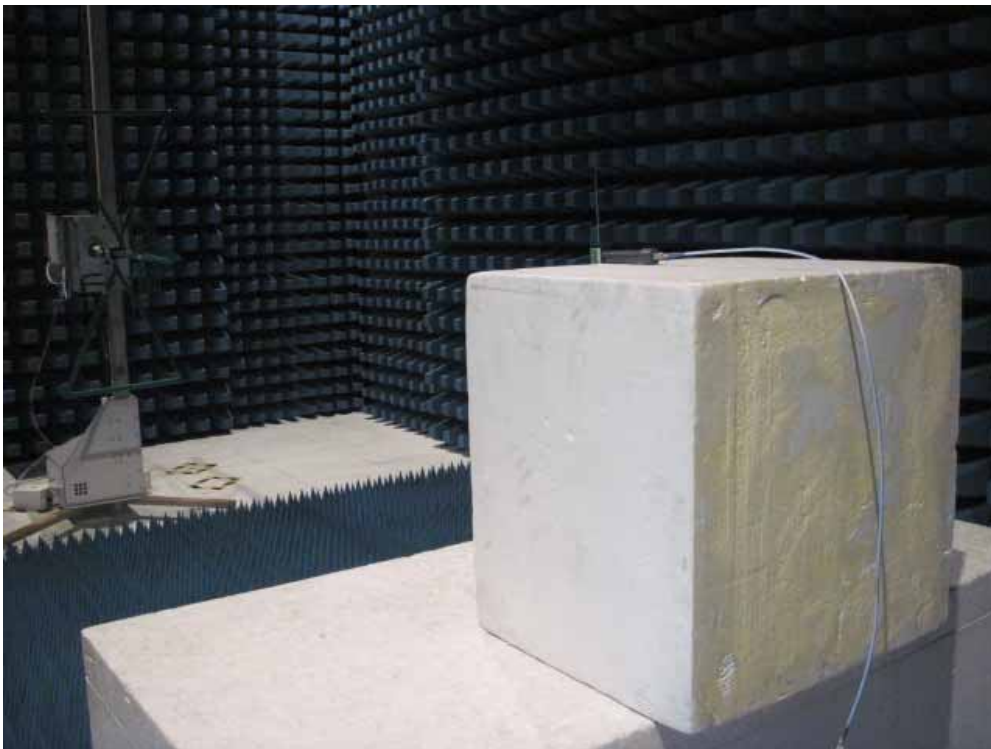

Description: EIRP Test Setup



Description: Substitution Antenna for EIRP Test



4. Modulation Characteristic

4.1. Test Equipment

Modulation Characteristic / AC-6

Instrument	Manufacturer	Type No.	Serial No	Cal. Date
PSA Series Spectrum Analyzer	Agilent	E4440A	MY49420184	2013.04.10
Radio Communication Tester	R&S	CMU 200	117088	2013.04.18
Dual Directional Coupler	Agilent	778D	20160	2013.04.18
10dB Coaxial Coupler	Agilent	87300C	MY44300299	2013.04.18
Temperature/Humidity Meter	Zhicheng	ZC1-2	AC6-TH	2013.01.10

4.2. Test Setup

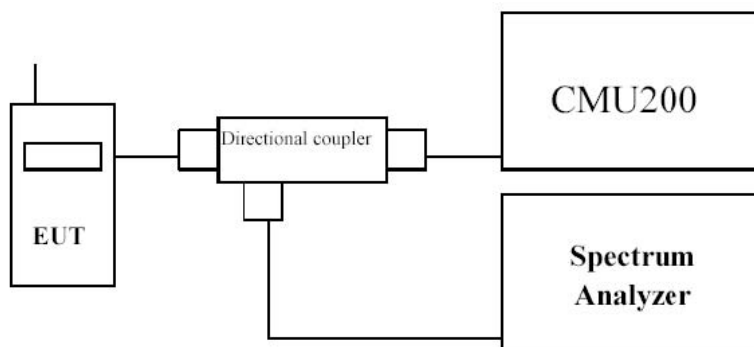

4.3. Limit

N/A

4.4. Test Procedure

GMSK is a form of binary signaling schemes which represent digital states as a shift between discrete sinusoidal frequencies called Frequency Shift Keying (FSK). Minimum Shift Keying (MSK) is continuous phase FSK with the smallest possible modulation index h . Modulation index is defined as: $h = 2 \cdot F \cdot T_b$

where F = Peak frequency deviation in Hz and T_b = Bit period in seconds

Two discrete frequencies, representing two distinct digital states, with equal phases at switch time $t = 0$ requires a minimum value of $h = 0.5$. The Gaussian part of GMSK describes the fact that the digital pulses are filtered in the time domain. This results in bits which are sinusoidal rather than square. The effective spectrum is then compressed with the average carrier frequency in the center of the passband. This is a great advantage because of the significantly reduced bandwidth. GMSK is utilized because of these bandwidth conservation properties.

The bandwidth for GSM is a 60 MHz up-link at 1850-1910 MHz and down-link at 1930-1990 MHz. The 65 MHz is divided into 299 channels, each of which is 200 kHz wide. Slight spectral spillage is allowed into neighboring channels (which is minimized by GMSK). This separated transmit/receive frequencies scheme under GSM enables easier duplex filtering.

Within the bandwidth, individual channels are subdivided into multiframe (made of 26 frames), frames (made of 8 time slots), and time slots (made of 8 fields). The time slots are 0.57 ms long allowing 156.25 bits of information including overhead.

The modulation used in GPRS is the same used in GSM. A GSM channel contains eight timeslots, each timeslot is dedicated to one circuit switched call. For GPRS the timeslots are assigned on an as needed basis, and more than one timeslot can be assigned for a particular transmission depending on the network and the device.

4.5. Uncertainty

The measurement uncertainty is defined as 0.1%

4.6. Test Result

The modulation of GSM/GPRS were verified and confirmed compliance with requirement.

5. Occupied Bandwidth

5.1. Test Equipment

Occupied Bandwidth / AC-6

Instrument	Manufacturer	Type No.	Serial No	Cali. Due Date
PSA Series Spectrum Analyzer	Agilent	E4440A	MY49420184	2013.04.10
Radio Communication Tester	R&S	CMU 200	117088	2013.04.18
Dual Directional Coupler	Agilent	778D	20160	2013.04.18
10dB Coaxial Coupler	Agilent	87300C	MY44300299	2013.04.18
Temperature/Humidity Meter	Zhicheng	ZC1-2	AC6-TH	2013.01.10

5.2. Test Setup

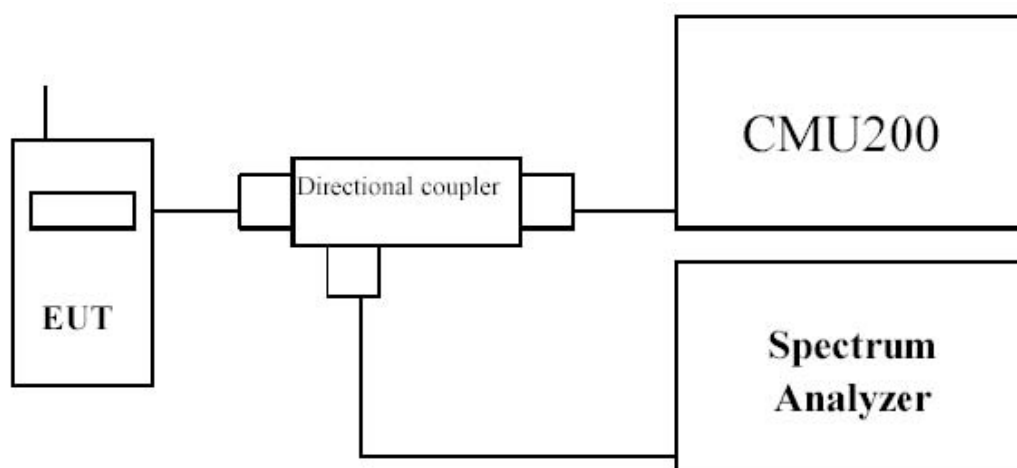

5.3. Limit

N/A

5.4. Test Procedure

Using Occupied Bandwidth measurement function of spectrum analyzer, and setting as follows:

For GSM 850/1900 test --- RBW = 3 kHz and VBW = 10 kHz

5.5. Uncertainty

The measurement uncertainty is defined as ± 10 Hz

5.6. Test Result

Product	GPS Locator		
Test Item	Occupied Bandwidth		
Test Mode	Mode 1: GPRS 850 Link		
Date of Test	2012/05/22	Test Site	AC-6

Channel No.	Frequency (MHz)	-26dB Occupied Bandwidth (kHz)	99% Occupied Bandwidth (kHz)
128	824.20	316.17	249.43
189	836.40	318.98	246.31
251	848.80	316.68	246.65

Figure Channel 128 (824.20MHz)

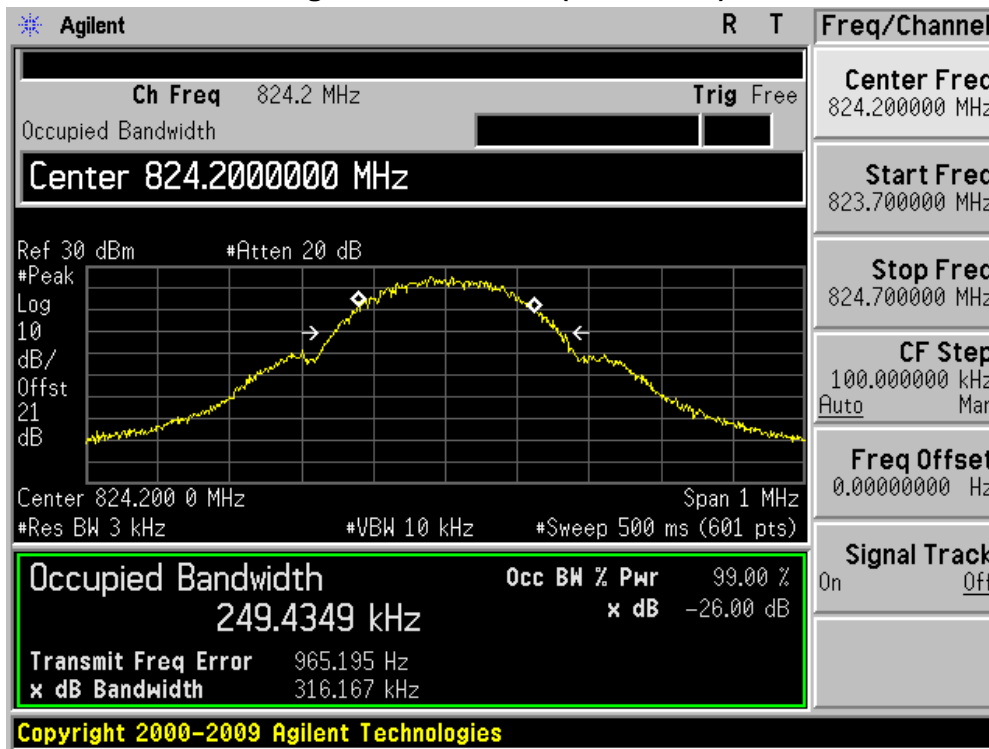

Figure Channel 189 (836.40MHz)

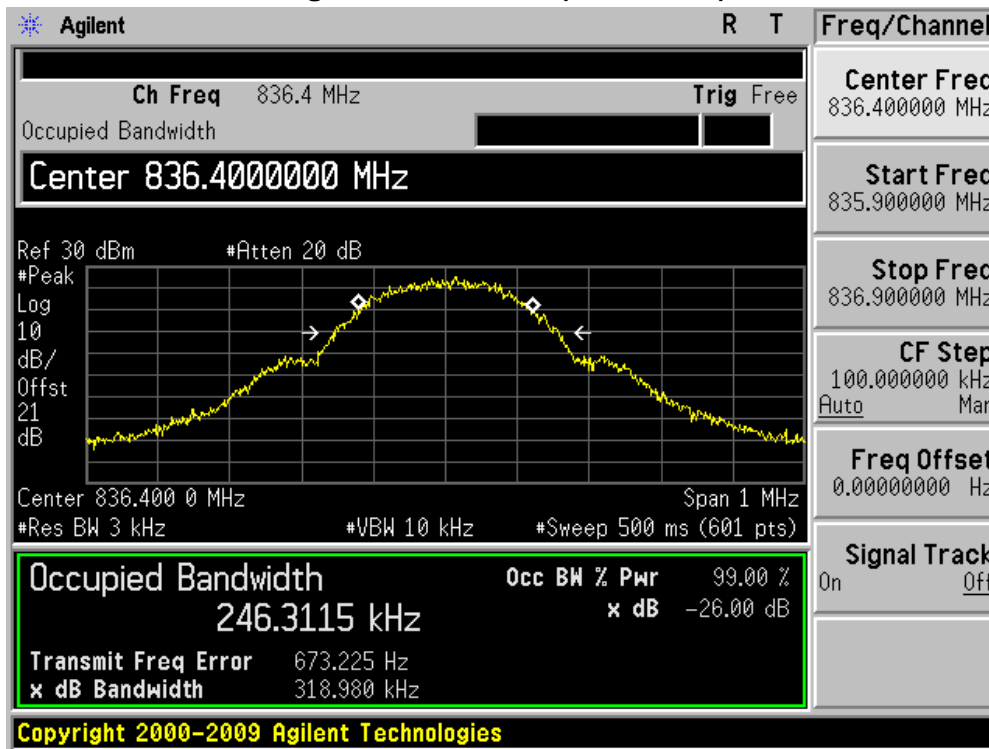
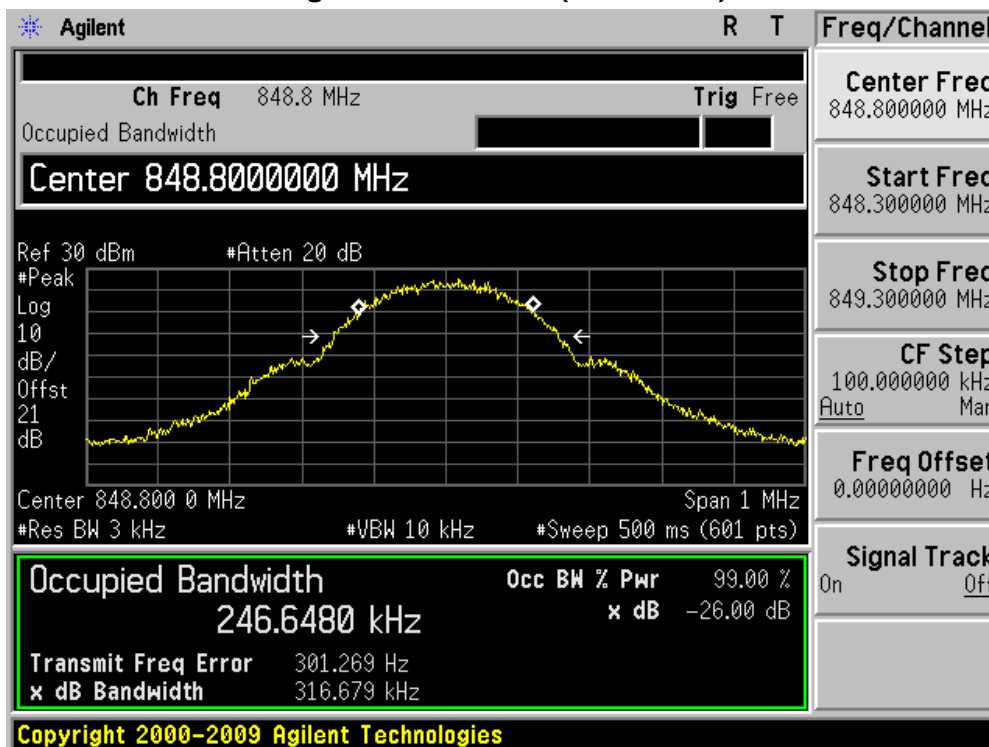

Figure Channel 251 (848.80MHz)



Product	GPS Locator		
Test Item	Occupied Bandwidth		
Test Mode	Mode 2: GPRS 1900 Link		
Date of Test	2012/05/22	Test Site	AC-6

Channel No.	Frequency (MHz)	-26dB Occupied Bandwidth (kHz)	99% Occupied Bandwidth (kHz)
512	1850.20	322.19	248.83
661	1880.00	320.76	246.48
810	1909.80	314.96	246.63

Figure Channel 512 (1850.20MHz)

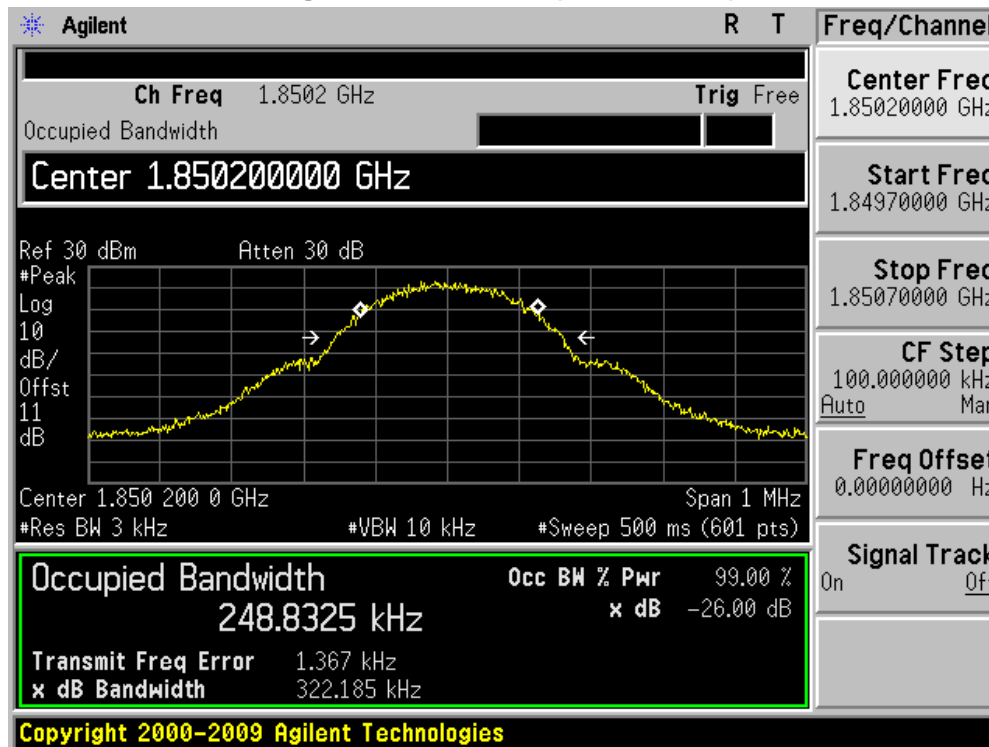

Figure Channel 661 (1880.00MHz)

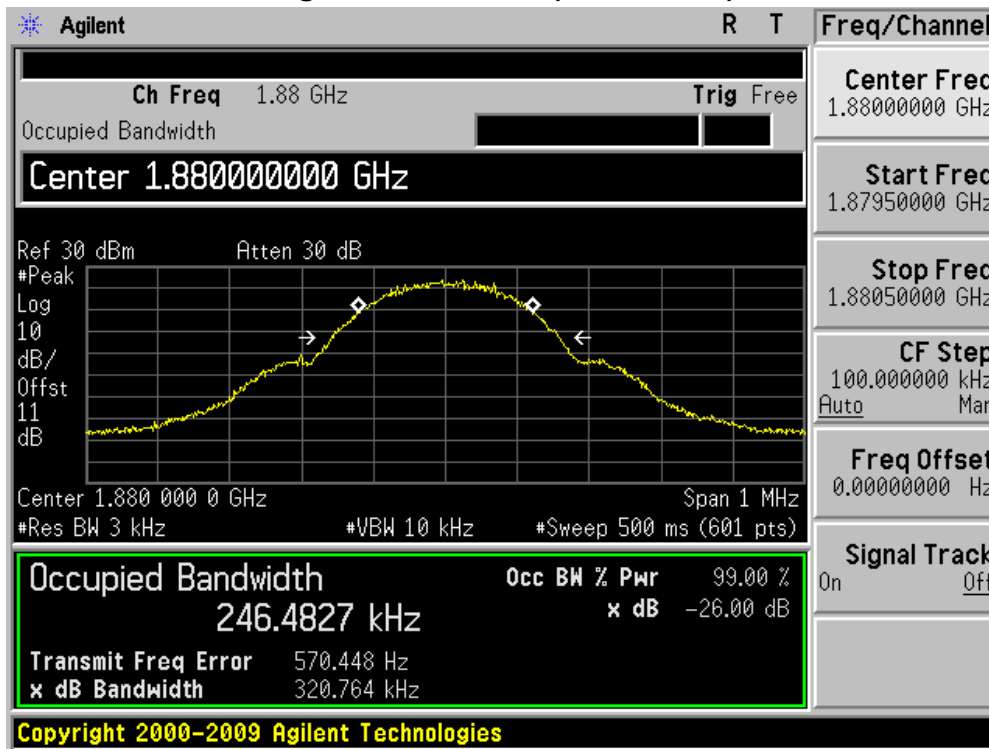
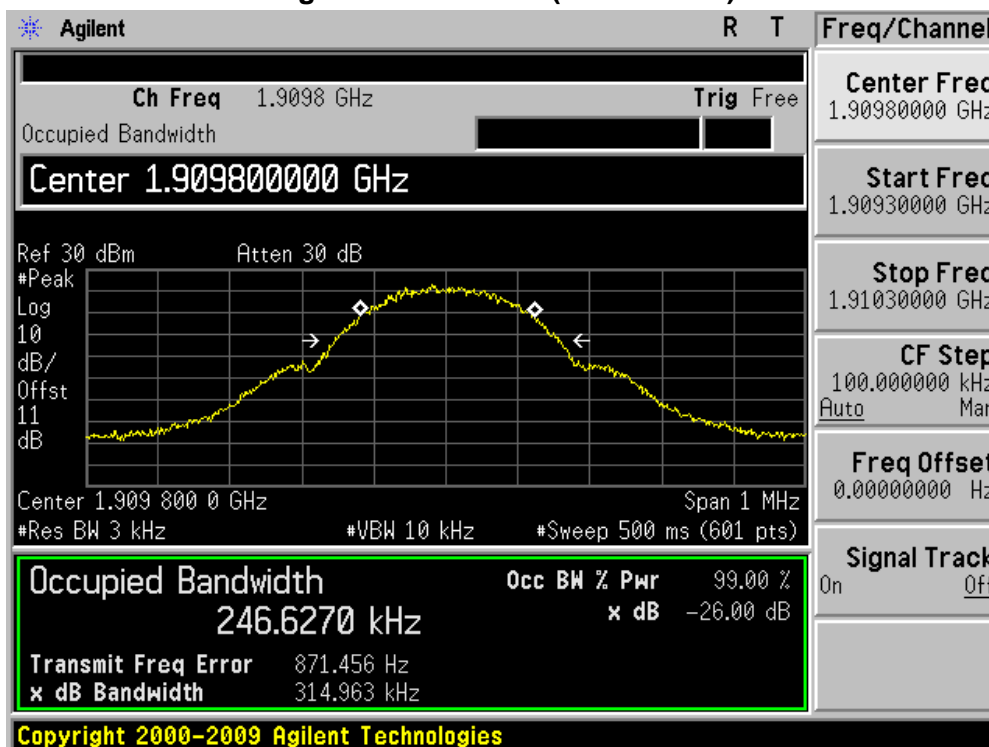

Figure Channel 810 (1909.80MHz)



6. Spurious Emission At Antenna Terminals (+/- 1MHz)

6.1. Test Equipment

Spurious Emission At Antenna Terminals (+/- 1MHz) / AC-6

Instrument	Manufacturer	Type No.	Serial No	Cali. Due Date
PSA Series Spectrum Analyzer	Agilent	E4440A	MY49420184	2013.04.10
Radio Communication Tester	R&S	CMU 200	117088	2013.04.18
Dual Directional Coupler	Agilent	778D	20160	2013.04.18
10dB Coaxial Coupler	Agilent	87300C	MY44300299	2013.04.18
Temperature/Humidity Meter	Zhicheng	ZC1-2	AC6-TH	2013.01.10

6.2. Test Setup

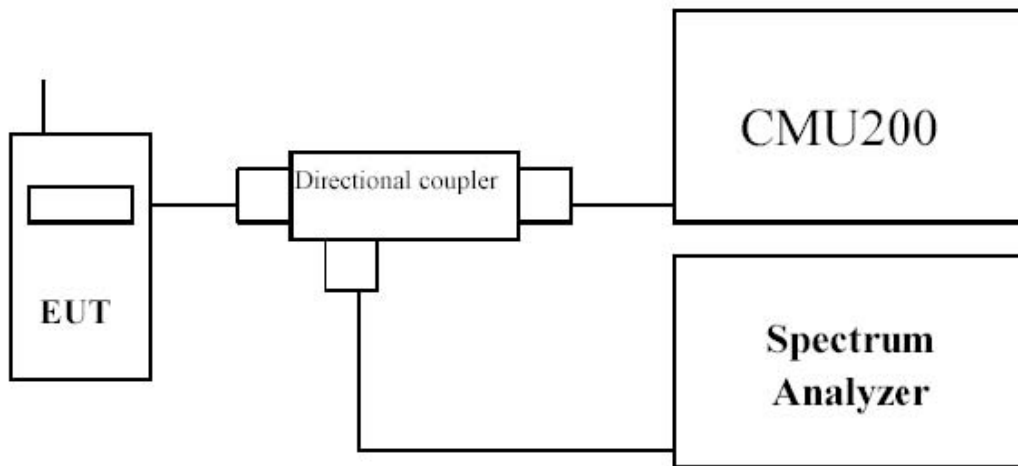

6.3. Limit

The power of any emission outside of the authorized operating frequency ranges must be attenuated below the transmitting power (P) by a factor of at least $43 + 10\log(P)$ dB.

6.4. Test Procedure

In the 1MHz bands immediately outside and adjacent to the frequency block a resolution bandwidth of at least one percent of the emission bandwidth of the fundamental emission of the transmitter may be employed to measure the out of band Emissions.

6.5. Uncertainty

The measurement uncertainty is defined as ± 1.2 dB.

6.6. Test Result

Product	GPS Locator		
Test Item	Spurious Emission At Antenna Terminals (+/- 1MHz)		
Test Mode	Mode 1: GPRS 850 Link		
Date of Test	2012/05/22	Test Site	AC-6

Figure Channel 128 (824.20MHz)

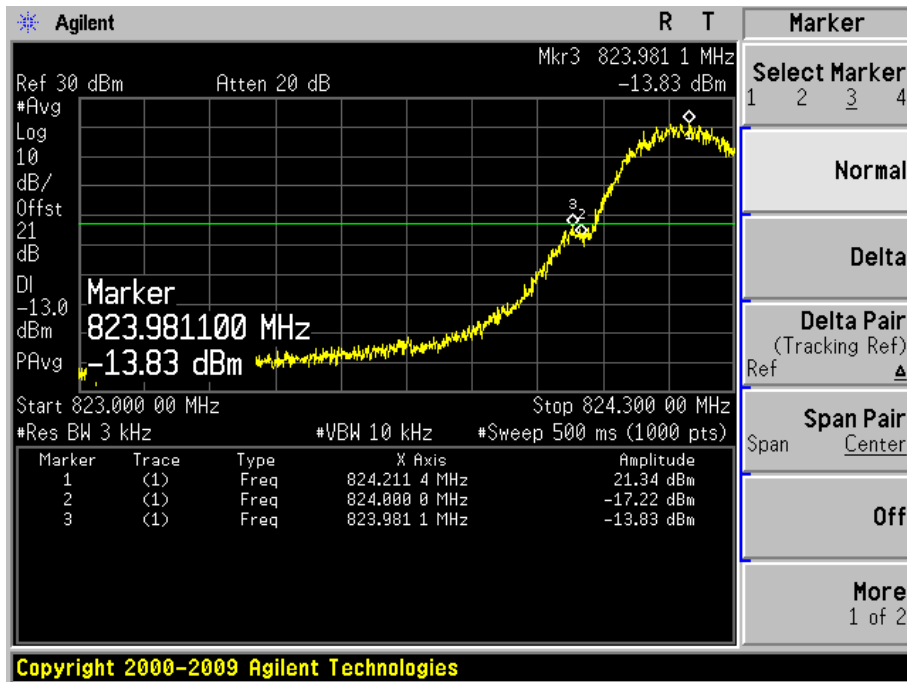
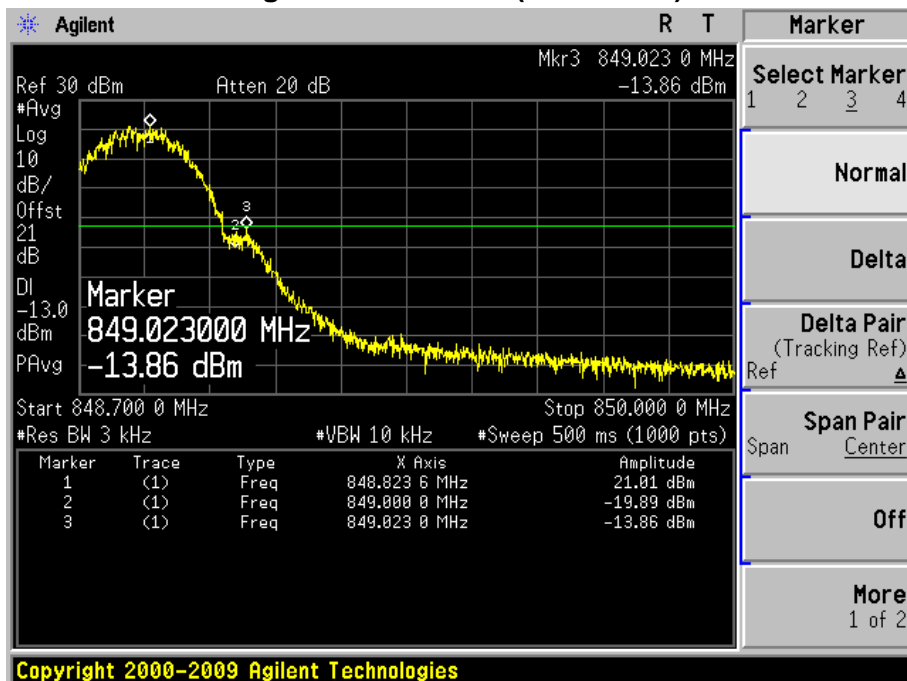

Figure Channel 251 (848.80MHz)



Product	GPS Locator		
Test Item	Spurious Emission At Antenna Terminals (+/- 1MHz)		
Test Mode	Mode 2: GPRS 1900 Link		
Date of Test	2012/05/22	Test Site	AC-6

Figure Channel 512 (1850.20MHz)

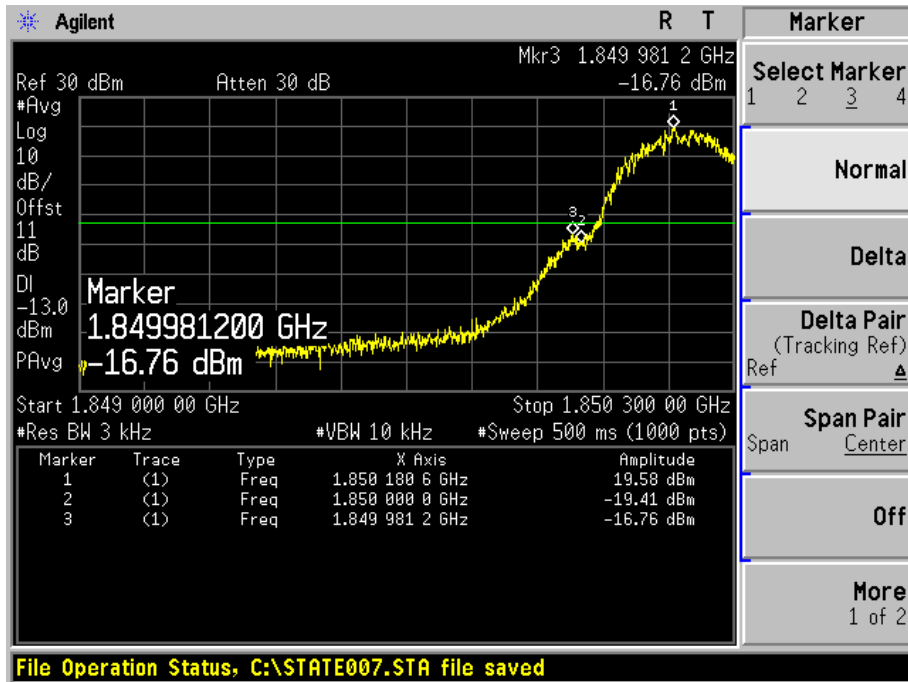
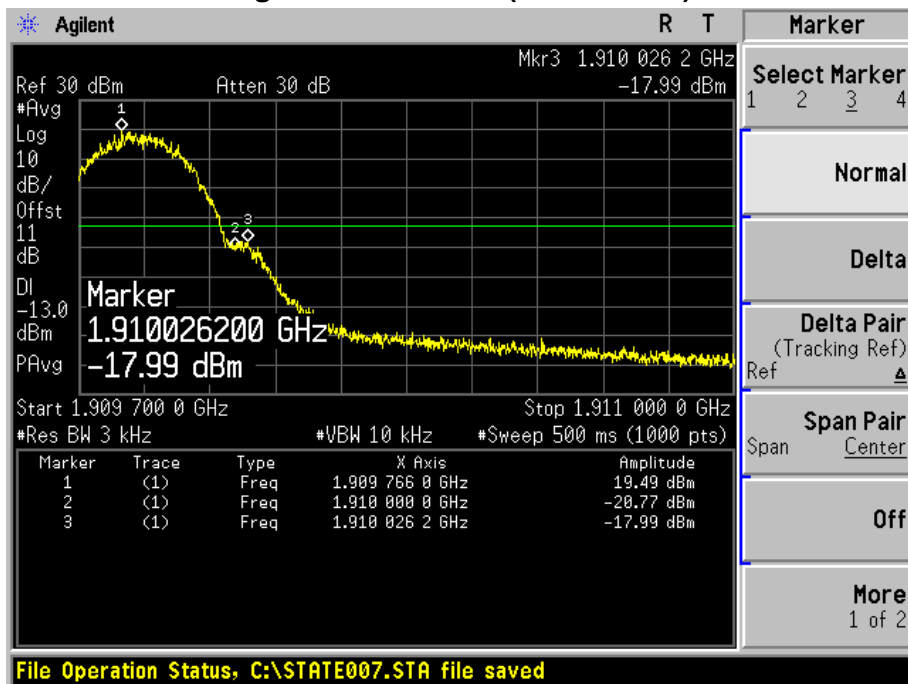

Figure Channel 810 (1909.80MHz)



7. Spurious Emission

7.1. Test Equipment

Spurious Emission / AC-5

Instrument	Manufacturer	Type No.	Serial No	Cali. Due Date
PSA Series Spectrum Analyzer	Agilent	E4440A	MY49420184	2013.04.10
Radio Communication Tester	R&S	CMU 200	117088	2013.04.18
Dual Directional Coupler	Agilent	778D	20160	2013.04.18
10dB Coaxial Coupler	Agilent	87300C	MY44300299	2013.04.18
PSG Analog Signal Generator	Agilent	E8257D	MY44321116	2013.04.18
Preamplifier	QuieTek	AP-025C	CHM-0503006	2013.05.04
Preamplifier	Miteq	NSP1800-25	1364185	2013.05.04
Bilog Antenna	Teseq GmbH	CBL6112D	27612	2012.10.18
Half Wave Tuned Dipole Antenna	COM-POWER	AD-100	40137	2013.11.24
Broad-Band Horn Antenna	Schwarzbeck	BBHA9120D	737	2013.11.24
Broad-Band Horn Antenna	Schwarzbeck	BBHA9120D	499	2012.06.11
Temperature/Humidity Meter	Zhicheng	ZC1-2	AC5-TH	2013.01.10

7.2. Test Setup

Conducted Spurious Emission Measurement:

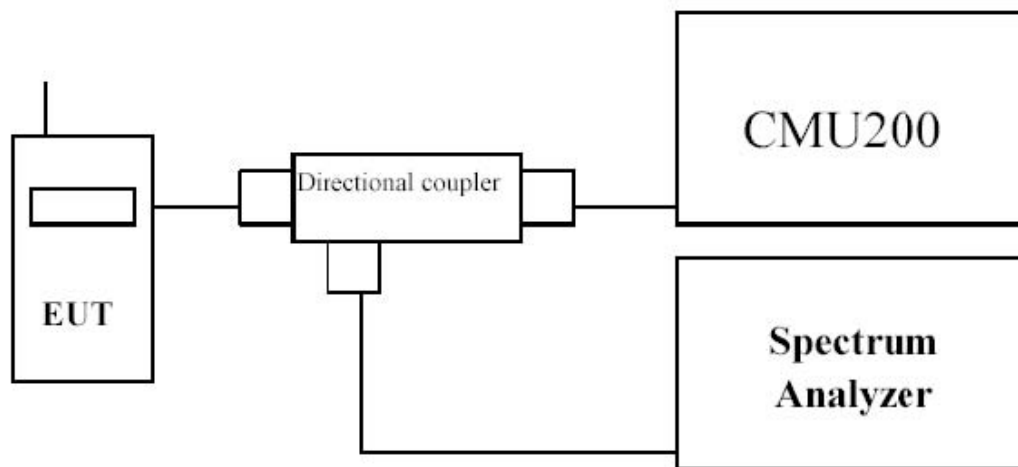

Radiated Spurious Measurement: below 1GHz

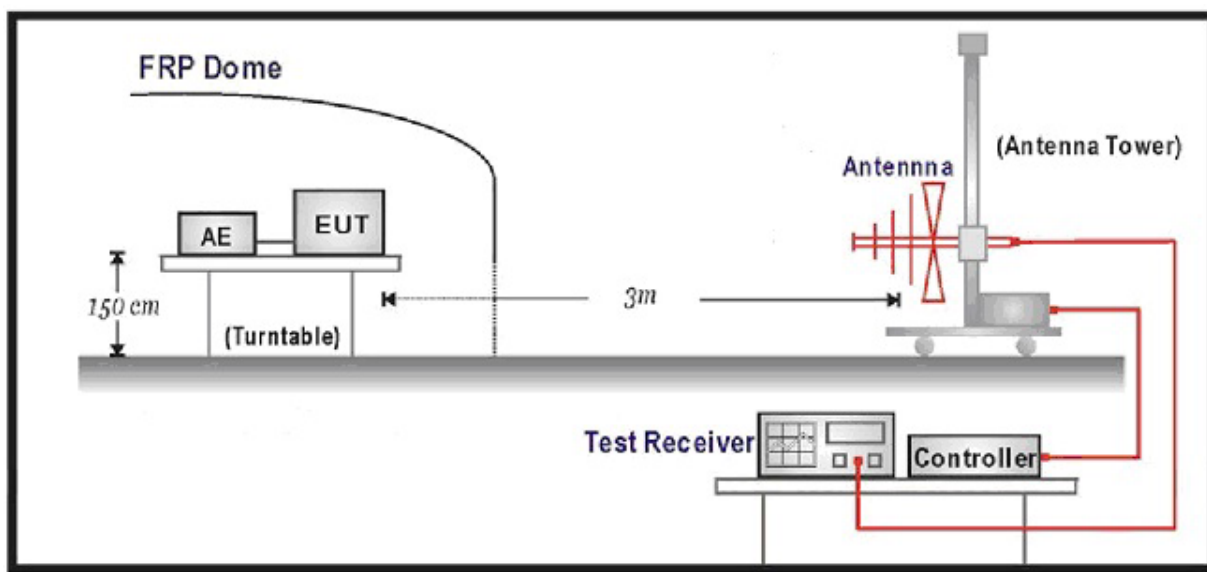

Radiated Spurious Measurement: above 1GHz

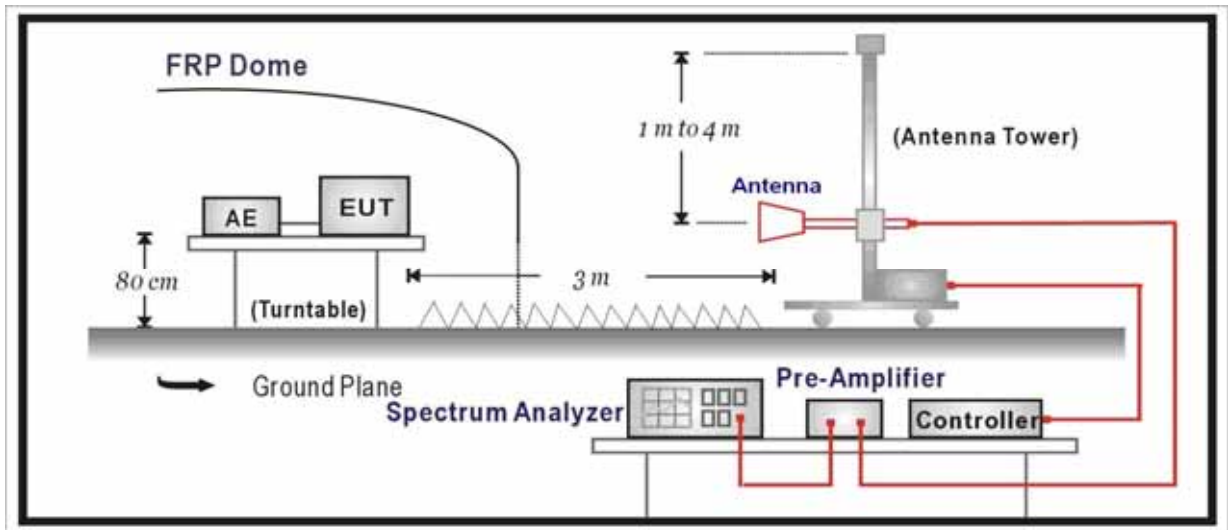

7.3. Limit

The power of any emission outside of the authorized operating frequency ranges must be attenuated below the transmitting power (P) by a factor of at least $43 + 10\log(P)$ dB.

7.4. Test Procedure

Conducted Spurious Measurement:

- a) Place the EUT on a bench and set it in transmitting mode.
- b) Connect a low loss RF cable from the antenna port to a spectrum analyzer and CMU200 by a Directional Couple.
- c) EUT Communicate with CMU200, then select a channel for testing.
- d) Add a correction factor to the display of spectrum, and then test.
- e) The resolution bandwidth of the spectrum analyzer was set at 1 MHz, sufficient scans were taken to show the out of band Emission if any up to 10th harmonic.

Radiated Spurious Measurement:

- a) The EUT shall be placed at the specified height on a support, and in the position closest to normal use as declared by provider.
- b) The test antenna shall be oriented initially for vertical polarization and shall be chosen to correspond to the frequency of the transmitter
- c) The output of the test antenna shall be connected to the measuring receiver.

- d) The transmitter shall be switched on and the measuring receiver shall be tuned to the frequency of the transmitter under test.
- e) The test antenna shall be raised and lowered through the specified range of height until a maximum signal level is detected by the measuring receiver.
- f) The transmitter shall then be rotated through 360° in the horizontal plane, until the maximum signal level is detected by the measuring receiver.
- g) The test antenna shall be raised and lowered again through the specified range of height until a maximum signal level is detected by the measuring receiver.
- v) The maximum signal level detected by the measuring receiver shall be noted.
- h) The transmitter shall be replaced by a substitution antenna.
- i) The substitution antenna shall be orientated for vertical polarization and the length of the substitution antenna shall be adjusted to correspond to the frequency of the transmitter.
- j) The substitution antenna shall be connected to a calibrated signal generator.
- k) If necessary, the input attenuator setting of the measuring receiver shall be adjusted in order to increase the sensitivity of the measuring receiver.
- l) The test antenna shall be raised and lowered through the specified range of height to ensure that the maximum signal is received.
- m) The input signal to the substitution antenna shall be adjusted to the level that produces a level detected by the measuring receiver, that is equal to the level noted while the transmitter radiated power was measured, corrected for the change of input attenuator setting of the measuring receiver.
- n) The measurement shall be repeated with the test antenna and the substitution antenna orientated for horizontal polarization.
- o) The measure of the effective radiated power is the larger of the two levels recorded at the input to the substitution antenna, corrected for gain of the substitution antenna if necessary.
- p) The frequency range was checked up to 10th harmonic.
- q) Test site anechoic chamber refer to ANSI C63.4: 2009

7.5. Uncertainty

The measurement uncertainty is defined as 3.2 dB for Radiated Power Measurement.

7.6. Test Result

Product	GPS Locator		
Test Item	Conducted Spurious Emission		
Test Mode	Mode 1: GPRS 850 Link		
Date of Test	2012/05/22	Test Site	TR-8



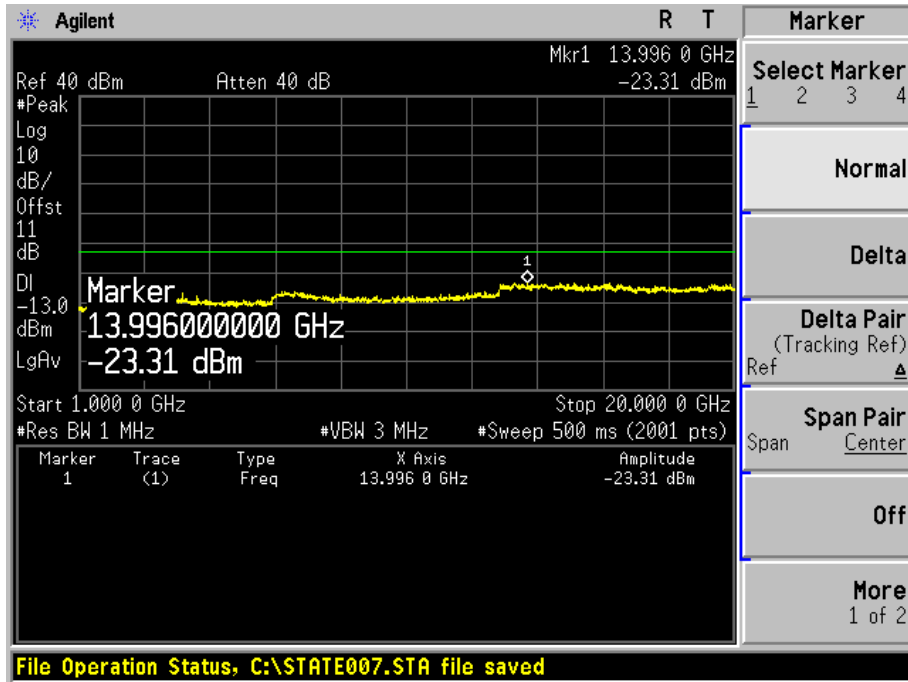

Mid Channel 189(836.4MHz)

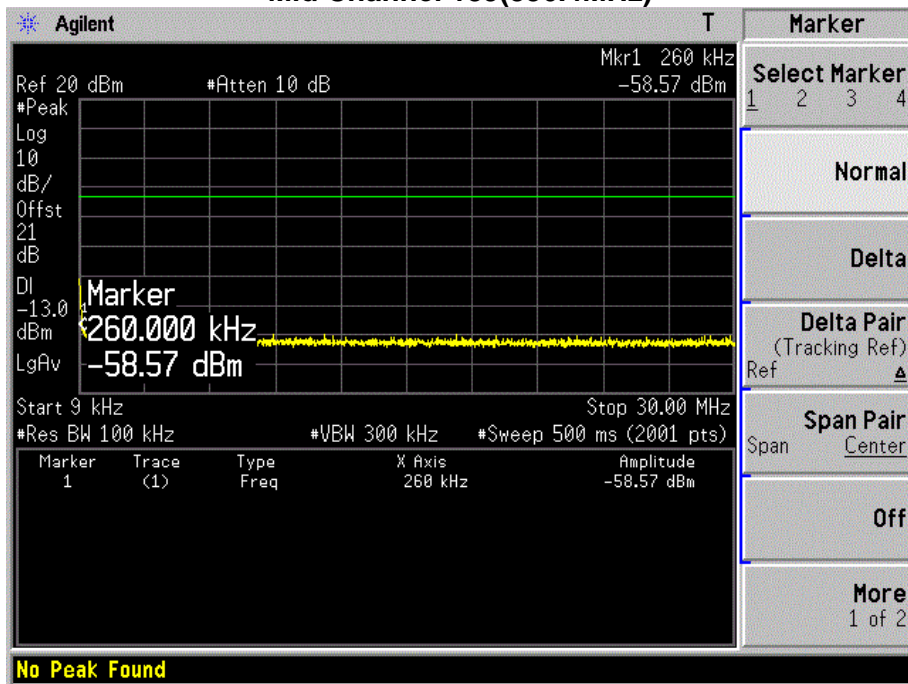

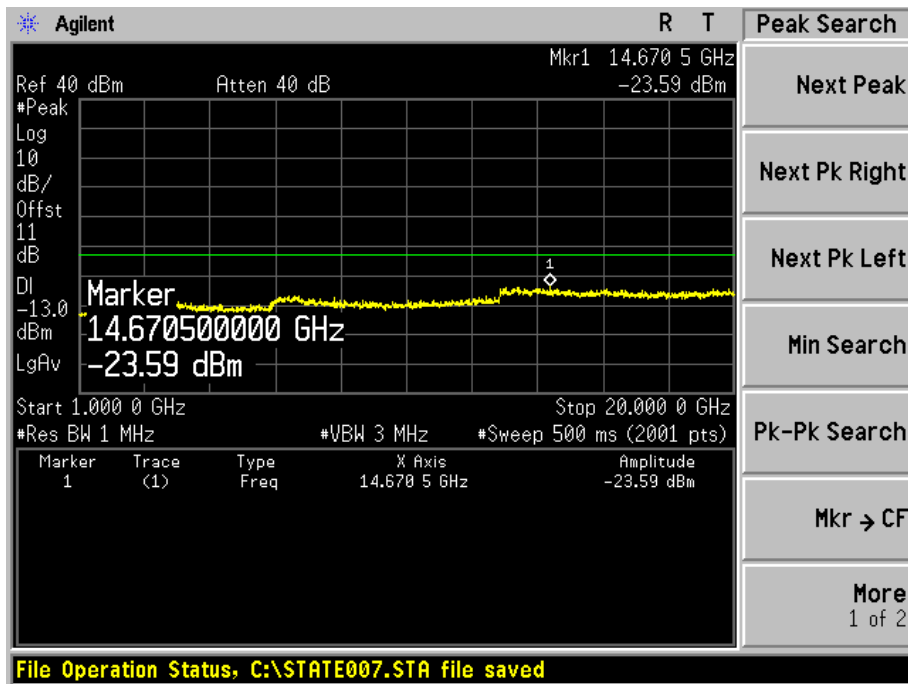
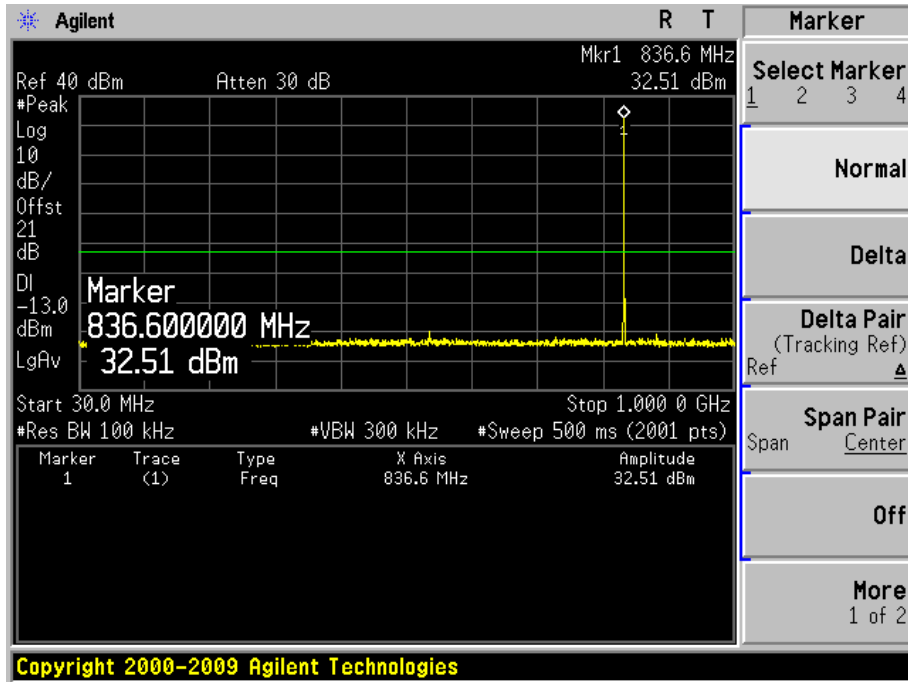

High Channel 251(848.8MHz)

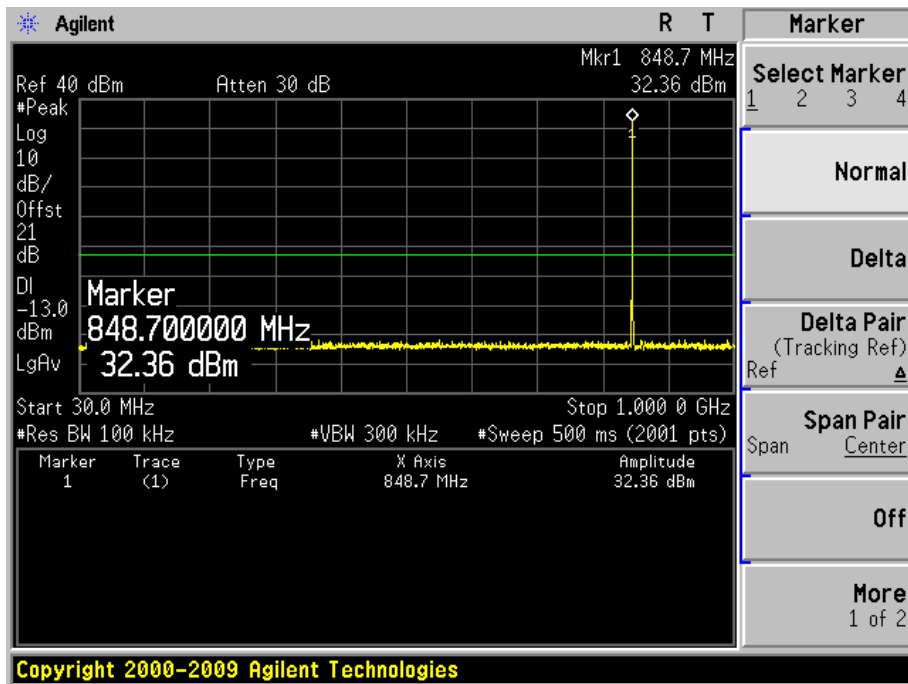
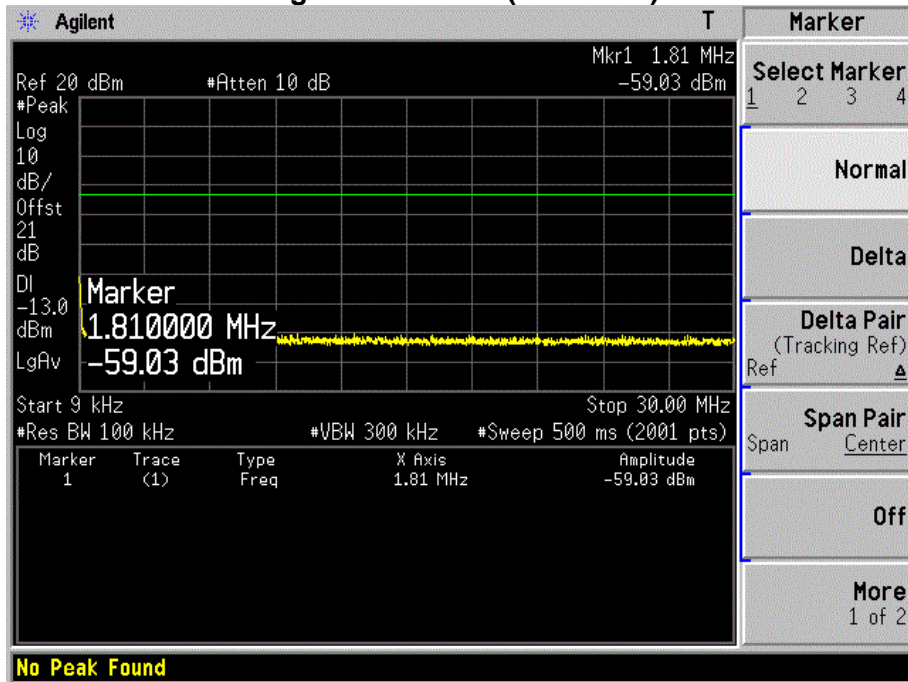

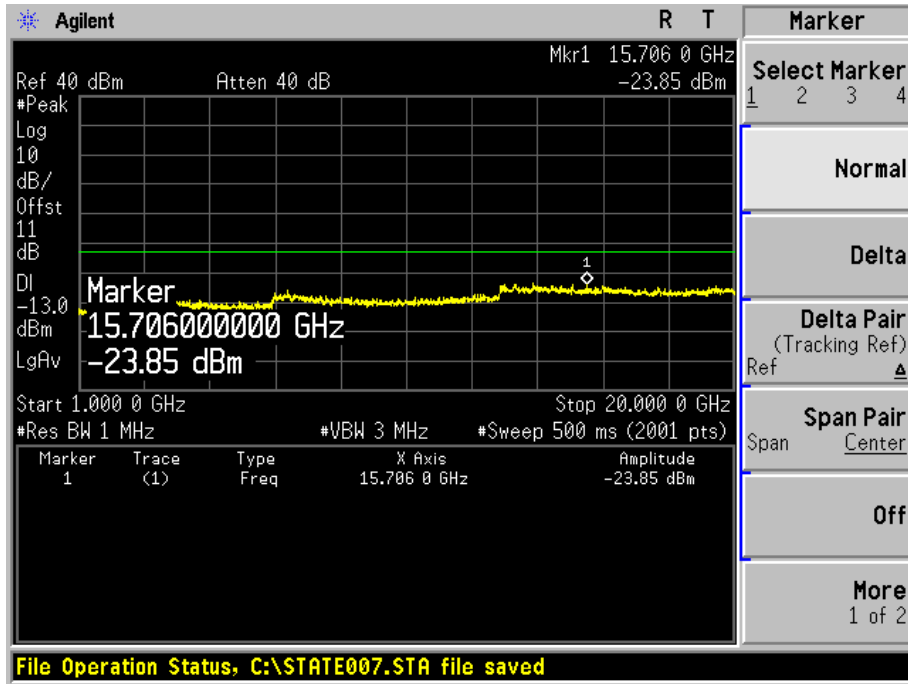

Product	GPS Locator		
Test Item	Conducted Spurious Emission		
Test Mode	Mode 2: GPRS 1900 Link		
Date of Test	2012/05/22	Test Site	TR-8

Low Channel 512(1850.2MHz)

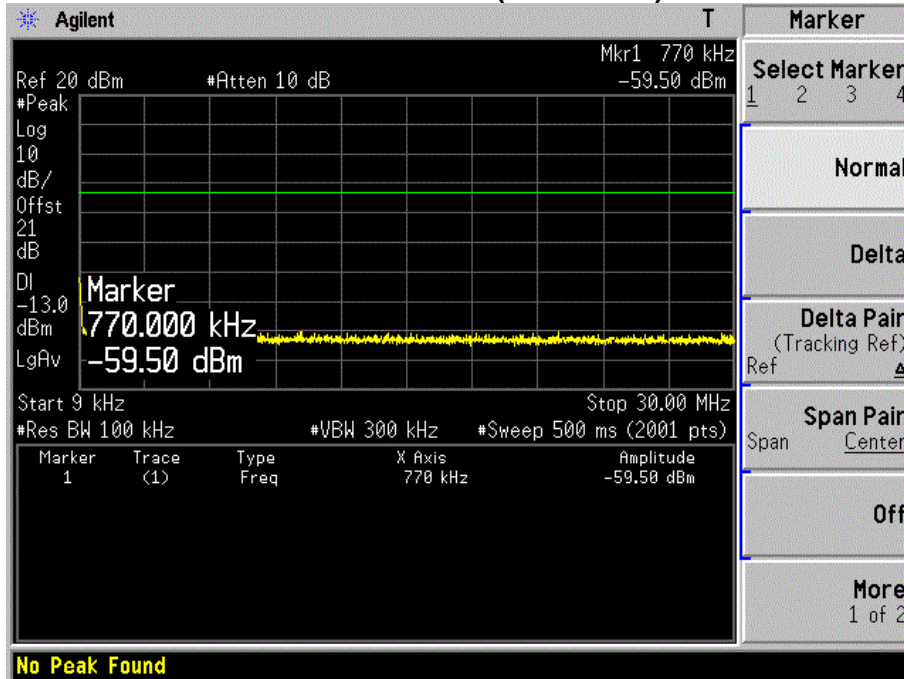

No Peak Found

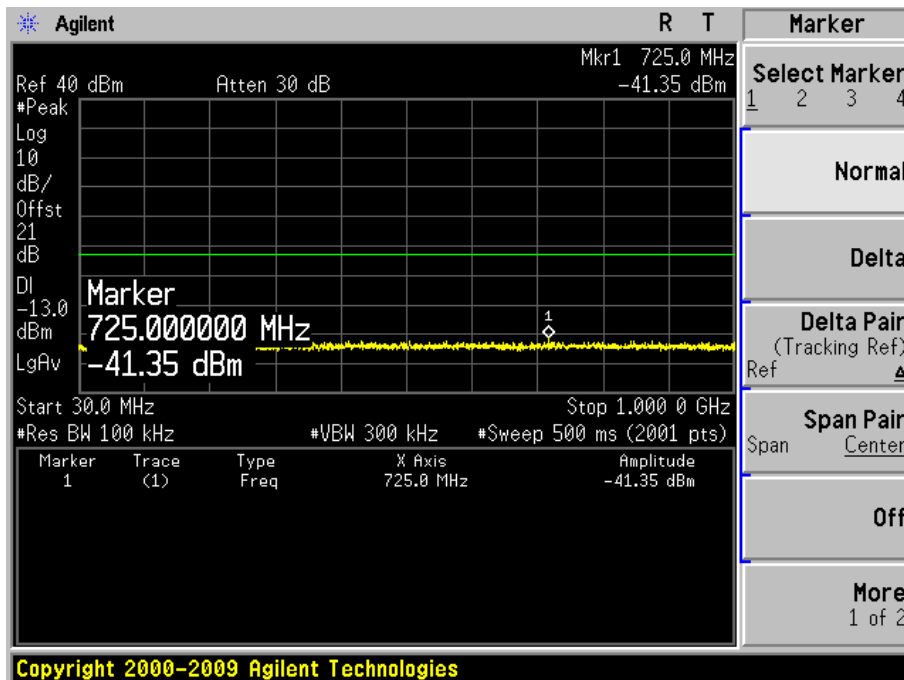

Copyright 2000-2009 Agilent Technologies

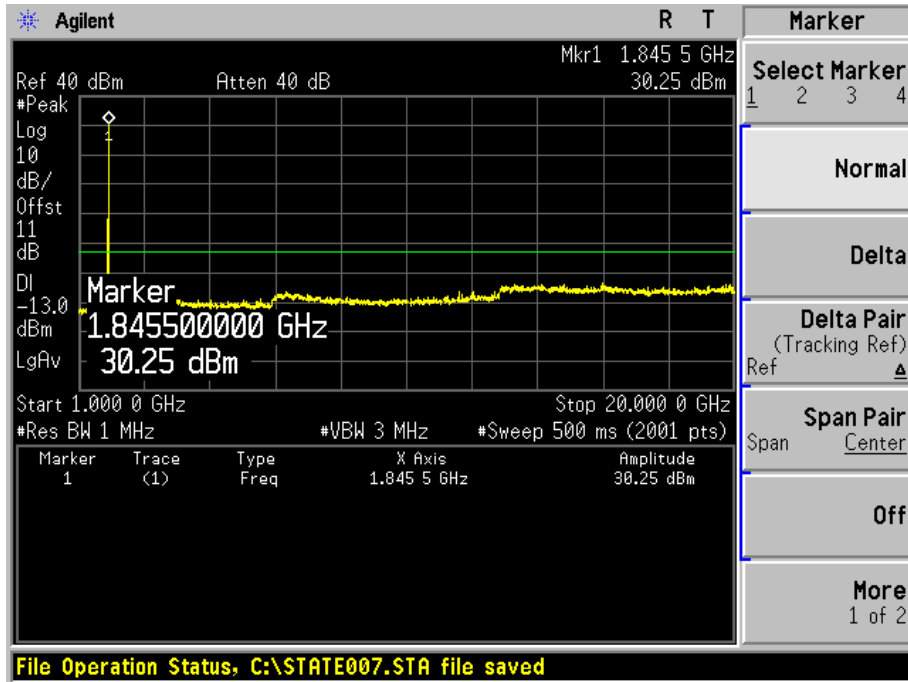

Mid Channel 661(1880.0MHz)

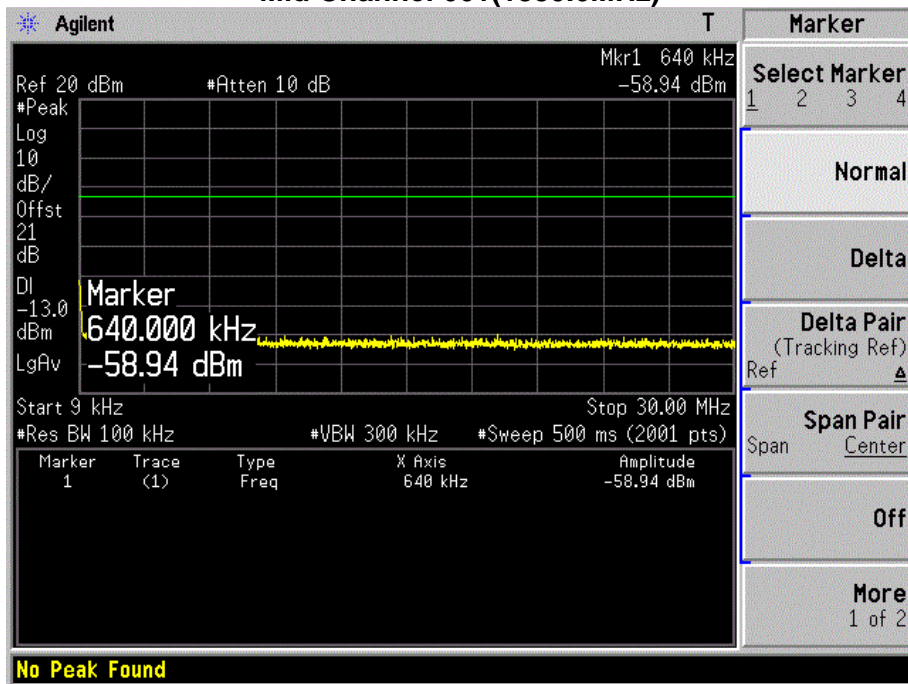

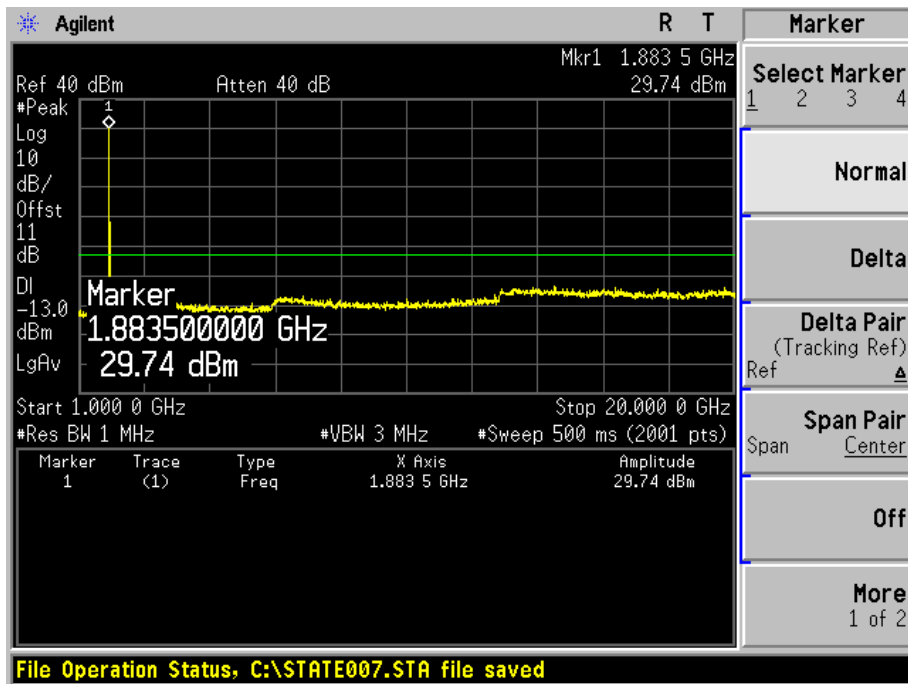
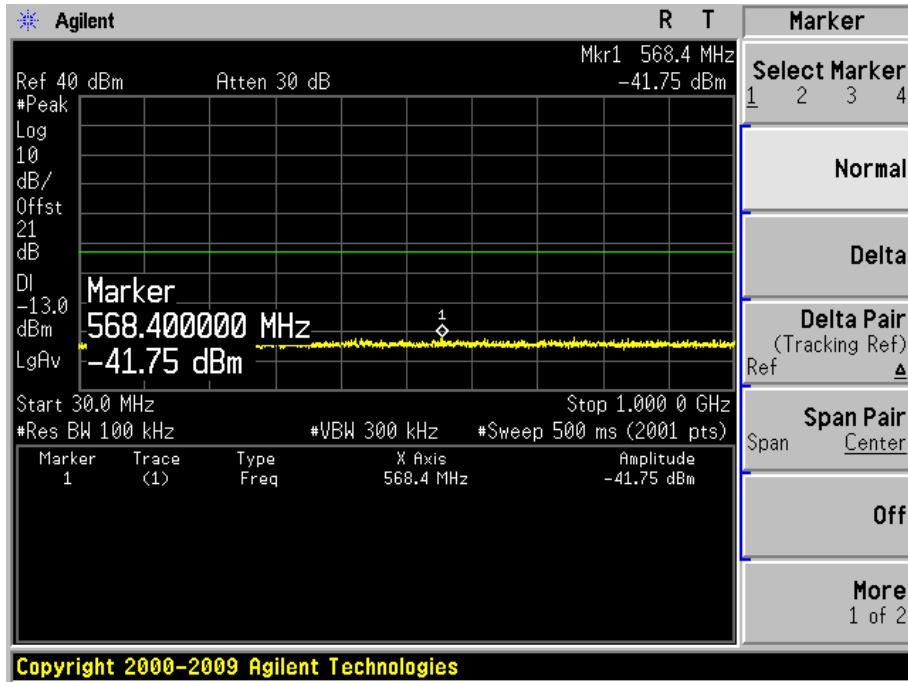

High Channel 810(1909.8MHz)

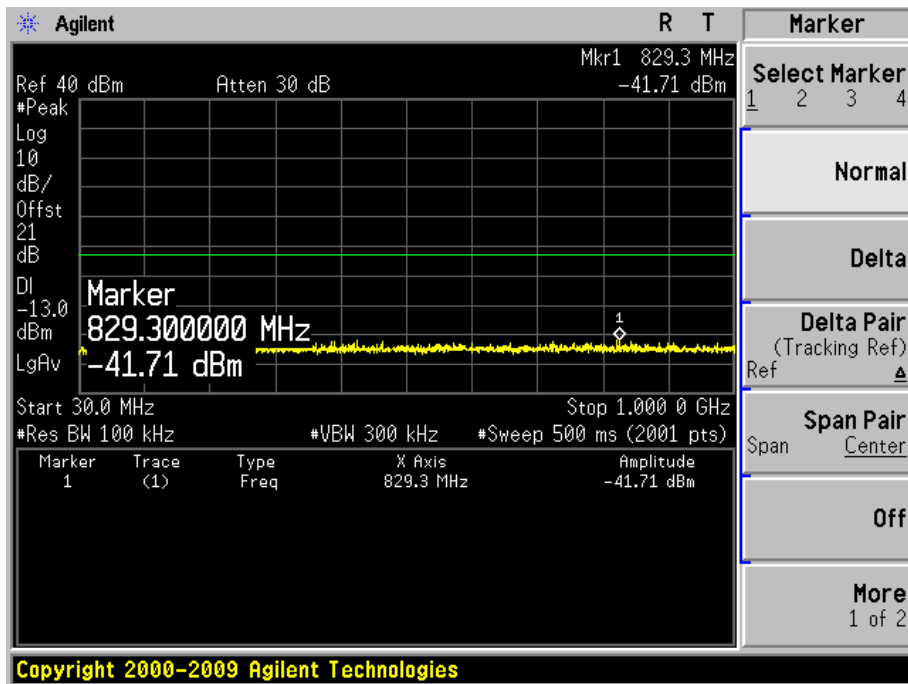
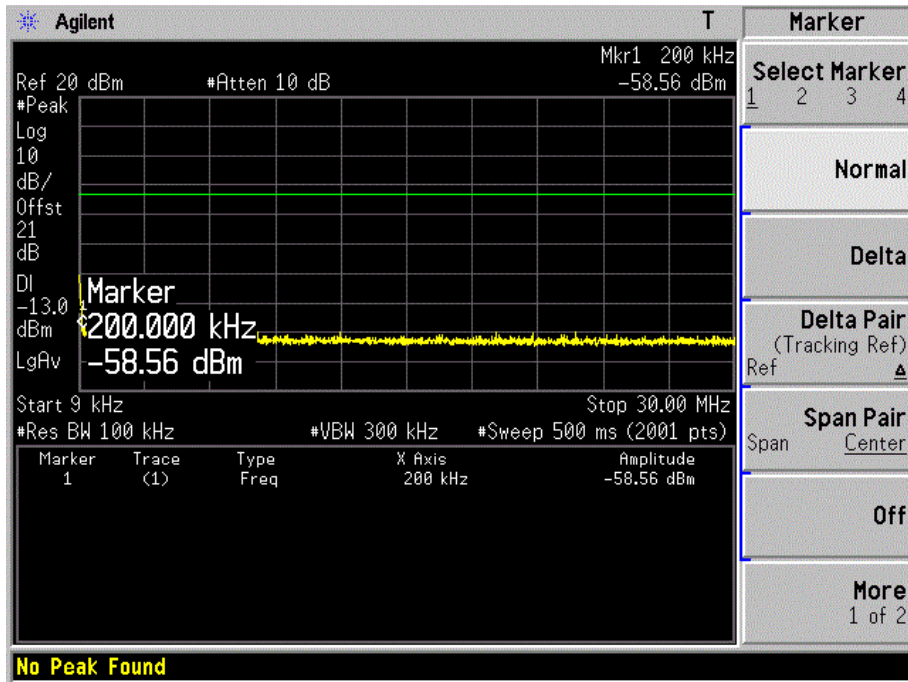

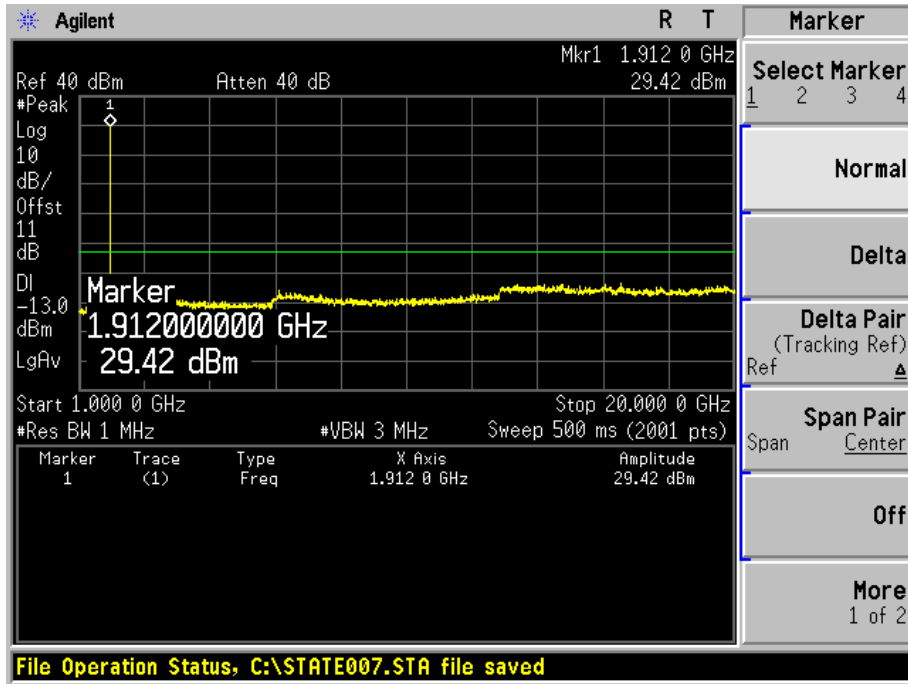

Product	GPS Locator		
Test Item	Radiated Spurious Emission		
Test Mode	Mode 1: GPRS 850 Link		
Date of Test	2012/05/22	Test Site	AC-5

Frequency (MHz)	SA Reading (dBm)	Ant.Pol. (H/V)	SG Reading (dBm)	Cable Loss (dB)	Gain (dBi)	EIRP (dBm)	Limit (dBm)	Margin (dB)
Low Channel 128 (824.20MHz)								
1646.00	-34.00	V	-36.57	2.50	9.75	-29.32	-13.00	-16.32
2470.50	-47.82	V	-46.85	3.12	10.48	-39.49	-13.00	-26.49
1646.00	-31.20	H	-33.86	2.50	9.75	-26.61	-13.00	-13.61
2470.50	-40.22	H	-39.11	3.12	10.48	-31.75	-13.00	-18.75
Middle Channel 189 (836.40MHz)								
1671.50	-39.39	V	-42.06	2.52	9.95	-34.63	-13.00	-21.63
2513.00	-49.60	V	-48.91	3.18	10.62	-41.47	-13.00	-28.47
1671.50	-35.84	H	-38.26	2.52	9.95	-30.83	-13.00	-17.83
2513.00	-46.25	H	-45.18	3.18	10.62	-37.74	-13.00	-24.74
High Channel 251 (848.80MHz)								
1697.00	-41.82	V	-44.55	2.54	10.06	-37.03	-13.00	-24.03
2547.00	-54.94	V	-53.38	3.14	10.68	-45.84	-13.00	-32.84
1697.00	-37.32	H	-39.32	2.54	10.06	-31.80	-13.00	-18.80
2547.00	-49.13	H	-47.31	3.14	10.68	-39.77	-13.00	-26.77

Product	GPS Locator		
Test Item	Radiated Spurious Emission		
Test Mode	Mode 2: GPRS 1900 Link		
Date of Test	2012/05/22	Test Site	AC-5

Frequency (MHz)	SA Reading (dBm)	Ant.Pol. (H/V)	SG Reading (dBm)	Cable Loss (dB)	Gain (dBi)	EIRP (dBm)	Limit (dBm)	Margin (dB)
Low Channel 512 (1850.20MHz)								
3703.00	-44.75	V	-41.3	3.84	12.69	-32.45	-13.00	-19.45
5547.50	-54.33	V	-45.83	4.82	13.15	-37.50	-13.00	-24.50
3703.00	-41.31	H	-37.94	3.84	12.69	-29.09	-13.00	-16.09
5547.50	-53.30	H	-45.41	4.82	13.15	-37.08	-13.00	-24.08
Middle Channel 661 (1880.00MHz)								
3762.50	-41.32	V	-38.1	3.73	12.72	-29.11	-13.00	-16.11
5641.00	-53.07	V	-45.14	4.93	13.14	-36.93	-13.00	-23.93
3762.50	-40.42	H	-37.12	3.73	12.72	-28.13	-13.00	-15.13
5641.00	-54.22	H	-46.61	4.93	13.14	-38.40	-13.00	-25.40
High Channel 810 (1909.80MHz)								
3822.00	-41.75	V	-38.03	4.02	12.73	-29.32	-13.00	-16.32
5726.00	-55.40	V	-46.78	4.87	13.11	-38.54	-13.00	-25.54
3822.00	-41.91	H	-38.04	4.02	12.73	-29.33	-13.00	-16.33
5726.00	-54.63	H	-46.39	4.87	13.11	-38.15	-13.00	-25.15

7.7. Test Photograph

Description: ERP Test Setup



Description: Substitution Antenna for ERP Test

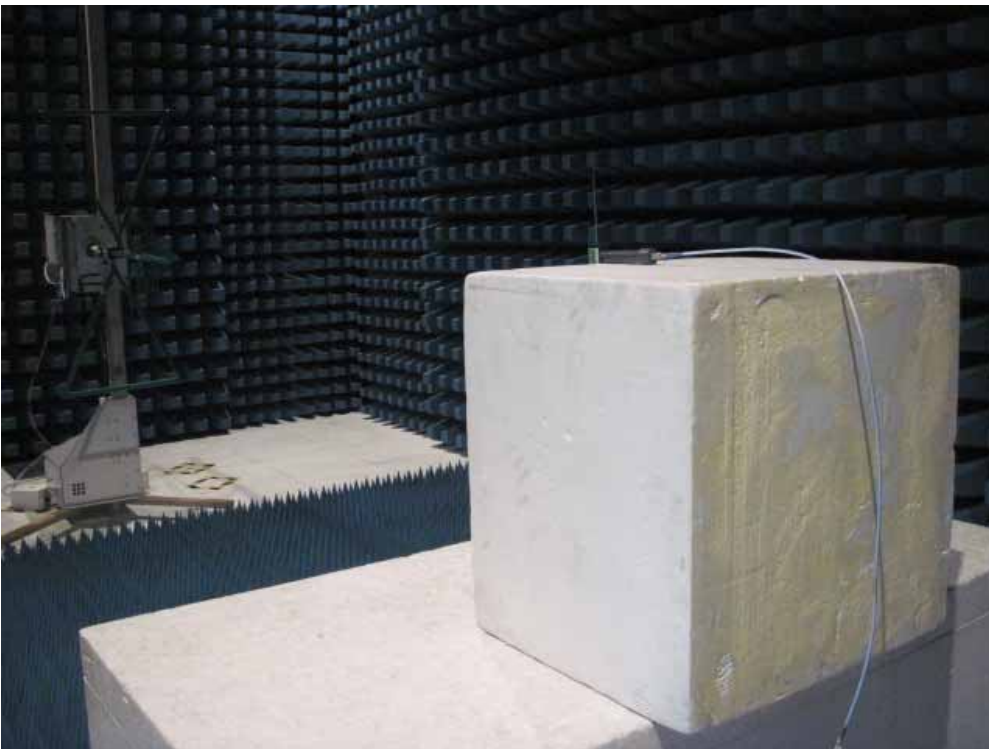

Description: EIRP Test Setup

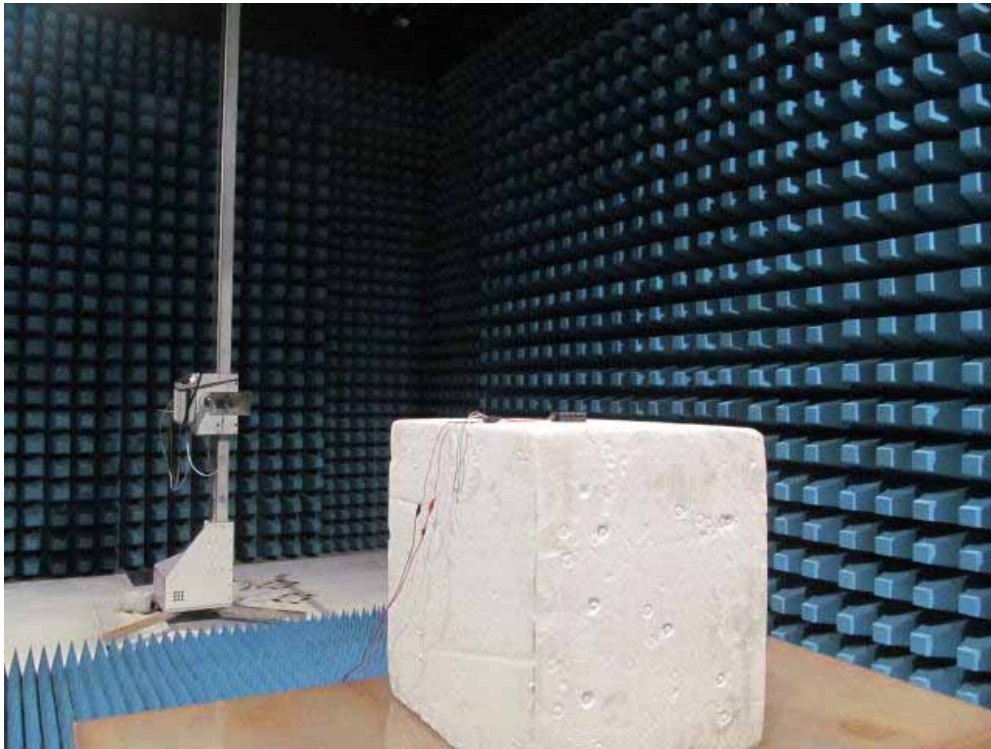

Description: Substitution Antenna for EIRP Test

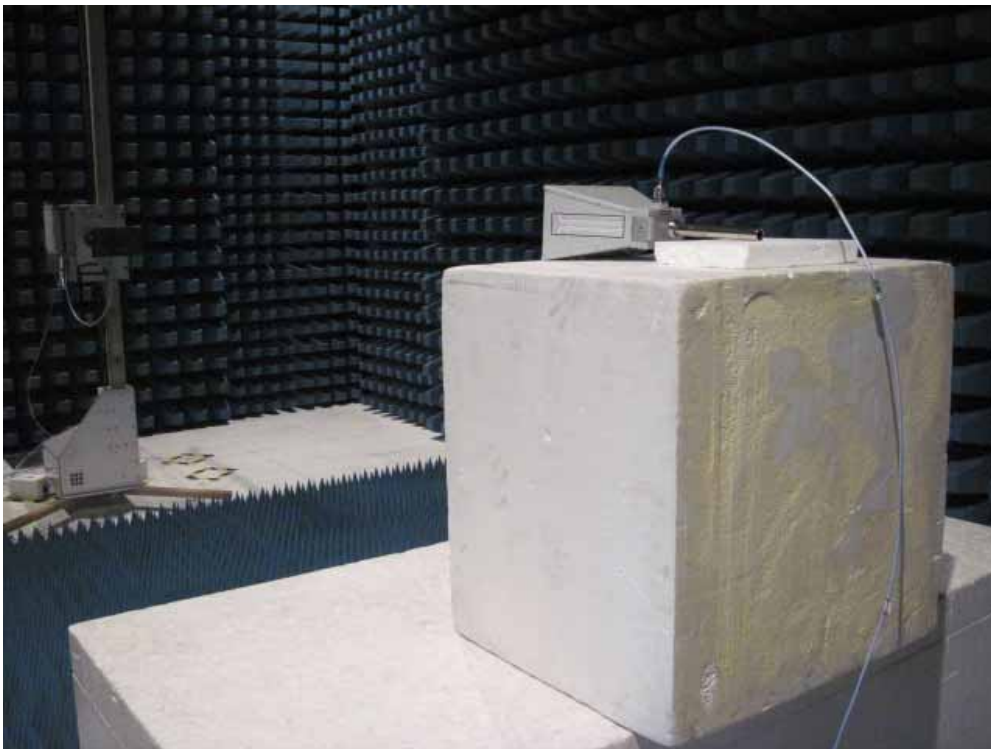

8. Frequency Stability Under Temperature & Voltage Variations

8.1. Test Equipment

Frequency Stability Under Temperature & Voltage Variations / AC-6

Instrument	Manufacturer	Type No.	Serial No	Cali. Due Date
PSA Series Spectrum Analyzer	Agilent	E4440A	MY49420184	2013.04.10
Radio Communication Tester	R&S	CMU 200	117088	2013.04.18
Dual Directional Coupler	Agilent	778D	20160	2013.04.18
10dB Coaxial Coupler	Agilent	87300C	MY44300299	2013.04.18
DC Power Supply	IDRC	CD-035-020PR	977272	2012.09.22
Temperature & Humidity Chamber	Gaoyu	TH-1P-B	WIT-05121302	2013.01.13
Temperature/Humidity Meter	Zhicheng	ZC1-2	AC6-TH	2013.01.10

8.2. Test Setup

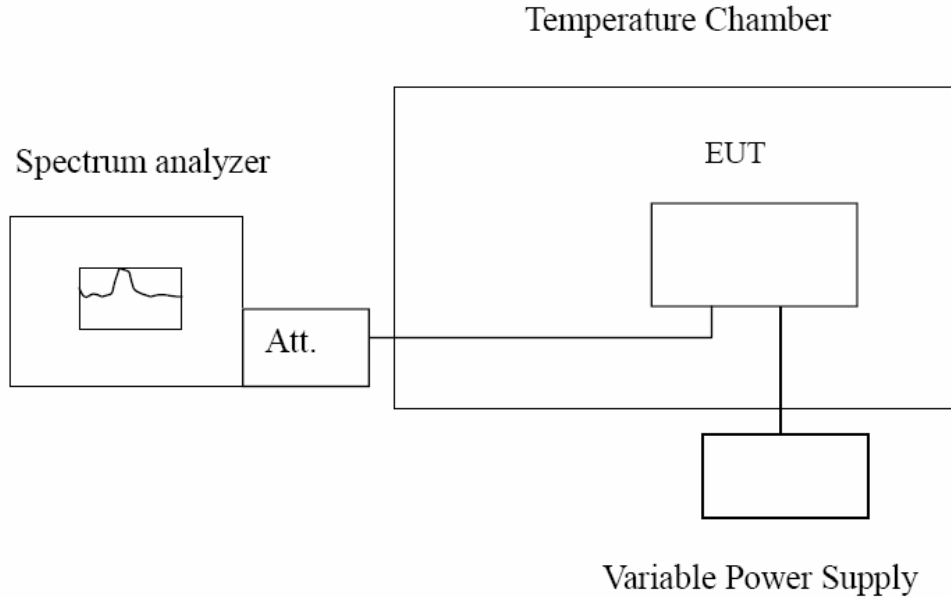

8.3. Limit

The frequency stability shall be sufficient to ensure that the fundamental emission stays within the authorized frequency block.

Limit	$< \pm 2.5 \text{ ppm}$
-------	-------------------------

8.4. Test Procedure

Frequency Stability Under Temperature Variations:

The equipment under test was connected to an external AC or DC power supply and input rated voltage. RF output was connected to a frequency counter or spectrum analyzer via feed through attenuators. The EUT was placed inside the temperature chamber. Set the spectrum analyzer RBW low enough to obtain the desired frequency resolution and measure EUT 20°C operating frequency as reference frequency. Turn EUT off and set the chamber temperature to -30°C. After the temperature stabilized for approximately 30 minutes recorded the frequency. Repeat step measure with 10°C increased per stage until the highest temperature of +50°C reached.

Frequency Stability Under Voltage Variations:

Set chamber temperature to 20°C. Use a variable AC power supply / DC power source to power the EUT and set the voltage to rated voltage. Set the spectrum analyzer RBW low enough to obtain the desired frequency resolution and recorded the frequency.

Reduce the input voltage to specify extreme voltage variation ($\pm 15\%$) and endpoint, record the maximum frequency change.

8.5. Uncertainty

The measurement uncertainty is defined as $\pm 10 \text{ Hz}$.

8.6. Test Result

Product	GPS Locator		
Test Item	Frequency Stability Under Temperature & Voltage Variations		
Test Mode	Mode 1: GPRS 850 Link		
Date of Test	2012/05/22	Test Site	TR7

Frequency Stability under Temperature

Temperature Interval (°C)	Test Frequency (MHz)	Deviation (Hz)	Limit (Hz)
-30	836.40	-93	± 2091
-20	836.40	-113	± 2091
-10	836.40	-120	± 2091
0	836.40	-64	± 2091
10	836.40	-87	± 2091
20	836.40	-73	± 2091
30	836.40	-66	± 2091
40	836.40	-75	± 2091
50	836.40	-41	± 2091

Frequency Stability under Voltage

DC Voltage (V)	Test Frequency (MHz)	Deviation (Hz)	Limit (Hz)
10.00	836.40	-63	± 2091
12.00	836.40	-11	± 2091
16.00	836.40	-48	± 2091

Product	GPS Locator		
Test Item	Frequency Stability Under Temperature & Voltage Variations		
Test Mode	Mode 2: GPRS 1900 Link		
Date of Test	2012/05/22	Test Site	TR7

Frequency Stability under Temperature

Temperature Interval (°C)	Test Frequency (MHz)	Deviation (Hz)	Limit (Hz)
-30	1880.00	-17	± 4700
-20	1880.00	-24	± 4700
-10	1880.00	-44	± 4700
0	1880.00	-26	± 4700
10	1880.00	-31	± 4700
20	1880.00	-8	± 4700
30	1880.00	11	± 4700
40	1880.00	20	± 4700
50	1880.00	34	± 4700

Frequency Stability under Voltage

DC Voltage (V)	Test Frequency (MHz)	Deviation (Hz)	Limit (Hz)
10.00	1880.00	-22	± 4700
12.00	1880.00	-23	± 4700
16.00	1880.00	-34	± 4700

9. Attachment

➤ EUT Photograph

(1) EUT Photo



(2) EUT Photo



(3) EUT Photo



(4) EUT Test Platform



(5) EUT Test Platform



(6) EUT Test Platform

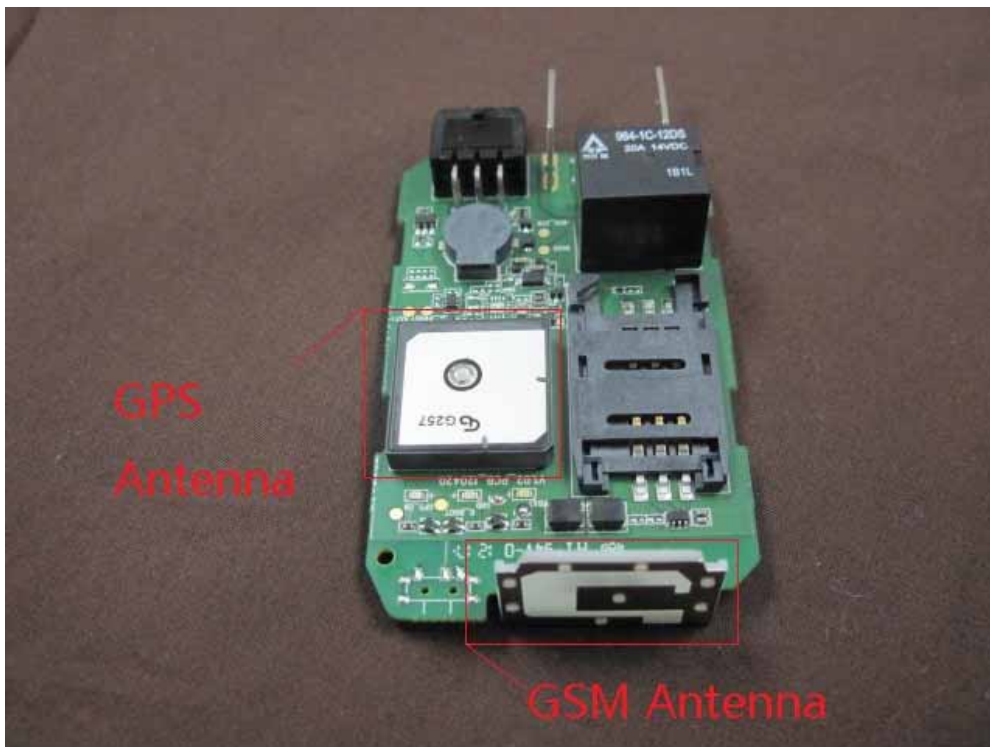

(7) EUT Test Platform



(8) EUT Test Platform



(9) EUT Test Platform

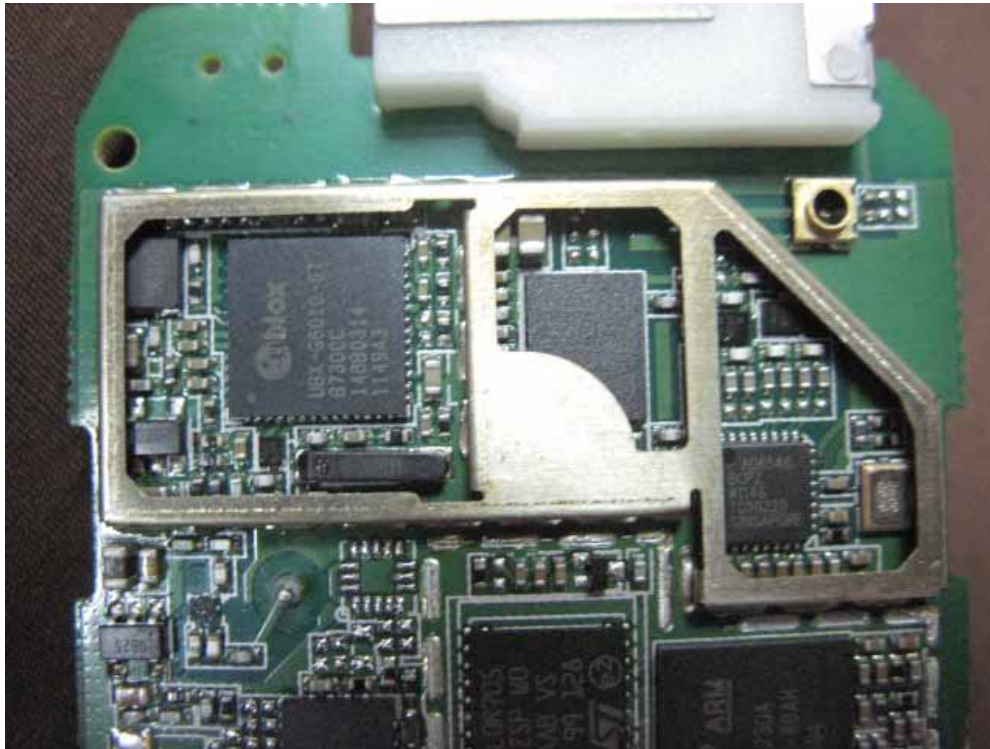

(10) EUT Test Platform

