



GV300CAU Series User Manual

GSM/GPRS/WCDMA/LTE Cat1/GNSS Tracker

QSZTRACGV300CUM0101

Version: 1.01

International Telematics Solutions Innovator

www.queclink.com

Document Title	GV300CAU Series User Manual
Version	1.01
Date	2020-09-02
Status	Released
Document Control ID	QSZTRACGV300CUM0101

General Notes

Queclink offers this information as a service to its customers, to support application and engineering efforts that use the products designed by Queclink. The information provided is based upon requirements specifically provided to Queclink by the customers. Queclink has not undertaken any independent search for additional relevant information, including any information that may be in the customer's possession. Furthermore, system validation of this product designed by Queclink within a larger electronic system remains the responsibility of the customer or the customer's system integrator. All specifications supplied herein are subject to change.

Copyright

This document contains proprietary technical information which is the property of Queclink. Copying of this document, distribution to others or using or communication of the contents thereof is forbidden without express authority. Offenders are liable to the payment of damages. All rights are reserved in the event of a patent grant or registration of a utility model or design. All specifications supplied herein are subject to change without notice at any time.

Copyright © Queclink Wireless Solutions Co., Ltd. 2020

Contents

0. Revision History	1
1. Introduction	2
1.1. GV300CAU Series Products	2
1.2. Reference.....	2
1.3. Terms and Abbreviations	3
2. Product Overview.....	4
2.1. Product Appearance	4
2.2. LED Description	4
2.3. Parts List	5
3. Interface Definition	6
4. GV300CAU Series Device Cable Color	8
5. Getting Started	9
5.1. Opening and Closing the Case	9
5.2. Installing a SIM Card	9
5.3. Installing the Internal Backup Battery	10
5.4. Switching on the Backup Battery.....	10
5.5. Installation of the External GPS Antenna (Optional)	10
5.6. Power Supply Connection	11
5.7. Ignition Detection.....	11
5.8. Digital Inputs	11
5.9. Analog Input/Digital out.....	12
5.10. Digital Outputs.....	12
5.11. Serial Port/UART Interface	14
6. Installation Precautions.....	15
7. Troubleshooting and Safety Info	16
7.1. Troubleshooting.....	16
7.2. Safety Info.....	16
8. Appendix: Supported Accessories	17

0. Revision History

Version	Date	Author	Description of Change
1.00	2020-06-20	Arry Wang	Initial
1.01	2020-09-02	Arry Wang	Modify interface definition description

1. Introduction

The GV300CAU Series are compact GPS trackers designed for a wide variety of vehicle tracking applications. It has multiple I/O interfaces that can be used for monitoring or controlling external devices. The GV300CAU Series supports various bands of LTE CAT1/WCDMA/GSM used by Latin America and Middle East cellular operators. The built-in GPS receiver has superior sensitivity and fast initial positioning. Its built-in 3-axis accelerometer allows motion detection and sophisticated power management algorithms extend battery life. System integration is straightforward as complete documentation is provided for the full featured @Track protocol. The @Track protocol supports a wide variety of reports including emergency alarm, Geo-fence boundary crossings, external power supply monitoring and position reports.

1.1. GV300CAU Series Products

Table 1. GV300CAU Series Products

Model No.	Region	Technology	Operating Band (MHz)
GV300CAU	Latin America	LTE CAT1/WCDMA /GSM	LTE FDD: B2/B4/B5/B7 WCDMA: B2/B5 GSM: 850/1900 MHz
GV300CEC	Middle East	LTE CAT1/WCDMA /GSM	LTE FDD: B1/B3/B7/B8/B20/B28A WCDMA: B1/B8 GSM: 900/1800 MHz

1.2. Reference

Table 2. GV300CAU Series Protocol Reference

SN	Document Name	Remark
[1]	GV300CAU Series @Track Air Interface Protocol	The air interface protocol between GV300CAU and backend server.

1.3. Terms and Abbreviations

Table 3. GV300CAU Series Terms and Abbreviations

Abbreviation	Description
AGND	Analog Ground
AIN	Analog Input
DIN	Digital Input
DOUT	Digital Output
GND	Ground
MIC	Microphone
RXD	Receive Data
TXD	Transmit Data
SPKN	Speaker Negative
SPKP	Speaker Positive

Bluetooth

The device role of Bluetooth could be Master and Slave. When the device role is Slave, the device will provide below services: device information service, battery information service, virtual serial port service. Other devices can read or use these services after connecting devices. When the device role is Master, the device will provide below services: the others devices can read or related information of the designated Bluetooth devices. After reading the data, the server can be reported to the server by the corresponding message.

The device's FCC ID: YQD-GV300CAU
Contains FCC ID: XMR201805EC21AU

2. Product Overview

2.1. Product Appearance



Figure 1. GV300CAU Series Products View

2.2. LED Description

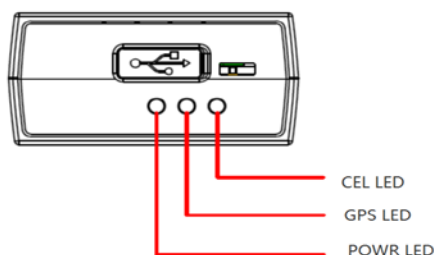

Figure 2. GV300CAU Series LEDs

There are three LEDs on GV300CAU Series. For details, please see the table below.

Table 4. GV300CAU Series LED Description

LED	Device Status	LED Status
CEL (Note 1)	Device is searching CEL network.	Fast flashing
	Device has registered to CEL network.	Slow flashing
	SIM card needs PIN to unlock.	ON
GPS (Note 2)	GPS chip is powered off.	OFF
	GPS sends no data or data format error occurs.	Slow flashing
	GPS chip is searching GPS signal.	Fast flashing
	GPS chip has received GPS signal.	ON
	Upgrading the device firmware over the air	Fast flashing
PWR (Note 2)	No external power and internal battery voltage is not lower than 3.65V.	OFF
	No external power and internal battery voltage is below 3.65V.	Slow flashing
	External power in and internal battery is charging.	Fast flashing
	The external power is connected and the battery is not in the charging state.	ON
	Upgrading the device firmware via Manage Tool	Fast flashing

Note:





1. CEL LED cannot be configured
2. GPS LED and PWR LED can be configured to turn off by using the Manage Tool.
3. Fast flashing: About 100ms ON/200ms OFF

4. Slow flashing: About 200ms ON/1000ms OFF

2.3. Parts List

Before starting, check whether all the following items have been included with your GV300CAU. If anything is missing, please contact your supplier.

Table 5. GV300CAU Series Parts List

Name	Picture	Description
GV300CAU Locator	 <p>80*49*26 mm</p>	GSM/GPRS/WCDMA/LTE Cat1/GNSS tracker
User Cable		GV300CAU Series standard cable
GPS Antenna (Optional)		External GPS Antenna
DATA_CABLE_M (Optional)		USB Data Cable, which can be used for firmware upgrade and configuration

3. Interface Definition

The GV300CAU has a 16-pin interface connector which contains the connections for power, I/O, RS232, MIC, etc. The sequence and definition of the 16-pin connector are shown in the following figure:

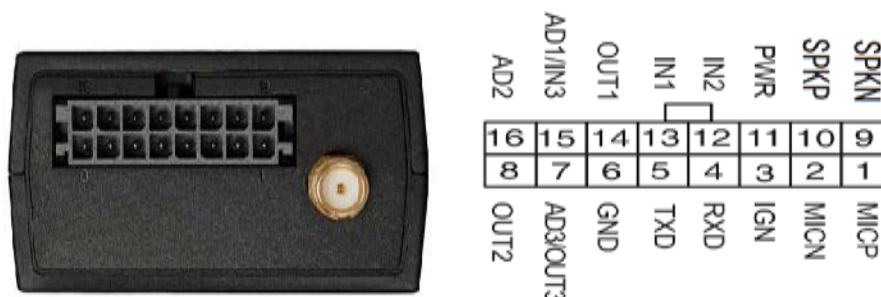



Figure 3. The 16-pin Connector on the GV300CAU

Series Table 6. Description of 16-pin Connections

Pin No.	Pin Name	Function Description
1	MICP	MIC positive input
2	MICN	MIC negative input
3	IGN	Ignition detection input, positive trigger
4	RXD	The RXD_RS232
5	TXD	The TXD_RS232
6	GND	Power and digital ground
7	ADIN3/OUT3	One special I/O can be configured as a 0-32V analog input or an open drain output with 150 mA max drive current
8	OUT2	Open drain output2, 150mA max drive current
9	SPKN	Speaker negative output
10	SPKP	Speaker positive output
11	PWR	External DC power input, 8-32V
12	IN2	Digital input2, negative trigger
13	IN1	Digital input1, negative trigger
14	OUT1	Open drain output1, 150mA max drive current, with latch circuit
15	ADIN1/IN3	Analog input1 (0-32V) or digital input 3, negative trigger
16	ADIN2	Analog input2 (0-32V)

4. GV300CAU Series Device Cable Color

Table 7. GV300CAU Series Cable Color Definition

Definition	Color	PIN No.	Cable	PIN No.	Color	Definition
OUT2	Yellow	8		16	Brown/White	ADIN2
ADIN3/OUT3	Brown	7		15	Green	ADIN1/IN3
GND	Black	6		14	Blue	OUT1
TXD	White/Black	5		13	Orange	IN1
RXD	Pink	4		12	Orange/Black	IN2
IGN	White	3		11	Red	PWR
MICN	Gray/Black	2		10	Purple/White	SPKP
MICP	Gray	1		9	Purple	SPKN

5. Getting Started

5.1. Opening and Closing the Case

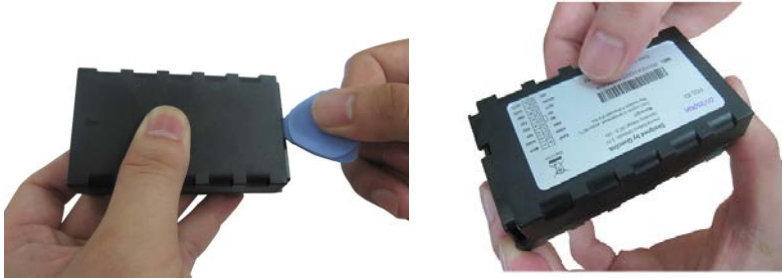

Figure 4. Opening and Closing the Case

To open: Insert the opener into the gap of the case as shown above, and push the opener up until the case is unsnapped.

To close: Place the cover on the bottom at the position as shown above. Slide the cover against the direction of the arrow until it snaps.

5.2. Installing a SIM Card

Install the SIM card into the holder when power is off as shown below (unplug the 16-pin cable and switch the internal battery to OFF position). Take care to align the cut mark. Close the card holder and then close the case.



Figure 5. SIM Card Installation

5.3. Installing the Internal Backup Battery

GV300CAU has an internal backup Li-ion battery.



Figure 6. Backup Battery Installation

5.4. Switching on the Backup Battery

To use the GV300CAU Series backup battery, the switch must be at the ON position. The switch and the ON/OFF position are shown as below.



Figure 7. Switch and ON/OFF Position

Note:

1. The switch must be at the “OFF” position when the GV300CAU series is shipped on an aircraft.
2. When the switch is at the “OFF” position, the battery cannot be charged nor be discharged.

5.5. Installation of the External GPS Antenna (Optional)

There is an SMA GPS antenna connector on GV300CAU Series. The GV300CAU Series will automatically detect and use the external antenna when it is connected.

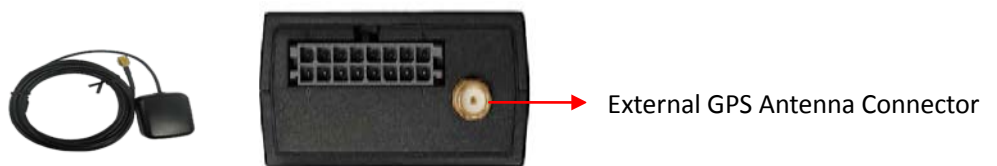

Figure 8. External GPS Antenna of GV300CAU Series

5.6. Power Supply Connection

PWR (pin 11)/GND (pin 6) are the power input pins. The input voltage range for this device is from 8V to 32V. The device is designed to be installed in vehicles that operate on 12V or 24V systems without the need for external transformers.

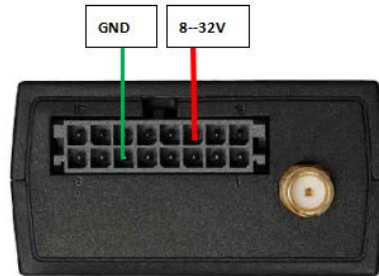

Figure 9. Typical Power Connection

5.7. Ignition Detection

IGN (pin 3) is used for ignition detection. It is recommended to connect this pin to the “RUN” position of the vehicle ignition switch as shown below.

An alternative to connect to the ignition switch is to find a non-permanent power source that is only available when the vehicle is running, for example, the power source for the FM radio.

IGN signal can be configured to transmit information to the backend server when ignition is on and enter the power saving mode when ignition is off.

Table 8. Electrical Characteristics of Ignition Detection

Logical State	Electrical Characteristics
Active	5.0V to 32V
Inactive	0V to 3V or open loop

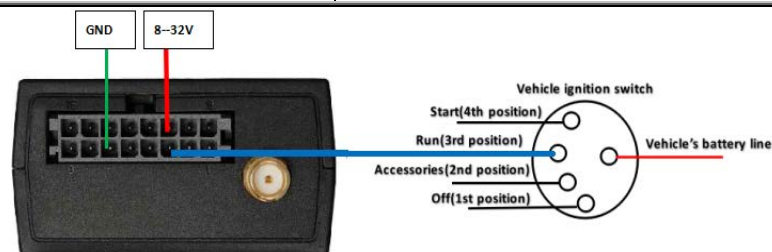

Figure 10. Typical Ignition Detection Connection

5.8. Digital Inputs

There are three general purpose digital inputs on GV300CAU. They all are negative triggers.

Table 9. Electrical Characteristics of the Digital Inputs

Logical State	Electrical Characteristics
Active	0V to 1.2V
Inactive	Open loop

The following picture shows the recommended connection of a digital input.

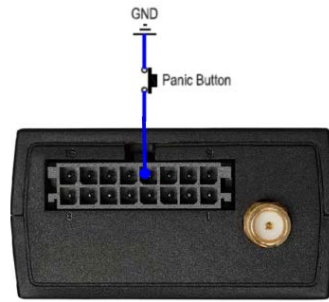

Figure 11. Digital Input Connection

5.9. Analog Input/Digital Output

This is a special I/O can be configured as a 0-32V analog input or an open drain output with 150mA max drive current.

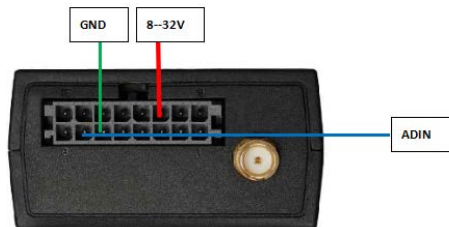

Figure 12. Analog Input or Digital out Connection

5.10. Digital Outputs

There are three digital outputs on GV300CAU. All are of open drain type and the maximum drain current is 150 mA. Each output has a built-in over current PTC resettable fuse.

e

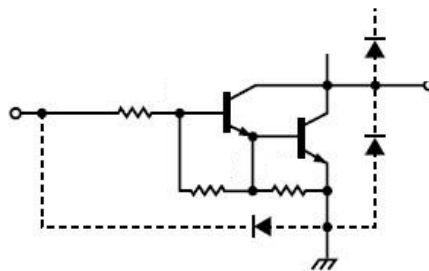

Figure 13. Digital Output Internal Drive Circuit

Table 10. Electrical Characteristics of Digital Outputs

Logical State	Electrical Characteristics
Enable	<1.5V @150 mA
Disable	Open drain

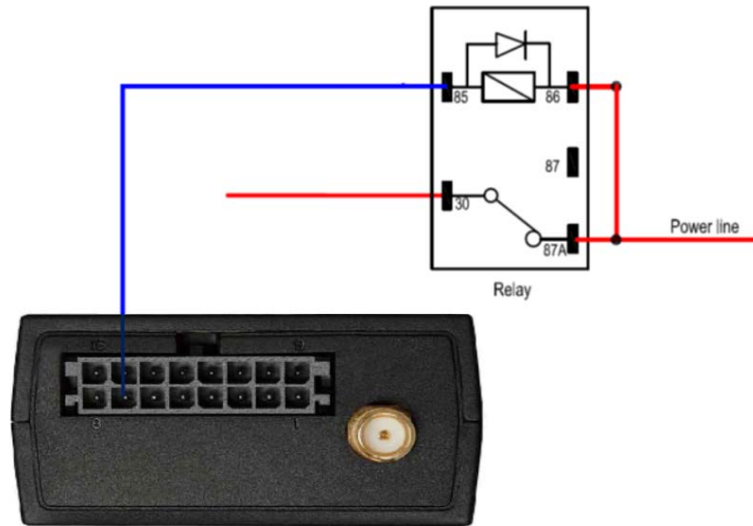

Figure 14. Typical Connection with a Relay

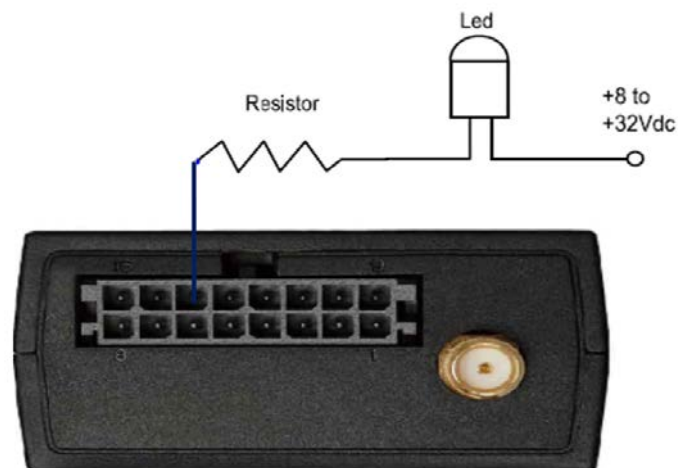

Figure 15. Typical Connection with a LED

Note: OUT1 will latch the output state during reset.

Warning: Many modern relays come with a flyback diode pre-installed internal to the relay itself. If the relay has this diode, insure the relay polarity connected is properly used. If this diode is not internal, it should be added externally. A common diode such as a 1N4004 will work in most circumstances.

5.11. Serial Port/UART Interface

There are two lines dedicated to the Serial Port/UART interface (TXD/RXD). TXD/RXD is standard RS232 signal.

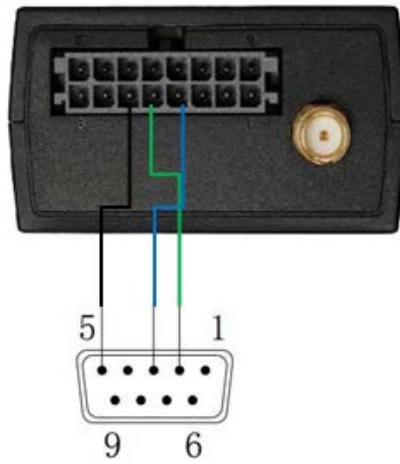

Figure 16. Connection with RS232 Port

6. Installation Precautions

- ◆ Firmly install the device to a reliable surface to prevent falling off.
- ◆ Make the side with antenna face sky to have better signal reception.
- ◆ Do not install the device under metal surface or in enclosed environments having difficulty in getting GPS and network signal.

7. Troubleshooting and Safety Info

7.1. Troubleshooting

Table 11. GV300CAU Series Troubleshooting List

Problem	Possible Reason	Solution
After the device is turned on, the CEL LED always flashes quickly.	The signal is too weak. The device isn't registered to the network.	Move the device to a place with good network coverage.
Messages can't be reported to the backend server by network.	APN is not right.	Ask the network operator for the right APN.
	The IP address or port of the backend server is wrong.	Make sure the IP address for the backend server is an identified address in the internet.
There is no response from UART when the device is configured by using UART.	The port is not ready or the device is not powered on.	Please check the port and the device to ensure they are working properly.
The device can't get GPS fix.	The GPS signal is weak.	Move the device to a place under open sky.
		It is better to make the side with antenna face the sky.

7.2. Safety Info

- ◆ Do not disassemble the device by yourself.
- ◆ Do not put the device in the overheated or too humid place, and avoid exposure to direct sunlight. Too high temperature will damage the device or even cause battery explosion.
- ◆ Do not use the device on the airplane or near medical equipment.

8. Appendix: Supported Accessories

- ◆ DATA_CABLE_M
- ◆ 1-Wire temperature sensor
- ◆ Relay with socket
- ◆ RS232 Camera
- ◆ Antenna_GPS_SMA_3M
- ◆ UFS300
- ◆ Garmin
- ◆ RFID reader (DR102)
- ◆ DUT-E
- ◆ RF 433MHz accessories (WRT100, WTH100, WTS100)

FCC Statement :

Any Changes or modifications not expressly approved by the party responsible for compliance could void the user's authority to operate the equipment.

This device complies with part 15 of the FCC Rules. Operation is subject to the following two conditions:

- (1) This device may not cause harmful interference, and
- (2) this device must accept any interference received, including interference that may cause undesired operation.

FCC Radiation Exposure Statement: This equipment complies with FCC radiation exposure limits set forth for an uncontrolled environment. This equipment should be installed and operated with minimum distance 20cm between the radiator and your body.

FCC&ISED Label Instructions: If using a permanently affixed label, the modular transmitter must be labeled with its own FCC or ISED identification number, and, if the FCC or ISED identification number is not visible when the module is installed inside another device, then the outside of the device into which the module is installed must also display a label referring to the enclosed module. This exterior label can use wording such as the following: "Contains Transmitter Module FCC ID:XMR201805EC21AU,IC:10224A-20198EC21AU" Any similar wording that expresses the same meaning may be used. The Grantee may either provide such a label, an example of which must be included in the application for equipment authorization, or, must provide adequate instructions along with the module which explain this requirement.

Note: This equipment has been tested and found to comply with the limits for a Class B digital device, pursuant to part 15 of the FCC Rules. These limits are designed to provide reasonable protection against harmful interference in a residential installation. This equipment generates uses and can radiate radio frequency energy and, if not installed and used in accordance with the instructions, may cause harmful interference to radio communications. However, there is no guarantee that interference will not occur in a particular installation. If this equipment does cause harmful interference to radio or television reception, which can be determined by turning the equipment off and on, the user is encouraged to try to correct the interference by one or more of the following measures:

- Reorient or relocate the receiving antenna.
- Increase the separation between the equipment and receiver.
- Connect the equipment into an outlet on a circuit different from that to which the receiver is connected.
- Consult the dealer or an experienced radio/TV technician for help.