RF Test Report

Test in accordance with
Federal Communications Commission(FCC)
CFR TITLE 47, Parts 2, 22, 24

Product Name : GPS Locator
Model No. : GV300C
FCC ID : YQD-GV300C

Applicant : Quealink Wireless Solutions Co.,Ltd

Address : Room 501, Building 9, No 99, TianZhou Road,
Shanghai, China

Date of Receipt : 12-26-2013
Test Date : 01-07-2014~12-26-2013
Issued Date : 01-07-2014
Report No. : UL12620131226FCC004-2
Report Version : V1.0

Notes:

The test results only relate to these samples which have been tested.
Partly using this report will not be admitted unless been allowed by Unilab.
Unilab is only responsible for the complete report with the reported stamp of Unilab.

Test Report Certification

Issued Date : 01-07-2014
Report No. : UL12620131226FCC004-2

Product Name : GPS Locator
Applicant : Queclink Wireless Solutions Co.,Ltd
Address : Room 501, Building 9, No 99, TianZhou Road, Shanghai, China
Manufacturer : Queclink Wireless Solutions Co.,Ltd.
Address : Room 501, Building 9, No 99, TianZhou Road, Shanghai, China
Model No. : GV300C
EUT Voltage : Extreme Low:8, Nominal:12, Extreme High:32
Brand Name : Queclink
FCC ID: YQD-GV300C
Applicable Standard : FCC CFR Title 47 Part 2;
FCC CFR Title 47 Part 22 Subpart H;
FCC CFR Title 47 Part24 Subpart E;
ANSI/TIA-603-D-2010;
FCC KDB 971168 D01 Power Meas. License Digital Systems v02
Test Result : Complied
Performed Location : Unilab (Shanghai) Co., Ltd.
FCC 2.948 register number is 714465
No. 1350, Lianxi Rd. Pudong New District, Shanghai, China
TEL: +86-21-50275125 FAX: +86-21-50275126

Documented By :



(Technical Engineer: Andy Wei)

Reviewed By :



(Senior Engineer: Forest Cao)

Approved By :



(Supervisor: Eva Wang)

TABLE OF CONTENTS

SUMMARY OF TEST RESULT.....	4
1. General Information.....	5
1.1. EUT Description	5
1.2. Mode of Operation	7
1.3. Tested System Details	9
1.4. Configuration of Tested System.....	9
1.5. EUT Exercise Software	8
2. Technical Test.....	9
2.1. Test Environment	9
3. Peak Output Power	10
3.2. Test Setup	10
3.3. Limit	11
3.4. Test Procedure	12
3.5. Uncertainty	12
3.6. Test Result	13
4. Occupied Bandwidth	17
4.1. Test Equipment	17
4.2. Test Setup	17
4.3. Limit	18
4.4. Test Procedure	18
4.5. Uncertainty	18
4.6. Test Result	19
5. Spurious Emission At Antenna Terminals (+/- 1MHz)	23
5.1. Test Equipment	23
5.2. Test Setup	23
5.3. Limit	24
5.4. Test Procedure	24
5.5. Uncertainty	24
5.6. Test Result	25
6. Spurious Emission.....	27
6.1. Test Equipment	27
6.2. Test Setup	28
6.3. Limit	29
6.4. Test Procedure	29
6.5. Uncertainty	30
6.6. Test Result	31
7. Frequency Stability Under Temperature & Voltage Variations.....	37
7.1. Test Equipment	37
7.2. Test Setup	37
7.3. Limit	38
7.4. Test Procedure	38
7.5. Uncertainty	38
7.6. Test Result	39
8. Attachment.....	89

SUMMARY OF TEST RESULT

Report Section	FCC CFR 47	Description	Limit	Result
3	part2.1046	Conducted Output Power	N/A	PASS
3	part 22.913(a)(2)	Effective Radiated Power	<7 Watts	PASS
3	part 24.232(c)	Equivalent Isotropic Radiated Power	<2 Watts	PASS
3	part 24.232(d)	Peak-to-Average Ration	< 13dB	PASS
4	part 2.1049 part 22.917(a) part 24.238(a)	Occupied Bandwidth	N/A	PASS
5	part 2.1051 part 22.917(a) part 24.238(a)	Band Edge Measurement	<43+10lg(P[Watts])	PASS
6	part 2.1051 part 22.917(a) part 24.238(a)	Conducted Spurious Emission	<43+10lg(P[Watts])	PASS
6	part 2.1053 part 22.917(a) part 24.238(a)	Field Strength of Supurious Radiation	<43+10lg(P[Watts])	PASS
7	part 2.1055 part 22.355 part 24.235	Frequency Stability for Temperature & Voltage	<2.5 ppm	PASS

1.General Information

1.1. EUT Description

Product Name:	GPS Locator
Model Name:	GV300C
Hardware Version:	1.03
Software Version:	MRN
RF Exposure Environment:	Uncontrolled
CDMA2000	
Support Band:	CDMA2000 BC0/BC1 (do not support Ev-Do mode)
Tx Frequency Range:	CDMA2000 BC0: 824.70 MHz to 848.31MHz CDMA2000 BC1: 1851.25MHz to 1908.75MHz
Rx Frequency Range:	CDMA2000 BC0: 869.70 MHz to 893.31MHz CDMA2000 BC1: 1931.25MHz to 2153.75MHz
Type of modulation:	QPSK
Antenna Type:	Connector
Antenna Peak Gain:	CDMA2000 BC0: 1.0dBi CDMA2000 BC1: 1.0dBi GPS: 0.5dBi

Notes: The above EUT's information was declared by manufacturer. Please refer to the specifications or user's manual for more detailed description.

1.2. Mode of Operation

Unilab has verified the construction and function in typical operation. EUT is in link mode with base station emulator at maximum power level. All the test modes were carried out with the EUT in normal operation, which was shown in this test report and defined as:

Test Mode		
Band	Radiated TCs	Conducted TCs
CDMA2000 BC0	1xRTT Link Mode	1xRTT Link Mode
CDMA2000 BC1	1xRTT Link Mode	1xRTT Link Mode

Note:

- 1.The maximum RF output power levels are 1xRTT RC3+SO55 mode for CDMA2000 BC0, 1xRTT RC3+SO55 mode for CDMA2000 BC1; only these modes are used for all tests.
2. Regards to the frequency band operation: the lowest、 middle and highest frequency of channel were selected to perform the test, then shown on this report.
4. This device is a composite device in accordance with Part 15 Subpart B regulations. The report number is UL12620131226FCC004-2.

The conducted power table is as follows:

Conducted Power (Unit: dBm)						
Band	CDMA2000 BC0			CDMA2000 BC1		
Channel	1013	384	777	25	660	1175
Frequency	824.70	836.52	848.31	1851.25	1880	1908.75
1xRTT RC1+SO55	22.98	23.03	22.95	23.07	23.12	23.08
1xRTT RC3+SO55	23.10	23.08	23.02	23.13	23.15	23.12
1xRTT RC1+SO32(+ F-SCH)	23.01	22.94	22.88	23.10	23.06	23.08
1xRTT RC1+SO32(+ SCH)	22.95	22.65	22.68	23.08	23.01	22.97

1.3. Tested System Details

The types for all equipments, plus descriptions of all cables used in the tested system (including inserted cards) are:

Product	Manufacturer	Model	Serial No.	Power Cord
1 Agilent8960	Agilent	E5515C	GB46581718	N/A

1.4. Configuration of Tested System

Connection Diagram

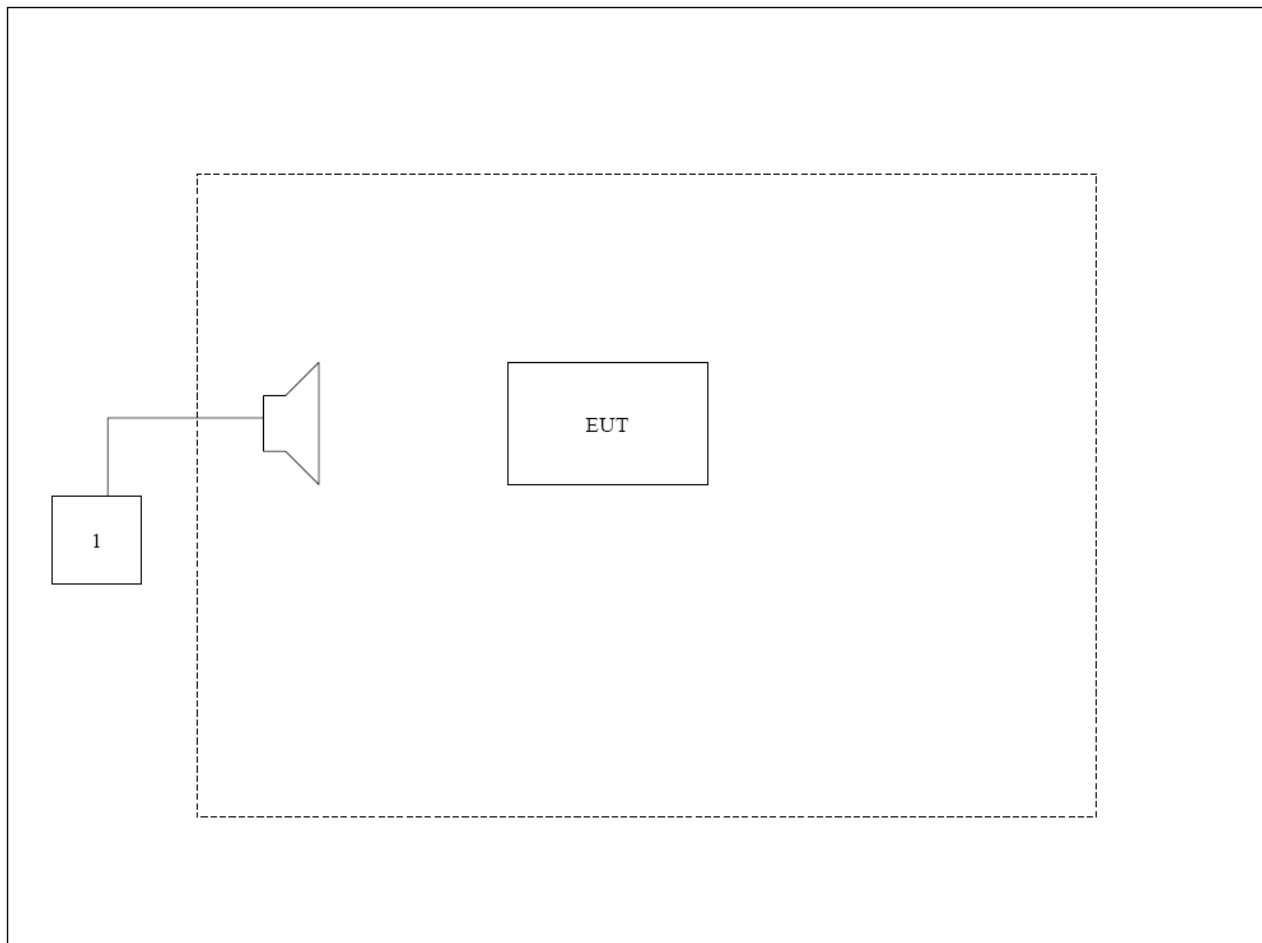

1.5. EUT Exercise Software

1	Setup the EUT and simulators as shown on above.
2	Turn on the power of all equipment.
3	EUT Communicate with E5515C, then select channel to test.

2. Technical Test

2.1. Test Environment

Items	Required (IEC 68-1)	Actual
Temperature (°C)	15-35	22
Humidity (%RH)	25-75	47
Barometric pressure (mbar)	860-1060	950-1000

3. Peak Output Power

3.1. Test Equipment

Instrument	Manufacturer	Model	Serial No.	Cali. Due Date
Spectrum Analyzer	Agilent	N9038A	MY51210142	2014.07.27
Radio Communication Tester	Agilent	E5515C	GB46581718	2014.10.24
Signal Generator	Agilent	N5183A	MY50140938	2014.10.07
Preamplifier	CEM	EM30180	3008A0245	2014.03.01
DC Power Supply	Agilent	6612C	MY43002989	2014.03.04
Bilog Antenna	Schwarzbeck	VULB9160	9160-3316	2014.07.19
VHF-UHF-Biconical Antenna	Schwarzbeck	VUBA9117	9117-263	2014.07.19
Broad-Band Horn Antenna	Schwarzbeck	BBHA9120D	9120D-942	2014.07.19
Broad-Band Horn Antenna	Schwarzbeck	BBHA9120D	9120D-943	2014.07.19

3.2. Test Setup

Conducted Power Measurement:

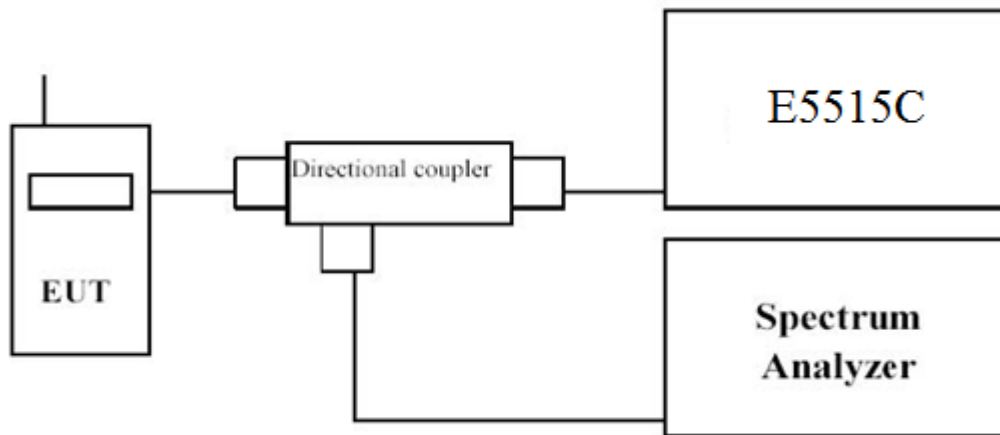

Radiated Spurious Measurement: below 1GHz

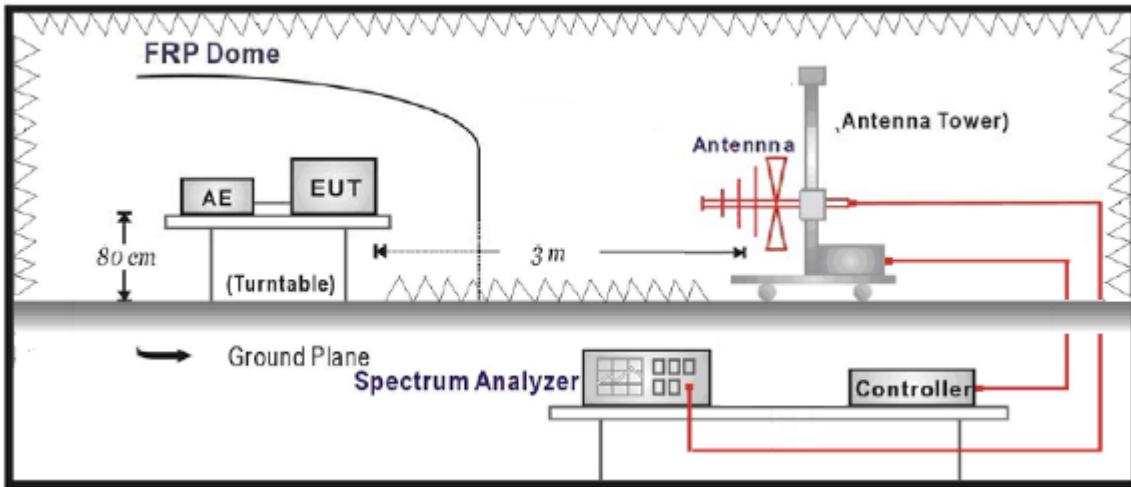

Radiated Spurious Measurement: above 1GHz

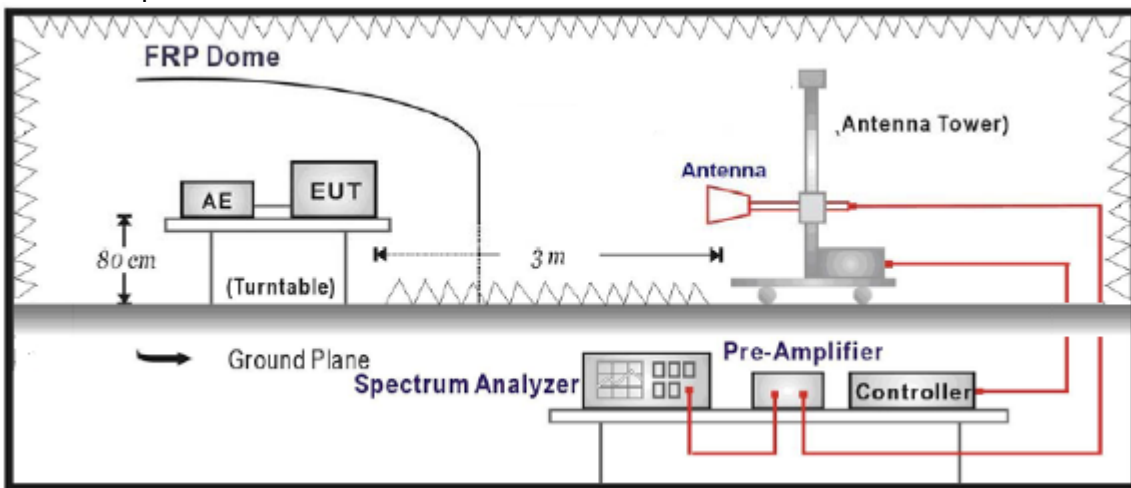

3.3. Limit

For FCC Part 22.913(a)(2):

The ERP of mobile transmitters and auxiliary test transmitters must not exceed 7 Watts.

For FCC Part 24.232(c):

The EIRP of mobile transmitters and auxiliary test transmitters must not exceed 2 Watts.

For FCC Part 24.232(d):

The PAPR of mobile transmitters and auxiliary test transmitters must not exceed 13 dB.

3.4. Test Procedure

Conducted Power Measurement:

- a. Place the EUT on a bench and set it in transmitting mode.
- b. Connect a low loss RF cable from the antenna port to a spectrum analyzer and E5515C by a Directional Couple.
- c. EUT Communicate with E5515C, then selects a channel for testing.
- d. Add a correction factor to the display of spectrum, and then test.

Radiated Power Measurement:

- a. The EUT was placed on an non-conductive rotating platform with 0.8 meter height in a semi-anechoic chamber. The radiated emission at the fundamental frequency was measured at 3m with a test antenna and a spectrum analyzer with RBW = 30kHz, VBW = 100kHz, and RMS detector settings per section 4.0 of KDB 971168 D01
- b. During the measurement, the EUT was enforced in maximum power and linked with a base station. The highest emission was recorded from analyzer power level from the 360 degrees rotation of the turntable and the test antenna raised and lowered over a range from 1 to 4 meters in both horizontally and vertically polarized orientations.
- c. Effective Isotropic Radiated Power(EIRP) was measured by substitution method according to TIA/EIA-603-C. The EUT was replaced by dipole antenna (substitution antenna) at same location, and then a known power from S.G. was applied into the dipole antenna through a Tx cable, and then recorded the maximum Analyzer reading through raised and lowered the test antenna. The correction factor (in dB) = S.G. – Tx Cable loss +Substitution antenna gain – Analyzer reading. Then the EUT's EIRP was calculated with the correction factor, $EIRP = \text{The reading value from analyzer power level} + \text{Correction factor}$ and $ERP = EIRP - 2.15$.

Peak to Average Power Ratio Measurement:

- a. Place the EUT on a bench and set it in transmitting mode.
- b. Connect a low loss RF cable from the antenna port to a spectrum analyzer and E5515C by a Directional Couple.
- c. Using the CCDF function in spectrum analyzer to measure it per section 5.7.1 of KDB 971168 D01

3.5. Uncertainty

The measurement uncertainty is defined as for Conducted Power Measurement ± 1.1 dB,
for Radiated Power Measurement ± 3.1 dB

3.6. Test Result

The following table shows the conducted power measured:

CDMA 2000 BC0					
Test Mode	Test Status	Channel	Frequency (MHz)	Conducted Power (dBm)	Conducted Power (W)
CDMA 2000 1xRTT	RC3+So55	1013(Low)	824.70	23.10	0.21
		384(Mid)	836.52	23.08	0.20
		777(High)	848.31	23.02	0.20

CDMA 2000 BC1					
Test Mode	Test Status	Channel	Frequency (MHz)	Conducted Power (dBm)	Conducted Power (W)
CDMA 2000 1xRTT	RC3+So55	25(Low)	1851.25	23.13	0.21
		600(Mid)	1880.00	23.15	0.21
		1175(High)	1908.75	23.12	0.21

The following table shows the Radiated Power measured:

CDMA2000 BC0 (1XRTT_RC3+SO55)

Frequency (MHz)	Ant. Pol. (H/V)	SG Reading (dBm)	Cable Loss (dB)	Gain (dBd)	ERP (dBm)	ERP (W)
Low Channel 1013 (824.70MHz)						
824.70	H	27.25	3.81	-2.99	20.45	0.11
824.70	V	27.28	3.81	-2.99	20.48	0.11
Middle Channel 384 (836.52MHz)						
836.52	H	27.49	3.96	-3.04	20.49	0.11
836.52	V	28.10	3.96	-3.04	21.10	0.13
High Channel 777 (848.31MHz)						
848.31	H	27.92	3.98	-3.10	20.84	0.12
848.31	V	27.62	3.98	-3.10	20.54	0.11

CDMA2000 BC1 (1XRTT_RC3+SO55)

Frequency (MHz)	Ant. Pol. (H/V)	SG Reading (dBm)	Cable Loss (dB)	Gain (dBi)	EIRP (dBm)	EIRP (W)
Low Channel 25(1851.25MHz)						
1851.25	H	17.75	6.26	10.40	21.89	0.15
1851.25	V	20.54	6.26	10.40	24.68	0.29
Middle Channel 600 (1880.00MHz)						
1880.0	H	17.29	6.19	10.43	21.53	0.14
1880.0	V	20.51	6.19	10.43	24.75	0.30
High Channel 1175 (1908.75MHz)						
1908.75	H	17.09	6.15	10.44	21.38	0.14
1908.75	V	20.08	6.15	10.44	24.37	0.27

The following test plots show the Peak to Average Power Ratio measured:

CDMA2000 BC1 (1XRTT_RC3+SO55), channel 25

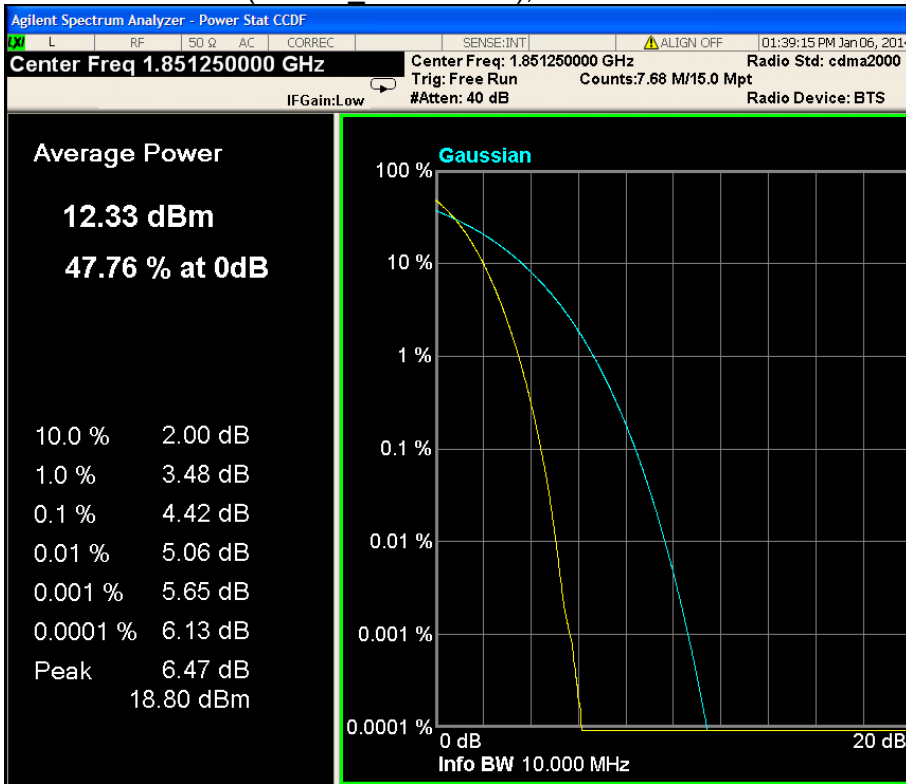

CDMA2000 BC1 (1XRTT_RC3+SO55), channel 600

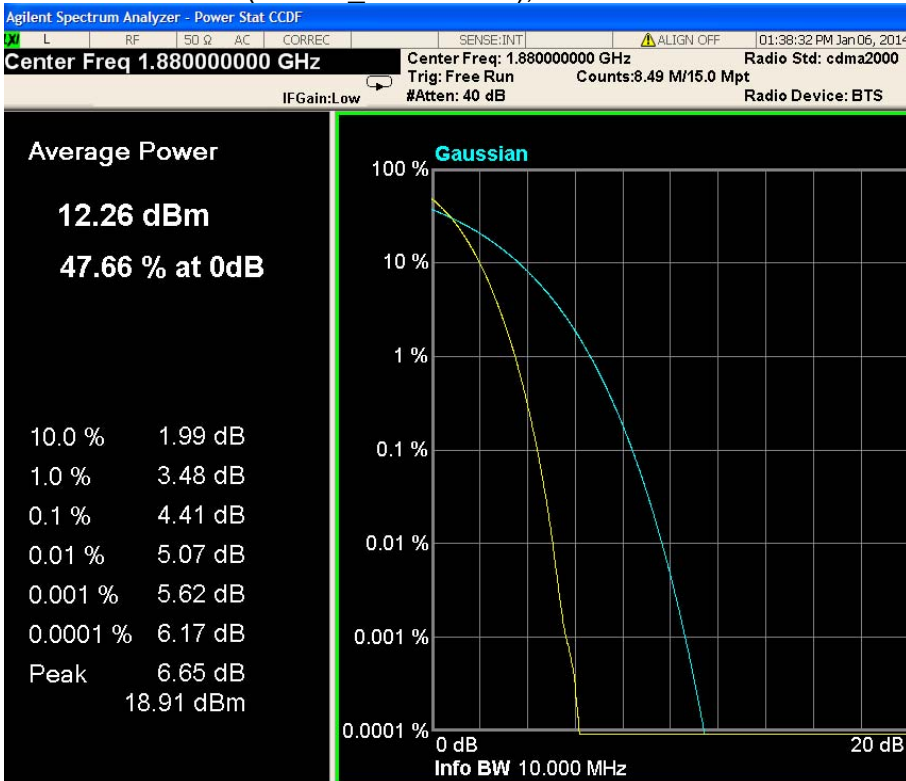

CDMA2000 BC1 (1XRTT_RC3+SO55), channel 1175

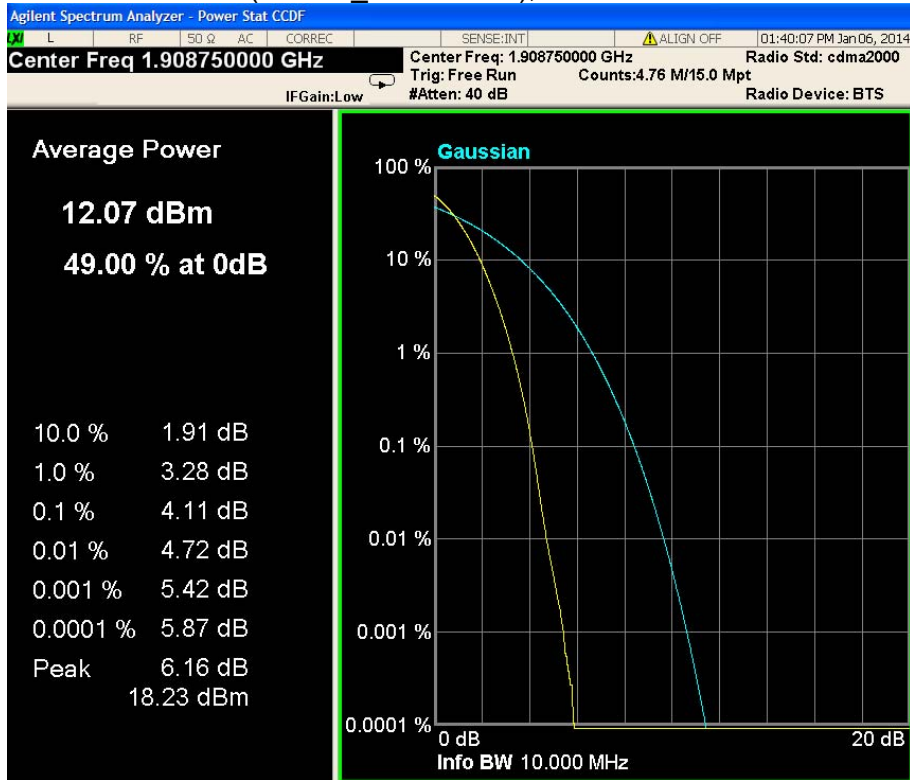

4. Occupied Bandwidth

4.1. Test Equipment

Occupied Bandwidth

Instrument	Manufacturer	Model	Serial No	Cal. Date
Radio Communication Tester	Agilent	E5515C	GB46581718	2014.10.24
Spectrum Analyzer	Agilent	N9038A	MY51210142	2014.07.27
DC Power Supply	Agilent	6612C	MY43002989	2014.03.04

4.2. Test Setup

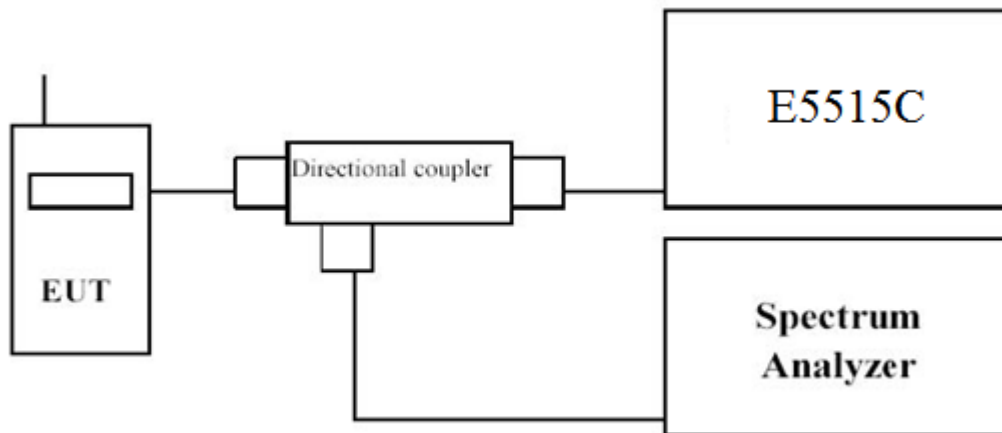

4.3. Limit

N/A

4.4. Test Procedure

Using Occupied Bandwidth measurement function of spectrum analyzer, and setting as follows:
For CDMA2000 BC0/ BC1 test --- RBW = 30 kHz and VBW = 100 kHz

4.5. Uncertainty

The measurement uncertainty is defined as ± 10 Hz

4.6. Test Result

CDMA2000 BC0 (1XRTT_RC3+SO55)

Channel No.	Frequency (MHz)	-26dB Occupied Bandwidth (MHz)	99% Occupied Bandwidth (MHz)
1013	824.70	1.425	1.270
384	836.52	1.418	1.272
777	848.31	1.434	1.268

Channel 1013

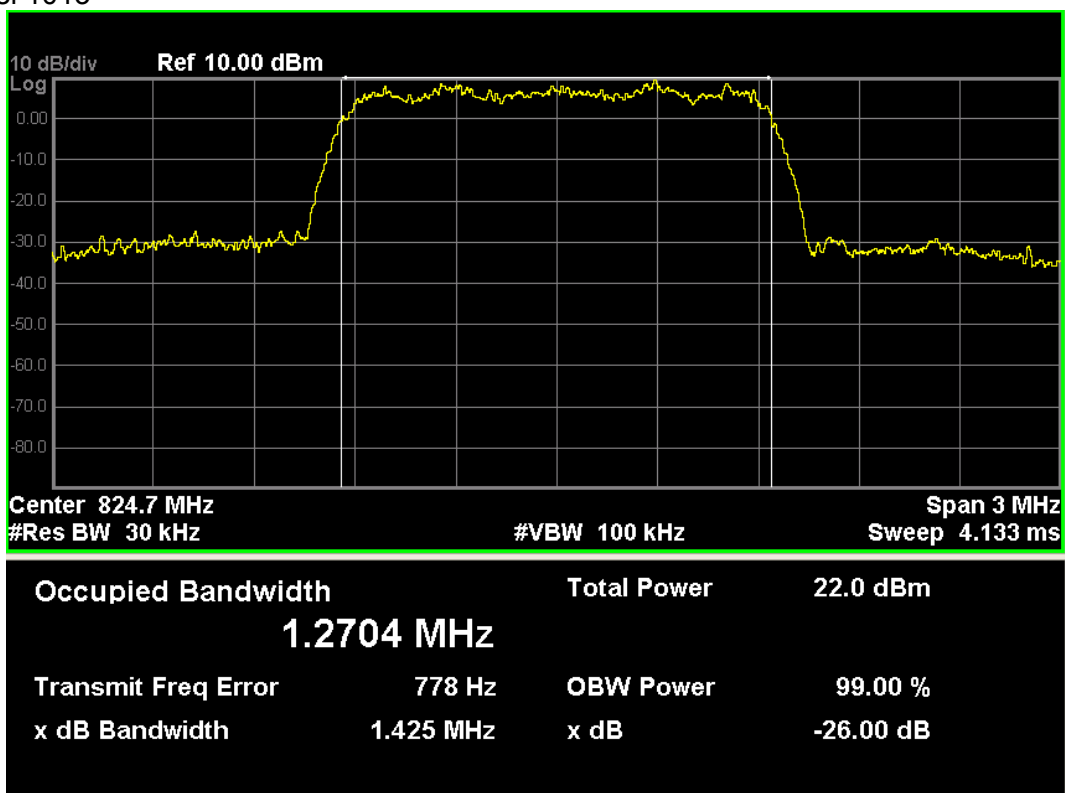

Channel 384

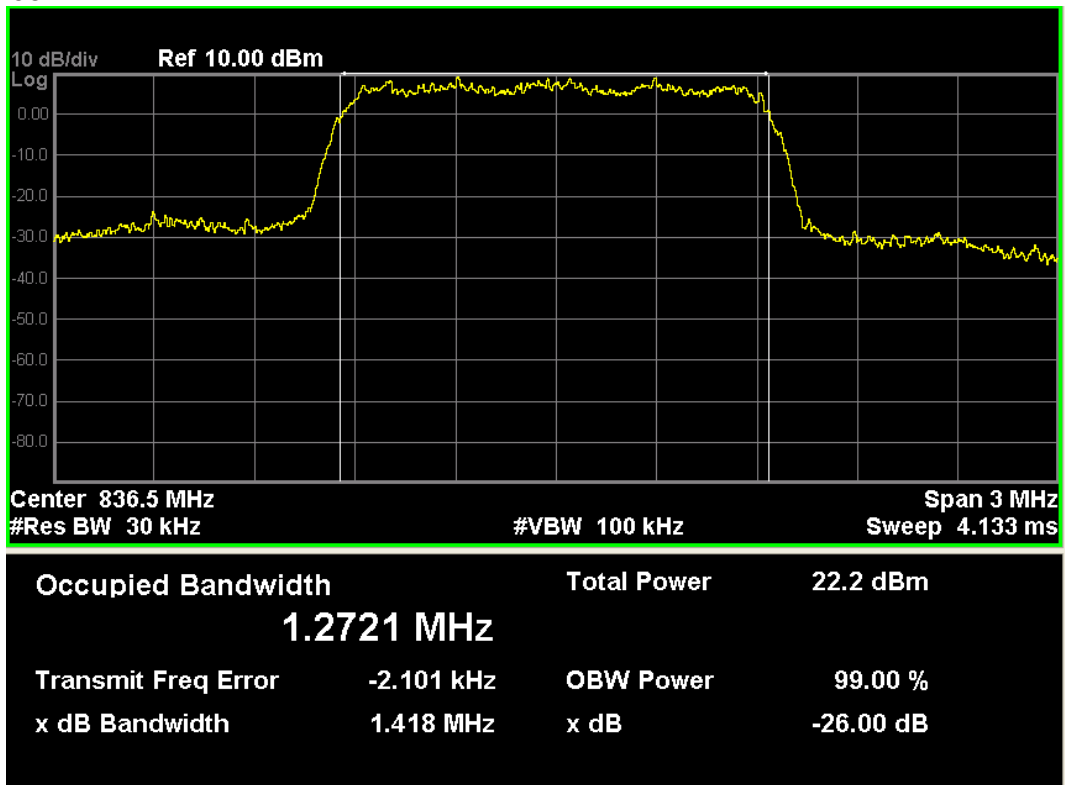

Channel 777

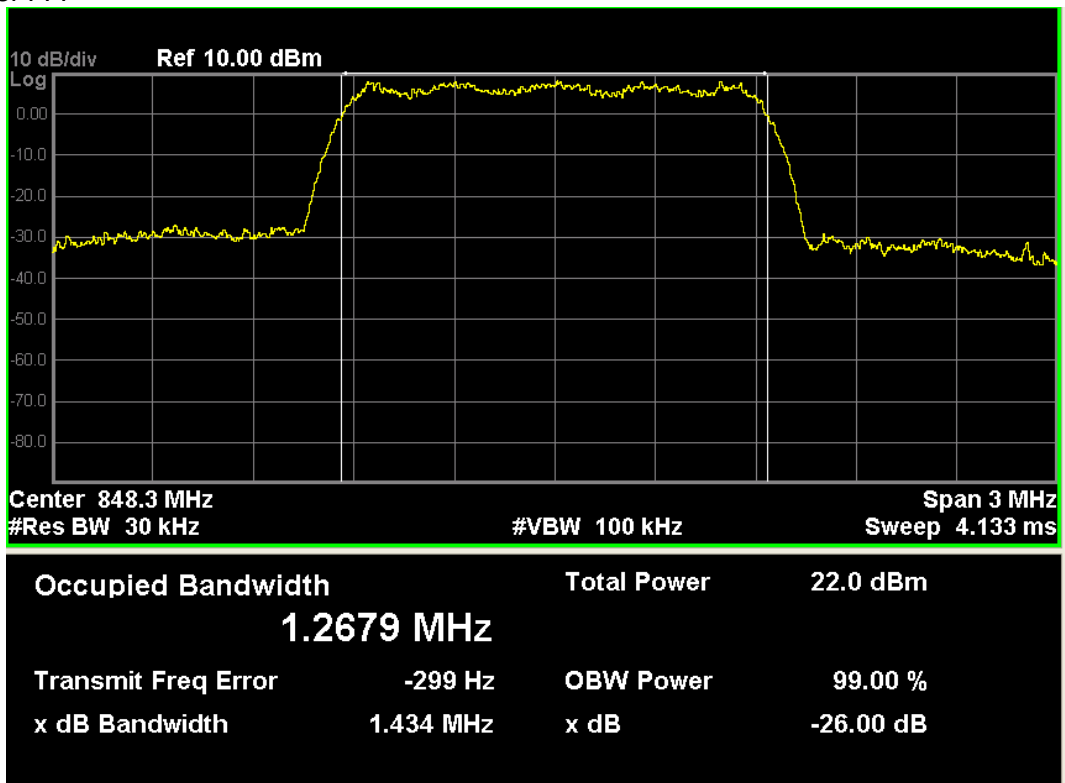

CDMA2000 BC1 (1XRTT_RC3+SO55)

Channel No.	Frequency (MHz)	-26dB Occupied Bandwidth (MHz)	99% Occupied Bandwidth (MHz)
25	1851.25	1.419	1.272
600	1880.00	1.421	1.270
1175	1908.75	1.425	1.270

Channel 25

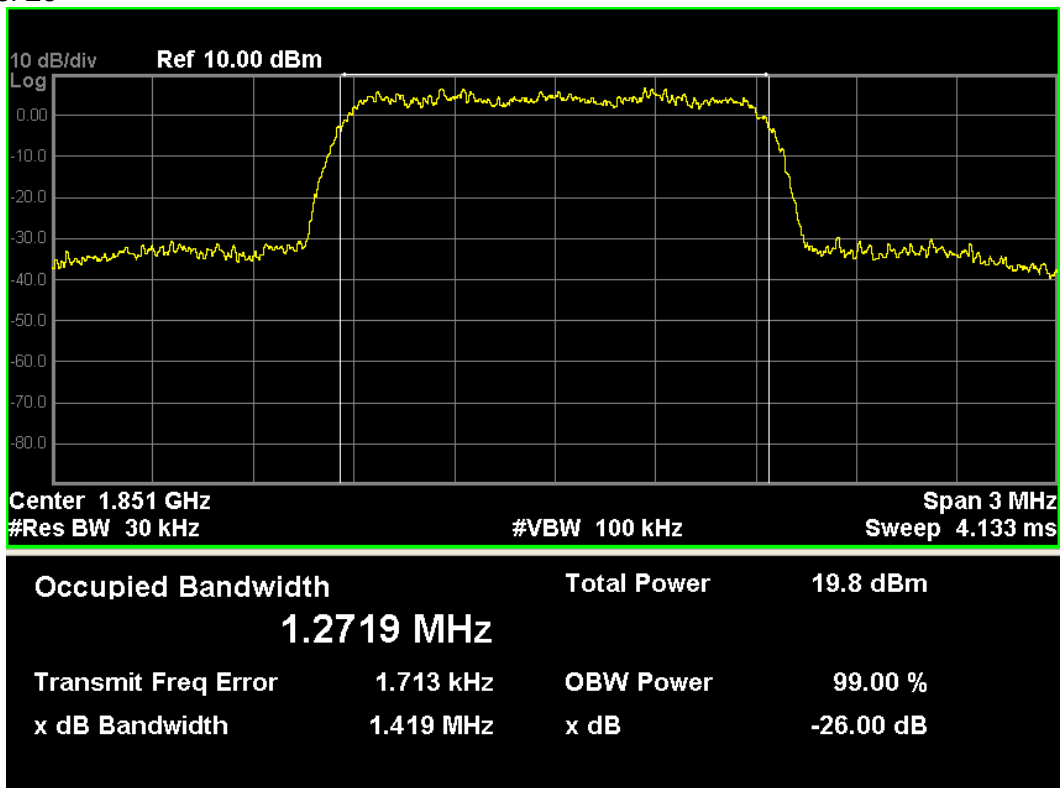

Channel 600

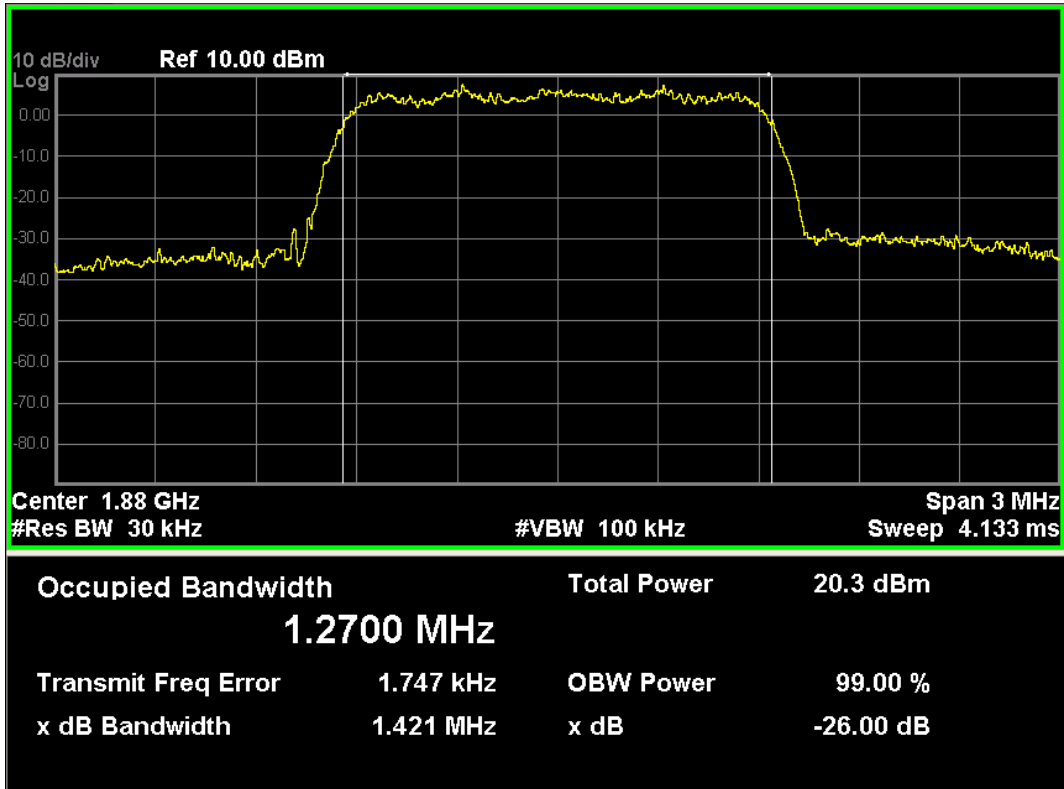

Channel 1175

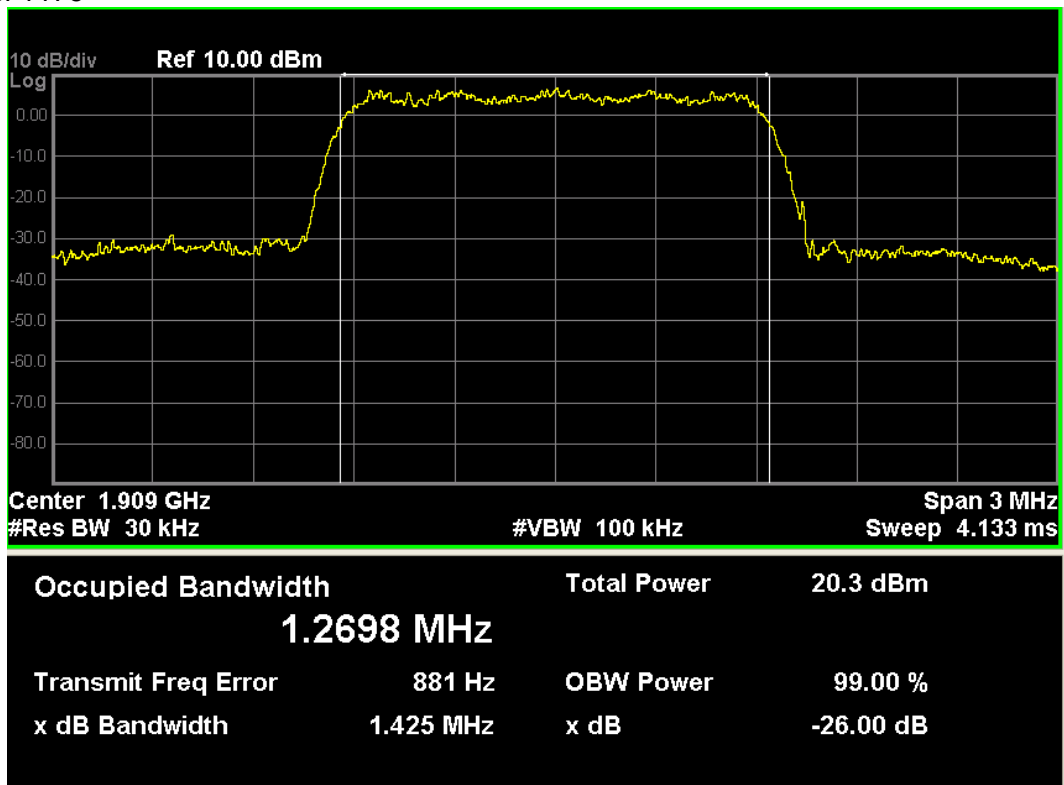

5. Spurious Emission At Antenna Terminals (+/- 1MHz)

5.1. Test Equipment

Instrument	Manufacturer	Model	Serial No	Cal. Date
Radio Communication Tester	Agilent	E5515C	GB46581718	2014.10.24
Spectrum Analyzer	Agilent	N9038A	MY51210142	2014.07.27
DC Power Supply	Agilent	6612C	MY43002989	2014.03.04

5.2. Test Setup

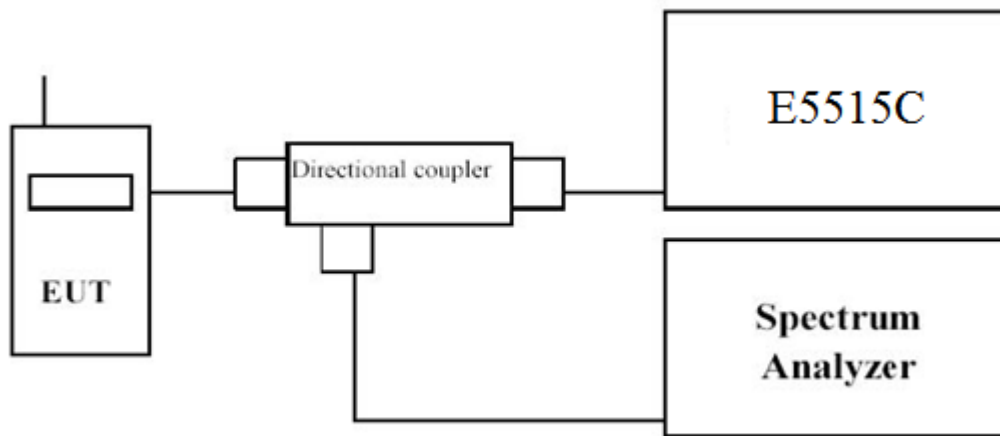

5.3. Limit

The power of any emission outside of the authorized operating frequency ranges must be attenuated below the transmitting power (P) by a factor of at least $43 + 10\log(P)$ dB.

5.4. Test Procedure

In the 1MHz bands immediately outside and adjacent to the frequency block a resolution bandwidth of at least one percent of the emission bandwidth of the fundamental emission of the transmitter may be employed to measure the out of band Emissions.

5.5. Uncertainty

The measurement uncertainty is defined as ± 1.2 dB.

5.6. Test Result

CDMA2000 BC0 (1XRTT_RC3+SO55), Channel 1013

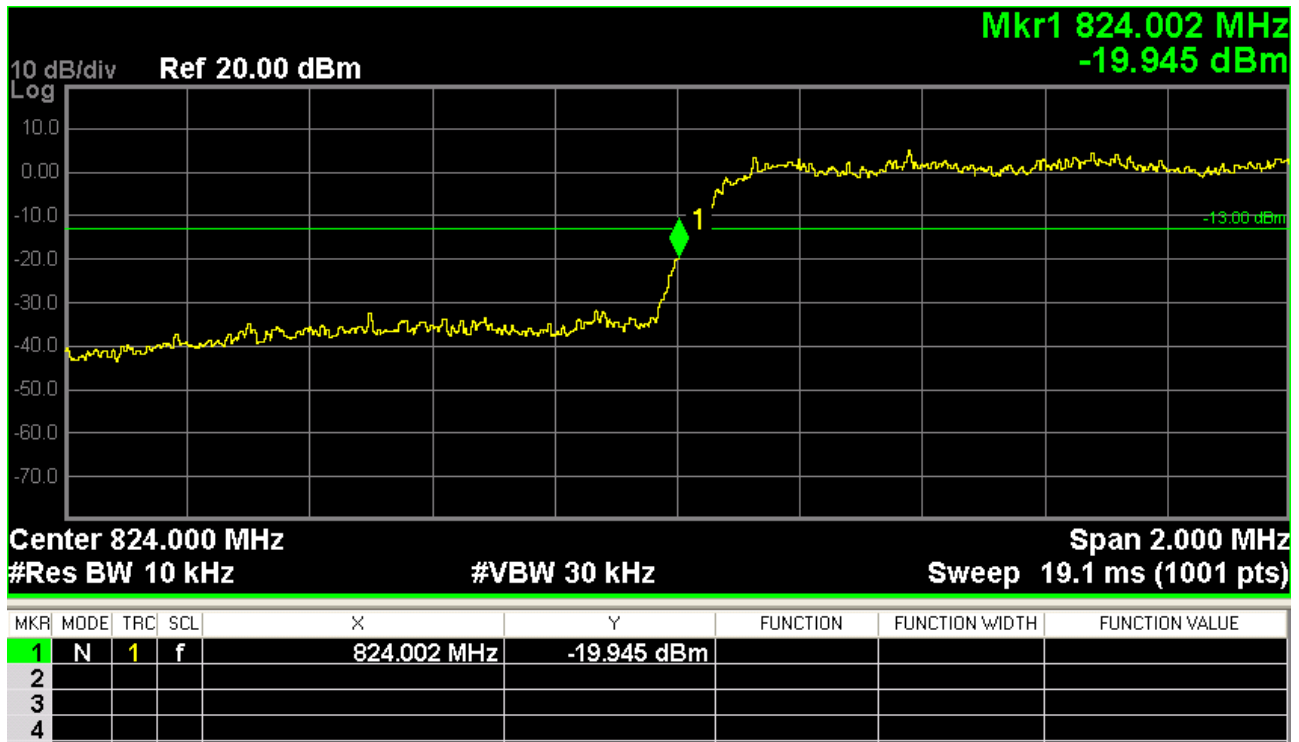

CDMA2000 BC0 (1XRTT_RC3+SO55), Channel 777

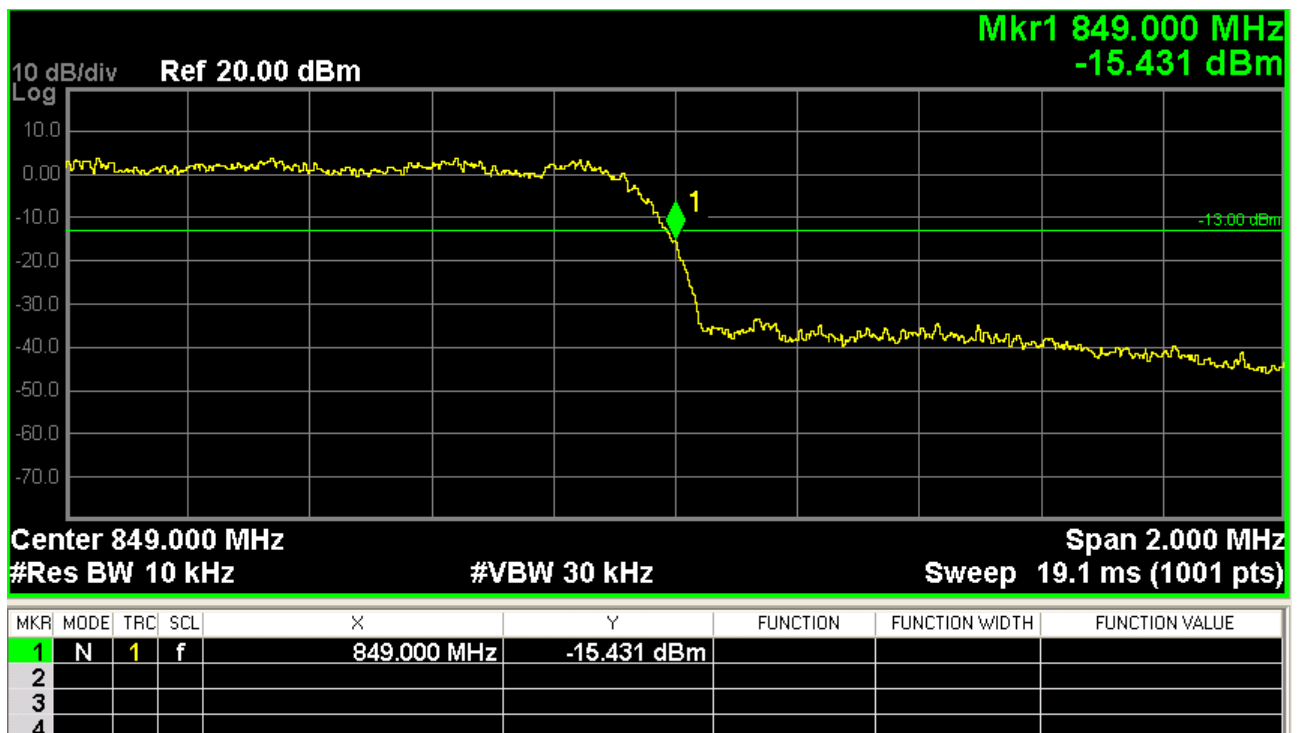

CDMA2000 BC1 (1XRTT_RC3+SO55), Channel 25

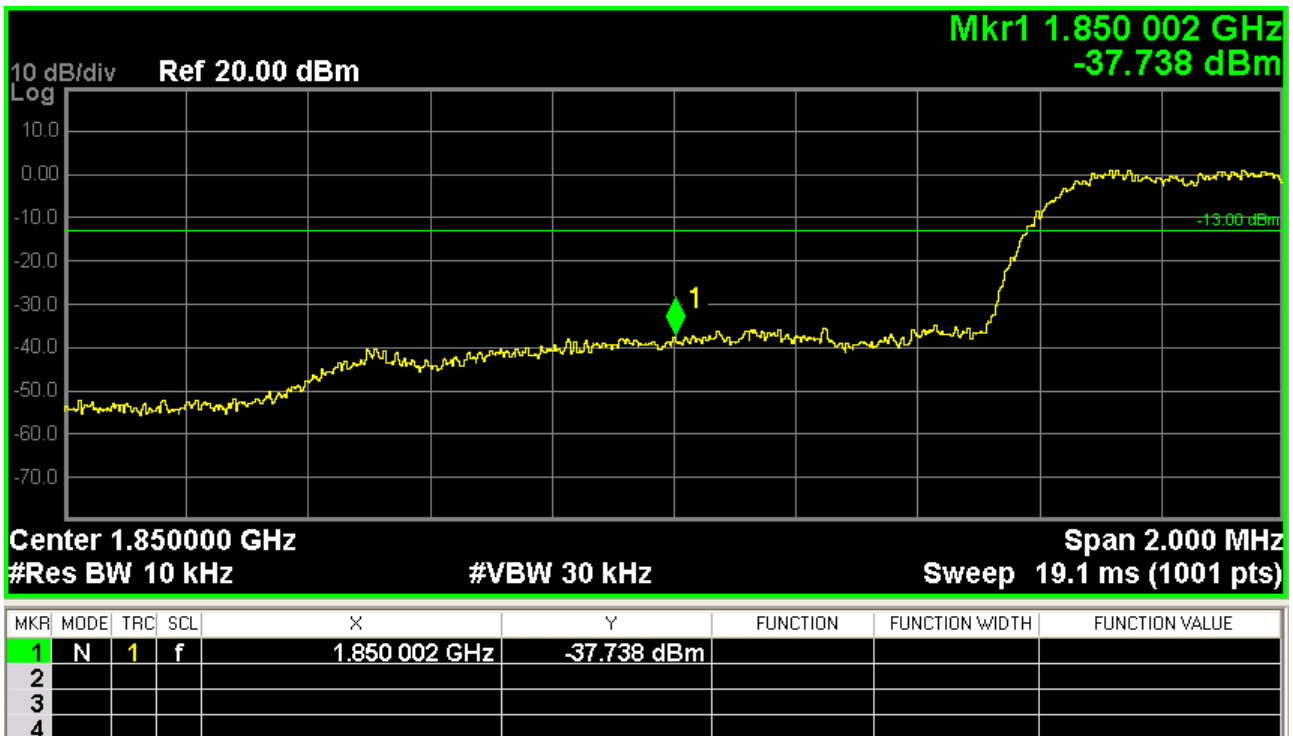

CDMA2000 BC1 (1XRTT_RC3+SO55), Channel 1175

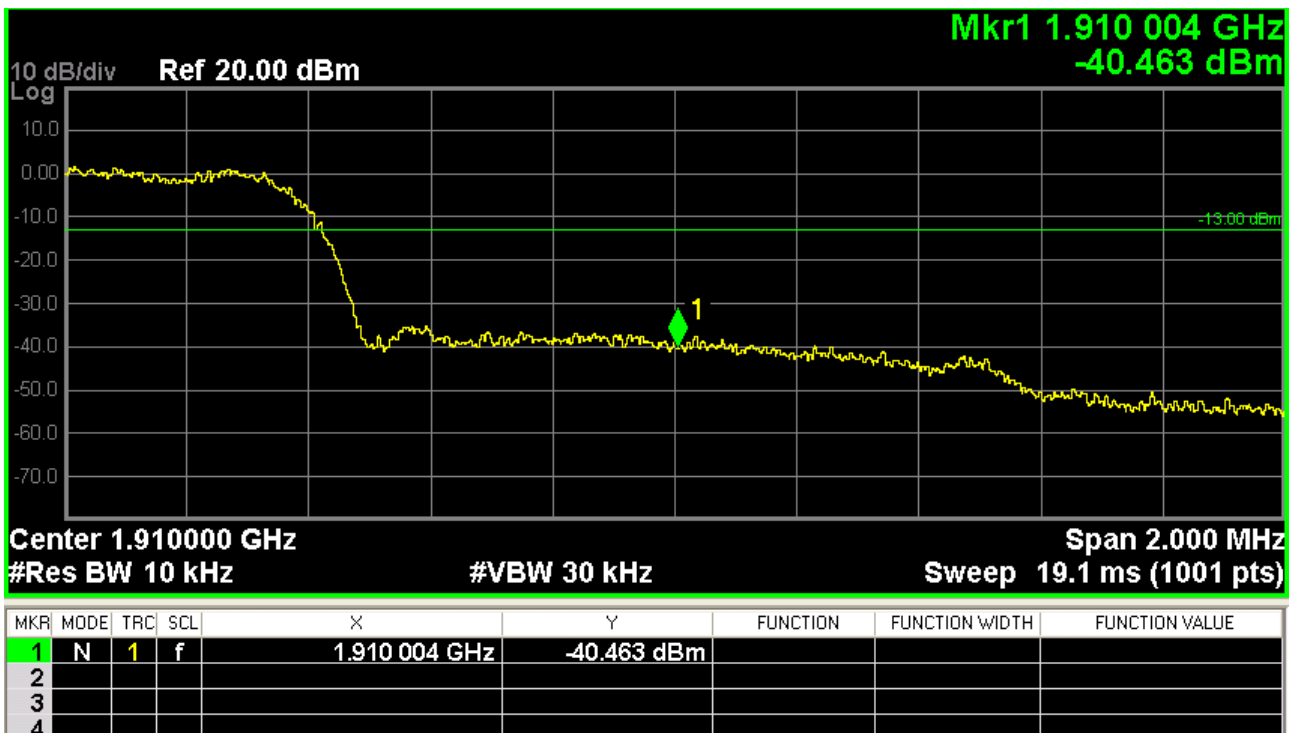

6. Spurious Emission

6.1. Test Equipment

Instrument	Manufacturer	Model	Serial No.	Cali. Due Date
Spectrum Analyzer	Agilent	N9038A	MY51210142	2014.07.27
Radio Communication Tester	Agilent	E5515C	GB46581718	2014.10.24
Signal Generator	Agilent	N5183A	MY50140938	2014.10.07
Preamplifier	CEM	EM30180	3008A0245	2014.03.01
DC Power Supply	Agilent	6612C	MY43002989	2014.03.04
Bilog Antenna	Schwarzbeck	VULB9160	9160-3316	2014.07.19
VHF-UHF-Biconical Antenna	Schwarzbeck	VUBA9117	9117-263	2014.07.19
Broad-Band Horn Antenna	Schwarzbeck	BBHA9120D	9120D-942	2014.07.19
Broad-Band Horn Antenna	Schwarzbeck	BBHA9120D	9120D-943	2014.07.19
Loop Antenna	Schwarzbeck	FMZB1519	1519-020	2014/03/27

6.2. Test Setup

Conducted Spurious Emission Measurement:

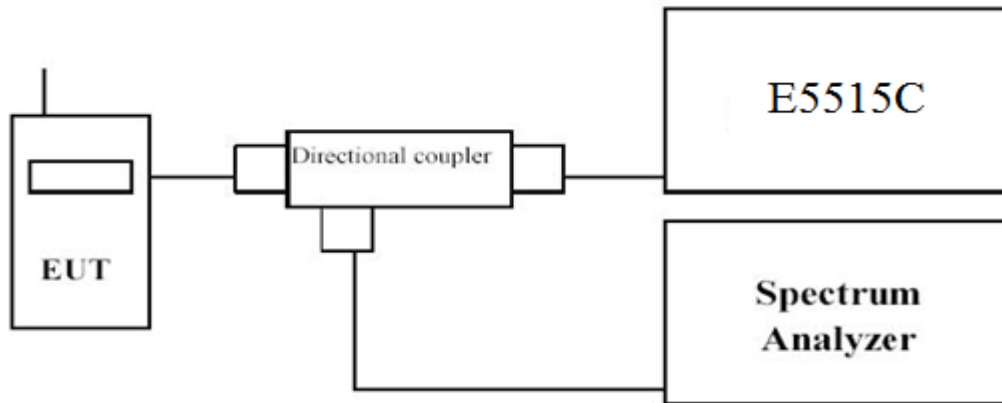

Radiated Spurious Measurement: below 30MHz

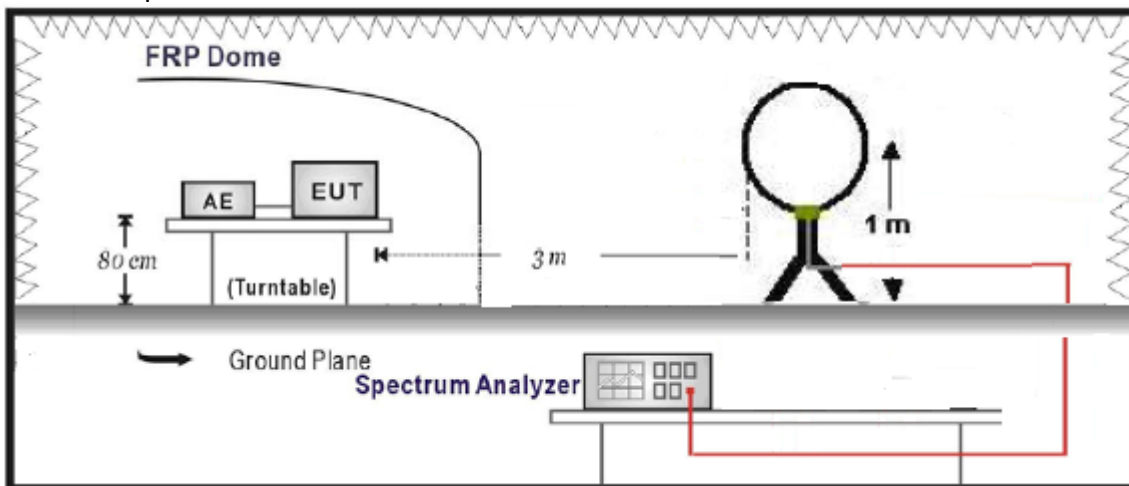

Radiated Spurious Measurement: 30MHz to 1GHz

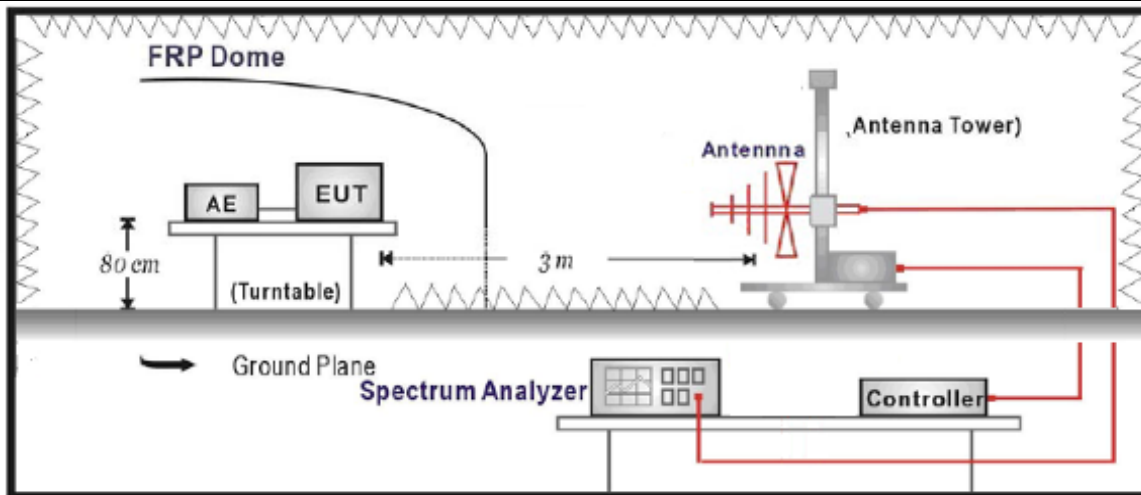

Radiated Spurious Measurement: above 1GHz

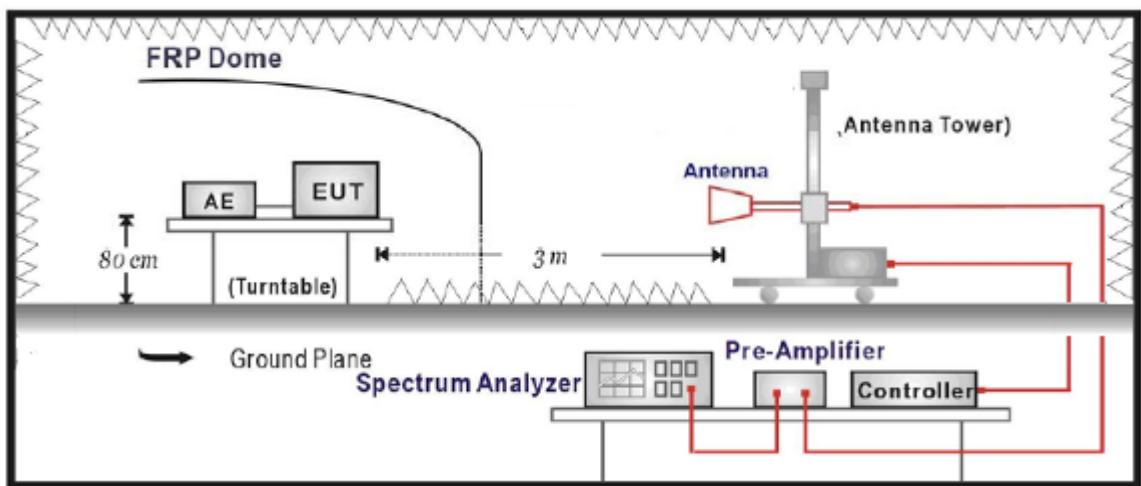

6.3. Limit

The power of any emission outside of the authorized operating frequency ranges must be attenuated below the transmitting power (P) by a factor of at least $43 + 10\log(P)$ dB.

6.4. Test Procedure

Conducted Spurious Measurement:

- Place the EUT on a bench and set it in transmitting mode.
- Connect a low loss RF cable from the antenna port to a spectrum analyzer and E5515C by a Directional Couple.
- EUT Communicate with E5515C, then select a channel for testing.
- Add a correction factor to the display of spectrum, and then test.

- e. The resolution bandwidth of the spectrum analyzer was set at 1 MHz, sufficient scans were taken to show the out of band Emission if any up to 10th harmonic.

Radiated Spurious Measurement:

- a. The EUT shall be placed at the specified height on a support, and in the position closest to normal use as declared by provider.
- b. The test antenna shall be oriented initially for vertical polarization and shall be chosen to correspond to the frequency of the transmitter
- c. The output of the test antenna shall be connected to the measuring receiver. The transmitter shall be switched on and the measuring receiver shall be tuned to the frequency of the transmitter under test.
- d. The test antenna shall be raised and lowered through the specified range of height until a maximum signal level is detected by the measuring receiver.
- e. The transmitter shall then be rotated through 360° in the horizontal plane, until the maximum signal level is detected by the measuring receiver.
- f. The test antenna shall be raised and lowered again through the specified range of height until a maximum signal level is detected by the measuring receiver.
- h. The maximum signal level detected by the measuring receiver shall be noted.
- i. The transmitter shall be replaced by a substitution antenna.
- j. The substitution antenna shall be orientated for vertical polarization and the length of the substitution antenna shall be adjusted to correspond to the frequency of the transmitter.
- k. The substitution antenna shall be connected to a calibrated signal generator.
- l. If necessary, the input attenuator setting of the measuring receiver shall be adjusted in order to increase the sensitivity of the measuring receiver.
 - m. The test antenna shall be raised and lowered through the specified range of height to ensure that the maximum signal is received.
- n. The input signal to the substitution antenna shall be adjusted to the level that produces a level detected by the measuring receiver, that is equal to the level noted while the transmitter radiated power was measured, corrected for the change of input attenuator setting of the measuring receiver.
- o. The measurement shall be repeated with the test antenna and the substitution antenna orientated for horizontal polarization.
- p. The measure of the effective radiated power is the larger of the two levels recorded at the input to the substitution antenna, corrected for gain of the substitution antenna if necessary.
- q. The frequency range was checked up to 10th harmonic.
- r. Test site anechoic chamber refer to ANSI C63.4: 2009

6.5. Uncertainty

The measurement uncertainty is defined as 3.2 dB for Radiated Power Measurement.

6.6. Test Result

Conducted Spurious Measurement:

CDMA2000 BC0 (1XRTT_RC3+SO55), Channel 384:

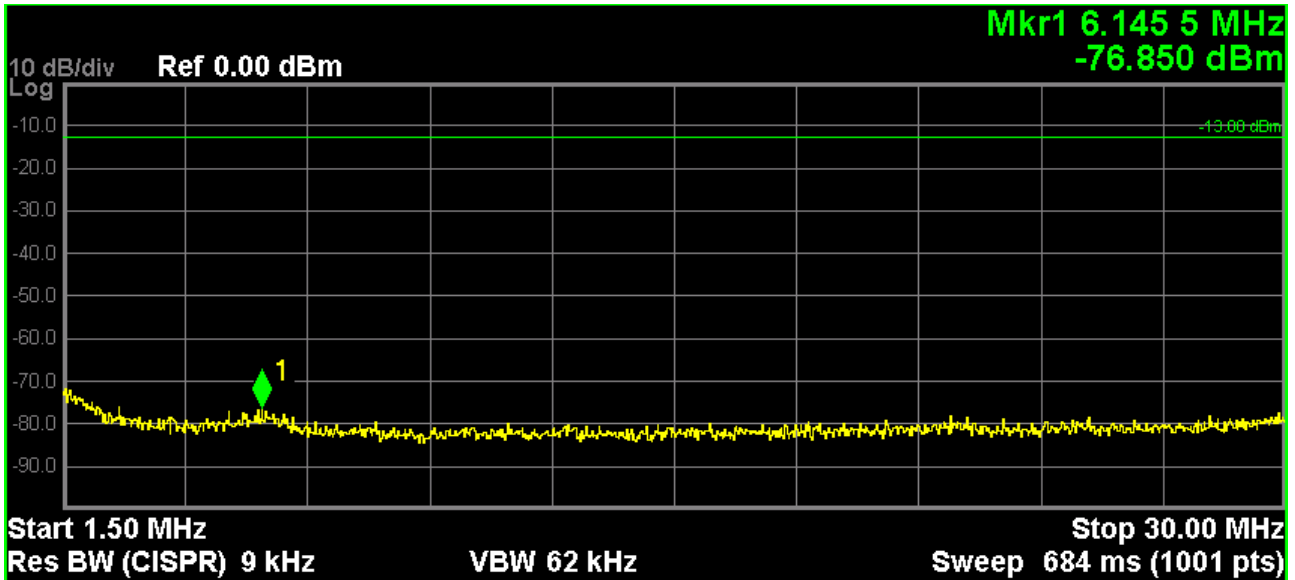

MKR	MODE	TRC	SCL	X	Y	FUNCTION	FUNCTION WIDTH	FUNCTION VALUE
1	N	1	f	6.145 5 MHz	-76.850 dBm			
2								
3								
4								

Note: There is not any harmonic but for background noise below 30 MHz.

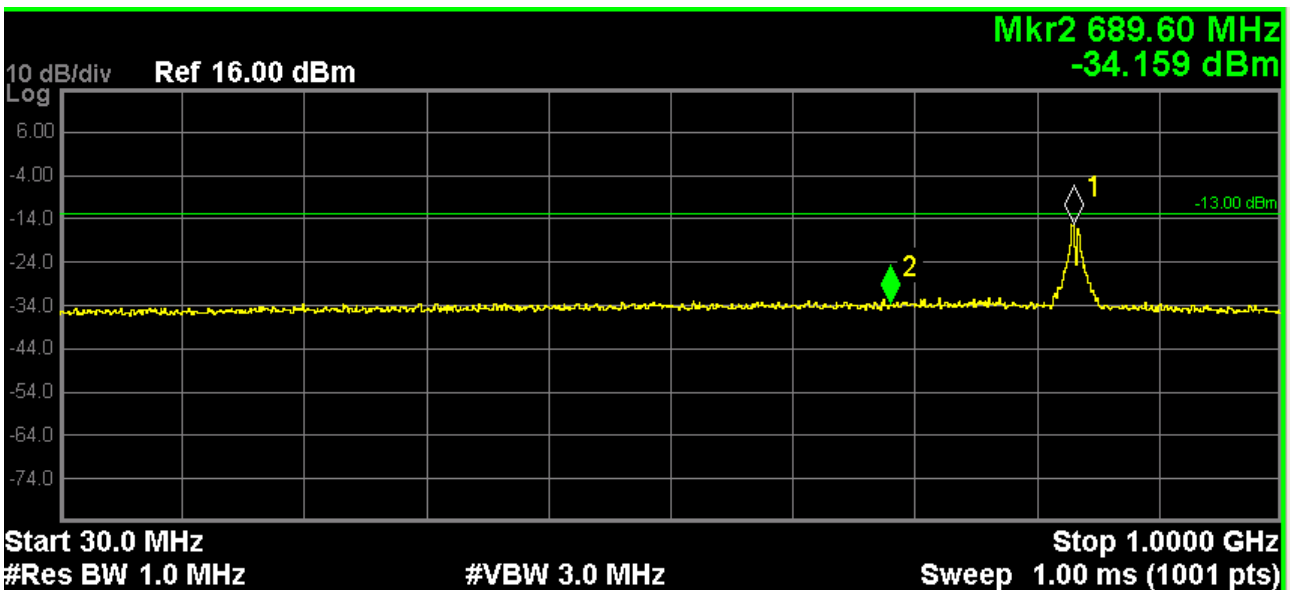

MKR	MODE	TRC	SCL	X	Y	FUNCTION	FUNCTION WIDTH	FUNCTION VALUE
1	N	1	f	835.10 MHz	-15.686 dBm			
2	N	1	f	689.60 MHz	-34.159 dBm			
3								
4								

Note: The signal at point 1 is carrier

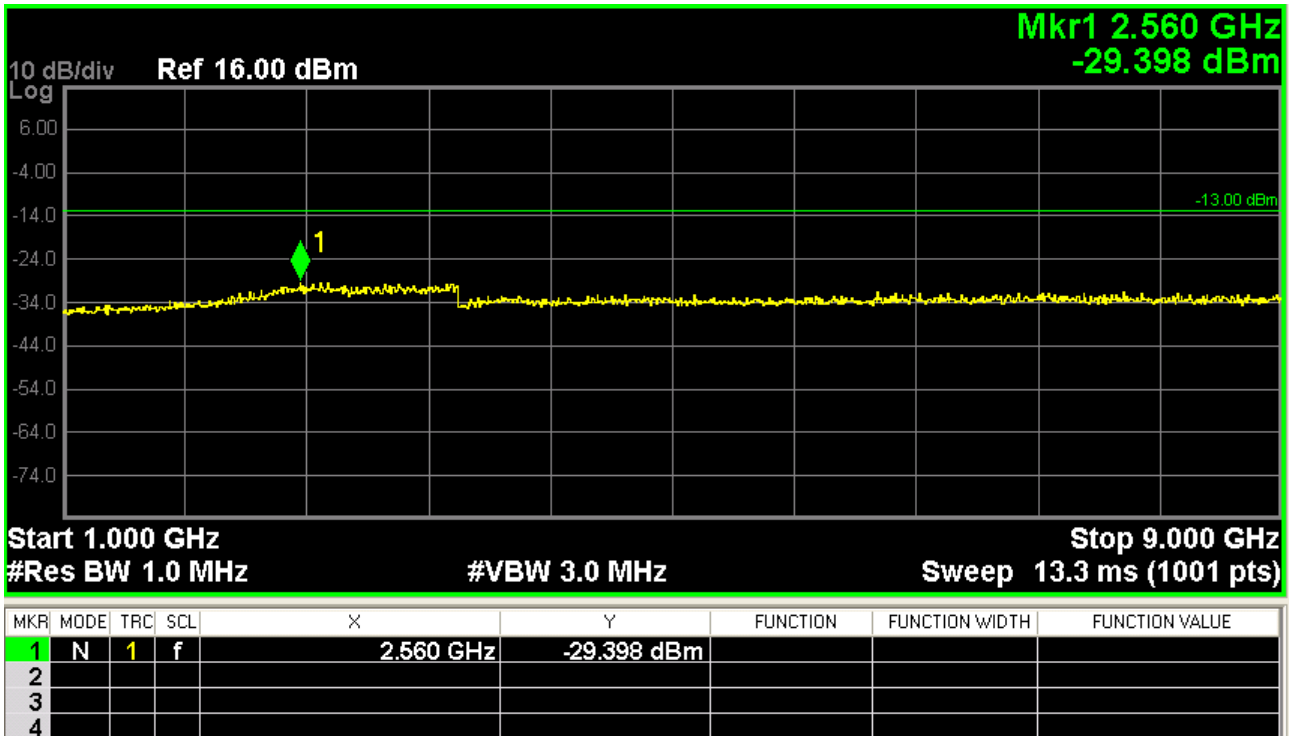

CDMA2000 BC1 (1XRTT_RC3+SO55), Channel 600:

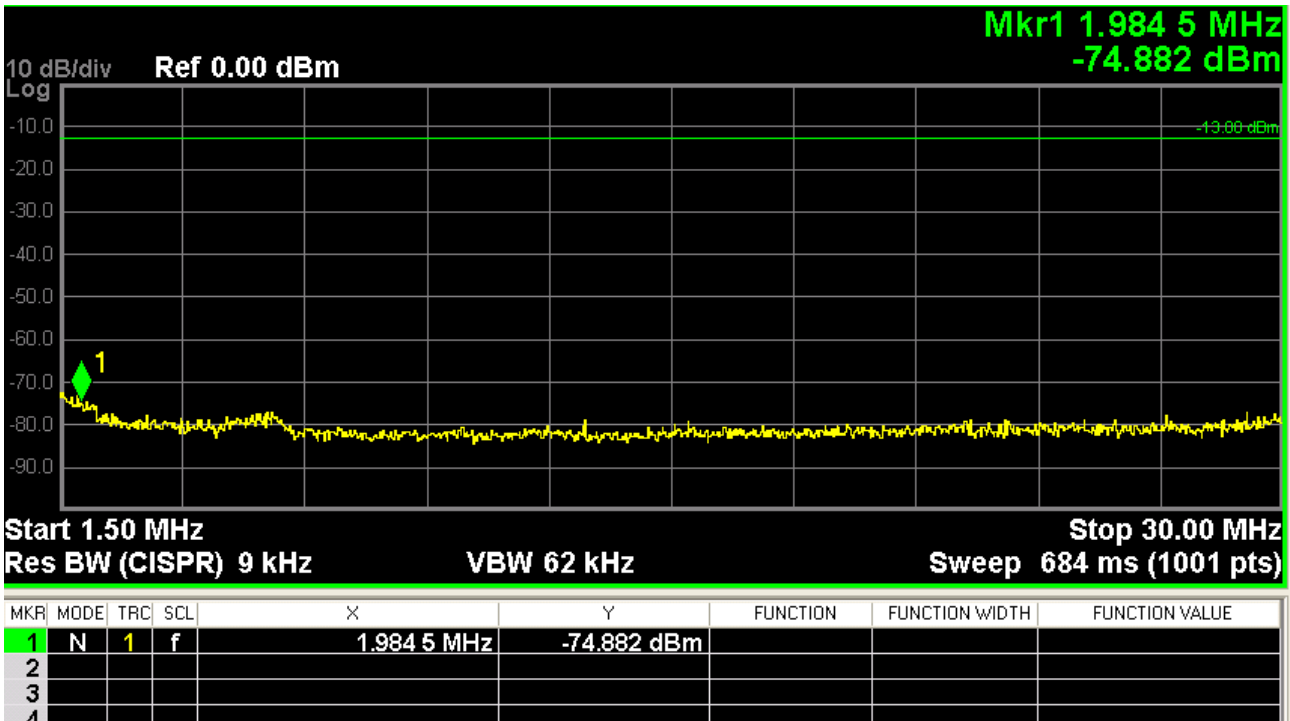

Note: There is not any harmonic but for background noise below 30 MHz.

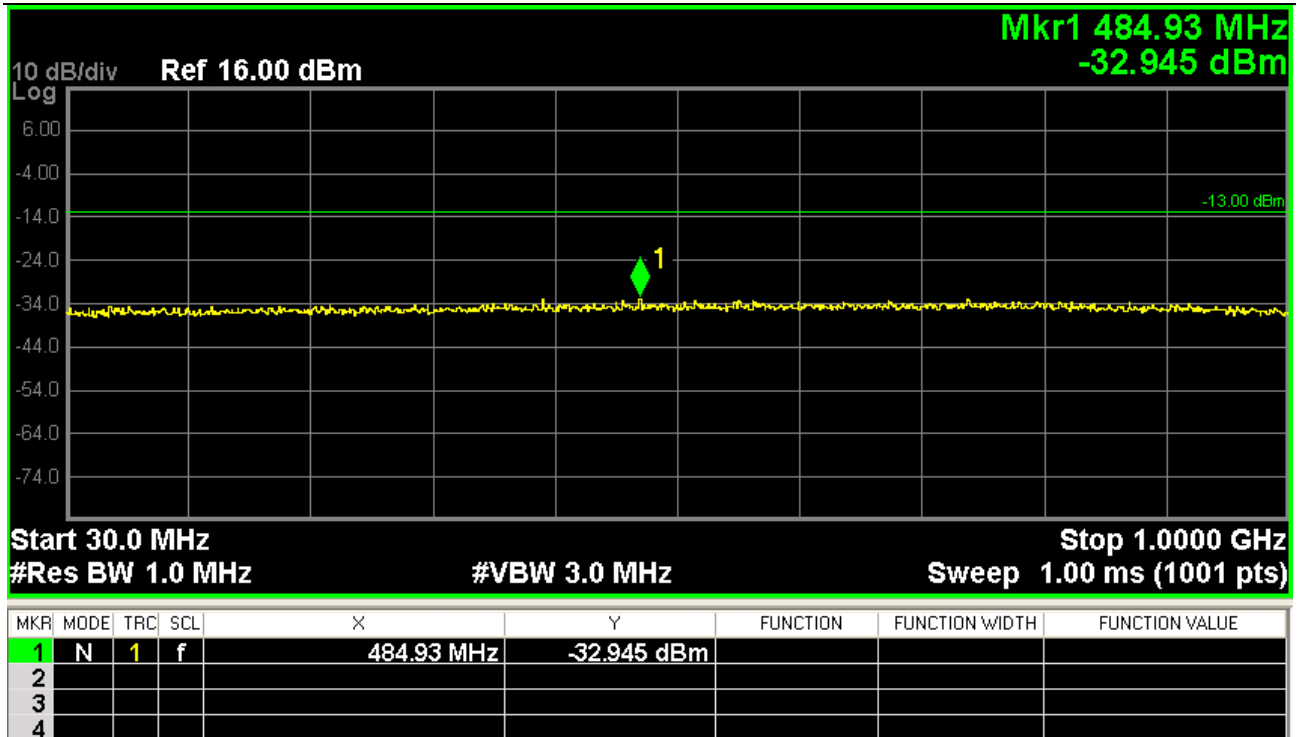

Note: The signal at point 1 is carrier

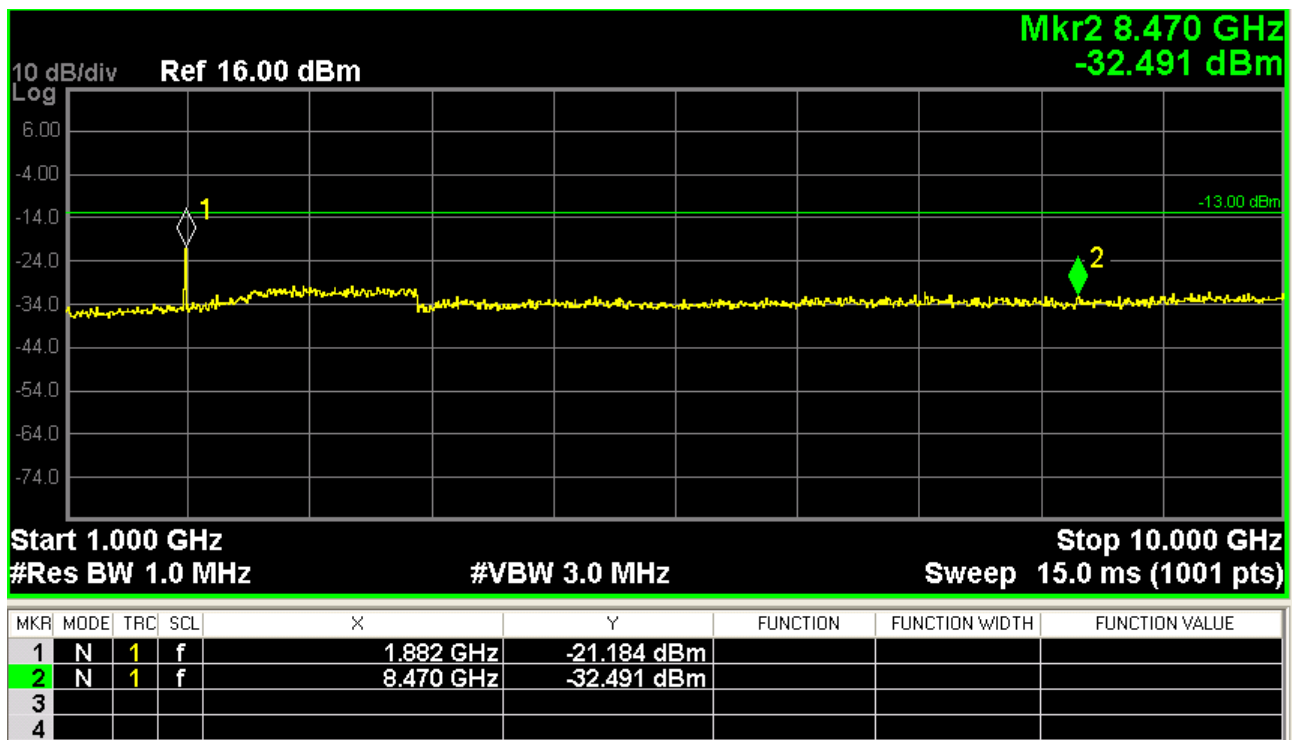

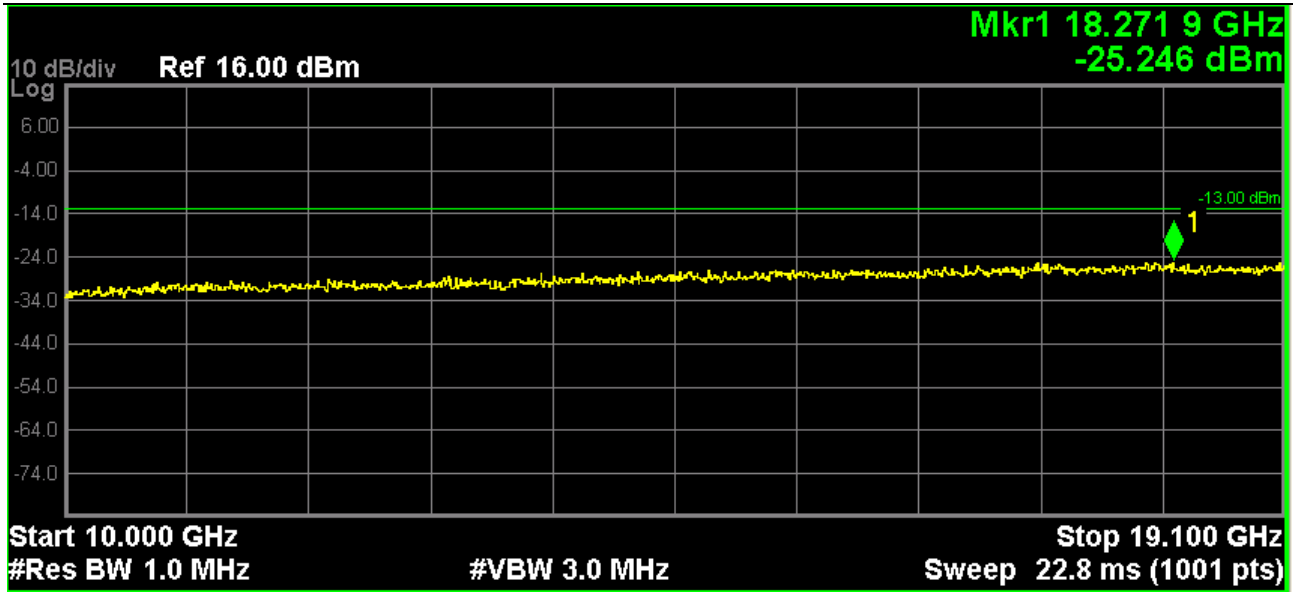

MKR	MODE	TRC	SCL	X	Y	FUNCTION	FUNCTION WIDTH	FUNCTION VALUE
1	N	1	f	18.271 9 GHz	-25.246 dBm			
2								
3								
4								

Radiated Spurious Measurement:

CDMA2000 BC0/BC1 (1XRTT_RC3+SO55), 9KHz to 30MHz

The low frequency, which started from 9KHz to 30MHz, was pre-scanned and the result which was 20dB lower than the limit line, and that was not reported per 2.1057 (c).

CDMA2000 BC0 (1XRTT_RC3+SO55), 30MHz to 1GHz

Frequency (MHz)	Ant. Pol. (H/V)	SG Reading (dBm)	Cable Loss (dB)	Gain (dBd)	ERP (dBm)	Limit (dBm)	Margin (dB)
Middle Channel 384 (836.52MHz)							
32.91	H	-72.36	0.71	-12.95	-86.02	-13.00	-73.02
952.47	H	-83.33	4.16	3.75	-83.74	-13.00	-70.74
32.91	V	-62.55	0.70	-12.95	-76.20	-13.00	-63.20
952.47	V	-78.73	4.16	3.75	-79.14	-13.00	-66.14

Note: Spurious emissions within 30MHz-1000MHz were found more than 20dB below limit line

CDMA2000 BC0 (1XRTT_RC3+SO55), Above 1GHz

Frequency (MHz)	Ant. Pol. (H/V)	SG Reading (dBm)	Cable Loss (dB)	Gain (dBd)	ERP (dBm)	Limit (dBm)	Margin (dB)
Middle Channel 384 (836.52MHz)							
1680.00	H	-47.12	6.00	7.25	-45.87	-13.00	-32.87
3346.00	H	-48.08	8.48	10.45	-46.11	-13.00	-33.11
1680.00	V	-44.34	6.00	7.25	-48.55	-13.00	-35.55
3346.00	V	-52.24	8.48	10.45	-39.89	-13.00	-26.89

Note: Spurious emissions within 30MHz-1000MHz were found more than 20dB below limit line

CDMA2000 BC1 (1XRTT_RC3+SO55), 30MHz to 1GHz

Frequency (MHz)	Ant. Pol. (H/V)	SG Reading (dBm)	Cable Loss (dB)	Gain (dBi)	EIRP (dBm)	Limit (dBm)	Margin (dB)
Middle Channel 661 (1880.00MHz)							
31.94	H	-72.85	0.67	-13.55	-87.07	-13.00	-74.07
31.94	V	-61.74	0.68	-13.55	-75.97	-13.00	-62.97

Note: Spurious emissions within 30MHz-1000MHz were found more than 20dB below limit line

CDMA2000 BC1 (1XRTT_RC3+SO55), Above 1GHz

Frequency (MHz)	Ant. Pol. (H/V)	SG Reading (dBm)	Cable Loss (dB)	Gain (dBi)	EIRP (dBm)	Limit (dBm)	Margin (dB)
Middle Channel 661 (1880.00MHz)							
1187.0	H	-48.47	4.96	4.35	-49.08	-13.00	-36.08
2054.0	H	-40.68	6.69	8.25	-39.12	-13.00	-26.12
1187.0	V	-45.83	4.96	4.35	-46.44	-13.00	-33.44
1714.0	V	-43.23	6.04	8.25	-41.02	-13.00	-28.02

Note: Spurious emissions within 30MHz-1000MHz were found more than 20dB below limit line

7. Frequency Stability Under Temperature & Voltage Variations

7.1. Test Equipment

Instrument	Manufacturer	Model	Serial No.	Cali. Due Date
Spectrum Analyzer	Agilent	N9038A	MY51210142	2014.07.27
Radio Communication Tester	Agilent	E5515C	GB46581718	2014.10.24
DC Power Supply	Agilent	6612C	MY43002989	2014.03.04
DC Power Supply	ITECH	IT5612	01600210661201014	2014.11.15
Temperature Chamber	WEISS	DU/20/40	58226017340050	2014.12.03

7.2. Test Setup

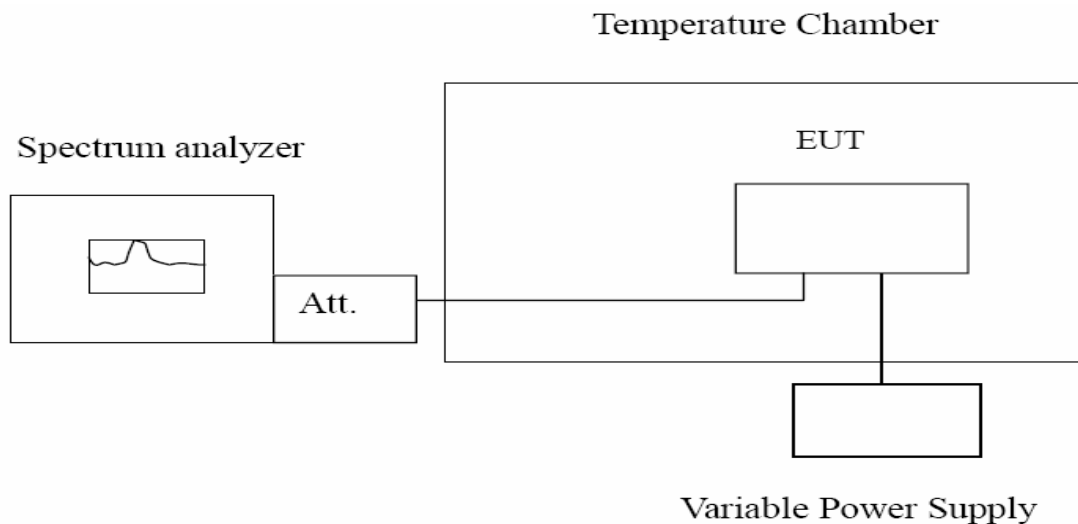

7.3. Limit

The frequency stability shall be sufficient to ensure that the fundamental emission stays within the authorized frequency block.

Limit	< 2.5 ppm
-------	-----------

7.4. Test Procedure

Frequency Stability Under Temperature Variations:

The equipment under test was connected to an external AC or DC power supply and input rated voltage. RF output was connected to a frequency counter or spectrum analyzer via feed through attenuators. The EUT was placed inside the temperature chamber. Set the spectrum analyzer RBW low enough to obtain the desired frequency resolution and measure

EUT 20°C operating frequency as reference frequency. Turn EUT off and set the chamber temperature to -30°C. After the temperature stabilized for approximately 30 minutes recorded the frequency. Repeat step measure with 10°C increased per stage until the highest temperature of +50°C reached.

Frequency Stability Under Voltage Variations:

Set chamber temperature to 20°C. Use a variable AC power supply / DC power source to power the EUT and set the voltage to rated voltage. Set the spectrum analyzer RBW low enough to obtain the desired frequency resolution and recorded the frequency.

Reduce the input voltage to specify extreme voltage variation ($\pm 15\%$) and endpoint, record the maximum frequency change.

7.5. Uncertainty

The measurement uncertainty is defined as ± 10 Hz.

7.6. Test Result

CDMA2000 BC0 (1XRTT_RC3+SO55):

Frequency Stability under Temperature

Temperature Interval (°C)	Test Frequency (MHz)	Deviation (Hz)	Limit(Hz)	Result
-30	836.52	-21.7	±2091.3	PASS
-20	836.52	-19.8	±2091.3	
-10	836.52	-22.4	±2091.3	
0	836.52	-16.7	±2091.3	
10	836.52	-15.0	±2091.3	
20	836.52	-18.6	±2091.3	
30	836.52	-25.1	±2091.3	
40	836.52	-21.6	±2091.3	
50	836.52	-32.2	±2091.3	

Frequency Stability under Voltage

DC Voltage (V)	Test Frequency (MHz)	Deviation (Hz)	Limit(Hz)	Result
10.2	836.52	-18.34	±2091.3	PASS
12	836.52	-20.24	±2091.3	
13.8	836.52	-28.40	±2091.3	

CDMA2000 BC1 (1XRTT_RC3+SO55):

Frequency Stability under Temperature

Temperature Interval (°C)	Test Frequency (MHz)	Deviation (Hz)	Limit(Hz)	Result
-30	1880.00	-21.3	±4700	PASS
-20	1880.00	-22.5	±4700	
-10	1880.00	-20.2	±4700	
0	1880.00	-21.8	±4700	
10	1880.00	-18.6	±4700	
20	1880.00	-17.4	±4700	
30	1880.00	-29.1	±4700	
40	1880.00	-37.5	±4700	
50	1880.00	-39.2	±4700	

Frequency Stability under Voltage

DC Voltage (V)	Test Frequency (MHz)	Deviation (Hz)	Limit(Hz)	Result
10.2	1880.00	-12.4	±4700	PASS
12	1880.00	-21.4	±4700	
13.8	1880.00	-26.8	±4700	

8.Attachment

PHOTOGRAPHS OF TEST SETUP

Please refer to the file named "YQD-GV300C_Part22&24 Setup Photos".

PHOTOGRAPHS OF EUT

Please refer to two files named "YQD-GV300C_EUT Internal Photos" and "YQD-GV300C_EUT External Photos".

----End of the report----