

# SAR TEST REPORT

**Report No.:** SET2014-14194  
**Product:** GPS Locator  
**Model No.:** GL300VC  
**Brand Name:** Queclink  
**FCC ID:** YQD-GL300VC  
**Applicant:** Queclink Wireless Solutions Co.,Ltd  
**Address:** Room 501, Building 9, No 99, TianZhou Road, Shanghai, China  
**Issued by:** CCIC-SET  
**Lab Location:** Electronic Testing Building, Shahe Road, Xili, Nanshan District, Shenzhen, 518055, P. R. China  
**Tel:** 86 755 26627338      **Fax:** 86 755 26627238  
**Mail:** manager@ccic-set.com      **Website:** <http://www.ccic-set.com>



This test report consists of 76 pages in total. It may be duplicated completely for legal use with the approval of the applicant. It should not be reproduced except in full, without the written approval of our laboratory. The client should not use it to claim product endorsement by CCIC-SET. The test results in the report only apply to the tested sample. The test report shall be invalid without all the signatures of testing engineers, reviewer and approver. Any objections must be raised to CCIC-SET within 15 days since the date when the report is received. It will not be taken into consideration beyond this limit.

## Test Report

**Product**..... : GPS Locator  
**Model No.** ..... : GL300VC  
**Brand Name**..... : Queclink  
**FCC ID**..... : YQD-GL300VC

**Applicant**..... : Queclink Wireless Solutions Co.,Ltd.  
**Applicant Address**..... : Room 501, Building 9, No 99, TianZhou Road, Shanghai, China

**Manufacturer**..... : Queclink Wireless Solutions Co.,Ltd.  
**Manufacturer Address**..... : Room 501, Building 9, No 99, TianZhou Road, Shanghai, China

**Rating** ..... : 5Vdc 1500mA(Charger) or 3.7V 1300mAh(Battery)

**Test Standards**..... : IEEE Std. 1528-2013, 47CFR § 2.1093  
RSS-102 Issue 4 March 2010

**Test Result**..... : Pass

**Tested by** .....



Signature

**Reviewed by**.....

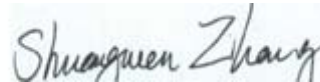

Signature

**Approved by**.....



Signature

## Contents

- 1. GENERAL CONDITIONS**
- 2. ADMINISTRATIVE DATA**
  - 2.1. Identification of the Responsible Testing Laboratory
  - 2.2. Identification of the Responsible Testing Location(s)
  - 2.3. Organization Item
  - 2.4. Identification of Applicant
  - 2.5. Identification of Manufacture
- 3. EQUIPMENT UNDER TEST (EUT)**
- 4. OPERATIONAL CONDITIONS DURING TEST**
  - 4.1. Introduction
  - 4.2. SAR Definition
  - 4.3. Phantoms
  - 4.4. Device Holder
  - 4.5. Probe Specification
- 5. OPERATIONAL CONDITIONS DURING TEST**
  - 5.1. Schematic Test Configuration
  - 5.2. SAR Measurement System
  - 5.3. Equipments and results of validation testing
  - 5.4. SAR measurement procedure
  - 5.5. Antennas position and test position
- 6. CHARACTERISTICS OF THE TEST**
  - 6.1. Applicable Limit Regulations
  - 6.2. Applicable Measurement Standards
- 7. LABORATORY ENVIRONMENT**
- 8. TEST RESULTS**
  - 8.1. Summary of Measurement Results
  - 8.2. Conclusion
- 9. MEASUREMENT UNCERTAINTY**
- 10. MAIN TEST INSTRUMENTS**

**This Test Report consists of the following Annexes:**

**Annex A: Test Layout**

**Annex B: Sample Photographs**

**Annex C: System Performance Check Data**

**Annex D: Calibration Certificate of Probe and Dipoles**

## **1. GENERAL CONDITIONS**

**1.1 This report only refers to the item that has undergone the test.**

**1.2 This report standalone dose not constitute or imply by its own an approval of the product by the certification Bodies or competent Authorities.**

**1.3 This document is only valid if complete; no partial reproduction can be made without written approval of CCIC-SET**

**1.4 This report cannot be used partially or in full for publicity and/or promotional purposes without previous written approval of CCIC-SET and the Accreditation Bodies, if it applies.**

## 2. Administrative Date

### 2.1. Identification of the Responsible Testing Laboratory

**Company Name:** CCIC-SET

**Department:** EMC & RF Department

**Address:** Electronic Testing Building, Shahe Road, Nanshan District,  
ShenZhen, P. R. China

**Telephone:** +86-755-26629676

**Fax:** +86-755-26627238

**Responsible Test Lab  
Managers:** Mr. Wu Li'an

### 2.2. Identification of the Responsible Testing Location(s)

**Company Name:** CCIC-SET

**Address:** Electronic Testing Building, Shahe Road, Nanshan District,  
Shenzhen, P. R. China

### 2.3. Organization Item

**CCIC-SET Report No.:** SET2014-14194

**CCIC-SET Project Leader:** Mr. Li Sixiong

**CCIC-SET Responsible  
for accreditation scope:** Mr. Wu Li'an

**Start of Testing:** 2014-12-16

**End of Testing:** 2014-12-16

### 2.4. Identification of Applicant

**Company Name:** Queclink Wireless Solutions Co.,Ltd.

**Address:** Room 501, Building 9, No 99, TianZhou Road, Shanghai,  
China

### 2.5. Identification of Manufacture

**Company Name:** Queclink Wireless Solutions Co.,Ltd.

**Address:** Room 501, Building 9, No 99, TianZhou Road, Shanghai,  
China

**Notes:** This data is based on the information by the applicant.

### 3. General Information

#### 3.1. Description Of Equipment Under Test (EUT)

<b>Sample Name:</b>	GPS Locator	
<b>Type Name:</b>	GL300VC	
<b>Brand Name:</b>	Queclink	
<b>Dual Transfer Mode (DTM) per 3GPP 51.010</b>	Not supported	
<b>General description:</b>	Support Band and Frequency Range	CDMA2000 BC0: 824.70 MHz to 848.31MHz CDMA2000 BC1: 1851.25MHz to 1908.75MHz
	Development Stage	Identical Prototype
	Accessories	Power Supply
	Battery type	GL100
	Battery specification	1300mAh 3.7V
	Antenna type	PIFA Antenna
	Modulation mode	QPSK

**NOTE:**

- a. The above EUT's information was declared by manufacturer. Please refer to the specifications or user's manual for more detailed description.

## 4 Specific Absorption Rate (SAR)

### 4.1 Introduction

SAR is related to the rate at which energy is absorbed per unit mass in an object exposed to a radio field. The SAR distribution in a biological body is complicated and is usually carried out by experimental techniques or numerical modeling. The standard recommends limits for two tiers of groups, occupational/controlled and general population/uncontrolled, based on a person's awareness and ability to exercise control over his or her exposure. In general, occupational/controlled exposure limits are higher than the limits for general population/uncontrolled.

### 4.2 SAR Definition

The SAR definition is the time derivative (rate) of the incremental energy (dW) absorbed by (dissipated in) an incremental mass (dm) contained in a volume element (dv) of a given density ( $\rho$ ). The equation description is as below:

$$\text{SAR} = \frac{d}{dt} \left( \frac{dW}{dm} \right) = \frac{d}{dt} \left( \frac{dW}{\rho dv} \right)$$

SAR is expressed in units of Watts per kilogram (W/kg)

SAR measurement can be either related to the temperature elevation in tissue by

$$\text{SAR} = C \frac{\delta T}{\delta t}$$

where C is the specific heat capacity,  $\delta T$  is the temperature rise and  $\delta t$  the exposure duration, or related to the electrical field in the tissue by

$$\text{SAR} = \frac{\sigma |E|^2}{\rho}$$

where  $\sigma$  is the conductivity of the tissue,  $\rho$  is the mass density of the tissue and E is the rms electrical field strength.

However for evaluating SAR of low power transmitter, electrical field measurement is typically applied.

### 4.3 Phantoms

The phantom used for all tests i.e. for both system checks and device testing, was the twin-headed "SAM Phantom", manufactured by SATIMO. The SAM twin phantom is a fiberglass shell phantom with 2mm shell thickness (except the ear region, where shell thickness increases to 6mm).

System checking was performed using the flat section, whilst Head SAR tests used the left and right head profile sections. Body SAR testing also used the flat section between the head profiles.



SAM Twin Phantom

### 4.4 Device Holder

The device was placed in the device holder (illustrated below) that is supplied by SATIMO as an integral part of the COMOSAR test system.

The device holder is designed to cope with the different positions given in the standard. It has two scales for device rotation (with respect to the body axis) and device inclination (with respect to the line between the ear reference points). The rotation centers for both scales is the ear reference point (ERP). Thus the device needs no repositioning when changing the angles.

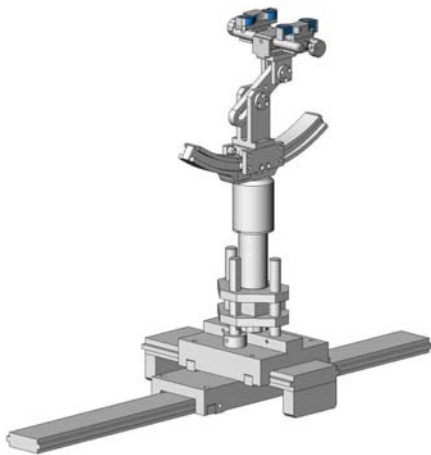

Device holder



## 4.5 Probe Specification



Construction	Symmetrical design with triangular core Interleaved sensors Built-in shielding against static charges PEEK enclosure material (resistant to organic solvents, e.g., DGBE)
Calibration	ISO/IEC 17025 calibration service available.
Frequency	700 MHz to 3 GHz; Linearity: $\pm 0.5$ dB (700 MHz to 3 GHz)
Directivity	$\pm 0.25$ dB in HSL (rotation around probe axis) $\pm 0.5$ dB in tissue material (rotation normal to probe axis)
Dynamic Range	1.5 $\mu$ W/g to 100 mW/g; Linearity: $\pm 0.5$ dB
Dimensions	Overall length: 330 mm (Tip: 20 mm) Tip diameter: 5 mm (Body: 8 mm) Distance from probe tip to dipole centers: <2.7 mm
Application	General dosimetry up to 3 GHz Dosimetry in strong gradient fields Compliance tests of mobile phones
Compatibility	COMOSAR

### Isotropic E-Field Probe

The isotropic E-Field probe has been fully calibrated and assessed for isotropicity, and boundary effect within a controlled environment. Depending on the frequency for which the probe is calibrated the method utilized for calibration will change.

The E-Field probe utilizes a triangular sensor arrangement as detailed in the diagram below:

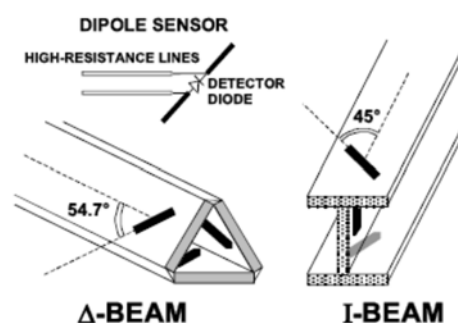

## **5 OPERATIONAL CONDITIONS DURING TEST**

### **5.1 Schematic Test Configuration**

During SAR test, EUT was operating in Traffic Mode (Channel Allocated) at Normal Voltage Condition. A communication link is set up with a System Simulator (SS) by air link, and a call is established.

The Absolute Radio Frequency Channel Number (ARFCN) was allocated to 1013, 384 and 777 respectively in the case of CDMA BC0, or to 25, 600 and 1175 respectively in the case of CDMA BC1. The EUT was commanded to operate at maximum transmitting power.

The EUT should use its internal transmitter. The antenna(s), battery and accessories shall be those specified by the manufacturer. The EUT battery must be fully charged and checked periodically during the test to ascertain uniform power output. If a wireless link was used, the antenna connected to the output of the base station simulator shall be placed at least 50 cm away from the handset.

The signal transmitted by the simulator to the antenna feeding point should be lower than the output power level of the handset by at least 35 dB

### **5.2 SAR Measurement System**

The SAR measurement system being used is the DASY4 system, the system is controlled remotely from a PC, which contains the software to control the robot and data acquisition equipment. The software also displays the data obtained from test scans.

In operation, the system first does an area (2D) scan at a fixed depth within the liquid from the inside wall of the phantom. When the maximum SAR point has been found, the system will then carry out a 3D scan centred at that point to determine volume averaged SAR level.

#### **5.2.1 Tissue Dielectric Parameters for Head and Body Phantoms**

The head tissue dielectric parameters recommended by the IEEE SCC-34/SC-2 in P1528 have been incorporated in the following table. These head parameters are derived from planar layer models simulating the highest expected SAR for the dielectric properties and tissue thickness Power drifts in a human head. Other head and body tissue parameters that have not been specified in P1528 are derived from the tissue dielectric parameters computed from the 4-Cole-Cole equations described in Reference [12] and extrapolated according to the head parameters specified in P1528.

Table 1: Recommended Dielectric Performance of Tissue

Ingredients (% by weight )	Frequency (MHz)									
	450		835		915		1900		2450	
Tissue Type	Head	Body	Head	Body	Head	Body	Head	Body	Head	Body
Water	38.56	51.16	41.45	52.4	41.05	56.0	54.9	40.4	62.7	73.2
Salt (Nacl)	3.95	1.49	1.45	1.4	1.35	0.76	0.18	0.5	0.5	0.04
Sugar	56.32	46.78	56.0	45.0	56.5	41.76	0.0	58.0	0.0	0.0
HEC	0.98	0.52	1.0	1.0	1.0	1.21	0.0	1.0	0.0	0.0
Bactericide	0.19	0.05	0.1	0.1	0.1	0.27	0.0	0.1	0.0	0.0
Triton x-100	0.0	0.0	0.0	0.0	0.0	0.0	0.0	0.0	36.8	0.0
DGBE	0.0	0.0	0.0	0.0	0.0	0.0	44.92	0.0	0.0	26.7
Dielectric Constant	43.42	58.0	42.54	56.1	42.0	56.8	39.9	54.0	39.8	52.5
Conductivity (s/m)	0.85	0.83	0.91	0.95	1.0	1.07	1.42	1.45	1.88	1.78

Table 2 Recommended Tissue Dielectric Parameters

Frequency (MHz)	Head Tissue		Body Tissue	
	$\epsilon_r$	$\sigma(S/m)$	$\epsilon_r$	$\sigma(S/m)$
150	52.3	0.76	61.9	0.80
300	45.3	0.87	58.2	0.92
450	43.5	0.87	56.7	0.94
835	41.5	0.90	55.2	0.97
900	41.5	0.97	55.0	1.05
915	41.5	0.98	55.0	1.06
1450	40.5	1.20	54.0	1.30
1610	40.3	1.29	53.8	1.40
1800-2000	40.0	1.40	53.3	1.52
2450	39.2	1.80	52.7	1.95
3000	38.5	2.40	52.0	2.73
5800	35.3	5.27	48.2	6.00

### 5.2.2 Simulant liquids

For body-worn measurements, the EUT was tested against flat phantom representing the user body. The EUT was put on in the belt holder. Simulant liquids that are used for testing at frequencies of CDMA BC0, CDMA BC1, which are made mainly of sugar, salt and water solutions may be left in the phantoms.

Table 3: Dielectric Performance of Body Tissue Simulating Liquid

Temperature: 23.2°C; Humidity: 64%;					
/	Frequency	Permittivity $\epsilon$	Conductivity $\sigma$ (S/m)	Deviation (%)	
Target value	835MHz	55.2	0.97	$\epsilon$	$\sigma$
Validation value (NOV. 16th, 2014)	835MHz	55.26	0.98	0.1	1.0
Target value	1900MHz	53.3	1.52	--	--
Validation value (NOV. 16th, 2014)	1900MHz	53.26	1.53	-0.1	0.7

Table 4: Dielectric Performance of Tissue Simulating Liquid at test channel

Band	Channel	Frequency (MHz)	Permittivity $\epsilon$	Conductivity $\sigma$ (S/m)
			Body	Body
CDMA BC0	1013	824.70	55.036	0.921
	384	836.52	54.908	0.940
	777	848.31	54.787	0.958
CDMA BC1	25	1851.25	53.508	1.538
	600	1880.00	53.332	1.531
	1175	1908.75	53.363	1.546



Fig. 1 Configuration of body tissue

### 5.2.3 Equipments and results of validation testing

Important equipments :

Equipment description	Manufacturer/Model	Identification No.
SAR Probe	SATIMO	SN_0913_EP169
Phantom	SATIMO	SN_0913_SAM97
Liquid	SATIMO	-
Dipole	SATIMO-SID835	SN_0913_DIP0G835-217
Dipole	SATIMO-SID1900	SN_0913_DIP1G900-218
Vector Network Analyzer	Rohde & Schwarz - ZVB8	1145.1010.08
Amplifier	Nucletudes	143060
Power Meter	Rohde & Schwarz - NRVS	1020.1809.02
Multimeter	Keithley - 2000	4014020

Prior to the assessment, the system validation kit was used to test whether the system was operating within its specifications of  $\pm 10\%$ . The validation results are tabulated below. And also the corresponding SAR plot is attached as well in the SAR plots files.

The following procedure, recommended for performing validation tests using box phantoms is based on the procedures described in the draft IEEE standard P1528. Setup according to the setup diagram below :

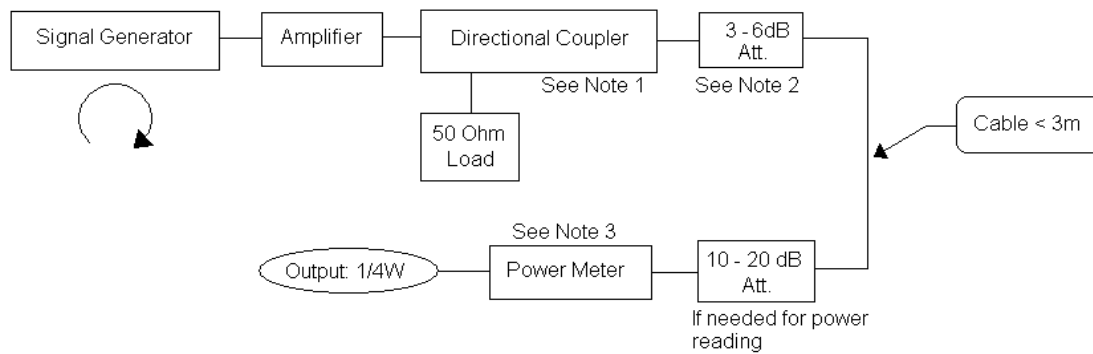

With the SG and Amp and with directional coupler in place, set up the source signal at the relevant frequency and use a power meter to measure the power at the end of the SMA cable that you intend to connect to the balanced dipole. Adjust the SG to make this, say, 0.25W (24 dBm). If this level is too high to read directly with the power meter sensor, insert a calibrated attenuator (e.g. 10 or 20 dB) and make a suitable correction to the power meter reading.

Note 1: In this method, the directional coupler is used for monitoring rather than setting the exact feed power level. If, however, the directional coupler is used for power measurement, you should check the frequency range and power rating of the coupler and measure the coupling factor (referred to output) at the test frequency using a VNA.

Note 2: Remember that the use of a 3dB attenuator (as shown in Figure 8.1 of P1528) means that you need an RF amplifier of 2 times greater power for the same feed power. The other issue is the cable length. You might get up to 1dB of loss per meter of cable, so the cable length after the coupler needs to be quite short.

Note 3: For the validation testing done using CW signals, most power meters are suitable. However, if you are measuring the output of a modulated signal from either a signal generator or a handset, you must ensure that the power meter correctly reads the modulated signals.

The measured 1-gram averaged SAR values of the device against the phantom are provided in Tables 5. The humidity and ambient temperature of test facility were 64% and 23.2°C respectively. The body phantom were full of the body tissue simulating liquid. The EUT was supplied with full-charged battery for each measurement.

Table 5: Body Liquid Verification Results (1g)

Frequency	Duty cycle	Target value (W/kg)	Test value (W/kg)		Deviation (%)
			250 mW	1W	
835MHz (16/12/ 2014)	1:1	10.31	2.64	10.56	2.42
1900MHz (16/12/ 2014)	1:1	40.81	9.98	39.92	-2.18

### 5.2.4 SAR measurement procedure

The SAR test against the head phantom was carried out as follow:

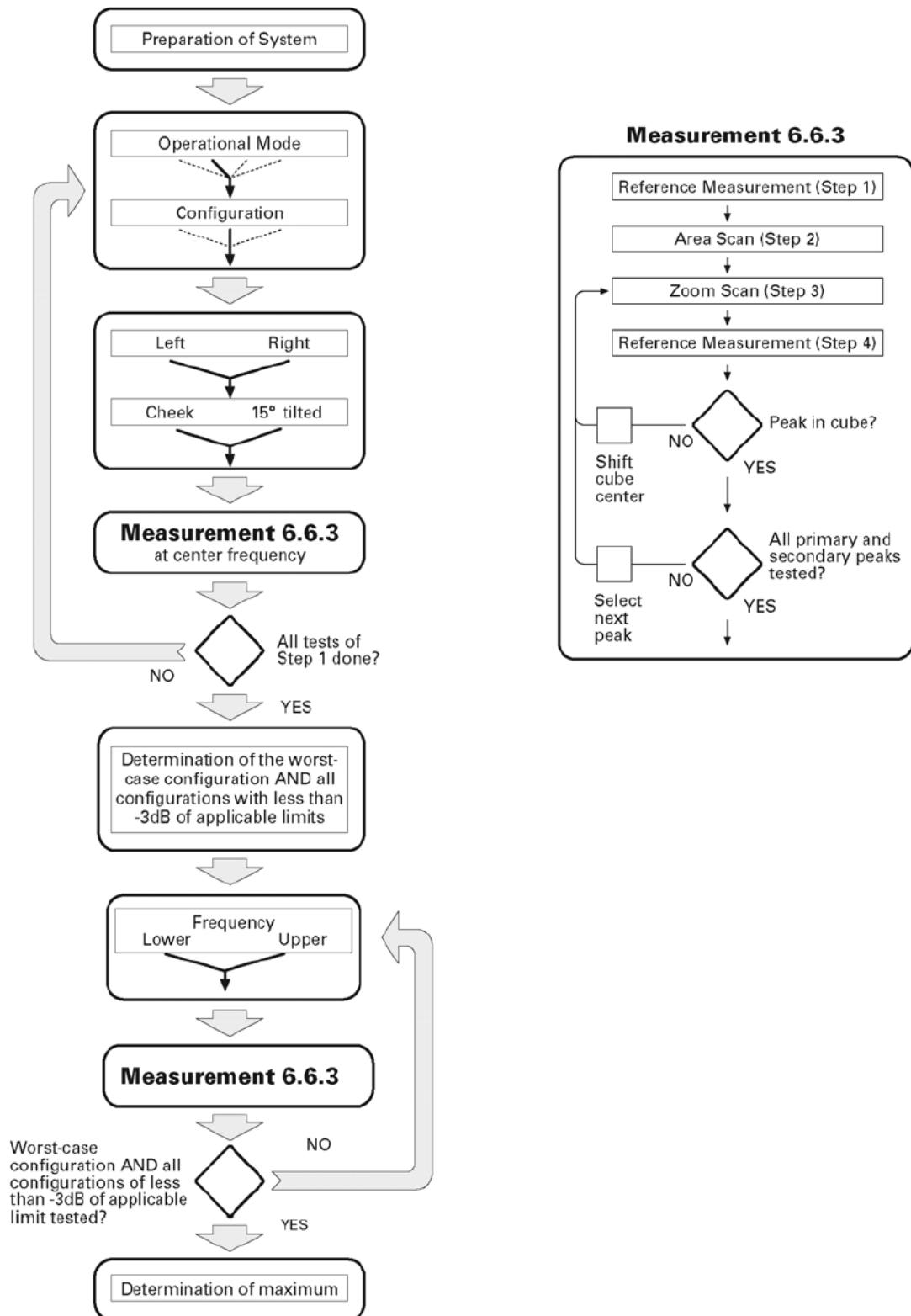

Establish a call with the maximum output power with a base station simulator, the connection between the EUT and the base station simulator is established via air interface.

After an area scan has been done at a fixed distance of 8mm from the surface of the

phantom on the source side, a 3D scan is set up around the location of the maximum spot SAR. First, a point within the scan area is visited by the probe and a SAR reading taken at the start of testing. At the end of testing, the probe is returned to the same point and a second reading is taken. Comparison between these start and end readings enables the power drift during measurement to be assessed.

Above is the scanning procedure flow chart and table from the IEEE1528-2013 standard. This is the procedure for which all compliant testing should be carried out to ensure that all variations of the device position and transmission behaviour are tested.

For body-worn measurement, the EUT was tested under two position: face upward and back upward.

**5.2.5 Transmitting antenna information**

There are two antennas(CDMA antenna and GPS antenna) inside the EUT, the CDMA antenna is the transmitting source, which is a type of PIFA antenna, the following picture shows the position of the antenna.

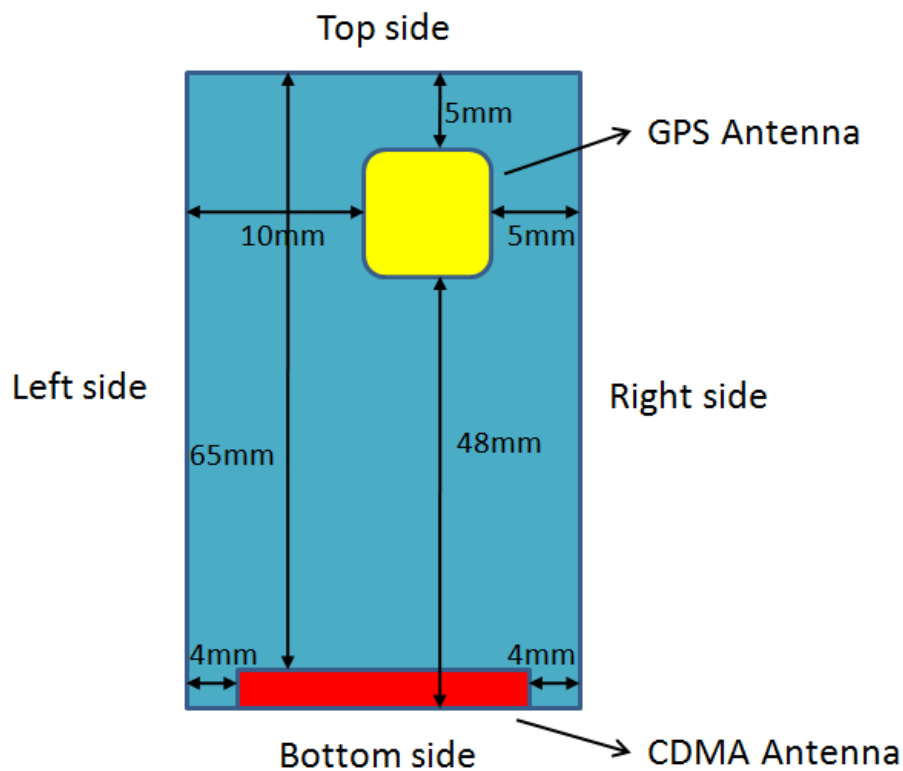

**Note:** The GPS antenna is charged for receive, the SAR result would not be affected by them.

Antennas	Wireless Interface
CDMA Antenna <Tx / Rx>	CDMA 1900/850
GPS Antenna <Rx>	\



## 6 CHARACTERISTICS OF THE TEST

### 6.1 Applicable Limit Regulations

**47CFR § 2.1093-** Radiofrequency Radiation Exposure Evaluation: Portable Devices;

**ANSI C95.1–1999:** IEEE Standard for Safety Levels with Respect to Human Exposure to Radio Frequency Electromagnetic Fields, 3 kHz to 300 GHz;

**RSS-102–2010:** Radio Frequency (RF) Exposure Compliance of Radio communication Apparatus (All Frequency Bands)

It specifies the maximum exposure limit of **1.6 W/kg** as averaged over any 1 gram of tissue for portable devices being used within 20 cm of the user in the uncontrolled environment.

### 6.2 Applicable Measurement Standards

The Specific Absorption Rate (SAR) testing specification, method, and procedure for this is in accordance with the following standards:

FCC 47 CFR Part2 (2.1046)

ANSI/IEEE C95.1-1999

IEEE 1528-2013

FCC KDB 447498 D01 v05r02

FCC KDB 648474 D04 v01r02

FCC KDB 865664 D01 v01r03

FCC KDB 941225 D01 v03

FCC KDB865664 D02 RF Exposure Reporting v01r01

## 7 LABORATORY ENVIRONMENT

### 7.1 The Ambient Conditions during SAR Test

Temperature	Min. = 15 ° C, Max. = 30 ° C
Relative humidity	Min. = 30%, Max. = 70%
Ground system resistance	< 0.5 Ω
Ambient noise is checked and found very low and in compliance with requirement of standards.	
Reflection of surrounding objects is minimized and in compliance with requirement of standards.	

### 7.2 Test Configuration

For WWAN SAR testing, the device was controlled by using a base station emulator. Communication between the device and the emulator was established by air link. The distance between the EUT and the antenna of the emulator is larger than 50 cm and the output power radiated from the emulator antenna is at least 30dB smaller than output power of EUT.

## 8. Conducted RF Output Power

### 8.1 CDMA Conducted Power

Conducted Power (Unit: dBm)						
Band	CDMA2000 BC0			CDMA2000 BC1		
Channel	1013	384	777	25	660	1175
Frequency	824.70	836.52	848.31	1851.25	1880	1908.75
1xRTT RC1+SO55	23.10	23.22	23.09	23.17	23.25	23.21
1xRTT RC3+SO55	<b>23.35</b>	<b>23.33</b>	<b>23.16</b>	<b>23.26</b>	<b>24.02</b>	<b>23.38</b>
1xRTT RC1+SO32(+ F-SCH)	23.13	23.09	23.07	23.13	23.26	23.17
1xRTT RC1+SO32(+ SCH)	23.09	23.14	23.11	23.14	23.18	23.19

**Note:**

1. Per KDB941225 D01, the maximum output power channel is used for SAR testing and for further SAR test reduction.
2. RC3/SO55 is used for Body-worn accessory SAR measurements.

## 9. SAR DATA SUMMARY

### General Note:

1. Per KDB 447498 D01v05r02, the reported SAR is the measured SAR value adjusted for maximum tune-up tolerance.
  - a. Tune-up scaling Factor = tune-up limit power(mW)/EUT RF power(mW), where tune-up limit is the maximum rated power among all production units.
  - b. For SAR testing of WLAN signal with non-100% duty cycle , the measured SAR is scaled-up by the duty cycle scaling factor which is equal to "1/(duty cycle)"
  - c. For WWAN: Reported SAR(W/kg)=Measured SAR(W/kg)\*Tune-up Scaling Factor
2. Per KDB 447498 D01v05r02, for each exposure position, if the highest output channel reported SAR $\leq$ 0.8W/kg, other channels SAR testing is not necessary.
3. Per KDB 648474 D04v01r02,when the reported SAR for a body-worn accessory measured without a headset connected to the handset is  $\leq$ 1.2W/kg, SAR testing with a headset connected to the handset is not required.
4. Per KDB 865664 D01V01r03, for each frequency band, repeated SAR measurement is required only when the measured SAR is  $\geq$ 0.8W/Kg

**9.1 Standalone Body Worn SAR DATA**

Band	Mode	Test Position	Gap (cm)	Ch.	Freq. (MHz)	Average Power (dBm)	Tune-Up Limit (dBm)	Scaling Factor	Measured 1g SAR (W/kg)	Reported 1g SAR (W/kg)
CDMA BC0	1xRTT RC3+So55	Back	0	1013	824.7	23.35	25	1.07	0.666	0.713
CDMA BC0	1xRTT RC3+So55	Front	0	1013	824.7	23.35	25	1.07	0.657	0.703
CDMA BC0	1xRTT RC3+So55	Left Side	0	1013	824.7	23.35	25	1.07	0.465	0.498
CDMA BC0	1xRTT RC3+So55	Right Side	0	1013	824.7	23.35	25	1.07	0.442	0.473
CDMA BC0	1xRTT RC3+So55	Bottom Side	0	1013	824.7	23.35	25	1.07	0.767	0.821
CDMA BC0	1xRTT RC3+So55	Bottom Side	0	384	836.5 2	23.33	25	1.07	0.797	0.853
CDMA BC0	1xRTT RC3+So55	Bottom Side	0	777	848.3 1	23.16	25	1.08	0.771	0.833
Band	Mode	Test Position	Gap (cm)	Ch.	Freq. (MHz)	Average Power (dBm)	Tune-Up Limit (dBm)	Scaling Factor	Measured 1g SAR (W/kg)	Reported 1g SAR (W/kg)
CDMA BC1	1xRTT RC3+So55	Bottom Side	0	25	1851. 25	23.26	25	1.07	0.823	0.881
CDMA BC1	1xRTT RC3+So55	Front	0	600	1880	24.02	25	1.04	0.464	0.483
CDMA BC1	1xRTT RC3+So55	Left Side	0	600	1880	24.02	25	1.04	0.502	0.522
CDMA BC1	1xRTT RC3+So55	Right Side	0	600	1880	24.02	25	1.04	0.483	0.502
CDMA BC1	1xRTT RC3+So55	Bottom Side	0	600	1880	24.02	25	1.04	0.849	0.883
CDMA BC1	1xRTT RC3+So55	Back	0	600	1880	24.02	25	1.04	0.614	0.638
CDMA BC1	1xRTT RC3+So55	Bottom Side	0	1175	1908. 75	23.38	25	1.07	0.832	0.890

Note:When the 1-g SAR for the mid-band channel or the channel with the Highest output power satisfy the following conditions, testing of the other channels in the band is not required.(Per KDB 447498 D01 General RF Exposure Guidance v05r02)

- $\leq 0.8$  W/kg, when the transmission band is  $\leq 100$  MHz
- $\leq 0.6$  W/kg, when the transmission band is between 100 MHz and 200 MHz
- $\leq 0.4$  W/kg, when the transmission band is  $\geq 200$  MHz

**9.2 Highest SAR Test Plots  
Standalone Body Worn**

**CDMA BC0 QPSK(1xRTT RC3+SO55) Bottom Side 0cm Channel 384:**

Type: Phone measurement (Very fast, 11 points in the volume)

Date of measurement: 16/12/2014

Measurement duration: 6 minutes 58 seconds

Mobile Phone IMEI number: --

A. Experimental conditions.

<b>Probe serial number</b>	SN 09/13 EP169
<b>Probe conversion factors</b>	5.68
<b>Measurement drifts(%)</b>	-0.27
<b>Area Scan</b>	dx=14mm dy=14mm, h= 5.00 mm
<b>ZoomScan</b>	5x5x7,dx=8mm dy=8mm dz=5mm,Very fast/ndx=14mm dy=14mm, h= 5.00 mm
<b>Phantom</b>	Validation plane
<b>Device Position</b>	Body
<b>Band</b>	BC0
<b>Channels</b>	Middle
<b>Signal</b>	CDMA (Duty factor: 1.0)

<b>Frequency (MHz)</b>	836.5
<b>Relative permittivity (real part)</b>	54.908634
<b>Relative permittivity (imaginary part)</b>	20.310402
<b>Conductivity (S/m)</b>	0.940439
<b>Variation (%)</b>	2.100000

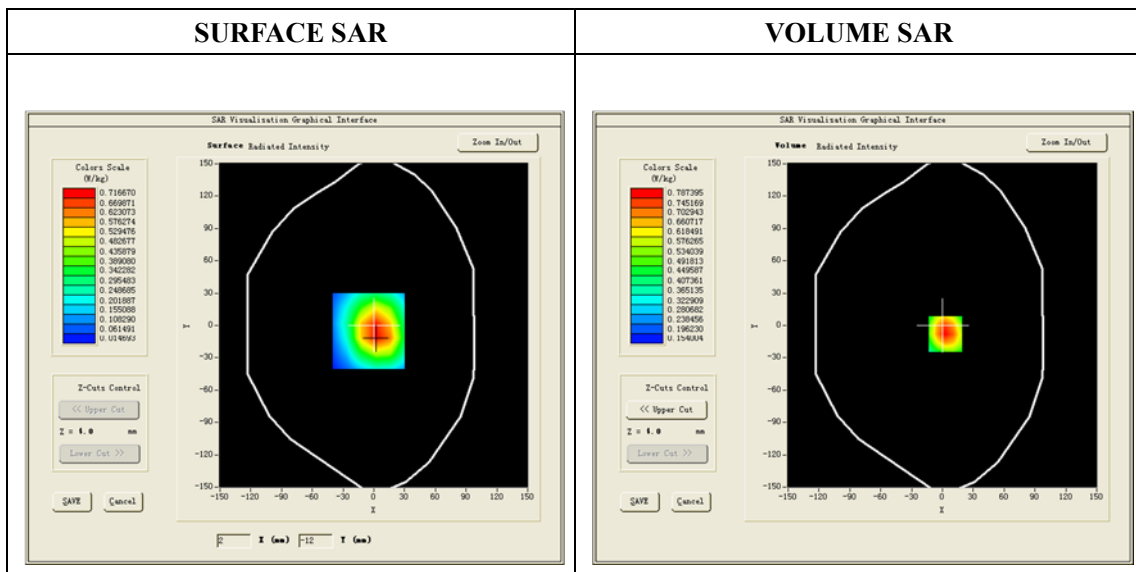

**Maximum location: X=3.00, Y=-8.00**

**SAR Peak: 1.03 W/kg**

<b>SAR 10g (W/Kg)</b>	0.575242
<b>SAR 1g (W/Kg)</b>	0.797025

<b>Z (mm)</b>	<b>0.00</b>	<b>4.00</b>	<b>9.00</b>	<b>14.00</b>	<b>19.00</b>
<b>SAR (W/Kg)</b>	<b>0.9706</b>	<b>0.7874</b>	<b>0.6129</b>	<b>0.4886</b>	<b>0.4004</b>

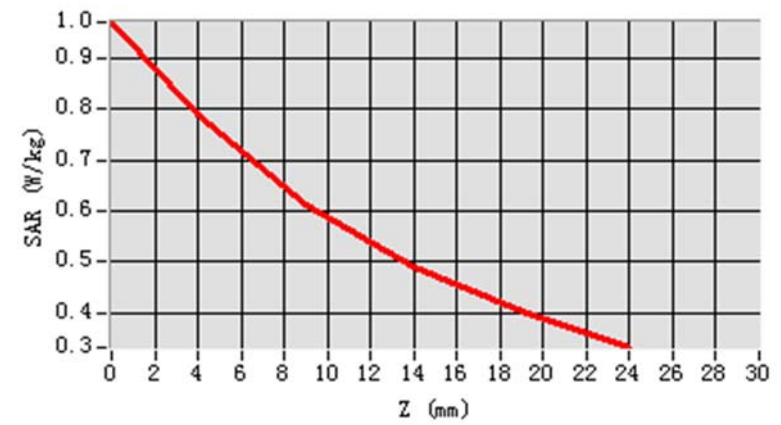

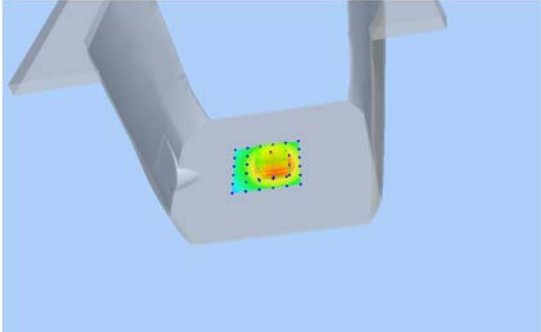
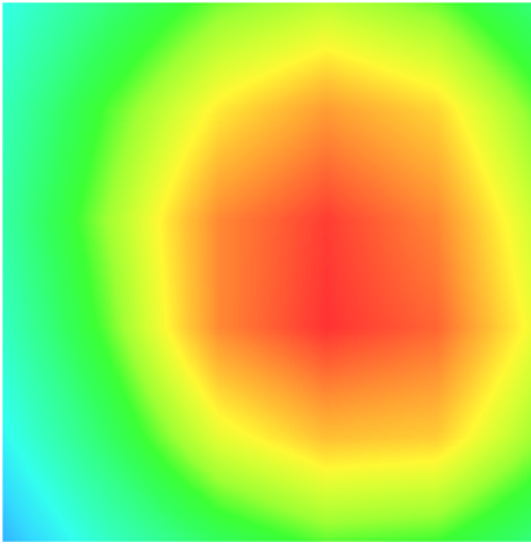
<b>3D screen shot</b>	<b>Hot spot position</b>
	

**CDMA BC1 QPSK(1xRTT RC3+SO55) Bottom Side 0cm Channel 600:**

Type: Phone measurement (Very fast, 11 points in the volume)

Date of measurement: 16/12/2014

Measurement duration: 6 minutes 13 seconds

Mobile Phone IMEI number: --

A. Experimental conditions.

<b>Probe serial number</b>	SN 09/13 EP169
<b>Probe conversion factors</b>	5.65
<b>Measurement drifts</b>	0.14
<b>Area Scan</b>	dx=14mm dy=14mm, h= 5.00 mm
<b>ZoomScan</b>	5x5x7,dx=8mm dy=8mm dz=5mm,Very fast/ndx=14mm dy=14mm, h= 5.00 mm
<b>Phantom</b>	Validation plane
<b>Device Position</b>	Body
<b>Band</b>	BC1
<b>Channels</b>	Middle
<b>Signal</b>	CDMA (Duty factor: 1.0)

<b>Frequency (MHz)</b>	1880
<b>Relative permittivity (real part)</b>	53.332199
<b>Relative permittivity (imaginary part)</b>	14.663500
<b>Conductivity (S/m)</b>	1.531521
<b>Variation (%)</b>	-0.470000

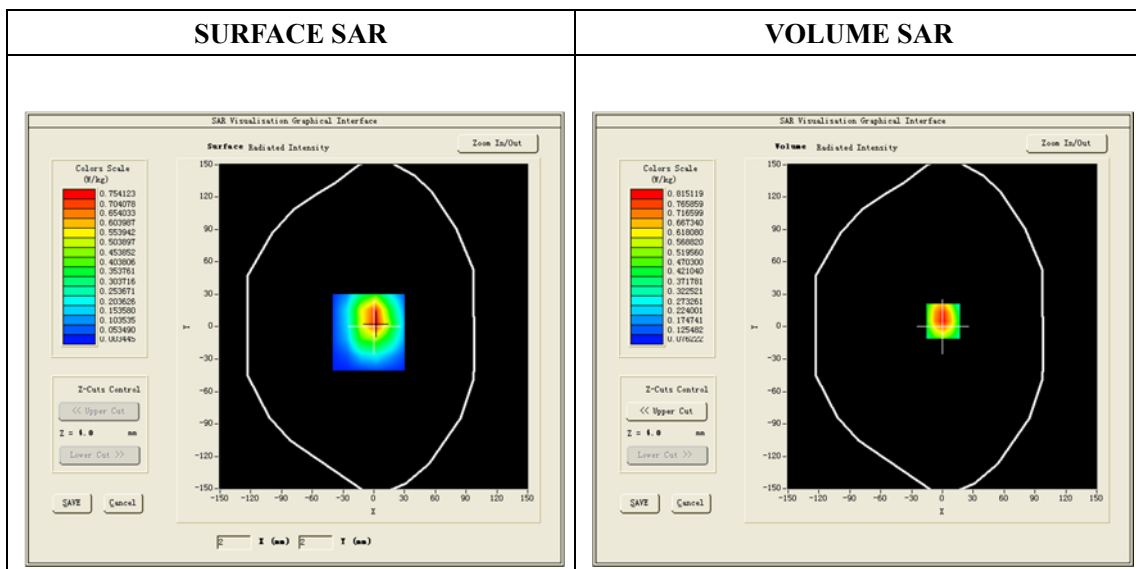

**Maximum location: X=1.00, Y=5.00**

**SAR Peak: 1.17 W/kg**

<b>SAR 10g (W/Kg)</b>	0.547306
<b>SAR 1g (W/Kg)</b>	0.849330

<b>Z (mm)</b>	<b>0.00</b>	<b>4.00</b>	<b>9.00</b>	<b>14.00</b>	<b>19.00</b>
<b>SAR (W/Kg)</b>	<b>1.0532</b>	<b>0.8151</b>	<b>0.5894</b>	<b>0.4279</b>	<b>0.3124</b>

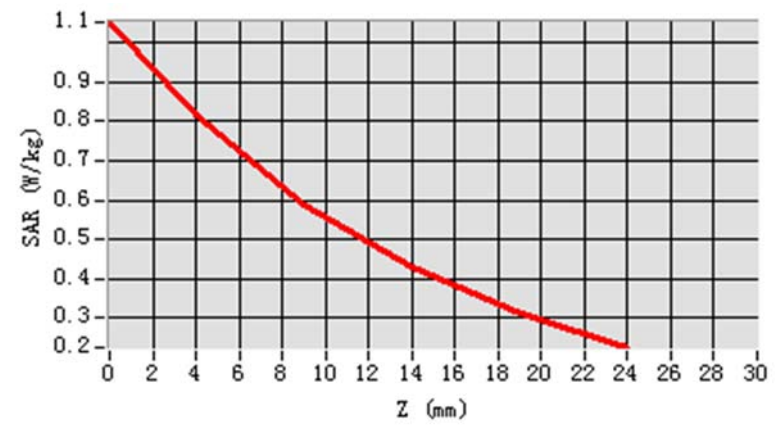

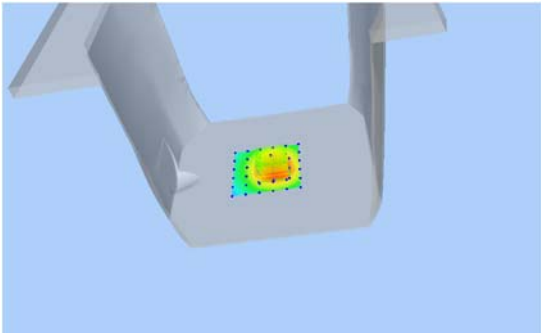
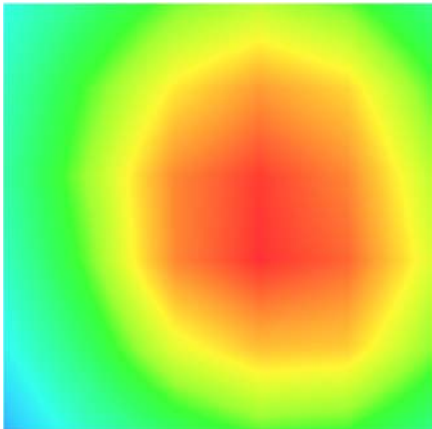
3D screen shot	Hot spot position
	



## 10 Measurement Uncertainty

Table 6: Measurement Uncertainty according to IEEE 1528

No.	Uncertainty Component	Type	Uncertainty Value (%)	Probability Distribution	k	ci	Standard Uncertainty (%) $u_i(\%)$	Degree of freedom $v_{eff}$ or $v_i$
<b>Measurement System</b>								
1	–Probe Calibration	B	6	N	1	1	3.5	$\infty$
2	–Axial isotropy	B	4.7	R	1.732	1	2.7	$\infty$
3	–Hemispherical Isotropy	B	9.4	R	1.732	1	5.4	$\infty$
4	–Boundary Effect	B	11.0	R	1.732	1	6.4	$\infty$
5	–Linearity	B	4.7	R	1.732	1	2.7	$\infty$
6	–System Detection Limits	B	1.0	R	1.732	1	0.6	$\infty$
7	–Readout Electronics	B	1.0	N	1	1	1.00	$\infty$
8	–Response Time	B	0.00	R	1.732	1	0.00	$\infty$
9	–Integration Time	B	0.00	R	1.732	1	0.00	$\infty$
10	–RF Ambient Conditions	B	3.0	R	1.732	1	1.73	$\infty$
11	–Probe Position Mechanical tolerance	B	0.4	R	1.732	1	0.2	$\infty$
12	–Probe Position with respect to Phantom Shell	B	2.9	R	1.732	1	1.7	$\infty$
13	–Extrapolation, Interpolation and Integration Algorithms for Max. SAR evaluation	B	3.9	R	1.732	1	2.3	$\infty$

Uncertainties of the DUT								
14	–Position of the DUT	A	4.8	N	1	1	4.8	5
15	–Holder of the DUT	A	7.1	N	1	1	7.1	5
16	–Output Power Variation –SAR drift measurement	B	5.0	R	1.732	1	2.9	∞
Phantom and Tissue Parameters								
17	–Phantom Uncertainty(shape and thickness tolerances)	B	1.0	R	1.732	1	0.6	∞
18	–Liquid Conductivity Target –tolerance	B	5.0	R	1.732	0.6	1.7	∞
19	–Liquid Conductivity –measurement Uncertainty)	B	0.23	N	1	1	0.23	9
20	–Liquid Permittivity Target tolerance	B	5.0	R	1.732	0.6	1.7	∞
21	–Liquid Permittivity –measurement uncertainty	B	0.46	N	1	1	0.46	∞
<b>Combined Standard Uncertainty</b>				RSS			12.92	35.15
<b>Expanded uncertainty</b> (Confidence interval of 95 %)				K=2			25.84	

Table 7: Measurement Uncertainty for Body Worn Test according to IEC 62209-2

No.	Uncertainty Component	Type	Uncertainty Value (%)	Probability Distribution	k	ci	Standard Uncertainty (%) $u_i(\%)$	Degree of freedom $v_{eff}$ or $v_i$
<b>Measurement System</b>								
1	–Probe Calibration	B	6	N	1	1	3.5	$\infty$
2	–Isotropy	B	14.1	R	1.732	1	4.1	$\infty$
3	–Hemispherical Isotropy	B	9.4	R	1.732	1	5.4	$\infty$
4	–Boundary Effect	B	11.0	R	1.732	1	6.4	$\infty$
5	–Linearity	B	4.7	R	1.732	1	2.7	$\infty$
6	–System Detection Limits	B	1.0	R	1.732	1	0.6	$\infty$
7	–Readout Electronics	B	1.0	N	1	1	1.00	$\infty$
8	–Response Time	B	0.00	R	1.732	1	0.00	$\infty$
9	–Integration Time	B	0.00	R	1.732	1	0.00	$\infty$
10	–RF Ambient Conditions	B	3.0	R	1.732	1	1.73	$\infty$
11	–Probe Position Mechanical tolerance	B	0.4	R	1.732	1	0.2	$\infty$
12	–Probe Position with respect to Phantom Shell	B	2.9	R	1.732	1	1.7	$\infty$
13	–Post-processing	B	5.0	R	1.732	1	2.9	$\infty$
14	–Probe modulation response	B	0.4	R	1.732	1	0.2	$\infty$

Uncertainties of the DUT								
15	–Position of the DUT	A	4.8	N	1	1	4.8	5
16	– Holder of the DUT	A	7.1	N	1	1	7.1	5
17	–Power Scaling	B	1.0	R	1.732	1	0.6	$\infty$
18	–Output Power Variation –SAR drift measurement	B	5.0	R	1.732	1	2.9	$\infty$
Phantom and Tissue Parameters								
19	–Phantom Uncertainty(shape and thickness tolerances)	B	1.0	R	1.732	1	0.6	$\infty$
20	–Liquid Conductivity Target –tolerance	B	5.0	R	1.732	0.6	1.7	$\infty$
21	–Liquid Conductivity –measurement Uncertainty)	B	0.23	N	1	1	0.23	9
22	–Liquid Permittivity Target tolerance	B	5.0	R	1.732	0.6	1.7	$\infty$
23	–Liquid Permittivity –measurement uncertainty	B	0.46	N	1	1	0.46	$\infty$
24	– liquid temperature uncertainty	B	1	N	1	1	1	$\infty$
<b>Combined Standard Uncertainty</b>				RSS			13.12	44.15
<b>Expanded uncertainty</b> (Confidence interval of 95 %)				K=2			26.24	

## 11 MAIN TEST INSTRUMENTS

<b>EQUIPMENT</b>	<b>TYPE</b>	<b>Series No.</b>	<b>Last Calibration</b>	<b>Due Date</b>
System Simulator	E5515C	GB 47200710	2014/02/23	1 Year
SAR Probe	SATIMO	SN 09/13 EP169	2014/04/05	1 Year
Dipole	SID835	SN09/13 DIP0G835-217	2014/08/28	1 Year
Dipole	SID1900	SN09/13 DIP1G900-218	2014/08/28	1 Year
Network Analyzer	ZVB8	A0802530	2014/06/13	1 Year
Signal Generator	SMR27	A0304219	2014/06/10	1 Year
Amplifier	Nucletudes	143060	2014/04/05	1 Year
Power Meter	NRVS	1020.1809.02	2014/06/13	1 Year
Power Sensor	NRV-Z4	100069	2014/06/10	1 Year
Multimeter	Keithley-2000	4014020	2013/01/29	2 Year
Device Holder	SATIMO	SN 09/13 MSH80	2014/04/05	1 Year
SAM Phantom	SAM97	SN 09/13 SAM97	2014/04/05	1 Year

**ANNEX A**

**of**

**CCIC-SET**

**CONFORMANCE TEST REPORT FOR**

**HUMAN EXPOSURE TO ELECTROMAGNETIC FIELDS**

**SET2014-14194**

**Queclink Wireless Solutions Co.,Ltd D**

**GPS Locator**

**Type Name: GL300VC**

**Hardware Version: 1.02**

**Software Version: GL300VCR00A01V12M128\_MXIC**

**TEST LAYOUT**

**This Annex consists of 3 pages**

**Date of Report: 2014-12-18**



**Fig.2 COMO SAR Test System**



**Fig.3 Body Position (Face Upward)**



**Fig.4 Body Position (Back Upward)**



**Fig.5 Body Position (Bottom Side)**





**Fig.6 Body Position (Right Side)**



**Fig.7 Body Position (Left Side)**

**ANNEX B**

**of**

**CCIC-SET**

**CONFORMANCE TEST REPORT FOR**

**HUMAN EXPOSURE TO ELECTROMAGNETIC FIELDS**

**SET2014-14194**

**GPS Locator**

**Type Name: GL300VC**

**Hardware Version: 1.02**

**Software Version: GL300VCR00A01V12M128\_MXIC**

**Sample Photographs**

**This Annex consists of 3 pages**

**Date of Report: 2014-12-18**

1. Appearance



Appearance and size (obverse)



Appearance and size (reverse)

1. Inside



2. Battery



4. Adapter



5. Position of antennas

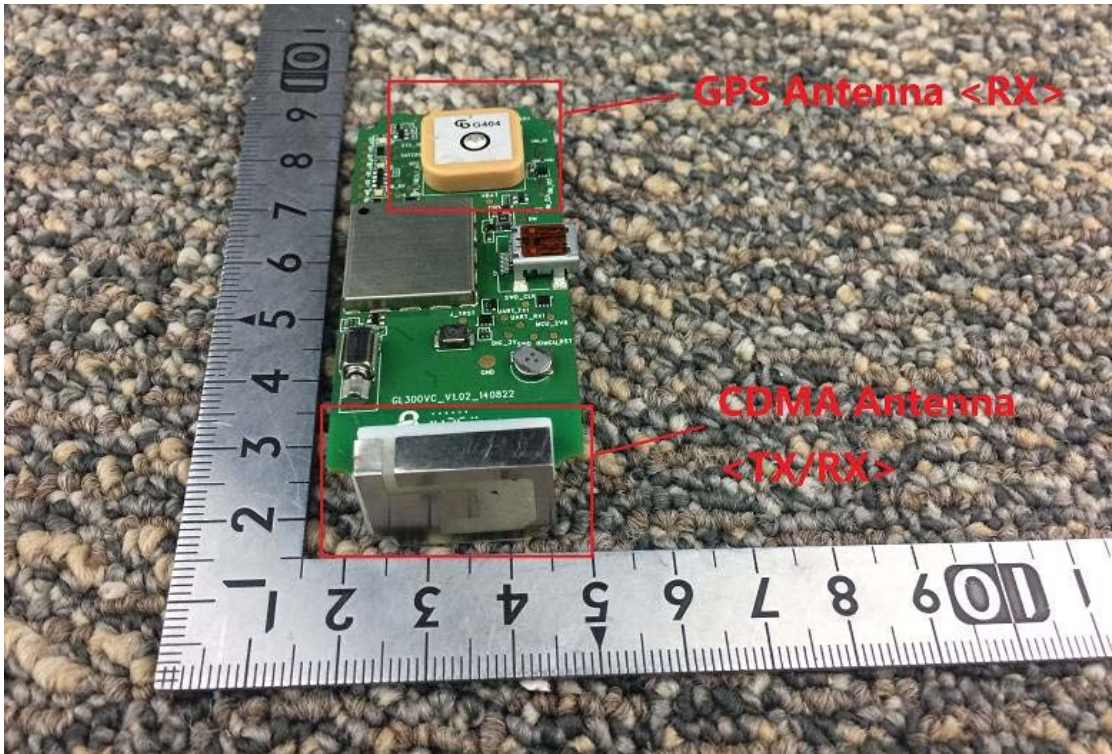

**ANNEX C**  
**of**  
**CCIC-SET**

**CONFORMANCE TEST REPORT FOR**  
**HUMAN EXPOSURE TO ELECTROMAGNETIC FIELDS**

**SET2014-14194**

**GPS Locator**

**Type Name: GL300VC**

**Hardware Version: 1.02**

**Software Version: GL300VCR00A01V12M128\_MXIC**

**Sample Photographs**

**This Annex consists of 4 pages**

**Date of Report: 2014-12-18**

## System Performance Check (Body, 835MHz)

Type: Phone measurement (Complete)

Area scan resolution: dx=8mm,dy=8mm

Zoom scan resolution: dx=8mm, dy=8mm, dz=5mm

Date of measurement: 16/12/2014

Measurement duration: 13 minutes 12 seconds

### A. Experimental conditions.

<b>Phantom File</b>	surf_sam_plan.txt
<b>Phantom</b>	Flat Plane
<b>Device Position</b>	Dipole
<b>Band</b>	835MHz
<b>Channels</b>	
<b>Signal</b>	CW

### B. SAR Measurement Results

#### Band SAR

<b>Frequency (MHz)</b>	835.000000
<b>Relative permittivity (real part)</b>	55.26
<b>Relative permittivity</b>	21.71
<b>Conductivity (S/m)</b>	0.98
<b>Power drift (%)</b>	-0.270000
<b>Ambient Temperature:</b>	23.2°C
<b>Liquid Temperature:</b>	23.5°C
<b>ConvF:</b>	5.68
<b>Duty factor:</b>	1:1

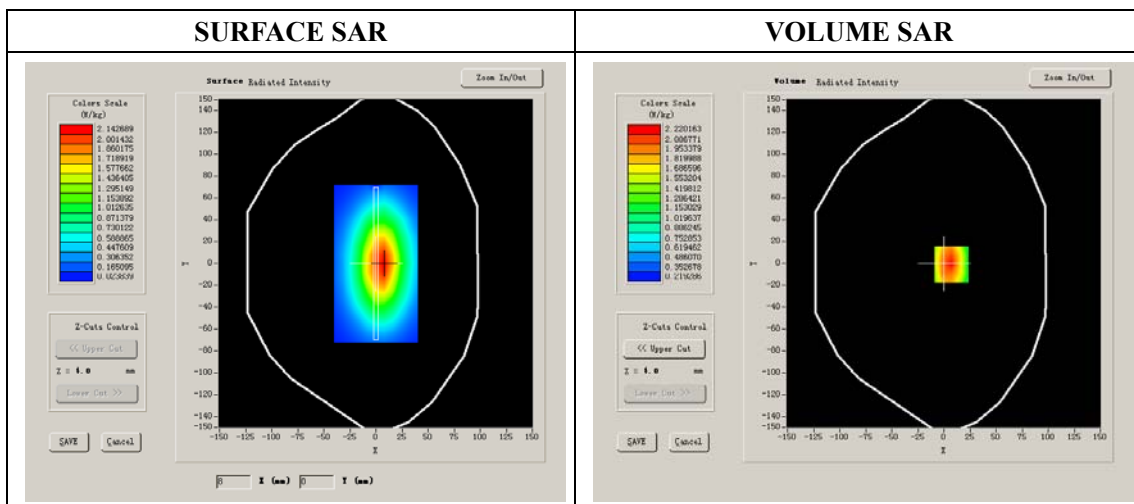

**Maximum location: X=7.00, Y=-1.00**

<b>SAR 10g (W/Kg)</b>	1.735712
<b>SAR 1g (W/Kg)</b>	2.643547

Z Axis Scan

<b>Z (mm)</b>	<b>0.00</b>	<b>4.00</b>	<b>9.00</b>	<b>14.00</b>	<b>19.00</b>	<b>24.00</b>	<b>29.00</b>
<b>SAR (W/Kg)</b>	<b>0.0000</b>	<b>2.5212</b>	<b>1.6645</b>	<b>1.1443</b>	<b>0.8082</b>	<b>0.5893</b>	<b>0.4148</b>

**SAR, Z Axis Scan (X = 7, Y = -1)**

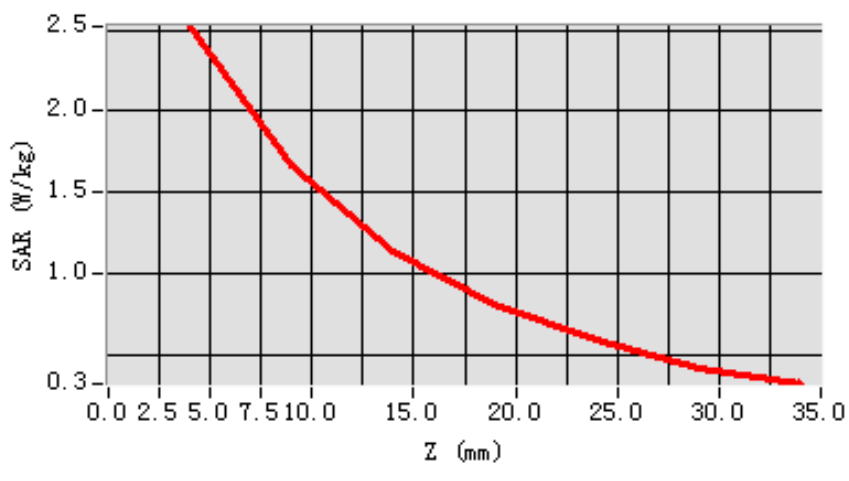

**3D scene shot**

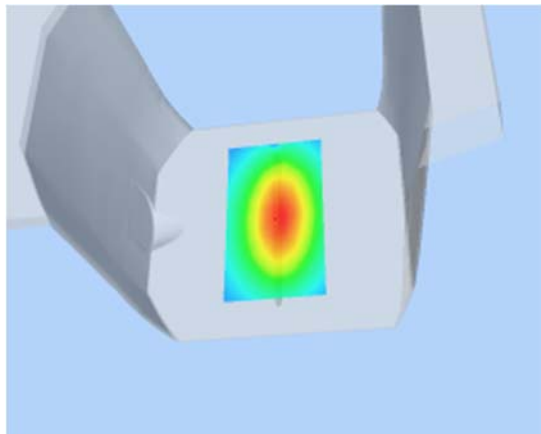

**Hot spot position**

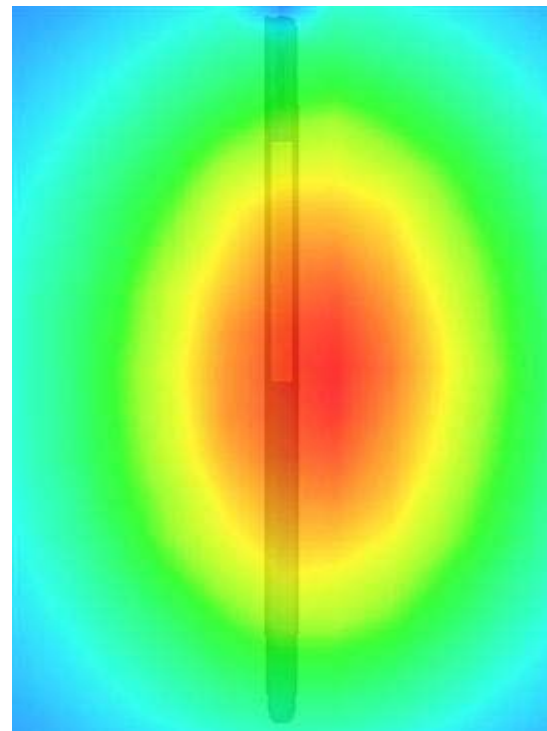



## System Performance Check (Body, 1900MHz)

Type: Phone measurement (Complete)

Area scan resolution: dx=8mm,dy=8mm

Zoom scan resolution: dx=8mm, dy=8mm, dz=5mm

Date of measurement: 16/12/2014

Measurement duration: 13 minutes 12 seconds

### A. Experimental conditions.

<b>Phantom File</b>	surf_sam_plan.txt
<b>Phantom</b>	Validation plane
<b>Device Position</b>	Dipole
<b>Band</b>	1900MHz
<b>Channels</b>	
<b>Signal</b>	CW

### B. SAR Measurement Results

#### Band SAR

<b>Frequency (MHz)</b>	1900.000000
<b>Relative permittivity (real part)</b>	53.28
<b>Relative permittivity</b>	12.99
<b>Conductivity (S/m)</b>	1.53
<b>Power Drift (%)</b>	0.410000
<b>Ambient Temperature:</b>	22.0°C
<b>Liquid Temperature:</b>	21.8°C
<b>ConvF:</b>	5.65
<b>Duty factor:</b>	1:1

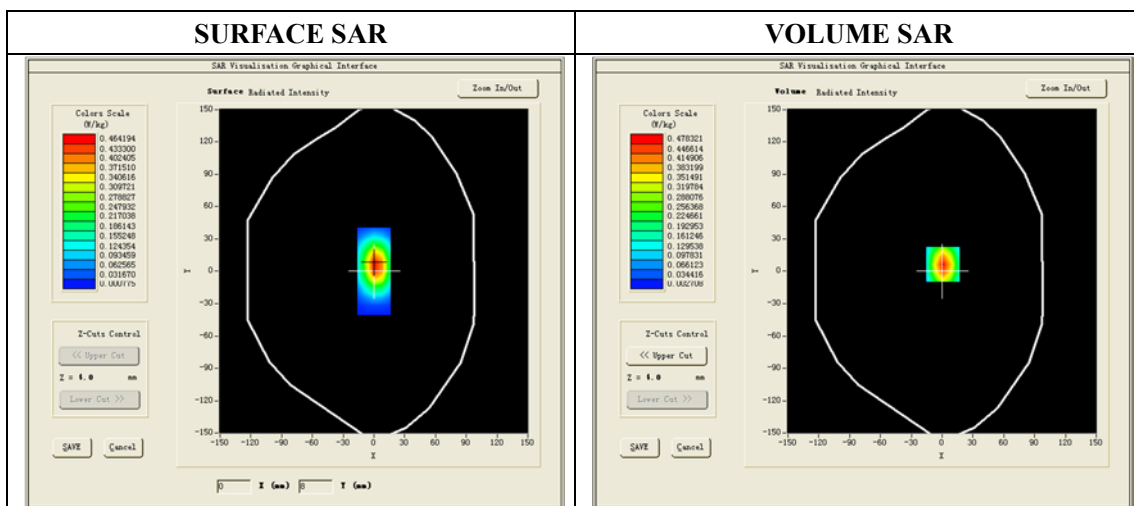

**Maximum location: X=1.00, Y=6.00**

<b>SAR 10g (W/Kg)</b>	5.215326
<b>SAR 1g (W/Kg)</b>	9.982523

**Z Axis Scan**

Z (mm)	0.00	4.00	9.00	14.00	19.00
SAR (W/Kg)	0.0000	10.0613	5.7282	3.6529	2.0314

**SAR, Z Axis Scan (X = 1, Y = 6)**

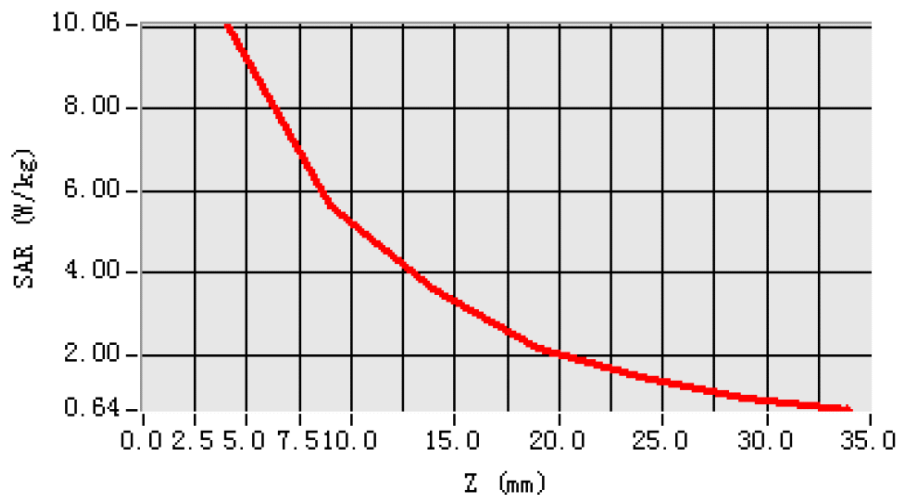

**3D scene shot**

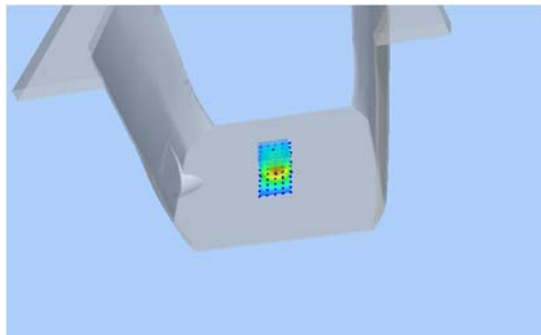

**Hot spot position**

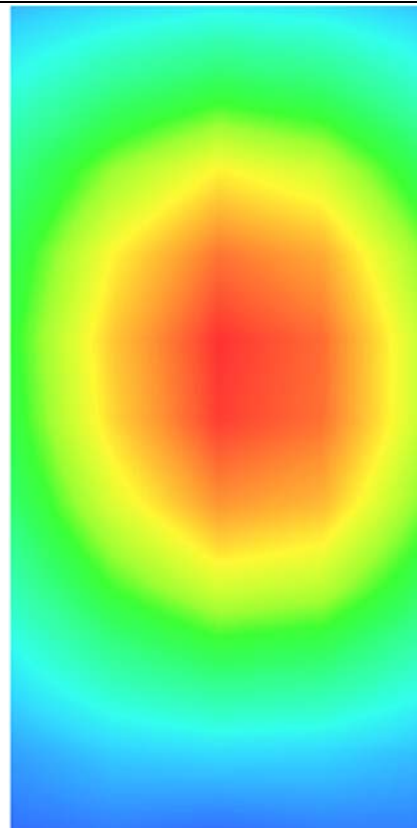

**ANNEX D**

**of**

**CCIC-SET**

**CONFORMANCE TEST REPORT FOR**

**HUMAN EXPOSURE TO ELECTROMAGNETIC FIELDS**

**SET2014-14194**

**Satimo**

**Type Name: SSE5**

**Calibration Certificate of Probe and Dipoles**

**This Annex consists of 33 pages**

**Date of Report: 2014-12-18**

**Probe Calibration Certificate**



**COMOSAR E-Field Probe Calibration Report**

Ref : ACR.96.2.14.SATU.A

**CCIC SOUTHERN ELECTRONIC PRODUCT  
TESTING (SHENZHEN) Co., Ltd**  
ELECTRONIC TESTING BUILDING, SHAHE ROAD, XILI  
TOWN, SHENZHEN, P.R. CHINA (POST CODE:518055)  
**SATIMO COMOSAR DOSIMETRIC E-FIELD PROBE**  
SERIAL NO.: SN 09/13 EP169

Calibrated at SATIMO US  
2105 Barrett Park Dr. - Kennesaw, GA 30144



04/05/14

*Summary:*

This document presents the method and results from an accredited COMOSAR Dosimetric E-Field Probe calibration performed in SATIMO USA using the CALISAR / CALIBAIR test bench, for use with a SATIMO COMOSAR system only. All calibration results are traceable to national metrology institutions.



## COMOSAR E-FIELD PROBE CALIBRATION REPORT

Ref: ACR.96.2.14.SATUA

	<i>Name</i>	<i>Function</i>	<i>Date</i>	<i>Signature</i>
<i>Prepared by :</i>	Jérôme LUC	Product Manager	04/05/2014	<i>JL</i>
<i>Checked by :</i>	Jérôme LUC	Product Manager	04/05/2014	<i>JL</i>
<i>Approved by :</i>	Kim RUTKOWSKI	Quality Manager	04/08/2014	<i>Kim Rutkowski</i>

	<i>Customer Name</i>
<i>Distribution :</i>	CCIC Southern Electronic Product Testing (Shenzhen) Co., Ltd

<i>Issue</i>	<i>Date</i>	<i>Modifications</i>
A	04/08/2014	Initial release

Page: 2/10

*This document shall not be reproduced, except in full or in part, without the written approval of SATIMO.  
The information contained herein is to be used only for the purpose for which it is submitted and is not to  
be released in whole or part without written approval of SATIMO.*



## TABLE OF CONTENTS

1	Device Under Test .....	4
2	Product Description.....	4
2.1	General Information .....	4
3	Measurement Method.....	4
3.1	Linearity.....	4
3.2	Sensitivity .....	5
3.3	Lower Detection Limit .....	5
3.4	Isotropy .....	5
3.5	Boundary Effect .....	5
4	Measurement Uncertainty .....	5
5	Calibration Measurement Results.....	6
5.1	Sensitivity in air .....	6
5.2	Linearity .....	7
5.3	Sensitivity in liquid.....	7
5.4	Isotropy.....	8
6	List of Equipment .....	10

Page: 3/10

*This document shall not be reproduced, except in full or in part, without the written approval of SATIMO.  
The information contained herein is to be used only for the purpose for which it is submitted and is not to  
be released in whole or part without written approval of SATIMO.*



## 1 DEVICE UNDER TEST

Device Under Test	
Device Type	COMOSAR DOSIMETRIC E FIELD PROBE
Manufacturer	Satimo
Model	SSE5
Serial Number	SN 09/13 EP169
Product Condition (new / used)	new
Frequency Range of Probe	0.7 GHz-3GHz
Resistance of Three Dipoles at Connector	Dipole 1: R1=0.223 MΩ Dipole 2: R2=0.233 MΩ Dipole 3: R3=0.222 MΩ

A yearly calibration interval is recommended.

## 2 PRODUCT DESCRIPTION

### 2.1 GENERAL INFORMATION

Satimo's COMOSAR E field Probes are built in accordance to the IEEE 1528, OET 65 Bulletin C and CEI/IEC 62209 standards.



Figure 1 – Satimo COMOSAR Dosimetric E field Dipole

Probe Length	330 mm
Length of Individual Dipoles	4.5 mm
Maximum external diameter	8 mm
Probe Tip External Diameter	5 mm
Distance between dipoles / probe extremity	2.7 mm

## 3 MEASUREMENT METHOD

The IEEE 1528, OET 65 Bulletin C, CENELEC EN50361 and CEI/IEC 62209 standards provide recommended practices for the probe calibrations, including the performance characteristics of interest and methods by which to assess their affect. All calibrations / measurements performed meet the fore mentioned standards.

### 3.1 LINEARITY

The evaluation of the linearity was done in free space using the waveguide, performing a power sweep to cover the SAR range 0.01W/kg to 100W/kg.

Page: 4/10

*This document shall not be reproduced, except in full or in part, without the written approval of SATIMO. The information contained herein is to be used only for the purpose for which it is submitted and is not to be released in whole or part without written approval of SATIMO.*



### 3.2 SENSITIVITY

The sensitivity factors of the three dipoles were determined using a two step calibration method (air and tissue simulating liquid) using waveguides as outlined in the standards.

### 3.3 LOWER DETECTION LIMIT

The lower detection limit was assessed using the same measurement set up as used for the linearity measurement. The required lower detection limit is 10 mW/kg.

### 3.4 ISOTROPY

The axial isotropy was evaluated by exposing the probe to a reference wave from a standard dipole with the dipole mounted under the flat phantom in the test configuration suggested for system validations and checks. The probe was rotated along its main axis from 0 - 360 degrees in 15 degree steps. The hemispherical isotropy is determined by inserting the probe in a thin plastic box filled with tissue-equivalent liquid, with the plastic box illuminated with the fields from a half wave dipole. The dipole is rotated about its axis (0°–180°) in 15° increments. At each step the probe is rotated about its axis (0°–360°).

### 3.5 BOUNDARY EFFECT

The boundary effect is defined as the deviation between the SAR measured data and the expected exponential decay in the liquid when the probe is oriented normal to the interface. To evaluate this effect, the liquid filled flat phantom is exposed to fields from either a reference dipole or waveguide. With the probe normal to the phantom surface, the peak spatial average SAR is measured and compared to the analytical value at the surface.

## 4 MEASUREMENT UNCERTAINTY

The guidelines outlined in the IEEE 1528, OET 65 Bulletin C, CENELEC EN50361 and CEI/IEC 62209 standards were followed to generate the measurement uncertainty associated with an E-field probe calibration using the waveguide technique. All uncertainties listed below represent an expanded uncertainty expressed at approximately the 95% confidence level using a coverage factor of  $k=2$ , traceable to the Internationally Accepted Guides to Measurement Uncertainty.

Uncertainty analysis of the probe calibration in waveguide					
ERROR SOURCES	Uncertainty value (%)	Probability Distribution	Divisor	ci	Standard Uncertainty (%)
Incident or forward power	3.00%	Rectangular	$\sqrt{3}$	1	1.733%
Reflected power	3.00%	Rectangular	$\sqrt{3}$	1	1.733%
Liquid conductivity	5.00%	Rectangular	$\sqrt{3}$	1	2.886%
Liquid permittivity	4.00%	Rectangular	$\sqrt{3}$	1	2.310%
Field homogeneity	3.00%	Rectangular	$\sqrt{3}$	1	1.733%
Field probe positioning	5.00%	Rectangular	$\sqrt{3}$	1	2.886%
Field probe linearity	3.00%	Rectangular	$\sqrt{3}$	1	1.733%

Page: 5/10

*This document shall not be reproduced, except in full or in part, without the written approval of SATIMO.  
The information contained herein is to be used only for the purpose for which it is submitted and is not to be released in whole or part without written approval of SATIMO.*





Combined standard uncertainty					5.832%
Expanded uncertainty 95 % confidence level k = 2					12.1%

5 CALIBRATION MEASUREMENT RESULTS

Calibration Parameters	
Liquid Temperature	23 °C
Lab Temperature	23 °C
Lab Humidity	58 %

5.1 SENSITIVITY IN AIR

Normx dipole 1 ( $\mu\text{V}/(\text{V}/\text{m})^2$ )	Normy dipole 2 ( $\mu\text{V}/(\text{V}/\text{m})^2$ )	Normz dipole 3 ( $\mu\text{V}/(\text{V}/\text{m})^2$ )
7.23	6.10	5.74

DCP dipole 1 (mV)	DCP dipole 2 (mV)	DCP dipole 3 (mV)
93.2	93.1	90.2

Calibration curves  $e_i=f(V)$  ( $i=1,2,3$ ) allow to obtain H-field value using the formula:

$$E = \sqrt{E_1^2 + E_2^2 + E_3^2}$$

Calibration curves

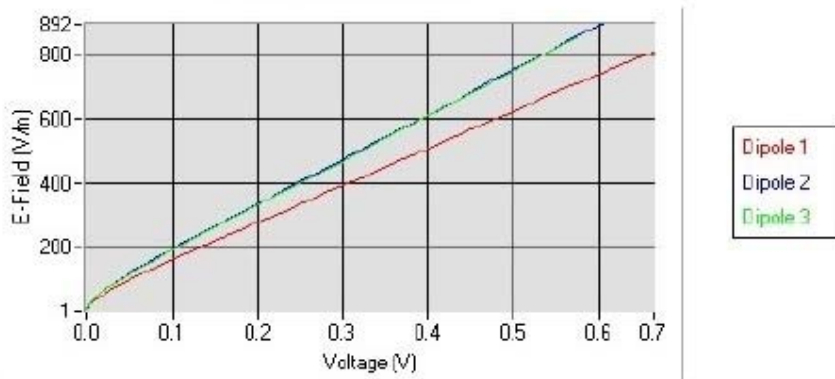



## 5.2 LINEARITY

### Linearity

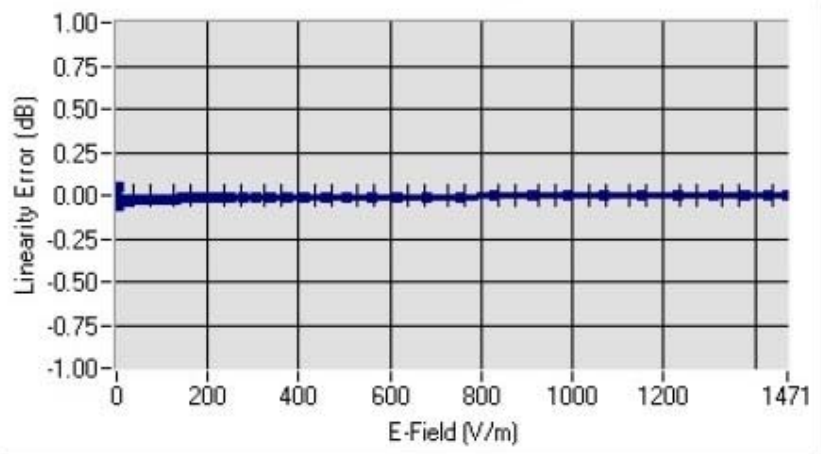

Linearity:  $\pm 1.42\%$  ( $\pm 0.06\text{dB}$ )

## 5.3 SENSITIVITY IN LIQUID

Liquid	Frequency (MHz +/- 100MHz)	Permittivity	Epsilon (S/m)	ConvF
HL850	835	42.56	0.87	5.51
BL850	835	55.26	0.97	5.68
HL900	900	41.79	0.97	5.20
BL900	900	55.98	1.05	5.33
HL1800	1750	40.17	1.39	4.80
BL1800	1750	52.05	1.49	4.94
HL1900	1880	39.80	1.45	5.49
BL1900	1880	52.55	1.52	5.65
HL2000	1950	38.93	1.42	4.80
BL2000	1950	53.12	1.50	5.02
HL2450	2450	38.64	1.83	4.81
BL2450	2450	52.02	1.95	4.91

LOWER DETECTION LIMIT: 9mW/kg

Page: 7/10

*This document shall not be reproduced, except in full or in part, without the written approval of SATIMO.  
The information contained herein is to be used only for the purpose for which it is submitted and is not to be released in whole or part without written approval of SATIMO.*



#### 5.4 ISOTROPY

##### HL900 MHz

- Axial isotropy: 0.04 dB
- Hemispherical isotropy: 0.04 dB

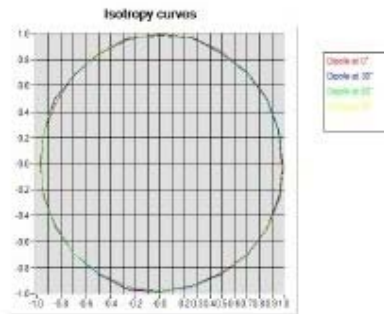

##### HL1800 MHz

- Axial isotropy: 0.05 dB
- Hemispherical isotropy: 0.06 dB

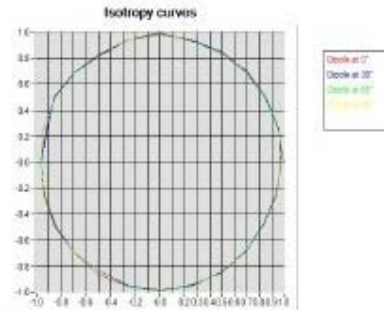

Page: 8/10

*This document shall not be reproduced, except in full or in part, without the written approval of SATIMO.  
The information contained herein is to be used only for the purpose for which it is submitted and is not to be released in whole or part without written approval of SATIMO.*



**HL2450 MHz**

- Axial isotropy: 0.07 dB
- Hemispherical isotropy: 0.08 dB

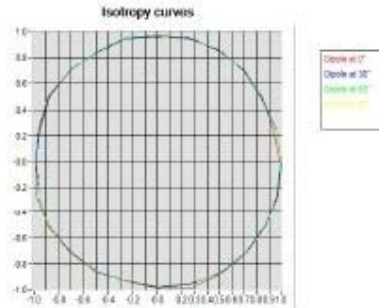



## 6 LIST OF EQUIPMENT

Equipment Summary Sheet				
Equipment Description	Manufacturer / Model	Identification No.	Current Calibration Date	Next Calibration Date
Flat Phantom	Satimo	SN-20/09-SAM71	Validated. No cal required.	Validated. No cal required.
COMOSAR Test Bench	Version 3	NA	Validated. No cal required.	Validated. No cal required.
Network Analyzer	Rhode & Schwarz ZVA	SN100132	02/2013	02/2016
Reference Probe	Satimo	EP 94 SN 37/08	Characterized prior to test. No cal required	Characterized prior to test. No cal required.
Multimeter	Keithley 2000	1188656	11/2013	11/2016
Signal Generator	Agilent E4438C	MY49070581	12/2013	12/2016
Amplifier	Aethercomm	SN 046	Characterized prior to test. No cal required.	Characterized prior to test. No cal required.
Power Meter	HP E4418A	US38261498	11/2013	11/2016
Power Sensor	HP ECP-E26A	US37181460	11/2013	11/2016
Directional Coupler	Narda 4216-20	01386	Characterized prior to test. No cal required	Characterized prior to test. No cal required.
Waveguide	Mega Industries	069Y7-158-13-712	Validated. No cal required.	Validated. No cal required.
Waveguide Transition	Mega Industries	069Y7-158-13-701	Validated. No cal required.	Validated. No cal required.
Waveguide Termination	Mega Industries	069Y7-158-13-701	Validated. No cal required.	Validated. No cal required.
Temperature / Humidity Sensor	Control Company	11-661-9	3/2014	3/2016

Page: 10/10

*This document shall not be reproduced, except in full or in part, without the written approval of SATIMO. The information contained herein is to be used only for the purpose for which it is submitted and is not to be released in whole or part without written approval of SATIMO.*

**SID835 Dipole Calibration Certificate**



**SAR Reference Dipole Calibration Report**

Ref : ACR.240.1.14.SATU.A

**CCIC SOUTHERN ELECTRONIC PRODUCT  
TESTING (SHENZHEN) CO., LTD  
ELECTRONIC TESTING BUILDING, SHAHE ROAD, XILI  
TOWN  
SHENZHEN, P.R. CHINA (POST CODE:518055)  
SATIMO COMOSAR REFERENCE DIPOLE  
FREQUENCY: 835 MHZ  
SERIAL NO.: SN 09/13 DIP0G835-217**

**Calibrated at SATIMO US  
2105 Barrett Park Dr. - Kennesaw, GA 30144**



**08/28/14**

*Summary:*

This document presents the method and results from an accredited SAR reference dipole calibration performed in SATIMO USA using the COMOSAR test bench. All calibration results are traceable to national metrology institutions.



## SAR REFERENCE DIPOLE CALIBRATION REPORT

Ref: ACB 200 1 14 SAT11 A

	<i>Name</i>	<i>Function</i>	<i>Date</i>	<i>Signature</i>
<i>Prepared by :</i>	Jérôme LUC	Product Manager	8/29/2014	<i>JS</i>
<i>Checked by :</i>	Jérôme LUC	Product Manager	8/29/2014	<i>JS</i>
<i>Approved by :</i>	Kim RUTKOWSKI	Quality Manager	8/29/2014	<i>Kim Rutkowski</i>

	<i>Customer Name</i>
<i>Distribution :</i>	CCIC SOUTHERN ELECTRONIC PRODUCT TESTING (SHENZHEN) Co., Ltd

<i>Issue</i>	<i>Date</i>	<i>Modifications</i>
A	8/29/2014	Initial release

Page: 2/11

*This document shall not be reproduced, except in full or in part, without the written approval of SATIMO.*



## TABLE OF CONTENTS

1	Introduction.....	4
2	Device Under Test .....	4
3	Product Description .....	4
3.1	General Information .....	4
4	Measurement Method .....	5
4.1	Return Loss Requirements .....	5
4.2	Mechanical Requirements .....	5
5	Measurement Uncertainty .....	5
5.1	Return Loss .....	5
5.2	Dimension Measurement .....	5
5.3	Validation Measurement .....	5
6	Calibration Measurement Results .....	6
6.1	Return Loss and Impedance In Head Liquid .....	6
6.2	Return Loss and Impedance In Body Liquid .....	6
6.3	Mechanical Dimensions .....	6
7	Validation measurement .....	7
7.1	Head Liquid Measurement .....	7
7.2	SAR Measurement Result With Head Liquid .....	8
7.3	Body Liquid Measurement .....	9
7.4	SAR Measurement Result With Body Liquid .....	10
8	List of Equipment .....	11

Page: 3/11

*This document shall not be reproduced, except in full or in part, without the written approval of SATIMO.*





## 1 INTRODUCTION

This document contains a summary of the requirements set forth by the IEEE 1528, OET 65 Bulletin C and CEI/IEC 62209 standards for reference dipoles used for SAR measurement system validations and the measurements that were performed to verify that the product complies with the fore mentioned standards.

## 2 DEVICE UNDER TEST

Device Under Test	
Device Type	COMOSAR 83.5 MHz REFERENCE DIPOLE
Manufacturer	Satimo
Model	SID835
Serial Number	SN 09/13 DIP0G835-217
Product Condition (new / used)	used

A yearly calibration interval is recommended.

## 3 PRODUCT DESCRIPTION

### 3.1 GENERAL INFORMATION

Satimo's COMOSAR Validation Dipoles are built in accordance to the IEEE 1528, OET 65 Bulletin C and CEI/IEC 62209 standards. The product is designed for use with the COMOSAR test bench only.



**Figure 1 – Satimo COMOSAR Validation Dipole**



#### 4 MEASUREMENT METHOD

The IEEE 1528, OET 65 Bulletin C and CEI/IEC 62209 standards provide requirements for reference dipoles used for system validation measurements. The following measurements were performed to verify that the product complies with the fore mentioned standards.

##### 4.1 RETURN LOSS REQUIREMENTS

The dipole used for SAR system validation measurements and checks must have a return loss of -20 dB or better. The return loss measurement shall be performed against a liquid filled flat phantom, with the phantom constructed as outlined in the fore mentioned standards.

##### 4.2 MECHANICAL REQUIREMENTS

The IEEE Std. 1528 and CEI/IEC 62209 standards specify the mechanical components and dimensions of the validation dipoles, with the dimensions frequency and phantom shell thickness dependent. The COMOSAR test bench employs a 2 mm phantom shell thickness therefore the dipoles sold for use with the COMOSAR test bench comply with the requirements set forth for a 2 mm phantom shell thickness.

#### 5 MEASUREMENT UNCERTAINTY

All uncertainties listed below represent an expanded uncertainty expressed at approximately the 95% confidence level using a coverage factor of  $k=2$ , traceable to the Internationally Accepted Guides to Measurement Uncertainty.

##### 5.1 RETURN LOSS

The following uncertainties apply to the return loss measurement:

Frequency band	Expanded Uncertainty on Return Loss
400-6000MHz	0.1 dB

##### 5.2 DIMENSION MEASUREMENT

The following uncertainties apply to the dimension measurements:

Length (mm)	Expanded Uncertainty on Length
3 - 300	0.05 mm

##### 5.3 VALIDATION MEASUREMENT

The guidelines outlined in the IEEE 1528, OET 65 Bulletin C, CENELEC EN50361 and CEI/IEC 62209 standards were followed to generate the measurement uncertainty for validation measurements.

Scan Volume	Expanded Uncertainty
1 g	20.3 %
10 g	20.1 %

Page: 5/11

*This document shall not be reproduced, except in full or in part, without the written approval of SATIMO*



## 6 CALIBRATION MEASUREMENT RESULTS

### 6.1 RETURN LOSS AND IMPEDANCE IN HEAD LIQUID

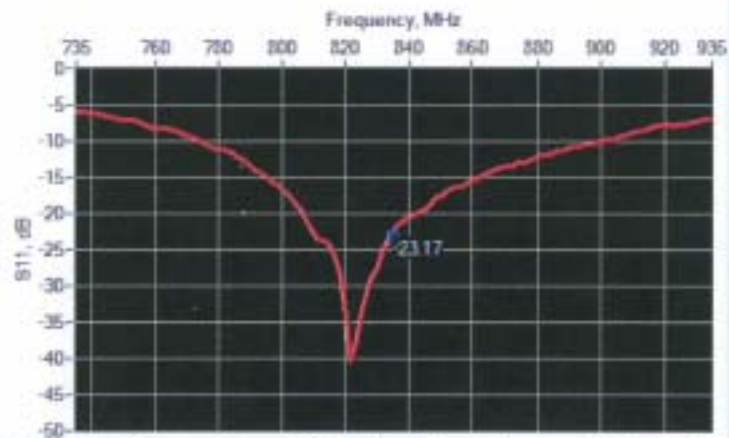

Frequency (MHz)	Return Loss (dB)	Requirement (dB)	Impedance
835	-23.17	-20	$57.4 \Omega - 0.2 j\Omega$

### 6.2 RETURN LOSS AND IMPEDANCE IN BODY LIQUID

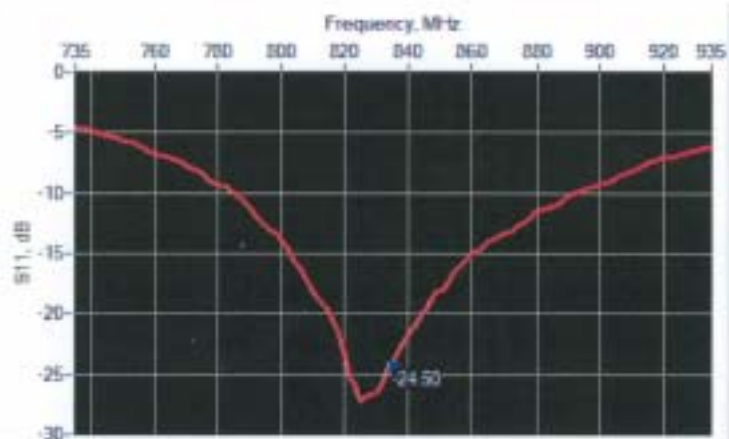

Frequency (MHz)	Return Loss (dB)	Requirement (dB)	Impedance
835	-24.50	-20	$55.0 \Omega + 3.9 j\Omega$

### 6.3 MECHANICAL DIMENSIONS

Frequency MHz	L mm		Is mm		d mm	
	required	measured	required	measured	required	measured
300	420.0 ±1 %		250.0 ±1 %		6.35 ±1 %	
450	290.0 ±1 %		166.7 ±1 %		6.35 ±1 %	
750	176.0 ±1 %		100.0 ±1 %		6.35 ±1 %	
835	161.0 ±1 %	PASS	89.8 ±1 %	PASS	1.6 ±1 %	PASS

Page: 6/11

This document shall not be reproduced, except in full or in part, without the written approval of SATIMO.



900	149.0 ±1 %		83.3 ±1 %		3.6 ±1 %
1450	89.1 ±1 %		51.7 ±1 %		3.6 ±1 %
1500	80.5 ±1 %		50.0 ±1 %		3.6 ±1 %
1640	79.0 ±1 %		45.7 ±1 %		3.6 ±1 %
1750	75.2 ±1 %		42.9 ±1 %		3.6 ±1 %
1800	72.0 ±1 %		41.7 ±1 %		3.6 ±1 %
1900	68.0 ±1 %		39.5 ±1 %		3.6 ±1 %
1950	66.3 ±1 %		38.5 ±1 %		3.6 ±1 %
2000	64.5 ±1 %		37.5 ±1 %		3.6 ±1 %
2100	61.0 ±1 %		35.7 ±1 %		3.6 ±1 %
2300	55.5 ±1 %		32.6 ±1 %		3.6 ±1 %
2450	51.5 ±1 %		30.4 ±1 %		3.6 ±1 %
2600	48.5 ±1 %		28.8 ±1 %		3.6 ±1 %
3000	41.5 ±1 %		25.0 ±1 %		3.6 ±1 %
3500	37.0 ±1 %		26.4 ±1 %		3.6 ±1 %
3700	34.7 ±1 %		26.4 ±1 %		3.6 ±1 %

## 7 VALIDATION MEASUREMENT

The IEEE Std. 1528, OET 65 Bulletin C and CEI/IEC 62209 standards state that the system validation measurements must be performed using a reference dipole meeting the fore mentioned return loss and mechanical dimension requirements. The validation measurement must be performed against a liquid filled flat phantom, with the phantom constructed as outlined in the fore mentioned standards. Per the standards, the dipole shall be positioned below the bottom of the phantom, with the dipole length centered and parallel to the longest dimension of the flat phantom, with the top surface of the dipole at the described distance from the bottom surface of the phantom.

### 7.1 HEAD LIQUID MEASUREMENT

Frequency MHz	Relative permittivity ( $\epsilon_r$ )		Conductivity ( $\sigma$ ) S/m	
	required	measured	required	measured
300	45.3 ±5 %		0.87 ±5 %	
450	43.5 ±5 %		0.87 ±5 %	
750	41.9 ±5 %		0.89 ±5 %	
835	41.5 ±5 %	PASS	0.90 ±5 %	PASS
900	41.5 ±5 %		0.97 ±5 %	
1450	40.5 ±5 %		1.20 ±5 %	
1500	40.4 ±5 %		1.23 ±5 %	
1640	40.2 ±5 %		1.31 ±5 %	
1750	40.1 ±5 %		1.37 ±5 %	
1800	40.0 ±5 %		1.40 ±5 %	
1900	40.0 ±5 %		1.40 ±5 %	
1950	40.0 ±5 %		1.40 ±5 %	
2000	40.0 ±5 %		1.40 ±5 %	

Page: 7/11

This document shall not be reproduced, except in full or in part, without the written approval of SATIMO.



## SAR REFERENCE DIPOLE CALIBRATION REPORT

Ref: ACR.240.1.14.SATU.A

2100	39.8 ±5 %		1.49 ±5 %	
2300	39.5 ±5 %		1.67 ±5 %	
2450	39.2 ±5 %		1.80 ±5 %	
2600	39.0 ±5 %		1.96 ±5 %	
3000	38.5 ±5 %		2.40 ±5 %	
3500	37.9 ±5 %		2.91 ±5 %	

## 7.2 SAR MEASUREMENT RESULT WITH HEAD LIQUID

The IEEE Std. 1528 and CEI/IEC 62209 standards state that the system validation measurements should produce the SAR values shown below (for phantom thickness of 2 mm), within the uncertainty for the system validation. All SAR values are normalized to 1 W forward power. In bracket, the measured SAR is given with the used input power.

Software	OPENSAR V4
Phantom	SN 20/09 SAM71
Probe	SN 18/11 EPG122
Liquid	Head Liquid Values: $\epsilon_p' : 42.3$ $\sigma : 0.92$
Distance between dipole center and liquid	15.0 mm
Area scan resolution	$dx=8mm/dy=8mm$
Zoon Scan Resolution	$dx=8mm/dy=8mm/dz=5mm$
Frequency	835 MHz
Input power	20 dBm
Liquid Temperature	21 °C
Lab Temperature	21 °C
Lab Humidity	45 %

Frequency MHz	1 g SAR (W/kg/W)		10 g SAR (W/kg/W)	
	required	measured	required	measured
300	2.85		1.94	
450	4.58		3.06	
750	8.49		5.55	
835	9.56	9.77 (0.98)	6.22	6.30 (0.63)
900	10.9		6.99	
1450	29		16	
1500	30.5		16.8	
1640	34.2		18.4	
1750	36.4		19.3	
1800	38.4		20.1	
1900	39.7		20.5	
1950	40.5		20.9	
2000	41.1		21.1	
2100	43.6		21.9	
2300	48.7		23.3	

Page: 8/11

*This document shall not be reproduced, except in full or in part, without the written approval of SATIMO.*



SAR REFERENCE DIPOLE CALIBRATION REPORT

Ref: ACR 240.1.14.SAT.U.A.

2450	52.4		24	
2600	55.3		24.6	
3000	63.8		25.7	
3500	67.1		25	

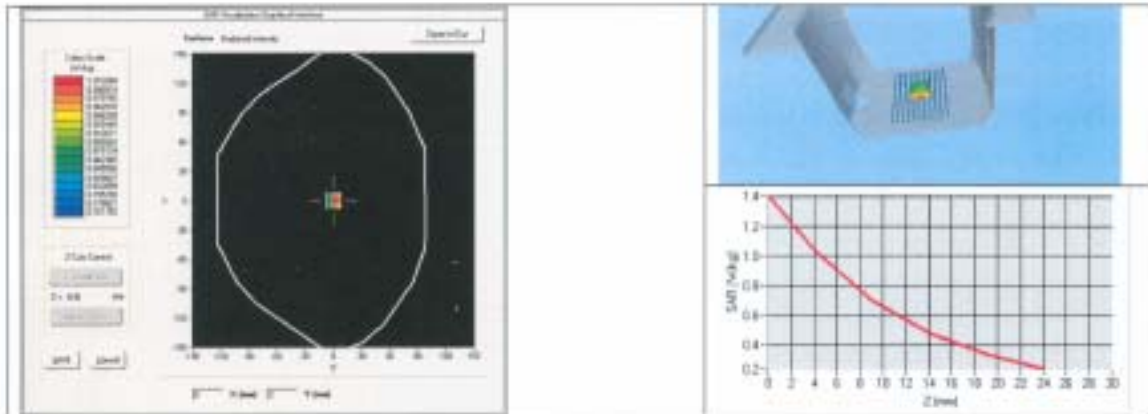

7.3 BODY LIQUID MEASUREMENT

Frequency MHz	Relative permittivity ( $\epsilon_r$ )		Conductivity ( $\sigma$ ) S/m	
	required	measured	required	measured
150	61.9 ±5 %		0.80 ±5 %	
300	58.2 ±5 %		0.92 ±5 %	
450	56.7 ±5 %		0.94 ±5 %	
750	55.5 ±5 %		0.96 ±5 %	
835	55.2 ±5 %	PASS	0.97 ±5 %	PASS
900	55.0 ±5 %		1.05 ±5 %	
915	55.0 ±5 %		1.06 ±5 %	
1450	54.0 ±5 %		1.30 ±5 %	
1610	53.8 ±5 %		1.40 ±5 %	
1800	53.3 ±5 %		1.52 ±5 %	
1900	53.3 ±5 %		1.52 ±5 %	
2000	53.3 ±5 %		1.52 ±5 %	
2100	53.2 ±5 %		1.62 ±5 %	
2450	52.7 ±5 %		1.95 ±5 %	
2600	52.5 ±5 %		2.16 ±5 %	
3000	52.0 ±5 %		2.73 ±5 %	
3500	51.3 ±5 %		3.31 ±5 %	
5200	49.0 ±10 %		5.30 ±10 %	
5300	48.9 ±10 %		5.42 ±10 %	
5400	48.7 ±10 %		5.53 ±10 %	



5500	48.6 ±10 %		5.65 ±10 %	
5600	48.5 ±10 %		5.77 ±10 %	
5800	48.2 ±10 %		6.00 ±10 %	

7.4 SAR MEASUREMENT RESULT WITH BODY LIQUID

Software	OPENSAR V4
Phantom	SN 20/09 SAM71
Probe	SN 18/11 EPG122
Liquid	Body Liquid Values: $\epsilon_{ps}^*$ : 54.1 sigma : 0.97
Distance between dipole center and liquid	15.0 mm
Area scan resolution	dx=8mm/dy=8mm
Zoon Scan Resolution	dx=8mm/dy=8m/dz=5mm
Frequency	835 MHz
Input power	20 dBm
Liquid Temperature	21 °C
Lab Temperature	21 °C
Lab Humidity	45 %

Frequency MHz	1 g SAR (W/kg/W)	10 g SAR (W/kg/W)
	measured	measured
835	10.31 (1.03)	6.74 (0.67)

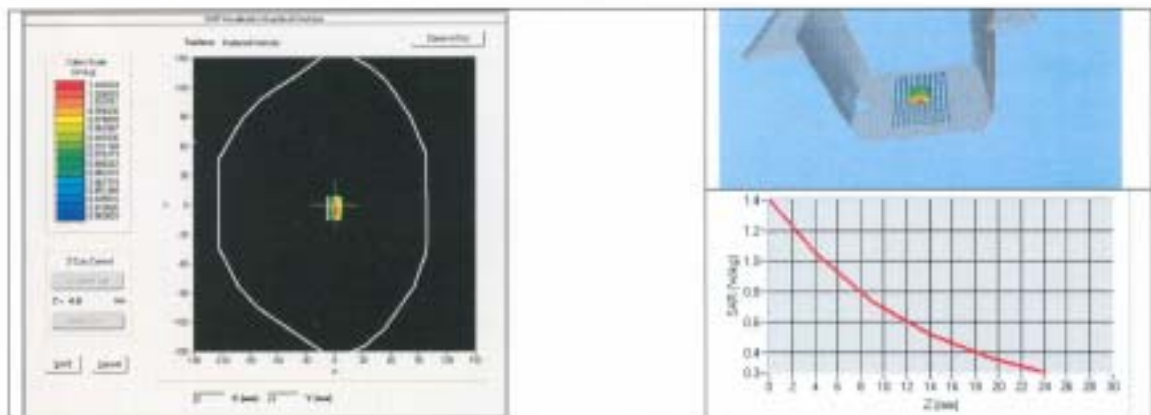



## 8 LIST OF EQUIPMENT

Equipment Summary Sheet				
Equipment Description	Manufacturer / Model	Identification No.	Current Calibration Date	Next Calibration Date
SAM Phantom	Satimo	SN-20/09-SAM71	Validated. No cal required.	Validated. No cal required.
COMOSAR Test Bench	Version 3	NA	Validated. No cal required.	Validated. No cal required.
Network Analyzer	Rhode & Schwarz ZVA	SN100132	02/2013	02/2016
Calipers	Carrera	CALIPER-01	12/2013	12/2016
Reference Probe	Satimo	EPG122 SN 18/11	10/2013	10/2014
Multimeter	Keithley 2000	1188656	12/2013	12/2016
Signal Generator	Agilent E4438C	MY49070581	12/2013	12/2016
Amplifier	Aethercomm	SN 046	Characterized prior to test. No cal required.	Characterized prior to test. No cal required.
Power Meter	HP E4418A	US38261498	12/2013	12/2016
Power Sensor	HP ECP-E26A	US37181460	12/2013	12/2016
Directional Coupler	Narda 4216-20	01386	Characterized prior to test. No cal required.	Characterized prior to test. No cal required.
Temperature and Humidity Sensor	Control Company	11-661-9	8/2012	8/2015

Page: 11/11

*This document shall not be reproduced, except in full or in part, without the written approval of SATIMO.*



**SID1900 Dipole Calibration Certificate**



**SAR Reference Dipole Calibration Report**

Ref : ACR.240.4.14.SATU.A

**CCIC SOUTHERN ELECTRONIC PRODUCT  
TESTING (SHENZHEN) CO., LTD**  
ELECTRONIC TESTING BUILDING, SHAHE ROAD, XILI  
TOWN  
SHENZHEN, P.R. CHINA (POST CODE:518055)  
**SATIMO COMOSAR REFERENCE DIPOLE**  
FREQUENCY: 1900 MHZ  
SERIAL NO.: SN 09/13 DIP1G900-218

Calibrated at SATIMO US  
2105 Barrett Park Dr. - Kennesaw, GA 30144



08/28/14

*Summary:*

This document presents the method and results from an accredited SAR reference dipole calibration performed in SATIMO USA using the COMOSAR test bench. All calibration results are traceable to national metrology institutions.



	<i>Name</i>	<i>Function</i>	<i>Date</i>	<i>Signature</i>
<i>Prepared by :</i>	Jérôme LUC	Product Manager	8/29/2014	<i>JS</i>
<i>Checked by :</i>	Jérôme LUC	Product Manager	8/29/2014	<i>JS</i>
<i>Approved by :</i>	Kim RUTKOWSKI	Quality Manager	8/29/2014	<i>Kim Rutkowski</i>

	<i>Customer Name</i>
<i>Distribution :</i>	CCIC SOUTHERN ELECTRONIC PRODUCT TESTING (SHENZHEN) Co., Ltd

<i>Issue</i>	<i>Date</i>	<i>Modifications</i>
A	8/29/2014	Initial release



## TABLE OF CONTENTS

1	Introduction.....	4
2	Device Under Test .....	4
3	Product Description .....	4
3.1	General Information .....	4
4	Measurement Method .....	5
4.1	Return Loss Requirements .....	5
4.2	Mechanical Requirements .....	5
5	Measurement Uncertainty .....	5
5.1	Return Loss .....	5
5.2	Dimension Measurement .....	5
5.3	Validation Measurement .....	5
6	Calibration Measurement Results .....	6
6.1	Return Loss and Impedance In Head Liquid .....	6
6.2	Return Loss and Impedance In Body Liquid .....	6
6.3	Mechanical Dimensions .....	6
7	Validation measurement .....	7
7.1	Head Liquid Measurement .....	7
7.2	SAR Measurement Result With Head Liquid .....	8
7.3	Body Liquid Measurement .....	9
7.4	SAR Measurement Result With Body Liquid .....	10
8	List of Equipment .....	11



## 1 INTRODUCTION

This document contains a summary of the requirements set forth by the IEEE 1528, OET 65 Bulletin C and CEI/IEC 62209 standards for reference dipoles used for SAR measurement system validations and the measurements that were performed to verify that the product complies with the fore mentioned standards.

## 2 DEVICE UNDER TEST

Device Under Test	
Device Type	COMOSAR 1900 MHz REFERENCE DIPOLE
Manufacturer	Satimo
Model	SID1900
Serial Number	SN 09/13 DIP1 G900-218
Product Condition (new / used)	Used

A yearly calibration interval is recommended.

## 3 PRODUCT DESCRIPTION

### 3.1 GENERAL INFORMATION

Satimo's COMOSAR Validation Dipoles are built in accordance to the IEEE 1528, OET 65 Bulletin C and CEI/IEC 62209 standards. The product is designed for use with the COMOSAR test bench only.



Figure 1 – Satimo COMOSAR Validation Dipole



#### 4 MEASUREMENT METHOD

The IEEE 1528, OET 65 Bulletin C and CEI/IEC 62209 standards provide requirements for reference dipoles used for system validation measurements. The following measurements were performed to verify that the product complies with the fore mentioned standards.

##### 4.1 RETURN LOSS REQUIREMENTS

The dipole used for SAR system validation measurements and checks must have a return loss of -20 dB or better. The return loss measurement shall be performed against a liquid filled flat phantom, with the phantom constructed as outlined in the fore mentioned standards.

##### 4.2 MECHANICAL REQUIREMENTS

The IEEE Std. 1528 and CEI/IEC 62209 standards specify the mechanical components and dimensions of the validation dipoles, with the dimensions frequency and phantom shell thickness dependent. The COMOSAR test bench employs a 2 mm phantom shell thickness therefore the dipoles sold for use with the COMOSAR test bench comply with the requirements set forth for a 2 mm phantom shell thickness.

#### 5 MEASUREMENT UNCERTAINTY

All uncertainties listed below represent an expanded uncertainty expressed at approximately the 95% confidence level using a coverage factor of  $k=2$ , traceable to the Internationally Accepted Guides to Measurement Uncertainty.

##### 5.1 RETURN LOSS

The following uncertainties apply to the return loss measurement:

Frequency band	Expanded Uncertainty on Return Loss
400-6000MHz	0.1 dB

##### 5.2 DIMENSION MEASUREMENT

The following uncertainties apply to the dimension measurements:

Length (mm)	Expanded Uncertainty on Length
3 - 300	0.05 mm

##### 5.3 VALIDATION MEASUREMENT

The guidelines outlined in the IEEE 1528, OET 65 Bulletin C, CENELEC EN50361 and CEI/IEC 62209 standards were followed to generate the measurement uncertainty for validation measurements.

Scan Volume	Expanded Uncertainty
1 g	20.3 %
10 g	20.1 %

Page: 5/11

*This document shall not be reproduced, except in full or in part, without the written approval of SATIMO.  
The information contained herein is to be used only for the purpose for which it is submitted and is not to be released in whole or part without written approval of SATIMO.*



6 CALIBRATION MEASUREMENT RESULTS

6.1 RETURN LOSS AND IMPEDANCE IN HEAD LIQUID

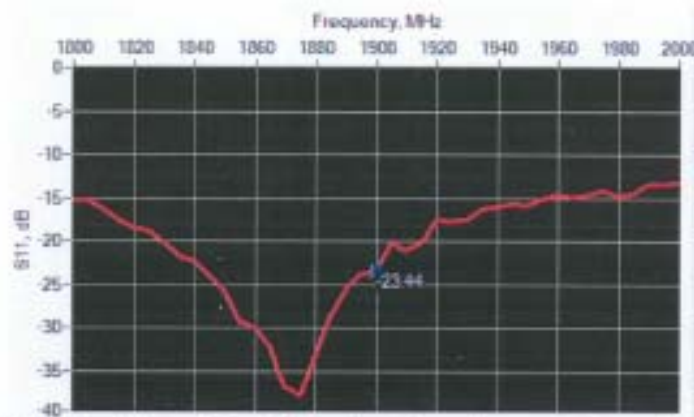

Frequency (MHz)	Return Loss (dB)	Requirement (dB)	Impedance
1900	-23.44	-20	55.4 Ω + 5.2 jΩ

6.2 RETURN LOSS AND IMPEDANCE IN BODY LIQUID

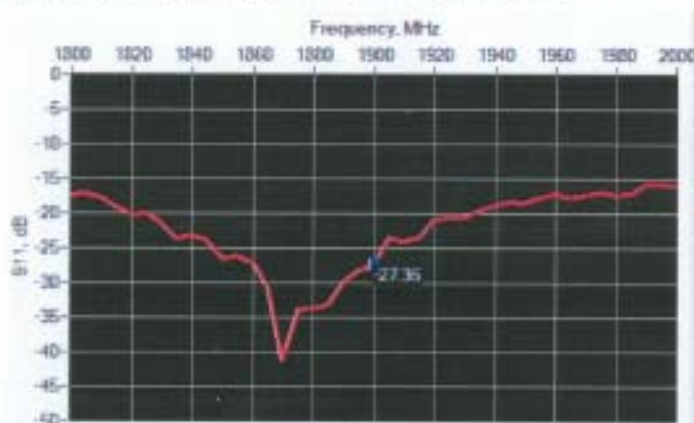

Frequency (MHz)	Return Loss (dB)	Requirement (dB)	Impedance
1900	-27.36	-20	51.7 Ω + 4.4 jΩ

6.3 MECHANICAL DIMENSIONS

Frequency MHz	L mm		h mm		d mm	
	required	measured	required	measured	required	measured
300	420.0 ±1 %		250.0 ±1 %		6.35 ±1 %	
450	290.0 ±1 %		166.7 ±1 %		6.35 ±1 %	
750	176.0 ±1 %		100.0 ±1 %		6.35 ±1 %	
835	161.0 ±1 %		89.8 ±1 %		3.6 ±1 %	

Page: 6/11

*This document shall not be reproduced, except in full or in part, without the written approval of SATIMO. The information contained herein is to be used only for the purpose for which it is submitted and is not to be released in whole or part without written approval of SATIMO.*



## SAR REFERENCE DIPOLE CALIBRATION REPORT

Ref: ACR.240.4.14.SAT1.A

900	149.0 ±1 %		83.3 ±1 %		3.6 ±1 %	
1450	89.1 ±1 %		51.7 ±1 %		3.6 ±1 %	
1500	80.5 ±1 %		50.0 ±1 %		3.6 ±1 %	
1640	79.0 ±1 %		45.7 ±1 %		3.6 ±1 %	
1750	75.2 ±1 %		42.9 ±1 %		3.6 ±1 %	
1800	72.0 ±1 %		41.7 ±1 %		3.6 ±1 %	
1900	68.0 ±1 %	PASS	39.5 ±1 %	PASS	3.6 ±1 %	PASS
1950	66.3 ±1 %		38.5 ±1 %		3.6 ±1 %	
2000	64.5 ±1 %		37.5 ±1 %		3.6 ±1 %	
2100	61.0 ±1 %		35.7 ±1 %		3.6 ±1 %	
2300	55.5 ±1 %		32.6 ±1 %		3.6 ±1 %	
2450	51.5 ±1 %		30.4 ±1 %		3.6 ±1 %	
2600	48.5 ±1 %		28.8 ±1 %		3.6 ±1 %	
3000	41.5 ±1 %		25.0 ±1 %		3.6 ±1 %	
3500	37.0 ±1 %		26.4 ±1 %		3.6 ±1 %	
3700	34.7 ±1 %		26.4 ±1 %		3.6 ±1 %	

## 7 VALIDATION MEASUREMENT

The IEEE Std. 1528, OET 65 Bulletin C and CEI/IEC 62209 standards state that the system validation measurements must be performed using a reference dipole meeting the fore mentioned return loss and mechanical dimension requirements. The validation measurement must be performed against a liquid filled phantom, with the phantom constructed as outlined in the fore mentioned standards. Per the standards, the dipole shall be positioned below the bottom of the phantom, with the dipole length centered and parallel to the longest dimension of the flat phantom, with the top surface of the dipole at the described distance from the bottom surface of the phantom.

### 7.1 HEAD LIQUID MEASUREMENT

Frequency MHz	Relative permittivity ( $\epsilon_r$ )		Conductivity ( $\sigma$ ) S/m	
	required	measured	required	measured
300	45.3 ±5 %		0.87 ±5 %	
450	43.5 ±5 %		0.87 ±5 %	
750	41.9 ±5 %		0.89 ±5 %	
835	41.5 ±5 %		0.90 ±5 %	
900	41.5 ±5 %		0.97 ±5 %	
1450	40.5 ±5 %		1.20 ±5 %	
1500	40.4 ±5 %		1.23 ±5 %	
1640	40.2 ±5 %		1.31 ±5 %	
1750	40.1 ±5 %		1.37 ±5 %	
1800	40.0 ±5 %		1.40 ±5 %	
1900	40.0 ±5 %	PASS	1.40 ±5 %	PASS
1950	40.0 ±5 %		1.40 ±5 %	
2000	40.0 ±5 %		1.40 ±5 %	

Page: 7/11

*This document shall not be reproduced, except in full or in part, without the written approval of SATIMO.  
The information contained herein is to be used only for the purpose for which it is submitted and is not to be released in whole or part without written approval of SATIMO.*



## SAR REFERENCE DIPOLE CALIBRATION REPORT

Ref: ACR.240.4.14.SATU.A

2100	39.8 ±5 %		1.49 ±5 %	
2300	39.5 ±5 %		1.67 ±5 %	
2450	39.2 ±5 %		1.80 ±5 %	
2600	39.0 ±5 %		1.96 ±5 %	
3000	38.5 ±5 %		2.40 ±5 %	
3500	37.9 ±5 %		2.91 ±5 %	

## 7.2 SAR MEASUREMENT RESULT WITH HEAD LIQUID

The IEEE Std. 1528 and CEI/IEC 62209 standards state that the system validation measurements should produce the SAR values shown below (for phantom thickness of 2 mm), within the uncertainty for the system validation. All SAR values are normalized to 1 W forward power. In bracket, the measured SAR is given with the used input power.

Software	OPENSAR V4
Phantom	SN 20/09 SAM71
Probe	SN 18/11 EPG122
Liquid	Head Liquid Values; eps' : 41.1 sigma : 1.42
Distance between dipole center and liquid	10.0 mm
Area scan resolution	dx=8mm/dy=8mm
Zoon Scan Resolution	dx=8mm/dy=8m/dz=5mm
Frequency	1900 MHz
Input power	20 dBm
Liquid Temperature	21 °C
Lab Temperature	21 °C
Lab Humidity	45 %

Frequency MHz	1 g SAR (W/kg/W)		10 g SAR (W/kg/W)	
	required	measured	required	measured
300	2.85		1.94	
450	4.58		3.06	
750	8.49		5.55	
835	9.56		6.22	
900	10.9		6.99	
1450	29		16	
1500	30.5		16.8	
1640	34.2		18.4	
1750	36.4		19.3	
1800	38.4		20.1	
1900	39.7	40.37 (4.04)	20.5	20.62 (2.06)
1950	40.5		20.9	
2000	41.1		21.1	
2100	43.6		21.9	
2300	48.7		23.3	

Page: 8/11

*This document shall not be reproduced, except in full or in part, without the written approval of SATIMO.  
The information contained herein is to be used only for the purpose for which it is submitted and is not to be released in whole or part without written approval of SATIMO.*





## SAR REFERENCE DIPOLE CALIBRATION REPORT

Ref: ACR240414.SATIM.A

2450	52.4		24	
2600	55.3		24.6	
3000	63.8		25.7	
3500	67.1		25	

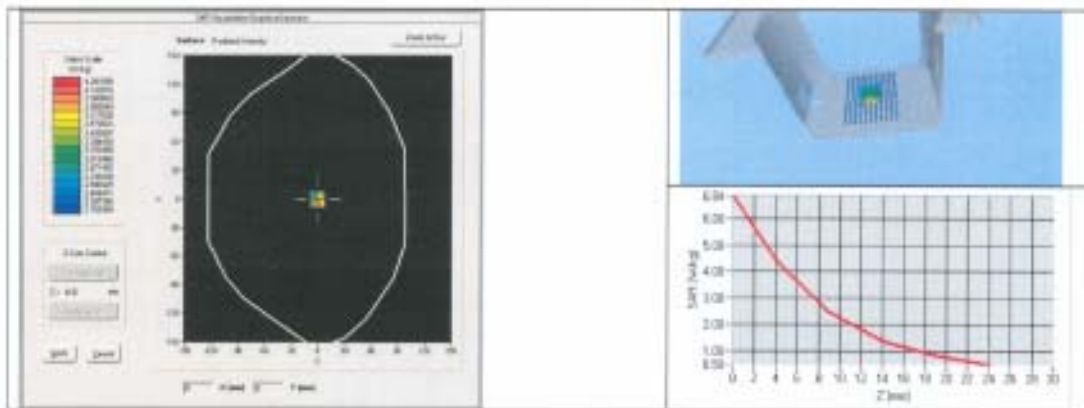

## 7.3 BODY LIQUID MEASUREMENT

Frequency MHz	Relative permittivity ( $\epsilon_r$ )		Conductivity ( $\sigma$ ) S/m	
	required	measured	required	measured
150	61.9 $\pm$ 5 %		0.80 $\pm$ 5 %	
300	58.2 $\pm$ 5 %		0.92 $\pm$ 5 %	
450	56.7 $\pm$ 5 %		0.94 $\pm$ 5 %	
750	55.5 $\pm$ 5 %		0.96 $\pm$ 5 %	
835	55.2 $\pm$ 5 %		0.97 $\pm$ 5 %	
900	55.0 $\pm$ 5 %		1.05 $\pm$ 5 %	
915	55.0 $\pm$ 5 %		1.06 $\pm$ 5 %	
1450	54.0 $\pm$ 5 %		1.30 $\pm$ 5 %	
1610	53.8 $\pm$ 5 %		1.40 $\pm$ 5 %	
1800	53.3 $\pm$ 5 %		1.52 $\pm$ 5 %	
1900	53.3 $\pm$ 5 %	PASS	1.52 $\pm$ 5 %	PASS
2000	53.3 $\pm$ 5 %		1.52 $\pm$ 5 %	
2100	53.2 $\pm$ 5 %		1.62 $\pm$ 5 %	
2450	52.7 $\pm$ 5 %		1.95 $\pm$ 5 %	
2600	52.5 $\pm$ 5 %		2.16 $\pm$ 5 %	
3000	52.0 $\pm$ 5 %		2.73 $\pm$ 5 %	
3500	51.3 $\pm$ 5 %		3.31 $\pm$ 5 %	
5200	49.0 $\pm$ 10 %		5.30 $\pm$ 10 %	
5300	48.9 $\pm$ 10 %		5.42 $\pm$ 10 %	
5400	48.7 $\pm$ 10 %		5.53 $\pm$ 10 %	

Page: 9/11

*This document shall not be reproduced, except in full or in part, without the written approval of SATIMO. The information contained herein is to be used only for the purpose for which it is submitted and is not to be released in whole or part without written approval of SATIMO.*



5500	48.6 ±10 %		5.65 ±10 %
5600	48.5 ±10 %		5.77 ±10 %
5800	48.2 ±10 %		6.00 ±10 %

7.4 SAR MEASUREMENT RESULT WITH BODY LIQUID

Software	OPENSAR V4
Phantom	SN 20/09 SAM71
Probe	SN 18/11 EPG122
Liquid	Body Liquid Values: eps' : 54.2 sigma : 1.54
Distance between dipole center and liquid	10.0 mm
Area scan resolution	dx=8mm/dy=8mm
Zoon Scan Resolution	dx=8mm/dy=8m/dz=5mm
Frequency	1900 MHz
Input power	20 dBm
Liquid Temperature	21 °C
Lab Temperature	21 °C
Lab Humidity	45 %

Frequency MHz	1 g SAR (W/kg/W)	10 g SAR (W/kg/W)
	measured	measured
1900	40.81 (4.08)	21.21 (2.12)

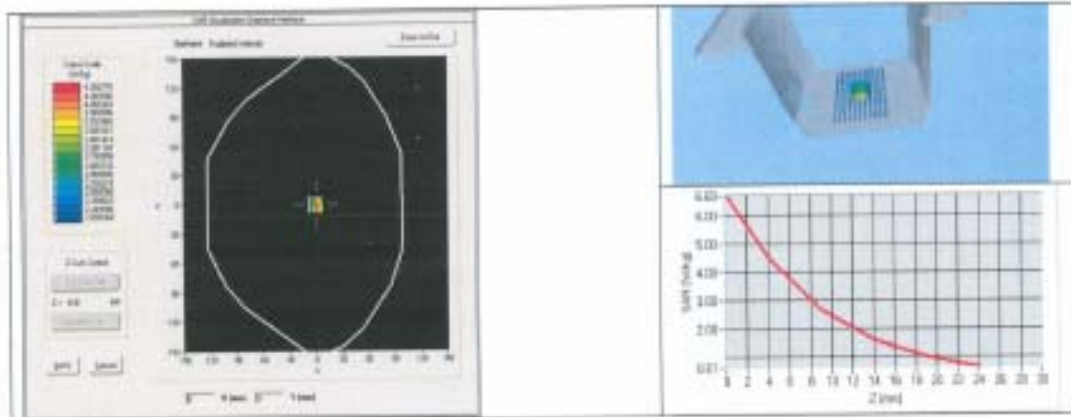



## 8 LIST OF EQUIPMENT

Equipment Summary Sheet				
Equipment Description	Manufacturer / Model	Identification No.	Current Calibration Date	Next Calibration Date
SAM Phantom	Satimo	SN-20/09-SAM71	Validated. No cal required.	Validated. No cal required.
COMOSAR Test Bench	Version 3	NA	Validated. No cal required.	Validated. No cal required.
Network Analyzer	Rhode & Schwarz ZVA	SN100132	02/2013	02/2016
Calipers	Carrera	CALIPER-01	12/2013	12/2016
Reference Probe	Satimo	EPG122 SN 18/11	10/2013	10/2014
Multimeter	Keithley 2000	1188656	12/2013	12/2016
Signal Generator	Agilent E4438C	MY49070581	12/2013	12/2016
Amplifier	Aethercomm	SN 046	Characterized prior to test. No cal required.	Characterized prior to test. No cal required.
Power Meter	HP E4418A	US38261498	12/2013	12/2016
Power Sensor	HP ECP-E26A	US37181460	12/2013	12/2016
Directional Coupler	Narda 4216-20	01386	Characterized prior to test. No cal required.	Characterized prior to test. No cal required.
Temperature and Humidity Sensor	Control Company	11-661-9	8/2012	8/2015

Page: 11/11

*This document shall not be reproduced, except in full or in part, without the written approval of SATIMO.  
The information contained herein is to be used only for the purpose for which it is submitted and is not to be released in whole or part without written approval of SATIMO.*

## SAR System Validation

Per FCC KDB 865664 D02v01, SAR system validation status should be documented to confirm measurement accuracy. The SAR systems (including SAR probes, system components and software versions) used for this device were validated against its performance specifications prior to the SAR measurements. Reference dipoles were used with the required tissue- equivalent media for system validation, according to the procedures outlined in FCC KDB 865664 D 01 v01 and IEEE 1528-2003. Since SAR probe calibrations are frequency dependent, each probe calibration point was validated at a frequency within the valid frequency range of the probe calibration point, using the system that normally operates with the probe for routine SAR measurements and according to the required tissue-equivalent media.

A tabulated summary of the system validation status including the validation date(s), measurement frequencies, SAR probes and tissue dielectric parameters has been included.

Freq. MHz	Date	probe	position	COND	PERM	CW validation			Mod validation		
				$\sigma$	$\epsilon$	Sensitivity	Probe linearity	Probe isotropy	Mod type	Duty factor	PAR
835	20140712	SN07/14 EPG211	Body	0.95	55.12	PASS	PASS	PASS	QPSK	PASS	N/A
1900	20140824	SN09/13 EP169	Body	1.52	53.28	PASS	PASS	PASS	QPSK	PASS	N/A

NOTE: While the probes have been calibrated for both CW and modulated signals, all measurements were performed using communication systems calibrated for CW signals only. Modulations in the table above represent test configurations for which the measurement system has been validated per FCC KDB publication 865664 D01v01 for scenarios when CW probe calibrations are used with other signal types. SAR systems were validated for modulated signals with a periodic duty cycle, such as GMSK, or with a high peak to average ratio (>5 dB), such as OFDM according to KDB 865664

————End of the Report————