

TURCK

Industrial
Automation

**USER-
MANUAL
RFID SYSTEM**

**INSTALLATION
OF THE
BL IDENT-
SYSTEM**



**BL
ident**

S1583/01

Safety Instructions!

Before beginning installation work

- Disconnect the device from the power supply
- Ensure against accidental restart
- Verify isolation from the supply
- Cover or close off neighbouring units that are live.
- The assembly instructions provided for the device are to be complied with
- Only suitably qualified personnel according to EN 50 110-1/-2 (VDE 0105 part 100) are authorised to carry out work on this device/system.
- When conducting installation work ensure that you are free of electrostatic charge before touching the device.
- Connection and signal cables are to be installed so that any inductive or capacitive interference does not impair the automation functions.
- The installation of automation devices and their operating elements is to be carried out in such a way as to prevent unintentional operation.
- In order to prevent cable or wire breakage on the signal side generating undefined states in the automation devices, appropriate safety measures are to be taken for the I/O coupling on the hardware and software side.
- The functional earth (FE) must be connected to the protective earth (PE) or the equipotential bonding. The system installer is responsible for establishing this connection.
- Ensure a reliable isolation of the extra-low voltage for the 24 volt supply. Only those power supply units that comply with IEC 60 364-4-41, i.e. HD 384.4.41 S2 (VDE 0100 part 410) are to be deployed.
- Fluctuations or deviations of the mains voltage from the nominal value should not exceed the tolerance limits specified in the technical data, otherwise malfunctions and dangerous states may occur.

- Devices for mounting in housings or cabinets, desktop or portable units, are only to be operated and controlled with the housing closed.
- Measures are to be taken to ensure the correct restarting of a program following interruption due to a voltage drop or failure. Dangerous operating conditions, even short term, should not occur as a result. If required an emergency stop should be carried out.
- External measures are to be implemented at those locations where faults in the automation installation could lead to injury to persons or damage to property. These measures must guarantee safe operating conditions even in the event of a fault or malfunction (e.g. by means of independent limit switches or mechanical locking devices etc.).
- The electrical installation must be carried out in accordance with the relevant regulations (e.g. in respect of the cable cross sections, fuses and protective earth connections).
- All work involving transport, installation, commissioning and maintenance is to be carried out exclusively by qualified personnel (in accordance with IEC 60 364 i.e. HD 384 or DIN VDE 0100 and national accident prevention regulations).
- USA Radio Frequency Interference FCC Part 15 Notice: Changes or modifications not expressly approved by TURCK could void the user's authority to operate the equipment

Contents

About this manual

Documentation concept.....	0 – 2
Description of symbols used	0 – 4
Prescribed use	0 – 5
Notes concerning planning / Installation of this product	0 – 5

1 The TURCK *BL ident* System – Overview

Schematic representation of the identification system <i>BL ident</i>	1 – 2
Support for <i>BL ident</i> -projects	1 – 2
Networking with <i>BL ident</i> systems.....	1 – 3
Identification systems with radio frequency technology (RFID).....	1 – 4
Characteristics and fields of application of the <i>BL ident</i> system.....	1 – 5
Degree of protection	1 – 5
Service life	1 – 5
Transmission frequency	1 – 5
Size.....	1 – 6
Read/write time	1 – 6
Compatibility	1 – 7
Areas of application (examples)	1 – 7
The <i>BL ident</i> -configurator	1 – 8

2 TURCK *BL ident* System – Planning

Selection criteria for data carriers and read-write head.....	2 – 2
Transfer zone and read-write distance	2 – 3
Length of the transfer zone and width offset	2 – 4
Minimum distance of the data carriers to read-write head, influence of adjacent fields	2 – 4
Permissible direction of movement of the data carrier	2 – 4
Reading and writing in static operation	2 – 4
Reading and writing in dynamic operation (on the fly).....	2 – 5
Dwell time of the data carrier T_d	2 – 5
Calculation of the maximum quantity of user data in dynamic operation.....	2 – 5
Minimum distances between two adjacent data carriers	2 – 6

Contents

3 Installation guidelines

Overview	3 – 2
Reduction of metallic influences	3 – 2
Installation of several read-write heads on metal frames or metal supports	3 – 3
No mounting of the data carrier directly on metal	3 – 5
Conclusion – influence on the transfer from metal	3 – 5

4 EMC directives

For whom are the EMC directives intended?	4 – 2
Dispersion of electromagnetic interference	4 – 2
How can RFID be subject to interference?	4 – 3
Coupled interference	4 – 3
What does EMC mean?	4 – 4
Fundamentals for EMC protection	4 – 5
Installation in a switch cabinet	4 – 6
Avoiding sources of interference	4 – 7
Potential equalization	4 – 7
Shielding the cable	4 – 7

5 Description of the data carrier

Type overview	5 – 2
Function principle	5 – 3
Technical data	
TW-R16-B64	5 – 5
TW-R16-B128	7 – 7
TW-R20-B128	9 – 9
TW-R30-B128	5 – 11
TW-R50-B128	5 – 13
TW-R20-K2	5 – 15
TW-R30-K2	5 – 17
TW-R50-K2	5 – 19
TW-R22-HT-B64	5 – 21

TW-R50-90-HT-B128 5 – 23
 TW-R50-90-HT-K2 5 – 25
 TW-I14-B128 5 – 27
 TW-L43-43-F-B128 5 – 29
 TW-L82-49-P-B128 5 – 31

6 Description of the read-write heads

Type overview 6 – 2
 Function principle 6 – 3
 Technical data
 TB-M18-H1147 6 – 6
 TB-M18-H1147/S1126 (optimised for special data carriers) 6 – 7
 TB-EM18WD-H1147 (wash-down) 6 – 8
 TB-EM18WD-H1147/S1126 (wash-down, optimised for special data carriers) 6 – 9
 TN-M18-H1147 6 – 10
 TN-M18-H1147/S1126 (optimised for special data carriers) 6 – 11
 TN-EM18WD-H1147 (wash-down) 6 – 12
 TN-EM18WD-H1147/S1126 (wash-down, optimised for special data carriers) 6 – 13
 TB-M30-H1147 6 – 14
 TB-M30-H1147/S1126 (optimised for special data carriers) 6 – 15
 TB-EM30WD-H1147 (wash-down) 6 – 16
 TB-EM30WD-H1147/S1126 (wash-down, optimised for special data carriers) 6 – 17
 TN-M30-H1147 6 – 18
 TN-M30-H1147/S1126 (optimised for special data carriers) 6 – 19
 TN-EM30WD-H1147 (wash-down) 6 – 20
 TN-EM30WD-H1147/S1126 (wash-down, optimised for special data carriers) 6 – 21
 TN-CK40-H1147 6 – 22
 TN-CK40-H1147/S1126 (optimised for special data carriers) 6 – 23

Contents

TN-Q80-H1147	6 – 24
TN-Q80-H1147/S1126 (optimised for special data carriers)	6 – 25
TNER-Q80-H1147 (increased range)	6 – 26
TNLR-Q80-H1147 (long range)	6 – 27
TNLR-Q80-H1147/S1126 (long range, optimised for special data carriers)	6 – 28
TN-S32XL-H1147	6 – 29
Connection of the read-write heads	6 – 30

7 Description of the read-write heads with corresponding data carriers

Notes for the operating data	7 – 5
TB-M18-H1147	7 – 3
TB-EM18WD-H1147	7 – 3
TB-M18-H1147/S1126	7 – 4
TB-EM18WD-H1147/S1126	7 – 4
TN-M18-H1147	7 – 5
TN-EM18WD-H1147	7 – 5
TN-M18-H1147/S1126	7 – 6
TN-EM18WD-H1147/S1126	7 – 6
TB-M30-H1147	7 – 7
TB-EM30WD-H1147	7 – 8
TB-M30-H1147/S1126	7 – 9
TB-EM30WD-H1147/S1126	7 – 10
TN-M30-H1147	7 – 11
TN-EM30WD-H1147	7 – 12
TN-M30-H1147/S1126	7 – 13
TN-EM30WD-H1147/S1126	7 – 14
TN-CK40-H1147	7 – 15
TN-CK40-H1147/S1126	7 – 16
TN-Q80-H1147	7 – 17
TN-Q80-H1147/S1126	7 – 18

TNER-Q80-H1147 7 – 19
 TNLR-Q80-H1147 7 – 20
 TNLR-Q80-H1147/S1126 7 – 21
 TN-S32XL-H1147 7 – 22

8 Overtravel distances of the read-write heads with corresponding data carriers

Notes for the overtravel distances 8 – 3
 Overtravel distance read-write head – housing style M18
 TN-M18-H1147 with data carrier TW-R16-... B128 8 – 4
 TB-M18-H1147 with data carrier TW-R16-... B128 8 – 4
 TN-M18-H1147 with data carrier TW-R20-... B128 8 – 5
 TB-M18-H1147 with data carrier TW-R20-... B128 8 – 5
 TN-M18-H1147 with data carrier TW-R30-... B128 8 – 6
 TB-M18-H1147 with data carrier TW-R30-... B128 8 – 6
 TN-M18-H1147 with data carrier TW-R50-... B128 8 – 7
 TN-M18-H1147 with data carrier TW-R20-... K2 8 – 7
 TB-M18-H1147 with data carrier TW-R20-... K2 8 – 8
 TN-M18-H1147 with data carrier TW-R30-... K2 8 – 8
 TN-M18-H1147 with data carrier TW-R50-... K2 8 – 9
 Overtravel distance read-write head – housing style M30
 TN-M30-H1147 with data carrier TW-R16-... B128 8 – 9
 TB-M30-H1147 with data carrier TW-R16-... B128 8 – 10
 TN-M30-H1147 with data carrier TW-R20-... B128 8 – 10
 TB-M30-H1147 with data carrier TW-R20-... B128 8 – 11
 TN-M30-H1147 with data carrier TW-R30-... B128 8 – 11
 TB-M30-H1147 with data carrier TW-R30-... B128 8 – 12
 TN-M30-H1147 with data carrier TW-R50-... B128 8 – 12
 TB-M30-H1147 with data carrier TW-R50-... B128 8 – 13
 TN-M30-H1147 with data carrier TW-R20-... K2 8 – 13
 TB-M30-H1147 with data carrier TW-R20-... K2 8 – 14
 TN-M30-H1147 with data carrier TW-R30-... K2 8 – 14

Contents

TB-M30-H1147 with data carrier TW-R30-...K2.....	8 – 15
TN-M30-H1147 with data carrier TW-R50-...K2	8 – 15
TB-M30-H1147 with data carrier TW-R50-...K2.....	8 – 16
Overtravel distance read-write head – housing style Q40	
TN-CK40-H1147 with data carrier TW-R16-...B128.....	8 – 16
TN-CK40-H1147 with data carrier TW-R20-...B128.....	8 – 17
TN-CK40-H1147 with data carrier TW-R30-...B128.....	8 – 17
TN-CK40-H1147 with data carrier TW-R50-...B128.....	8 – 18
TN-CK40-H1147 with data carrier TW-R20-...K2.....	8 – 18
TN-CK40-H1147 with data carrier TW-R30-...K2.....	8 – 19
TN-CK40-H1147 with data carrier TW-R50-...K2.....	8 – 19
Overtravel distance read-write head – housing style Q80	
TN-Q80-H1147 with data carrier TW-R16-...B128.....	8 – 20
TN-Q80-H1147 with data carrier TW-R20-...B128.....	8 – 20
TN-Q80-H1147 with data carrier TW-R30-...B128.....	8 – 21
TN-Q80-H1147 with data carrier TW-R50-...B128.....	8 – 21
TN-Q80-H1147 with data carrier TW-R20-...K2.....	8 – 22
TN-Q80-H1147 with data carrier TW-R30-...K2.....	8 – 22
TN-Q80-H1147 with data carrier TW-R50-...K2.....	8 – 23
Overtravel distance read-write head – housing style S32	
TN-S32XL-H1147 with data carrier TW-R16-...B128	8 – 23
TN-S32XL-H1147 with data carrier TW-R30-...B128	8 – 24
TN-S32XL-H1147 with data carrier TW-R50-...B128	8 – 24
TN-S32XL-H1147 with data carrier TW-R30-...K2	8 – 25
TN-S32XL-H1147 with data carrier TW-R50-...K2	8 – 25

9 Accessories

General description of the accessories.....	9 – 2
Accessories for Ø 30 mm and Ø 50 mm data carriers	
Spacer DS-R30	9 – 3
Spacer DS-R50.....	9 – 4

Accessories for read-write heads of housing style M18	
Mounting clip BS18.....	9 – 5
Mounting clip BSN18	9 – 6
Mounting clip with limit stop BST-18B	9 – 7
Mounting clip without limit stop BST-18N	9 – 8
Quick mounting mounts QM-18	9 – 9
Cover cap SKN/M18	9 – 10
Accessories for cylindrical read-write heads of housing style M30	
Mounting clip with limit stop BST-30B.	9 – 11
Mounting clip without limit stop BST-30N	9 – 12
Quick mounting mounts QM-30	9 – 13
Cover cap SKN/M30	9 – 14
Common accessories for read-write heads of housing style M18 and M30	
Mounting aid for BST mounting clips BST-UH	9 – 15
Mounting aid for BST mounting clips BST-UV	9 – 16
Inscription labels for BST mounting clips BST-BS	9 – 17
Accessories for read-write heads of housing style CK40	
Protective mounting MF-CK40-1S.....	9 – 18
Protective mounting MF-CK40-2S.....	9 – 19
Protective mounting MF-CK40-3S.....	9 – 20
Protective housing SG40	9 – 21
Protective housing SG40/2, temperature resistant.....	9 – 22
Adjustable rail JS 025/037	9 – 23
Cover cap T-CK40-T-FC.....	9 – 24
Cover capT-CK40-D-FC, temperature resistant	9 – 25
Handheld with accessories	
PD-ident	9 – 26
PD-ident-WLAN	9 – 27
PD-ident-PF	9 – 27
PD-ident-DS.....	9 – 27

Contents

PD-ident-RB.....	9 – 28
PD-ident-BC.....	9 – 28
PD-ident-RS.....	9 – 28
PD-ident-CB.....	9 – 28

About this manual

Documentation concept.....	2
Description of symbols used	4
Prescribed use	5
Notes concerning planning / Installation of this product	5

Documentation concept

This manual contains all the information necessary for professional installation of the *BL ident* systems particularly with regard to the data carriers and the read-write heads.

The following chapter provides an overview of the *BL ident* system, how to plan a *BL ident* system and indicates the necessary installation guidelines while providing a brief overview of the EMC directives. The manual also describes the functional principle of the data carriers and read-write heads, the technical data and operating data as well as the available accessories.

The manuals for BL67 and BL20 I/O modules contain information concerning the non bus-specific I/O modules of the modular TURCK BL67 and BL20 systems. You can find a short system description, a detailed function description of the I/O modules as well as all the information concerning topics such as mounting/dismounting and inscription. The manuals contain a short description of the I/O-ASSISTANT which is the engineering and configuration software for TURCK I/O products.

- Manual BL67 I/O Modules
TURCK documentation number:
German D300572/
English D300529
- Manual BL20 I/O Modules
TURCK documentation number:
German D300716/
English D300717

Also included are manuals concerning the PROFIBUS-DP and DeviceNet™ gateway of the BL67 and BL20 series. These include a short BL67 or BL20 system description and a description of the PROFIBUS-DP or DeviceNet™ fieldbus systems. Besides you will find exact details concerning the function and design of bus-specific gateways as well as all bus-specific information concerning the connection to different automation devices, the maximum system extension, etc.

- Manual BL67 PROFIBUS-DP
TURCK documentation number:
German D300570/
English D300527

- Manual BL67 DeviceNet™
TURCK documentation number:
English D300528
- Manual BL20 PROFIBUS-DP
TURCK documentation number:
German D300822/
English D300458
- Manual BL20 DeviceNet™
TURCK documentation number:
English D300460.

Further support can be found in the following manuals for engineering, installation and commissioning:

- Manual D101580 - This manual describes the professional application of *BL ident* interface modules.
- Manual D101578 - This manual includes instructions for commissioning of a *BL ident* systems using the function block “Proxy Ident Function Block”. The commissioning example is undertaken using a SIMATIC S7/-300 station (Siemens). SIMATIC STEP 7 standard software is used.
- Manual D101606 - This manual contains the software description for the so-called “Handheld” (programming device) which can be used to read data irrespective of the location.
- Manual D101584 - This manual contains the hardware description for the so-called “Handheld” (programming device) which can be used to read data irrespective of the location.

Description of symbols used



Warning

This sign can be found next to all notes that indicate a source of hazards. This can refer to danger to personnel or damage to the system (hardware and software).

This sign means for the operator: work with extreme caution.



Attention

This sign can be found next to all notes that indicate a source of potential hazards.

This can refer to possible danger to personnel or damage to the systems (hardware and software) and installations.



Note

This sign can be found next to all general notes that supply important information about one or more operating stages.

These specific notes are intended to make operation easier and avoid unnecessary work due to incorrect operation.



Attention

Please read this section carefully. Safety aspects cannot be left to chance when dealing with electrical equipment

This manual contains all the necessary information concerning the intended usage of TURCK products. It has been specially developed for qualified personnel who have the required level of expertise.

Prescribed use



Warning

The devices described in this manual must be used only in applications prescribed in this manual or in the respective technical descriptions, and only in connection with components and devices from third party manufacturers that have been certified.

Appropriate transport, storage deployment and mounting as well as careful operating and thorough maintenance guarantee trouble-free and safe operation of these devices.

Notes concerning planning / Installation of this product



Warning

It is imperative that all respective safety measures and accident protection guidelines be adhered to.

About this manual



1 The TURCK *BL ident* system

- Schematic representation of the identification system *BL ident*2
 - Support for *BL ident* projects2
 - Networking with *BL ident* systems3
- Identification systems with radio frequency technology (RFID)4
- Characteristics and fields of application of the *BL ident* system5
 - Degree of protection5
 - Service life5
 - Transmission frequency5
 - Size6
 - Read/write time6
 - Compatibility7
 - Areas of application (examples):7
- The *BL ident* configurator8

The TURCK *BL ident* System

Schematic representation of the identification system *BL ident*

The TURCK *BL ident* system consists of several levels. Every level offers variation options. An application adapted to the overall system is possible.

Figure: 1
System overview

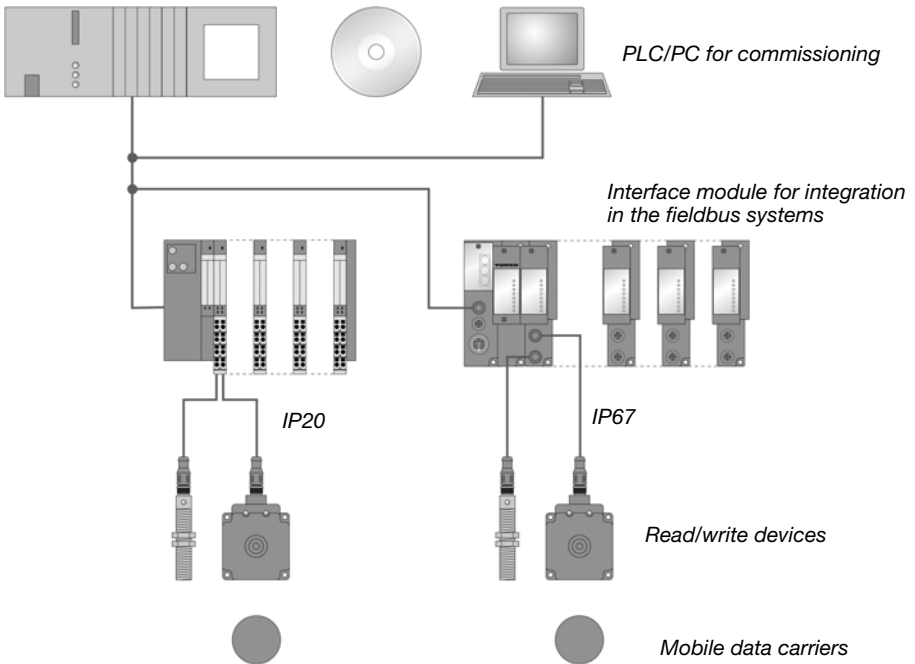

Support for *BL ident* projects

Further support can be found in the following software for engineering, installation and commissioning:

- For simulation and optimisation of an application a “*BL ident* configurator” is available free of charge on the internet at www.turck.com (see page 1 - 8).

Networking with *BL ident* systems

As it is possible to integrate *BL ident* systems in (existing) bus systems, networking of several *BL ident* systems is possible.

The guidelines which relate to the maximum extension of the respective bus systems apply.

A PROFIBUS system can only extend, for example, up to a maximum of 31 stations with 1 master when a repeater is not used.

Identification systems with radio frequency technology (RFID)

RFID is the abbreviation for Radio Frequency Identification.

An RFID system consists of a data carrier, a device for reading the data from the data carrier (read-write head) as well as other devices which perform the transfer and processing of data (interfaces).

The transfer of data from the data carrier to the read-write heads is undertaken using electromagnetic waves. This type of data transfer is non-contact, without a visual contact and is insensitive to dirt and temperature fluctuations.

The data carriers can be attached directly to a product. Further terms used for the data carriers are TAGs or transponders. The data content can consist of production and manufacturing data. Important it that this data identifies the product. This is the origination of the term "Identification System".

A whole range of possibilities exist as the data content can be changed by writing on the data carrier. Accordingly, the production and manufacturing processes can be traced and monitored. Logistics/distribution can be optimized.

The "Identifications Systems" can be integrated into (existing) fieldbus systems (e.g. PROFIBUS). The integration of the respective fieldbus system is undertaken with suitable interfaces.

Standardized software modules (e.g. the Proxy Ident Function Block for PROFIBUS) enable simple system integration and commissioning with different controls.

Characteristics and fields of application of the *BL ident* system

In order to comply with the demands presented by different fields of application, TURCK offers the *BL ident* system with a whole range of combination possibilities of data carriers and read-write heads as well as interfaces for integration into fieldbus systems (e.g. PROFIBUS-DP). Software modules enable simple integration and commissioning.

The characteristics of the TURCK *BL ident* system are listed in the following:

Degree of protection

All data carriers as well as the suitable write-read heads feature a high mechanical degree of protection (e.g. **IP67**) and can thus be subject to the most harsh industrial conditions.

The integration into a fieldbus system is implemented with suitable TURCK interface modules. The interface modules are available in degrees of protection IP20 and IP67. TURCK connection cables featuring an adequate degree of protection round off the identification system.

Service life

The service life results from the possible number of read-write operations on the data memory.

FRAM memory features an **unlimited** number of read operations and 10^{10} write operations.

EEPROM memory features an **unlimited** number of read operations and 10^5 write operations.

The data carrier does not require batteries.

Transmission frequency

The TURCK *BL ident* system operates with **13.56 MHz** transmission frequency between the data memories and the read/write devices. Systems which operate with these transmission frequencies are practically immune to electromagnetic interference. The 13.56 MHz transmission frequency has developed into a standard in many RFID fields of application.

Size

TURCK supplies the data carriers with diameters of 16, 20, 30 and 50 mm.

The read-write units are available in different housing styles ranging from cylindrical M18 and M30, to rectangular CK40 and Q80 and ring-shaped S32XL.

Memory capacity

The memory capacity on the data storage device is **64 Bytes** or **128 Bytes** with an EEPROM memory and **2 KBytes** with an FRAM memory. New data carriers are in the design stage.

FRAM: (Ferroelectric Random Access Memory), non-volatile, high service life based on the higher number of write-read operations (10^{10} up to 10^{11})

EEPROM: (Electrically Erasable Programmable Read Only Memory), non-volatile

Write time/read time (air interface only)

The write and read times depend for all data carriers on the number of bytes which are to be transferred. On FRAM data carriers the read and write time are almost identical and are between 0.7 and 3.4 ms/byte. On EEPROM data carriers the read time is between 0.7 and 6 ms/byte and the write time is between 3.3 and 7.9 ms/byte.

The write-read distances depend on the corresponding combination of data carrier and read-write head, and can be between 0 and 200 mm. With the *BL ident* configurator the application variables speed, range and data quantity can be varied and the optimum combination can be selected for the respective application. The configurator is available online at <http://www.turck.com/> (also see page 1 - 8).

Compatibility

All technical data relates to the *BL ident* system, i.e. to the combinations of *BL ident* data carriers, read-write heads and interface modules. Completely different values may apply for data carriers from other manufacturers. Therefore they may only be used after prior approval by TURCK.

Areas of application (examples):

The characteristics as stated beforehand allow the application of a TURCK *BL ident* system in the following fields:

- Automotive
- Transport and handling
- Machine (mechanical) engineering
- Food and beverages
- Chemicals
- Pharmaceuticals and petrochemicals.

Possible areas of application are:

- Assembly lines
- Conveyors
- Industrial manufacturing
- Warehousing
- Logistics
- Distribution
- Component picking
- Transport logistics

The *BL ident* configurator

The use of sensors and actuators – and even fieldbuses – is state-of-the-art in many industrial fields. When RFID systems are used on the other hand, there are always questions relating to the air-interface, e.g. "How fast and at which distance can I move the data carrier past the write-read heads?". That is to say that there is a certain amount of general uncertainty concerning the range of applications of an RFID system.

General details such as "recommended write-read distance" or "transmission speed = 0.5 ms/ byte" are usually not sufficient for evaluation of the usage of the devices in a determined application, as the application variables such as data quantity, speed and distance are the result of a complex interaction between the read-write heads and data carriers.

With the "*BL ident* configurator" the respective application can be simulated and the correct preliminary selection can be made.

The setting of applications parameters by "playing" with the values allows the user to easily test the options and limits associated with the respective combinations.

Figure: 2
BL ident
configurator

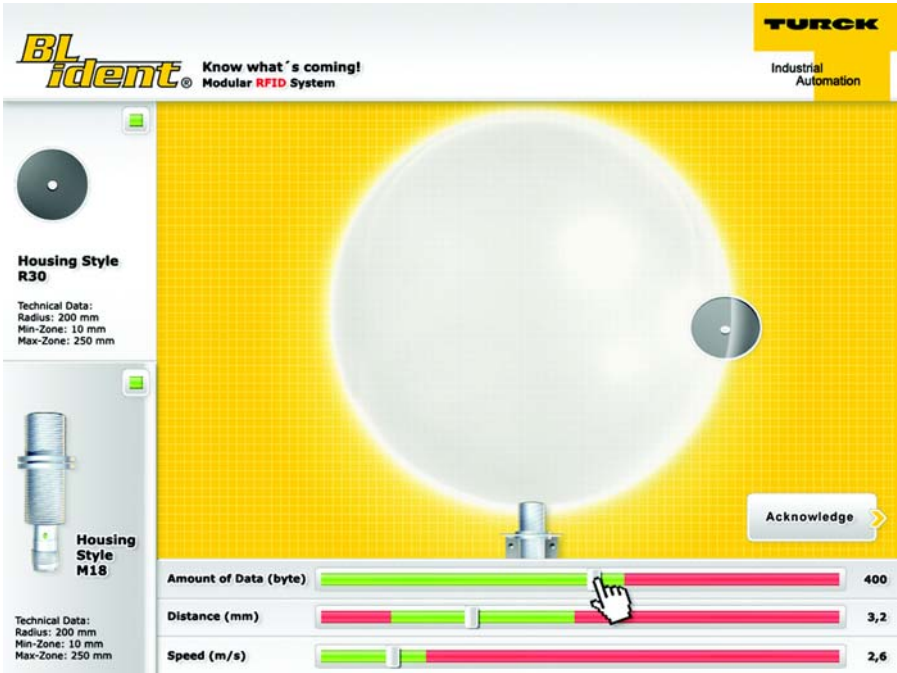

The online variants of the configurator (available free on the Internet at www.turck.com) accesses the data in the TURCK product database and always provides the most up-to-date information.. In addition to simulating the application, the configurator also generates the corresponding data sheets and documentation.



2 TURCK-BL ident System – Planning

- Selection criteria for data carriers, read-write head and interface module.....2
- Transfer zone and read-write distance3
- Length of the transfer zone and width offset4
- Minimum distance of the data carriers to read-write head, influence of adjacent fields.....4
- Permissible direction of movement and alignment of the data carrier4
- Reading and writing in static operation4
- Reading and writing in dynamic operation (on the fly).....5
- Dwell time of the data carrier T_d 5
- Calculation of the maximum quantity of user data in dynamic operation5
- Minimum distances between two adjacent data carriers6

Selection criteria for data carriers, read-write head and interface module

The application should be judged using the following criteria in order to make the correct selection of *BL ident* system components:

- Mechanical dimensions
- Distance from data carriers to read-write heads when reading and writing
- Tolerances in the mechanical guidance
- Static and/or dynamic transfer of data
- Data quantities to be transferred
- Speed with dynamic writing and reading (on the fly)
- Metal-free areas with data carriers and read-write heads
- Ambient conditions such as humidity, temperature, chemical influences, etc.

There are special selection criteria relating to read-write heads:

- Mechanical dimensions
- Required transfer zone
- Size of the data carrier in use

The following criteria should be considered specially for the use of the interface modules:

- Degree of protection
- Bus type
- Number of channels

Transfer zone and read-write distance

The read-write head generates an alternating inductive field. The recommended read-write distance results from the combination of data carrier and read-write head. The appearance of the distribution of this field depends on the design of the antenna in the data carrier and in the read-write head.

Figure 1
Transfer zone

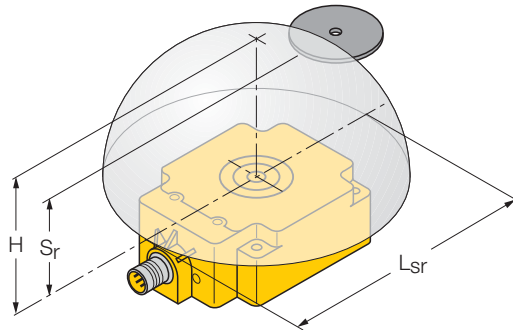

Exchange of data is only possible within the transfer zone (Fig. 1) with the parameters L_{sr} = length of the transfer zone and S_r = recommended write-read distance. The transfer zone reduces when the distance from the data carrier to the read-write head increases and is reduced to a point at the threshold distance H , i.e. as the distance increases less data can be transferred or the speed at which the read-write head moves past the data carrier must be reduced.



Note

Using the *BL ident* configurator at www.turck.com allows the relationships to be simulated.

Length of the transfer zone L_{Sr} and width offset

The length of the transfer zone L_{Sr} (Fig. 1) is dependent on the combination of data carrier and read-write head.

The width is particularly important for the tolerance of mechanical tracking.



Note

An illustrative representation of this relationship can be found in the *BL ident* configurator at www.turck.com.

Minimum distance of the data carriers to read-write head, influence of adjacent fields

Adjacent fields are practically always available. Normally the adjacent fields should not be used for transfer of data, so there must be an minimum distance between data carriers and read-write head. But with the TURCK *BL ident* system a minimum distance must not be observed.

Permissible direction of movement and alignment of the data carrier

The data carrier can pass over the read-write head from any direction.

The data carriers can have any horizontal alignment. They should only be aligned in parallel to the read-write head.

Reading and writing in static operation

In static operation a data exchange is possible up to the range of the threshold distance H . The data carrier must be positioned exactly above the read-write head.

Reading and writing in dynamic operation (on the fly)

In dynamic operation the data carriers move past the read-write head. A data exchange is only possible within the transfer zone.

Dwell time of the data carrier T_d

The dwell time T_d is the time in which the data carrier is present in the transfer zone of the read-write head as it passes by. The read-write head exchanges data with the data carrier during this time.

The dwell time T_d is calculated as follows:

$$T_d = L_{Sr} / V_{Tag}$$

where:

L_{Sr} :length of the transfer zone

V_{Tag} :speed of the data carrier in dynamic operation

In static mode the dwell time can be as long as necessary. The dwell time must be long enough to ensure that communication with the data carrier has been completed.

In dynamic operation the dwell time is defined by the system environment. The dwell time must be matched to the data quantity to be transferred. Conversely, this means that the shorter the dwell time, the lower the quantity of data to be transferred.



Note

At www.turck.com various examples relating to this topic can be examined with the *BL ident* configurator.

Calculation of the maximum quantity of user data in dynamic operation

The calculation of the maximum user data quantity is dependent on the read-write head used and the corresponding data carrier.

Example:

Read-write head: TB-M18-H1147,

Data carrier: TW-R30-K2

Pass speed: 0.5 m/s

- The read-write head contacts the data carrier when it is entering the transfer zone: This takes about 2.7 ms.
- With the second contact to the data carrier the read-write head recognizes the data carrier. A signal is sent to the interface module: Duration about 12 ms.
- The interface module sends a read-write command, e.g. read 4 bytes, incl. version and feedback of the data on the interface module: Duration about 7 ms.

This results in total to about 22 ms.

Until 4 bytes of data have been processed by the interface module takes about 5 ms/byte.

This means when the data carrier passes the read-write head, a max. of 8 bytes can be read or written.



Note

With the BL ident configurator at www.turck.com different operating states in dynamic operation can be simulated and represented.

Minimum distances between two adjacent data carriers

The minimum distance between two data carriers is dependent on the size of the data carrier and the read-write head.

In dynamic operation (on the fly) the minimum distance is still dependent on the data quantity and the bus cycle time.



Note

Corresponding tests for determination of the minimum distance should be undertaken before commissioning.

3 Installation guidelines

Overview	2
Reduction of metallic influences	2
Installation of several read-write heads on metal frames or metal supports	3
No mounting of the data carrier directly on metal	6
Conclusion – influence on the transfer from metal	7

Installation guidelines

Overview

Because of the inductive operating principle of the data carriers and read-write heads, every type of metal (particularly iron and ferromagnetic materials) should be avoided in proximity of these devices, as they will influence the manner in which they function.

It is necessary to observe the following important points during engineering and installation:

- Minimum distance between read-write heads
- Minimum distance between two adjacent data carriers (see chapter 2, page 2 - 6)
- Metal-free areas with installation of read-write heads and data carriers on metals
- Installation of several read-write heads on metal frames or metal supports.

Reduction of metallic influences

Problem: A metal support is located above the transfer zone of the read-write head. This influences the entire field. Specifically, the transfer zone between read-write head and data carrier is reduced (Fig. 1).

*Figure 1
Interfering metal
supports.*

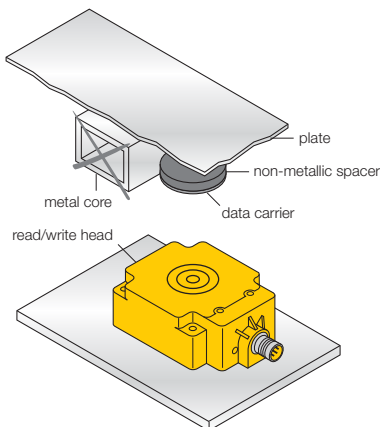

Remedy: Install the data carriers in a different manner and there will no longer be an influence on the transfer zone (Fig. 2).

Figure 2
Other
arrangement of
the data carrier

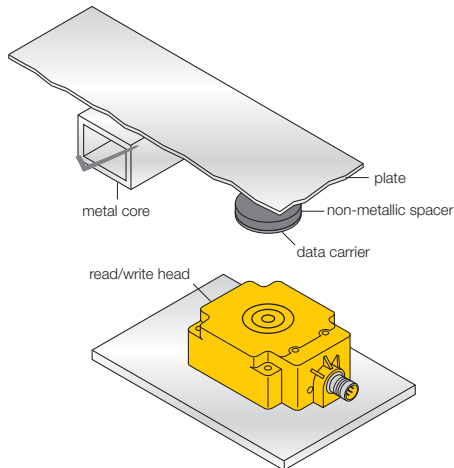

Installation of several read-write heads on metal frames or metal supports

Every read-write head which is mounted on metal couples a part of the field to the metal support. If the minimum distance d and the metal-free zones are observed, there is generally no mutual influence. If however a metal frame should have an unfavourable form an influence is still possible. This results in longer data transfer times and error messages in the interface module.

Problem: Mutual interference of the read-write heads

Installation guidelines

Remedy 1: Extend the distance d between both read-write heads (Fig. 3).

Figure 3
Extending the
distance

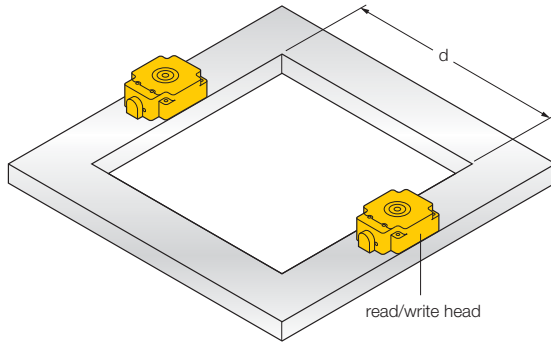

Remedy 2: Fit one or several iron struts which should short-circuit the parasitic fields (Fig. 4).

Figure 4
Fitting iron struts

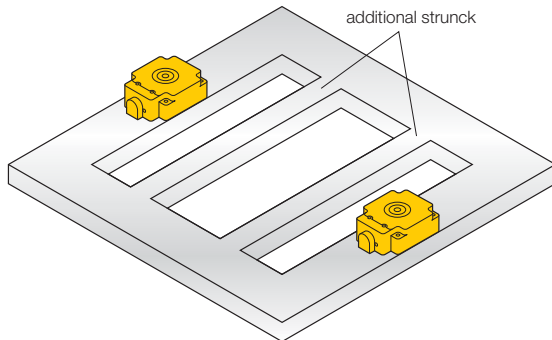

Remedy 3: Place a non-metallic intermediary element of 20 to 40 mm thickness between the read-write head and the iron frame. This will significantly reduce the parasitic coupling of the field and the support (Fig. 5).

Figure 5
Addition of an
intermediary non-
metallic element

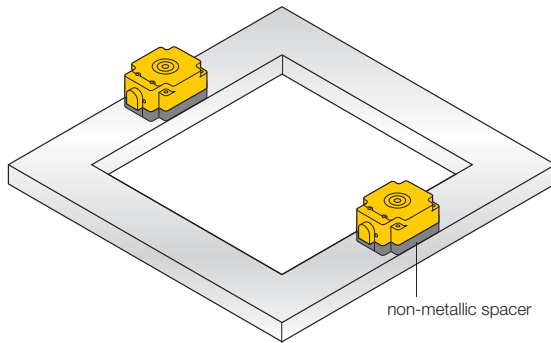

Remedy 4: It is also possible to contact the read-write heads via the function block (PLC) and to use it to switch them on and off. The influence through another read-write head can be avoided using the selective mode, where the channel in whose transfer window the data is located is active (see manual *BL ident Proxy-Ident-Block (PIB)*, D101578). Using this method the adjacent read-write heads do not emit a field and there is no mutual interference.

Installation guidelines

No mounting of the data carrier directly on metal

The data carriers (with the exception of high temperature data carriers) may not be mounted directly on metal. Non-metallic spacers (see chapter 9, Accessories) enable mounting which does not lead to an interruption of the functions (Fig. 6).

*Figure 6
Installation with
spacers*

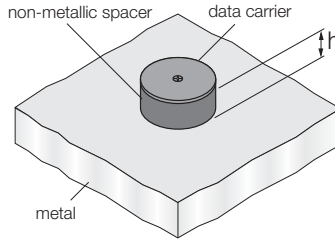

The data carriers may not be mounted so that the necessary minimum distance to metal and to the data carriers around them is less than the minimum distance. The minimum distance is dependent on the housing design of the read-write head; $a = 10$ mm around the data carrier can be assumed (Fig. 7). The high temperature data carrier (see page 5 - 2, table 1) can be constructed so that it can be mounted directly on metal without the need for additional measures.

*Figure 7
Installation
considering the
minimum distance
from metal*

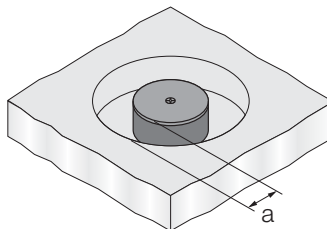

Conclusion – influence on the transfer from metal

The following points should be considered with the installation of the *BL ident* components:

- Data carriers (except high temperature data carriers) can not be mounted directly on metal or suitable accessories must be used (spacers)
- It is important to ensure that no metallic rails (or similar parts) intersect the transfer zone. The metal rails would interfere with the field data.
- Only plastic or stainless steel screws can be used for attachment of the read-write heads.

Installation guidelines



4 EMC directives

For whom are the EMC directives intended?.....	2
Dispersion of electromagnetic interference	2
How can RFID be subject to interference?	3
Coupled interference	3
What does EMC mean?	4
Fundamentals for EMC protection	5
Installation in a switch cabinet	6
Avoiding sources of interference.....	7
Potential equalization	7
Shielding the cable.....	7

For whom are the EMC directives intended?

These EMC directives are intended for:

- Project engineers and planners who are planning the system with the RFID modules to be configured.
- Installation personnel, service technicians and engineers, who use this description to correctly lay the connection cables or have to remedy the existing problems during a malfunction.

In this chapter you will learn more about the EMC guidelines, particularly:

- Dispersion of electromagnetic interference
- What does EMC mean?
- Fundamentals for EMC protection
- Installation in a switch cabinet
- Avoiding sources of interference
- Potential equalisation
- Shielding the cable

Dispersion of electromagnetic interference

In a system or installation electromagnetic interference can only occur if the following components are mutually present:

- Source of interference
- Interference path
- Susceptible equipment.

If one of these components is not present (for example the interference path), no interference will occur even if the source of interference sends high levels of interference (Fig. 1):

Figure 1
Interference
components

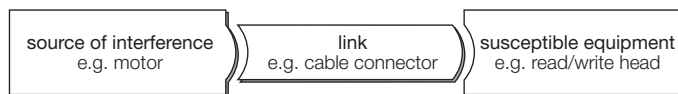

The measures for prevention of the interference (EMC) are relevant for all three components. The manufacturer is obliged to undertake all possible measures to counter the development of sources of interference.

The installation design must be implemented to ensure that mutual interference of the individual components is avoided or kept to as low a level as possible.

How can RFID be subject to interference?

- Problem: interference radiation from the power supply when switching mode power supplies are used.
Remedy: use of a stabilized power supply
- Problem: interference via the serial connection cable.
Remedy: improved cable shielding and/or read-write head earthing
- HF interference via the antenna from another read-write head or via an external source of interference which operates using the same frequency.
Remedy: the interference from another read-write head can be avoided by using the selective mode (see manual *BL ident Proxy-Ident-Block (PIB)*, D101578).

Coupled interference

There are four possibilities for coupled interference:

- Galvanic coupled interference
- Capacitive coupled interference
- Inductive coupled interference
- Radiated interference

There are different causes for the radiated interference on the data interface paths:

With cables and wiring:

- Incorrect or poorly laid
- Missing or incorrectly connected shield
- Unfavourable arrangement of the cable

With the switch cabinet or housing:

- Missing or incorrectly wired potential equalization wiring
- Missing or incorrect earthing
- Unfavourable arrangement
- Modules which are not mounted in a fixed position
- Unfavourable switch cabinet design.

What does EMC mean?

The increasing component density, increased switching speed of power electronics and the continuous rise in switching speeds present more and more sources of interference to electronic elements of a system. The following generally applies: the higher the level of automation, the higher the danger of mutual interference.

Definition of EMC:

“Electromagnetic compatibility (EMC) is the capability of an electrical or electronic device in an electromagnetic environment to function without fault, without influencing or interfering with the environment beyond defined limits.”

The TURCK *BL ident* devices are subjected to test compliance to the following standards:

- EN 61000-4-2 (ESD)
- EN 61000-4-3 (Electromagnetic fields)
- EN 61000-4-4 (Burst)
- EN 61000-4-5 (Surge)
- EN 61000-4-6 (immunity to conducted disturbances induced by radio-frequency fields)

As the RFID modules are only components of an overall system and sources of interferences can result from the combination of different components, the design of a system or installation must be subject to certain guidelines.

In order to obtain an installation which is immune to interference, a whole package of measures must be implemented; where the operator of the system or installation is responsible for the RFI suppression. They must observe and comply with the local and national stipulations and directives. All measures, which have been

undertaken during system design save expensive modifications and elimination of interference at a later date.

Fundamentals for EMC protection

The following elementary rules relating to electromagnetic compatibility (EMC) must be observed:

4

■ Shielding by a housing

Protect the device from external sources of interference by the installation in a switch cabinet or housing. The cabinet or the housing must be included in the connection to earth.

Shield the electromagnetic fields from inductances by partition panels of devices. Use shielded data transmission cables with metallic connector housings.

■ Large area ground connections

Connect all inductive metal parts over a large area and use a low resistance for radio frequencies. Establish a large area connection between the inactive metal parts and the central earthing point.

Integrate the shield earth into the earthing concept, i.e. the end of the shield must be connected to a large area to earth.

■ Planning of the cable routes

Divide the cables into power groups and lay them separately.

Lay the high power cables and the data cables in separate ducts or bundles.

Introduce the entire cabling into the cabinet only from one side and on a single level when possible.

Lay the data cables as close to earthed surfaces as possible.

Twist the incoming and outgoing cables of individually laid conductor pairs.

In many cases an independent cable guidance for the bus cable is already provided. Ideally this should also be used for laying the data cables between read-write heads and interface modules.

■ Shielding of cables

Shield the data transfer cables and apply the shield on gateway side. Shield the analogue cables and apply the shield at one end, e.g. on the drive unit.

Always apply the cable shields at the entry to the switch cabinet to a large area on the grounding bar and attach them with fixing clamps.

Connect the applied shield to the module without interruption.
Use a braided shield and not a metal foil shield.

■ **Mains and signal filter**

Use the mains filter with metal housing.

Connect the filter housing on a wide area and with a low radio frequency resistance to the switch cabinet earth.

Never attach the filter housing to painted surfaces.

Attach the filter at the switch cabinet entry or in the direction of the interference source.

Installation in a switch cabinet

Metal housings shield susceptible equipment against magnetic and electrical fields as well as electromagnetic waves. The better that the induced interference current can flow, the better that the interference field will weaken itself. It is therefore essential to ensure that all housing panels are connected electrically conducting to each other.

If the switch cabinet panels are insulated from one another, an RF conductive connection using metal braiding and RF clips or RF paste (the greater the surface area of the connection the better) must be possible.

Interference can be avoided by optimum switch cabinet design. The following generally applies:

- The effects of the interference generally reduce as the distance between the susceptible equipment and the source of interference increases.
- An additional reduction in interference can be achieved by installation of shield panels
- Signal cables should keep a minimum distance of at least 10 cm from high power cables.

External interference induced through the mains is avoided by the installation of mains filters. Ensure that the mains filter is correctly rated and fitted directly at the entry to the switch cabinet.

Avoiding sources of interference

Avoid the installation of sources of interference which occur primarily due to switched inductances.

Interference is generated primarily by relays, contactors, fluorescent lamps in the switch cabinet and valves, and can be avoided by the use of RC combinations, freewheel diodes etc. This also avoids inductive interference in the cables which are laid parallel to the coil cables.

Potential equalisation

If the system sections are subject to a different design and different voltage levels result, potential differences can result between the different sections of the system. Equalization currents then flow via signal cables (potential equalization should not be confused with a protective earth).

Therefore correctly implemented potential equalization is essential. The following points should be observed:

- The potential equalization cable must have a sufficient cross-section (min. 10 mm²).
- The distance between signal cables and the respective potential equalization cable must be as small as possible.
- A stranded conductor must be used.
- If the potential equalization cables are connected to the central potential equalization bars, the power components and the non-power components must be combined.

Shielding the cable

Signal cables must be shielded in order to avoid coupled interference. Even though the best shielding effect when laying the cables is achieved by using steel ducts, the use of cables with braided shields is usually sufficient. Decisive for the effect of the shield in both cases is however the correct connection, as a non-connected or incorrectly connected shield has no effect.

The following must be observed:

- As the interference signals are frequently in a range > 10 kHz, a large area shield connection is necessary.
- The shield bar is very conductive and connected over a large area with the switch cabinet housing and must be as near as possible to the cable entry. The cable must be stripped and connected to the grounding bar with an RF clip or cable tie.
- The shielding bar must be connected with the PE bar.
- If shielded cables have to be interrupted, the shield must continue via the corresponding connector housing using suitable connectors.
- If intermediate connectors are used which do not feature a suitable shield, the shield must be connected via cable clips to the point where it is interrupted.

5 Description of the data carrier

Type overview	2
Function principle.....	3
Memory module	3
Data carrier electronics	4
Data carrier antenna	4
Technical data	
TW-R16-B64	5
TW-R16-B128	7
TW-R20-B128	9
TW-R30-B128	11
TW-R50-B128	13
TW-R20-K2.....	15
TW-R30-K2.....	17
TW-R50-K2.....	19
TW-R22-HT-B64	21
TW-R50-90-HT-B128	23
TW-R50-90-HT-K2	25
TW-I14-B128	27
TW-L43-43-F-B128	29
TW-L82-49-P-B128	31

Description of the data carrier

Type overview

Table 1:
Data carrier type
overview

Type	Memory size	Memory type	Highly temperature resistant
TW-R16-B64	64 Byte	EEPROM	–
TW-R16-B128	128 Byte	EEPROM	–
TW-R20-B128	128 Byte	EEPROM	–
TW-R30-B128	128 Byte	EEPROM	–
TW-R50-B128	128 Byte	EEPROM	–
TW-R20-K2	2 kByte	FRAM	–
TW-R30-K2	2 kByte	FRAM	–
TW-R50-K2	2 kByte	FRAM	–
TW-R22-HT-B64	64 Byte	EEPROM	✓
TW-R50-90-HT-B128	128 Byte	EEPROM	✓
TW-R50-90-HT-K2	2 kByte	FRAM	✓
TW-I14-B128	128 Byte	EEPROM	–
TW-L43-43-F-B128	128 Byte	EEPROM	–
TW-L82-49-P-B128	128 Byte	EEPROM	–

Function principle

The *BLident* data carriers (TAGs) can be written and read on a non-contact basis using the corresponding read-write heads. The operating frequency is 13.56 MHz.

The data carriers are passive, i.e. without batteries. If the data carriers enter the transfer range of a read-write head, the energy is inductively coupled and the data transfer is initiated.

The achievable distances vary depending on the sizes from 15...200 mm. All housing styles (with the exception of the TW-R16...-B128, EEPROM only) are available both as EEPROM and FRAM memory variants. The *BLident* data carrier consists of a memory module, electronics and an antenna (see Fig. 1).

Figure 1
Block diagram
Data carrier

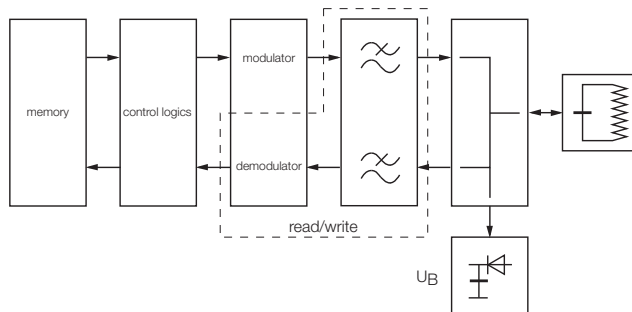

Memory module

The information on the data carrier can be read – and new data can also be added (read/write). The memory size is 64 Bytes, 128 Bytes or 2 KBytes.

The memory consists alternatively of the following components:

- EEPROM: unlimited read but limited write cycles are possible (10^5). No battery required.
- FRAM = ferroelectric memory: unlimited read and almost unlimited write cycles are possible (10^{10}). No battery required.

Description of the data carrier

The data retention time of the memory is:

- 1 year at 85 °C,
- 10 years at 55 °C,
- 120 years at 25 °C.

Electrical fields do not have an influence as they are normally have a frequency which is much too low to erase the memory.

Data carrier electronics

The electronics ensure the communication on the data carrier side with the read-write head.

Data carrier antenna

The antenna is designed as an air coil and is used to transfer data and energy between the data carrier and the read-write head.

Technical data TW-R16-B64

Figure 2
TW-R16-B64

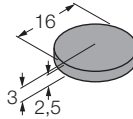

Table 2:
TW-R16-B64

Type	TW-R16-B64
Ident-No.	6900???

Memory data

Operating frequency	13.56 MHz
Memory size	128 Bytes
Number of read operations	unlimited
Number of write operations	10 ⁵
Read time (typical)	0.5...5 ms/Byte
Write time (typical)	3...6 ms/Byte
Memory type	EEPROM

Installation guidelines

Minimum distances when mounting in metal (around the data carrier)	10 mm
--	-------

General data

Colour	black
Ambient temperature	-25...+85 °C

Description of the data carrier

Table 2:
TW-R16-B64

Type	TW-R16-B64
Ident-No.	6900???
Storage temperature	-25...+120 °C +160 °C (1 x 35 h) +220 °C (1 x 30 s)
Degree of protection (IEC 60529/EN 60529)	IP68
Housing material	Epoxy, plastic-moulded

Technical data TW-R16-B128

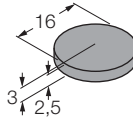
 Figure 3
TW-R16-B128

 Table 3:
TW-R16-B128

Type	TW-R16-B128
Ident-No.	6900501
Memory data	
Operating frequency	13.56 MHz
Memory size	128 Bytes
Number of read operations	unlimited
Number of write operations	10 ⁵
Read time (typical)	0.5...5 ms/Byte
Write time (typical)	3...6 ms/Byte
Memory type	EEPROM
Installation guidelines	
Minimum distances when mounting in metal (around the data carrier)	10 mm
General data	
Colour	black
Ambient temperature	-25...+85 °C

Description of the data carrier

Table 3:
TW-R16-B128

Type	TW-R16-B128
Ident-No.	6900501
Storage temperature	-25...+120 °C +160 °C (1 x 35 h) +220 °C (1 x 30 s)
Degree of protection (IEC 60529/EN 60529)	IP68
Housing material	Epoxy, plastic-moulded

Technical data TW-R20-B128

Figure 4
TW-R20-B128

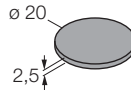

Table 4:
TW-R20-B128

Type	TW-R20-B128
Ident-No.	6900502
Memory data	
Operating frequency	13.56 MHz
Memory size	128 Bytes
Number of read operations	unlimited
Number of write operations	10 ⁵
Read time (typical)	0.5...5 ms/Byte
Write time (typical)	3...6 ms/Byte
Memory type	EEPROM
Installation guidelines	
Minimum distances when mounting in metal (around the data carrier)	10 mm
General data	
Colour	black
Ambient temperature	-25...+85 °C

Description of the data carrier

Table 4:
TW-R20-B128

Type	TW-R20-B128
Ident-No.	6900502
Storage temperature	-40...+90 °C +140 °C (1 x 100 h)
Degree of protection (IEC 60529/EN 60529)	IP68
Housing material	PA6

Technical data TW-R30-B128

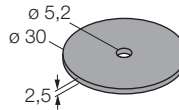
 Figure 5
TW-R30-B128

 Table 5:
TW-R30-B128

Type	TW-R30-B128
Ident-No.	6900503

Memory data

Operating frequency	13.56 MHz
Memory size	128 Bytes
Number of read operations	unlimited
Number of write operations	10 ⁵
Read time (typical)	0.5...5 ms/Byte
Write time (typical)	3...6 ms/Byte
Memory type	EEPROM

Installation guidelines

Minimum distances when mounting in metal (around the data carrier)	10 mm
--	-------

General data

Colour	black
Ambient temperature	-25...+85 °C

Description of the data carrier

Table 5:
TW-R30-B128

Type	TW-R30-B128
Ident-No.	6900503
Storage temperature	-40...+90 °C +140 °C (1 x 100 h)
Degree of protection (IEC 60529/EN 60529)	IP68
Housing material	PA6

Technical data TW-R50-B128

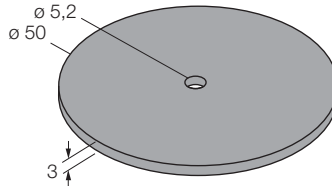
 Figure 6
TW-R50-B128

 Table 6:
TW-R50-B128

Type	TW-R50-B128
Ident-No.	6900504
Memory data	
Operating frequency	13.56 MHz
Memory size	128 Bytes
Number of read operations	unlimited
Number of write operations	10 ⁵
Read time (typical)	0.5...5 ms/Byte
Write time (typical)	3...6 ms/Byte
Memory type	EEPROM
Installation guidelines	
Minimum distances when mounting in metal (around the data carrier)	10 mm
General data	
Colour	black
Ambient temperature	-25...+85 °C

Description of the data carrier

Table 6:
TW-R50-B128

Type	TW-R50-B128
Ident-No.	6900504
Storage temperature	-40...+90 °C +140 °C (1 x 100 h)
Degree of protection (IEC 60529/EN 60529)	IP68
Housing material	PA6

Technical data TW-R20-K2

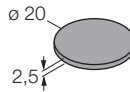
 Figure 7
TW-R20-K2

 Table 7:
TW-R20-K2

Type	TW-R20-K2
Ident-No.	6900505

Memory data

Operating frequency	13.56 MHz
Memory size	2 KBytes
Number of read operations	unlimited
Number of write operations	10 ¹⁰
Read time (typical)	0.5...5 ms/Byte
Write time (typical)	0.5...5 ms/Byte
Memory type	FRAM

Installation guidelines

Minimum distances when mounting in metal (around the data carrier)	10 mm
--	-------

General data

Colour	black
Ambient temperature	-20...+85 °C

Description of the data carrier

Table 7:
TW-R20-K2

Type	TW-R20-K2
Ident-No.	6900505
Storage temperature	-20...+85 °C +140 °C (1 x 100 h)
Degree of protection (IEC 60529/EN 60529)	IP68
Housing material	PA6

Technical data TW-R30-K2

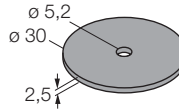
 Figure 8
TW-R30-K2

 Table 8:
TW-R30-K2

Type	TW-R30-K2
Ident-No.	6900506

Memory data

Operating frequency	13.56 MHz
Memory size	2 KBytes
Number of read operations	unlimited
Number of write operations	10 ¹⁰
Read time (typical)	0.5...5 ms/Byte
Write time (typical)	0.5...5 ms/Byte
Memory type	FRAM

Installation guidelines

Minimum distances when mounting in metal (around the data carrier)	10 mm
--	-------

General data

Colour	black
Ambient temperature	-20...+85 °C

Description of the data carrier

Table 8:

TW-R30-K2

Type	TW-R30-K2
Ident-No.	6900506
Storage temperature	-20...+85 °C +140 °C (1 x 100 h)
Degree of protection (IEC 60529/EN 60529)	IP68
Housing material	PA6

Technical data TW-R50-K2

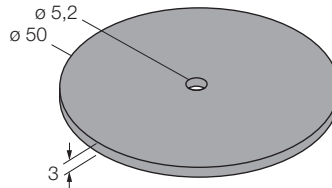
 Figure 9
TW-R50-K2

 Table 9:
TW-R50-K2

Type	TW-R50-K2
Ident-No.	6900507

Memory data

Operating frequency	13.56 MHz
Memory size	2 KBytes
Number of read operations	unlimited
Number of write operations	10 ¹⁰
Read time (typical)	0.5...5 ms/Byte
Write time (typical)	0.5...5 ms/Byte
Memory type	FRAM

Installation guidelines

Minimum distances when mounting in metal (around the data carrier)	10 mm
--	-------

General data

Colour	black
Ambient temperature	-20...+85 °C

Description of the data carrier

Table 9:
TW-R50-K2

Type	TW-R50-K2
Ident-No.	6900507
Storage temperature	-20...+85 °C +140 °C (1 x 100 h)
Degree of protection (IEC 60529/EN 60529)	IP68
Housing material	PA6

Technical data TW-R22-HT-B64

Figure 10
TW-R22-HT-B64

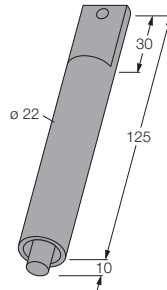

Table 10:
TW-R22-HT-B64

Type	TW-R22-HT-B64
Ident-No.	1542323

Memory data

Operating frequency	13.56 MHz
Memory size	64 Bytes
Number of read operations	unlimited
Number of write operations	10 ⁵
Read time (typical)	0.5...5 ms/Byte
Write time (typical)	3...6 ms/Byte
Memory type	EEPROM

Installation guidelines

Minimum distances when mounting in metal (around the data carrier)	10 mm
--	-------

General data

Colour	black
Ambient temperature	-25...+85 °C (time-dependent)

Description of the data carrier

Table 10:
TW-R22-HT-B64

Type	TW-R22-HT-B64
Ident-No.	1542323
Storage temperature	-40...+210 °C
Degree of protection (IEC 60529/EN 60529)	IP68
Housing material	PA66

Technical data TW-R50-90-HT-B128

Figure 11
TW-R50-90-HT-
B128

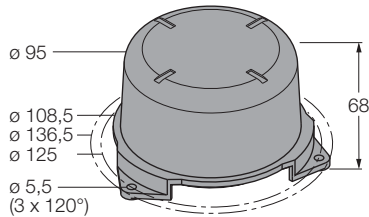

Table 11:
TW-R50-90HT-
B128

Type	TW-R50-90-HT-B128
Ident-No.	1542326

Memory data

Operating frequency	13.56 MHz
Memory size	128 Bytes
Number of read operations	unlimited
Number of write operations	10 ⁵
Read time (typical)	0.5...5 ms/Byte
Write time (typical)	3...6 ms/Byte
Memory type	EEPROM

Installation guidelines

Minimum distances when mounting in metal (around the data carrier)	–
--	---

General data

Colour	black
Ambient temperature	-25...+85 °C (time-dependent)

Description of the data carrier

Table 11:
TW-R50-90HT-
B128

Type	TW-R50-90-HT-B128
Ident-No.	1542326
Storage temperature	-40...+210 °C
Degree of protection (IEC 60529/EN 60529)	IP67
Housing material	PA66

Technical data TW-R50-90-HT-K2

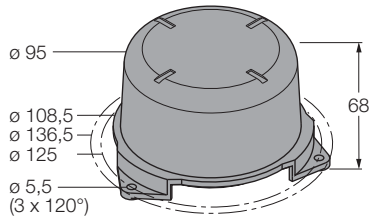
 Figure 12
TW-R50-90-HT-
K2

 Table 12:
TW-R50-90-HT-
K2

Type	TW-R50-90-HT-K2
Ident-No.	1542329

Memory data

Operating frequency	13.56 MHz
Memory size	2 KBytes
Number of read operations	unlimited
Number of write operations	10 ¹⁰
Read time (typical)	0.5...5 ms/Byte
Write time (typical)	0.5...5 ms/Byte
Memory type	FRAM

Installation guidelines

Minimum distances when mounting in metal (around the data carrier)	–
--	---

General data

Colour	black
Ambient temperature	-20...+85 °C (time-dependent)

Description of the data carrier

Table 12:
TW-R50-90-HT-
K2

Type	TW-R50-90-HT-K2
Ident-No.	1542329
Storage temperature	-40...+210 °C
Degree of protection (IEC 60529/EN 60529)	IP68
Housing material	PA66

Technical data TW-I14-B128

Figure 13
TW-I14-B128

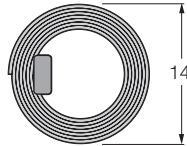

Table 13:
TW-I14-B128

Type	TW-I14-B128
Ident-No.	6900526

Memory data

Operating frequency	13.56 MHz
Memory size	128 Bytes
Number of read operations	unlimited
Number of write operations	10 ⁵
Read time (typical)	0.5...5 ms/Byte
Write time (typical)	3...6 ms/Byte
Memory type	EEPROM

Installation guidelines

Minimum distances when mounting in metal (around the data carrier)	10 mm
--	-------

General data

Colour	black
Ambient temperature	-25...+85 °C

Description of the data carrier

Table 13:
TW-I14-B128

Type	TW-I14-B128
Ident-No.	6900526
Storage temperature	-25...+120 °C +160 °C (1 x 35 h) +220 °C (1 x 30 s)
Degree of protection (IEC 60529/EN 60529)	IP10
Housing material	Epoxy foil

Technical data TW-L43-43-F-B128

Figure 14
TW-L43-43-F-
B128

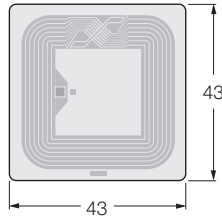

Table 14:
TW-L43-43-F-
B128

Type	TW-L43-43-F-B128
Ident-No.	6901344

Memory data

Operating frequency	13.56 MHz
Memory size	128 Bytes
Number of read operations	unlimited
Number of write operations	10 ⁵
Read time (typical)	0.5...5 ms/Byte
Write time (typical)	3...6 ms/Byte
Memory type	EEPROM

Installation guidelines

Minimum distances when mounting in metal (around the data carrier)	10 mm
--	-------

General data

Colour	white
Ambient temperature	-20...+70 °C

Description of the data carrier

Table 14:

TW-L43-43-F-
B128

Type	TW-L43-43-F-B128
Ident-No.	6901344
Storage temperature	-20...+70 °C
Degree of protection (IEC 60529/EN 60529)	IP40
Housing material	Foil, self-adhesive

Technical data TW-L82-49-P-B128

Figure 15
TW-L82-49-P-
B128

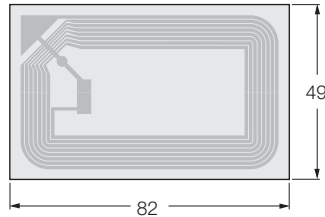

Table 15:
TW-L82-49-P-
B128

Type	TW-L82-49-P-B128
Ident-No.	6901345

Memory data

Operating frequency	13.56 MHz
Memory size	128 Bytes
Number of read operations	unlimited
Number of write operations	10 ⁵
Read time (typical)	0.5...5 ms/Byte
Write time (typical)	3...6 ms/Byte
Memory type	EEPROM

Installation guidelines

Minimum distances when mounting in metal (around the data carrier)	10 mm
--	-------

General data

Colour	white
Ambient temperature	-20...+70 °C

Description of the data carrier

Table 15:

TW-L82-49-P-
B128

Type	TW-L82-49-P-B128
Ident-No.	6901345
Storage temperature	-20...+70 °C
Degree of protection (IEC 60529/EN 60529)	IP40
Housing material	Paper, self-adhesive

6 Description of the read-write heads

Type overview	2
Function principle.....	3
Read-write head electronics	3
Read-write head antenna	4
Technical data of the read-write heads	
TB-M18-H1147.....	6
TB-M18-H1147/S1126 (optimised for special data carriers).....	7
TB-EM18WD-H1147 (wash-down).....	8
TB-EM18WD-H1147/S1126 (wash-down, optimised for special data carriers)	9
TN-M18-H1147	10
TN-M18-H1147/S1126 (optimised for special data carriers)	11
TN-EM18WD-H1147 (wash-down).....	12
TN-EM18WD-H1147/S1126 (wash-down, optimised for special data carriers).....	13
TB-M30-H1147.....	14
TB-M30-H1147/S1126 (optimised for special data carriers).....	15
TB-EM30WD-H1147 (wash-down).....	16
TB-EM30WD-H1147/S1126 (wash-down, optimised for special data carriers).....	17
TN-M30-H1147	18
TN-M30-H1147/S1126 (optimised for special data carriers)	19
TN-EM30WD-H1147 (wash-down).....	20
TN-EM30WD-H1147/S1126 (wash-down, optimised for special data carriers).....	21
TN-CK40-H1147.....	22
TN-CK40-H1147/S1126 (optimised for special data carriers).....	23
TN-Q80-H1147	24
TN-Q80-H1147/S1126 (optimised for special data carriers).....	25
TNER-Q80-H1147 (increased range).....	26
TNLR-Q80-H1147 (long range)	27
TNLR-Q80-H1147/S1126 (long range, optimised for special data carriers).....	28
TN-S32XL-H1147	29
Connection of the read-write heads	30

Description of the read-write heads

Type overview

Table 1:
Type overview
read-write
heads

Type	Installation conditions	Output function	Connection
TB-M18-H1147 TB-M18-H1147/S1126 TB-EM18WD-H1147 TB-EM18WD-H1147/S1126	flush	Read/write	via <i>BLident</i> cable
TN-M18-H1147 TN-M18-H1147/S1126 TN-EM30WD-H1147 TN-EM30WD-H1147/S1126	non- flush	Read/write	via <i>BLident</i> cable
TB-M30-H1147 TB-M30-H1147/S1126 TB-EM30WD-H1147 TB-EM30WD-H1147/S1126	flush	Read/write	via <i>BLident</i> cable
TN-M30-H1147 TN-M30-H1147/S1126 TN-EM30WD-H1147 TN-EM30WD-H1147/S1126	non- flush	Read/write	via <i>BLident</i> cable
TN-CK40-H1147 TN-CK40-H1147/S1126	non- flush, (flush instal- lation possible)	Read/write	via <i>BLident</i> cable
TN-Q80-H1147 TN-Q80-H1147/S1126 TNER-Q80-H1147 TNLR-Q80-H1147 TNLR-Q80-H1147/S1126	non- flush, (installatio n on metal possible)	Read/write	via <i>BLident</i> cable
TN-S32XL-H1147	non- flush (installation on metal possible)	Read/write	via <i>BLident</i> cable

Function principle

The *BLident* read-write heads (transceivers) are used for non-contact data exchange with the corresponding data carriers (TAGs). They form the so-called air-interface (transfer window), whose size varies depending on the combination of data carrier and transceiver. In this air-interface the data carrier is supplied with energy and the exchange of data is also implemented. The operating frequency is 13.56 MHz.

The achievable distances vary depending on the sizes from 15...200 mm. The read-write heads consist of electronics and an antenna. (Figure 1)

Figure 1
Block diagram
Read-write head

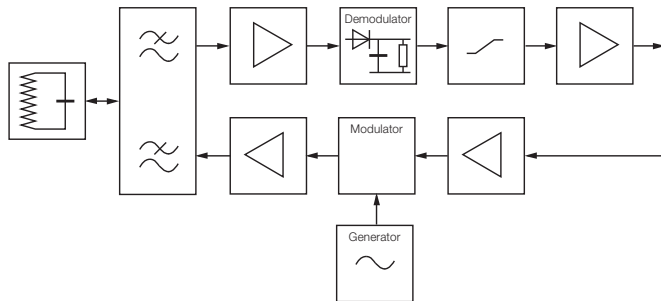

Read-write head electronics

The electronics ensure the communication between the data carrier, the read-write head and the *BLident* interface module.

Description of the read-write heads

Read-write head antenna

The antenna consists of an air coil. It is used to transfer data and energy between the data carrier and the read-write head. The antenna generates an electromagnetic field which is detected by the data carrier within the transfer zone. A data and energy transfer is only possible as long as the data carrier is located in this field (Figure 2).

Figure 2
Transfer zone

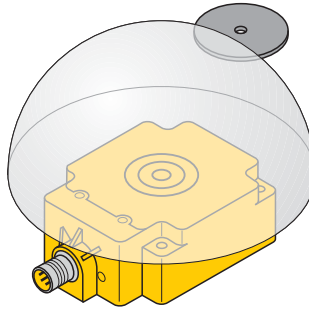

Technical data TB-M18-H1147

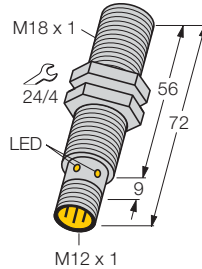
 Figure 3
TB-M18-H1147

 Table 2:
TB-M18-H1147

Type	TB-M18-H1147
Ident-No.	7030001
Mounting condition	flush
Ambient temperature	-25...+ 70 °C
Data transfer	inductive
Output function	Read/write
Operating frequency	13.56 MHz
Housing style	Threaded barrel, M18 × 1
Housing material	Metal, CuZn, chrome-plated
Active face material	Plastic, PA12-GF30
Connection	Connector, M12 × 1
Vibration resistance	55 Hz (1 mm)
Shock resistance	30 g (11 ms)
Degree of protection	IP67
Power ON indication	Green LED
Function display	Green LED, flashing

Description of the read-write heads

Technical data TB-M18-H1147/S1126

Figure 4
TB-M18-H1147/
S1126

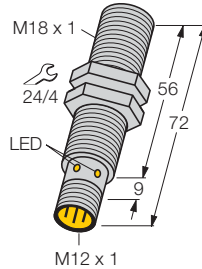

Table 3:TB-M18-
H1147/S1126

Type	TB-M18-H1147/S1126
Ident-No.	7030212

Mounting condition	flush
Ambient temperature	-25...+ 70 °C
Data transfer	inductive
Output function	Read/write
Operating frequency	13.56 MHz
Housing style	Threaded barrel, M18 × 1
Housing material	Metal, CuZn, chrome-plated
Active face material	Plastic, PA12-GF30
Connection	Connector, M12 × 1
Vibration resistance	55 Hz (1 mm)
Shock resistance	30 g (11 ms)
Degree of protection	IP67
Power ON indication	Green LED
Function display	Green LED, flashing

Technical data TB-EM18WD-H1147

Figure 5
TB-EM18WD-
H1147

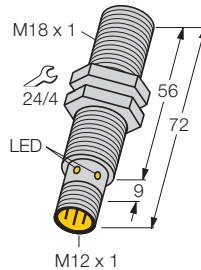

Table 4:TB-
EM18WD-H1147

Type	TB-EM18WD-H1147
Ident-No.	7030224
Mounting condition	flush
Ambient temperature	-25...+ 70 °C
Data transfer	inductive
Output function	Read/write
Operating frequency	13.56 MHz
Housing style	Threaded barrel, M18 × 1
Housing material	Metal, A4 1.4404 (AISI 316L)
Active face material	Plastic, LCP-GF30
Connection	Connector, M12 × 1
Vibration resistance	55 Hz (1 mm)
Shock resistance	30 g (11 ms)
Degree of protection	IP67
Power ON indication	Green LED
Function display	Green LED, flashing

Description of the read-write heads

Technical data TB-EM18WD-H1147/S1126

Figure 6
TB-EM18WD-
H1147/S1126

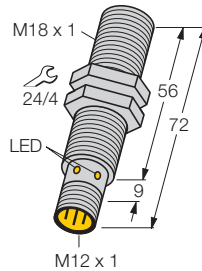
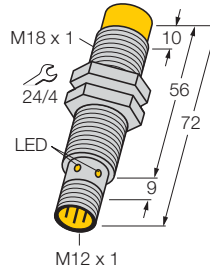

Table 5:TB-EM18
WD-H1147/S1126

Type	TB-EM18WD-H1147/S1126
Ident-No.	7030228

Mounting condition	flush
Ambient temperature	-25...+ 70 °C
Data transfer	inductive
Output function	Read/write
Operating frequency	13.56 MHz
Housing style	Threaded barrel, M18 × 1
Housing material	Metal, A4 1.4404 (AISI 316L)
Active face material	Plastic, LCP-GF30
Connection	Connector, M12 × 1
Vibration resistance	55 Hz (1 mm)
Shock resistance	30 g (11 ms)
Degree of protection	IP67
Power ON indication	Green LED
Function display	Green LED, flashing

Technical data TN-M18-H1147

 Figure 7
TN-M18-H1147

 Table 6:
TN-M18-H1147

Type	TN-M18-H1147
Ident-No.	7030002
Mounting condition	non-flush
Ambient temperature	-25...+ 70 °C
Data transfer	inductive
Output function	Read/write
Operating frequency	13.56 MHz
Housing style	Threaded barrel, M18 × 1
Housing material	Metal, CuZn, chrome-plated
Active face material	Plastic, PA12-GF30
Connection	Connector, M12 × 1
Vibration resistance	55 Hz (1 mm)
Shock resistance	30 g (11 ms)
Degree of protection	IP67
Power ON indication	Green LED
Function display	Green LED, flashing

Description of the read-write heads

Technical data TN-M18-H1147/S1126

Figure 8
TN-M18-H1147/
S1126

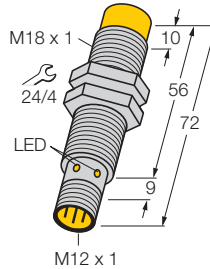

Table 7: TN-M18-
H1147/S1126

Type Ident-No.	TN-M18-H1147/S1126 7030213
Mounting condition	non-flush
Ambient temperature	-25...+ 70 °C
Data transfer	inductive
Output function	Read/write
Operating frequency	13.56 MHz
Housing style	Threaded barrel, M18 × 1
Housing material	Metal, CuZn, chrome-plated
Active face material	Plastic, PA12-GF30
Connection	Connector, M12 × 1
Vibration resistance	55 Hz (1 mm)
Shock resistance	30 g (11 ms)
Degree of protection	IP67
Power ON indication	Green LED
Function display	Green LED, flashing

Technical data TN-EM18WD-H1147

Figure 9
TN-EM18WD-
H1147

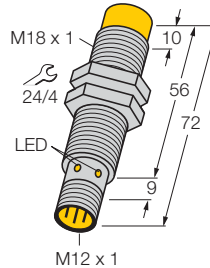

Table 8: TN-
EM18WD-H1147

Type	TN-EM18WD-H1147
Ident-No.	7030223
Mounting condition	non-flush
Ambient temperature	-25...+ 70 °C
Data transfer	inductive
Output function	Read/write
Operating frequency	13.56 MHz
Housing style	Threaded barrel, M18 × 1
Housing material	Metal, A4 1.4404 (AISI 316L)
Active face material	Plastic, LCP-GF30
Connection	Connector, M12 × 1
Vibration resistance	55 Hz (1 mm)
Shock resistance	30 g (11 ms)
Degree of protection	IP67
Power ON indication	Green LED
Function display	Green LED, flashing

Description of the read-write heads

Technical data TN-EM18WD-H1147/S1126

Figure 10
TN-EM18WD-
H1147/S1126

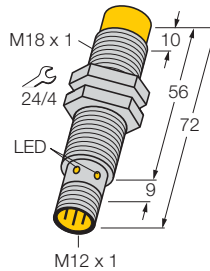
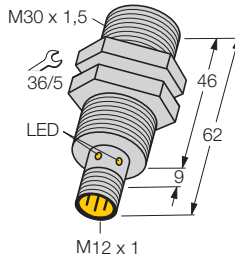

Table 9: TN-EM18
WD-H1147/S1126

Type Ident-No.	TN-EM18WD-H1147/S1126 7030227
Mounting condition	non-flush
Ambient temperature	-25...+ 70 °C
Data transfer	inductive
Output function	Read/write
Operating frequency	13.56 MHz
Housing style	Threaded barrel, M18 × 1
Housing material	Metal, A4 1.4404 (AISI 316L)
Active face material	Plastic, LCP-GF30
Connection	Connector, M12 × 1
Vibration resistance	55 Hz (1 mm)
Shock resistance	30 g (11 ms)
Degree of protection	IP67
Power ON indication	Green LED
Function display	Green LED, flashing

Technical data TB-M30-H1147

 Figure 11
TB-M30-H1147

This device complies with Part 15 of the FCC Rules.

Operation is subject to the following two conditions:
(1) this device may not cause harmful interference, and
(2) this device must accept any interference received, including interference that may cause undesired operation.

 Table 10:
TB-M30-H1147

Type	TB-M30-H1147
Ident-No.	7030003
Mounting condition	flush
Ambient temperature	-25...+ 70 °C
Data transfer	inductive
Output function	Read/write
Operating frequency	13.56 MHz
Housing style	Threaded barrel, M30 × 1.5
Housing material	Metal, CuZn, chrome-plated
Active face material	Plastic, PA12-GF30
Connection	Connector, M12 × 1
Vibration resistance	55 Hz (1 mm)
Shock resistance	30 g (11 ms)
Degree of protection	IP67
Power ON indication	Green LED
Function display	Green LED, flashing

Description of the read-write heads

Technical data TB-M30-H1147/S1126

Figure 12
TB-M30-H1147/
S1126

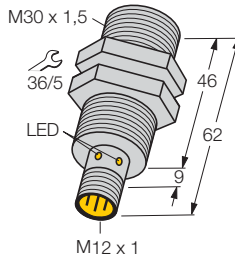

This device complies with Part 15 of the FCC Rules.

Operation is subject to the following two conditions:
(1) this device may not cause harmful interference, and
(2) this device must accept any interference received, including interference that may cause undesired operation.

Table 11: TB-M30
-H1147/S1126

Type	TB-M30-H1147/S1126
Ident-No.	7030214
Mounting condition	flush
Ambient temperature	-25...+ 70 °C
Data transfer	inductive
Output function	Read/write
Operating frequency	13.56 MHz
Housing style	Threaded barrel, M30 × 1.5
Housing material	Metal, CuZn, chrome-plated
Active face material	Plastic, PA12-GF30
Connection	Connector, M12 × 1
Vibration resistance	55 Hz (1 mm)
Shock resistance	30 g (11 ms)
Degree of protection	IP67
Power ON indication	Green LED
Function display	Green LED, flashing

Technical data TB-EM30WD-H1147

Figure 13
TB-EM30WD-
H1147

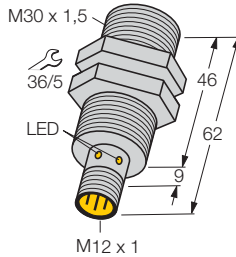

This device complies with Part 15 of the FCC Rules.

Operation is subject to the following two conditions:
(1) this device may not cause harmful interference, and
(2) this device must accept any interference received, including interference that may cause undesired operation.

Table 12:TB-
EM30WD-H1147

Type Ident-No.	TB-EM30WD-H1147 7030221
Mounting condition	flush
Ambient temperature	-25...+ 70 °C
Data transfer	inductive
Output function	Read/write
Operating frequency	13.56 MHz
Housing style	Threaded barrel, M30 × 1.5
Housing material	Metal, A4 1.4404 (AISI 316L)
Active face material	Plastic, LCP-GF30
Connection	Connector, M12 × 1
Vibration resistance	55 Hz (1 mm)
Shock resistance	30 g (11 ms)
Degree of protection	IP67
Power ON indication	Green LED
Function display	Green LED, flashing

Description of the read-write heads

Technical data TB-EM30WD-H1147/S1126

Figure 14
TB-EM30WD-
H1147/S1126

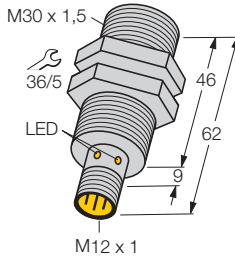

This device complies with Part 15 of the FCC Rules.

Operation is subject to the following two conditions:
(1) this device may not cause harmful interference, and
(2) this device must accept any interference received, including interference that may cause undesired operation.

Table 13:TB-EM30
WD-H1147/S1126

Type	TB-EM30WD-H1147/S1126
Ident-No.	7030225

Mounting condition	flush
Ambient temperature	-25...+ 70 °C
Data transfer	inductive
Output function	Read/write
Operating frequency	13.56 MHz
Housing style	Threaded barrel, M30 × 1.5
Housing material	Metal, A4 1.4404 (AISI 316L)
Active face material	Plastic, LCP-GF30
Connection	Connector, M12 × 1
Vibration resistance	55 Hz (1 mm)
Shock resistance	30 g (11 ms)
Degree of protection	IP67
Power ON indication	Green LED
Function display	Green LED, flashing

Technical data TN-M30-H1147

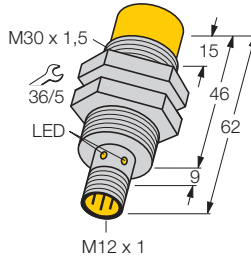
 Figure 15
TN-M30-H1147

This device complies with Part 15 of the FCC Rules.

Operation is subject to the following two conditions:
(1) this device may not cause harmful interference, and
(2) this device must accept any interference received, including interference that may cause undesired operation.

 Table 14:
TN-M30-H1147

Type	TN-M30-H1147
Ident-No.	7030004
Mounting condition	non-flush
Ambient temperature	-25...+ 70 °C
Data transfer	inductive
Output function	Read/write
Operating frequency	13.56 MHz
Housing style	Threaded barrel, M30 × 1.5
Housing material	Metal, CuZn, chrome-plated
Active face material	Plastic, PA12-GF30
Connection	Connector, M12 × 1
Vibration resistance	55 Hz (1 mm)
Shock resistance	30 g (11 ms)
Degree of protection	IP67
Power ON indication	Green LED
Function display	Green LED, flashing

Description of the read-write heads

Technical data TN-M30-H1147/S1126

Figure 16
TN-M30-H1147/
S1126

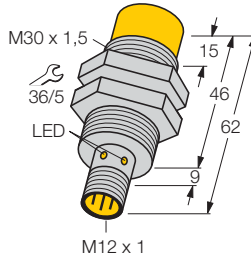

This device complies with Part 15 of the FCC Rules.

Operation is subject to the following two conditions:
(1) this device may not cause harmful interference, and
(2) this device must accept any interference received, including interference that may cause undesired operation.

Table 15: TN-M30-
H1147/S1126

Type	TN-M30-H1147/S1126
Ident-No.	7030215
Mounting condition	non-flush
Ambient temperature	-25...+ 70 °C
Data transfer	inductive
Output function	Read/write
Operating frequency	13.56 MHz
Housing style	Threaded barrel, M30 × 1.5
Housing material	Metal, CuZn, chrome-plated
Active face material	Plastic, PA12-GF30
Connection	Connector, M12 × 1
Vibration resistance	55 Hz (1 mm)
Shock resistance	30 g (11 ms)
Degree of protection	IP67
Power ON indication	Green LED
Function display	Green LED, flashing

Technical data TN-EM30WD-H1147

Figure 17
TN-EM30WD-
H1147

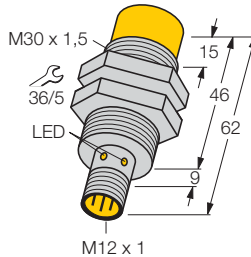

This device complies with Part 15 of the FCC Rules.

Operation is subject to the following two conditions:
(1) this device may not cause harmful interference, and
(2) this device must accept any interference received, including interference that may cause undesired operation.

6

Table 16: TN-
EM30WD-H1147

Type	TN-EM30WD-H1147
Ident-No.	7030222
Mounting condition	non-flush
Ambient temperature	-25...+ 70 °C
Data transfer	inductive
Output function	Read/write
Operating frequency	13.56 MHz
Housing style	Threaded barrel, M30 × 1.5
Housing material	Metal, A4 1.4404 (AISI 316L)
Active face material	Plastic, LCP-GF30
Connection	Connector, M12 × 1
Vibration resistance	55 Hz (1 mm)
Shock resistance	30 g (11 ms)
Degree of protection	IP67
Power ON indication	Green LED
Function display	Green LED, flashing

Description of the read-write heads

Technical data TN-EM30WD-H1147/S1126

Figure 18
TN-EM30WD-
H1147/S1126

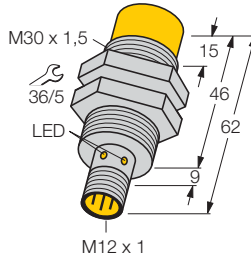

This device complies with Part 15 of the FCC Rules.

Operation is subject to the following two conditions:
(1) this device may not cause harmful interference, and
(2) this device must accept any interference received, including interference that may cause undesired operation.

Table 17: TN-EM30
WD-H1147/S1126

Type	TN-EM30WD-H1147/S1126
Ident-No.	7030226

Mounting condition	non-flush
Ambient temperature	-25...+ 70 °C
Data transfer	inductive
Output function	Read/write
Operating frequency	13.56 MHz
Housing style	Threaded barrel, M30 × 1.5
Housing material	Metal, A4 1.4404 (AISI 316L)
Active face material	Plastic, LCP-GF30
Connection	Connector, M12 × 1
Vibration resistance	55 Hz (1 mm)
Shock resistance	30 g (11 ms)
Degree of protection	IP67
Power ON indication	Green LED
Function display	Green LED, flashing

Technical data TN-CK40-H1147

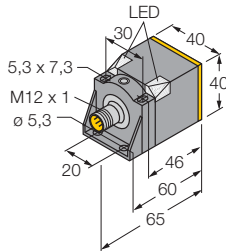
 Figure 19
TN-CK40-H1147

This device complies with Part 15 of the FCC Rules.

Operation is subject to the following two conditions:

- (1) this device may not cause harmful interference, and
- (2) this device must accept any interference received, including interference that may cause undesired operation.

 Table 18:
TN-CK40-H1147

Type	TN-CK40-H1147
Ident-No.	7030006
Mounting condition	non-flush, flush installation
Ambient temperature	-25...+ 70 °C
Data transfer	inductive
Output function	Read/write
Operating frequency	13.56 MHz
Housing style	Rectangular, CK40
Housing material	Plastic, PBT-GF30-V0, black
Active face material	Plastic, PBT-GF30-V0, yellow
Connection	Connector, M12 × 1
Vibration resistance	55 Hz (1 mm)
Shock resistance	30 g (11 ms)
Degree of protection	IP67
Power ON indication	Green LED
Function display	Green LED, flashing

Description of the read-write heads

Technical data TN-CK40-H1147/S1126

Figure 20
TN-CK40-H1147

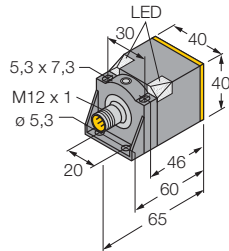

This device complies with Part 15 of the FCC Rules.

Operation is subject to the following two conditions:
(1) this device may not cause harmful interference, and
(2) this device must accept any interference received, including interference that may cause undesired operation.

Table 19: TN-CK40
-H1147/S1126

Type Ident-No.	TN-CK40-H1147/S1126 7030216
Mounting condition	non-flush, flush installation
Ambient temperature	-25...+ 70 °C
Data transfer	inductive
Output function	Read/write
Operating frequency	13.56 MHz
Housing style	Rectangular, CK40
Housing material	Plastic, PBT-GF30-V0, black
Active face material	Plastic, PBT-GF30-V0, yellow
Connection	Connector, M12 × 1
Vibration resistance	55 Hz (1 mm)
Shock resistance	30 g (11 ms)
Degree of protection	IP67
Power ON indication	Green LED
Function display	Green LED, flashing

Technical data TN-Q80-H1147

Figure 21
TN-Q80-H1147

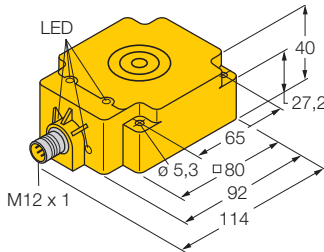

This device complies with Part 15 of the FCC Rules. Operation is subject to the following two conditions: (1) this device may not cause harmful interference, and (2) this device must accept any interference received, including interference that may cause undesired operation.

Table 20:
TN-Q80-H1147

Type	TN-Q80-H1147
Ident-No.	7030007
Mounting condition	non-flush, installation on metal possible
Ambient temperature	-25...+ 70 °C
Data transfer	inductive
Output function	Read/write
Operating frequency	13.56 MHz
Housing style	Q80
Housing material	Plastic, PBT-GF30-V0, yellow
Active face material	Plastic, PBT-GF30-V0, yellow
Connection	Connector, M12 × 1
Vibration resistance	55 Hz (1 mm)
Shock resistance	30 g (11 ms)
Degree of protection	IP67
Power ON indication	Green LED
Function display	Green LED, flashing

Description of the read-write heads

Technical data TN-Q80-H1147/S1126

Figure 22
TN-Q80-H1147/
S1126

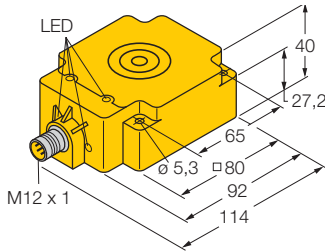

This device complies with Part 15 of the FCC Rules.

Operation is subject to the following two conditions:

- (1) this device may not cause harmful interference, and
- (2) this device must accept any interference received, including interference that may cause undesired operation.

Table 21: TN-Q80-
H1147/S1126

Type Ident-No.	TN-Q80-H1147/S1126 7030217
Mounting condition	non-flush, installation on metal possible
Ambient temperature	-25...+ 70 °C
Data transfer	inductive
Output function	Read/write
Operating frequency	13.56 MHz
Housing style	Q80
Housing material	Plastic, PBT-GF30-V0, yellow
Active face material	Plastic, PBT-GF30-V0, yellow
Connection	Connector, M12 × 1
Vibration resistance	55 Hz (1 mm)
Shock resistance	30 g (11 ms)
Degree of protection	IP67
Power ON indication	Green LED
Function display	Green LED, flashing

Technical data TNER-Q80-H1147

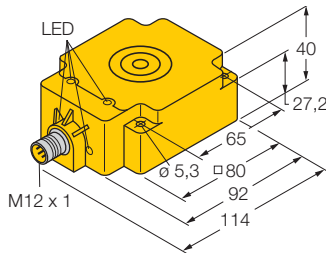
 Figure 23
TNER-Q80-
H1147

This device complies with Part 15 of the FCC Rules.

Operation is subject to the following two conditions:
(1) this device may not cause harmful interference, and
(2) this device must accept any interference received, including interference that may cause undesired operation.

6

 Table 22: TNER-
Q80-H1147

Type Ident-No.	TNER-Q80-H1147 7030211
Mounting condition	non-flush, installation on metal possible
Ambient temperature	-25...+ 70 °C
Data transfer	inductive
Output function	Read/write
Operating frequency	13.56 MHz
Housing style	Q80
Housing material	Plastic, PBT-GF30-V0, yellow
Active face material	Plastic, PBT-GF30-V0, yellow
Connection	Connector, M12 × 1
Vibration resistance	55 Hz (1 mm)
Shock resistance	30 g (11 ms)
Degree of protection	IP67
Power ON indication	Green LED
Function display	Green LED, flashing

Description of the read-write heads

Technical data TNLR-Q80-H1147

Figure 24
TNLR-Q80-H1147

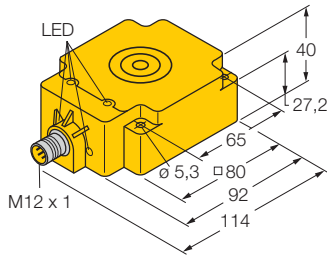

This device complies with Part 15 of the FCC Rules. Operation is subject to the following two conditions: (1) this device may not cause harmful interference, and (2) this device must accept any interference received, including interference that may cause undesired operation.

Table 23: TNLR-Q80-H1147

Type Ident-No.	TNLR-Q80-H1147 7030230
Mounting condition	non-flush, installation on metal possible
Ambient temperature	-25... + 70 °C
Data transfer	inductive
Output function	Read/write
Operating frequency	13.56 MHz
Housing style	Q80
Housing material	Plastic, PBT-GF30-V0, yellow
Active face material	Plastic, PBT-GF30-V0, yellow
Connection	Connector, M12 × 1
Vibration resistance	55 Hz (1 mm)
Shock resistance	30 g (11 ms)
Degree of protection	IP67
Power ON indication	Green LED
Function display	Green LED, flashing

Technical data TNLR-Q80-H1147/S1126

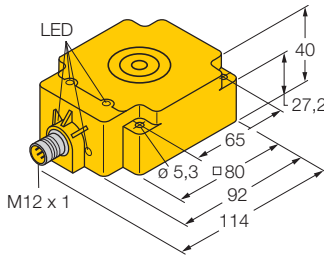
 Figure 25
TNLR-Q80-
H1147/S1126

This device complies with Part 15 of the FCC Rules.

Operation is subject to the following two conditions:
(1) this device may not cause harmful interference, and
(2) this device must accept any interference received, including interference that may cause undesired operation.

 Table 24: TNLR-
Q80-H1147/S1126

Type Ident-No.	TNLR-Q80-H1147/S1126 7030219
Mounting condition	non-flush, installation on metal possible
Ambient temperature	-25...+ 70 °C
Data transfer	inductive
Output function	Read/write
Operating frequency	13.56 MHz
Housing style	Q80
Housing material	Plastic, PBT-GF30-V0, yellow
Active face material	Plastic, PBT-GF30-V0, yellow
Connection	Connector, M12 × 1
Vibration resistance	55 Hz (1 mm)
Shock resistance	30 g (11 ms)
Degree of protection	IP67
Power ON indication	Green LED
Function display	Green LED, flashing

Description of the read-write heads

Technical data TN-S32XL-H1147

Figure 26
TN-S32XL-H1147

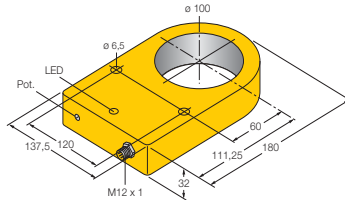

This device complies with Part 15 of the FCC Rules.

Operation is subject to the following two conditions:

- (1) this device may not cause harmful interference, and
- (2) this device must accept any interference received, including interference that may cause undesired operation.

Table 25:
TN-S32XL-H1147

Type	TN-S32XL-H1147
Ident-No.	7030008
Mounting condition	non-flush, installation on metal possible
Ambient temperature	-25...+ 70 °C
Data transfer	inductive
Output function	Read/write
Operating frequency	13.56 MHz
Housing style	Ring sensor, S32
Housing material	Plastic, ABS, yellow
Ring internal diameter	100 mm
Connection	Connector, M12 × 1
Vibration resistance	55 Hz (1 mm)
Shock resistance	30 g (11 ms)
Degree of protection	IP67
Power ON indication	Green LED
Function display	Green LED, flashing

Connection of the read-write heads

The read-write heads are connected via an M12 × 1 connector with the *BLident* interface module. The power supply (24 V DC) and function are implemented via the *BLident* interface module.

The standard cordsets feature the wiring diagram shown in figure 27.

Figure 27
Wiring diagram,
standard cables



The special cordsets .../S2502 feature a different wiring diagram (see figure 28).

Figure 28:
Wiring diagram,
special cordsets



Description of the read-write heads



7 Description of the read-write heads with corresponding data carriers

Notes for the operating data	2
Operating data	
TB-M18-H1147.....	3
TB-EM18WD-H1147	3
TB-M18-H1147/S1126	4
TB-EM18WD-H1147/S1126	4
TN-M18-H1147	5
TN-EM18WD-H1147	5
TN-M18-H1147/S1126.....	6
TN-EM18WD-H1147/S1126.....	6
TB-M30-H1147.....	7
TB-EM30WD-H1147	8
TB-M30-H1147/S1126.....	9
TB-EM30WD-H1147/S1126.....	10
TN-M30-H1147	11
TN-EM30WD-H1147	12
TN-M30-H1147/S1126.....	13
TN-EM30WD-H1147/S1126.....	14
TN-CK40-H1147.....	15
TN-CK40-H1147/S1126.....	16
TN-Q80-H1147	17
TN-Q80-H1147/S1126	18
TNER-Q80-H1147	19
TNLR-Q80-H1147	20
TNLR-Q80-H1147/S1126.....	21
TN-S32XL-H1147	22

Operating data

Notes for the operating data

The operating data are sufficient for the fundamental specification of a system. They provide a simplified analysis of the overtravel distances which can be found in chapter 8.

If a more detailed examination of the performance of read-write heads is necessary, the corresponding overtravel distances can be consulted.



Note

Remember that the auxiliary factors, e.g. the influence of metals, are not considered for the sake of simplification.

Corresponding tests should be undertaken before commissioning.

Operating data for read-write head

- TB-M18-H1147

- TB-EM18WD-H1147

*Table 1:
Operating data
TB-...M18...-
H1147*

Corresponding data carrier	Read-write distance	
	Recommended [mm]	Maximum [mm]
TW-R16-B128	6	13
TW-R20-B128	6	13
TW-R20-K2	5	12
TW-I14-B128	6	13
TW-L43-43-F-B128	15	30
TW-L82-49-P-B128	15	23

7

Operating data

Operating data for read-write head

- TB-M18-H1147/S1126

- TB-EM18WD-H1147/S1126

*Table 2:
Operating data
TB-...M18...-
H1147/S1126*

Corresponding data carrier	Read-write distance	
	Recommended [mm]	Maximum [mm]
TW-R16-B64	6	13
TW-R16-B128	6	13
TW-R20-B128	6	13
TW-I14-B128	6	13
TW-L43-43-F-B128	15	30
TW-L82-49-P-B128	15	23

Operating data for read-write head

- TN-M18-H1147

- TN-EM18WD-H1147

*Table 3:
Operating data
TN-...M18...-
H1147*

Corresponding data carrier	Read-write distance	
	Recommended [mm]	Maximum [mm]
TW-R16-B128	12	23
TW-R20-B128	10	22
TW-R30-B128	10	25
TW-R50-B128	20	41
TW-R20-K2	12	20
TW-R30-K2	16	31
TW-R50-K2	12	30
TW-I14-B128	10	22
TW-L43-43-F-B128	25	45
TW-L82-49-P-B128	20	40

7

Operating data

Operating data for read-write head

– TN-M18-H1147/S1126

– TN-EM18WD-H1147/S1126

*Table 4:
Operating data
TN-...M18...-
H1147/S1126*

Corresponding data carrier	Read-write distance	
	Recommended [mm]	Maximum [mm]
TW-R16-B64	6	13
TW-R16-B128	6	13
TW-R20-B128	6	13
TW-R20-K2	5	12
TW-I14-B128	6	13
TW-L43-43-F-B128	15	30
TW-L82-49-P-B128	15	23

**Operating data for read-write head
– TB-M30-H1147**

*Table 5:
Operating data
TB-M30-H1147*

Corresponding data carrier	Read-write distance	
	Recommended [mm]	Maximum [mm]
TW-R16-B64	12	23
TW-R16-B128	12	23
TW-R20-B128	15	27
TW-R30-B128	13	30
TW-R50-B128	20	43
TW-R20-K2	15	22
TW-R30-K2	15	27
TW-R50-K2	15	33
TW-R50-90-HT-B128	5	10
TW-I14-B128	15	27
TW-L43-43-F-B128	25	42
TW-L82-49-P-B128	20	43

7

Operating data

Operating data for read-write head - TB-EM30WD-H1147

Table 6:
Operating data
TB-...M30...-
H1147

Corresponding data carrier	Read-write distance	
	Recommended [mm]	Maximum [mm]
TW-R16-B128	12	23
TW-R20-B128	15	27
TW-R30-B128	13	30
TW-R50-B128	20	43
TW-R20-K2	15	22
TW-R30-K2	15	27
TW-R50-K2	15	33
TW-R50-90-HT-B128	5	10
TW-I14-B128	15	27
TW-L43-43-F-B128	25	42
TW-L82-49-P-B128	20	43

Operating data for read-write head
- TB-M30-H1147/S1126

<i>Table 7: Operating data TB-M30-H1147/ S1126</i>	Corresponding data carrier	Read-write distance	
		Recommended [mm]	Maximum [mm]
	TW-R16-B128	12	23
	TW-R20-B128	15	27
	TW-R30-B128	13	30
	TW-R50-B128	20	43
	TW-R22-HT-B64	5	17
	TW-R50-90-HT-B128	5	10
	TW-I14-B128	15	27
	TW-L43-43-F-B128	25	42
	TW-L82-49-P-B128	20	43

Operating data

Operating data for read-write head - TB-EM30WD-H1147/S1126

*Table 8:
Operating data
TB-...M30...-
H1147/S1126*

Corresponding data carrier	Read-write distance	
	Recommended [mm]	Maximum [mm]
TW-R16-B64	12	23
TW-R16-B128	12	23
TW-R20-B128	15	27
TW-R30-B128	13	30
TW-R50-B128	20	43
TW-R22-HT-B64	5	17
TW-R50-90-HT-B128	5	10
TW-I14-B128	15	27
TW-L43-43-F-B128	25	42
TW-L82-49-P-B128	20	43

**Operating data for read-write head
– TN-M30-H1147**

*Table 9:
Operating data
TN-M30-H1147*

Corresponding data carrier	Read-write distance	
	Recommen-ded [mm]	Maximum [mm]
TW-R16-B128	20	38
TW-R20-B128	22	40
TW-R30-B128	22	43
TW-R50-B128	40	72
TW-R20-K2	17	31
TW-R30-K2	23	42
TW-R50-K2	30	58
TW-R50-90-HT-B128	19	39
TW-R50-90-HT-K2	12	25
TW-I14-B128	22	40
TW-L43-43-F-B128	30	64
TW-L82-49-P-B128	30	65

Operating data

Operating data for read-write head – TN-EM30WD-H1147

Table 10:
Operating data
TN-...M30...-
H1147

Corresponding data carrier	Read-write distance	
	Recommended [mm]	Maximum [mm]
TW-R16-B128	20	38
TW-R20-B128	22	40
TW-R30-B128	22	43
TW-R50-B128	40	72
TW-R20-K2	17	31
TW-R30-K2	23	42
TW-R50-K2	30	58
TW-R50-90-HT-B128	19	39
TW-R50-90-HT-K2	12	25
TW-I14-B128	22	40
TW-L43-43-F-B128	30	64
TW-L82-49-P-B128	30	65

Operating data for read-write head
- TN-M30-H1147/S1126

<i>Table 11: Operating data TN-M30-H1147/ S1126</i>	Corresponding data carrier	Read-write distance	
		Recommended [mm]	Maximum [mm]
	TW-R16-B64	20	38
	TW-R16-B128	20	38
	TW-R20-B128	22	40
	TW-R30-B128	22	43
	TW-R50-B128	40	72
	TW-R22-HT-B64	12	30
	TW-R50-90-HT-B128	19	39
	TW-I14-B128	22	40
	TW-L43-43-F-B128	30	64
	TW-L82-49-P-B128	30	65

Operating data

Operating data for read-write head – TN-EM30WD-H1147/S1126

Table 12:
Operating data
TN-EM30WD-
H1147/S1126

Corresponding data carrier	Read-write distance	
	Recommended [mm]	Maximum [mm]
TW-R16-B64	20	38
TW-R16-B128	20	38
TW-R20-B128	22	40
TW-R30-B128	22	43
TW-R50-B128	40	72
TW-R22-HT-B64	12	30
TW-R50-90-HT-B128	19	39
TW-I14-B128	22	40
TW-L43-43-F-B128	30	64
TW-L82-49-P-B128	30	65

**Operating data for read-write head
– TN-CK40-H1147**

*Table 13:
Operating data
TN-CK40-H1147*

Corresponding data carrier	Read-write distance	
	Recommended [mm]	Maximum [mm]
TW-R16-B64	28	50
TW-R16-B128	28	50
TW-R20-B128	30	50
TW-R30-B128	30	53
TW-R50-B128	45	85
TW-R20-K2	22	40
TW-R30-K2	30	55
TW-R50-K2	38	81
TW-R50-90-HT-B128	26	52
TW-R50-90-HT-K2	24	48
TW-I14-B128	30	50
TW-L43-43-F-B128	50	90
TW-L82-49-P-B128	50	96

Operating data

Operating data for read-write head – TN-CK40-H1147/S1126

*Table 14:
Operating data
TN-CK40-H1147/
S1126*

Corresponding data carrier	Read-write distance	
	Recommended [mm]	Maximum [mm]
TW-R16-B64	28	50
TW-R16-B128	28	50
TW-R20-B128	30	50
TW-R30-B128	30	53
TW-R50-B128	45	85
TW-R22-HT-B64	20	40
TW-R50-90-HT-B128	26	52
TW-I14-B128	30	50
TW-L43-43-F-B128	50	90
TW-L82-49-P-B128	50	96

**Operating data for read-write head
– TN-Q80-H1147**

*Table 15:
Operating data
TN-Q80-H1147*

Corresponding data carrier	Read-write distance	
	Recommen-ded [mm]	Maximum [mm]
TW-R16-B128	20	52
TW-R20-B128	35	65
TW-R30-B128	35	72
TW-R50-B128	65	118
TW-R20-K2	25	52
TW-R30-K2	35	67
TW-R50-K2	50	100
TW-R50-90-HT-B128	42	85
TW-R50-90-HT-K2	33	67
TW-I14-B128	35	65
TW-L43-43-F-B128	60	115
TW-L82-49-P-B128	65	128

Operating data

Operating data for read-write head – TN-Q80-H1147/S1126

*Table 16:
Operating data
TN-Q80-H1147/
S1126*

Corresponding data carrier	Read-write distance	
	Recommended [mm]	Maximum [mm]
TW-R16-B64	20	52
TW-R16-B128	20	52
TW-R20-B128	35	65
TW-R30-B128	35	72
TW-R50-B128	65	118
TW-R20-K2	25	52
TW-R22-HT-B64	25	55
TW-R50-90-HT-B128	42	85
TW-I14-B128	35	65
TW-L43-43-F-B128	60	115
TW-L82-49-P-B128	65	128

**Operating data for read-write head
- TNER-Q80-H1147**

*Table 17:
Operating data
TNER-Q80-
H1147*

Corresponding data carrier	Read-write distance	
	Recommended [mm]	Maximum [mm]
TW-R16-B64	20	52
TW-R22-HT-B64	35	70

Operating data

Operating data for read-write head – TNLR-Q80-H1147

Table 18:
Operating data
TNLR-Q80-H1147

Corresponding data carrier	Read-write distance	
	Recommended [mm]	Maximum [mm]
TW-R16-B128	50	85
TW-R20-B128	50	88
TW-R30-B128	60	115
TW-R50-B128	80	165
TW-R20-K2	40	75
TW-R30-K2	60	98
TW-R50-K2	90	144
TW-R50-90-HT-B128	60	135
TW-R50-90-HT-K2	60	114
TW-I14-B128	50	85
TW-L43-43-F-B128	90	155
TW-L82-49-P-B128	90	168

**Operating data for read-write head
– TNLR-Q80-H1147/S1126**

<i>Table 19: Operating data TNLR-Q80- H1147/S1126</i>	Corresponding data carrier	Read-write distance	
		Recommended [mm]	Maximum [mm]
	TW-R20-B128	50	88
	TW-R30-B128	60	115
	TW-R50-B128	80	165
	TW-R22-HT-B64	39	74
	TW-R50-90-HT-B128	60	135
	TW-I14-B128	50	85
	TW-L43-43-F-B128	90	155
	TW-L82-49-P-B128	90	168

Operating data

Operating data for read-write head – TN-S32XL-H1147

Table 20:
Operating data
TN-S32XL-H1147

Corresponding data carrier	Read-write distance	
	Recommen-ded [mm]	Maximum [mm]
TW-R16-B128	20	67
TW-R20-B128	36	72
TW-R30-B128	30	80
TW-R50-B128	80	150
TW-R20-K2	32	64
TW-R30-K2	30	78
TW-R50-K2	60	128
TW-R50-90-HT-B128	58	1117
TW-R50-90-HT-K2	42	85
TW-I14-B128	36	72
TW-L43-43-F-B128	80	140
TW-L82-49-P-B128	80	160

8 Description of the read-write heads with corresponding data carriers

Notes for the overtravel distances	3
Overtravel distance read-write head – housing style M18	
TN-...M18...-H1147... with data carrier TW-R16-B128	5
TB-...M18...-H1147... with data carrier TW-R16-B128	5
TN-...M18...-H1147... with data carrier TW-R20-B128	6
TB-...M18...-H1147... with data carrier TW-R20-B128	6
TN-...M18...-H1147... with data carrier TW-R30-B128	7
TB-...M18...-H1147... with data carrier TW-R30-B128	7
TN-...M18...-H1147... with data carrier TW-R50-B128,	8
TN-...M18...-H1147... with data carrier TW-R20-K2	8
TB-...M18...-H1147... with data carrier TW-R20-K2	9
TN-...M18...-H1147... with data carrier TW-R30-K2	9
TN-...M18...-H1147... with data carrier TW-R50-K2	10
TN-...M18...-H1147... with data carrier TW-L43-43-F-B128	10
TB-...M18...-H1147... with data carrier TW-L43-43-F-B128	11
TN-...M18...-H1147... with data carrier TW-L82-49-P-B128	11
TB-...M18...-H1147... with data carrier TW-L82-49-P-B128	12
Overtravel distance read-write head – housing style M30	
TN-...M30...-H1147... with data carrier TW-R16-B128	12
TB-...M30...-H1147... with data carrier TW-R16-B128	13
TN-...M30...-H1147... with data carrier TW-R20-B128	13
TB-...M30...-H1147... with data carrier TW-R20-B128	14
TN-...M30...-H1147... with data carrier TW-R30-B128	14
TB-...M30...-H1147... with data carrier TW-R30-B128	15
TN-...M30...-H1147... with data carrier TW-R50-B128	15
TB-...M30...-H1147... with data carrier TW-R50-B128	16
TN-...M30...-H1147... with data carrier TW-R20-K2	16
TB-...M30...-H1147... with data carrier TW-R20-K2	17
TN-...M30...-H1147... with data carrier TW-R30-K2	17
TB-...M30...-H1147... with data carrier TW-R30-K2	18
TN-...M30...-H1147... with data carrier TW-R50-K2	18
TB-...M30...-H1147... with data carrier TW-R50-K2	19
TN-...M30...-H1147... with data carrier TW-L43-43-F-B128	19
TB-...M30...-H1147... with data carrier TW-L43-43-F-B128	20
TN-...M30...-H1147... with data carrier TW-L82-49-P-B128	20
TB-...M30...-H1147... with data carrier TW-L82-49-P-B128	21

Overtravel ranges

Overtravel distance read-write head – housing style Q40	
TN-CK40-H1147... with data carrier TW-R16-B128	21
TN-CK40-H1147... with data carrier TW-R20-B128	22
TN-CK40-H1147... with data carrier TW-R30-B128	22
TN-CK40-H1147... with data carrier TW-R50-B128	23
TN-CK40-H1147... with data carrier TW-R20-K2	23
TN-CK40-H1147... with data carrier TW-R30-K2	24
TN-CK40-H1147... with data carrier TW-R50-K2	24
TN-CK40-H1147... with data carrier TW-L43-43-F-B128	25
TN-CK40-H1147... with data carrier TW-L82-49-P-B128	25
Overtravel distance read-write head – housing style Q80	
TN-Q80-H1147 with data carrier TW-R16-B128	26
TN-Q80-H1147 with data carrier TW-R20-B128	26
TN-Q80-H1147 with data carrier TW-R30-B128	27
TN-Q80-H1147 with data carrier TW-R50-B128	27
TN-Q80-H1147 with data carrier TW-R20-K2	28
TN-Q80-H1147 with data carrier TW-R30-K2	28
TN-Q80-H1147 with data carrier TW-R50-K2	29
TN-Q80-H1147 with data carrier TW-L43-43-F-B128	29
TN-Q80-H1147 with data carrier TW-L82-49-P-B128	30
TNLR-Q80-H1147 with data carrier TW-R16-B128	30
TNLR-Q80-H1147 with data carrier TW-R20-B128	31
TNLR-Q80-H1147 with data carrier TW-R20-K2	31
TNLR-Q80-H1147 with data carrier TW-R30-B128	32
TNLR-Q80-H1147 with data carrier TW-R30-K2	32
TNLR-Q80-H1147 with data carrier TW-R50-B128	33
TNLR-Q80-H1147 with data carrier TW-R50-K2	33
TNLR-Q80-H1147 with data carrier TW-L43-43-F-B128	34
Overtravel distance read-write head – housing style S32	
TN-S32XL-H1147 with data carrier TW-R16-B128	35
TN-S32XL-H1147 with data carrier TW-R30-B128	35
TN-S32XL-H1147 with data carrier TW-R50-B128	36
TN-S32XL-H1147 with data carrier TW-R30-K2	36
TN-S32XL-H1147 with data carrier TW-R50-K2	37
TN-S32XL-H1147 with data carrier TW-L43-43-F-B128	37
TN-S32XL-H1147 with data carrier TW-L82-49-P-B128	38

Notes for the overtravel distances

The following characteristic curves indicate the overtravel distances of the different read-write heads with the data carriers used.

The characteristic curves are not just dependent on the used read-write head and the data carrier, but also on the memory type of the data carrier (EEPROM or FRAM) (see Overview table 1).

The characteristic curves of the high temperature data carriers TW-50-90-HT-B128 and TW-50-90-HT-K2 are not listed separately.

They deviate from those listed on the following pages only in the fact that the curves must simply be offset downwards by 30mm..

Overtravel ranges

Table 1:
Data carrier
memory type

Type	High-temperature resistant	Memory size	Memory type
TW-R16-B64	–	64 Byte	EEPROM
TW-R16-B128	–	128 Byte	EEPROM
TW-R20-B128	–	128 Byte	EEPROM
TW-R30-B128	–	128 Byte	EEPROM
TW-R50-B128	–	128 Byte	EEPROM
TW-R20-K2	–	2 kByte	FRAM
TW-R30-K2	–	2 kByte	FRAM
TW-R50-K2	–	2 kByte	FRAM
TW-R22-HT-B64	✓	64 Byte	EEPROM
TW-R50-90-HT-B128	✓	128 Byte	EEPROM
TW-R50-90-HT-K2	✓	2 kByte	FRAM
TW-I14-B128	–	128 Byte	EEPROM
TW-L43-43-F-B128	–	128 Byte	EEPROM
TW-L82-49-P-B128	–	128 Byte	EEPROM

Read-write head TN-...M18...-H1147... overtravel distance with data carrier TW-R16-B128.

Figure 1
Overtravel distance TN-...M18...-H1147... with TW-R16-B128

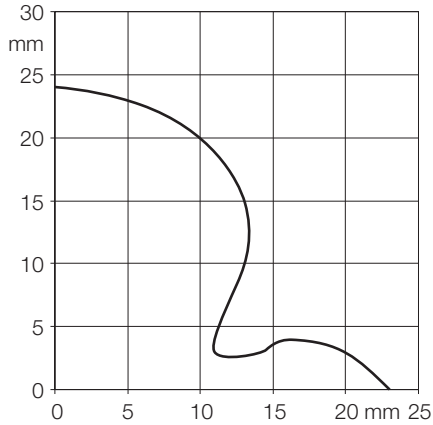

8

Read-write head TB-...M18...-H1147... overtravel distance with data carrier TW-R16-B128.

Figure 2
Overtravel distance TB-...M18...-H1147... with TW-R16-B128

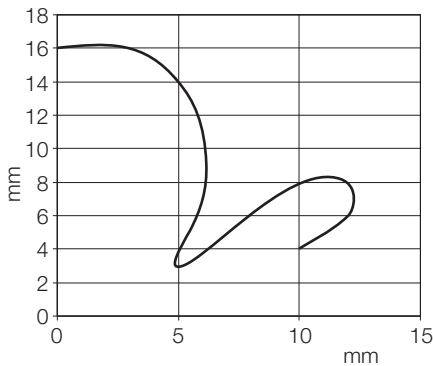

Overtravel ranges

Read-write head TN-...M18...-H1147... overtravel distance with data carrier TW-R20-B128.

Figure 3
Overtravel
distance TN-
...M18...-H1147...
with TW-R20-
B128

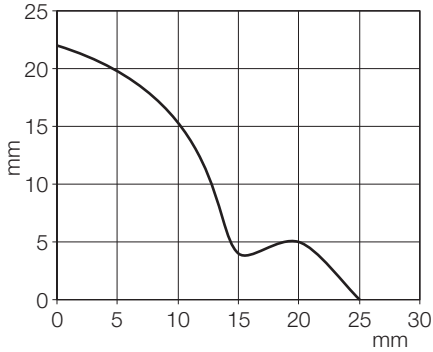

Read-write head TB-...M18...-H1147... overtravel distance with data carrier TW-R20-B128.

Figure 4
Overtravel
distance TB-
...M18...-H1147...
with TW-R20-
B128

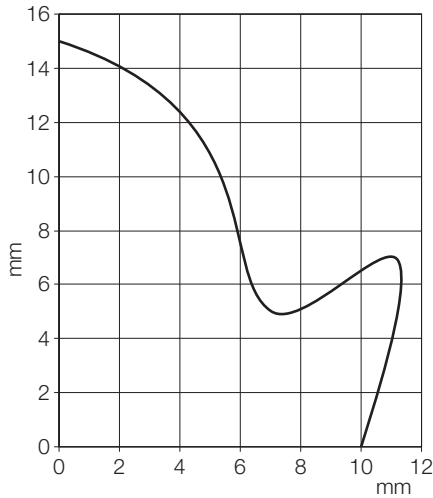

Read-write head TN-...M18...-H1147... overtravel distance with data carrier TW-R30-B128.

Figure 5
Overtravel
distance TN-
...M18...-H1147...
with TW-R30-
B128

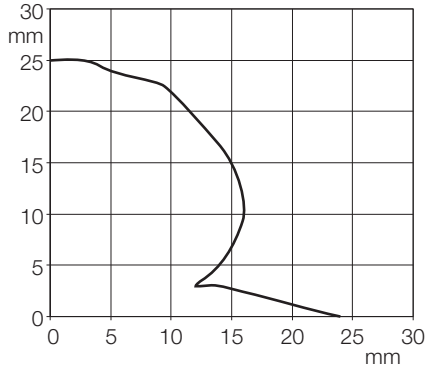

Read-write head TB-...M18...-H1147... overtravel distance with data carrier TW-R30-B128.

Figure 6
Overtravel
distance TB-
...M18...-H1147...
with TW-R30-
B128

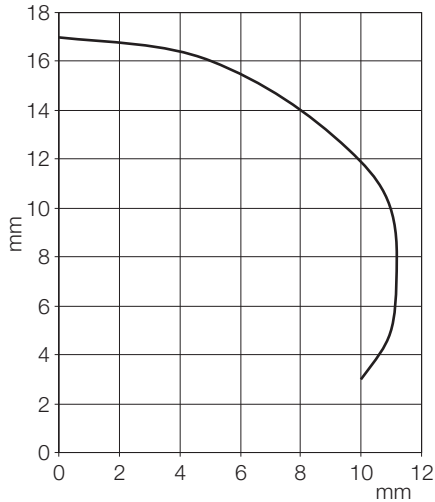

Overtravel ranges

Read-write head TN-...M18...-H1147... overtravel distance with data carrier TW-R50-B128.,

Figure 7
Overtravel
distance TN-
...M18...-H1147...
with TW-R50-
B128

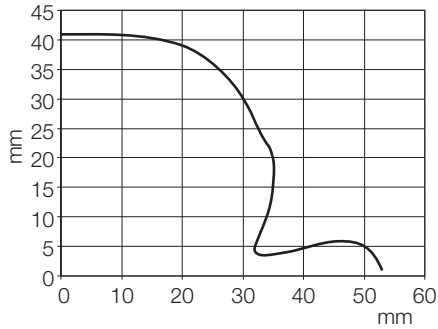

Read-write head TN-...M18...-H1147... overtravel distance with data carrier TW-R20-K2,

Figure 8
Overtravel
distance TN-
...M18...-H1147...
with TW-R20-K2

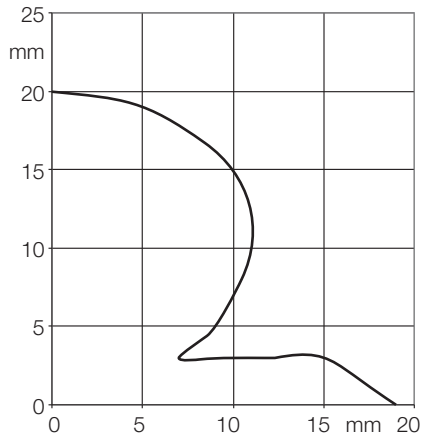

Read-write head TB-...M18...-H1147... overtravel distance with data carrier TW-R20-K2,

Figure 9
Overtravel
distance TB-
...M18...-H1147...
with TW-R20-K2

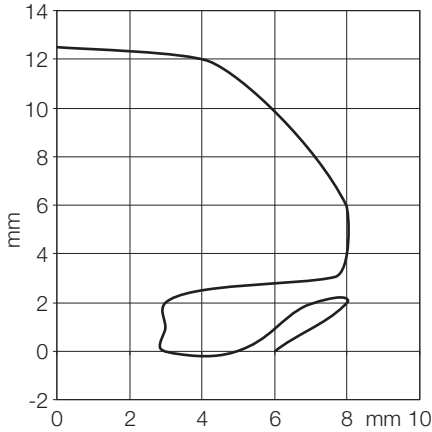

Read-write head TN-...M18...-H1147... overtravel distance with data carrier TW-R30-K2

Figure 10
Overtravel
distance TN-
...M18...-H1147...
with TW-R30-K2

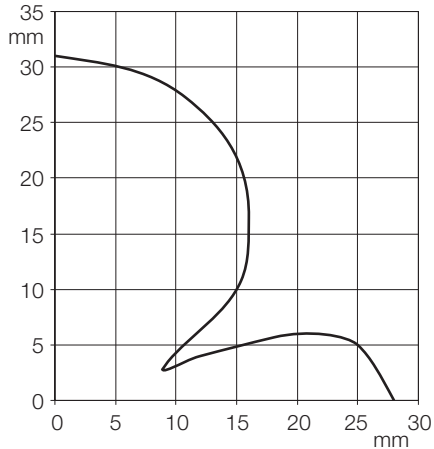

Overtravel ranges

Read-write head TN...-...M18...-H1147... overtravel distance with data carrier TW-R50-K2

Figure 11
Overtravel distance TN-M18-H1147 with TW-R50-K2

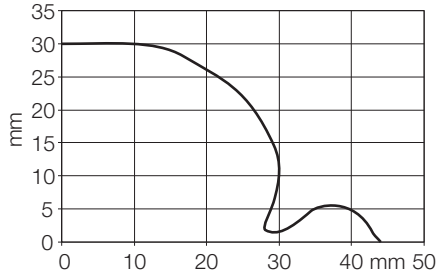

Read-write head TN-...M18..-H1147... overtravel distance with data carrier TW-L43-43-F-B128

Figure 12
Overtravel distance TN-...M18...-H1147... with TW-L43-43-F-B128

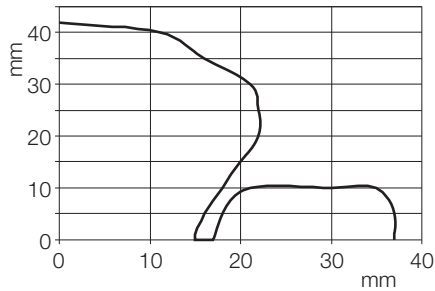

Read-write head TB-...M18..-H1147... overtravel distance with data carrier TW-L43-43-F-B128

Figure 13
Overtravel distance TB-...M18...-H1147... with TW-L43-43-F-B128

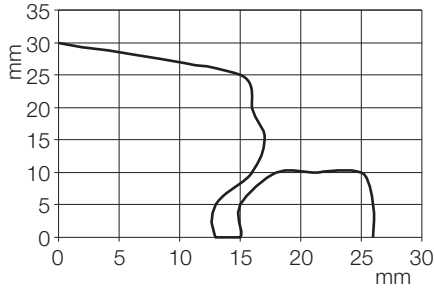

Read-write head TN-...M18..-H1147... overtravel distance with data carrier TW-L82-49-P-B128

Figure 14
Overtravel distance TN-...M18...-H1147... with TW-L82-49-P-B128

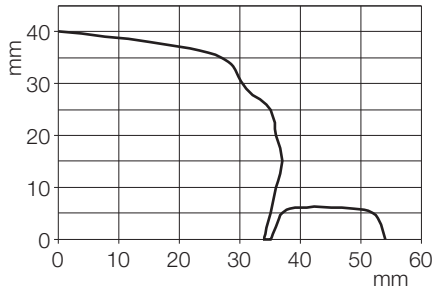

Overtravel ranges

Read-write head TB-...M18...H1147... overtravel distance with data carrier TW-L82-49-P-B128

Figure 15
Overtravel distance TB-...M18-...H1147... with TW-L82-4-P-B128

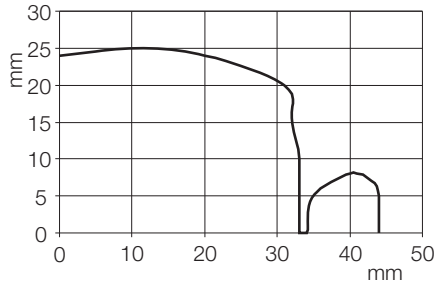

Read-write head TN-...M30...-H1147... overtravel distance with data carrier TW-R16-B128.

Figure 16
Overtravel distance TN-M30-H1147 with TW-R16-B128

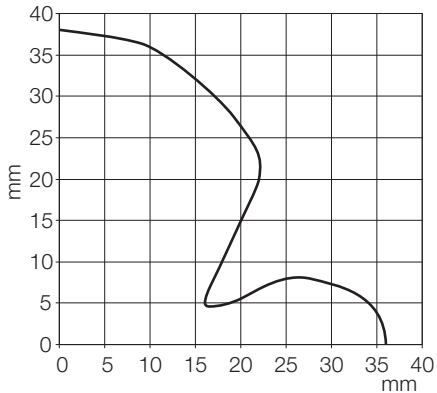

Read-write head TB-...M30...-H1147... overtravel distance with data carrier TW-R16-B128.

Figure 17
Overtravel
distance TB-
...M30...-H1147...
with TW-R16-
B128

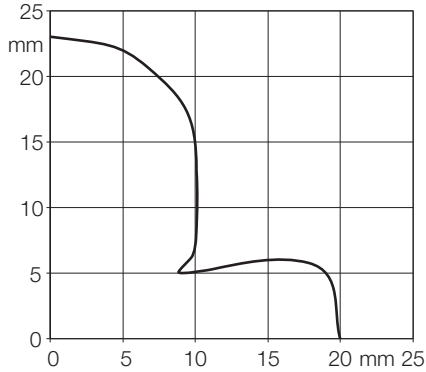

Read-write head TN-...M30...-H1147... overtravel distance with data carrier TW-R20-B128.

Figure 18
Overtravel
distance TN-
...M30...-H1147...
with TW-R20-
B128

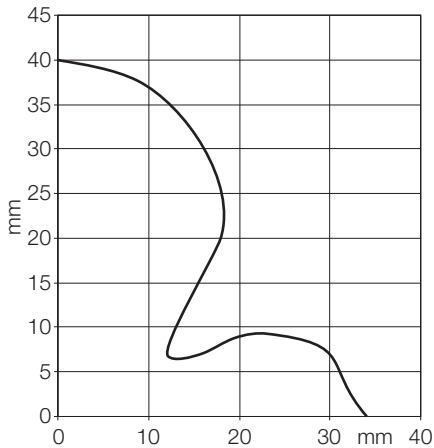

Overtravel ranges

Read-write head TB-...M30...-H1147... overtravel distance with data carrier TW-R20-B128.

Figure 19
Overtravel
distance TB-
...M30...-H1147...
with TW-R20-
B128

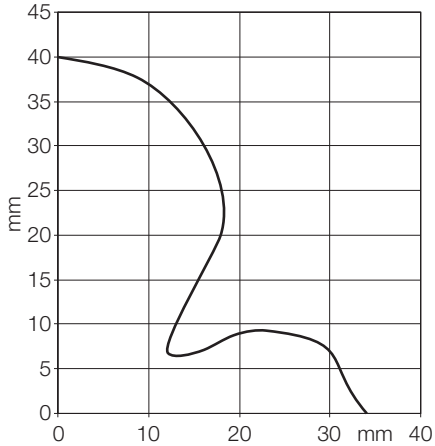

Read-write head TN-...M30...-H1147... overtravel distance with data carrier TW-R30-B128.

Figure 20
Overtravel
distance TN-
...M30...-H1147...
with TW-R30-
B128

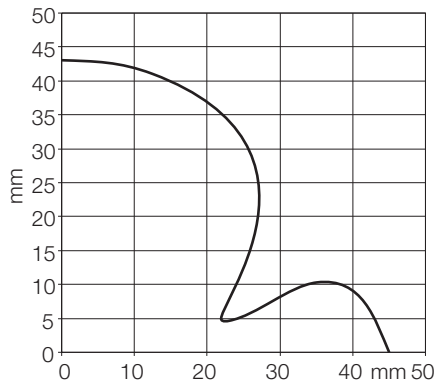

Read-write head TB-...M30...-H1147... overtravel distance with data carrier TW-R30-B128.

Figure 21
Overtravel
distance TB-
...M30...-H1147...
with TW-R30-
B128

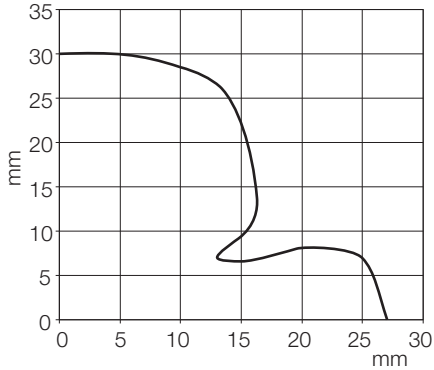

Read-write head TN-...M30...-H1147... overtravel distance with data carrier TW-R50-B128.

Figure 22
Overtravel
distance TN-
...M30...-H1147...
with TW-R50-
B128

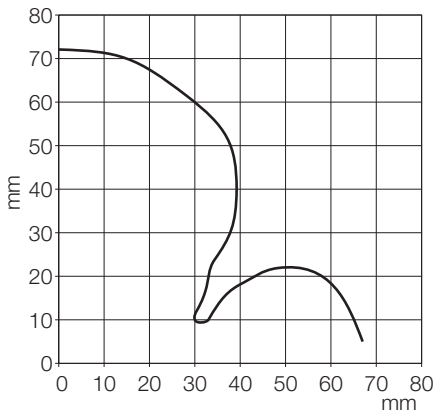

Overtravel ranges

Read-write head TB-...M30...-H1147... overtravel distance with data carrier TW-R50-B128

Figure 23
Overtravel
distance TB-
...M30...-H1147...
with TW-R50-
B128

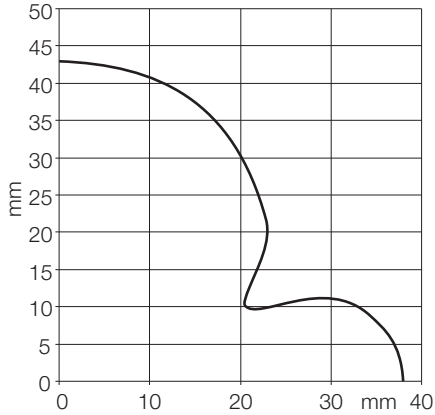

Read-write head TN-...M30...-H1147... overtravel distance with data carrier TW-R20-K2

Figure 24
Overtravel
distance TN-
...M30...-H1147...
with TW-R20-K2

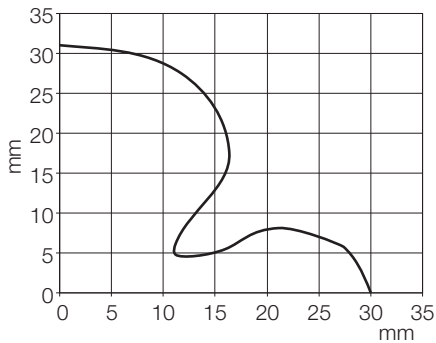

Read-write head TB-...M30...-H1147... overtravel distance with data carrier TW-R20-K2

Figure 25
Overtravel
distance TB-
...M30...-H1147...
with TW-R20-K2

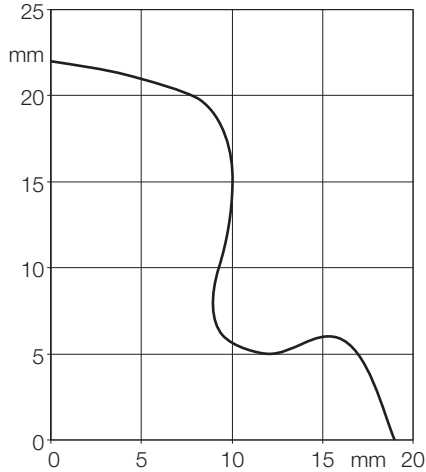

Read-write head TN-...M30...-H1147... overtravel distance with data carrier TW-R30-K2

Figure 26
Overtravel
distance TN-
...M30...-H1147...
with TW-R30-K2

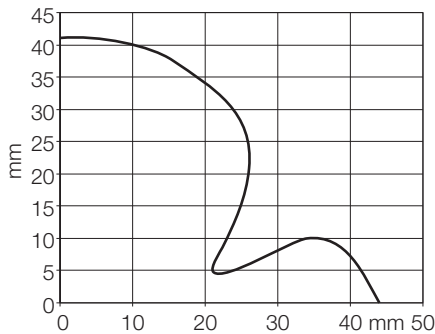

Overtravel ranges

Read-write head TB-...M30...-H1147... overtravel distance with data carrier TW-R30-K2

Figure 27
Overtravel
distance TB-
...M30...-H1147...
with TW-R30-K2

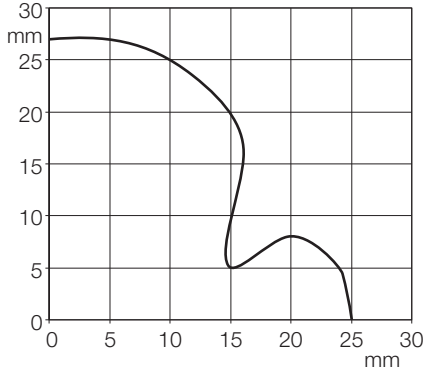

Read-write head TN-...M30...-H1147... overtravel distance with data carrier TW-R50-K2

Figure 28
Overtravel
distance TN-
...M30...-H1147...
with TW-R50-K2

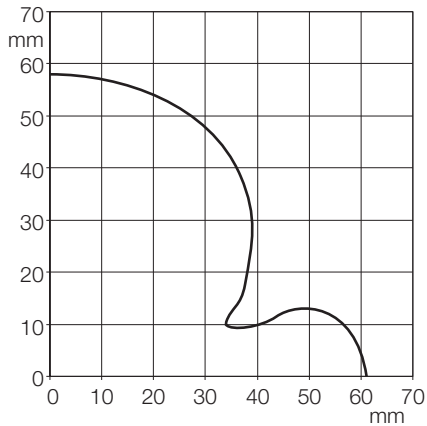

Read-write head TB-...M30...-H1147... overtravel distance with data carrier TW-R50-K2

Figure 29
Overtravel distance TB-...M30...-H1147... with TW-R50-...K2

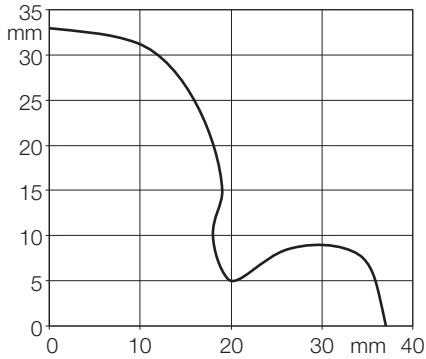

Read-write head TN-...M30...-H1147... overtravel distance with data carrier TW-L43-43-F-B128

Figure 30
Overtravel distance TN-...M30...-H1147... with TW-L43-43-F-B128

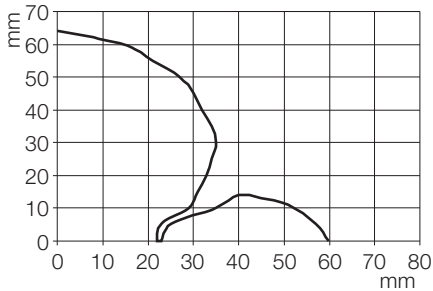

Overtravel ranges

Read-write head TB-...M30...-H1147... overtravel distance with data carrier TW-L43-43-F-B128

Figure 31
Overtravel distance TB-...M30...-H1147... with TW-L43-43-F-B128

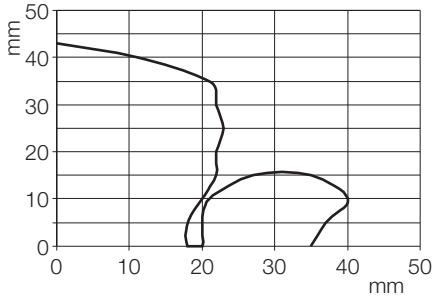

Read-write head TN-...M30...-H1147... overtravel distance with data carrier TW-L82-49-P-B128

Figure 32
Overtravel distance TN-...M30...-H1147... with TW-L82-49-P-B128

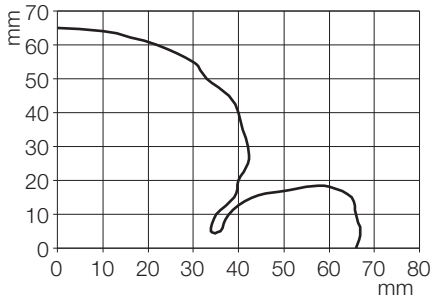

Read-write head TB-...M30...-H1147... overtravel distance with data carrier TW-L82-49-P-B128

Figure 33
Overtravel distance TNB-M30-H1147 with TW-L82-49-P-B128

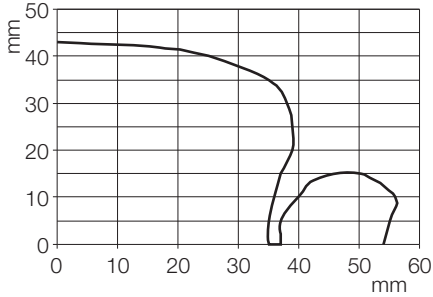

Read-write head TN-CK40-H1147... overtravel distance with data carrier TW-R16-B128

Figure 34
Overtravel distance TN-CK40-H1147... with TW-R16-B128

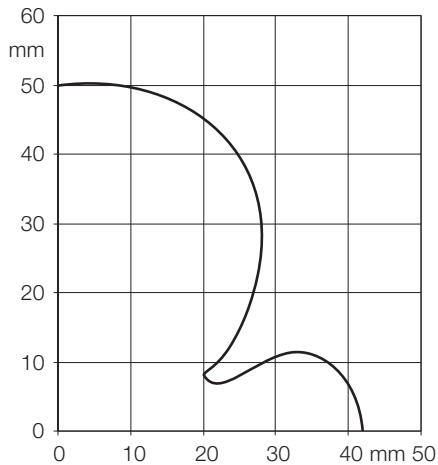

Overtravel ranges

Read-write head TN-CK40-H1147... overtravel distance with data carrier TW-R20-B128

Figure 35
Overtravel
distance TN-
CK40-H1147...
with TW-R20-
B128

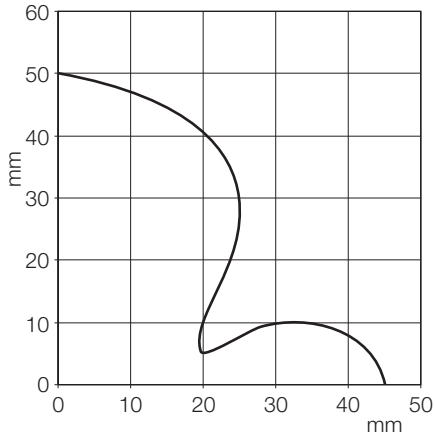

Read-write head TN-CK40-H1147... overtravel distance with data carrier TW-R30-B128

Figure 36
Overtravel
distance TN-
CK40-H1147...
with TW-R30-
B128

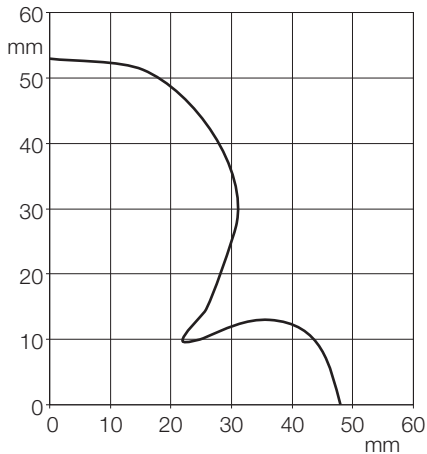

Read-write head TN-CK40-H1147... overtravel distance with data carrier TW-R50-B128

Figure 37
Overtravel
distance TN-
CK40-H1147...
with TW-R50-
B128

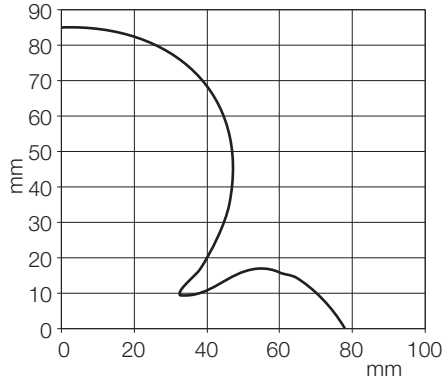

Read-write head TN-CK40-H1147... overtravel distance with data carrier TW-R20-K2

Figure 38
Overtravel
distance TN-
CK40-H1147...
with TW-R20-K2

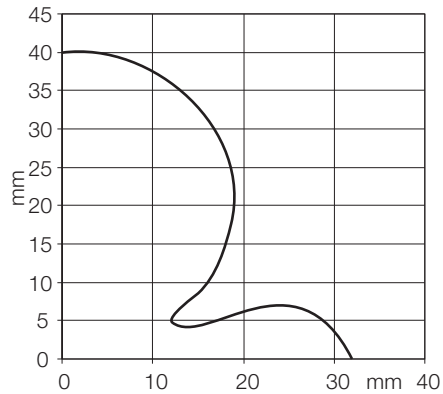

Overtravel ranges

Read-write head TN-CK40-H1147... overtravel distance with data carrier TW-R30-K2

Figure 39
Overtravel
distance TN-
CK40-H1147...
with TW-R30-K2

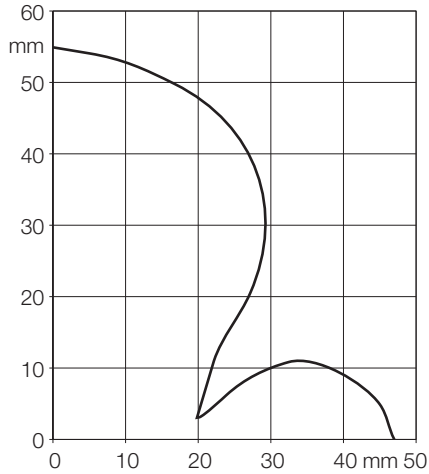

Read-write head TN-CK40-H1147... overtravel distance with data carrier TW-R50-K2

Figure 40
Overtravel
distance TN-
CK40-H1147...
with TW-R50-K2

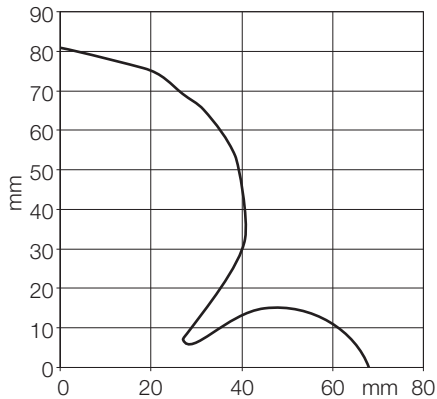

Read-write head TN-CK40-H1147... overtravel distance with data carrier TW-L43-43-F-B128

Figure 41:
Overtravel
distance TN-
CK40-H1147...
with TW-L82-49-
P-B128

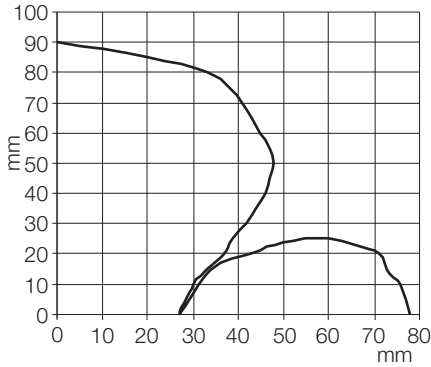

Read-write head TN-CK40-H1147... overtravel distance with data carrier TW-L82-49-P-B128

Figure 42
Overtravel dis-
tance TN-CK40-
H1147... with TW-
L82-49-P-B128

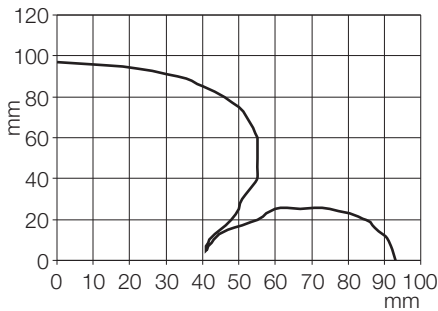

Overtravel ranges

Read-write head TN-Q80-H1147 overtravel distance with data carrier TW-R16-B128

Figure 43
Overtravel
distance TN-Q80-
H1147 with TW-
R16-B128

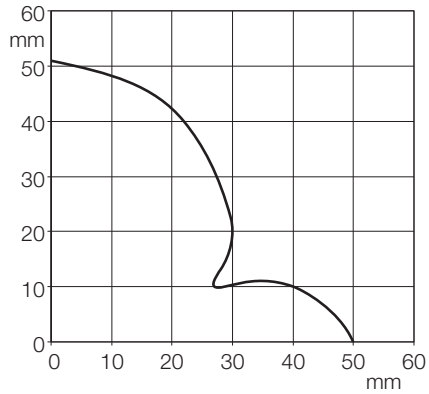

Read-write head TN-Q80-H1147 overtravel distance with data carrier TW-R20-B128

Figure 44
Overtravel
distance TN-Q80-
H1147 with TW-
R20-B128

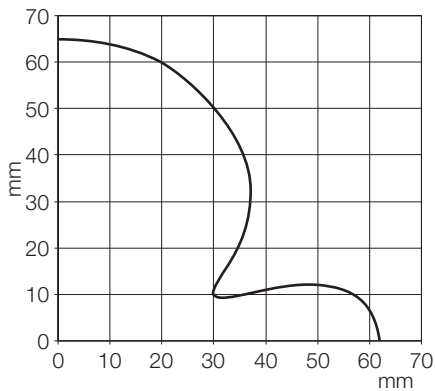

Read-write head TN-Q80-H1147 overtravel distance with data carrier TW-R30-B128

Figure 45
Overtravel
distance TN-Q80-
H1147 with TW-
R30-B128

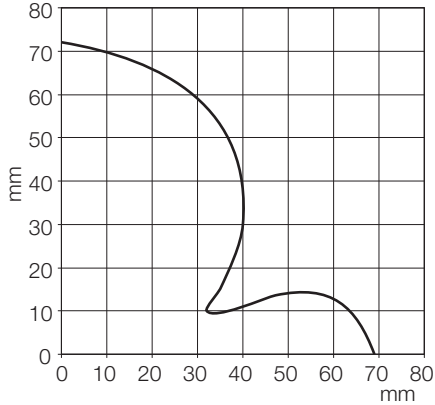

Read-write head TN-Q80-H1147 overtravel distance with data carrier TW-R50-B128

Figure 46
Overtravel
distance TN-Q80-
H1147 with TW-
R50-B128

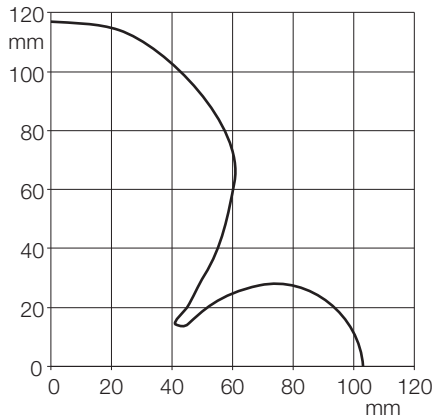

Overtravel ranges

Read-write head TN-Q80-H1147 overtravel distance with data carrier TW-R20-K2

Figure 47
Overtravel
distance TN-Q80-
H1147 with TW-
R20-K2

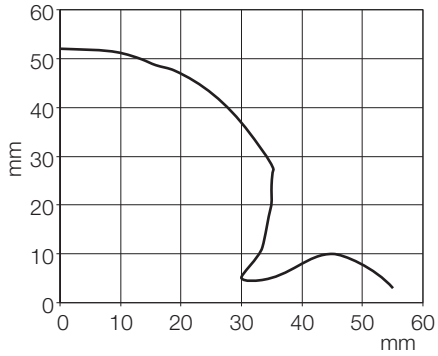

Read-write head TN-Q80-H1147 overtravel distance with data carrier TW-R30-K2

Figure 48
Overtravel
distance TN-Q80-
H1147 with TW-
R30-K2

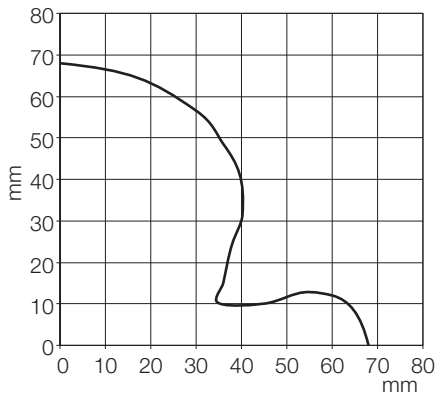

Read-write head TN-Q80-H1147 overtravel distance with data carrier TW-R50-K2

Figure 49
Overtravel
distance TN-Q80-
H1147 with TW-
R50-K2

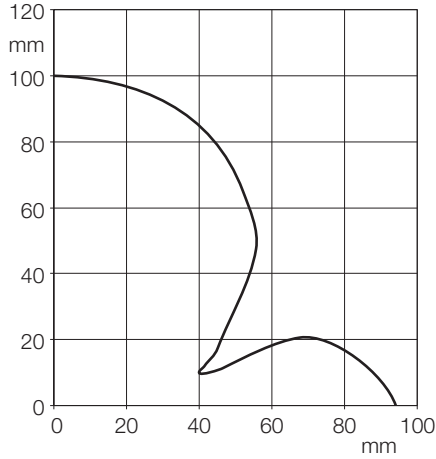

Read-write head TN-Q80-H1147 overtravel distance with data carrier TW-L43-43-F-B128

Figure 50
Overtravel dis-
tance TN-Q80-
H1147 with TW-
L43-43-B128

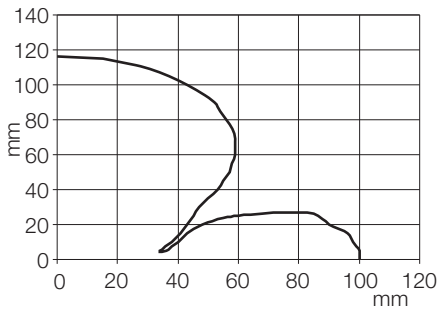

Overtravel ranges

Read-write head TN-Q80-H1147 overtravel distance with data carrier TW-L82-49-P-B128

Figure 51
Overtravel distance TN-Q80-H1147 with TW-L82-49-P-B128

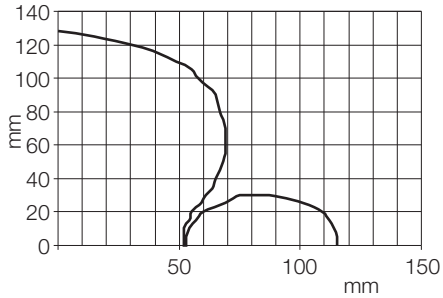

Read-write head TNLR-Q80-H1147 overtravel distance with data carrier TW-R16-B128

Figure 52
Overtravel distance TNLR-Q80-H1147 with TW-R16-B128

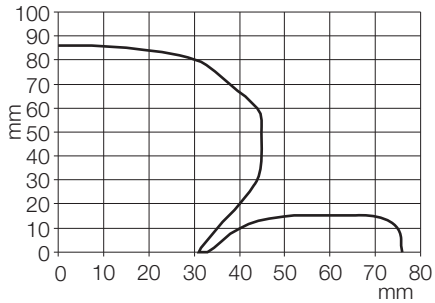

Read-write head TNLR-Q80-H1147 overtravel distance with data carrier TW-R20-B128

Figure 53
Overtravel distance TNLR-Q80-H1147 with TW-R20-B128

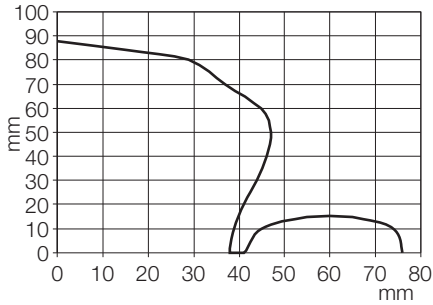

Read-write head TNLR-Q80-H1147 overtravel distance with data carrier TW-R20-K2

Figure 54
Overtravel distance TNLR-Q80-H1147 with TW-R20-K2

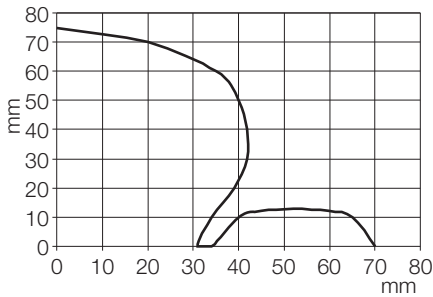

Overtravel ranges

Read-write head TNLR-Q80-H1147 overtravel distance with data carrier TW-R30-B128

Figure 55
Overtravel distance TNLR-Q80-H1147 with TW-R30-B128

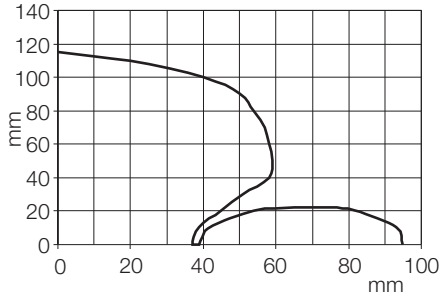

Read-write head TNLR-Q80-H1147 overtravel distance with data carrier TW-R30-K2

Figure 56
Overtravel distance TNLR-Q80-H1147 with TW-R30-K2

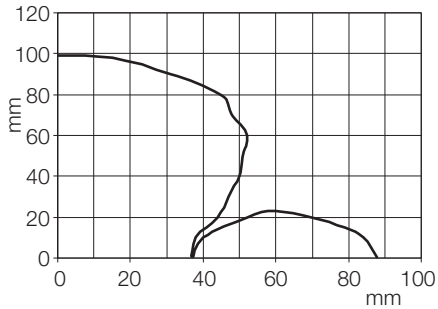

Read-write head TNLR-Q80-H1147 overtravel distance with data carrier TW-R50-B128

Figure 57
Overtravel distance TNLR-Q80-H1147 with TW-R50-B128

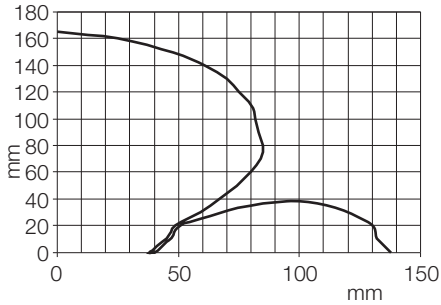

Read-write head TNLR-Q80-H1147 overtravel distance with data carrier TW-R50-K2

Figure 58
Overtravel distance TNLR-Q80-H1147 with TW-R50-K2

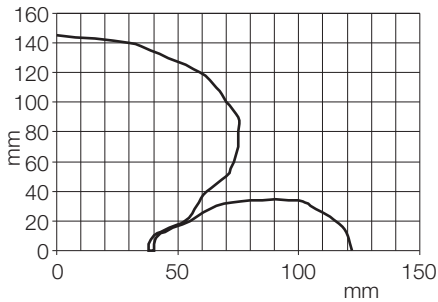

Overtravel ranges

Read-write head TNLR-Q80-H1147 overtravel distance with data carrier TW-L43-43-F-B128

Figure 59
Overtravel distance TNLR-Q80-H1147 with TW-L43-43-F-B128

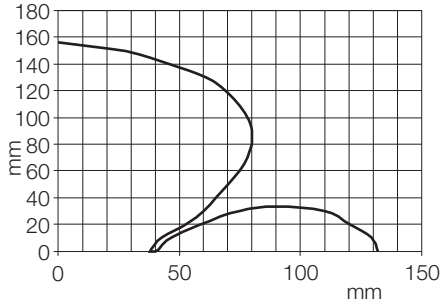

Read-write head TNLR-Q80-H1147 overtravel distance with data carrier TW-L82-49-P-B128

Figure 60
Overtravel distance TNLR-Q80-H1147 with TW-L82-49-P-B128

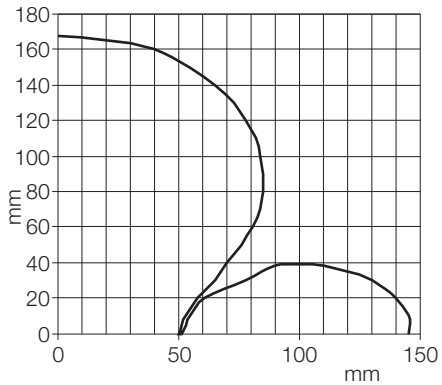

Read-write head TN-S32XL-H1147 overtravel distance with data carrier TW-R16-B128

Figure 61
Overtravel
distance TN-
S32XL-H1147
with TW-R16-
B128

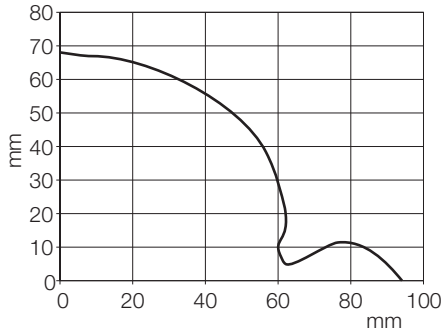

Read-write head TN-S32XL-H1147 overtravel distance with data carrier TW-R30-B128

Figure 62
Overtravel
distance TN-
32XL-H1147 with
TW-R30-B128

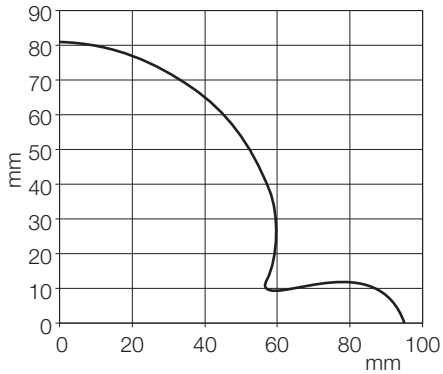

Overtravel ranges

Read-write head TN-S32XL-H1147 overtravel distance with data carrier TW-R50-B128.

Figure 63
Overtravel
distance TN-
S32XL-H1147
with TW-R50-
B128

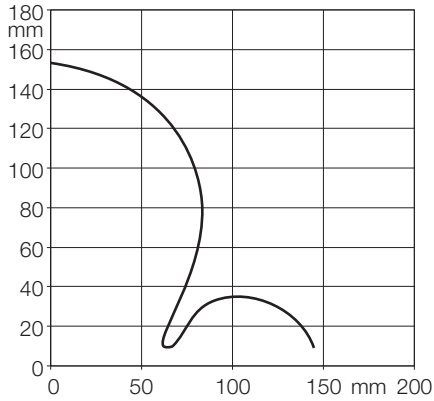

Read-write head TN-S32XL-H1147 overtravel distance with data carrier TW-R30-K2

Figure 64
Overtravel
distance TN-
S32XL-H1147
with TW-R30-K2

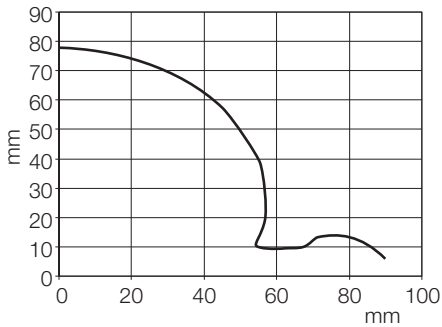

Read-write head TN-S32XL-H1147 overtravel distance with data carrier TW-R50-K2

Figure 65
Overtravel distance TN-S32XL-H1147 with TW-R50-...K2

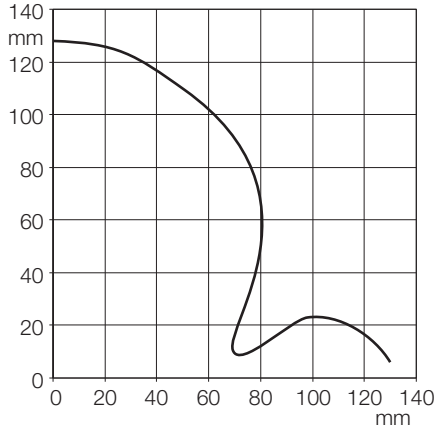

Read-write head TN-S32XL-H1147 overtravel distance with data carrier TW-L43-43-F-B128

Figure 66
Overtravel distance TN-S32XL-H1147 with TW-L43-43-F-B128

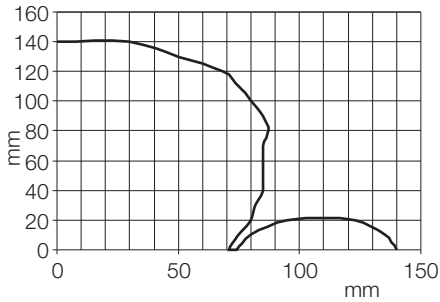

Overtravel ranges

Read-write head TN-S32XL-H1147 overtravel distance with data carrier TW-L82-49-P-B128

Figure 67
Overtravel distance TN-S32XL-H1147 with TW-L82-49-P-B128

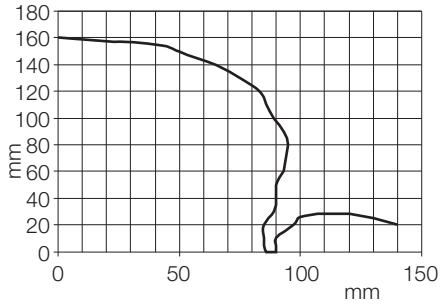

9 Accessories

General description of the accessories.....	2
Accessories for Ø 30 mm and Ø 50 mm data carriers	
Spacer DS-R30	3
Spacer DS-R50	4
Accessories for cylindrical read-write heads of housing style M18	
Mounting clip BS18	5
Mounting clip BSN18	6
Mounting clip with limit stop BST-18B.....	7
Mounting clip without limit stop BST-18N	8
Quick mounting mounts QM-18.....	9
Cover cap SKN/M18	10
Accessories for cylindrical read-write heads of housing style M30	
Mounting clip with limit stop BST-30B.....	11
Mounting clip without limit stop BST-30N	12
Quick mounting mounts QM-30.....	13
Cover cap SKN/M30	14
Common accessories for cylindrical read-write heads of housing style M18 and M30	
Mounting aid for BST mounting clips BST-UH	15
Mounting aid for BST mounting clips BST-UV.....	16
Inscription labels for BST mounting clips BST-BS.....	17
Accessories for rectangular read-write heads of housing style CK40	
Protective mounting MF-CK40-1S.....	18
Protective mounting MF-CK40-2S.....	19
Protective mounting MF-CK40-3S.....	20
Protective housing SG40.....	21
Protective housing SG40/2, temperature resistant	22
Adjustable rail JS 025/037	23
Cover cap T-CK40-T-FC	24
Cover cap T-CK40-D-FC, temperature resistant	25
Handheld with accessories	
PD-ident	26
PD-ident-WLAN.....	27
PD-ident-PF.....	27
PD-ident-DS	27
PD-ident-RB	28
PD-ident-BC.....	28
PD-ident-RS	28
PD-ident-CB.....	28

General description of the accessories

TURCK provides an extensive range of accessories for mounting of the data carriers and for mounting and protection of the read-write heads.

Spacers are used for mounting the Ø 30 mm and Ø 50 mm data carriers.

Suitable mounting clips as well as quick mounting mounts are available for the cylindrical read-write heads M18 x 1 and M30 x 1.5.

The adjustable rail JS 025/037 simplifies the mounting and adjustment of read-write heads for housing style CK40.

Additional protection against mechanical damage is provided by protective mountings, which also simplify mounting of the CK40 housing style.

The computer Handheld PD-ident provides a range of features for location independent writing and reading of all *BL ident* data carriers under Windows CE and is also provided with WLAN and Bluetooth functionality.



Note

Mounting accessories may possibly reduce the read-write distance. Appropriate tests should be undertaken before commissioning.

Accessories for Ø 30 mm and Ø 50 mm data carriers

Spacer DS-R30.

Figure 1
Spacer
DS-R30

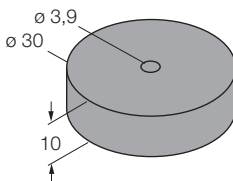

Table 1:
Spacer
DS-R30

Type	DS-R30
Ident-No.	6900512
Description	Spacer for data carrier Ø 30 mm
Material	Plastic

Spacer DS-R50.

Figure 2
Spacer
DS-R50

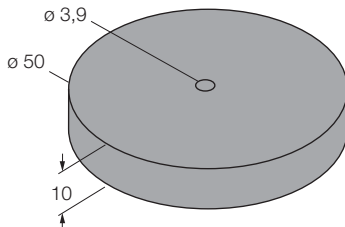

Table 2:
Spacer
DS-R50

Type	DS-R50
Ident-No.	6900386
Description	Spacer for data carrier $\varnothing 50$ mm
Material	Plastic

Accessories for cylindrical read-write heads of housing style M18

Mounting clip BS185

Figure 3
Mounting clip
BS185

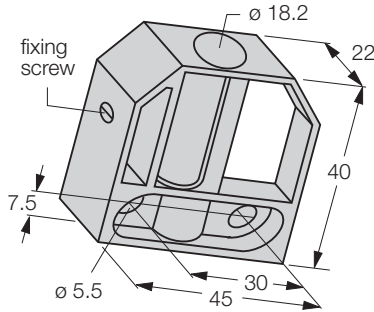

Table 3:
Mounting clip
BS185

Type	BS18
Ident-No.	69471
Description	Mounting clip for cylindrical read-write heads M18 x 1
Material	Polyamide

Mounting clip BSN18

Figure 4
Mounting clip
BSN18

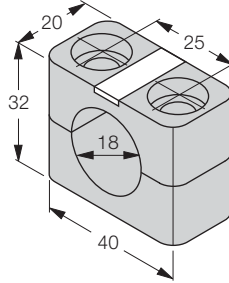

Table 4:
Mounting clip
BSN18

Type	BSN18
Ident-No.	69472
Description	Mounting clip for cylindrical read-write heads M18 x 1
Material	PBT

Mounting clip with limit stop BST-18B

Figure 5
Mounting clip
BST-18B

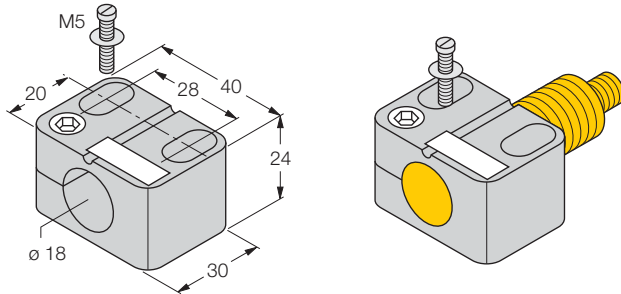

Table 5:
Mounting clip
BST-18B

Type	BST-18B
Ident-No.	6947214
Description	Mounting clip with limit stop for cylindrical read-write heads M18 x 1
Material	Polyamide

Mounting clip without limit stop BST-18N

Figure 6
Mounting clip
BST-18N

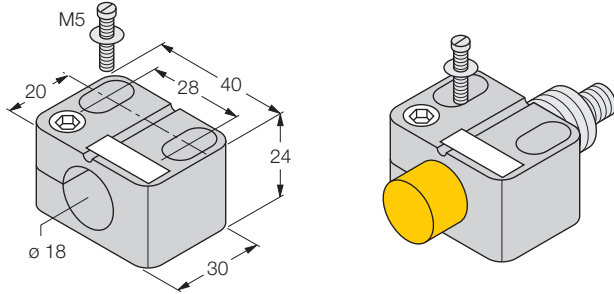

Table 6:
Mounting clip
BST-18N

Type	BST-18N
Ident-No.	6947215
Description	Mounting clip without limit stop for cylindrical read-write heads M18 x 1
Material	Polyamide

Quick mounting mounts QM-18

Figure 7
Quick mounting
mounts QM-18

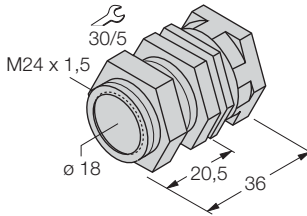

Table 7:
Quick mounting
mounts QM-18

Type	QM-18
Ident-No.	6945102
Description	Quick mounting mounts for cylindrical read-write heads M18 x 1
Material	Chrome-plated brass

Accessories

Cover cap SKN/M18

Figure 8
Cover cap SKN/
M18

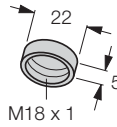

Table 8:
Cover cap SKN/
M18

Type	SKN/M18
Ident-No.	-
Description	Teflon cover cap for cylindrical read-write heads M18 × 1
Material	PTFE

Accessories for cylindrical read-write heads of housing style M30

Mounting clip with limit stop BST-30B

Figure 9
Mounting clip
BST-30B

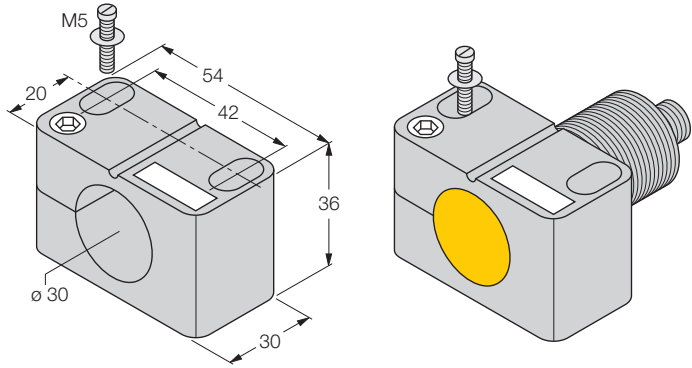

Table 9:
Mounting clip
BST-30B

Type	BST-30B
Ident-No.	6947216
Description	Mounting clip with limit stop for cylindrical read-write heads M30 x 1.5
Material	Polyamide

Mounting clip without limit stop BST-30N

Figure 10
Mounting clip
BST-30N

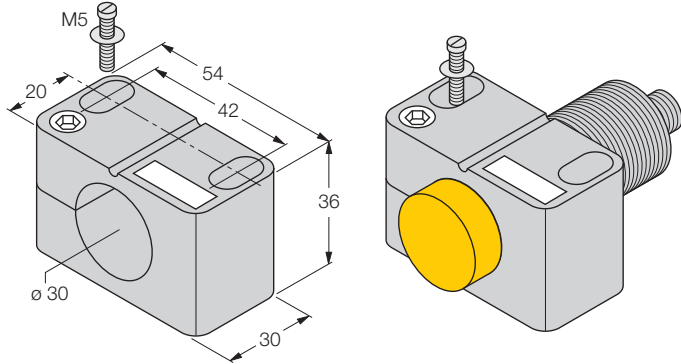

Table 10:
Mounting clip
BST-30N

Type	BST-30N
Ident-No.	6947217
Description	Mounting clip without limit stop for cylindrical read-write heads M30 x 1.5
Material	Polyamide

Quick mounting mounts QM-30

Figure 11
Quick mounting
mounts QM-30

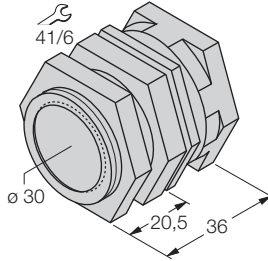

Table 11:
Quick mounting
mounts QM-30

Type	QM-30
Ident-No.	6945103
Description	Quick mounting mounts for cylindrical read-write heads M30 x 1.5
Material	Chrome-plated brass

Accessories

Cover cap SKN/M30

Figure 12
Cover cap SKN/
M30

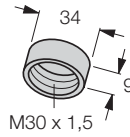

Table 12:
Cover cap SKN/
M30

Type	SKN/M30
Ident-No.	-
Description	Teflon cover cap for cylindrical read-write heads M30 x 1.5
Material	PTFE

Common accessories for cylindrical read-write heads of housing style M18 and M30

Mounting aid for BST mounting clips BST-UH

Figure 13
Mounting aid
BST-UH

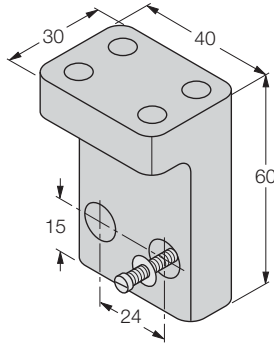

Table 13:
Mounting aid
BST-UH

Type	BST-UH
Ident-No.	6947219
Description	Mounting aid for BST mounting clips for cylindrical read-write heads M18 × 1 and M30 × 1.5
Material	Polyamide

Mounting aid for BST mounting clips BST-UV

Figure 14
Mounting aid
BST-UV

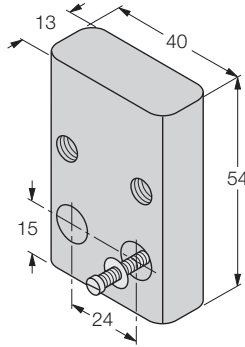

Table 14:
Mounting aid
BST-UV

Type	BST-UV
Ident-No.	6947218
Description	Mounting aid for BST mounting clips for cylindrical read-write heads M18 × 1 and M30 × 1.5
Material	Polyamide

Inscription labels for BST mounting clips BST-BS

Figure 15
Inscription labels
BST-BS

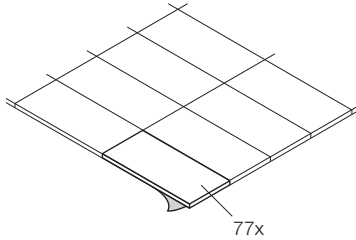

Table 15:
Inscription labels
BST-BS

Type	BST-BS
Ident-No.	6947220
Description	Inscription labels for BST mounting clips for cylindrical read-write heads M18 × 1 and M30 × 1.5
Material	Plastic

Accessories

Accessories for rectangular read-write heads of housing style CK40

Protective mounting MF-CK40-1S

Figure 16
Protective
mounting
MF-CK40-1S

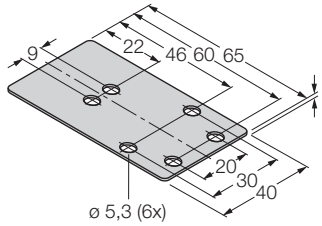

Table 16:
Protective
mounting
MF-CK40-1S

Type	MF-CK40-1S
Ident-No.	6900481
Description	Protective mounting for rectangular read-write heads of housing style CK40 "single sided"
Material	Stainless steel, rust-free

Protective mounting MF-CK40-2S

Figure 17
Protective
mounting
MF-CK40-2S

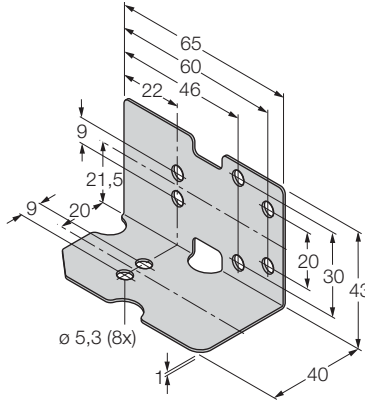

Table 17:
Protective
mounting
MF-CK40-2S

Type	MF-CK40-2S
Ident-No.	6900482
Description	Protective mounting for rectangular read-write heads of housing style CK40 "angled"
Material	Stainless steel, rust-free

Protective mounting MF-CK40-3S

Figure 18
Protective
mounting
MF-CK40-3S

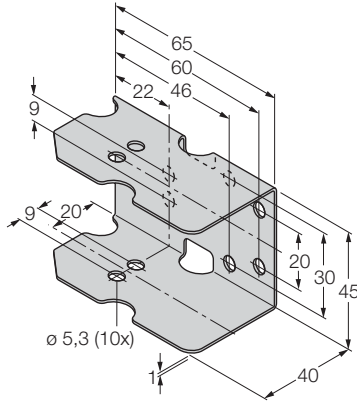

Table 18:
Protective
mounting
MF-CK40-3S

Type	MF-CK40-3S
Ident-No.	6900483
Description	Protective mounting for rectangular read-write heads of housing style CK40 "U-shaped"
Material	Stainless steel, rust-free

Protective housing SG40

Figure 19
Protective housing SG40

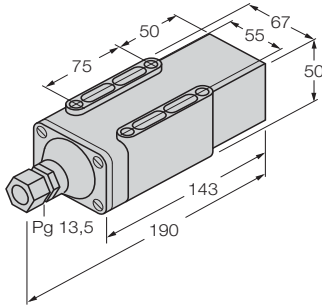

Table 19:
Protective housing SG40

Type	SG40
Ident-No.	69500
Description	Protective housing for rectangular read-write heads of housing style CK40
Material	Polyamide

Protective housing SG40/2

Figure 20
Protective
housing SG40/2

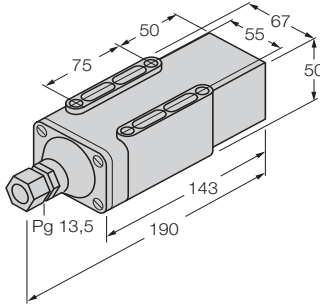

Table 20:
Protective
housing
SG40/2

Type	SG40/2
Ident-No.	69497
Description	Temperature-resistant protective housing for rectangular read-write heads of housing style CK40
Material	Ultem

Adjustable rail JS 025/037

Figure 21
Adjustable rail
JS 025/037

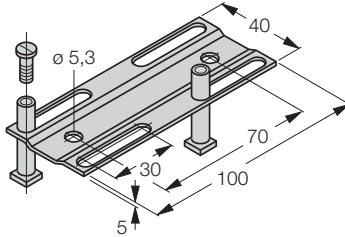

Table 21:
Adjustable rail
JS 025/037

Type	JS 025/037
Ident-No.	69429
Description	Adjustable rail for rectangular read-write heads of housing style CK40
Material	Stainless steel, rust-free

Accessories

Cover cap MF-CK40-1S

Figure 22
Cover cap
T-CK40-T-FC

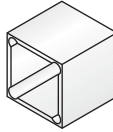

Table 22:
Cover cap
T-CK40-T-FC

Type	T-CK40-T-FC
Ident-No.	6900146
Description	Teflon cover cap for rectangular read-write heads of housing style CK40
Material	PTFE

Cover cap T-CK40-D-FC

Figure 23
Cover cap
T-CK40-D-FC

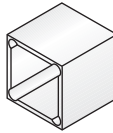

Table 23:
Cover cap
T-CK40-D-FC

Type	T-CK40-D-FC
Ident-No.	6900146
Description	Teflon cover cap for rectangular read-write heads of housing style CK40, high-temperature resistant
Material	Delrin

Accessories

Handheld with accessories

Handheld computer PD-ident

Figure 24
Handheld
computer PD-
ident

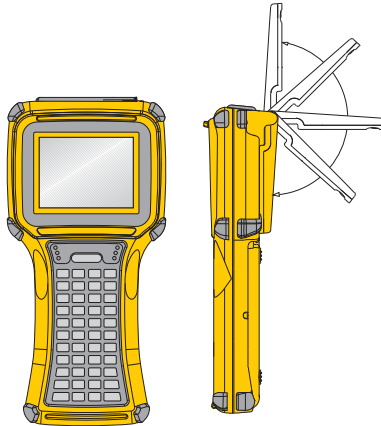

Table 24:
Handheld
computer PD-
ident

Type	PD-ident
Ident-No.	1542331
Description	Location-independent reading and writing of all TURCK data carriers Windows CE Lit touch screen Protection degree IP54, opt. IP65 Programming device (handheld) Display in decimal, binary, hexadecimal and ASCII code Definition of password protected areas possible Automatic reading of data carriers incl. docking station

Handheld computer PS-ident-WLAN with WLAN functionality

<i>Table 25: Handheld computer PD- ident-WLAN</i>	Type	PD-ident-WLAN
	Ident-No.	1542340
	Description	Same features as PD-ident additionally with WLAN and Bluetooth functionality

Handheld accessories

<i>Table 26: Handheld computer PD- ident-PF</i>	Type	PD-ident-PF
	Ident-No.	1542336
	Description	Display protective file (25 pieces)

<i>Table 27: Handheld computer PD- ident-DS</i>	Type	PD-ident-DS
	Ident-No.	1542333
	Description	Docking station, incl. power supply, RS232 cable

Accessories

Table 28:
Handheld
computer PD-
ident-RB

Type	PD-ident-RB
Ident-No.	1542337
Description	Spare rechargeable battery

Table 29:
Handheld
computer PD-
ident-BC

Type	PD-ident-BC
Ident-No.	1542335
Description	Rechargeable battery charger

Table 30:
Handheld
computer PD-
ident-RS

Type	PD-ident-RS
Ident-No.	1542338
Description	Spare pins (25 pieces)

Table 31:
Handheld
computer PD-
ident-CB

Type	PD-ident-CB
Ident-No.	1542334
Description	Pouch holder

TURCK

**Industrial
Automation**

TURCK WORLD-WIDE HEADQUARTERS

GERMANY

Hans Turck GmbH & Co. KG
Witzlebenstraße 7
45472 Mülheim an der Ruhr
P. O. Box 45466 Mülheim an der Ruhr
Phone +49 208 4952-0
Fax +49 208 4952-2 64
E-Mail more@turck.com

www.turck.com

D101583 0207



Irrtümer und Änderungen vorbehalten