

Königswinkel 10
32825 Blomberg
Germany
Phone +49 5235 9500-0
Fax +49 5235 9500-10

Test Report

Report Number: F135060E3

Applicant:

Werner Turck GmbH & Co. KG

Manufacturer:

Hans Turck GmbH & Co. KG

Equipment under Test (EUT):

RFID Reader

TN-M30-H1147



Laboratory (CAB) accredited by
Deutsche Akkreditierungsstelle GmbH (DAkkS)
in compliance with DIN EN ISO/IEC 17025
under the Reg. No. D-PL-17186-01-02,
FCC Test site registration number 90877 and
Industry Canada Test site registration IC3469A-1

REFERENCES

[1] **ANSI C63.4:2009** American National Standard for Methods of Measuring of Radio-Noise Emissions from Low-Voltage Electrical and Electronic Equipment in the Range of 9 kHz to 40 GHz.

[2] **FCC 47 CFR Part 15** Radio Frequency Devices

TEST RESULT

The requirements of the tests performed as shown in the overview (chapter 4 of this test report) were fulfilled by the equipment under test.

The complete test results are presented in the following.

Test engineer:	Manuel BASTERT		27 May 2015
	_____ Name	_____ Signature	_____ Date
Authorized reviewer:	Bernd SELCK		27 May 2015
	_____ Name	_____ Signature	_____ Date

RESERVATION

This test report is only valid in its original form.

Any reproduction of its contents in extracts without written permission of the accredited test laboratory PHOENIX TESTLAB GmbH is prohibited.

The test results herein refer only to the tested sample. PHOENIX TESTLAB GmbH is not responsible for any generalisations or conclusions drawn from these test results concerning further samples. Any modification of the tested samples is prohibited and leads to the invalidity of this test report. Each page necessarily contains the PHOENIX TESTLAB Logo and the TEST REPORT NUMBER.

Contents:	Page
1 Identification	4
1.1 Applicant.....	4
1.2 Manufacturer.....	4
1.3 Test laboratory.....	4
1.4 EUT (equipment Under Test)	5
1.5 Technical data of equipment	5
1.6 Ancillary equipment used for test:	5
1.7 Dates	5
2 Operational states and physical boundaries	6
3 Additional information	6
4 Overview	6
5 Test results	7
5.1 Spectrum mask.....	7
5.1.1 Method of measurement	7
5.1.2 Test results	8
5.2 20 dB Bandwidth.....	9
5.2.1 Method of measurement	9
5.2.2 Test results	10
5.3 Frequency tolerance	11
5.3.1 Method of measurement	11
5.3.2 Test results	12
5.4 Conducted emissions on power supply line	13
5.4.1 Method of measurement	13
5.4.2 Test results	14
5.5 Radiated emissions.....	16
5.5.1 Method of measurement	16
5.5.2 Preliminary radiated emission tests	23
5.5.3 Final radiated emission tests	26
6 Test equipment and ancillaries used for tests.....	29
7 Report history	30
8 List of annexes	30

1 Identification

1.1 Applicant

Name:	Werner Turck GmbH & Co. KG
Address:	Goethestr. 7 58553 Halver
Country:	Germany
Name for contact purposes:	Mr. Markus TEUBNER
Tel:	+49 (0) 2353 / 709-6124
Fax:	+49 (0) 2353 / 709-6174
e-mail address:	Markus.Teubner@Turck.com

1.2 Manufacturer

Name:	Hans Turck GmbH & Co. KG
Address:	Witzlebenstr. 7 45472 Mülheim an der Ruhr
Country:	Germany
Name for contact purposes:	Mr. Markus TEUBNER
Tel:	+49 (0) 2353 / 709-6124
Fax:	+49 (0) 2353 / 709-6174
e-mail address:	Markus.Teubner@Turck.com

1.3 Test laboratory

The tests were carried out at: **PHOENIX TESTLAB GmbH**
Königswinkel 10
32825 Blomberg
Germany

Test Laboratory (CAB) accredited by Deutsche Akkreditierungsstelle GmbH (DAkS) in compliance with DIN EN ISO/IEC 17025 under the Reg. No. D-PL-17186-01-02, recognized by Bundesnetzagentur under the Reg.-No. BNetzA-CAB-02/21-104. CAB Designation Number DE0004, listed by FCC 31040/SIT1300F2, IC OATS Listing 3469A-1.

1.4 EUT (Equipment Under Test)

Type of equipment:	RFID transceiver
HVIN / model name:	TN-M30-H1147
Serial No.:	None (Engineering sample)
FCC ID:	YQ7-TNM30

1.5 Technical data of equipment

Power supply: *	DC		
Supply voltage: *	U _{nom} = 24 V	U _{min} = 10 V	U _{max} = 30 V
Type of modulation: *	ASK		
Frequency deviation: *	± 7 kHz		
Operating frequency range: *	13.56 MHz		
Number of channels: *	1		
Antenna type: *	Internal loop antenna		
Antenna area: *	32.2 cm ²		
Duty cycle: *	100%		
Rated RF power: *	< 250 mW		
Data rate: *	26.48 kbaud		
Lowest internal frequency: *	13.56 MHz		
Highest internal frequency: *	13.56 MHz		
Temperature range: *	-25 to 70 °C (-13 to 158 °F)		

* declared by the applicant.

1.6 Ancillary equipment used for test:

Turck Gateway BL67 (consisting of PG-DP, 2RFID-S and 8XSG-PD).

1.7 Dates

Date of receipt of test sample:	06 November 2013
Start of test:	18 November 2013
End of test:	27 March 2014

2 Operational states and physical boundaries

If not otherwise stated the EUT was powered with 24 V_{DC} by an external power supply. A test mode was implemented which set the EUT in a continuous tag authentication. An LED at an ancillary monitoring device indicates successful data communication. The equipment is shown in the following pictures.

3 Additional information

None.

4 Overview

Application	Frequency range [MHz]	FCC 47 CFR Part 15 section [2]	Status	Refer page
Radiated emissions	13.110 to 14.110	15.225 (a) – (d)	Passed	7 et seq.
20 dB bandwidth	13.560	15.215 (c)	Passed	9 et seq.
Frequency tolerance	13.560	15.225 (e)	Passed	11 et seq.
Conducted emissions on power supply lines	0.015 - 30	15.207 (a)	Passed	13 et seq.
Radiated emissions	0.009 - 1,000	15.205 (a) 15.209 (a)	Passed	16 et seq.

5 Test results

5.1 Spectrum mask

5.1.1 Method of measurement

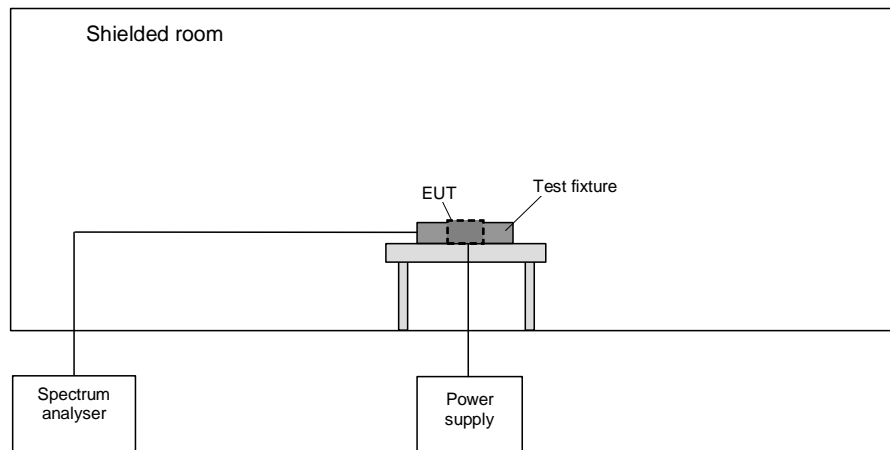

The following procedure will be used for the spectrum mask measurement:

- 1) Place the EUT in the test fixture and switch it on.
- 2) Use the following spectrum analyser settings: $RWB = VBW = 1 \text{ kHz}$, $\text{Span} = \text{wide enough to capture the whole } 13 \text{ MHz band including the frequency ranges where the limit [2] applies}$, $\text{Trace mode} = \text{MaxHold}$, select the limit line. The bandwidth usually has to be 10 kHz for the measurement [1]. Because a measurement with this bandwidth results into an envelope, which is too wide for the 14 kHz spectrum mask, the bandwidth was reduced. The amplitude was determined using the 10 kHz bandwidth.
- 3) After trace stabilisation, set the marker to the signal peak.
- 4) The Reference level will be calculated by the amount of the margin of the wanted signal to its 30 m emission limit plus the marker value.
- 5) The whole signal trace has to be below the limit line.

5.1.2 Test results

Ambient temperature	21 °C	Relative humidity	55 %
---------------------	-------	-------------------	------

Supply voltage: The EUT was supplied with 24 V_{DC}.

Test record: The test was carried out while the EUT was reading an TAG.

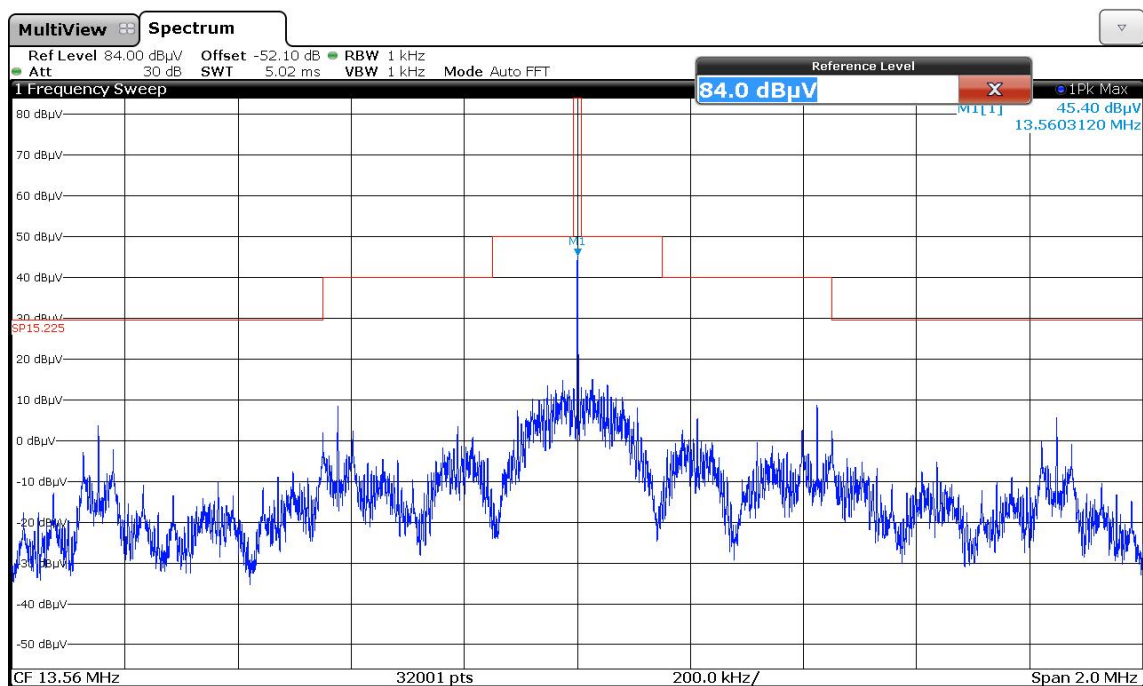

135060TNM30SM.png: Spectrum mask

Test result: Passed

Test equipment used (see chapter 6)

19 – 21

5.2 20 dB Bandwidth

5.2.1 Method of measurement

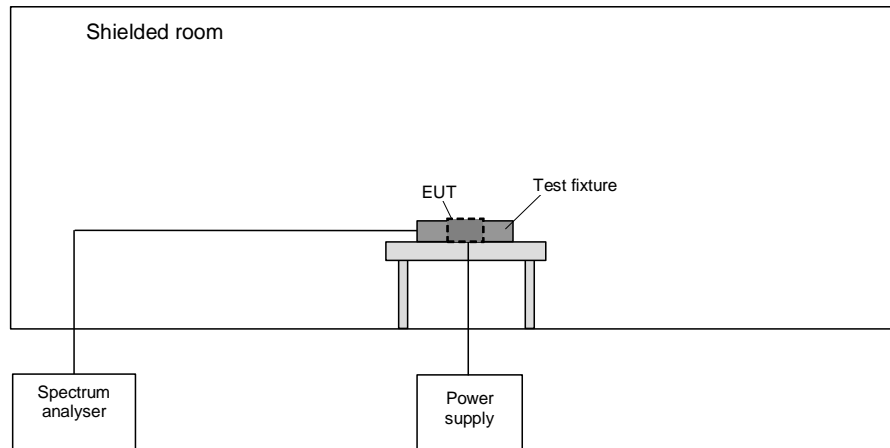

The following procedure will be used for the occupied bandwidth measurement [1]:

- 1) Place the EUT in the test fixture and switch it on.
- 2) Use the following spectrum analyser settings: RWB = VBW = 10 kHz, Span = wide enough to capture app. 1.5 times the 20 dB bandwidth, Trace mode = MaxHold.
- 3) After trace stabilisation, set the first marker and the first display line to the signal peak. Set the second display line 20 dB below the first display line. The second marker and its delta marker shall be set to cross points of the spectrum line and the second display line and note these frequencies.
- 4) Alternatively the 20 dB down function of the analyser could be used, if this function will be applicable to the displayed spectrum.

5.2.2 Test results

Ambient temperature	21 °C	Relative humidity	55 %
---------------------	-------	-------------------	------

Supply voltage: The EUT was supplied with 24 V_{DC}.

Test record: The test was carried out while the EUT was reading a tag.

135060TN20DB.wmf: 20 dB Bandwidth:

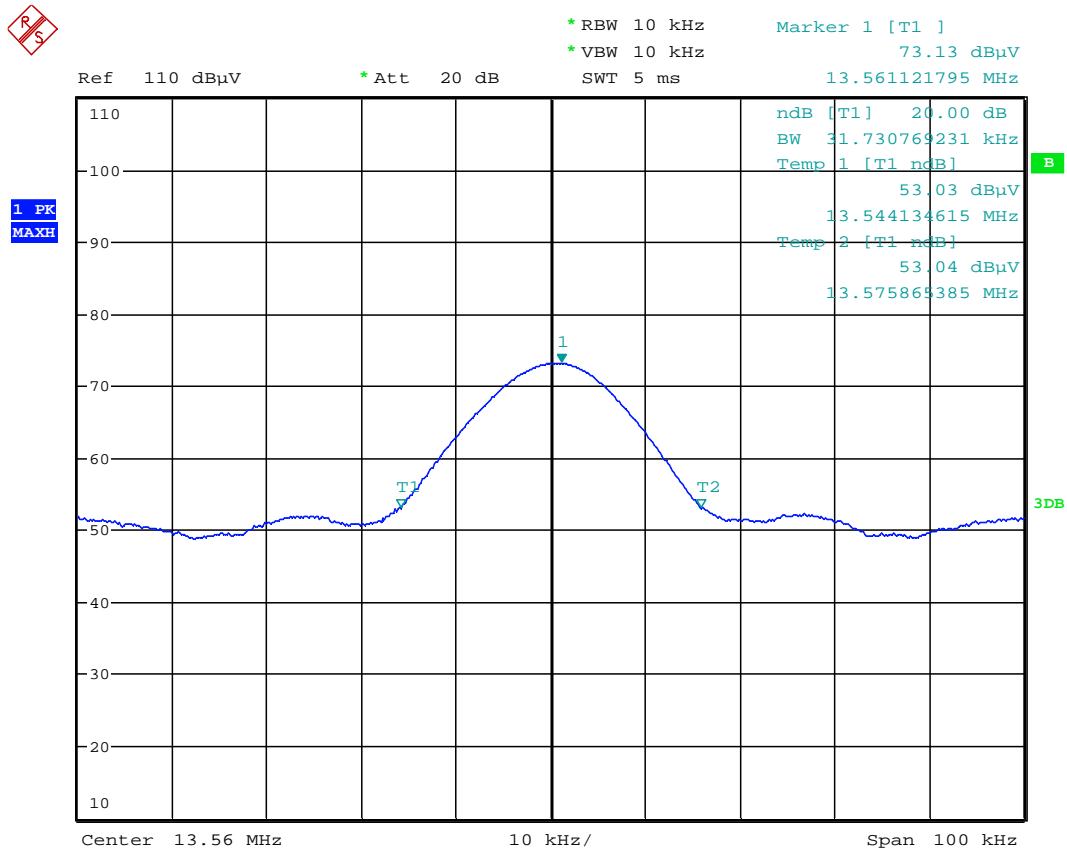

f _L	f _U	BW (f _U - f _L)
13.544 MHz	13.576 MHz	32 kHz
Measurement uncertainty		< ± 1*10 ⁻⁷

Test result: Passed.

Test equipment used (see chapter 6)

10, 21, 22

5.3 Frequency tolerance

5.3.1 Method of measurement

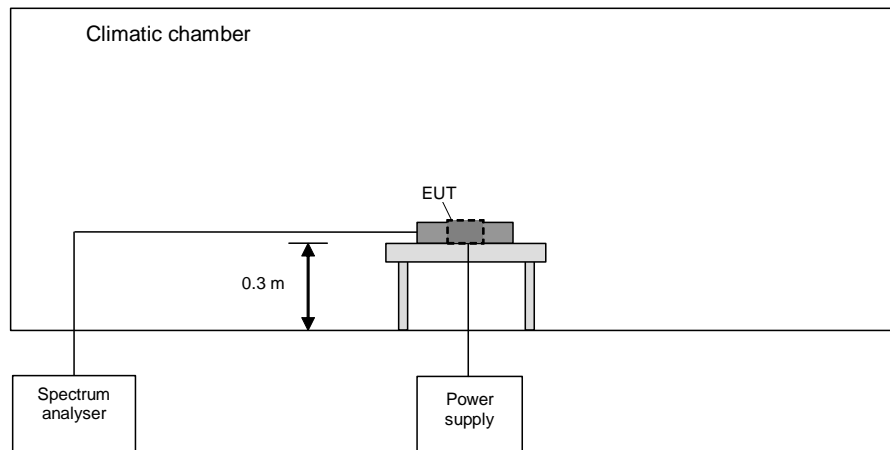

The following procedure will be used [1]:

- 1) Place the EUT in the climatic chamber.
- 2) Switch on the EUT and check the correct function and the settings of the spectrum analyser.
- 3) Switch off the EUT and tune the climatic chamber to a temperature of 50 °C. Wait until the thermal balance is obtained.
- 4) Switch the EUT on and record the frequencies at start-up and 2, 5 and 10 minutes after powering on.
- 5) Repeat 4) with the minimum and the maximum of the supply voltage.
- 6) Switch off the EUT and tune the climatic chamber to a temperature range of 50 °C to –20 °C to in ten-degree steps. Wait until the thermal balance is obtained for every step.
- 7) Switch the EUT on and record the frequencies at start-up and 2, 5 and 10 minutes after powering on.
- 8) Repeat 7) with the minimum and the maximum of the supply voltage at 20 °C.
- 9) Repeat 6) with the next temperature step until –20 °C were reached.

5.3.2 Test results

Ambient temperature	21 °C	Relative humidity	55 %
---------------------	-------	-------------------	------

Test set-up: For this test the EUT was fixed on a wooden table inside the climatic chamber.

Cable guide: For further information of the cable guide refer to the pictures in annex A of this test report.

Temperature	Supply voltage	Minutes after switch on [min]	Frequency	Allowed tolerance	Measured tolerance	Result
70 °C	24 V _{DC}	0	13.560325 MHz	±1.356kHz	100 Hz	Passed
		2	13.560325 MHz	±1.356kHz	100 Hz	Passed
		5	13.560275 MHz	±1.356kHz	50 Hz	Passed
		10	13.560275 MHz	±1.356kHz	50 Hz	Passed
60 °C	24 V _{DC}	0	13.560325 MHz	±1.356kHz	100 Hz	Passed
		2	13.560275 MHz	±1.356kHz	50 Hz	Passed
		5	13.560275 MHz	±1.356kHz	50 Hz	Passed
		10	13.560275 MHz	±1.356kHz	50 Hz	Passed
50 °C	24 V _{DC}	0	13.560225 MHz	±1.356kHz	0 Hz	Passed
		2	13.560200 MHz	±1.356kHz	-25 Hz	Passed
		5	13.560225 MHz	±1.356kHz	0 Hz	Passed
		10	13.560225 MHz	±1.356kHz	0 Hz	Passed
40 °C	24 V _{DC}	0	13.560225 MHz	±1.356kHz	0 Hz	Passed
		2	13.560200 MHz	±1.356kHz	-25 Hz	Passed
		5	13.560200 MHz	±1.356kHz	-25 Hz	Passed
		10	13.560225 MHz	±1.356kHz	0 Hz	Passed
30 °C	24 V _{DC}	0	13.560275 MHz	±1.356kHz	50 Hz	Passed
		2	13.560225 MHz	±1.356kHz	0 Hz	Passed
		5	13.560200 MHz	±1.356kHz	-25 Hz	Passed
		10	13.560200 MHz	±1.356kHz	-25 Hz	Passed
20 °C	10 V _{DC}	0	13.560225 MHz	±1.356kHz	0 Hz	Passed
	24 V _{DC}		13.560225 MHz	±1.356kHz	0 Hz	Passed
	30 V _{DC}		13.560200 MHz	±1.356kHz	-25 Hz	Passed
10 °C	24 V _{DC}	0	13.560300 MHz	±1.356kHz	75 Hz	Passed
		2	13.560275 MHz	±1.356kHz	50 Hz	Passed
		5	13.560250 MHz	±1.356kHz	25 Hz	Passed
		10	13.560225 MHz	±1.356kHz	0 Hz	Passed
0 °C	24 V _{DC}	0	13.560300 MHz	±1.356kHz	75 Hz	Passed
		2	13.560300 MHz	±1.356kHz	75 Hz	Passed
		5	13.560275 MHz	±1.356kHz	50 Hz	Passed
		10	13.560275 MHz	±1.356kHz	50 Hz	Passed
-10 °C	24 V _{DC}	0	13.560300 MHz	±1.356kHz	75 Hz	Passed
		2	13.560300 MHz	±1.356kHz	75 Hz	Passed
		5	13.560275 MHz	±1.356kHz	50 Hz	Passed
		10	13.560275 MHz	±1.356kHz	50 Hz	Passed
-20 °C	24 V _{DC}	0	13.560150 MHz	±1.356kHz	-75 Hz	Passed
		2	13.560225 MHz	±1.356kHz	0 Hz	Passed
		5	13.560225 MHz	±1.356kHz	0 Hz	Passed
		10	13.560225 MHz	±1.356kHz	0 Hz	Passed
-25 °C	24 V _{DC}	0	13.560125 MHz	±1.356kHz	-100 Hz	Passed
		2	13.560175 MHz	±1.356kHz	-50 Hz	Passed
		5	13.560200 MHz	±1.356kHz	-25 Hz	Passed
		10	13.560200 MHz	±1.356kHz	-25 Hz	Passed
Measurement uncertainty				< ± 1*10 ⁻⁷		

Test result: Passed

Test equipment used (see chapter 6)

19 – 21

5.4 Conducted emissions on power supply line

5.4.1 Method of measurement

This test will be carried out in a shielded chamber. Tabletop devices will set up on a non-conducting support with a size of 1 m by 1.5 m and a height of 80 cm above the ground plane. Floor-standing devices will be placed directly on the ground plane. The setup of the Equipment under Test will be in accordance to [1].

The frequency range 150 kHz to 30 MHz will be measured with an EMI Receiver set to MAX Hold mode with peak and average detector and a resolution bandwidth of 9 kHz. A scan will be carried out on the phase (or plus pole in case of DC powered devices) of the AC mains network. If levels detected 10 dB below the appropriate limit, this emission will be measured with the average and quasi-peak detector on all lines.

Frequency range	Resolution bandwidth
150 kHz to 30 MHz	9 kHz

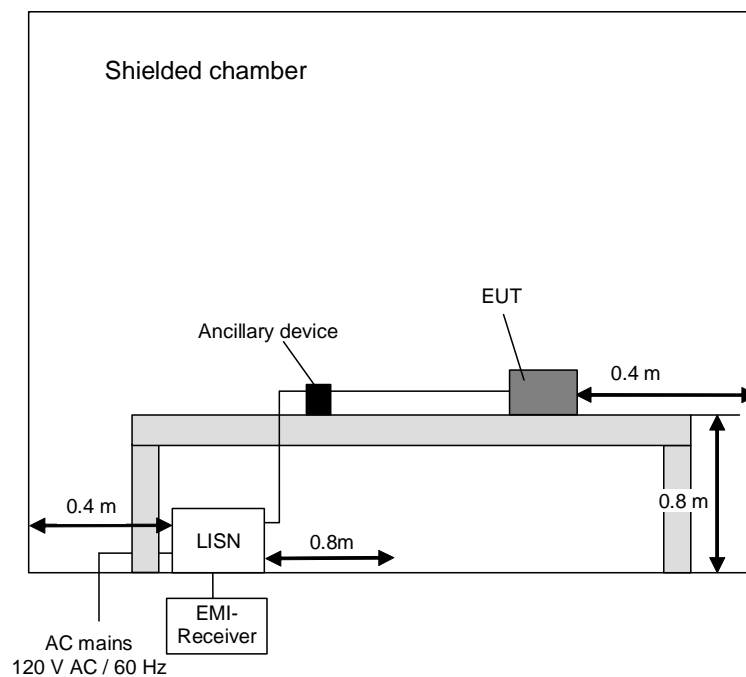

5.4.2 Test results

Ambient temperature:	20 °C	Relative humidity:	45 %
----------------------	-------	--------------------	------

Position of EUT:	The EUT was set-up on a wooden table of a height of 0.8 m.
Cable guide:	The cable of the EUT was fixed on the wooden table. For further information of the cable guide refer to the pictures in annex A of this test report.
Test record:	The test was carried out in normal operation mode of the EUT (reading a TAG). All results are shown in the following.
Power supply:	During this test the EUT was powered with 24 V _{DC} by the ancillary monitoring device which was itself supplied with 120 V _{AC} / 60 Hz.

The curves in the diagram only represent for each frequency point the maximum measured value of all preliminary measurements which were made for each power supply line. The top measured curve represents the peak measurement and the bottom measured curve the average measurement. The quasi-peak measured points are marked by “x” and the average measured points by “+”.

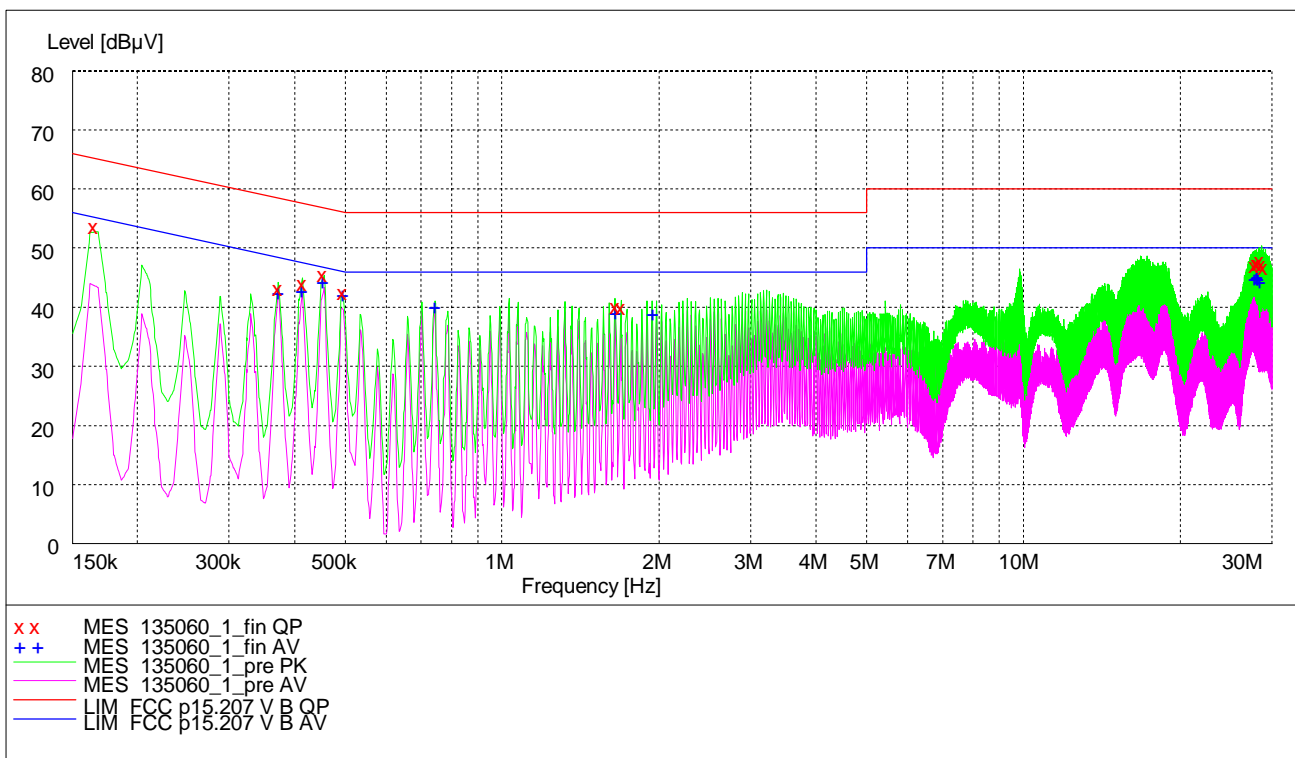

Result measured with the quasipeak detector (marked by an x):

Frequency MHz	Level dB μ V	Transducer dB	Limit dB μ V	Margin dB	Line	PE
0.164400	54.30	1.4	65.2	11.0	N	FLO
0.371400	43.80	0.9	58.5	14.7	L1	GND
0.412800	44.50	0.9	57.6	13.1	L1	FLO
0.453300	46.20	0.9	56.8	10.6	N	GND
0.494700	43.10	0.8	56.1	13.0	L1	FLO
1.649400	40.70	0.7	56.0	15.3	L1	FLO
1.689900	40.60	0.7	56.0	15.4	L1	FLO
28.040100	47.60	3.1	60.0	12.4	N	FLO
28.286700	47.90	3.1	60.0	12.1	N	GND
28.369500	48.00	3.1	60.0	12.0	L1	GND
28.410900	47.90	3.1	60.0	12.1	N	GND
28.660200	48.50	3.2	60.0	11.5	L1	GND
28.905900	47.80	3.3	60.0	12.2	L1	GND
29.151600	47.30	3.3	60.0	12.7	L1	FLO

Result measured with the average detector (marked by a +):

Frequency MHz	Level dB μ V	Transducer dB	Limit dB μ V	Margin dB	Line	PE
0.371400	43.20	0.9	48.5	5.3	L1	GND
0.411900	43.50	0.9	47.6	4.1	L1	FLO
0.453300	44.90	0.9	46.8	1.9	N	GND
0.494700	42.70	0.8	46.1	3.4	L1	GND
0.742200	40.80	0.8	46.0	5.2	L1	GND
1.649400	39.70	0.7	46.0	6.3	L1	GND
1.937400	39.40	0.7	46.0	6.6	L1	FLO
28.040100	45.50	3.1	50.0	4.5	L1	FLO
28.286700	45.60	3.1	50.0	4.4	L1	GND
28.327200	45.50	3.1	50.0	4.5	L1	GND
28.369500	45.70	3.1	50.0	4.3	L1	FLO
28.410900	45.50	3.1	50.0	4.5	N	FLO
28.452300	45.40	3.1	50.0	4.6	L1	FLO
28.659300	44.90	3.2	50.0	5.1	L1	FLO

Test: Passed

Test equipment used (see chapter 6)

23 - 27

5.5 Radiated emissions

5.5.1 Method of measurement

The radiated emission measurement is subdivided into five stages.

- A preliminary measurement carried out in a fully anechoic chamber with a fixed antenna height in the frequency range 9 kHz to 1 GHz.
- A final measurement carried out on an outdoor test side without reflecting ground plane and a fixed antenna height in the frequency range 9 kHz to 30 MHz.
- A final measurement carried out on an open area test side with reflecting ground plane and various antenna height in the frequency range 30 MHz to 1 GHz.
- A preliminary measurement carried out in a fully anechoic chamber with a variable antenna distance and height in the frequency range 1 GHz to 110 GHz.
- A final measurement carried out in a fully anechoic chamber with a fixed antenna height in the frequency range 1 GHz to 110 GHz.

All measurements will be carried out with the EUT working on the middle and upper and lower edge of the assigned frequency band.

Preliminary measurement (9 kHz to 30 MHz):

In the first stage a preliminary measurement will be performed in a shielded room with a measuring distance of 3 meters. Tabletop devices will set up on a non-conducting support with a size of 1 m by 1.5 m and a height of 80 cm. Floor-standing devices will be placed directly on the turntable/ground plane. The setup of the Equipment under test will be in accordance to [1].

The frequency range 9 kHz to 30 MHz will be monitored with a spectrum analyser while the system and its cables will be manipulated to find out the configuration with the maximum emission levels if applicable. The EMI Receiver will be set to MAX Hold mode. The EUT and the measuring antenna will be rotated around their vertical axis to found the maximum emissions.

The resolution bandwidth of the spectrum analyser will be set to the following values:

Frequency range	Resolution bandwidth
9 kHz to 150 kHz	200 Hz
150 kHz to 30 MHz	10 kHz

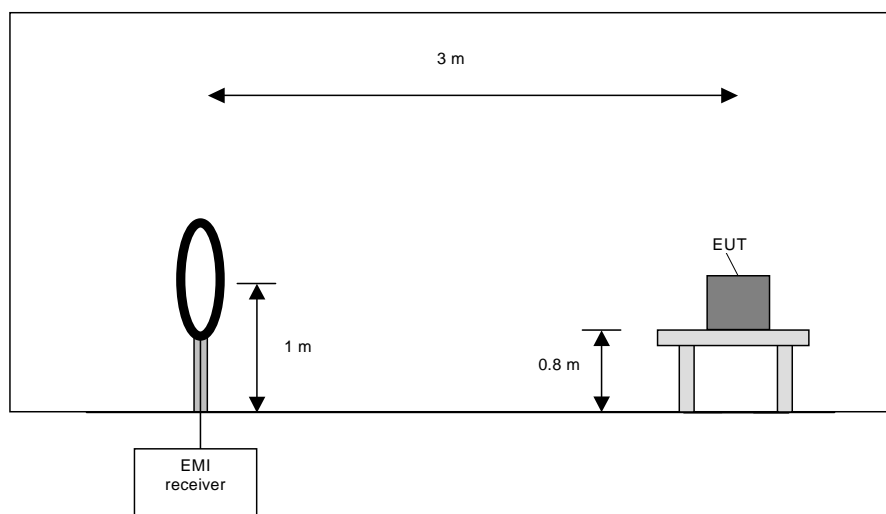

Preliminary measurement procedure:

Prescans were performed in the frequency range 9 kHz to 150 kHz and 150 kHz to 30 MHz.

The following procedure will be used:

- 1) Monitor the frequency range at horizontal polarisation and a EUT azimuth of 0 °.
- 2) Manipulate the system cables within the range to produce the maximum level of emission.
- 3) Rotate the EUT by 360 ° to maximize the detected signals.
- 4) Make a hardcopy of the spectrum.
- 5) Measure the frequencies of highest detected emission with a lower span and resolution bandwidth to increase the accuracy and note the frequency value.
- 6) Repeat steps 1) to 5) with the other orthogonal axes of the EUT (only if the EUT is a module or is used in a handheld application).
- 7) Rotate the measuring antenna and repeat steps 1) to 5).

Final measurement (9 kHz to 30 MHz):

In the second stage a final measurement will be performed on an open area test site with no conducting ground plane in a measuring distances of 3 m, 10 m and 30 m whichever is appropriate. In the case where larger measuring distances are required the results will be extrapolated based on the values measured on the closer distances according to [2]. The final measurement will be performed with a EMI Receiver set to Quasi Peak detector except for the frequency bands 9 kHz to 90 kHz and 110 kHz to 490 kHz where an average detector will be used according to [2].

On the during the preliminary measurement detected frequencies the final measurement will be performed while rotating the EUT and the measuring antenna in the range of 0 ° to 360 ° around their vertical axis until the maximum value is found.

The resolution bandwidth of the EMI Receiver will be set to the following values:

Frequency range	Resolution bandwidth
9 kHz to 150 kHz	200 Hz
150 kHz to 30 MHz	9 kHz

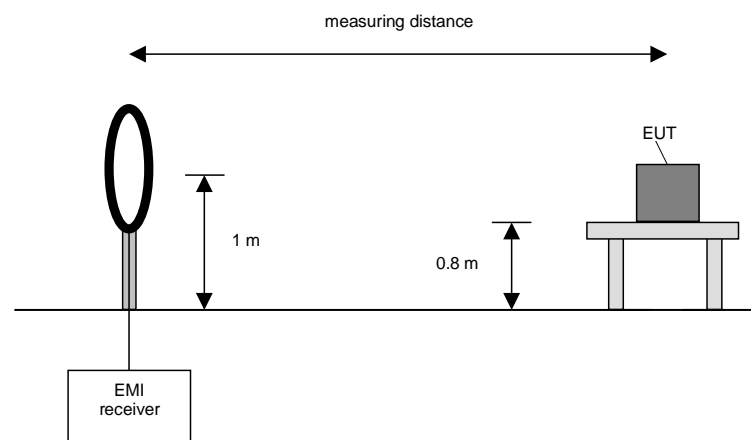

Final measurement procedure:

The following procedure will be used:

- 1) Monitor the frequency range with the measuring antenna at vertical orientation parallel to the EUT at an azimuth of 0 °.
- 2) Rotate the EUT by 360 ° to maximize the detected signals and note the azimuth and orientation.
- 3) Rotate the measuring antenna to find the maximum and note the value.
- 4) Rotate the measuring antenna and repeat steps 1) to 3) until the maximum value is found.
- 5) Repeat steps 1) to 4) with the other orthogonal axes of the EUT (only if the EUT is a module or is used in a handheld application).

Preliminary measurement (30 MHz to 1 GHz)

In the first stage a preliminary measurement will be performed in a fully anechoic chamber with a measuring distance of 3 meter. Tabletop devices will set up on a non-conducting support with a size of 1 m by 1.5 m and a height of 80 cm. Floor-standing devices will be placed directly on the turntable/ground plane. The setup of the Equipment under test will be in accordance to [1].

The frequency range 30 MHz to 1 GHz will be measured with an EMI Receiver set to MAX Hold mode and a resolution bandwidth of 100 kHz. The measurement will be performed in horizontal and vertical polarisation of the measuring antenna and while rotating the EUT in its vertical axis in the range of 0 ° to 360 °.

The resolution bandwidth of the EMI Receiver will be set to the following values:

Frequency range	Resolution bandwidth
30 MHz to 230 MHz	100 kHz
230 MHz to 1 GHz	100 kHz

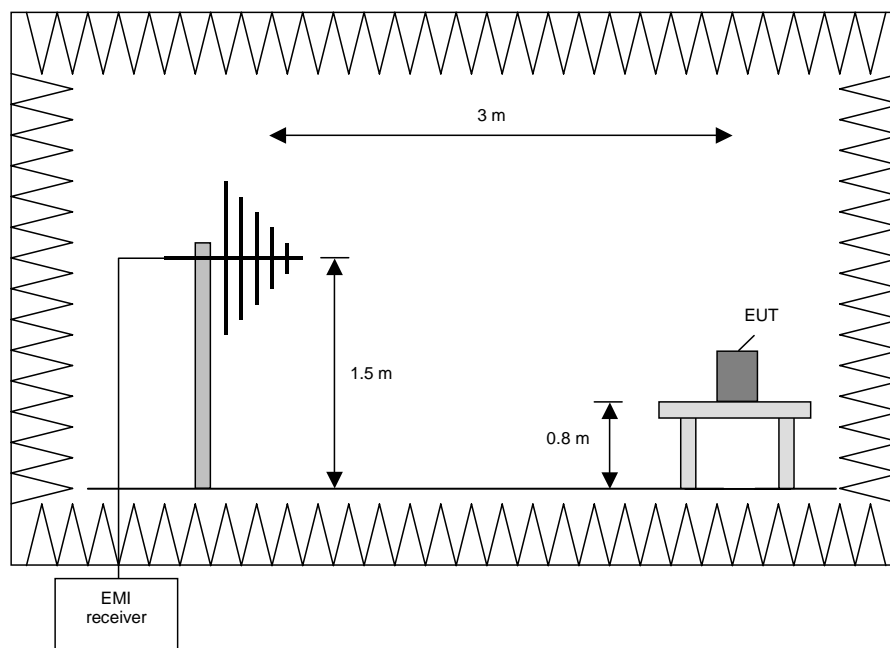

Procedure preliminary measurement:

Prescans were performed in the frequency range 30 MHz to 230 MHz and 230 MHz to 1 GHz.
The following procedure will be used:

1. Monitor the frequency range at horizontal polarisation and a EUT azimuth of 0 °.
2. Manipulate the system cables within the range to produce the maximum level of emission.
3. Rotate the EUT by 360 ° to maximize the detected signals.
4. Make a hardcopy of the spectrum.
5. Measure the frequency of the detected emissions with a lower span and resolution bandwidth to increase the accuracy and note the frequency value.
6. Repeat 1) to 4) for each orthogonal axes of the EUT (only if the EUT is a module or is used in a handheld application).
7. Repeat 1) to 5) with the vertical polarisation of the measuring antenna.

Final measurement (30 MHz to 1 GHz)

A final measurement on an open area test site will be performed on selected frequencies found in the preliminary measurement. During this test the EUT will be rotated in the range of 0 ° to 360 °, the measuring antenna will be set to horizontal and vertical polarisation and raised and lowered in the range from 1 m to 4 m to find the maximum level of emissions.

The resolution bandwidth of the EMI Receiver will be set to the following values:

Frequency range	Resolution bandwidth
30 MHz to 1 GHz	120 kHz

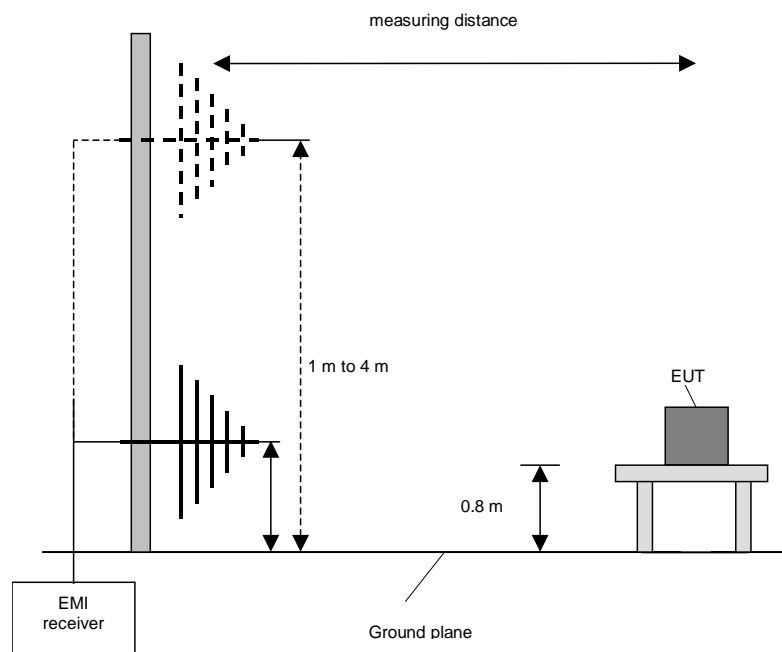

Procedure final measurement:

The following procedure will be used:

- 1) Measure on the selected frequencies at an antenna height of 1 m and a EUT azimuth of 23 °.
- 2) Move the antenna from 1 m to 4 m and note the maximum value at each frequency.
- 3) Rotate the EUT by 45 ° and repeat 2) until an azimuth of 337 ° is reached.
- 4) Repeat 1) to 3) for the other orthogonal antenna polarization.
- 5) Move the antenna and the turntable to the position where the maximum value is detected.
- 6) Measure while moving the antenna slowly +/- 1 m.
- 7) Set the antenna to the position where the maximum value is found.
- 8) Measure while moving the turntable +/- 45 °.
- 9) Set the turntable to the azimuth where the maximum value is found.
- 10) Measure with Final detector (QP and AV) and note the value.
- 11) Repeat 5) to 10) for each frequency.
- 12) Repeat 1) to 11) for each orthogonal axes of the EUT (only if the EUT is a module or is used in a handheld application).

Preliminary and final measurement (1 GHz to 110 GHz)

This measurement will be performed in a fully anechoic chamber. Tabletop devices will set up on a non-conducting support with a size of 1 m by 1.5 m and a height of 80 cm. Floor-standing devices will be placed directly on the turntable/ground plane. The setup of the Equipment under test will be in accordance to [1].

Preliminary measurement (1 GHz to 110 GHz)

The frequency range will be divided into different sub ranges depending of the frequency range of the used horn antenna. The spectrum analyser set to MAX Hold mode and a resolution bandwidth of 100 kHz. The measurement will be performed in horizontal and vertical polarisation of the measuring antenna, the antenna close to the EUT and while moving the antenna over all sides of the EUT. With the spectrum analyser in CLEAR / WRITE mode the cone of the emission should be found and then the measuring distance will be set to 3 m with the receiving antenna moving in this cone of emission. At this position the final measurement will be carried out.

The resolution bandwidth of the EMI Receiver will be set to the following values:

Frequency range	Resolution bandwidth
1 GHz to 4 GHz	100 kHz
4 GHz to 12 GHz	100 kHz
12 GHz to 18 GHz	100 kHz
18 GHz to 26.5 GHz	100 kHz
26.5 GHz to 40 GHz	100 kHz
40 GHz to 60 GHz	100 kHz
50 GHz to 75 GHz	100 kHz
75 GHz to 110 GHz	100 kHz

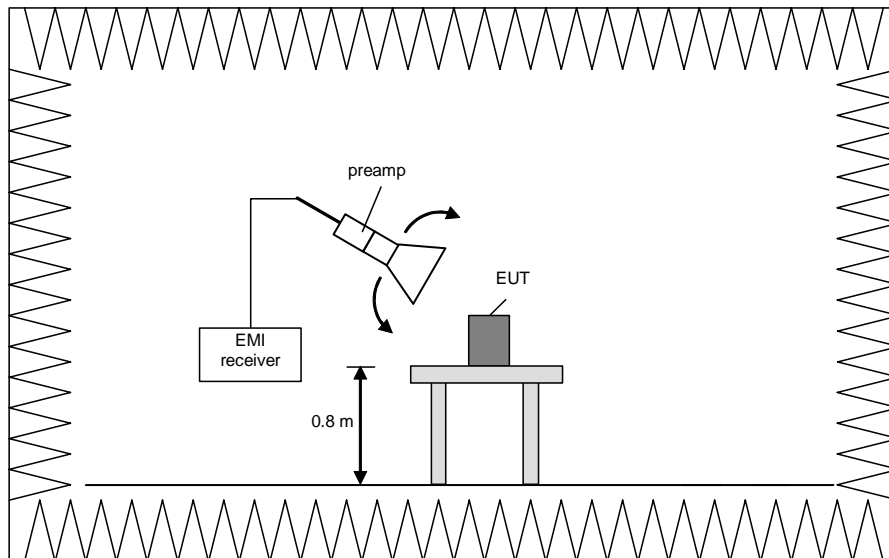

Final measurement (1 GHz to 110 GHz)

The frequency range will be divided into different sub ranges depending of the frequency range of the used horn antenna. The EMI Receiver set to peak and average mode and a resolution bandwidth of 1 MHz. The measurement will be performed in horizontal and vertical polarisation of the measuring antenna and while rotating the EUT in its vertical axis in the range of 0 ° to 360 ° in order to have the antenna inside the cone of radiation.

The resolution bandwidth of the EMI Receiver will be set to the following values:

Frequency range	Resolution bandwidth
1 GHz to 4 GHz	1 MHz
4 GHz to 12 GHz	1 MHz
12 GHz to 18 GHz	1 MHz
18 GHz to 26.5 GHz	1 MHz
26.5 GHz to 40 GHz	1 MHz
40 GHz to 60 GHz	1 MHz
50 GHz to 75 GHz	1 MHz
75 GHz to 110 GHz	1 MHz

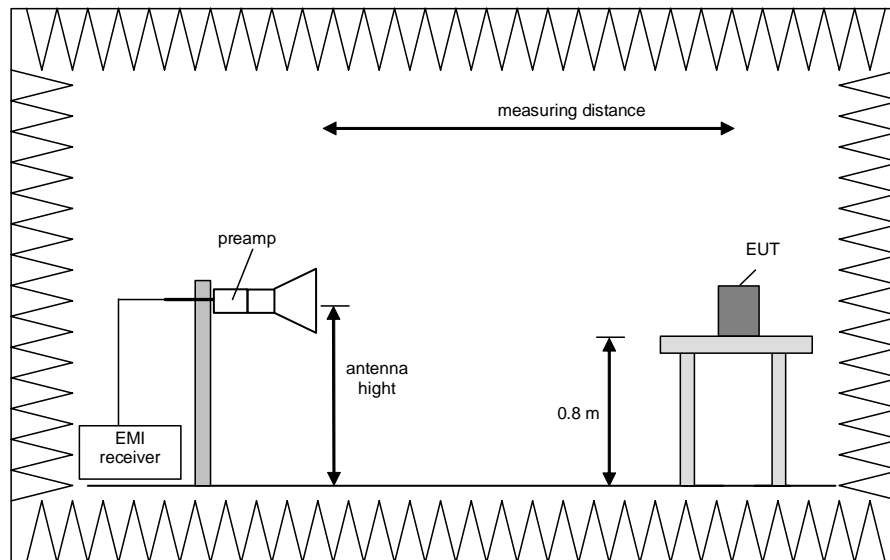

Procedure of measurement:

The measurements were performed in the frequency range 1 GHz to 4 GHz, 4 GHz to 12 GHz, 12 GHz to 18 GHz, 18 GHz to 26.5 GHz, 26.5 GHz to 40 GHz, 40 GHz to 60 GHz, 60 GHz to 75 GHz and 75 GHz to 110 GHz. The following procedure will be used:

- 1) Monitor the frequency range at horizontal polarisation and move the antenna over all sides of the EUT (if necessary move the EUT to another orthogonal axis).
- 2) Change the antenna polarisation and repeat 1) with vertical polarisation.
- 3) Make a hardcopy of the spectrum.
- 4) Measure the frequency of the detected emissions with a lower span and resolution bandwidth to increase the accuracy and note the frequency value.
- 5) Change the analyser mode to Clear / Write and found the cone of emission.
- 6) Rotate and move the EUT, so that the measuring distance can be enlarged to 3 m and the antenna will be still inside the cone of emission.
- 7) Measure the level of the detected frequency with the correct resolution bandwidth, with the antenna polarisation and azimuth and the peak and average detector, which causes the maximum emission.
- 8) Repeat steps 1) to 7) for the next antenna spot if the EUT is larger than the antenna beamwidth.

Step 1) to 6) are defined as preliminary measurement.

5.5.2 Preliminary radiated emission tests

Ambient temperature:	20 °C	Relative humidity:	45 %
----------------------	-------	--------------------	------

- Position of EUT: The EUT was set-up on a wooden table of a height of 0.8 m.
- Cable guide: The cable of the EUT was fixed on the wooden table. For further information of the cable guide refer to the pictures in annex A of this test report.
- Test record: The test was carried out in normal operation mode of the EUT (reading a TAG). All results are shown in the following.
- Power supply: During this test the EUT was powered with 24 V DC.
- Frequency range: According to [2] from 9 kHz to 30 MHz.

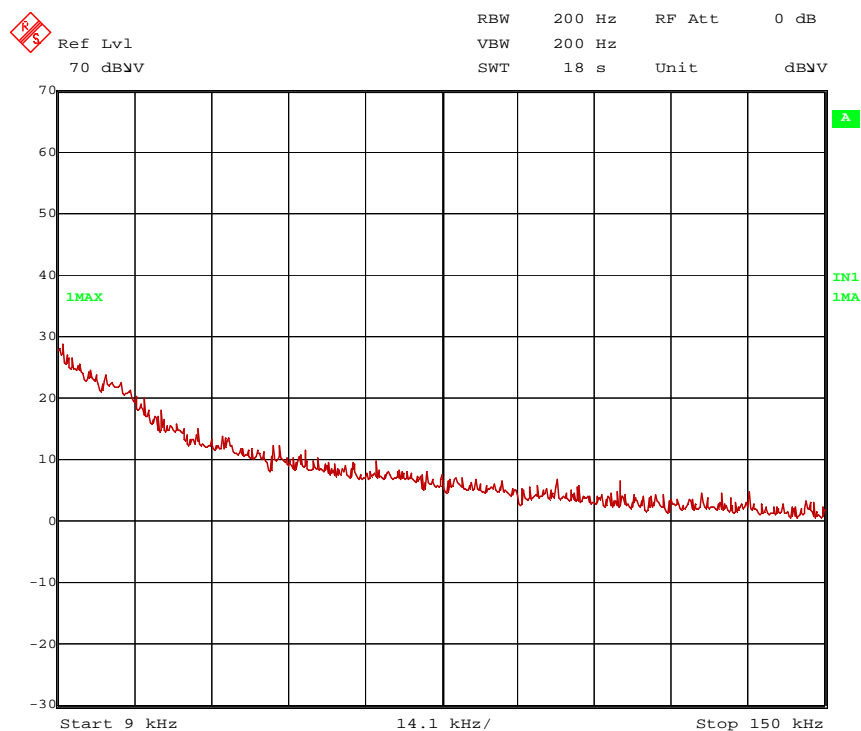

135074_a.wmf: Spurious emissions from 9 kHz to 150 kHz

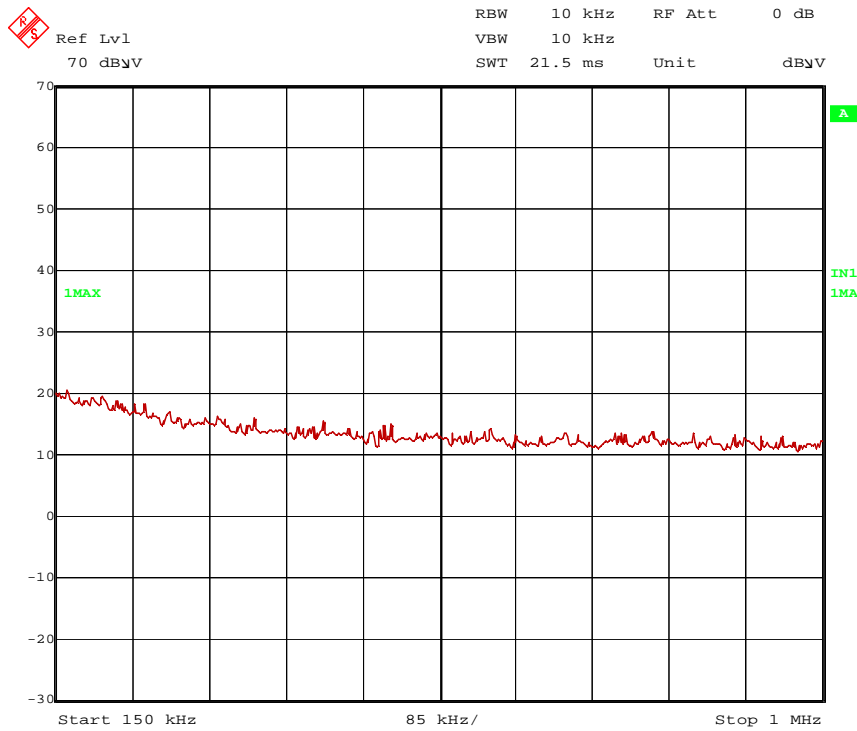

135074_b.wmf: Spurious emissions from 150 kHz to 1 MHz

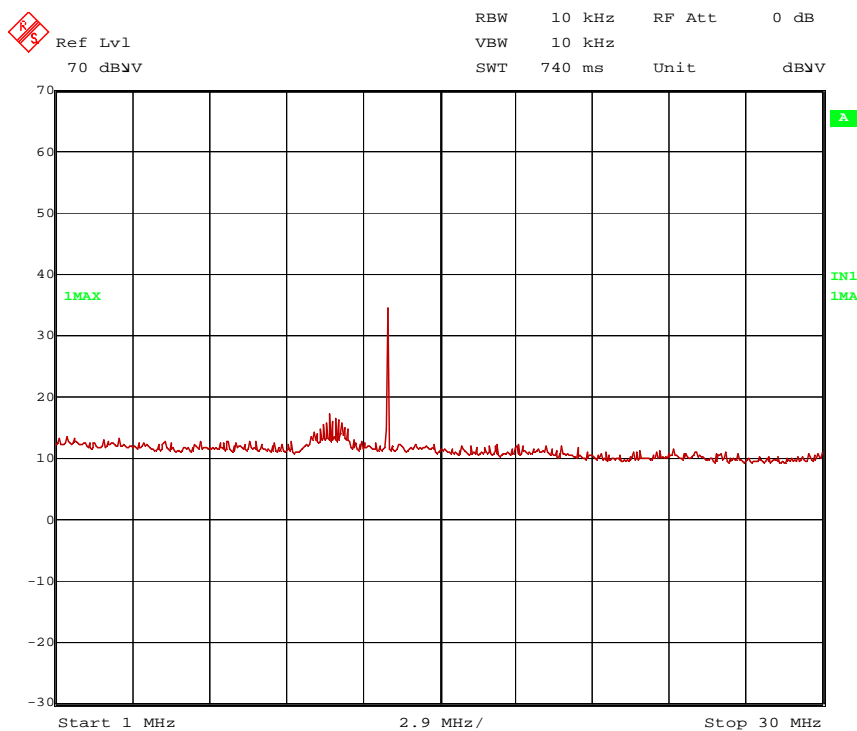

135074_c.wmf: Spurious emissions from 1 MHz to 30 MHz

Title: Preliminary emission measurement according to CFR47 Part 15
 EUT: TN-M30-H1147
 Manufacturer: Hans Turck GmbH & Co. KG
 Operating Condition: Continuous tag authentication
 Test site: Fully anechoic chamber M20, PHOENIX TESTLAB GmbH, Blomberg
 Operator: M. Bastert
 Test Specification: Operation at 13.56 MHz
 Comment: Supplied via ancillary with 24 VDC
 Ancillary outside chamber

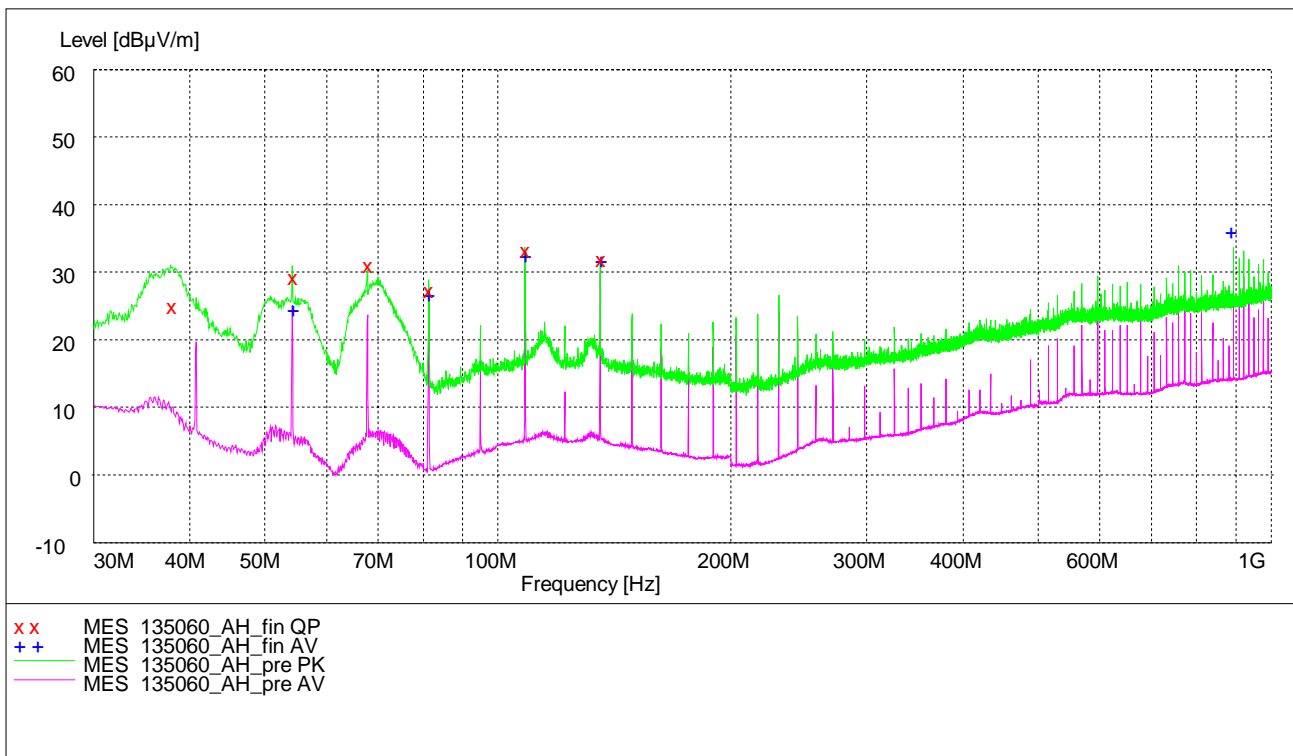

The following frequencies were found during the preliminary radiated emission test outside restricted bands:

54.240 MHz, 67.788 MHz, 81.360 MHz and 894.976 MHz

The following frequencies were found inside the restricted bands:

37.824 MHz, 108.480 MHz and 135.610MHz

These frequencies have to be measured on the open area test site. The results were presented in the following.

The following emission was found according to [2].

13.560 MHz (wanted signal is according to [2])

This frequency has to be measured on the outdoor test site. The results were presented in the following.

Test equipment used (see chapter 6)

1 - 8

5.5.3 Final radiated emission tests

Ambient temperature:	15 °C	Relative humidity:	56 %
----------------------	-------	--------------------	------

Position of EUT: The EUT was set-up on a non-conducting table of a height of 0.8 m. The distance between EUT and antenna was 10 m.

Cable guide: The cable of the EUT was fixed on the non-conducting table. For further information of the cable guide refer to the pictures in annex A of this test report.

Test record: The test was carried out in normal operation mode of the EUT (reading a TAG). All results are shown in the following.

Power supply: During this test the EUT was powered with 24 V_{DC}.

Test results: The test results were calculated with the following formula:

$$\text{Result [dB}\mu\text{V/m]} = \text{reading [dB}\mu\text{V]} + \text{antenna factor [dB/m]}$$

Results with measuring distance of 10 m						
Frequency MHz	Result dB μ V/m	Limit ²⁾ dB μ V/m	Margin dB	Detector	Readings dB μ V	Antenna factor ¹⁾ dB/m
13.560	65.4	104.0	38.6	QP	44.4	20.0
Results with measuring distance of 30 m (calculated)						
Frequency MHz	Result dB μ V/m	Limit ²⁾ dB μ V/m	Margin dB	Detector	Readings dB μ V	Antenna factor ¹⁾ dB/m
13.560	45.4 ³⁾	84.0	38.6	QP	-	20.0
Signal was below the noise floor of the measuring system						
Measurement uncertainty			+2.2 dB / -3.6 dB			

¹⁾: Cable loss included

²⁾: Limits according to 15.225

³⁾: Level extrapolated with a factor (40dB/decade) from the result at 10 m according to Part 15.31 (f)(2)

Test: Passed

Test equipment used (see chapter 6)

8 – 9, 11

Ambient temperature:	20 °C
----------------------	-------

Relative humidity:	47 %
--------------------	------

- Position of EUT: The EUT was set-up on a wooden table of a height of 0.8 m.
- Cable guide: The cable of the EUT was fixed on the wooden table. For further information of the cable guide refer to the pictures in annex A of this test report.
- Test record: The test was carried out in normal operation mode of the EUT (reading a TAG). All results are shown in the following.
- Power supply: During this test the EUT was powered with 24 V DC.
- Test results: The test results were calculated with the following formula:

$$\text{Result [dB}\mu\text{V/m]} = \text{reading [dB}\mu\text{V]} + \text{cable loss [dB]} + \text{antenna factor [dB/m]}$$

The measured points and the limit line in the following diagram refer to the standard measurement of the emitted interference in compliance with the above mentioned standard. The measured points marked with x are the measured results of the standard subsequent measurement on the open area test site.

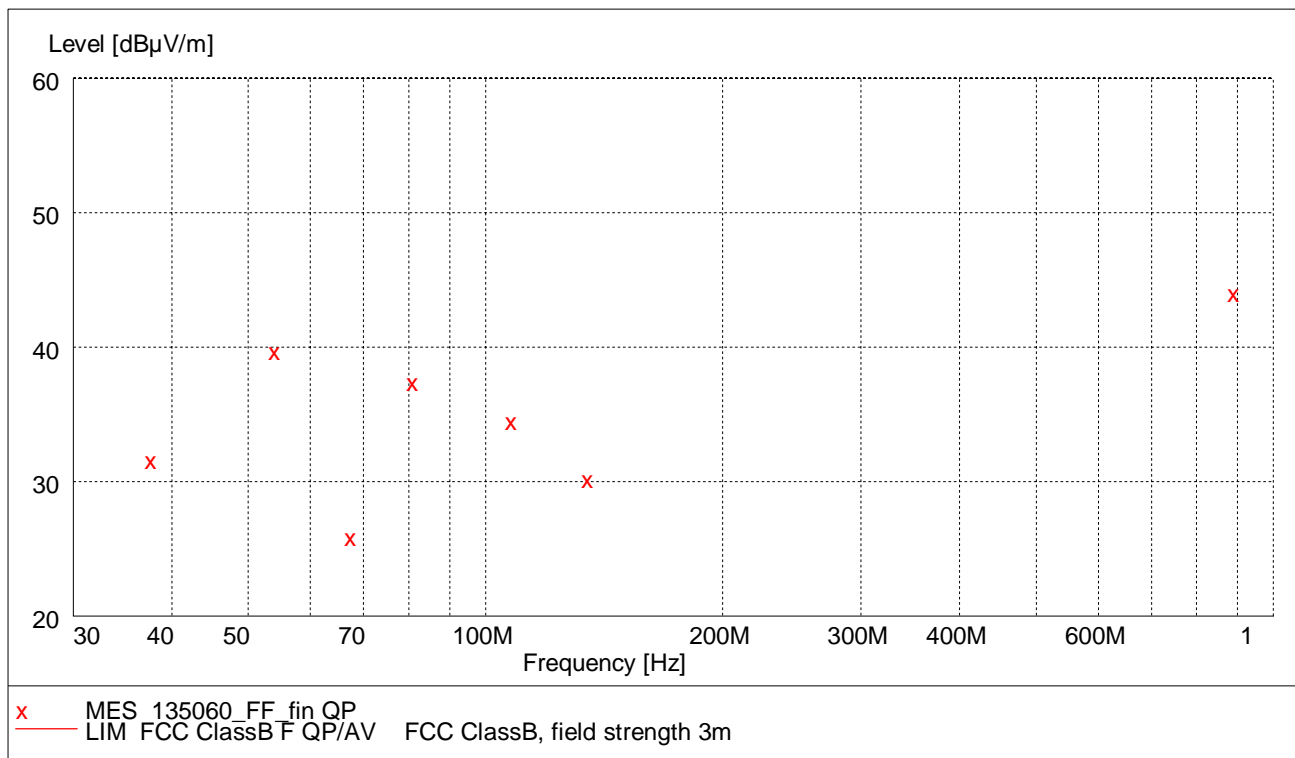

The results of the standard subsequent measurement on the open area test site are indicated in the table below. The limits as well as the measured results (levels) refer to the above mentioned standard while taking account of the specified requirements for a 3 m measuring distance.

Result measured with the quasipeak detector:
(These values are marked in the above diagram by an x)

Spurious emissions in restricted bands									
Frequency MHz	Result dB μ V/m	Limit dB μ V/m	Margin dB	Readings dB μ V	Antenna factor dB/m	Cable loss dB	Height cm	Azimuth deg	Pol.
37.820	31.8	40.0	8.2	15.2	16.0	0.6	125	269	vertical
108.480	34.7	43.5	8.8	22.0	11.6	1.1	100	53	vertical
135.600	30.4	43.5	13.1	17.2	11.9	1.3	100	47	vertical
Spurious emissions outside restricted bands									
Frequency MHz	Result dB μ V/m	Limit dB μ V/m	Margin dB	Readings dB μ V	Antenna factor dB/m	Cable loss dB	Height cm	Azimuth deg	Pol.
54.240	39.9	40.0	0.1	31.9	7.2	0.8	100	148	vertical
67.788	26.1	40.0	13.9	18.9	6.3	0.9	193	346	vertical
81.360	37.6	40.0	2.4	28.4	8.2	1.0	125	15	vertical
894.976	44.2	46.0	1.8	18.5	22.2	3.5	155	252	horizontal
Measurement uncertainty				+2.2 dB / -3.6 dB					

Test: Passed

Test equipment used (see chapter 6)

12 – 18

6 Test equipment and ancillaries used for tests

No.	Test equipment	Type	Manufacturer	Serial No.	PM. No.	Cal. Date	Cal. due
1	Fully anechoic chamber M20	-	Albatross Projects	B83107-E2439-T232	480303	Weekly verification (system cal.)	
2	Measuring receiver	ESI 40	Rohde & Schwarz	100064	480355	13/02/2012 26/02/2014	02/2014 02/2015
3	Controller	HD100	Deisel	100/670	480326	-	-
4	Turntable	DS420HE	Deisel	420/620/80	480315	-	-
5	Antenna support	AS615P	Deisel	615/310	480187	-	-
6	Antenna	CBL6112 B	Chase	2688	480328	14/04/2014	04/2017
7	RF-cable No. 30	RTK 081	Rosenberger	-	410141	Weekly verification (system cal.)	
8	Loop antenna	HFH2-Z2	Rohde & Schwarz	832609/014	480059	16/02/2012 18/02/2014	02/2014 02/2016
9	EMI test receiver	ESPC	Rohde & Schwarz	843756/006	480150	09/02/2012 24/02/2014	02/2014 02/2016
11	Outdoor test site	-	Phoenix Testlab	-	480293	-	-
12	Open area test site	-	Phoenix Testlab	-	480085	Weekly verification (system cal.)	
13	Measuring receiver	ESIB7	Rohde & Schwarz	100304	480521	06/02/2013	02/2015
14	Controller	HD100	Deisel	100/670	480139	-	-
15	Turntable	DS420HE	Deisel	420/620/80	480087	-	-
16	Antenna support	AS615P	Deisel	615/310	480086	-	-
17	Antenna	CBL6111 D	Chase	25761	480894	28/09/2011	09/2014
18	EMI Software	ES-K1	Rohde & Schwarz	-	480111	-	
19	Climatic Chamber	MK 240	WTB Binder Labortechnik GmbH	05-79022	480462	18/02/2014	08/2015
20	Spectrum analyser	FSW43	Rohde & Schwarz	100586	481720	10/09/2013	09/2015
21	Loop Antenna Ø = 225 mm	-	Phoenix Testlab	-	410085	Weekly verification	
22	Spectrum analyser	FSU	Rohde & Schwarz	100586	480956	24/02/2014	02/2016
23	Shielded chamber M4	-	Siemens	B83117S1-X158	480088	Weekly verification (system cal.)	
24	Measuring receiver	ESIB 26	Rohde & Schwarz	100292	481182	09/03/2012 21/03/2014	03/2014 03/2016
25	LISN	NSLK8128	Schwarzbeck	8128155	480058	20/12/2013	12/2014
26	AC-filter	B84299-D87-E3	Siemens	930262292	480097	Weekly verification (system cal.)	
27	EMI-Software	ES-K1	Rohde & Schwarz	-	480111	-	-

7 Report history

Report Number	Date	Comment
F135060E3	18 September 2014	Document created
-	-	-

8 List of annexes

ANNEX A	Test setup photos:	6 pages
	Test setup shielded chamber	135060_1a.jpg
	Test setup fully anechoic chamber (E-Field)	135060_2.jpg
	Test setup fully anechoic chamber (H-Field)	135060_3.jpg
	Test setup open area test site	135060_4.jpg
	Test setup outdoor test site	135060_5.jpg
	Test setup climatic chamber	135060_6a.jpg
ANNEX B	External photos:	3 pages
	TN-M30-H1147, 3D view 1	135060_7.jpg
	TN-M30-H1147, 3D view 2	135060_8.jpg
	TAG	135060_11.jpg
ANNEX C	Internal photos:	3 pages
	TN-M30-H1147, PCB, top view	135060_12.jpg
	TN-M30-H1147, PCB, bottom view	135060_13.jpg
	TN-M30-H1147, front view to PCB antenna	135060_14.jpg