

- For roller conveyors
- Rectangular, 80 x 400 mm, height 25 mm
- Active face on top
- Plastic, PBT-GF30-V0
- Powered and operated only via BL ident interface module
- Male M12 x 1, only for use with BL ident extension cable

Connectors .../S2503

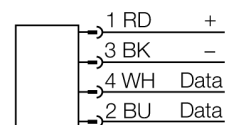

Connectors .../S2500



Connectors .../S2501

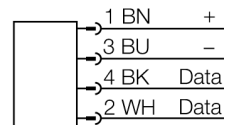

Type code	TNLR-Q80L400-H1147
Ident no.	7030204
Mounting conditions	non-flush, flush mountable
Ambient temperature	-25...+70 °C
Operating voltage	19.2...28.8VDC
DC rated operational current	≤ 230 mA
Data transfer	inductive coupling
Operating frequency	13.56 MHz
Radio communication and protocol standards	ISO 15693
Read/write distance max.	345 mm
Output function	4-wire, read/write
Construction	rectangular, Q80L400
Dimensions	400x 80x 25mm
Housing material	plastic, PBT, black
Material active area	plastic, Black
Connection	male, M12 x 1
Vibration resistance	55 Hz (1 mm)
Shock resistance	30 g (11 ms)
IP Rating	IP67
MTTF	121 years acc. to SN 29500 (Ed. 99) 40 °C
Power-on indication	LED green
Diagnostic display	Functional description of yellow range-restricted LED: If the read/write head is supplied with voltage, it briefly checks to see whether its resonance frequency is affected by surrounding metal. If this is the case, the resonant circuit off-tunes its frequency to reach again the (optimum) resonance frequency. However, this is only possible within a certain range. If too much metal is in the environment, the read/write head cannot re-tune or the surrounding metal takes too much energy from the field and due to the reduced range the communication between the read/write head and the data carrier is cut off (the orange range-restricted-LED lights up). If the LED is off, this does not mean conversely, that no reduction in range occurs. The lit LED is rather an indication of too much metal in the environment and a greatly reduced range (about 50% less).

Functional principle

The HF read/write heads operating at a frequency of 13.56 MHz form a transmission zone the size of which (0...500 mm) varies, depending on the combination of read/write head and data carrier.

The read/write distances mentioned here only represent standard values measured under laboratory conditions.



The read/write distances of the data carriers for mounting in metal TW-R**-(MF) were determined in metal.

Attainable distances may vary by up to 30 % due to component tolerances, mounting conditions, ambient conditions and material qualities (especially when mounted in metal)

Testing of the application under real operating conditions is therefore essential, especially with read/write on-the-fly!

Packaged quantity	1
Special features	For roller conveyors (vertical or horizontal orientation)

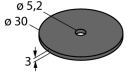
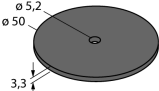
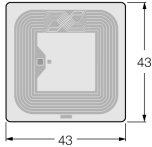

Data carrier

Dimensions	Type designation Ident - no.	Read-write distance		Transfer zone		Minimum distance between two read-write heads [mm]
		Recommend-ed (mm)	max. [mm]	length max. [mm]	width offset max. [mm]	
	TW-R16-B128 6900501	50	95	74	205	240
	TW-R20-B128 6900502	60	102	86	202	240
	TW-R20-K2 6900505	15	64	70	195	240
	TW-R30-B128 6900503	90	152	132	217	240
	TW-R30-K2 6900506	70	122	100	208	240
	TW-R50-B128 6900504	150	256	230	242	240
	TW-R50-K2 6900507	120	216	190	233	240
	TW-L49-46-F-B128 7030390	74	176	149	197	240
						

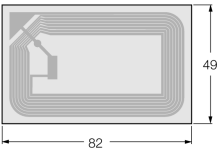
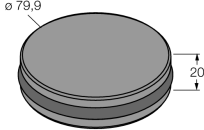
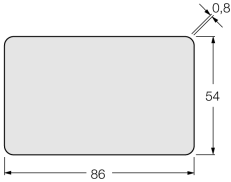
Data carrier

Dimensions	Type designation Ident - no.	Read-write distance		Transfer zone		Minimum distance between two read-write heads [mm]
		Recommend- ed (mm)	max. [mm]	length max. [mm]	width offset max. [mm]	
	TW-L80-50-P-B128 7030389	136	229	204	207	240
	TW-R80-M-B128 7030207 TW-R80-M-K2 7030205	40 30	77 77	56 64	199 195	240 240
	TW-L86-54-C-B128 6900479	200	345	306	242	240

Data carrier longitudinal approach

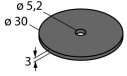
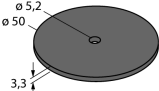
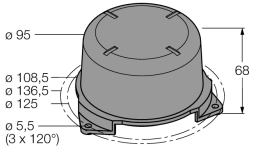
Dimensions	Type designation	Read-write distance		Transfer zone		Minimum distance between two read-write heads [mm]
	Ident - no.	Recommend- ed (mm)	max. [mm]	length max. [mm]	width offset max. [mm]	
	TW-R16-B128 6900501	30	95	410	37	240
	TW-R20-B128 6900502	40	102	404	43	240
	TW-R20-K2 6900505	30	64	390	35	240
	TW-R30-B128 6900503	60	152	434	66	240
	TW-R30-K2 6900506	50	122	416	50	240
	TW-R50-B128 6900504	100	256	484	115	240
	TW-R50-K2 6900507	90	216	466	95	240
	TW-R50-90-HT-B128 1542326	70	226	484	115	240
	TW-R50-90-HT-K2 1542329	60	186	466	95	240

Data carrier longitudinal approach

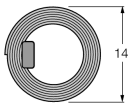
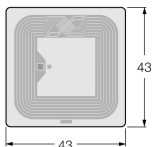
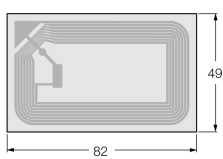
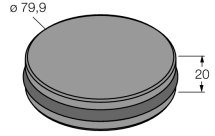
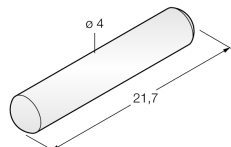
Dimensions	Type designation Ident - no.	Read-write distance		Transfer zone		Minimum distance between two read-write heads [mm]
		Recommend-ed (mm)	max. [mm]	length max. [mm]	width offset max. [mm]	
	TW-I14-B128 6900526	30	95	410	37	240
	TW-L49-46-F-B128 7030390	68	176	394	74	240
	TW-L80-50-P-B128 7030389	85	229	414	102	240
	TW-R80-M-B128 7030207 TW-R80-M-K2 7030205	30	77	398	28	240
	TW-R4-22-B128 7030237	20	80	368	34	240

Data carrier longitudinal approach

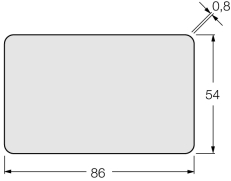
Dimensions	Type designation Ident - no.	Read-write distance		Transfer zone		Minimum distance between two read-write heads [mm]
		Recommend- ed (mm)	max. [mm]	length max. [mm]	width offset max. [mm]	
	TW-L86-54-C-B128 6900479	120	360	484	153	240

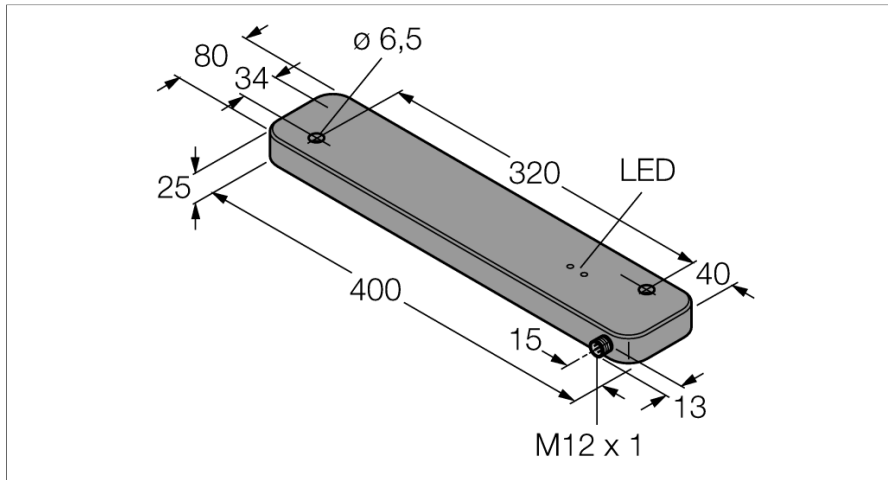

- For roller conveyors
- The approach direction of the data carrier can be both, diagonal as well as longitudinal to the read/write head.
- Rectangular, 80 x 400 mm, height 25 mm
- Active face on top
- Plastic, PBT-GF30-VO
- Powered and operated only via BL ident interface module
- Male M12 x 1, only for use with BL ident extension cable

Connectors .../S2503

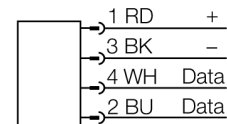

Connectors .../S2500

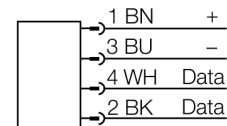

Connectors .../S2501

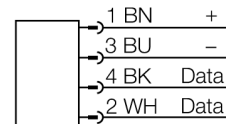

Functional principle

The HF read/write heads operating at a frequency of 13.56 MHz form a transmission zone the size of which (0...500 mm) varies, depending on the combination of read/write head and data carrier.

The read/write distances mentioned here only represent standard values measured under laboratory conditions.

The read/write distances of the data carriers for mounting in metal TW-R**-(MF) were determined in metal.



Attainable distances may vary by up to 30 % due to component tolerances, mounting conditions, ambient conditions and material qualities (especially when mounted in metal)

Testing of the application under real operating conditions is therefore essential, especially with read/write on-the-fly!

Type code	TNLR-Q80L400-H1147L
Ident no.	7030234
Mounting conditions	non-flush, flush mountable
Ambient temperature	-25...+70 °C
Operating voltage	19.2...28.8VDC
DC rated operational current	≤ 230 mA
Data transfer	inductive coupling
Operating frequency	13.56 MHz
Radio communication and protocol standards	ISO 15693
Read/write distance max.	345 mm
Output function	4-wire, read/write
Construction	rectangular, Q80L400
Dimensions	400x 80x 25mm
Housing material	plastic, PBT, black
Material active area	plastic, Black
Connection	male, M12 x 1
Vibration resistance	55 Hz (1 mm)
Shock resistance	30 g (11 ms)
IP Rating	IP67
MTTF	121 years acc. to SN 29500 (Ed. 99) 40 °C
Power-on indication	LED green
Diagnostic display	Functional description of yellow range-restricted LED: If the read/write head is supplied with voltage, it briefly checks to see whether its resonance frequency is affected by surrounding metal. If this is the case, the resonant circuit off-tunes its frequency to reach again the (optimum) resonance frequency. However, this is only possible within a certain range. If too much metal is in the environment, the read/write head cannot re-tune or the surrounding metal takes too much energy from the field and due to the reduced range the communication between the read/write head and the data carrier is cut off (the orange range-restricted-LED lights up). If the LED is off, this does not mean conversely, that no reduction in range occurs. The lit LED is rather an indication of too much metal in the environment and a greatly reduced range (about 50% less).

Packaged quantity	1
Special features	For roller conveyors (vertical or horizontal orientation)

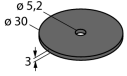
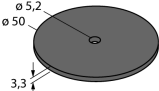
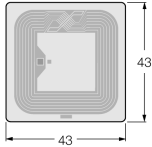

Data carrier

Dimensions	Type designation Ident - no.	Read-write distance		Transfer zone		Minimum distance between two read-write heads [mm]
		Recommend-ed (mm)	max. [mm]	length max. [mm]	width offset max. [mm]	
	TW-R16-B128 6900501	50	95	74	205	240
	TW-R20-B128 6900502 TW-R20-K2 6900505	60 15	102 64	86 70	202 195	240 240
	TW-R30-B128 6900503 TW-R30-K2 6900506	90 70	152 122	132 100	217 208	240 240
	TW-R50-B128 6900504 TW-R50-K2 6900507	150 120	256 216	230 190	242 233	240 240
	TW-L49-46-F-B128 7030390	74	176	149	197	240

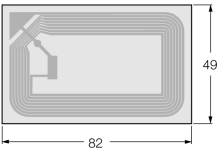
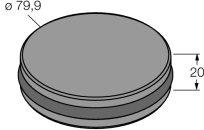
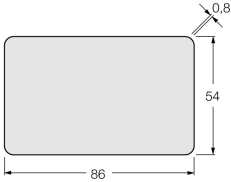
Data carrier

Dimensions	Type designation Ident - no.	Read-write distance		Transfer zone		Minimum distance between two read-write heads [mm]
		Recommend- ed (mm)	max. [mm]	length max. [mm]	width offset max. [mm]	
	TW-L80-50-P-B128 7030389	136	229	204	207	240
	TW-R80-M-B128 7030207 TW-R80-M-K2 7030205	40 30	77 77	56 64	199 195	240 240
	TW-L86-54-C-B128 6900479	200	345	306	242	240

Data carrier longitudinal approach

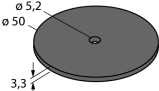
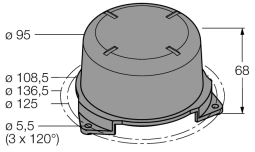
Dimensions	Type designation	Read-write distance		Transfer zone		Minimum distance between two read-write heads [mm]
	Ident - no.	Recommend- ed (mm)	max. [mm]	length max. [mm]	width offset max. [mm]	
	TW-R16-B128 6900501	30	95	410	37	240
	TW-R20-B128 6900502 TW-R20-K2 6900505	40 30	102 64	404 390	43 35	240 240
	TW-R30-B128 6900503 TW-R30-K2 6900506	60 50	152 122	434 416	66 50	240 240
	TW-R50-B128 6900504 TW-R50-K2 6900507	100 90	256 216	484 466	115 95	240 240
	TW-R50-90-HT-B128 1542326 TW-R50-90-HT-K2 1542329	70 60	226 186	484 466	115 95	240 240
						

Data carrier longitudinal approach

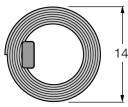
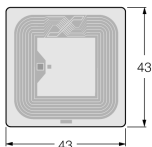
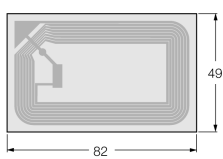
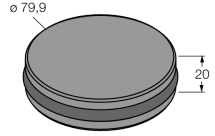
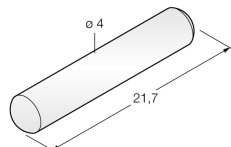
Dimensions	Type designation Ident - no.	Read-write distance		Transfer zone		Minimum distance between two read-write heads [mm]
		Recommend- ed (mm)	max. [mm]	length max. [mm]	width offset max. [mm]	
	TW-I14-B128 6900526	30	95	410	37	240
	TW-L49-46-F-B128 7030390	68	176	394	74	240
	TW-L80-50-P-B128 7030389	85	229	414	102	240
	TW-R80-M-B128 7030207 TW-R80-M-K2 7030205	30	77	398	28	240
	TW-R4-22-B128 7030237	20	80	368	34	240

Data carrier longitudinal approach

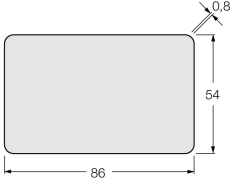
Dimensions	Type designation Ident - no.	Read-write distance		Transfer zone		Minimum distance between two read-write heads [mm]
		Recommend- ed (mm)	max. [mm]	length max. [mm]	width offset max. [mm]	
	TW-L86-54-C-B128 6900479	120	360	484	153	240

BL
ident



Qty 1 Type **TNLR-Q80L400-H1147**

CE

Ident-No. **7030204**

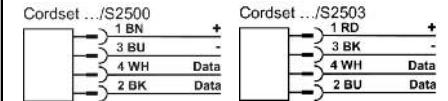

24 VDC

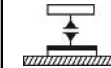
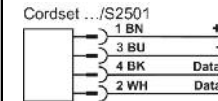

1615H

Warning: Hazardous voltage can cause electrical shock and burns. Disconnect power before proceeding with any work on this equipment.
Made in Germany
Hans Turck GmbH & Co. KG · Witzlebenstraße 7 · 45472 Mülheim/Ruhr · Germany
Phone +49 208 49 52-0 · Fax +49 208 49 52-264 · more@turck.com · www.turck.com

FCC/IC Digital Device Limitations

M/N: **TNLR-Q80L400-H1147**
FCC ID: **YQ7-TNLRQ80L400**
IC: **8821A-TNLRQ80L400**

This device complies with Industry Canada licence-exempt RSS standard(s) and part 15 of the FCC Rules. Operation is subject to the following two conditions:
(1) this device may not cause interference, and
(2) this device must accept any interference, including interference that may cause undesired operation of the device.

Changes or modifications not expressly approved by the party responsible for compliance could void the user's authority to operate the equipment.

Le présent appareil est conforme aux CNR d'Industrie Canada applicables aux appareils radio exempts de licence. L'exploitation est autorisée aux deux conditions suivantes :
(1) l'appareil ne doit pas produire de brouillage, et
(2) l'appareil doit accepter tout brouillage radioélectrique subi, même si le brouillage est susceptible d'en compromettre le fonctionnement.