

Königswinkel 10
32825 Blomberg
Germany
Phone +49 5235 9500-0
Fax +49 5235 9500-10

Test Report

Report Number: F135053E2

Applicant:

Werner Turck GmbH & Co. KG

Manufacturer:

Hans Turck GmbH & Co. KG

Equipment under Test (EUT):

RFID Reader

TB-Q08-0.15-RS4.47T



Laboratory (CAB) accredited by
Deutsche Akkreditierungsstelle GmbH (DAkks)
in compliance with DIN EN ISO/IEC 17025
under the Reg. No. D-PL-17186-01-02,
FCC Test site registration number 90877 and
Industry Canada Test site registration IC3469A-1

REFERENCES

[1] **ANSI C63.4:2009** American National Standard for Methods of Measuring of Radio-Noise Emissions from Low-Voltage Electrical and Electronic Equipment in the Range of 9 kHz to 40 GHz.

[2] **FCC 47 CFR Part 15** Radio Frequency Devices

TEST RESULT

The requirements of the tests performed as shown in the overview (chapter 4 of this test report) were fulfilled by the equipment under test.

The complete test results are presented in the following.

Test engineer:	Manuel BASTERT		27 May 2015
	_____ Name	_____ Signature	_____ Date
Authorized reviewer:	Bernd SELCK		27 May 2015
	_____ Name	_____ Signature	_____ Date

RESERVATION

This test report is only valid in its original form.

Any reproduction of its contents in extracts without written permission of the accredited test laboratory PHOENIX TESTLAB GmbH is prohibited.

The test results herein refer only to the tested sample. PHOENIX TESTLAB GmbH is not responsible for any generalisations or conclusions drawn from these test results concerning further samples. Any modification of the tested samples is prohibited and leads to the invalidity of this test report. Each page necessarily contains the PHOENIX TESTLAB Logo and the TEST REPORT NUMBER.

Contents:	Page
1 Identification	4
1.1 Applicant.....	4
1.2 Manufacturer.....	4
1.3 Test laboratory.....	4
1.4 EUT (Equipment Under Test).....	5
1.5 Technical data of equipment.....	5
1.6 Ancillary equipment used for test:	5
1.7 Dates	5
2 Operational states.....	6
3 Additional information	7
4 Overview	7
5 Test results	8
5.1 20 dB Bandwidth.....	8
5.1.1 Method of measurement	8
5.1.2 Test results	9
5.2 Conducted emissions on power supply line	10
5.2.1 Method of measurement	10
5.2.2 Test results	11
5.3 Radiated emissions.....	13
5.3.1 Method of measurement	13
5.3.2 Preliminary radiated emission tests	20
5.3.3 Final radiated emission tests	23
6 Test equipment and ancillaries used for tests.....	26
7 Report history	27
8 List of annexes	27

1 Identification

1.1 Applicant

Name:	Werner Turck GmbH & Co. KG
Address:	Goethestr. 7 58553 Halver
Country:	Germany
Name for contact purposes:	Mr. Markus TEUBNER
Tel:	+49 (0) 2353 / 709-6124
Fax:	+49 (0) 2353 / 709-6174
e-mail address:	markus.teubner@turck.com

1.2 Manufacturer

Name:	Hans Turck GmbH & Co. KG
Address:	Witzlebenstr. 7 45472 Mühlheim an der Ruhr
Country:	Germany
Name for contact purposes:	Mr. Markus TEUBNER
Tel:	+49 (0) 2353 / 709-6124
Fax:	+49 (0) 2353 / 709-6174
e-mail address:	markus.teubner@turck.com

1.3 Test laboratory

The tests were carried out at: **PHOENIX TESTLAB GmbH**
Königswinkel 10
32825 Blomberg
Germany

Test Laboratory (CAB) accredited by Deutsche Akkreditierungsstelle GmbH (DAkkS) in compliance with DIN EN ISO/IEC 17025 under the Reg. No. D-PL-17186-01-02, recognized by Bundesnetzagentur under the Reg.-No. BNetzA-CAB-02/21-104. CAB Designation Number DE0004, listed by FCC 31040/SIT1300F2, IC OATS Listing 3469A-1.

1.4 EUT (Equipment Under Test)

Type of equipment:	RFID transceiver
HVIN / model name:	TB-Q08-0.15-RS4.47T
Serial No.:	None (Engineering sample)
FCC ID:	YQ7-TBQ08

1.5 Technical data of equipment

Power supply: *	DC		
Supply voltage: *	U _{nom} = 24 V	U _{min} = 10 V	U _{max} = 30 V
Type of modulation: *	ASK		
Frequency deviation: *	-		
Operating frequency range: *	13.56 MHz		
Number of channels: *	1		
Antenna type: *	Internal loop antenna		
Duty cycle: *	100%		
Rated RF power: *	< 250 mW		
Data rate: *	26.48 kbaud		
Lowest internal frequency: *	13.56 MHz		
Highest internal frequency: *	13.56 MHz		
Temperature range: *	-25 to 70 °C (-13 to 158 °F)		

* declared by the applicant.

1.6 Ancillary equipment used for test:

Turck Gateway BL67 (consisting of PG-DP, 2RFID-S and 8XSG-PD).

1.7 Dates

Date of receipt of test sample:	05 March 2014
Start of test:	05 May 2014
End of test:	28 November 2014

2 Operational states

If not otherwise stated the EUT was powered with 24 V_{DC} by an external power supply via the ancillary device. A test mode was implemented which set the EUT in a continuous tag authentication. An LED at an ancillary monitoring device indicates successful data communication. The equipment is shown in the following pictures.

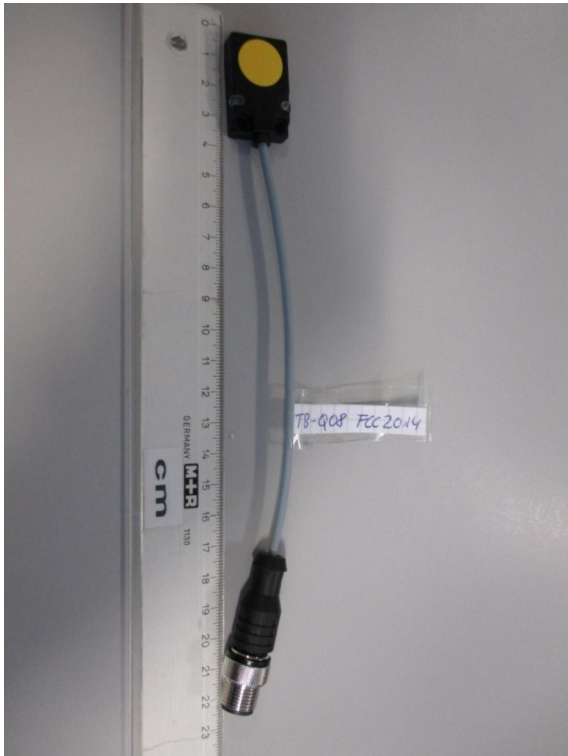

TB-Q08-0.15-RS4.47T

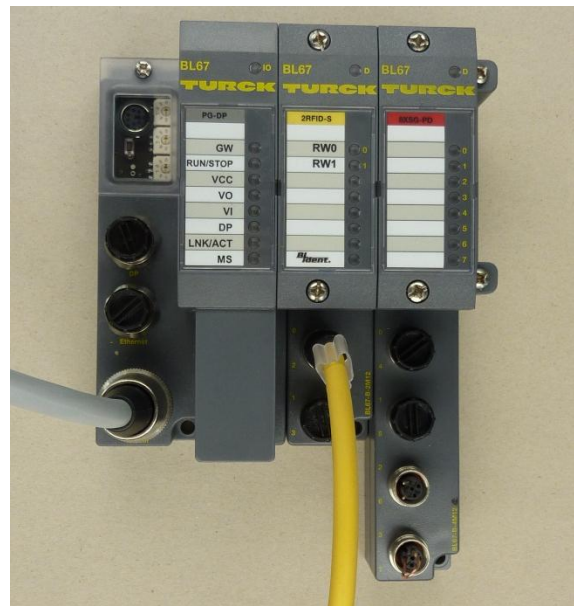

Ancillary device



TAG

3 Additional information

None

4 Overview

Application	Frequency range [MHz]	FCC 47 CFR Part 15 section [2]	Status	Refer page
Radiated emissions	13.110 to 14.110	15.225 (a) – (d)	Not applicable*	-
20 dB bandwidth	13.560	15.215 (c)	Passed	8 et seq.
Frequency tolerance	13.560	15.225 (e)	Not applicable*	-
Conducted emissions on power supply lines	0.015 - 30	15.207 (a)	Passed	10 et seq.
Radiated emissions	0.009 - 1,000	15.205 (a) 15.209 (a)	Passed	13 et seq.

*) Because the fundamental emission is below the CFR 47 Part 15.209 spurious domain emission limit no measurement of spectrum mask and frequency tolerance according to CFR 47 Part 15.225 need to be performed.

5 Test results

5.1 20 dB Bandwidth

5.1.1 Method of measurement

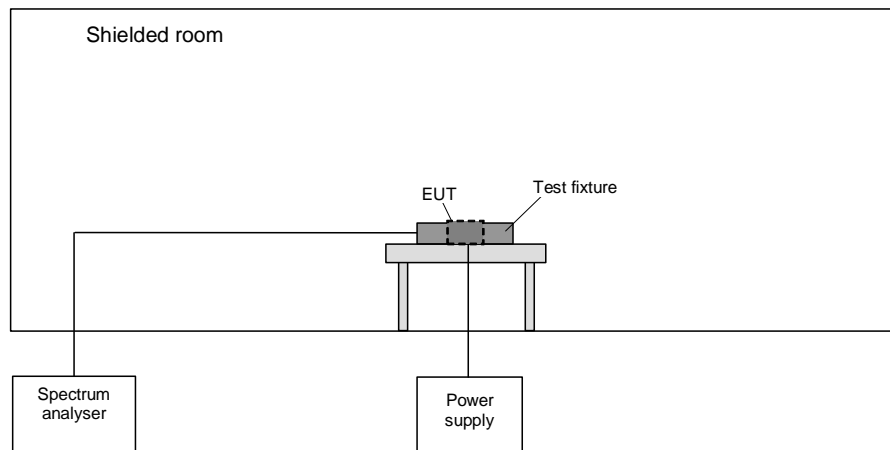

The following procedure will be used for the occupied bandwidth measurement [1]:

- 1) Place the EUT in the test fixture and switch it on.
- 2) Use the following spectrum analyser settings: $RWB = VBW = 10 \text{ kHz}$, $\text{Span} = \text{wide enough to capture app. } 1.5 \text{ times the } 20 \text{ dB bandwidth}$, $\text{Trace mode} = \text{MaxHold}$.
- 3) After trace stabilisation, set the first marker and the first display line to the signal peak. Set the second display line 20 dB below the first display line. The second marker and its delta marker shall be set to cross points of the spectrum line and the second display line and note these frequencies.
- 4) Alternatively the 20 dB down function of the analyser could be used, if this function will be applicable to the displayed spectrum.

5.1.2 Test results

Ambient temperature	21 °C	Relative humidity	35 %
---------------------	-------	-------------------	------

Supply voltage: The EUT was supplied with 24 V_{DC}.

Test record: The test was carried out while the EUT was reading a tag.

135053_20dB.wmf: 20 dB Bandwidth:

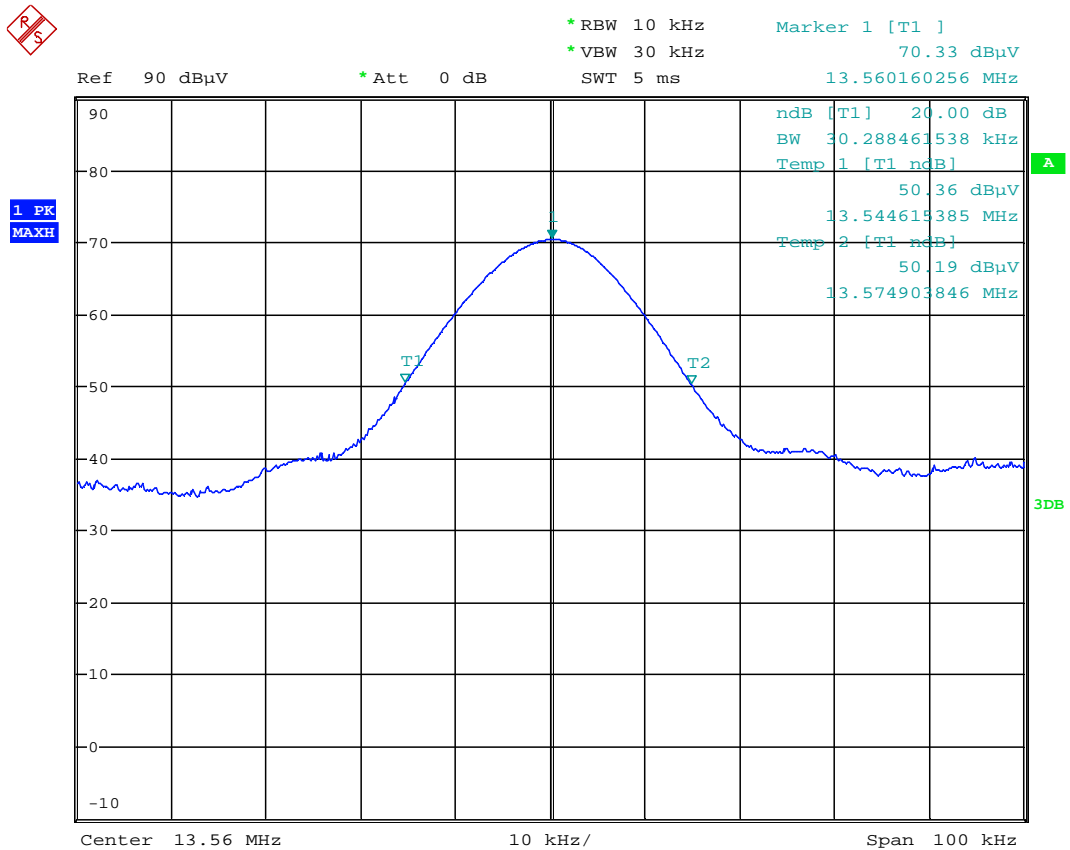

f _L	f _U	BW (f _U - f _L)
13.545 MHz	13.575 MHz	30 kHz
Measurement uncertainty		< ± 1*10 ⁻⁷

Test equipment used (see chapter 6)

10, 21, 22

5.2 Conducted emissions on power supply line

5.2.1 Method of measurement

This test will be carried out in a shielded chamber. Tabletop devices will set up on a non-conducting support with a size of 1 m by 1.5 m and a height of 80 cm above the ground plane. Floor-standing devices will be placed directly on the ground plane. The setup of the Equipment under test will be in accordance to [1].

The frequency range 150 kHz to 30 MHz will be measured with an EMI Receiver set to MAX Hold mode with peak and average detector and a resolution bandwidth of 9 kHz. A scan will be carried out on the phase (or plus pole in case of DC powered devices) of the AC mains network. If levels detected 10 dB below the appropriate limit, this emission will be measured with the average and quasi-peak detector on all lines.

Frequency range	Resolution bandwidth
150 kHz to 30 MHz	9 kHz

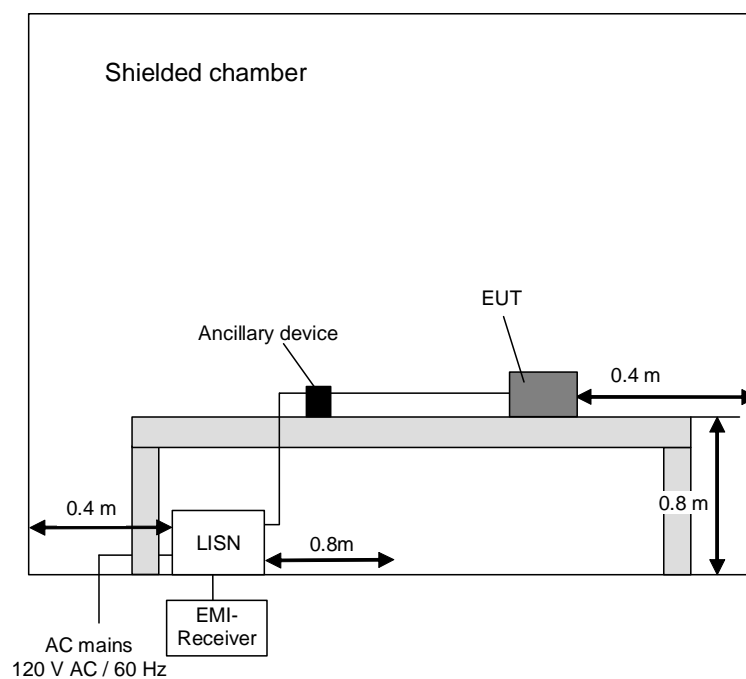

5.2.2 Test results

Ambient temperature:	21 °C	Relative humidity:	47 %
----------------------	-------	--------------------	------

Position of EUT:	The EUT was set-up on a wooden table of a height of 0.8 m.
Cable guide:	The cable of the EUT was fixed on the wooden table. For further information of the cable guide refer to the pictures in annex A of this test report.
Test record:	The test was carried out in normal operation mode of the EUT (reading a TAG). All results are shown in the following.
Power supply:	During this test the EUT was powered with 24 V _{DC} by the ancillary device which was itself supplied also with 24 V _{DC} by an AC power supply Phoenix Contact Mini-PS-100-240AC/24DC/2 with 120 V _{AC} / 60 Hz.

The curves in the diagram only represent for each frequency point the maximum measured value of all preliminary measurements which were made for each power supply line. The top measured curve represents the peak measurement and the bottom measured curve the average measurement. The quasi-peak measured points are marked by "x" and the average measured points by "+".

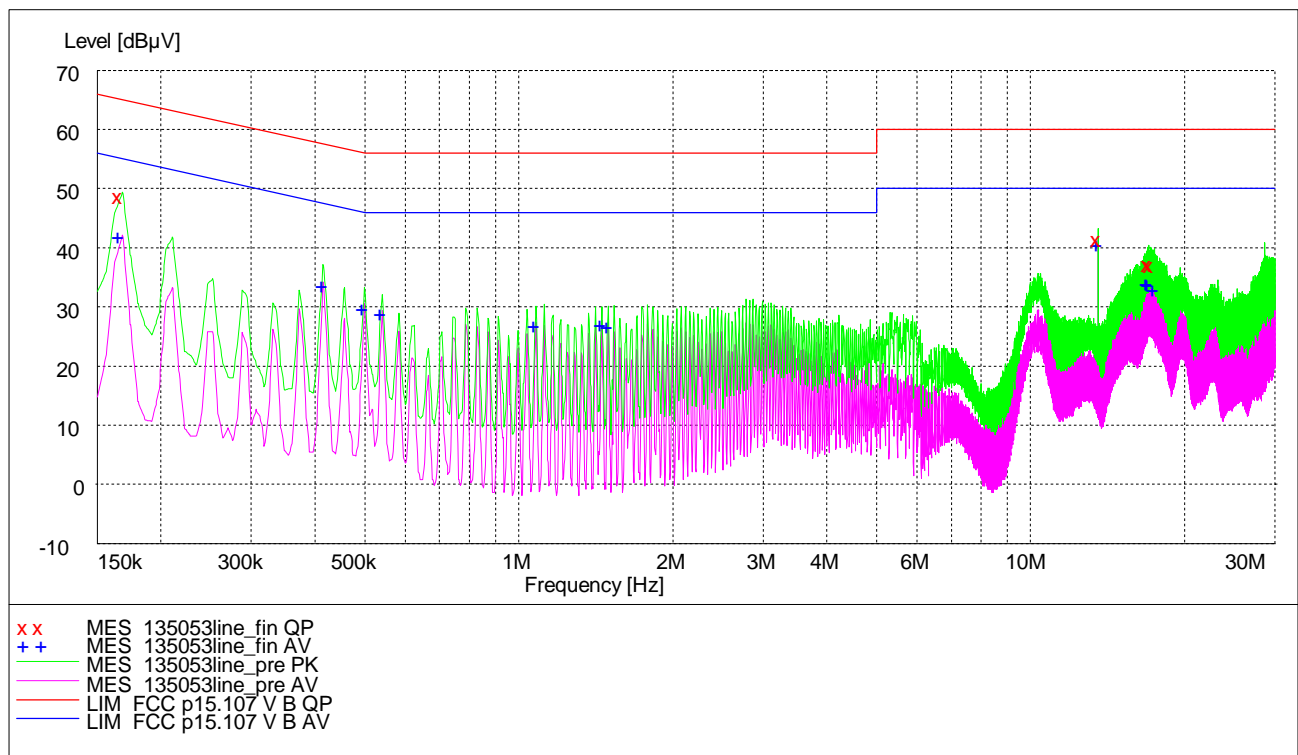

Result measured with the quasipeak detector (marked by an x):

Frequency MHz	Level dB μ V	Transducer dB	Limit dB μ V	Margin dB	Line	PE
0.166200	49.20	1.3	65.1	16.0	N	FLO
13.560000	41.90	1.8	60.0	18.1	N	GND
16.992600	37.70	2.0	60.0	22.3	N	FLO
17.159100	37.60	2.0	60.0	22.4	N	FLO

Result measured with the average detector (marked by a +):

Frequency MHz	Level dB μ V	Transducer dB	Limit dB μ V	Margin dB	Line	PE
0.166200	42.50	1.3	55.1	12.7	N	FLO
0.414600	34.20	0.9	47.6	13.3	N	FLO
0.497400	30.30	0.8	46.0	15.7	N	FLO
0.538800	29.40	0.8	46.0	16.6	N	FLO
1.078800	27.50	0.8	46.0	18.5	N	FLO
1.451400	27.60	0.7	46.0	18.4	N	GND
1.493700	27.20	0.7	46.0	18.8	N	FLO
13.560000	41.20	1.8	50.0	8.8	N	GND
16.909800	34.60	2.0	50.0	15.4	N	FLO
16.951200	34.50	2.0	50.0	15.5	N	FLO
16.992600	34.40	2.0	50.0	15.6	N	FLO
17.448900	33.60	2.1	50.0	16.4	N	FLO

Test: Passed

Test equipment used (see chapter 6)

23 - 27

5.3 Radiated emissions

5.3.1 Method of measurement

The radiated emission measurement is subdivided into five stages.

- A preliminary measurement carried out in a fully anechoic chamber with a fixed antenna height in the frequency range 9 kHz to 1 GHz.
- A final measurement carried out on an outdoor test side without reflecting ground plane and a fixed antenna height in the frequency range 9 kHz to 30 MHz.
- A final measurement carried out on an open area test side with reflecting ground plane and various antenna height in the frequency range 30 MHz to 1 GHz.
- A preliminary measurement carried out in a fully anechoic chamber with a variable antenna distance and height in the frequency range 1 GHz to 110 GHz.
- A final measurement carried out in a fully anechoic chamber with a fixed antenna height in the frequency range 1 GHz to 110 GHz.

All measurements will be carried out with the EUT working on the middle and upper and lower edge of the assigned frequency band.

Preliminary measurement (9 kHz to 30 MHz):

In the first stage a preliminary measurement will be performed in a shielded room with a measuring distance of 3 meters. Tabletop devices will set up on a non-conducting support with a size of 1 m by 1.5 m and a height of 80 cm. Floor-standing devices will be placed directly on the turntable/ground plane. The setup of the Equipment under test will be in accordance to [1].

The frequency range 9 kHz to 30 MHz will be monitored with a spectrum analyser while the system and its cables will be manipulated to find out the configuration with the maximum emission levels if applicable. The EMI Receiver will be set to MAX Hold mode. The EUT and the measuring antenna will be rotated around their vertical axis to found the maximum emissions.

The resolution bandwidth of the spectrum analyser will be set to the following values:

Frequency range	Resolution bandwidth
9 kHz to 150 kHz	200 Hz
150 kHz to 30 MHz	10 kHz

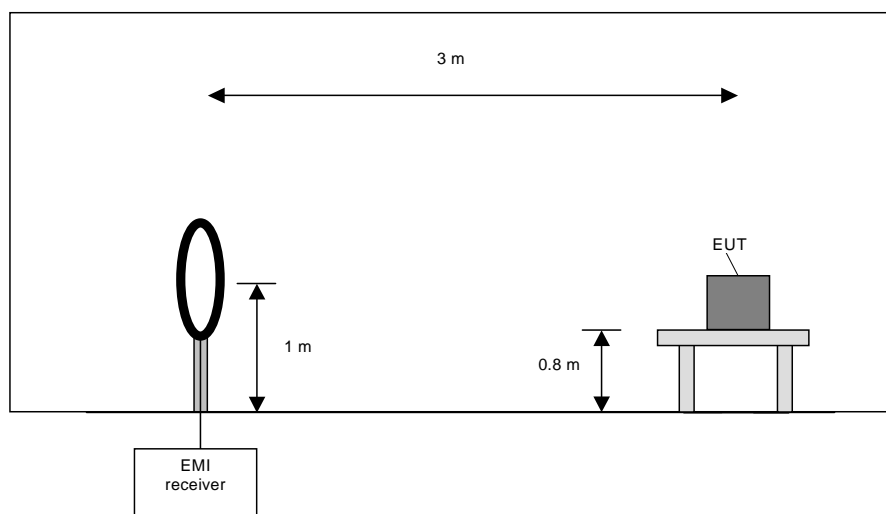

Preliminary measurement procedure:

Prescans were performed in the frequency range 9 kHz to 150 kHz and 150 kHz to 30 MHz.

The following procedure will be used:

- 1) Monitor the frequency range at horizontal polarisation and a EUT azimuth of 0 °.
- 2) Manipulate the system cables within the range to produce the maximum level of emission.
- 3) Rotate the EUT by 360 ° to maximize the detected signals.
- 4) Make a hardcopy of the spectrum.
- 5) Measure the frequencies of highest detected emission with a lower span and resolution bandwidth to increase the accuracy and note the frequency value.
- 6) Repeat steps 1) to 5) with the other orthogonal axes of the EUT (only if the EUT is a module or is used in a handheld application).
- 7) Rotate the measuring antenna and repeat steps 1) to 5).

Final measurement (9 kHz to 30 MHz):

In the second stage a final measurement will be performed on an open area test site with no conducting ground plane in a measuring distances of 3 m, 10 m and 30 m whichever is appropriate. In the case where larger measuring distances are required the results will be extrapolated based on the values measured on the closer distances according to [2]. The final measurement will be performed with a EMI Receiver set to Quasi Peak detector except for the frequency bands 9 kHz to 90 kHz and 110 kHz to 490 kHz where an average detector will be used according to [2].

On the during the preliminary measurement detected frequencies the final measurement will be performed while rotating the EUT and the measuring antenna in the range of 0 ° to 360 ° around their vertical axis until the maximum value is found.

The resolution bandwidth of the EMI Receiver will be set to the following values:

Frequency range	Resolution bandwidth
9 kHz to 150 kHz	200 Hz
150 kHz to 30 MHz	9 kHz

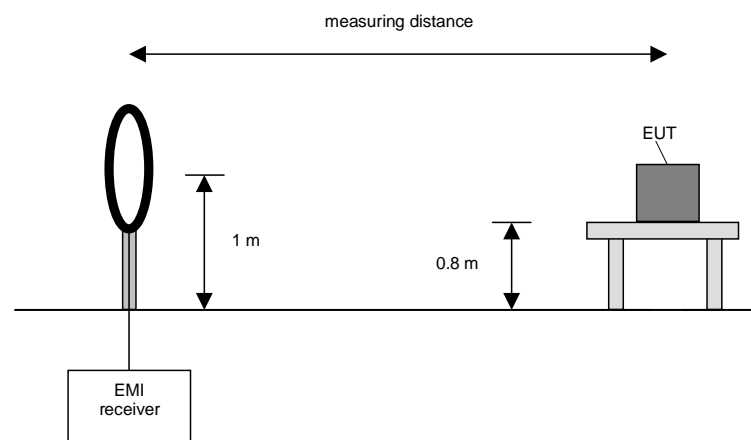

Final measurement procedure:

The following procedure will be used:

- 1) Monitor the frequency range with the measuring antenna at vertical orientation parallel to the EUT at an azimuth of 0 °.
- 2) Rotate the EUT by 360 ° to maximize the detected signals and note the azimuth and orientation.
- 3) Rotate the measuring antenna to find the maximum and note the value.
- 4) Rotate the measuring antenna and repeat steps 1) to 3) until the maximum value is found.
- 5) Repeat steps 1) to 4) with the other orthogonal axes of the EUT (only if the EUT is a module or is used in a handheld application).

Preliminary measurement (30 MHz to 1 GHz)

In the first stage a preliminary measurement will be performed in a fully anechoic chamber with a measuring distance of 3 meter. Tabletop devices will set up on a non-conducting support with a size of 1 m by 1.5 m and a height of 80 cm. Floor-standing devices will be placed directly on the turntable/ground plane. The setup of the Equipment under test will be in accordance to [1].

The frequency range 30 MHz to 1 GHz will be measured with an EMI Receiver set to MAX Hold mode and a resolution bandwidth of 100 kHz. The measurement will be performed in horizontal and vertical polarisation of the measuring antenna and while rotating the EUT in its vertical axis in the range of 0 ° to 360 °.

The resolution bandwidth of the EMI Receiver will be set to the following values:

Frequency range	Resolution bandwidth
30 MHz to 230 MHz	100 kHz
230 MHz to 1 GHz	100 kHz

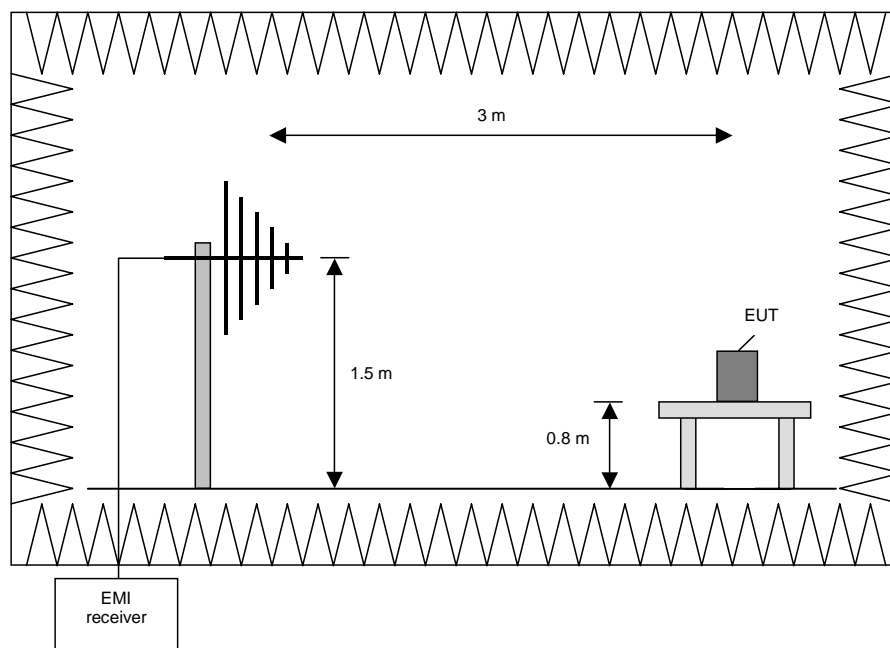

Procedure preliminary measurement:

Prescans were performed in the frequency range 30 MHz to 230 MHz and 230 MHz to 1 GHz.

The following procedure will be used:

1. Monitor the frequency range at horizontal polarisation and a EUT azimuth of 0 °.
2. Manipulate the system cables within the range to produce the maximum level of emission.
3. Rotate the EUT by 360 ° to maximize the detected signals.
4. Make a hardcopy of the spectrum.
5. Measure the frequency of the detected emissions with a lower span and resolution bandwidth to increase the accuracy and note the frequency value.
6. Repeat 1) to 4) for each orthogonal axes of the EUT (only if the EUT is a module or is used in a handheld application).
7. Repeat 1) to 5) with the vertical polarisation of the measuring antenna.

Final measurement (30 MHz to 1 GHz)

A final measurement on an open area test site will be performed on selected frequencies found in the preliminary measurement. During this test the EUT will be rotated in the range of 0 ° to 360 °, the measuring antenna will be set to horizontal and vertical polarisation and raised and lowered in the range from 1 m to 4 m to find the maximum level of emissions.

The resolution bandwidth of the EMI Receiver will be set to the following values:

Frequency range	Resolution bandwidth
30 MHz to 1 GHz	120 kHz

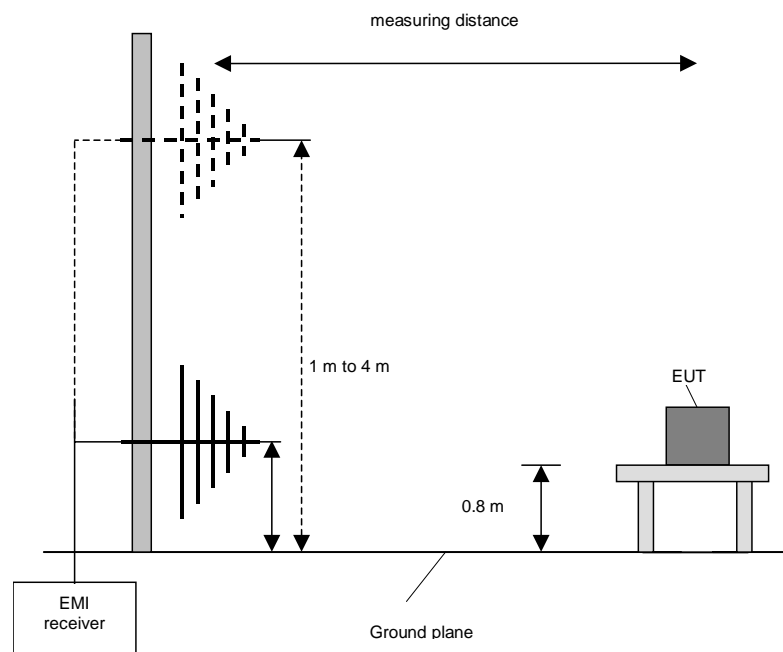

Procedure final measurement:

The following procedure will be used:

- 1) Measure on the selected frequencies at an antenna height of 1 m and a EUT azimuth of 23 °.
- 2) Move the antenna from 1 m to 4 m and note the maximum value at each frequency.
- 3) Rotate the EUT by 45 ° and repeat 2) until an azimuth of 337 ° is reached.
- 4) Repeat 1) to 3) for the other orthogonal antenna polarization.
- 5) Move the antenna and the turntable to the position where the maximum value is detected.
- 6) Measure while moving the antenna slowly +/- 1 m.
- 7) Set the antenna to the position where the maximum value is found.
- 8) Measure while moving the turntable +/- 45 °.
- 9) Set the turntable to the azimuth where the maximum value is found.
- 10) Measure with Final detector (QP and AV) and note the value.
- 11) Repeat 5) to 10) for each frequency.
- 12) Repeat 1) to 11) for each orthogonal axes of the EUT (only if the EUT is a module or is used in a handheld application).

Preliminary and final measurement (1 GHz to 110 GHz)

This measurement will be performed in a fully anechoic chamber. Tabletop devices will set up on a non-conducting support with a size of 1 m by 1.5 m and a height of 80 cm. Floor-standing devices will be placed directly on the turntable/ground plane. The setup of the Equipment under test will be in accordance to [1].

Preliminary measurement (1 GHz to 110 GHz)

The frequency range will be divided into different sub ranges depending of the frequency range of the used horn antenna. The spectrum analyser set to MAX Hold mode and a resolution bandwidth of 100 kHz. The measurement will be performed in horizontal and vertical polarisation of the measuring antenna, the antenna close to the EUT and while moving the antenna over all sides of the EUT. With the spectrum analyser in CLEAR / WRITE mode the cone of the emission should be found and then the measuring distance will be set to 3 m with the receiving antenna moving in this cone of emission. At this position the final measurement will be carried out.

The resolution bandwidth of the EMI Receiver will be set to the following values:

Frequency range	Resolution bandwidth
1 GHz to 4 GHz	100 kHz
4 GHz to 12 GHz	100 kHz
12 GHz to 18 GHz	100 kHz
18 GHz to 26.5 GHz	100 kHz
26.5 GHz to 40 GHz	100 kHz
40 GHz to 60 GHz	100 kHz
50 GHz to 75 GHz	100 kHz
75 GHz to 110 GHz	100 kHz

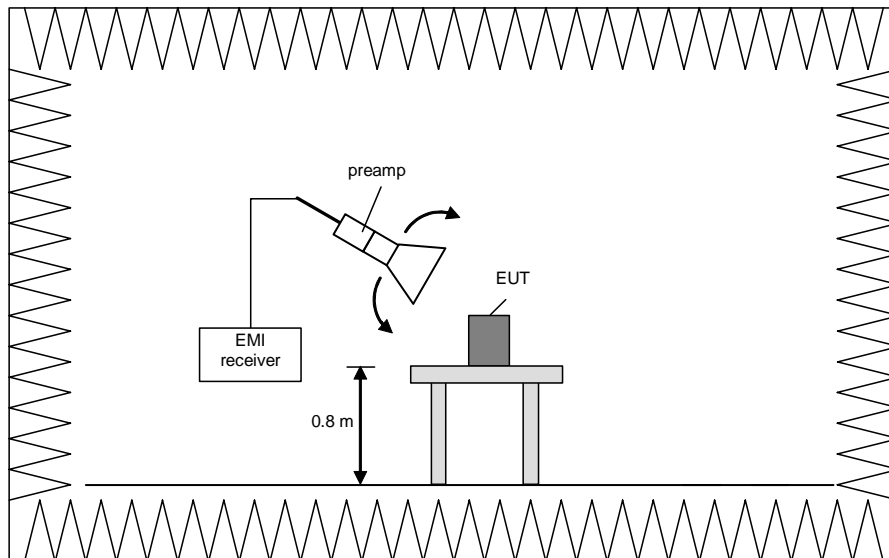

Final measurement (1 GHz to 110 GHz)

The frequency range will be divided into different sub ranges depending of the frequency range of the used horn antenna. The EMI Receiver set to peak and average mode and a resolution bandwidth of 1 MHz. The measurement will be performed in horizontal and vertical polarisation of the measuring antenna and while rotating the EUT in its vertical axis in the range of 0 ° to 360 ° in order to have the antenna inside the cone of radiation.

The resolution bandwidth of the EMI Receiver will be set to the following values:

Frequency range	Resolution bandwidth
1 GHz to 4 GHz	1 MHz
4 GHz to 12 GHz	1 MHz
12 GHz to 18 GHz	1 MHz
18 GHz to 26.5 GHz	1 MHz
26.5 GHz to 40 GHz	1 MHz
40 GHz to 60 GHz	1 MHz
50 GHz to 75 GHz	1 MHz
75 GHz to 110 GHz	1 MHz

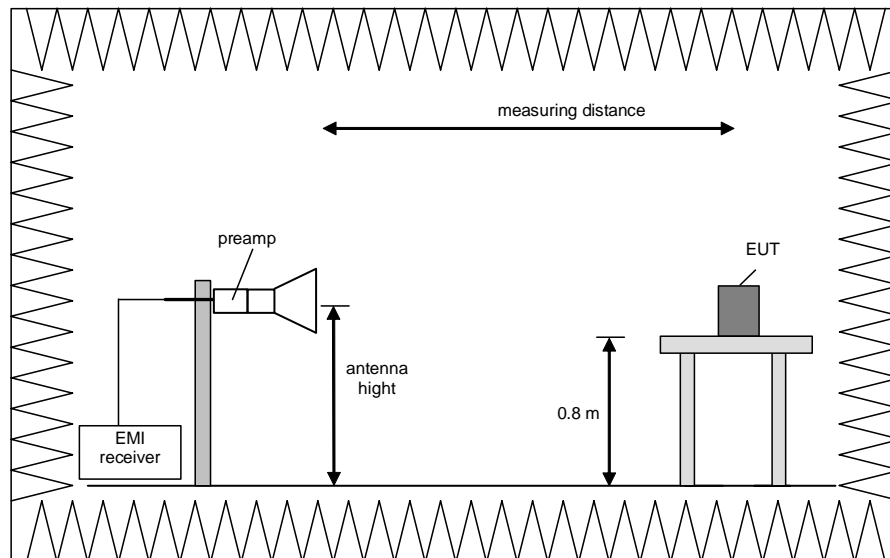

Procedure of measurement:

The measurements were performed in the frequency range 1 GHz to 4 GHz, 4 GHz to 12 GHz, 12 GHz to 18 GHz, 18 GHz to 26.5 GHz, 26.5 GHz to 40 GHz, 40 GHz to 60 GHz, 60 GHz to 75 GHz and 75 GHz to 110 GHz. The following procedure will be used:

- 1) Monitor the frequency range at horizontal polarisation and move the antenna over all sides of the EUT (if necessary move the EUT to another orthogonal axis).
- 2) Change the antenna polarisation and repeat 1) with vertical polarisation.
- 3) Make a hardcopy of the spectrum.
- 4) Measure the frequency of the detected emissions with a lower span and resolution bandwidth to increase the accuracy and note the frequency value.
- 5) Change the analyser mode to Clear / Write and found the cone of emission.
- 6) Rotate and move the EUT, so that the measuring distance can be enlarged to 3 m and the antenna will be still inside the cone of emission.
- 7) Measure the level of the detected frequency with the correct resolution bandwidth, with the antenna polarisation and azimuth and the peak and average detector, which causes the maximum emission.
- 8) Repeat steps 1) to 7) for the next antenna spot if the EUT is larger than the antenna beamwidth.

Step 1) to 6) are defined as preliminary measurement.

5.3.2 Preliminary radiated emission tests

Ambient temperature:	20 °C	Relative humidity:	45 %
----------------------	-------	--------------------	------

- Position of EUT: The EUT was set-up on a wooden table of a height of 0.8 m.
- Cable guide: The cable of the EUT was fixed on the wooden table. For further information of the cable guide refer to the pictures in annex A of this test report.
- Test record: The test was carried out in normal operation mode of the EUT (reading a TAG). All results are shown in the following.
- Power supply: During this test the EUT was powered with 24 V DC.
- Frequency range: According to [2] from 9 kHz to 30 MHz.

135053_1.wmf: Spurious emissions from 9 kHz to 150 kHz

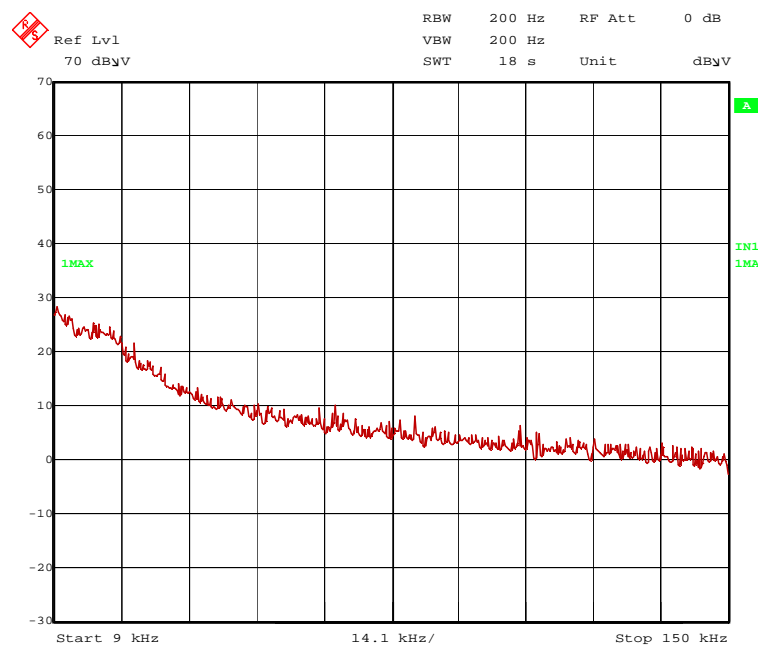

Title: Emission measurement according to FCC 15.247
EMI Test receiver ESI Rohde & Schwarz
EUT: TB-Q08-0.1.RS4.47T
Manufacturer: Turck Holding GmbH
Operating Condition: Continuous tag reading
Test site: fully anechoic chamber M20; PHOENIX TEST LAB GmbH
Operator: M. Dinter
Test Specification: 24 VDC
Comment: Ancillary outside

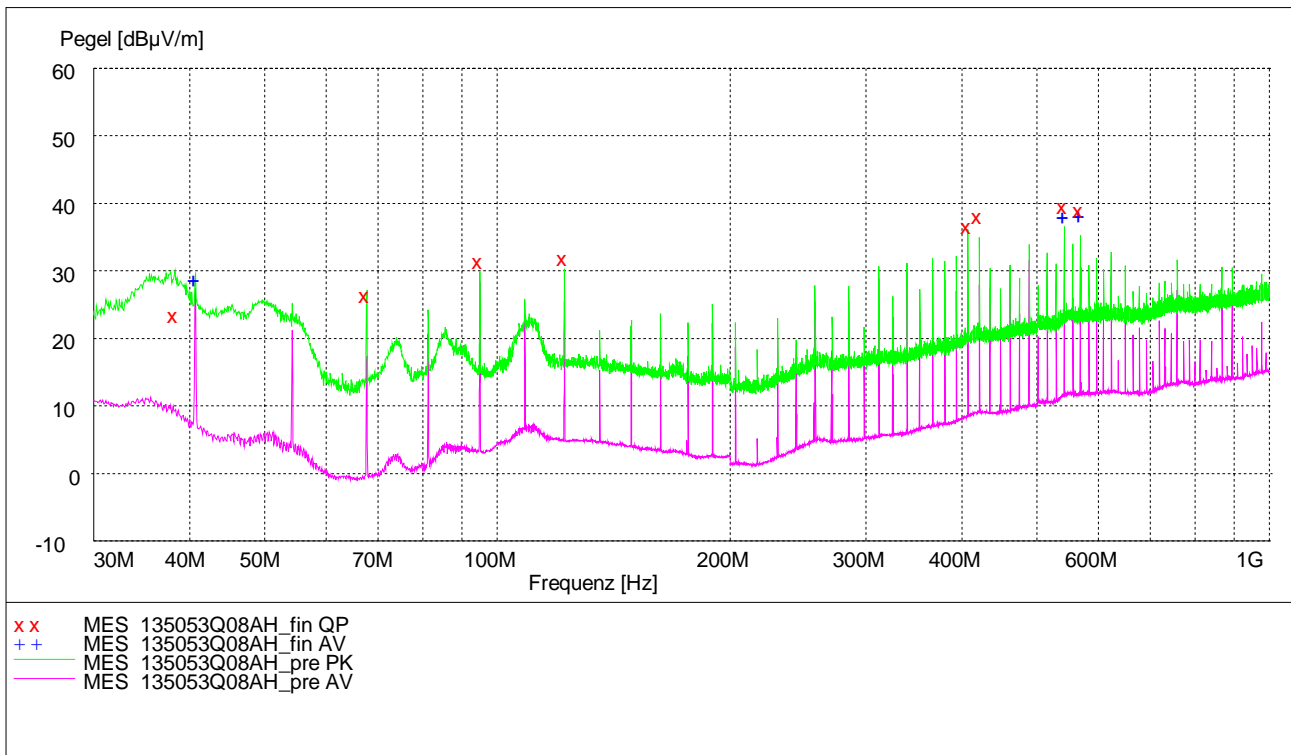

The following frequencies were found during the preliminary radiated emission test outside restricted bands: 38.256 MHz, 40.68 MHz, 67.812 MHz, 94.932 MHz, 122.028 MHz, 406.816 MHz, 542.404 MHz and 569.56 MHz.

The following frequency was found inside the restricted bands.

406.816 MHz.

These frequencies have to be measured on the open area test site. The results were presented in the following.

The following emission was found according to [2].

13.560 MHz (wanted signal is according to [2])

This frequency has to be measured on the outdoor test site. The results were presented in the following.

Test equipment used the test:

1 – 8

5.3.3 Final radiated emission tests

Ambient temperature:	12 °C	Relative humidity:	48 %
----------------------	-------	--------------------	------

Position of EUT: The EUT was set-up on a non-conducting table of a height of 0.8 m. The distance between EUT and antenna was 10 m.

Cable guide: The cable of the EUT was fixed on the non-conducting table. For further information of the cable guide refer to the pictures in annex A of this test report.

Test record: The test was carried out in normal operation mode of the EUT (reading a TAG). All results are shown in the following.

Power supply: During this test the EUT was powered with 24 V_{DC}.

Test results: The test results were calculated with the following formula:

$$\text{Result [dB}\mu\text{V/m]} = \text{reading [dB}\mu\text{V]} + \text{antenna factor [dB/m]}$$

Results with measuring distance of 10 m						
Frequency MHz	Result dB μ V/m	Limit ²⁾ dB μ V/m	Margin dB	Detector	Readings dB μ V	Antenna factor ¹⁾ dB/m
13.560	32.9	49.5	16.6	QP	58.0	20.0
Results with measuring distance of 30 m (calculated)						
Frequency MHz	Result dB μ V/m	Limit ²⁾ dB μ V/m	Margin dB	Detector	Readings dB μ V	Antenna factor ¹⁾ dB/m
13.560	12.9 ³⁾	29.5	16.6	QP	-	20.0
Measurement uncertainty			+2.2 dB / -3.6 dB			

¹⁾: Cable loss included

²⁾: Limits according to 15.209

³⁾: Level extrapolated with a factor (40 dB/decade) from the result at 10 m according to Part 15.31 (f)(2)

Test: Passed

Test equipment used for the test:

8 – 9, 11

Ambient temperature:	20 °C
----------------------	-------

Relative humidity:	47 %
--------------------	------

- Position of EUT: The EUT was set-up on a wooden table of a height of 0.8 m.
- Cable guide: The cable of the EUT was fixed on the wooden table. For further information of the cable guide refer to the pictures in annex A of this test report.
- Test record: The test was carried out in normal operation mode of the EUT (reading a TAG). All results are shown in the following.
- Power supply: During this test the EUT was powered with 24 V DC.
- Test results: The test results were calculated with the following formula:

$$\text{Result [dB}\mu\text{V/m]} = \text{reading [dB}\mu\text{V]} + \text{cable loss [dB]} + \text{antenna factor [dB/m]}$$

The measured points and the limit line in the following diagram refer to the standard measurement of the emitted interference in compliance with the above mentioned standard. The measured points marked with x are the measured results of the standard subsequent measurement on the open area test site.

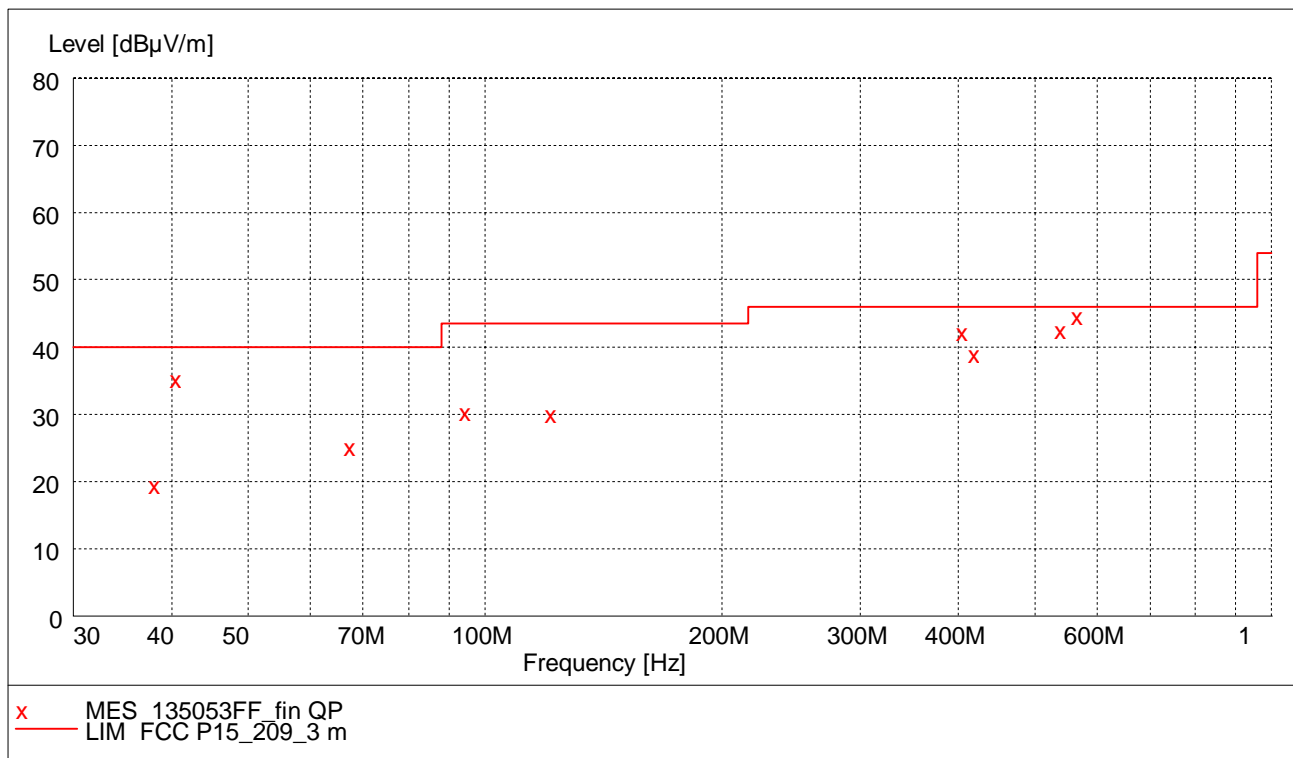

The results of the standard subsequent measurement on the open area test site are indicated in the table below. The limits as well as the measured results (levels) refer to the above mentioned standard while taking account of the specified requirements for a 3 m measuring distance.

Result measured with the quasipeak detector:
(These values are marked in the above diagram by an x)

Spurious emissions in restricted bands									
Frequency MHz	Result dB μ V/m	Limit dB μ V/m	Margin dB	Readings dB μ V	Antenna factor dB/m	Cable loss dB	Height cm	Azimuth deg	Pol.
406.816	42.6	46	3.4	24.6	15.8	2.2	257	127	Horizontal
Spurious emissions outside restricted bands									
Frequency MHz	Result dB μ V/m	Limit dB μ V/m	Margin dB	Readings dB μ V	Antenna factor dB/m	Cable loss dB	Height cm	Azimuth deg	Pol.
38.256	19.9	40	20.1	3.6	15.7	0.6	103	313	Vertical
40.680	35.6	40	4.4	20.6	14.3	0.7	100	271	Vertical
67.812	25.5	40	14.5	18.3	6.3	0.9	138	316	Vertical
94.932	30.8	43.5	12.7	19.2	10.5	1.1	125	6	Vertical
122.028	30.5	43.5	13.0	16.9	12.4	1.2	256	101	Horizontal
420.388	39.4	46	6.6	21.1	16.0	2.3	212	122	Horizontal
Measurement uncertainty				+2.2 dB / -3.6 dB					

Test: Passed

Test equipment used for the test:

12 – 18

6 Test equipment and ancillaries used for tests

No.	Test equipment	Type	Manufacturer	Serial No.	PM. No.	Cal. Date	Cal. due
1	Fully anechoic chamber M20	-	Albatross Projects	B83107-E2439-T232	480303	Weekly verification (system cal.)	
2	Measuring receiver	ESI 40	Rohde & Schwarz	100064	480355	13/02/2012 26/02/2014	02/2014 02/2015
3	Controller	HD100	Deisel	100/670	480326	-	-
4	Turntable	DS420HE	Deisel	420/620/80	480315	-	-
5	Antenna support	AS615P	Deisel	615/310	480187	-	-
6	Antenna	CBL6112 B	Chase	2688	480328	14/04/2014	04/2017
7	RF-cable No. 30	RTK 081	Rosenberger	-	410141	Weekly verification (system cal.)	
8	Loop antenna	HFH2-Z2	Rohde & Schwarz	832609/014	480059	16/02/2012 18/02/2014	02/2014 02/2016
9	EMI test receiver	ESPC	Rohde & Schwarz	843756/006	480150	09/02/2012 24/02/2014	02/2014 02/2016
11	Outdoor test site	-	Phoenix Testlab	-	480293	-	-
12	Open area test site	-	Phoenix Testlab	-	480085	Weekly verification (system cal.)	
13	Measuring receiver	ESIB7	Rohde & Schwarz	100304	480521	06/02/2013	02/2015
14	Controller	HD100	Deisel	100/670	480139	-	-
15	Turntable	DS420HE	Deisel	420/620/80	480087	-	-
16	Antenna support	AS615P	Deisel	615/310	480086	-	-
17	Antenna	CBL6111 D	Chase	25761	480894	28/09/2011	09/2014
18	EMI Software	ES-K1	Rohde & Schwarz	-	480111	-	
19	Climatic Chamber	MK 240	WTB Binder Labortechnik GmbH	05-79022	480462	18/02/2014	08/2015
20	Spectrum analyser	FSW43	Rohde & Schwarz	100586	481720	10/09/2013	09/2015
21	Loop Antenna Ø = 225 mm	-	Phoenix Testlab	-	410085	Weekly verification	
22	Spectrum analyser	FSU	Rohde & Schwarz	100586	480956	24/02/2014	02/2016
23	Shielded chamber M4	-	Siemens	B83117S1-X158	480088	Weekly verification (system cal.)	
24	Measuring receiver	ESIB 26	Rohde & Schwarz	100292	481182	09/03/2012 21/03/2014	03/2014 03/2016
25	LISN	NSLK8128	Schwarzbeck	8128155	480058	20/12/2013	12/2014
26	AC-filter	B84299-D87-E3	Siemens	930262292	480097	Weekly verification (system cal.)	
27	EMI-Software	ES-K1	Rohde & Schwarz	-	480111	-	-

7 Report history

Report Number	Date	Comment
F135053E2	27 May 2015	Document created
-	-	-

8 List of annexes

ANNEX A	Test setup photos:	5 pages
	Test setup shielded chamber	135053_11.jpg
	Test setup fully anechoic chamber (E-Field)	135053_12.jpg
	Test setup fully anechoic chamber (H-Field)	135053_13.jpg
	Test setup open area test site	135053_14.jpg
	Test setup outdoor test site	135053_15.jpg
ANNEX B	External photos:	5 pages
	TB-Q08-0.15-RS4.47T, overview with cable and plug	135053_5.jpg
	TB-Q08-0.15-RS4.47T, top view	135053_6.jpg
	TB-Q08-0.15-RS4.47T, bottom view (not grouted, PCB bottom visible)	135053_7.jpg
	TB-Q08-0.15-RS4.47T, S2500 plug	135053_9.jpg
	RFID tag	135053_10.jpg
ANNEX C	Internal photos:	2 pages
	TB-Q08-0.15-RS4.47T, PCB, top view	135053_8.jpg
	TB-Q08-0.15-RS4.47T, bottom view (not grouted, PCB bottom visible)	135053_7.jpg