

Test Report of FCC CFR 47 Part 15 Subpart C

On Behalf of

Shenzhen Ceba China Limited

FCC ID: YPX-W906
Product Description: Wireless AP
Model No.: W906
Brand Name: N/A

Prepared for: **Shenzhen Ceba China Limited**
2Floor,Building 1,Zhenbao industrial Park,Beihuan Road,ShiYan
Town,Bao'an District,Shenzhen

Prepared by: **Bontek Compliance Testing Laboratory Ltd**
1/F, Block East H-3, OCT Eastern Ind. Zone, Qiaocheng East
Road, Nanshan, Shenzhen, China
Tel: 86-755-86337020
Fax: 86-755-86337028

Report No.: BCT12BR015E
Issue Date: February 17, 2012
Test Date: February 6~17, 2012

Test by:

Reviewed By:



Kendy Wang

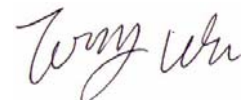

Tony Wu

TABLE OF CONTENTS

- 1. GENERAL INFORMATION 3**
 - 1.1 PRODUCT DESCRIPTION FOR EQUIPMENT UNDER TEST (EUT)..... 3
 - 1.2 RELATED SUBMITTAL(S) / GRANT (S) AND TEST METHODOLOGY..... 3
 - 1.3 TEST FACILITY..... 4
- 2. SYSTEM TEST CONFIGURATION..... 5**
 - 2.1 EUT CONFIGURATION..... 5
 - 2.2 EUT EXERCISE 5
 - 2.3 GENERAL TEST PROCEDURES..... 5
 - 2.4 MEASUREMENT UNCERTAINTY 5
 - 2.5 LIST OF MEASURING EQUIPMENTS USED..... 6
- 3. SUMMARY OF TEST RESULTS 8**
- 4. TEST OF AC POWER LINE CONDUCTED EMISSION 9**
 - 4.1 APPLICABLE STANDARD..... 9
 - 4.2 TEST SETUP DIAGRAM..... 9
 - 4.3 TEST RESULT 9
- 5. TEST OF MAXIMUM PEAK OUTPUT POWER 12**
 - 5.1 APPLICABLE STANDARD..... 12
 - 5.2 EUT SETUP..... 12
 - 5.3 TEST EQUIPMENT LIST AND DETAILS 12
 - 5.4 TEST PROCEDURE 12
 - 5.5 TEST RESULT 12
- 6. TEST OF PEAK POWER SPECTRAL DENSITY 18**
 - 6.1 APPLICABLE STANDARD..... 18
 - 6.2 EUT SETUP..... 18
 - 6.3 TEST EQUIPMENT LIST AND DETAILS 18
 - 6.4 TEST PROCEDURE 18
 - 6.5 TEST RESULT 18
- 7. TEST OF 6DB BANDWIDTH..... 24**
 - 7.1 APPLICABLE STANDARD..... 24
 - 7.2 EUT SETUP..... 24
 - 7.3 TEST EQUIPMENT LIST AND DETAILS 24
 - 7.4 TEST PROCEDURE 24
 - 7.5 TEST RESULT 24
- 8. TEST OF CONDUCTED SPURIOUS EMISSION 30**
 - 8.1 APPLICABLE STANDARD..... 30
 - 8.2 EUT SETUP..... 30
 - 8.3 TEST EQUIPMENT LIST AND DETAILS 30
 - 8.4 TEST PROCEDURE 30
 - 8.5 TEST RESULT 30
- 9. TEST OF RADIATED SPURIOUS EMISSION 33**
 - 9.1 RADIATED SPURIOUS EMISSION 33
 - 9.1.1 LIMITS..... 33
 - 9.1.2 EUT SETUP 34
 - 9.1.3 TEST PROCEDURE 35
 - 9.1.4 TEST RESULT..... 35
 - 9.2 RESTRICTED BAND EDGES..... 43
- 10. ANTENNA REQUIREMENT 52**
 - 10.1 STANDARD APPLICABLE..... 52
 - 10.2 ANTENNA CONNECTED CONSTRUCTION 52

1. GENERAL INFORMATION

1.1 Product Description for Equipment Under Test (EUT)

Client Information

Applicant: **Shenzhen Ceba China Limited**
Address of applicant: 2Floor,Building 1,Zhenbao industrial Park,Beihuan Road,ShiYan Town,Bao'an District,Shenzhen
Manufacturer: **Shenzhen Ceba China Limited**
Address of manufacturer: 2Floor,Building 1,Zhenbao industrial Park,Beihuan Road,ShiYan Town,Bao'an District,Shenzhen

General Description of E.U.T

Items	Description
EUT Description:	Wireless AP
Trade Name:	N/A
Model No.:	W906
Frequency Band:	IEEE 802.11b/g: 2412MHz~2462MHz,
Channel Spacing:	IEEE 802.11b/g: 5MHz
Number of Channels:	IEEE 802.11b/g: 11 Channels
Transmit Data Rate:	IEEE802.11b: 11 , 5.5 , 2 , 1 Mbps IEEE802.11g: 54 , 48 , 36 , 24 , 18 , 12 , 9 , 6 Mbps
Type of Modulation:	IEEE 802.11b: DSSS (CCK, DQPSK, DBPSK) IEEE 802.11g: OFDM (64QAM, 16QAM, QPSK, BPSK)
Antenna Type:	Built-in Antenna
Rated Voltage:	Input: USB DC5V

Remark: * The test data gathered are from the production sample provided by the manufacturer.

1.2 Related Submittal(s) / Grant (s) and Test Methodology

The tests were performed based on the Electromagnetic Interference (EMI) tests performed on the EUT. Both conducted and radiated testing were performed according to the procedures in ANSI C63.4 - 2003 Radiated testing was performed at an antenna to EUT distance 3 meters.

The tests were performed in order to determine compliance with FCC Part 15, Subpart C, and section 15.203, 15.207, 15.209 and 15.247 rules.

1.3 Test Facility

All measurement required was performed at laboratory of Bontek Compliance Testing Laboratory Ltd at 1/F, Block East H-3, OCT Eastern Ind. Zone, Qiaocheng East Road, Nanshan, Shenzhen, China.

The test facility is recognized, certified, or accredited by the following organizations:

FCC – Registration No.: 338263

BONTEK COMPLIANCE TESTING LABORATORY LTD. EMC Laboratory has been registered and fully described in a report filed with the (FCC) Federal Communications Commission. The acceptance letter from the FCC is maintained in our files. Registration 338263, March, 2008.

IC Registration No.: 7631A

The 3m alternate test site of BONTEK COMPLIANCE TESTING LABORATORY LTD. EMC Laboratory has been registered by Certification and Engineer Bureau of Industry Canada for the performance of with Registration NO.: 7631A on August 2009.

CNAS - Registration No.: L3923

BONTEK COMPLIANCE TESTING LABORATORY LTD. to ISO/IEC 17025:25 General Requirements for the Competence of Testing and Calibration Laboratories(CNAS-CL01 Accreditation Criteria for the Competence of Testing and Calibration Laboratories) for the competence in the field of testing. The acceptance letter from the CNAS is maintained in our files: Registration: L3923,February,2009.

TUV - Registration No.: UA 50203122-0001

BONTEK COMPLIANCE TESTING LABORATORY LTD. An assessment of the laboratory was conducted according to the"Procedures and Conditions for EMC Test Laboratories"with reference to EN ISO/IEC 17025 by a TUV Rheinland auditor. Audit Report NO. 17010783-002.

2. SYSTEM TEST CONFIGURATION

2.1 EUT Configuration

The EUT configuration for testing is installed on RF field strength measurement to meet the Commissions requirement and operating in a manner that intends to maximize its emission characteristics in a continuous normal application.

2.2 EUT Exercise

The calibrated antennas used to sample the radiated field strength are mounted on a non-conductive, motorized antenna mast 3 or 10 meters from the leading edge of the turntable.

2.3 General Test Procedures

Conducted Emissions: The EUT is placed on the turntable, which is 0.8 m above ground plane. According to the requirements in Section 7.1 of ANSI C63.4-2003 Conducted emissions from the EUT measured in the frequency range between 0.15 MHz and 30MHz using CISPR Quasi-Peak detector mode.

Radiated Emissions: The EUT is a placed on as turntable, which is 0.8 m above ground plane. The turntable shall rotate 360 degrees to determine the position of maximum emission level. EUT is set 3m away from the receiving antenna, which varied from 1m to 4m to find out the highest emission. And also, each emission was to be maximized by changing the polarization of receiving antenna both horizontal and vertical. In order to find out the maximum emissions, exploratory radiated emission measurements were made according to the requirements in Section 13.1.4.1 of ANSI C63.4-2009.

2.4 Measurement Uncertainty

Where relevant, the following measurement uncertainty levels have been estimated for tests performed on the apparatus:

Parameter	Uncertainty
Power Line Conducted Emission	+/- 2.3 dB
Radiated Emission	+/- 3.4 dB

Uncertainty figures are valid to a confidence level of 95%.

2.5 List of Measuring Equipments Used

No.	Equipment	Manufacturer	Model No.	S/N	Calibration Date	Calibration Due Date
1	EMI Test Receiver	R&S	ESCI	100687	2011-4-07	2012-4-06
2	EMI Test Receiver	R&S	ESPI	100097	2011-4-07	2012-4-06
3	Amplifier	HP	8447D	1937A02492	2011-4-07	2012-4-06
4	Single Power Conductor Module	FCC	FCC-LISN-5-50-1-01-CISPR25	7101	2011-4-07	2012-4-06
5	Single Power Conductor Module	FCC	FCC-LISN-5-50-1-01-CISPR25	7102	2011-4-07	2012-4-06
6	Power Clamp	SCHWARZBECK	MDS-21	3812	2011-4-07	2012-4-06
7	Positioning Controller	C&C	CC-C-1F	MF7802113	N/A	N/A
8	Electrostatic Discharge Simulator	TESEQ	NSG437	125	2011-4-07	2012-4-06
9	Fast Transient Burst Generator	SCHAFFNER	MODULA6150	34572	2011-4-07	2012-4-06
10	Fast Transient Noise Simulator	Noiseken	FNS-105AX	31485	2011-4-07	2012-4-06
11	Color TV Pattern Generator	PHILIPS	PM5418	TM209947	N/A	N/A
12	Power Frequency Magnetic Field Generator	EVERFINE	EMS61000-8K	608002	2011-4-07	2012-4-06
14	Capacitive Coupling Clamp	TESEQ	CDN8014	25096	2011-4-07	2012-4-06
15	High Field Biconical Antenna	ELECTRO-METRICS	EM-6913	166	2010-4-14	2012-4-13
16	Log Periodic Antenna	ELECTRO-METRICS	EM-6950	811	2010-4-14	2012-4-13
17	Remote Active Vertical Antenna	ELECTRO-METRICS	EM-6892	304	2010-4-14	2012-4-13
18	TRILOG Broadband Test-Antenna	SCHWARZBECK	VULB9163	9163-324	2010-4-14	2012-4-13
19	Horn Antenna	SCHWARZBECK	BBHA9120A	B08000991-0001	2010-4-14	2012-4-13
20	Teo Line Single Phase Module	SCHWARZBECK	NSLK8128	D-69250	2011-4-07	2012-4-06
21	10dB attenuator	SCHWARZBECK	MTAIMP-136	R65.90.0001#06	2011-4-07	2012-4-06
22	Electric bridge	Zentech	100 LCR METER	803024	N/A	N/A
23	RF Current Probe	FCC	F-33-4	80	2011-4-07	2012-4-06
24	Triple-Loop Antenna	EVERFINE	LLA-2	607004	2011-4-07	2012-4-06
25	CDN	FRANKONIA	M2+M3	A3027019	2011-4-07	2012-4-06

26	6dB Attenuator	FRANKONIA	75-A-FFN-06	1001698	2011-4-07	2012-4-06
27	EMV-Mess-Systeme GMBH	FRANKONIA	FLL-75	1020A1109	2011-4-07	2012-4-06
28	EM Injection Clamp	FCC	F-203I-13mm	91536	2011-4-07	2012-4-06
29	9KHz-2.4GHz Signal generator	MARCONI INSTRUMENTS	2024	112260/042	2011-4-07	2012-4-06
30	Broadband Preamplifier	SCHWARZBECK	BBV 9718	9718-182	2011-4-07	2012-4-06
31	Harmonics& Flicker Analyser	Voltech	PM6000	AFC-150	2011-4-07	2012-4-06
32	Spectrum Analyzer	R&S	FSP30	1093.4495.30	2011-4-07	2012-4-06
33	Temperature & Humidity Chamber	TOPSTAT	TOS-831A	3438A05208	2011-4-07	2012-4-06

3. SUMMARY OF TEST RESULTS

FCC Rules	Description of Test	Result
FCC §15.207	AC Power Line Conducted Emission	Pass
FCC §15.247(b)	Maximum Peak Output Power	Pass
FCC §15.247(e)	Power Spectral Density	Pass
FCC §15.247(a)	6dB Bandwidth	Pass
FCC §15.247 (d)	Conducted Spurious Emission	Pass
FCC §15.205 and §15.209 &	Radiated Spurious Emission	Pass
FCC §15.203/15.247(b)/(c)	Antenna Requirement	Pass

4. TEST OF AC POWER LINE CONDUCTED EMISSION

4.1 Applicable Standard

Refer to FCC §15.207.

For a Low-power Radio-frequency Device is designed to be connected to the AC power line, the radio frequency voltage that is conducted back onto the AC power line on any frequency or frequencies within the band 150 kHz to 30 MHz shall not exceed below limits table.

Frequency Range (MHz)	Limits (dBuV)	
	Quasi-Peak	Average
0.150~0.500	66~56	56~46
0.500~5.000	56	46
5.000~30.00	60	50

4.2 Test Setup Diagram

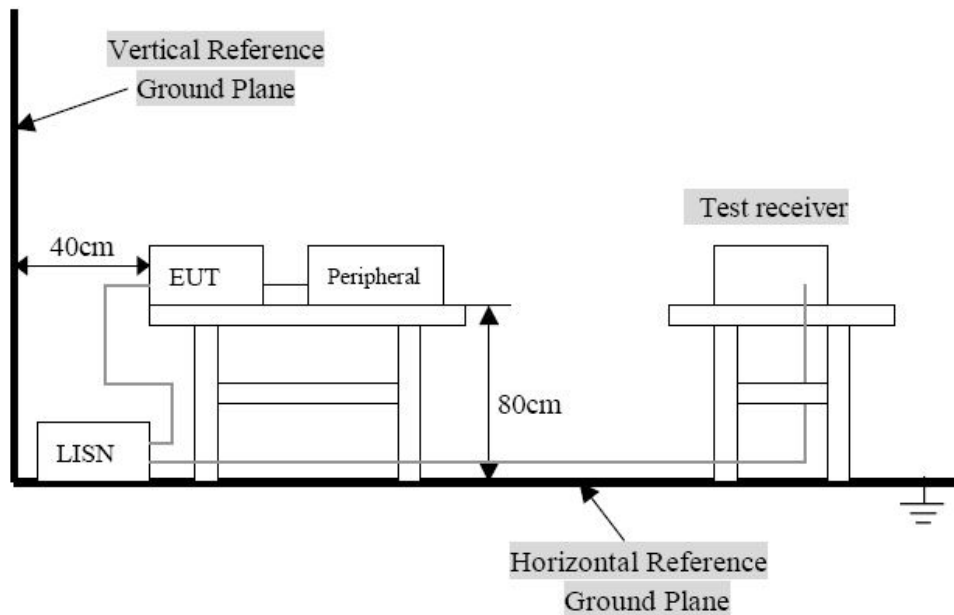

Remark: The EUT was connected to a 120VAC/ 60Hz power source.

4.3 Test Result

Temperature (°C) : 23~25	EUT: Wireless AP
Humidity (%RH) : 45~58	M/N: W906
Barometric Pressure (mbar) : 950~1000	Operation Condition: ON

Conducted Emission:

EUT: Wireless AP
 Operating Condition: ON
 Test Site: Shielded Room
 Operator: Andy
 Test Specification: USB DC5V from PC
 Comment: Live Line

SCAN TABLE: "Voltage (9K-30M) FIN"
 Short Description: 150K-30M Voltage

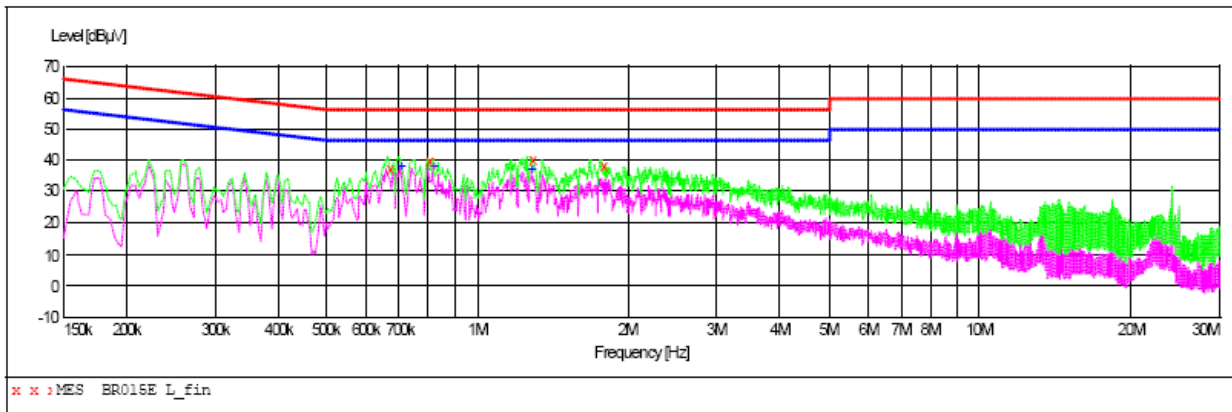

MEASUREMENT RESULT: "BR015E L_fin"

2/13/2012 20:35

Frequency MHz	Level dBµV	Transd dB	Limit dBµV	Margin dB	Detector	Line	PE
0.663000	37.60	10.2	56	18.4	QP	L1	GND
0.798000	39.40	10.1	56	16.6	QP	L1	GND
1.279500	40.00	10.1	56	16.0	QP	L1	GND
1.761000	38.90	10.1	56	17.1	QP	L1	GND

MEASUREMENT RESULT: "BR015E L_fin2"

2/13/2012 20:35

Frequency MHz	Level dBµV	Transd dB	Limit dBµV	Margin dB	Detector	Line	PE
0.703500	38.30	10.2	46	7.7	AV	L1	GND
0.816000	38.90	10.1	46	7.1	AV	L1	GND
1.279500	37.20	10.1	46	8.8	AV	L1	GND

Conducted Emission:

EUT: Wireless AP
 Operating Condition: ON
 Test Site: Shielded Room
 Operator: Andy
 Test Specification: USB DC5V from PC
 Comment: Neutral Line

SCAN TABLE: "Voltage (9K-30M)FIN"
 Short Description: 150K-30M Voltage

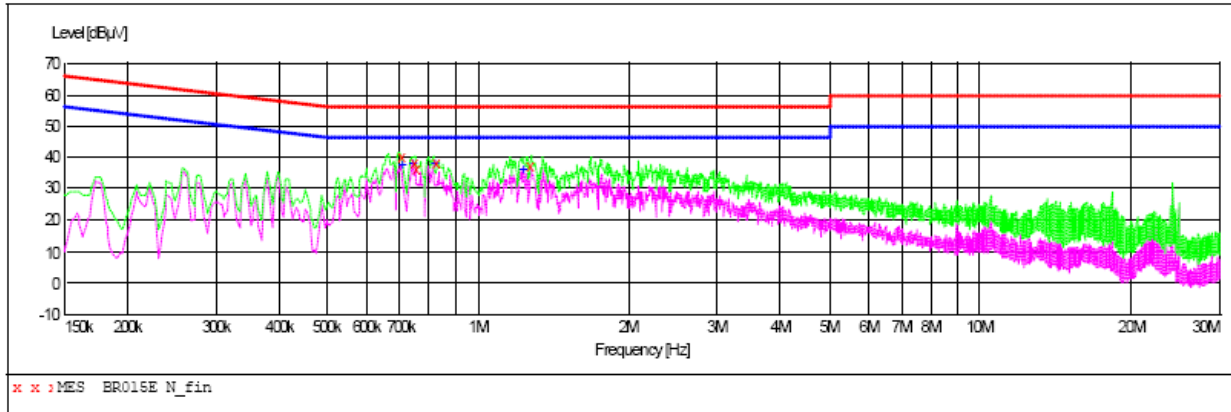

MEASUREMENT RESULT: "BR015E N_fin"

2/13/2012 20:31

Frequency MHz	Level dBuV	Transd dB	Limit dBuV	Margin dB	Detector	Line	PE
0.694500	39.80	10.2	56	16.2	QP	N	GND
0.739500	38.80	10.2	56	17.2	QP	N	GND
0.744000	36.20	10.2	56	19.8	QP	N	GND
0.816000	38.90	10.1	56	17.1	QP	N	GND
1.252500	37.50	10.1	56	18.5	QP	N	GND

MEASUREMENT RESULT: "BR015E N_fin2"

2/13/2012 20:31

Frequency MHz	Level dBuV	Transd dB	Limit dBuV	Margin dB	Detector	Line	PE
0.703500	38.00	10.2	46	8.0	AV	N	GND
0.739500	38.60	10.2	46	7.4	AV	N	GND
0.816000	38.40	10.1	46	7.6	AV	N	GND
1.230000	36.20	10.1	46	9.8	AV	N	GND

5. Test of Maximum Peak Output Power

5.1 Applicable Standard

Refer to FCC §15.247 (b)

5.2 EUT Setup

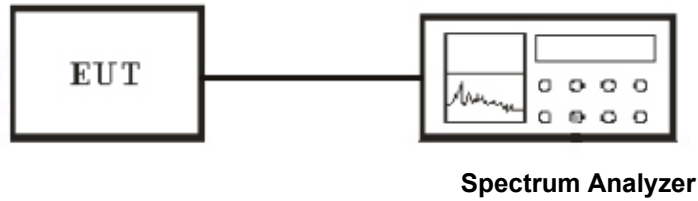

5.3 Test Equipment List and Details

See section 2.5.

5.4 Test Procedure

Connect the EUT to spectrum analyzer, set the center frequency of the spectrum analyzer to the channel center frequency. Set the RBW to 1MHz and VBW to 3MHz.

Measurement of Digital Transmission Systems Operating under Section 15.247

5.5 Test Result

Temperature (°C) : 22~23	EUT: Wireless AP
Humidity (%RH) : 50~54	M/N: W906
Barometric Pressure (mbar) : 950~1000	Operation Condition: Tx Mode

IEEE 802.11b mode

Channel	Channel Frequency (MHz)	Peak Power Chain C (dBm)	Peak Power Limit (dBm)	Pass / Fail
Low	2412	9.91	30	PASS
Middle	2437	10.33	30	PASS
High	2462	10.13	30	PASS

NOTE : 1. At final test to get the worst-case emission at 11Mbps.

IEEE 802.11g mode

Channel	Channel Frequency (MHz)	Peak Power (dBm)	Peak Power Limit (dBm)	Pass / Fail
Low	2412	8.37	30	PASS
Middle	2437	8.82	30	PASS
High	2462	8.51	30	PASS

NOTE : 1. At final test to get the worst-case emission at 6Mbps.

MAXIMUM PEAK OUTPUT POWER (802.11b MODE CH Low)

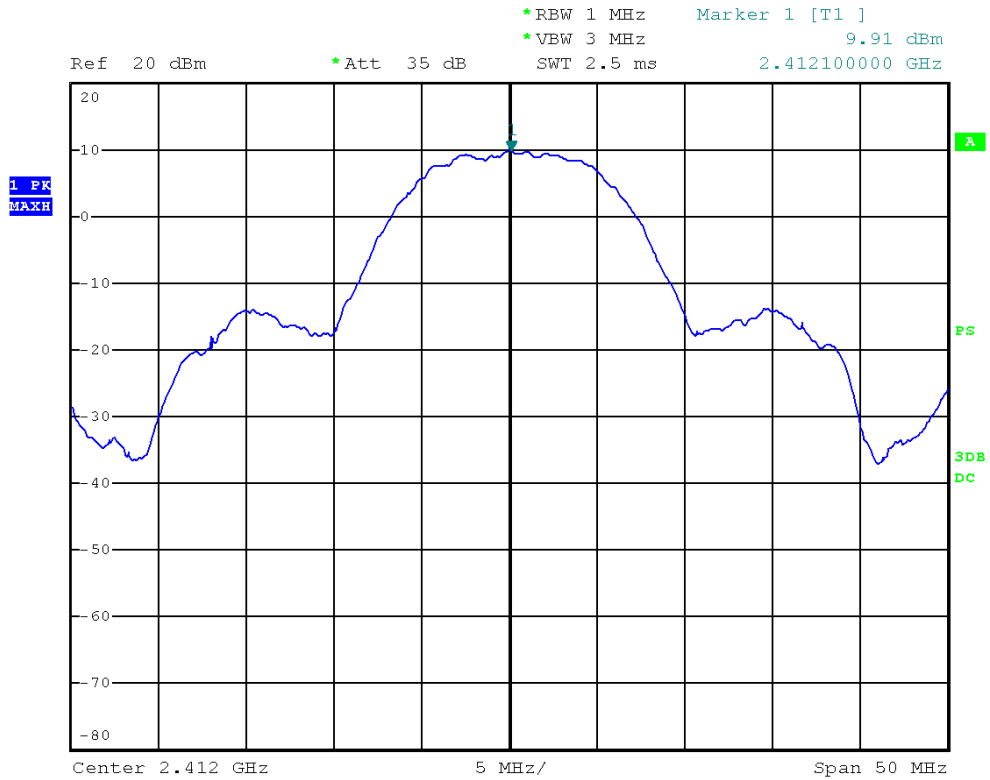

MAXIMUM PEAK OUTPUT POWER (802.11b MODE CH Mid)

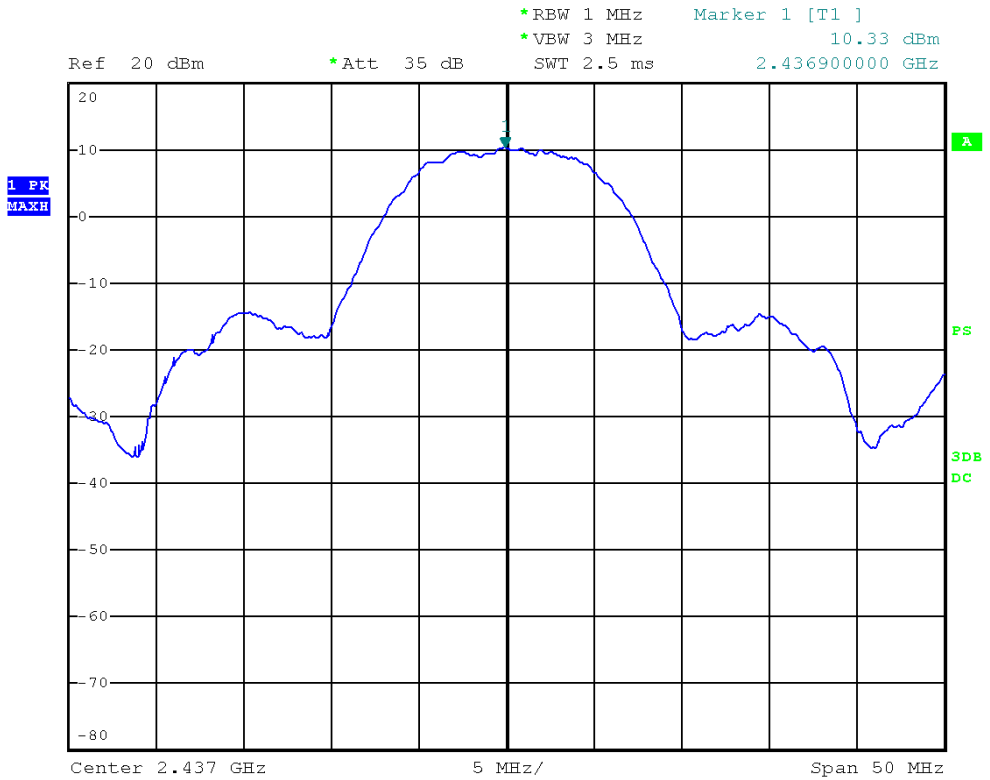

MAXIMUM PEAK OUTPUT POWER (802.11b MODE CH High)

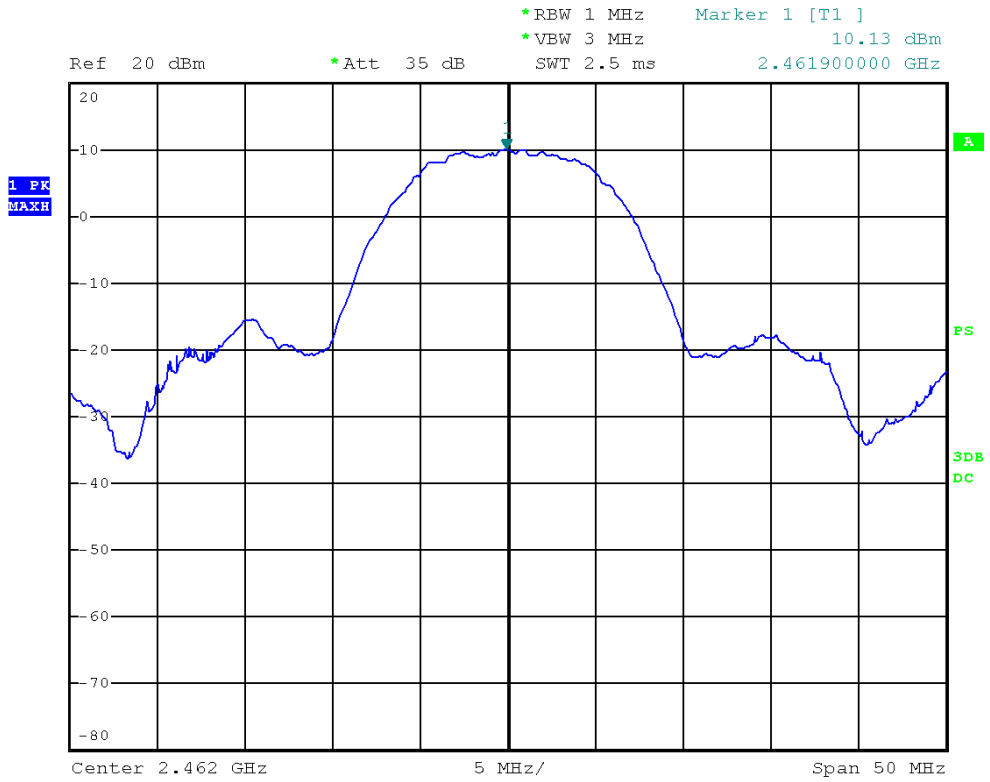

MAXIMUM PEAK OUTPUT POWER (802.11g MODE CH Low)

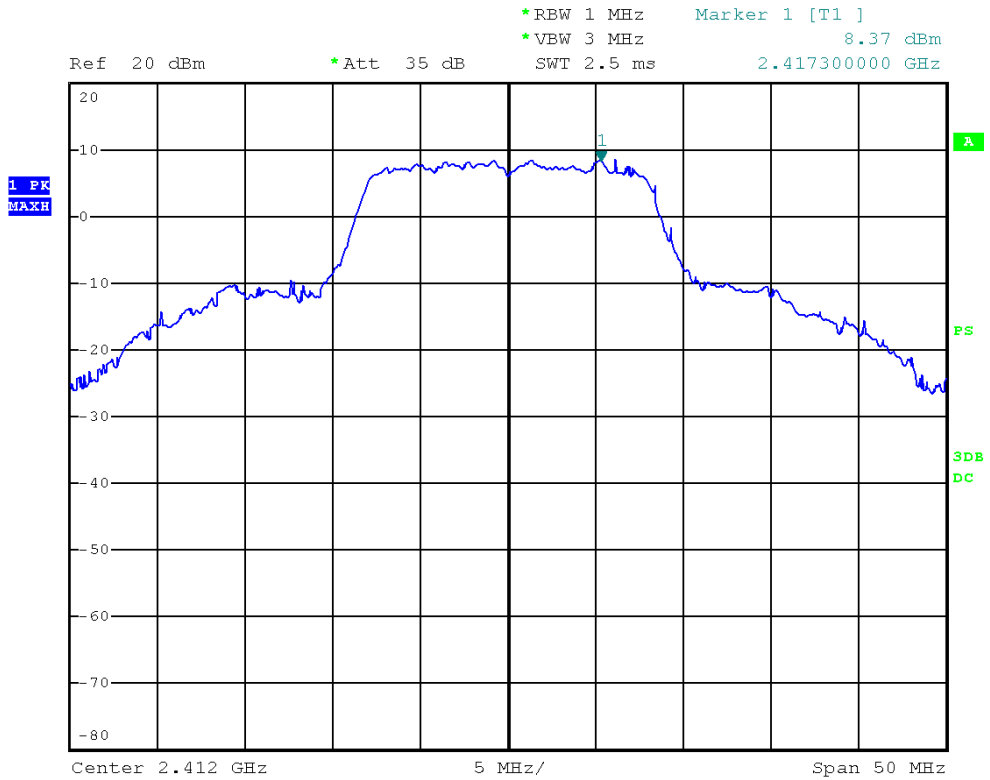

MAXIMUM PEAK OUTPUT POWER (802.11g MODE CH Mid)

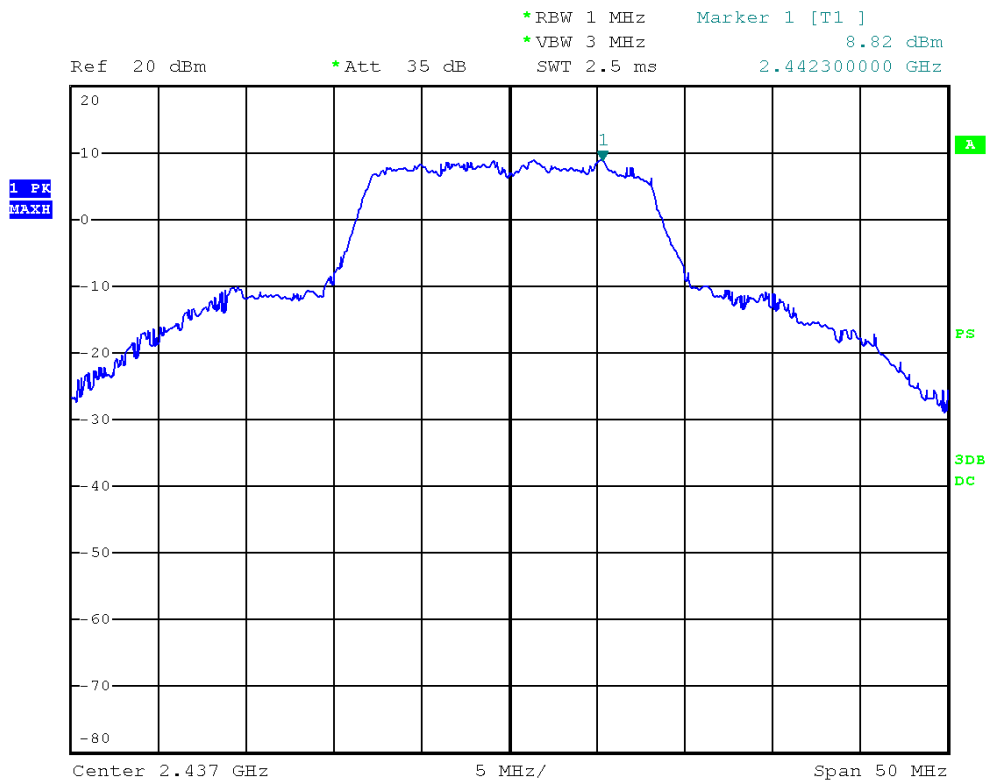

MAXIMUM PEAK OUTPUT POWER (802.11g MODE CH High)

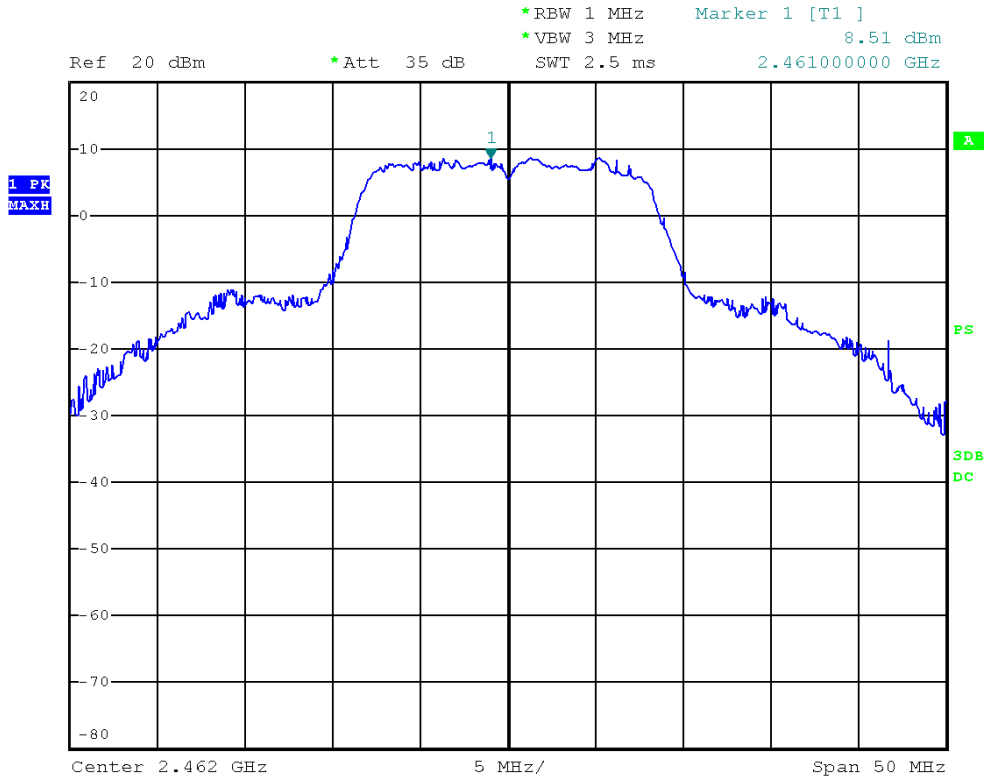

6. Test of Peak Power Spectral Density

6.1 Applicable Standard

Refer to FCC §15.247 (e).

The power spectral density conducted from the transmitter to the antenna shall not be greater than 8 dBm in any 3 kHz band during any time interval of continuous transmission.

6.2 EUT Setup

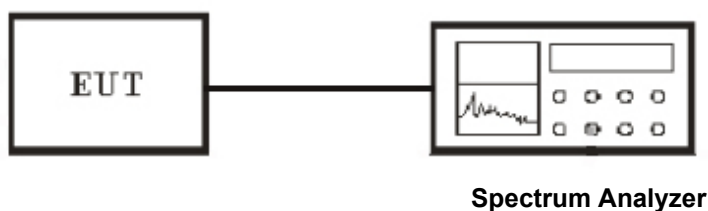

6.3 Test Equipment List and Details

See section 2.5.

6.4 Test Procedure

The transmitter output was connected to the spectrum analyzer, the bandwidth of the fundamental frequency was measured with the spectrum analyzer using RBW=3KHz and VBW \cong RBW, set sweep time=span / 3KHz.

The power spectral density was measured and recorded. The sweep time is allowed to be longer than span / 3KHz for a full response of the mixer in the spectrum analyzer.

NOTE: Total peak power calculation formula:

$$10 \log (10^{\text{Chain A Power} / 10} + 10^{\text{Chain C Power} / 10}).$$

6.5 Test Result

Temperature (°C) : 22~23	EUT: Wireless AP
Humidity (%RH) : 50~54	M/N: W906
Barometric Pressure (mbar) : 950~1000	Operation Condition: Tx Mode

IEEE 802.11b mode

Channel	Channel Frequency (MHz)	Final RF Power Level in 3KHz BW (dBm)	Maximum Limit (dBm)	Pass / Fail
Low	2412	-12.21	8	PASS
Middle	2437	-15.14	8	PASS
High	2462	-11.36	8	PASS

NOTE : 1. At final test to get the worst-case emission at 11Mbps.

IEEE 802.11g mode

Channel	Channel Frequency (MHz)	Final RF Power Level in 3KHz BW (dBm)	Maximum Limit (dBm)	Pass / Fail
Low	2412	-15.26	8	PASS
Middle	2437	-15.02	8	PASS
High	2462	-14.57	8	PASS

NOTE : 1. At final test to get the worst-case emission at 6Mbps.

POWER SPECTRAL DENSITY (802.11b MODE CH Low)

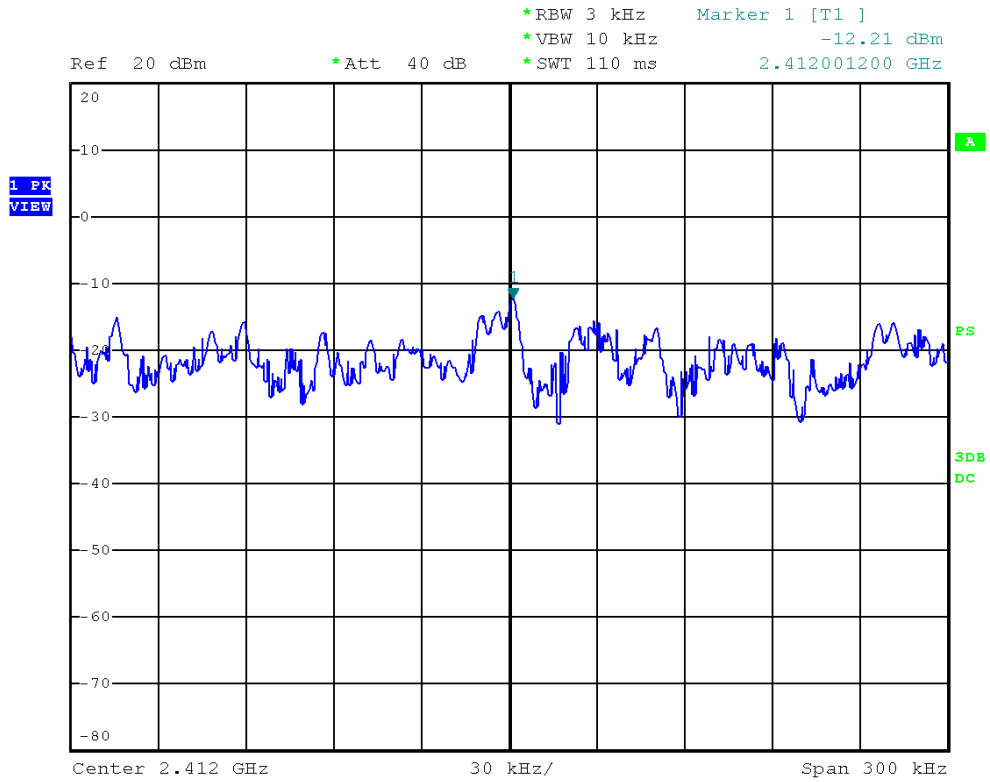

POWER SPECTRAL DENSITY (802.11b MODE CH Mid)

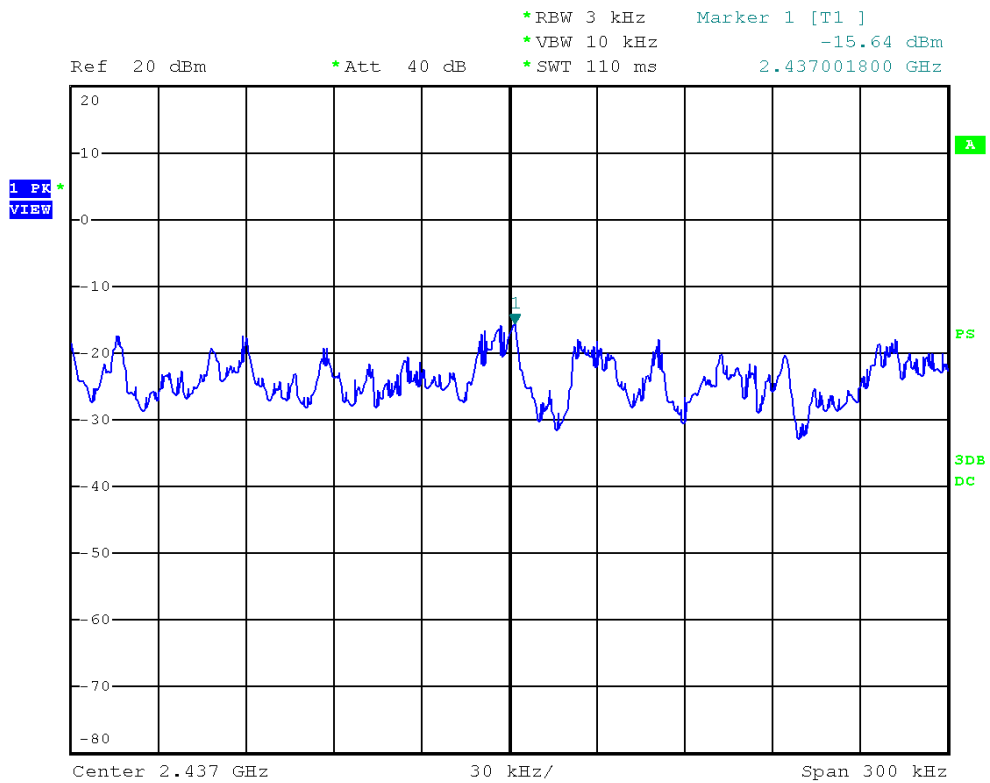

POWER SPECTRAL DENSITY (802.11b MODE CH High)

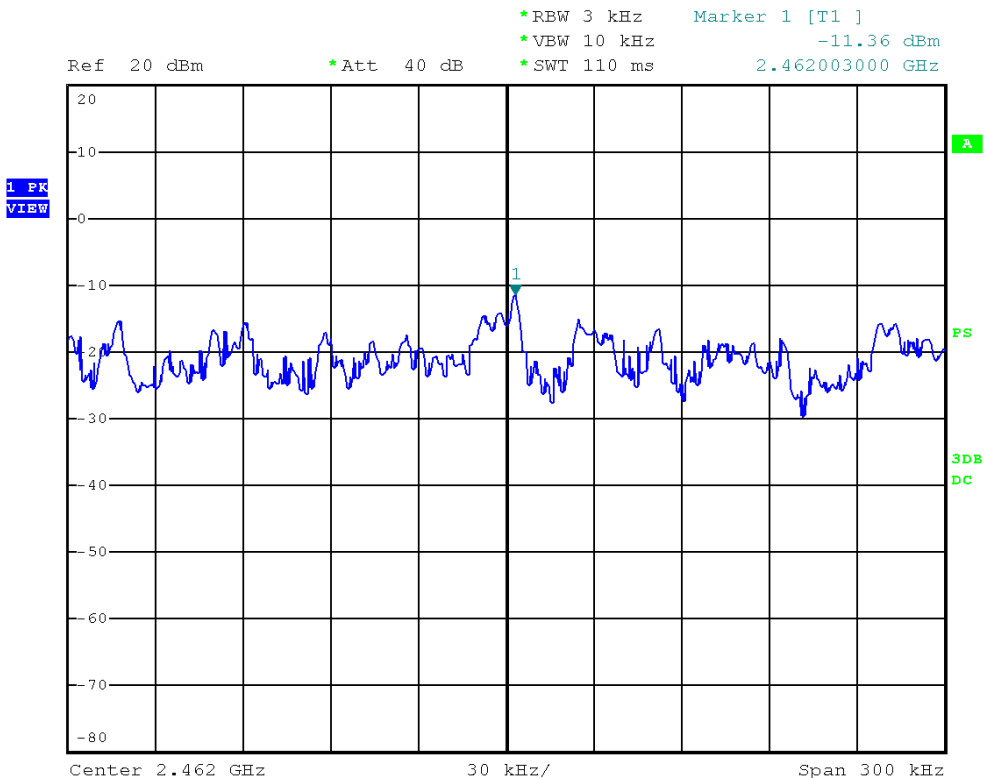

POWER SPECTRAL DENSITY (802.11g MODE CH Low)

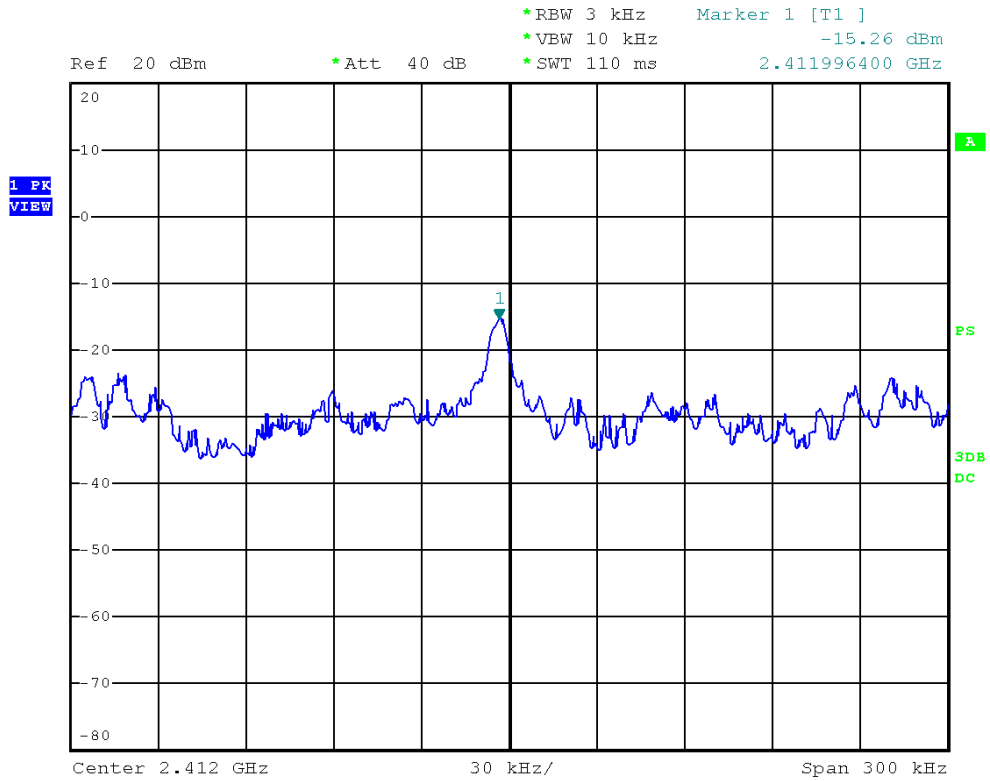

POWER SPECTRAL DENSITY (802.11g MODE CH Mid)

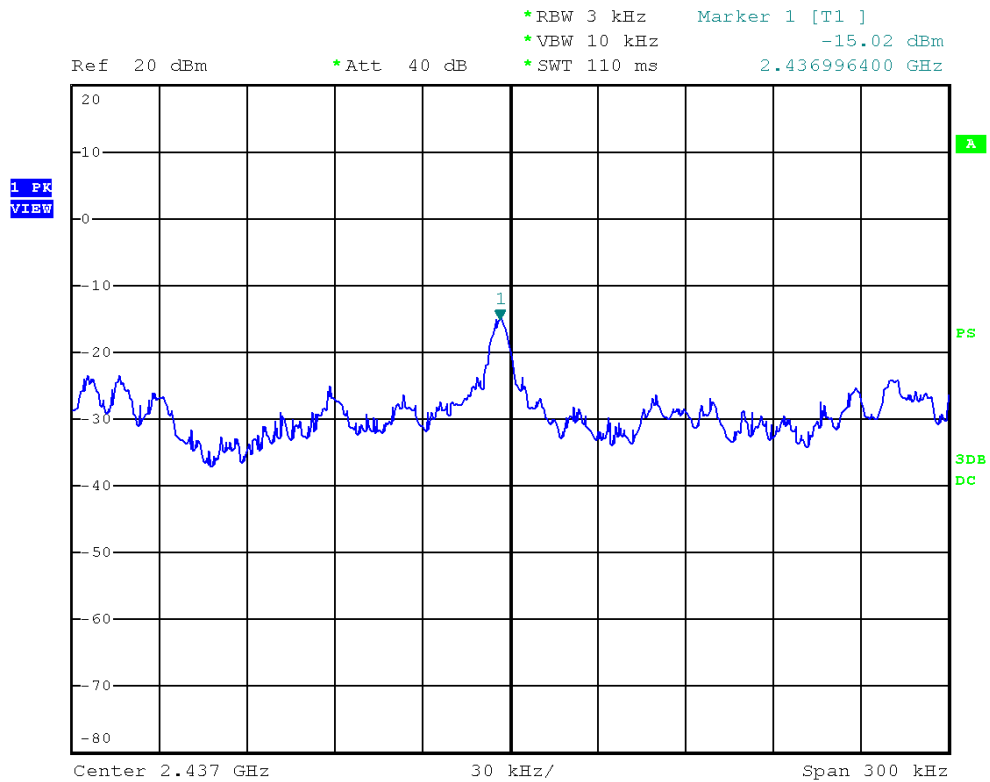

POWER SPECTRAL DENSITY (802.11g MODE CH High)

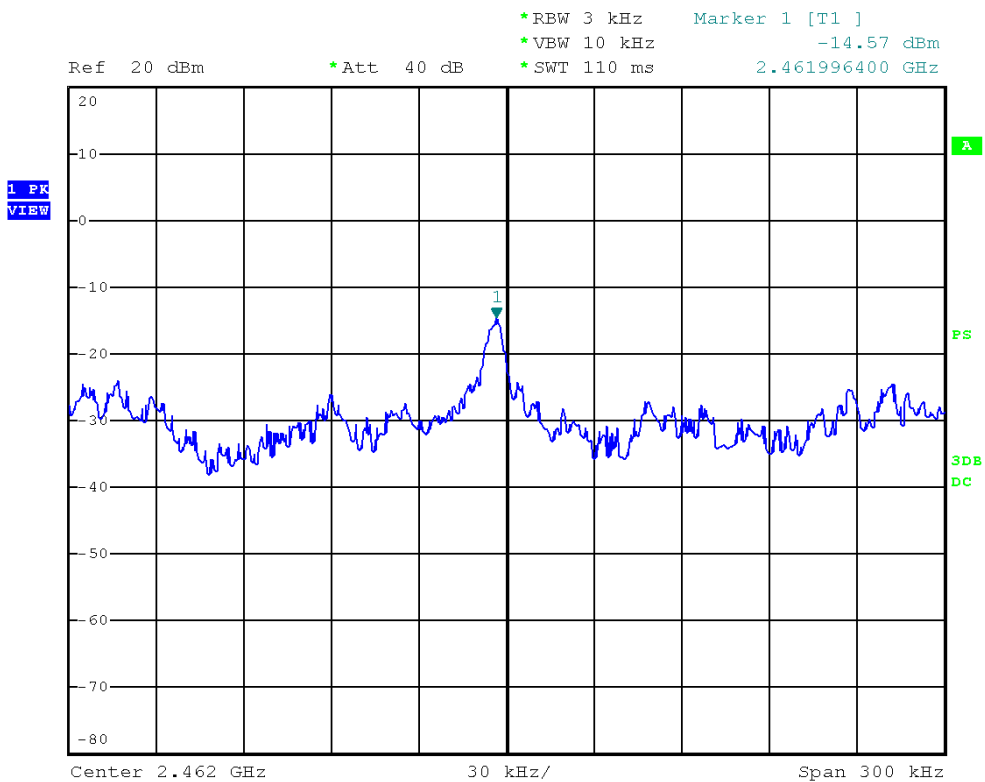

7. Test of 6dB Bandwidth

7.1 Applicable Standard

Refer to FCC §15.247 (a) (2).

The minimum 6 dB bandwidth shall be at least 500 kHz.

7.2 EUT Setup

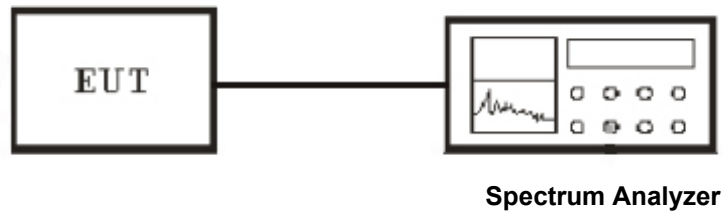

7.3 Test Equipment List and Details

See section 2.5.

7.4 Test Procedure

The transmitter output was connected to a spectrum analyzer. The bandwidth of the fundamental frequency was measured by spectrum analyzer with 100 kHz RBW and 100 kHz VBW. The 6dB bandwidth is defined as the total spectrum the power of which is higher than peak power minus 6dB.

7.5 Test Result

Temperature (°C) : 22~23	EUT: Wireless AP
Humidity (%RH) : 50~54	M/N: W906
Barometric Pressure (mbar) : 950~1000	Operation Condition: Tx Mode

IEEE 802.11b mode

Channel	Channel Frequency (MHz)	6dB Bandwidth (kHz)	Minimum Limit (kHz)	Pass / Fail
Low	2412	11300	500	PASS
Middle	2437	10100	500	PASS
High	2462	9900	500	PASS

NOTE : 1. At final test to get the worst-case emission at 11Mbps.

IEEE 802.11g mode

Channel	Channel Frequency (MHz)	6dB Bandwidth (kHz)	Minimum Limit (kHz)	Pass / Fail
Low	2412	16300	500	PASS
Middle	2437	16300	500	PASS
High	2462	16200	500	PASS

NOTE : 1. At final test to get the worst-case emission at 6Mbps.

6dB BANDWIDTH (802.11b MODE CH Low)

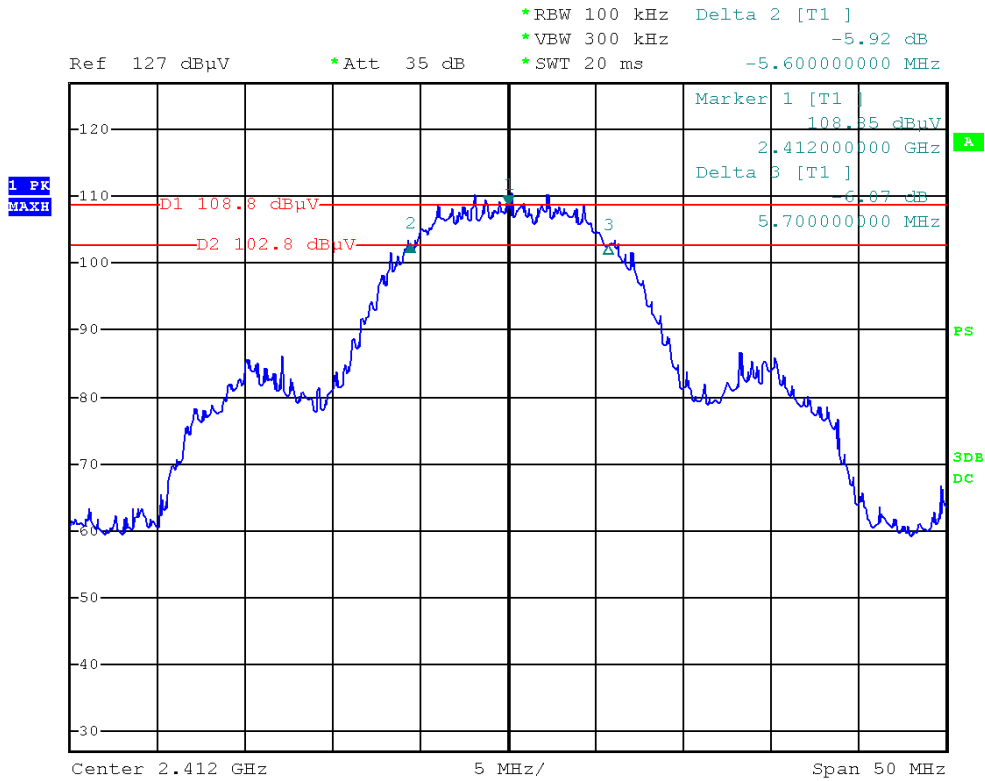

6dB BANDWIDTH (802.11b MODE CH Mid)

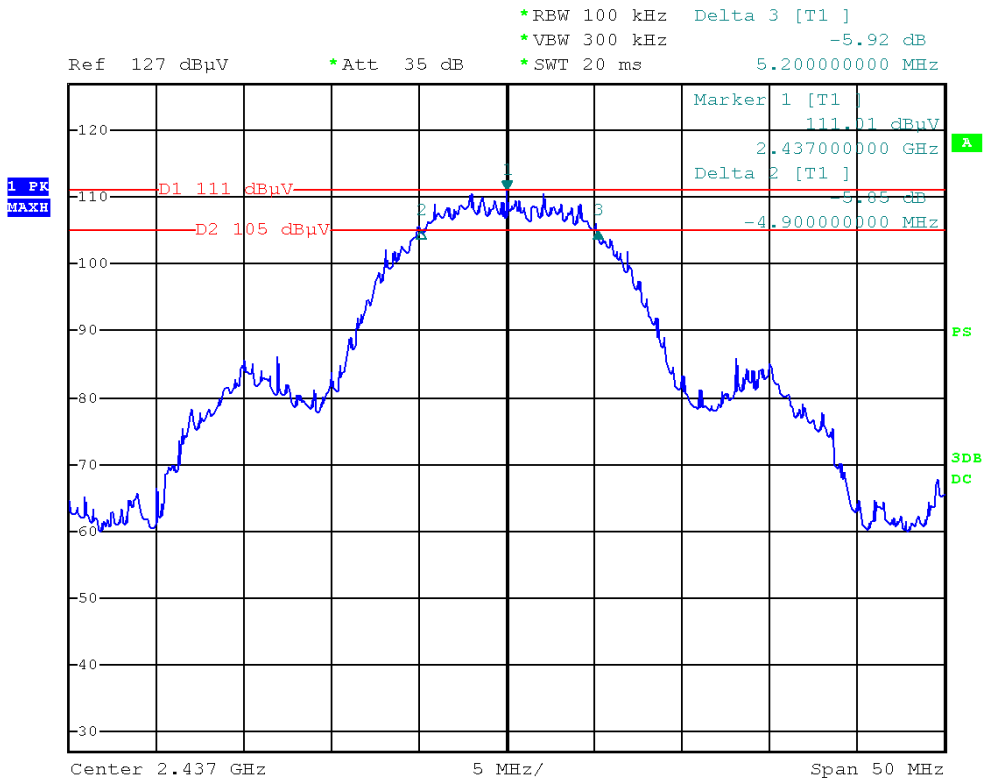

6dB BANDWIDTH (802.11b MODE CH High)

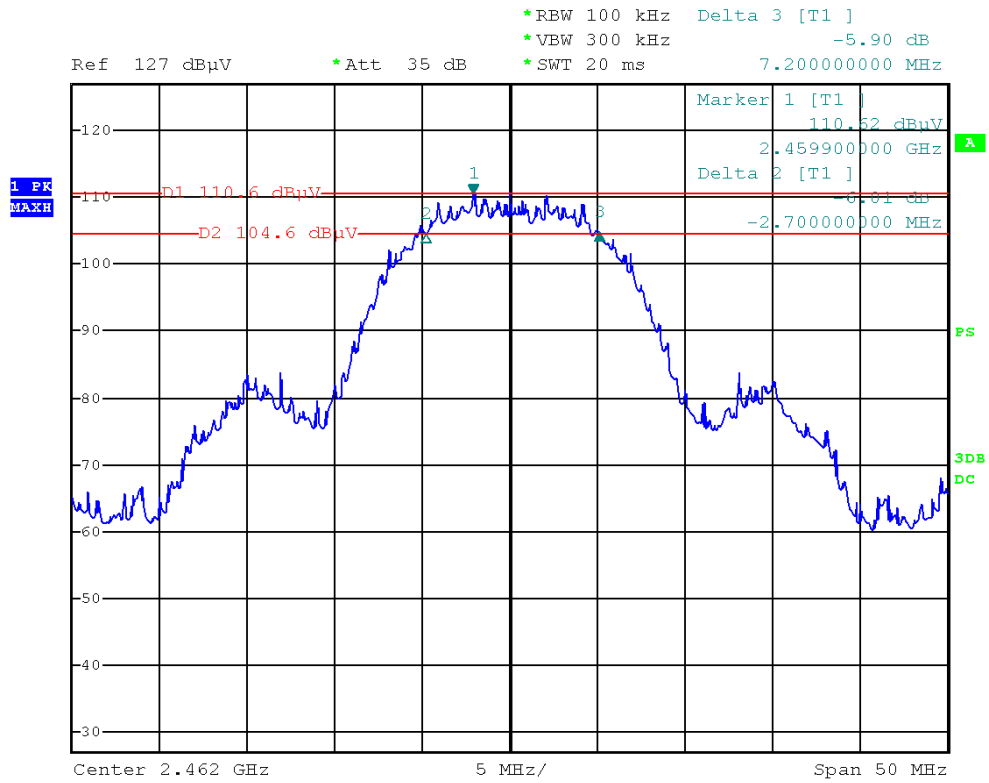

6dB BANDWIDTH (802.11g MODE CH Low)

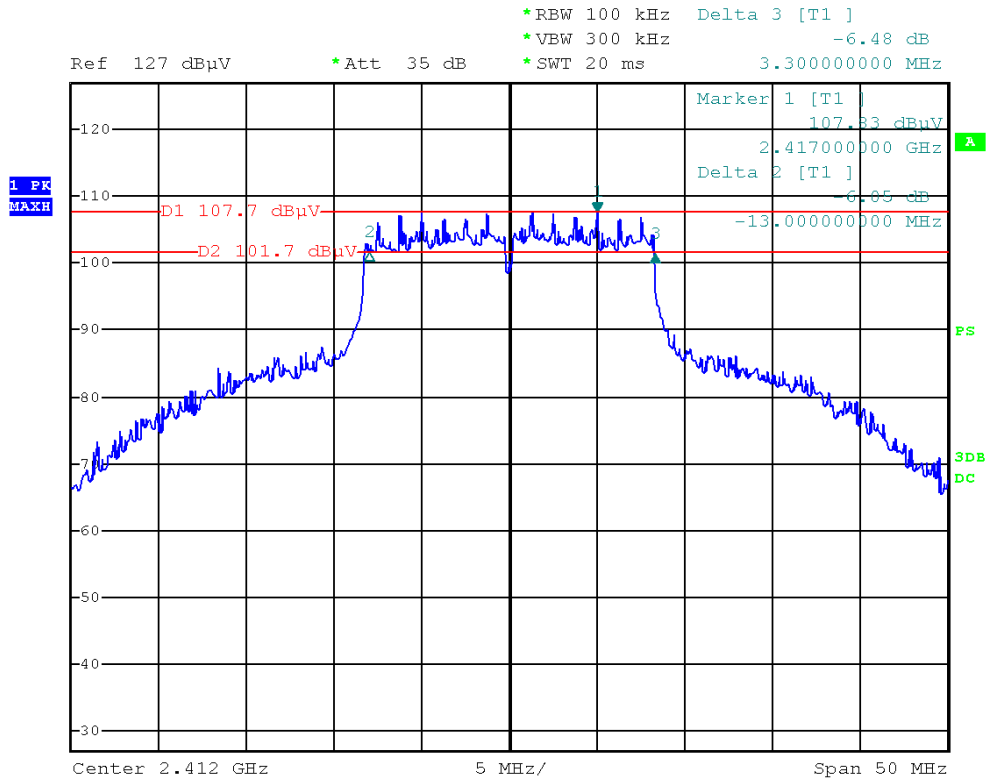

6dB BANDWIDTH (802.11g MODE CH Mid)

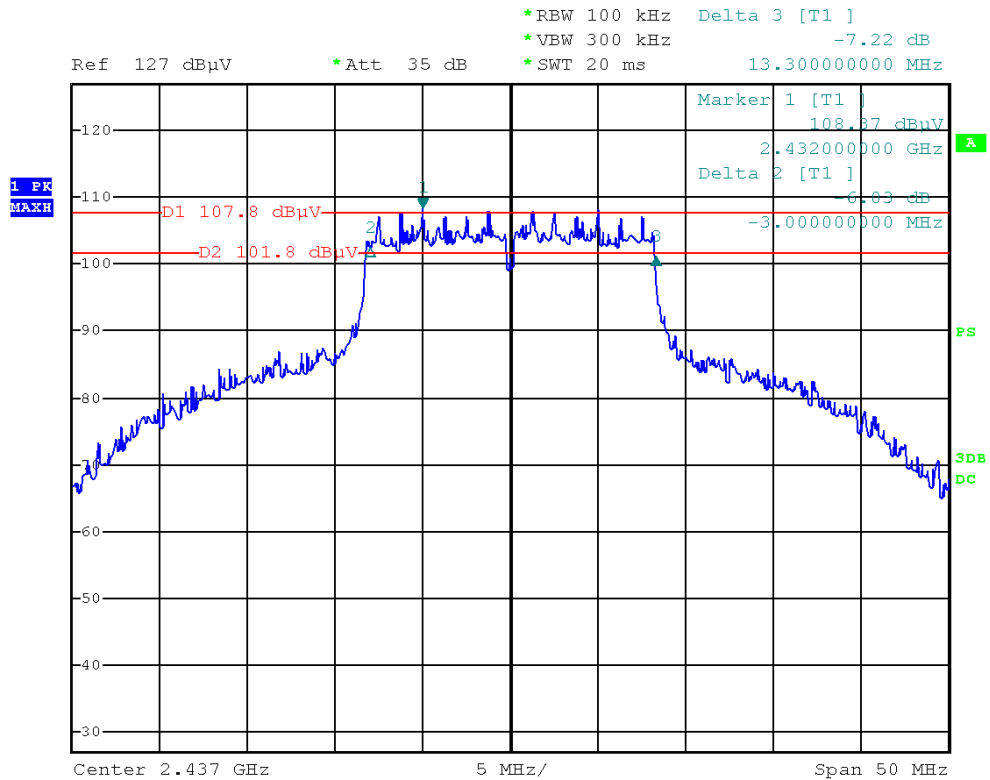

6dB BANDWIDTH (802.11g MODE CH High)

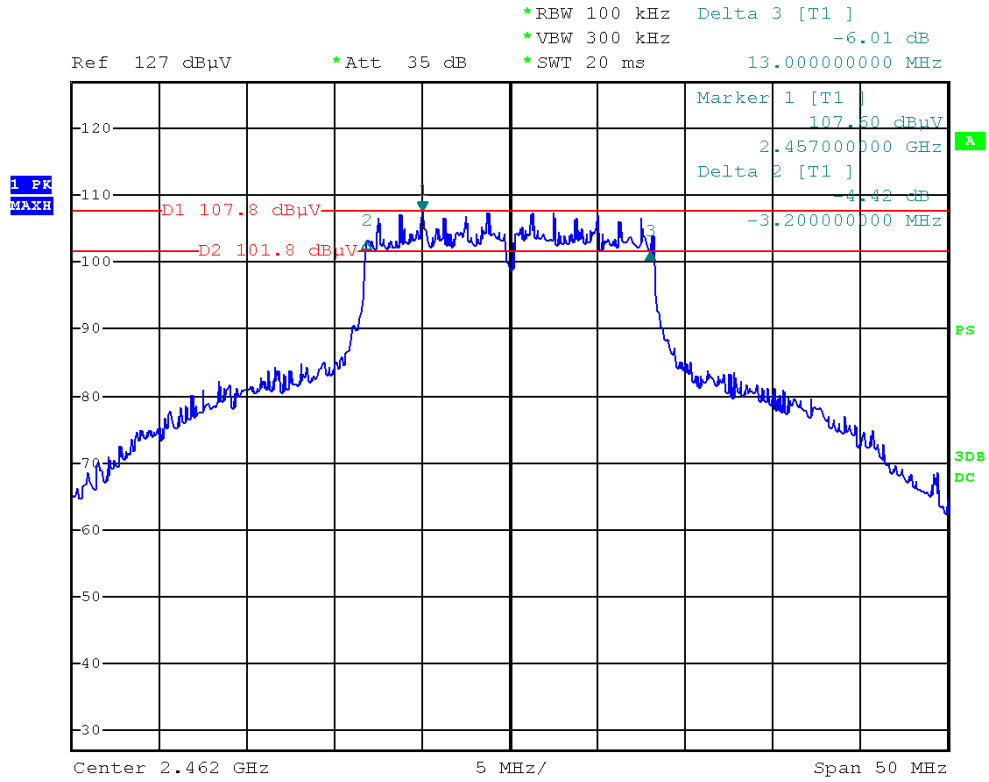

8. Test of Conducted Spurious Emission

8.1 Applicable Standard

Refer to FCC §15.247 (d).

Output power was measured based on the use of RMS averaging over a time interval, therefore the required attenuation is 30 dB.

8.2 EUT Setup

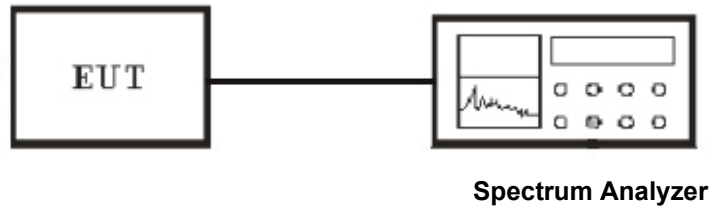

8.3 Test Equipment List and Details

See section 2.5.

8.4 Test Procedure

The transmitter output is connected to a spectrum analyzer. The resolution bandwidth is set to 100 kHz. The video bandwidth is set to 100 kHz.

The spectrum from 30 MHz to 26.5 GHz is investigated with the transmitter set to the lowest, middle, and highest channels in the 2.4 GHz band.

8.5 Test Result

Temperature (°C) : 22~23	EUT: Wireless AP
Humidity (%RH) : 50~54	M/N: W906
Barometric Pressure (mbar) : 950~1000	Operation Condition: TX Mode

IEEE 802.11b mode**CH Low**

Frequency (MHz)	Reading (dBμV)	Level (dBμV)	Limit (dBμV)	Margin (dB)	Pass/Fail
2412.6535	97.49	109.19	N/A	N/A	
1197.014	40.58	52.28	89.19	-36.91	PASS
4910.2404	42.91	54.61	89.19	-34.58	PASS
6979.038	46.45	58.15	89.19	-31.04	PASS

CH Mid

Frequency (MHz)	Reading (dBμV)	Level (dBμV)	Limit (dBμV)	Margin (dB)	Pass/Fail
2437.1524	98.78	110.48	N/A	N/A	
1462.2444	41.28	52.98	90.48	-37.50	PASS
4857.1943	44.06	55.76	90.48	-34.72	PASS
6819.8998	45.76	57.46	90.48	-33.02	PASS

CH High

Frequency (MHz)	Reading (dBμV)	Level (dBμV)	Limit (dBμV)	Margin (dB)	Pass/Fail
2462.5352	97.74	109.44	N/A	N/A	
1303.1062	40.93	52.63	89.44	-36.81	PASS
5493.7474	44.02	55.72	89.44	-33.72	PASS
6766.8537	45.39	57.09	89.44	-32.35	PASS

IEEE 802.11g mode**CH Low**

Frequency (MHz)	Reading (dBμV)	Level (dBμV)	Limit (dBμV)	Margin (dB)	Pass/Fail
2412.6352	93.04	104.74	N/A	N/A	
1409.7984	40.47	52.17	84.74	-32.57	PASS
5865.0701	44.22	55.92	84.74	-28.82	PASS
6713.8076	45.37	57.07	84.74	-27.67	PASS

CH Mid

Frequency (MHz)	Reading (dB μ V)	Level (dB μ V)	Limit (dB μ V)	Margin (dB)	Pass/Fail
2436.9525	93.81	105.51	N/A	N/A	
1674.4288	41.44	53.14	85.51	-32.37	PASS
5546.7935	43.12	54.82	85.51	-30.69	PASS
6766.8537	45.53	57.23	85.51	-28.28	PASS

CH High

Frequency (MHz)	Reading (dB μ V)	Level (dB μ V)	Limit (dB μ V)	Margin (dB)	Pass/Fail
2461.5352	92.89	104.59	N/A	N/A	
1780.521	41.29	52.99	84.59	-31.60	PASS
6501.6232	45.57	57.27	84.59	-27.32	PASS
6979.038	45.45	57.15	84.59	-27.44	PASS

9. Test of Radiated Spurious Emission

9.1 Radiated Spurious Emission

9.1.1 Limits

15.205 (a) Except as shown in paragraph (d) of this section, only spurious emissions are permitted in any of the frequency bands listed below:

MHz	MHz	MHz	GHz
0.090 - 0.110	16.42 - 16.423	399.9 - 410	4.5 - 5.15
¹ 0.495 - 0.505	16.69475 - 16.69525	608 - 614	5.35 - 5.46
2.1735 - 2.1905	16.80425 - 16.80475	960 - 1240	7.25 - 7.75
4.125 - 4.128	25.5 - 25.67	1300 - 1427	8.025 - 8.5
4.17725 - 4.17775	37.5 - 38.25	1435 - 1626.5	9.0 - 9.2
4.20725 - 4.20775	73 - 74.6	1645.5 - 1646.5	9.3 - 9.5
6.215 - 6.218	74.8 - 75.2	1660 - 1710	10.6 - 12.7
6.26775 - 6.26825	108 - 121.94	1718.8 - 1722.2	13.25 - 13.4
6.31175 - 6.31225	123 - 138	2200 - 2300	14.47 - 14.5
8.291 - 8.294	149.9 - 150.05	2310 - 2390	15.35 - 16.2
8.362 - 8.366	156.52475 - 156.52525	2483.5 - 2500	17.7 - 21.4
8.37625 - 8.38675	156.7 - 156.9	2655 - 2900	22.01 - 23.12
8.41425 - 8.41475	162.0125 - 167.17	3260 - 3267	23.6 - 24.0
12.29 - 12.293	167.72 - 173.2	3332 - 3339	31.2 - 31.8
12.51975 - 12.52025	240 - 285	3345.8 - 3338	36.43 - 36.5
12.57675 - 12.57725	322 - 335.4	3600 - 4400	(²)
13.36 - 13.41			

15.205 (b) Except as provided in paragraphs (d) and (e), the field strength of emissions appearing within these frequency bands shall not exceed the limits shown in Section 15.209. At frequencies equal to or less than 1000 MHz, compliance with the limits in Section 15.209 shall be demonstrated using measurement instrumentation employing a CISPR quasi-peak detector. Above 1000 MHz, compliance with the emission limits in Section 15.209 shall be demonstrated based on the average value of the measured emissions. The provisions in Section 15.35 apply to these measurements.

15.209 (a) Except as provided elsewhere in this Subpart, the emissions from an intentional radiator shall not exceed the field strength levels specified in the following table :

Frequency (MHz)	Field Strength (microvolts/meter)	Measurement Distance (meters)
30 - 88	100 **	3
88 - 216	150 **	3
216 - 960	200 **	3
Above 960	500	3

** Except as provided in paragraph (g), fundamental emissions from intentional radiators operating under this Section shall not be located in the frequency bands 54-72 MHz, 76-88 MHz, 174-216 MHz or 470-806 MHz, However, operation within these frequency bands is permitted under other sections of this Part, e-g, Sections 15.231 and 15.241.

15.209 (b) In the emission table above, the tighter limit applies at the band edges.

9.1.2 EUT Setup

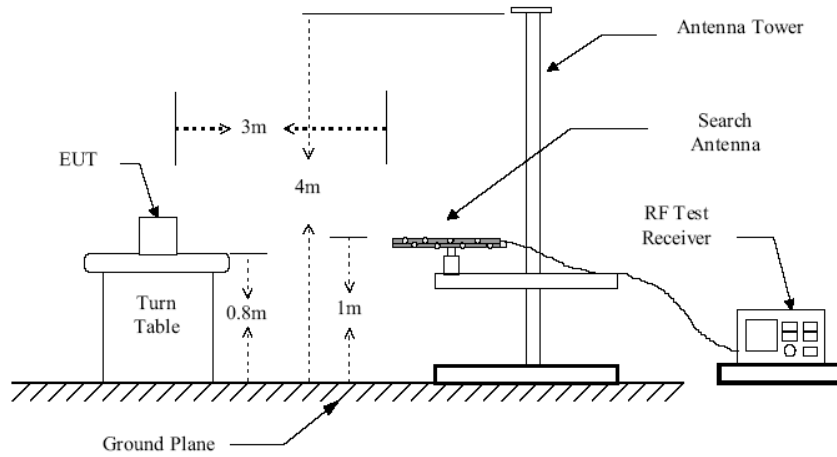

Figure 1 : Frequencies measured below 1 GHz configuration

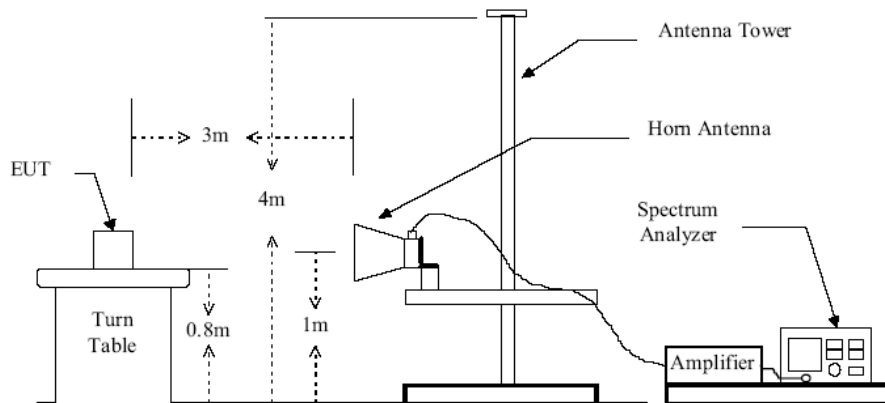

Figure 2 : Frequencies measured above 1 GHz configuration

9.1.3 Test Procedure

- a). The EUT was placed on the top of a rotating table 0.8 meters above the ground at a 10 meter open area test site. The table was rotated 360 degrees to determine the position of the highest radiation.
- b). While measuring the radiated emission below 1GHz, the EUT was set 3 meters away from the interference-receiving antenna, which was mounted on the top of a variable-height antenna tower. While measuring the radiated emission above 1GHz, the EUT was set 3 meters away from the interference-receiving antenna.
- c). The antenna is a broadband antenna, and its height is varied from one meter to four meters above the ground to determine the maximum value of the field strength. Both horizontal and vertical polarization of the antenna are set to make the measurement.
- d). For each suspected emission, the EUT was arranged to its worst case and then the antenna was tuned to heights from 1 meter to 4 meters and the table was turned from 0 degrees to 360 degrees to find the maximum reading.
- e). The test-receiver system was set to Peak Detect Function and Specified Bandwidth with Maximum Hold Mode.
- f). If the emission level of the EUT in peak mode was 10 dB lower than the limit specified, then testing could be stopped and the peak values of the EUT would be reported. Otherwise the emissions that did not have 10 dB margin would be re-tested one by one using peak, quasi-peak or average method as specified and then reported in a data sheet.

NOTE :

1. The resolution bandwidth and video bandwidth of test receiver/spectrum analyzer is 120 KHz for Peak detection (PK) and Quasi-peak detection (QP) at frequency below 1GHz.
2. The resolution bandwidth and video bandwidth of test receiver/spectrum analyzer is 1 MHz for Peak detection and frequency above 1GHz.
3. The resolution bandwidth of test receiver/spectrum analyzer is 1 MHz and the video bandwidth is 10 Hz for Average detection (AV) at frequency above 1GHz.

9.1.4 Test Result

Temperature (°C) : 22~23	EUT: Wireless AP
Humidity (%RH) : 50~54	M/N: W906
Barometric Pressure (mbar) : 950~1000	Operation Condition: ON & TX Mode

WORST-CASE RADIATED EMISSION BELOW 1 GHz

Normal operating Mode:

Horizontal

Frequency	Meter Reading	Antenna Factor	Cable Loss	Emission Levels	Limits	Margin	Detector Mode
(MHz)	(dB μ V)	(dB/M)	(dB)	(dB μ V/M)	(dB μ V/M)	(dB)	PK/QP
84.32	26.40	7.97	1.18	36.56	40.00	-3.44	QP
160.01	16.50	12.60	1.59	30.69	43.50	-12.81	QP
402.48	14.50	14.44	2.72	36.66	46.00	-9.34	QP
652.74	14.50	18.00	3.05	35.55	46.00	-10.45	QP
726.46	9.60	20.84	3.84	34.28	46.00	-11.72	QP
823.46	10.30	21.80	4.14	36.24	46.00	-9.76	QP
N/A	----	----	----	----	----	----	----

Vertical

Frequency	Meter Reading	Antenna Factor	Cable Loss	Emission Levels	Limits	Margin	Detector Mode
(MHz)	(dB μ V)	(dB/M)	(dB)	(dB μ V/M)	(dB μ V/M)	(dB)	PK/QP
142.52	21.40	7.89	1.01	30.30	40.00	-9.70	QP
191.02	16.10	12.60	1.59	30.29	43.50	-13.21	QP
216.24	25.70	12.20	2.02	39.92	46.00	-6.08	QP
239.52	22.80	14.44	2.72	39.96	46.00	-6.04	QP
503.36	16.50	18.00	3.05	37.55	46.00	-8.45	QP
749.74	13.20	21.80	4.14	39.14	46.00	-6.86	QP
N/A	----	----	----	----	----	----	----

REMARK: Emission level (dB μ V/m) =Antenna Factor (dB/m) + Cable loss (dB) + Meter Reading (dB μ V).

WORST-CASE RADIATED EMISSION BELOW 30 MHz

Frequency	Meter Reading	Antenna Factor	Cable Loss	Emission Levels	Limits	Margin	Detector Mode
(MHz)	(dB μ V)	(dB/M)	(dB)	(dB μ V/M)	(dB μ V/M)	(dB)	PK/QP
0.510	19.10	7.89	1.02	28.01	67.0	-38.99	QP
15.40	19.50	8.75	1.21	29.46	49.5	-20.04	QP
19.30	16.20	8.73	1.05	25.98	49.5	-23.52	QP
23.20	21.20	7.33	1.68	30.21	49.5	-19.29	QP

TRANSMITTER RADIATED EMISSION ABOVE 1 GHz

IEEE 802.11b TX (CH Low)

Horizontal

TX / IEEE 802.11b mode / CH Low				Measurement Distance at 3m Horizontal polarity					
Freq.	Reading	AF	Cable Loss	Pre-amp	Filter	Level	Limit	Margin	Mark
(MHz)	(dBμV)	(dB/m)	(dB)	(dB)	(dB)	(dBμV/m)	(dBμV/m)	(dB)	(P/Q/A)
4824.15	51.24	32.81	3.71	41.34	0.69	47.12	74.00	-26.88	P
4824.15	39.25	32.81	3.71	41.34	0.69	35.13	54.00	-18.87	A
7236.35	49.85	38.83	4.93	41.42	1.44	53.62	74.00	-20.38	P
7236.35	37.49	38.83	4.93	41.42	1.44	41.26	54.00	-12.74	A
9645.85	48.75	38.75	5.74	38.43	0.61	55.42	74.00	-18.58	P
9645.85	37.69	38.75	5.74	38.43	0.61	44.36	54.00	-9.64	A
N/A	----	----	----	----	----	----	----	----	P
N/A	----	----	----	----	----	----	----	----	A

Vertical

TX / IEEE 802.11b mode / CH Low				Measurement Distance at 3m Vertical polarity					
Freq.	Reading	AF	Cable Loss	Pre-amp	Filter	Level	Limit	Margin	Mark
(MHz)	(dBμV)	(dB/m)	(dB)	(dB)	(dB)	(dBμV/m)	(dBμV/m)	(dB)	(P/Q/A)
4823.85	53.62	32.81	3.70	41.34	0.69	49.49	74.00	-24.51	P
4823.85	42.00	32.81	3.70	41.34	0.69	37.87	54.00	-16.13	A
7236.18	51.42	38.83	4.93	41.42	1.44	55.19	74.00	-18.81	P
7236.18	39.85	38.83	4.93	41.42	1.44	43.62	54.00	-10.38	A
9647.94	50.24	38.75	5.74	38.43	0.61	56.92	74.00	-17.08	P
9647.94	39.68	38.75	5.74	38.43	0.61	46.36	54.00	-7.64	A
N/A	----	----	----	----	----	----	----	----	P
N/A	----	----	----	----	----	----	----	----	A

REMARK:

1. AF: Antenna Factor, Cable: Cable Loss, Pre-Amp: Preamplifier gain, Filter: High Pass Filter Insertion Loss (3.5GHz)
2. Spectrum analyzer setting P(Peak): RBW=1MHz, VBW=1MHz, A(Average): RBW=1MHz, VBW=10Hz
3. The result basic equation calculation is as follow: Level = Reading + AF + Cable – Preamp + Filter – Dist, Margin = Level-Limit
4. The other emission levels were 20dB below the limit
5. The test limit distance is 3M limit.

IEEE 802.11b TX (CH Middle)

Horizontal

				Measurement Distance at 3m Horizontal polarity					
Freq.	Reading	AF	Cable Loss	Pre-amp	Filter	Level	Limit	Margin	Mark
(MHz)	(dBμV)	(dB/m)	(dB)	(dB)	(dB)	(dBμV/m)	(dBμV/m)	(dB)	(P/Q/A)
4876.53	51.28	32.93	3.73	41.41	0.71	47.24	74.00	-26.76	P
4876.53	41.96	32.93	3.73	41.41	0.71	37.92	54.00	-16.08	A
7309.41	50.24	38.93	4.96	41.32	1.59	54.40	74.00	-19.60	P
7309.41	39.42	38.93	4.96	41.32	1.59	43.58	54.00	-10.42	A
9747.83	49.85	38.85	5.75	38.24	0.55	56.76	74.00	-17.24	P
9747.83	38.65	38.85	5.75	38.24	0.55	45.56	54.00	-8.44	A
N/A	----	----	----	----	----	----	----	----	P
N/A	----	----	----	----	----	----	----	----	A

Vertical

TX / IEEE 802.11b mode / CH Middle				Measurement Distance at 3m Vertical polarity					
Freq.	Reading	AF	Cable Loss	Pre-amp	Filter	Level	Limit	Margin	Mark
(MHz)	(dBμV)	(dB/m)	(dB)	(dB)	(dB)	(dBμV/m)	(dBμV/m)	(dB)	(P/Q/A)
4876.92	53.64	32.93	3.73	41.42	0.71	49.60	74.00	-24.40	P
4876.92	43.84	32.93	3.73	41.42	0.71	39.80	54.00	-14.20	A
7309.25	51.51	38.93	4.96	41.32	1.59	55.67	74.00	-18.33	P
7309.25	40.93	38.93	4.96	41.32	1.59	45.09	54.00	-8.91	A
9748.35	52.14	38.85	5.75	38.24	0.55	59.05	74.00	-14.95	P
9748.35	40.57	38.85	5.75	38.24	0.55	47.48	54.00	-6.52	A
N/A	----	----	----	----	----	----	----	----	P
N/A	----	----	----	----	----	----	----	----	A

REMARK:

1. AF: Antenna Factor, Cable: Cable Loss, Pre-Amp: Preamplifier gain, Filter: High Pass Filter Insertion Loss (3.5GHz)
2. Spectrum analyzer setting P(Peak): RBW=1MHz, VBW=1MHz, A(Average): RBW=1MHz, VBW=10Hz
3. The result basic equation calculation is as follow: Level = Reading + AF + Cable – Preamp + Filter – Dist, Margin = Level-Limit
4. The other emission levels were 20dB below the limit
5. The test limit distance is 3M limit.

IEEE 802.11b TX (CH High)

Horizontal

TX / IEEE 802.11b mode / CH High				Measurement Distance at 3m Horizontal polarity					
Freq.	Reading	AF	Cable Loss	Pre-amp	Filter	Level	Limit	Margin	Mark
(MHz)	(dBµV)	(dB/m)	(dB)	(dB)	(dB)	(dBµV/m)	(dBµV/m)	(dB)	(P/Q/A)
4923.85	52.46	33.03	3.76	41.49	0.73	48.50	74.00	-25.50	P
4923.85	42.11	33.03	3.76	41.49	0.73	38.15	54.00	-15.85	A
7385.69	51.24	39.04	4.99	41.21	1.76	55.82	74.00	-18.18	P
7385.69	39.51	39.04	4.99	41.21	1.76	44.09	54.00	-9.91	A
9848.15	50.24	38.95	5.76	38.06	0.49	57.39	74.00	-16.61	P
9848.15	38.96	38.95	5.76	38.06	0.49	46.10	54.00	-7.90	A
N/A	----	----	----	----	----	----	----	----	P
N/A	----	----	----	----	----	----	----	----	A

Vertical

TX / IEEE 802.11b mode / CH High				Measurement Distance at 3m Vertical polarity					
Freq.	Reading	AF	Cable Loss	Pre-amp	Filter	Level	Limit	Margin	Mark
(MHz)	(dBµV)	(dB/m)	(dB)	(dB)	(dB)	(dBµV/m)	(dBµV/m)	(dB)	(P/Q/A)
4924.03	53.84	33.03	3.76	41.49	0.73	49.88	74.00	-24.12	P
4924.03	43.45	33.03	3.76	41.49	0.73	39.49	54.00	-14.51	A
7386.08	52.41	39.04	4.99	41.21	1.76	56.99	74.00	-17.01	P
7386.08	40.57	39.04	4.99	41.21	1.76	45.15	54.00	-8.85	A
9847.35	52.11	38.95	5.76	38.06	0.49	59.25	74.00	-14.75	P
9847.35	41.35	38.95	5.76	38.06	0.49	48.49	54.00	-5.51	A
N/A	----	----	----	----	----	----	----	----	P
N/A	----	----	----	----	----	----	----	----	A

REMARK:

1. AF: Antenna Factor, Cable: Cable Loss, Pre-Amp: Preamplifier gain, Filter: High Pass Filter Insertion Loss (3.5GHz)
2. Spectrum analyzer setting P(Peak): RBW=1MHz, VBW=1MHz, A(Average): RBW=1MHz, VBW=10Hz
3. The result basic equation calculation is as follow: Level = Reading + AF + Cable – Preamp + Filter – Dist, Margin = Level-Limit
4. The other emission levels were 20dB below the limit
5. The test limit distance is 3M limit.

IEEE 802.11g TX (CH Low)

Horizontal

TX / IEEE 802.11g mode / CH Low				Measurement Distance at 3m Horizontal polarity					
Freq.	Reading	AF	Cable Loss	Pre-amp	Filter	Level	Limit	Margin	Mark
(MHz)	(dBμV)	(dB/m)	(dB)	(dB)	(dB)	(dBμV/m)	(dBμV/m)	(dB)	(P/Q/A)
4824.23	52.12	32.81	3.71	41.34	0.69	48.00	74.00	-26.00	P
4824.23	42.11	32.81	3.71	41.34	0.69	37.99	54.00	-16.01	A
7236.00	51.24	38.83	4.93	41.42	1.44	55.01	74.00	-18.99	P
7236.00	40.35	38.83	4.93	41.42	1.44	44.12	54.00	-9.88	A
9642.15	50.22	38.74	5.74	38.44	0.61	56.88	74.00	-17.12	P
9642.15	38.95	38.74	5.74	38.44	0.61	45.61	54.00	-8.39	A
N/A	----	----	----	----	----	----	----	----	P
N/A	----	----	----	----	----	----	----	----	A

Vertical

TX / IEEE 802.11g mode / CH Low				Measurement Distance at 3m Vertical polarity					
Freq.	Reading	AF	Cable Loss	Pre-amp	Filter	Level	Limit	Margin	Mark
(MHz)	(dBμV)	(dB/m)	(dB)	(dB)	(dB)	(dBμV/m)	(dBμV/m)	(dB)	(P/Q/A)
4824.00	54.24	32.81	3.70	41.34	0.69	50.11	74.00	-23.89	P
4824.00	43.97	32.81	3.70	41.34	0.69	39.84	54.00	-14.16	A
7236.39	51.62	38.83	4.93	41.42	1.44	55.39	74.00	-18.61	P
7236.39	41.52	38.83	4.93	41.42	1.44	45.29	54.00	-8.71	A
9641.57	52.21	38.74	5.74	38.44	0.62	58.87	74.00	-15.13	P
9641.57	41.25	38.74	5.74	38.44	0.62	47.91	54.00	-6.09	A
N/A	----	----	----	----	----	----	----	----	P
N/A	----	----	----	----	----	----	----	----	A

REMARK:

1. AF: Antenna Factor, Cable: Cable Loss, Pre-Amp: Preamplifier gain, Filter: High Pass Filter Insertion Loss (3.5GHz)
2. Spectrum analyzer setting P(Peak): RBW=1MHz, VBW=1MHz, A(Average): RBW=1MHz, VBW=10Hz
3. The result basic equation calculation is as follow: Level = Reading + AF + Cable – Preamp + Filter – Dist, Margin = Level-Limit
4. The other emission levels were 20dB below the limit
5. The test limit distance is 3M limit.

IEEE 802.11g TX (CH Middle)

Horizontal

TX / IEEE 802.11g mode / CH Middle				Measurement Distance at 3m Horizontal polarity					
Freq.	Reading	AF	Cable Loss	Pre-amp	Filter	Level	Limit	Margin	Mark
(MHz)	(dBµV)	(dB/m)	(dB)	(dB)	(dB)	(dBµV/m)	(dBµV/m)	(dB)	(P/Q/A)
4871.16	50.24	32.92	3.73	41.41	0.71	46.19	74.00	-27.81	P
4871.16	41.35	32.92	3.73	41.41	0.71	37.30	54.00	-16.70	A
7318.25	49.85	38.95	4.96	41.31	1.61	54.06	74.00	-19.94	P
7318.25	40.22	38.95	4.96	41.31	1.61	44.43	54.00	-9.57	A
9748.35	50.24	38.85	5.75	38.24	0.55	57.15	74.00	-16.85	P
9748.35	39.58	38.85	5.75	38.24	0.55	46.49	54.00	-7.51	A
N/A	----	----	----	----	----	----	----	----	P
N/A	----	----	----	----	----	----	----	----	A

Vertical

TX / IEEE 802.11g mode / CH Middle				Measurement Distance at 3m Vertical polarity					
Freq.	Reading	AF	Cable Loss	Pre-amp	Filter	Level	Limit	Margin	Mark
(MHz)	(dBµV)	(dB/m)	(dB)	(dB)	(dB)	(dBµV/m)	(dBµV/m)	(dB)	(P/Q/A)
4871.56	53.62	32.92	3.73	41.41	0.71	49.57	74.00	-24.43	P
4871.56	44.17	32.92	3.73	41.41	0.71	40.12	54.00	-13.88	A
7317.24	51.24	38.94	4.96	41.31	1.61	55.45	74.00	-18.55	P
7317.24	42.33	38.94	4.96	41.31	1.61	46.54	54.00	-7.46	A
9747.26	52.34	38.85	5.75	38.25	0.55	59.25	74.00	-14.75	P
9747.26	41.52	38.85	5.75	38.25	0.55	48.43	54.00	-5.57	A
N/A	----	----	----	----	----	----	----	----	P
N/A	----	----	----	----	----	----	----	----	A

REMARK:

1. AF: Antenna Factor, Cable: Cable Loss, Pre-Amp: Preamplifier gain, Filter: High Pass Filter Insertion Loss (3.5GHz)
2. Spectrum analyzer setting P(Peak): RBW=1MHz, VBW=1MHz, A(Average): RBW=1MHz, VBW=10Hz
3. The result basic equation calculation is as follow: Level = Reading + AF + Cable – Preamp + Filter – Dist, Margin = Level-Limit
4. The other emission levels were 20dB below the limit
5. The test limit distance is 3M limit.

IEEE 802.11g TX (CH High)

Horizontal

TX / IEEE 802.11g mode / CH High				Measurement Distance at 3m Horizontal polarity					
Freq.	Reading	AF	Cable Loss	Pre-amp	Filter	Level	Limit	Margin	Mark
(MHz)	(dBμV)	(dB/m)	(dB)	(dB)	(dB)	(dBμV/m)	(dBμV/m)	(dB)	(P/Q/A)
4924.35	51.24	33.03	3.76	41.49	0.73	47.28	74.00	-26.72	P
4924.35	40.26	33.03	3.76	41.49	0.73	36.30	54.00	-17.70	A
7384.86	49.87	39.04	4.99	41.21	1.75	54.44	74.00	-19.56	P
7384.86	38.65	39.04	4.99	41.21	1.75	43.22	54.00	-10.78	A
9847.56	50.14	38.95	5.76	38.06	0.49	57.28	74.00	-16.72	P
9847.56	39.85	38.95	5.76	38.06	0.49	46.99	54.00	-7.01	A
N/A	----	----	----	----	----	----	----	----	P
N/A	----	----	----	----	----	----	----	----	A

Vertical

TX / IEEE 802.11g mode / CH High				Measurement Distance at 3m Vertical polarity					
Freq.	Reading	AF	Cable Loss	Pre-amp	Filter	Level	Limit	Margin	Mark
(MHz)	(dBμV)	(dB/m)	(dB)	(dB)	(dB)	(dBμV/m)	(dBμV/m)	(dB)	(P/Q/A)
4923.85	53.22	33.03	3.76	41.49	0.73	49.26	74.00	-24.74	P
4923.85	42.61	33.03	3.76	41.49	0.73	38.65	54.00	-15.35	A
7385.94	51.33	39.04	4.99	41.21	1.76	55.91	74.00	-18.09	P
7385.94	40.25	39.04	4.99	41.21	1.76	44.83	54.00	-9.17	A
9847.59	52.64	38.95	5.76	38.06	0.49	59.78	74.00	-14.22	P
9847.59	41.24	38.95	5.76	38.06	0.49	48.38	54.00	-5.62	A
N/A	----	----	----	----	----	----	----	----	P
N/A	----	----	----	----	----	----	----	----	A

REMARK:

1. AF: Antenna Factor, Cable: Cable Loss, Pre-Amp: Preamplifier gain, Filter: High Pass Filter Insertion Loss (3.5GHz)
2. Spectrum analyzer setting P(Peak): RBW=1MHz, VBW=1MHz, A(Average): RBW=1MHz, VBW=10Hz
3. The result basic equation calculation is as follow: Level = Reading + AF + Cable – Preamp + Filter – Dist, Margin = Level-Limit
4. The other emission levels were 20dB below the limit
5. The test limit distance is 3M limit.

9.2 RESTRICTED BAND EDGES

TEST RESULT

IEEE 802.11b mode

Channel	Polarity	Freq.(MHz)	Level(dBuV)	Limit(dBuV)	Margin(dB)	Detector
	H	2390	60.96	74	-13.04	Peak
	H	2390	48.51	54	-5.49	Average
	V	2390	59.09	74	-14.91	Peak
LOW	V	2390	48.35	54	-5.65	Average
	H	2483.5	69.16	74	-4.86	Peak
	H	2483.5	49.71	54	-4.29	Average
	V	2483.5	68.46	74	-5.54	Peak
HIGH	V	2483.5	49.46	54	-4.54	Average

IEEE 802.11g mode

Channel	Polarity	Freq.(MHz)	Level(dBuV)	Limit(dBuV)	Margin(dB)	Detector
	H	2390	56.48	74	-17.52	Peak
	H	2390	49.79	54	-4.21	Average
	V	2390	56.56	74	-17.44	Peak
LOW	V	2390	49.51	54	-4.49	Average
	H	2483.5	62.94	74	-11.06	Peak
	H	2483.5	48.63	54	-5.37	Average
	V	2483.5	62.26	74	-11.74	Peak
HIGH	V	2483.5	48.13	54	-5.87	Average

CH Low (802.11b MODE–Horizontal–Peak)

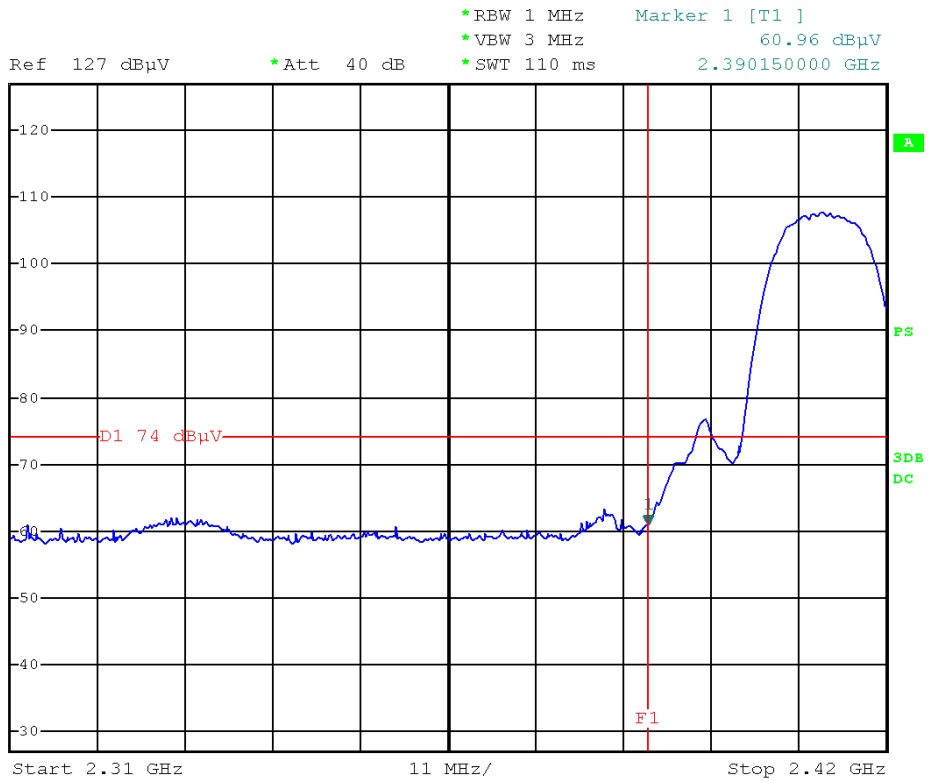

CH Low (802.11b MODE–Horizontal–Average)

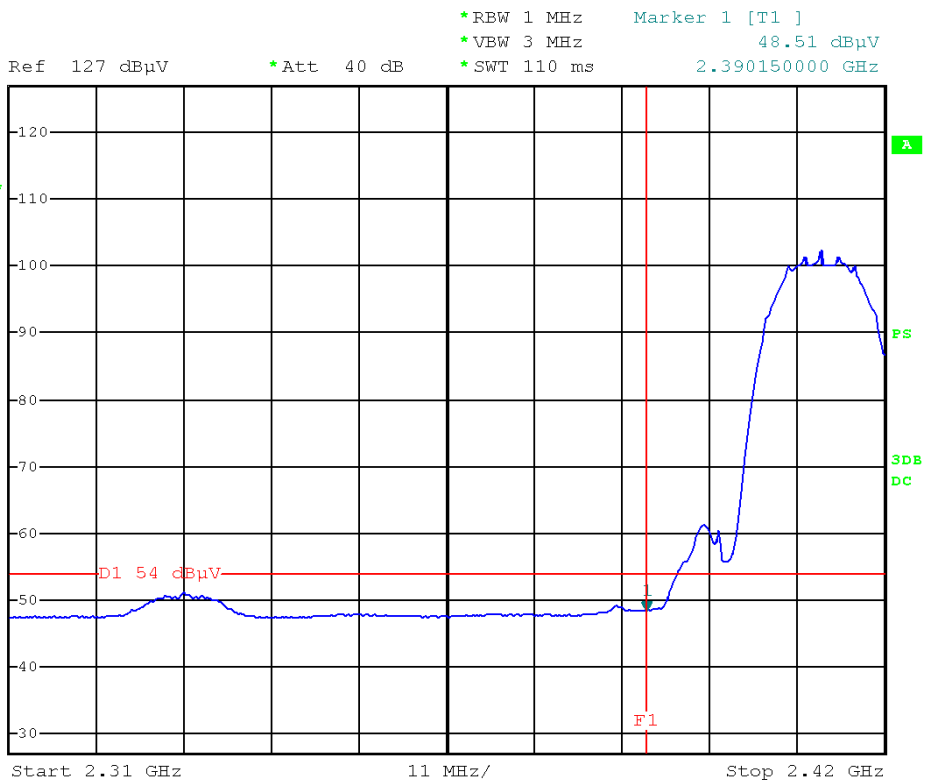

CH Low (802.11b MODE-Vertical-Peak)

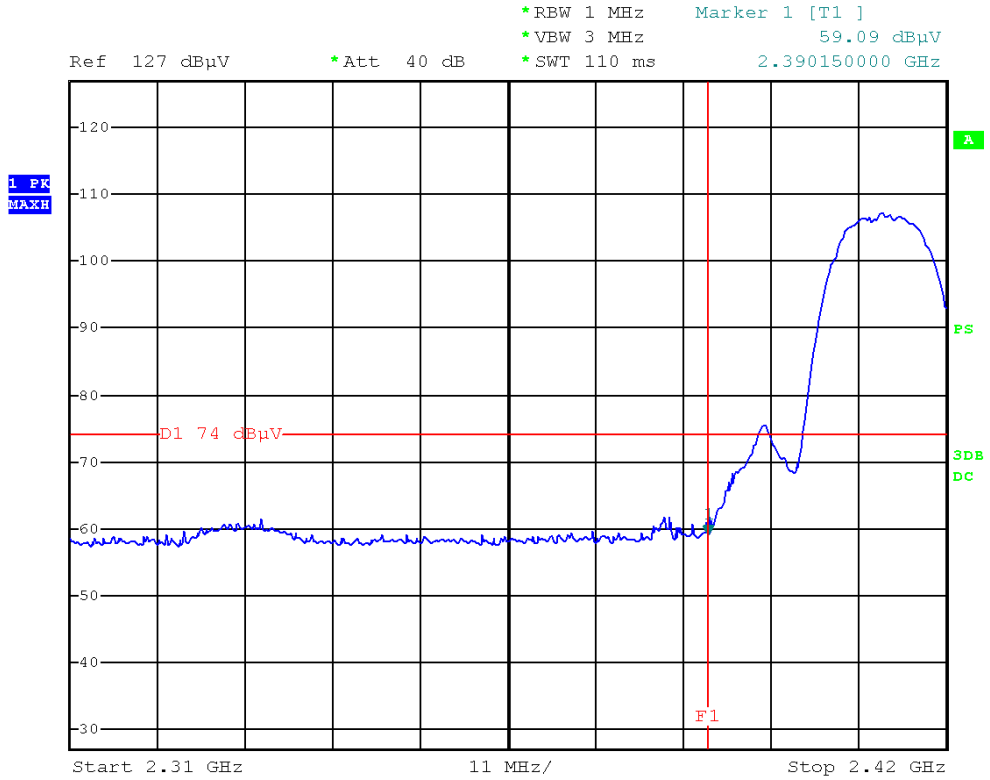

CH Low (802.11b MODE-Vertical-Average)

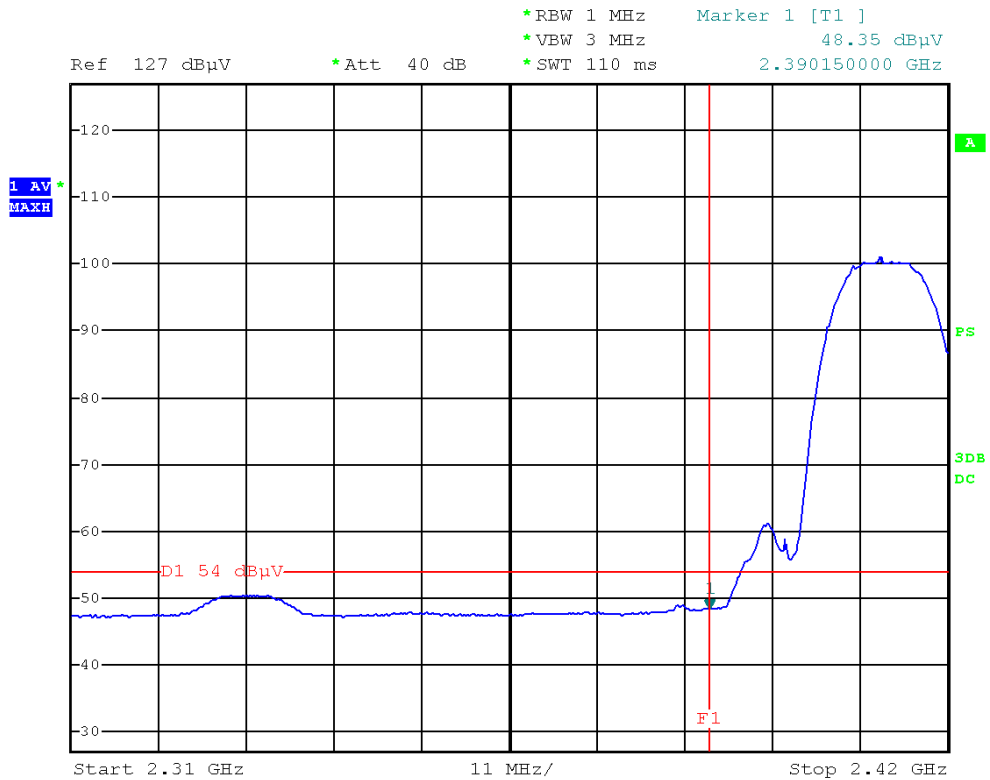

CH High (802.11b MODE–Horizontal–Peak)

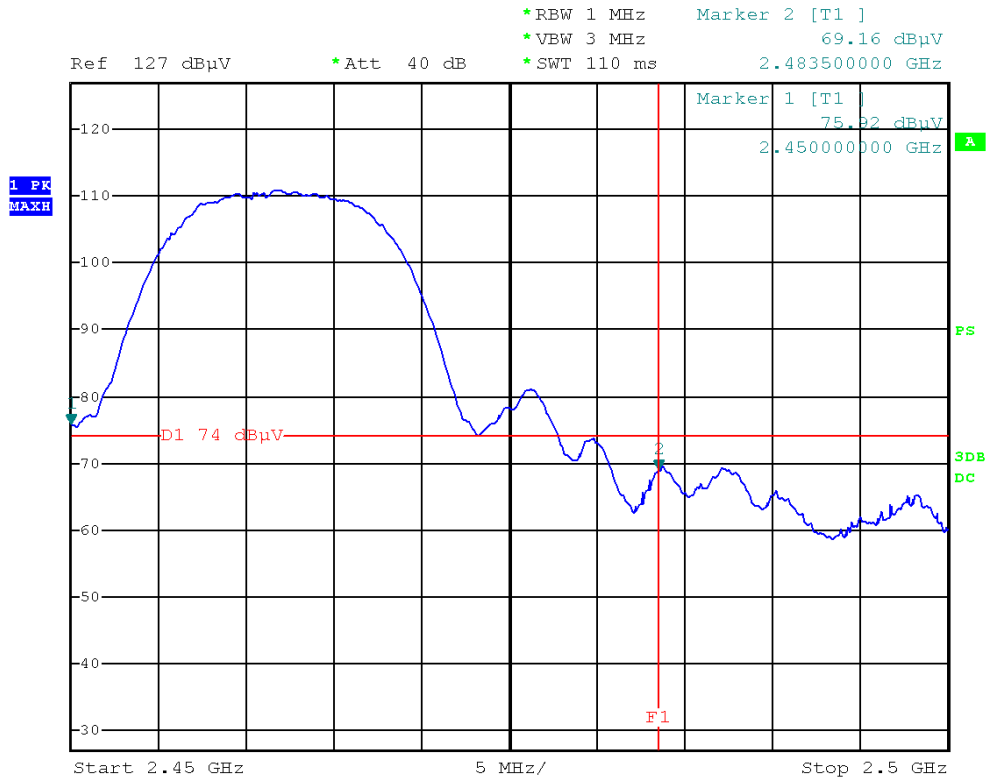

CH High (802.11b MODE–Horizontal–Average)

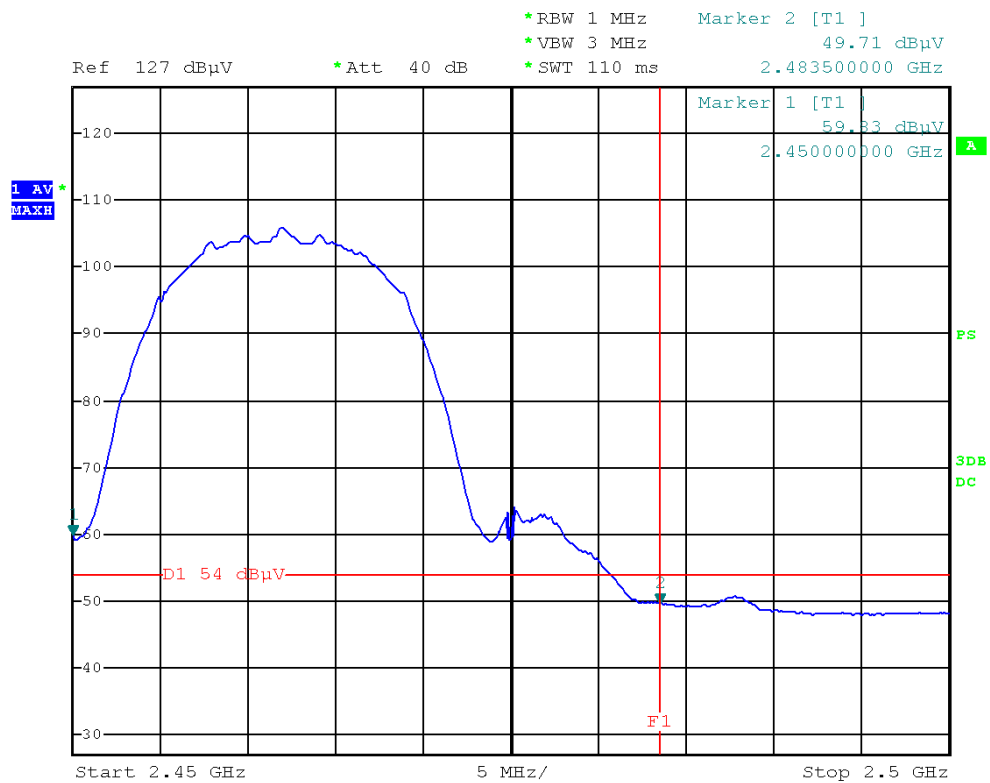

CH High (802.11b MODE-Vertical-Peak)

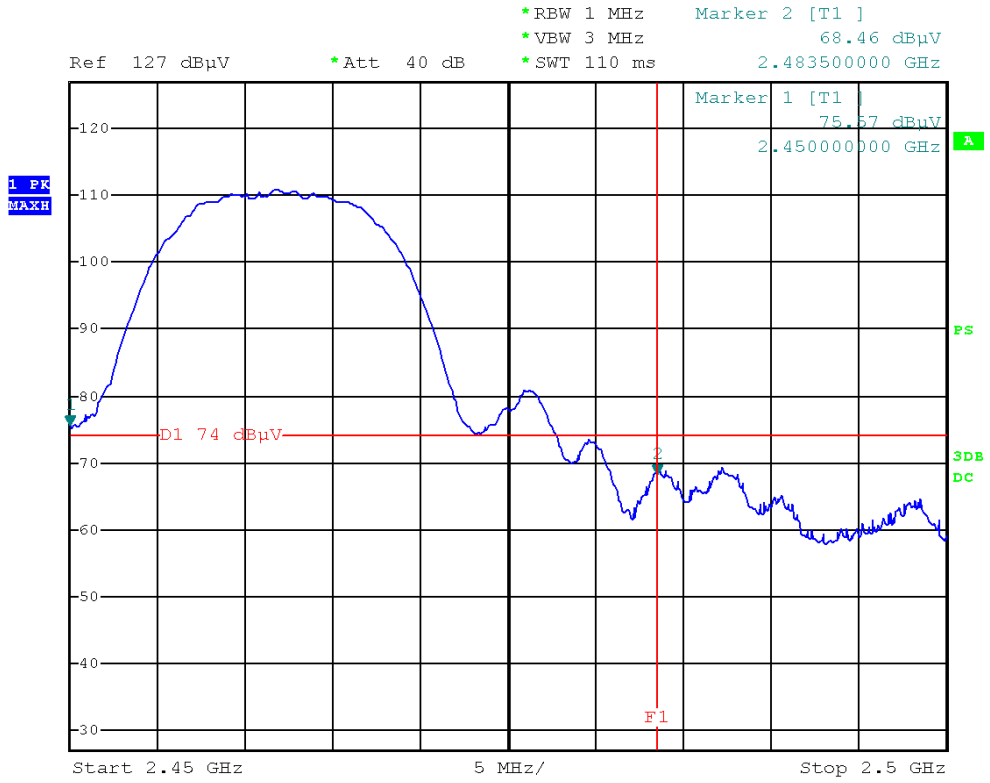

CH High (802.11b MODE-Vertical-Average)

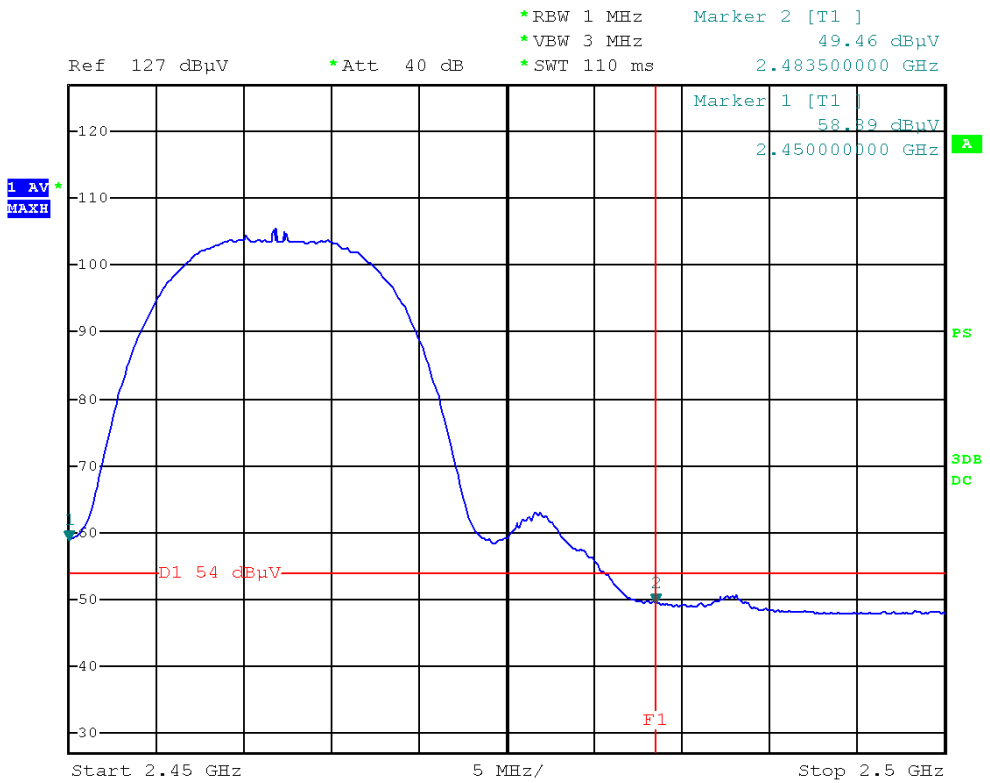

CH Low (802.11g MODE–Horizontal–Peak)

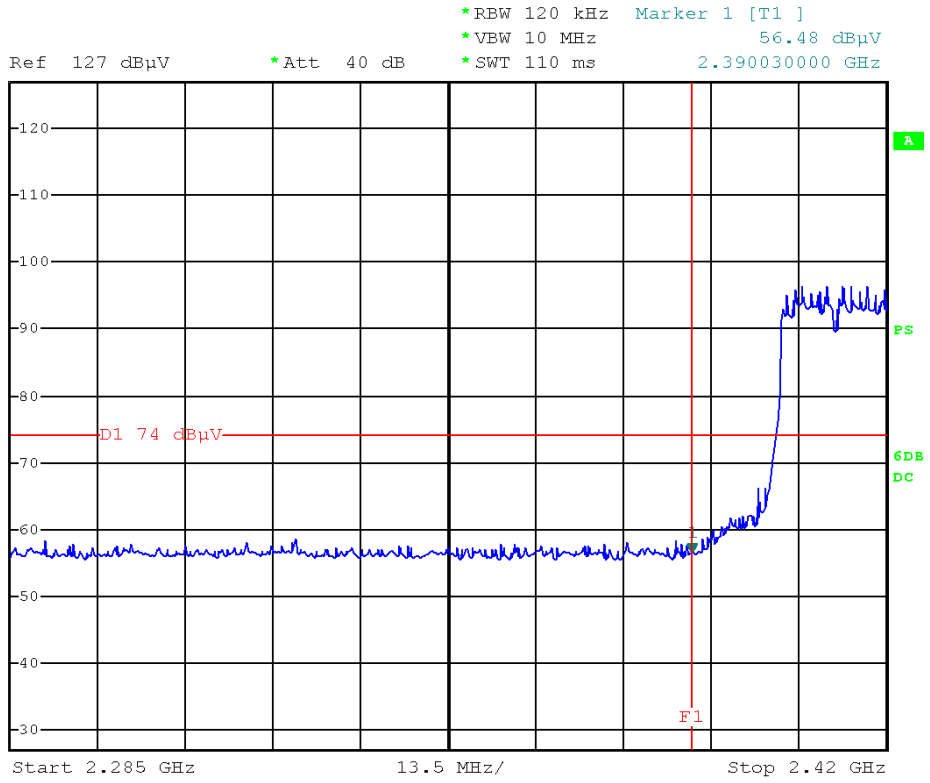

CH Low (802.11g MODE–Horizontal–Average)

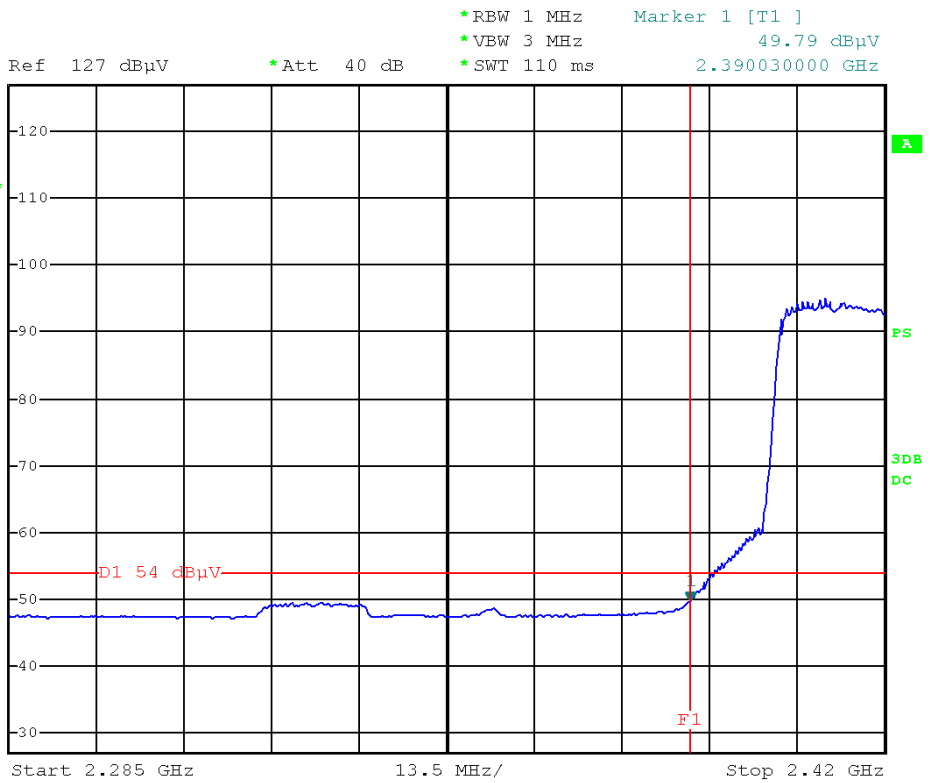

CH Low (802.11g MODE-Vertical-Peak)

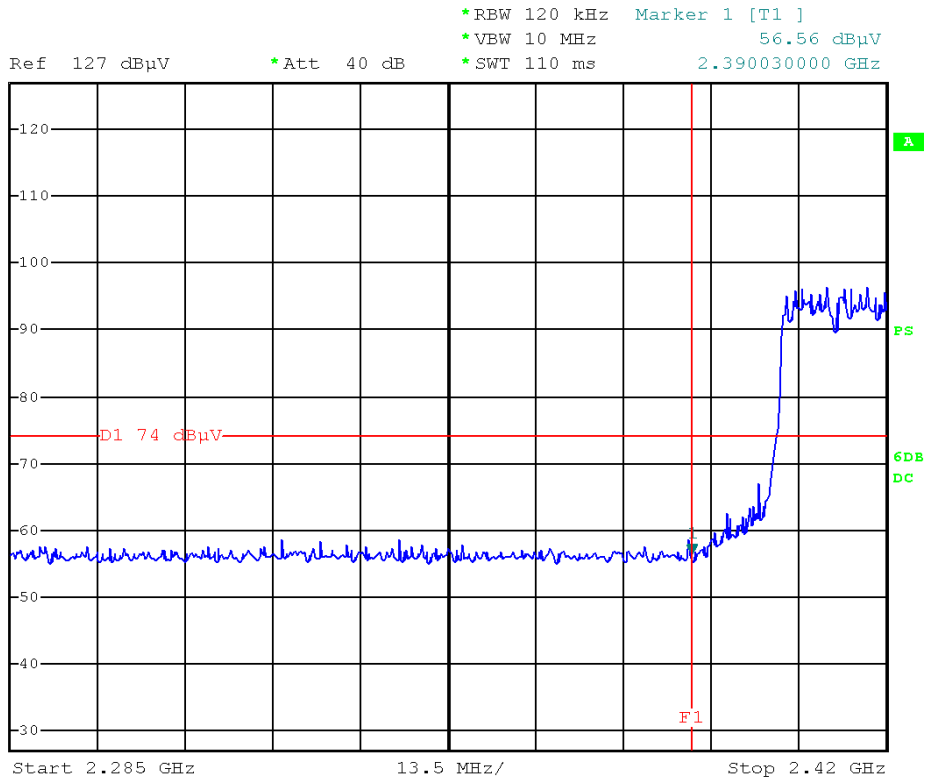

CH Low (802.11g MODE-Vertical-Average)

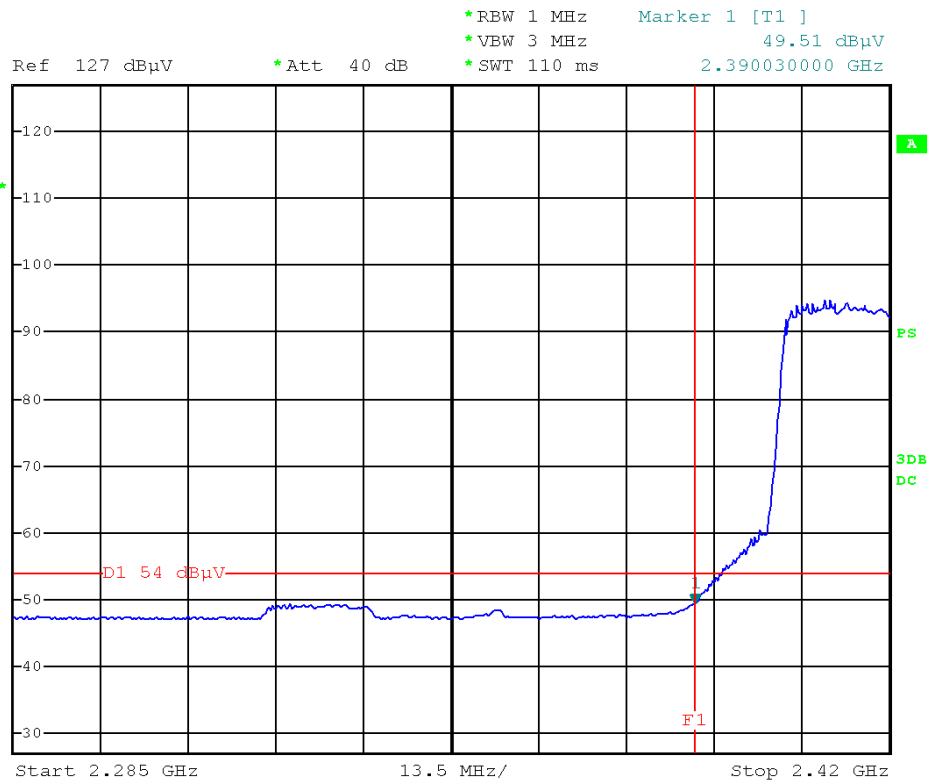

CH High (802.11g MODE–Horizontal–Peak)

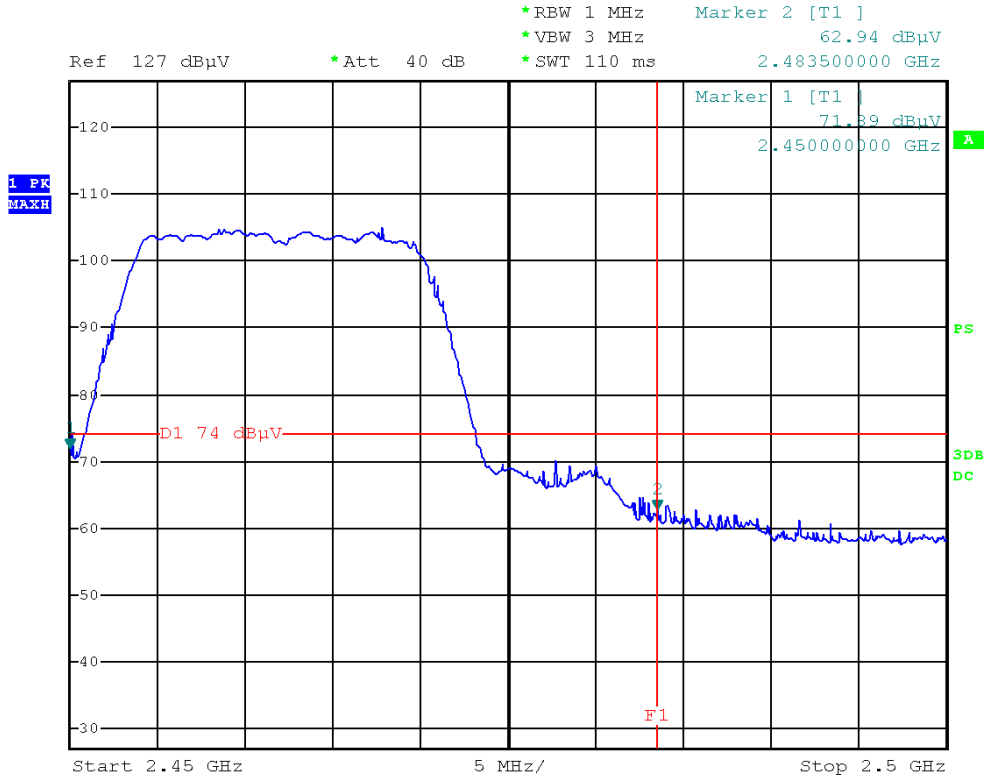

CH High (802.11g MODE–Horizontal–Average)

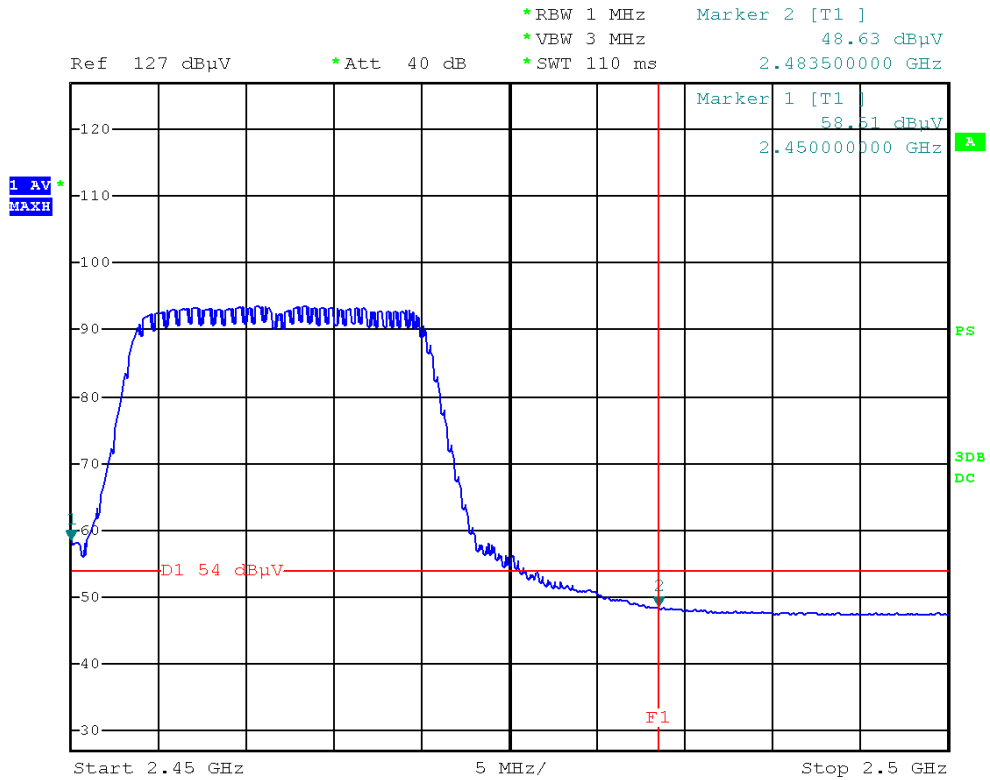

CH High (802.11g MODE-Vertical-Peak)

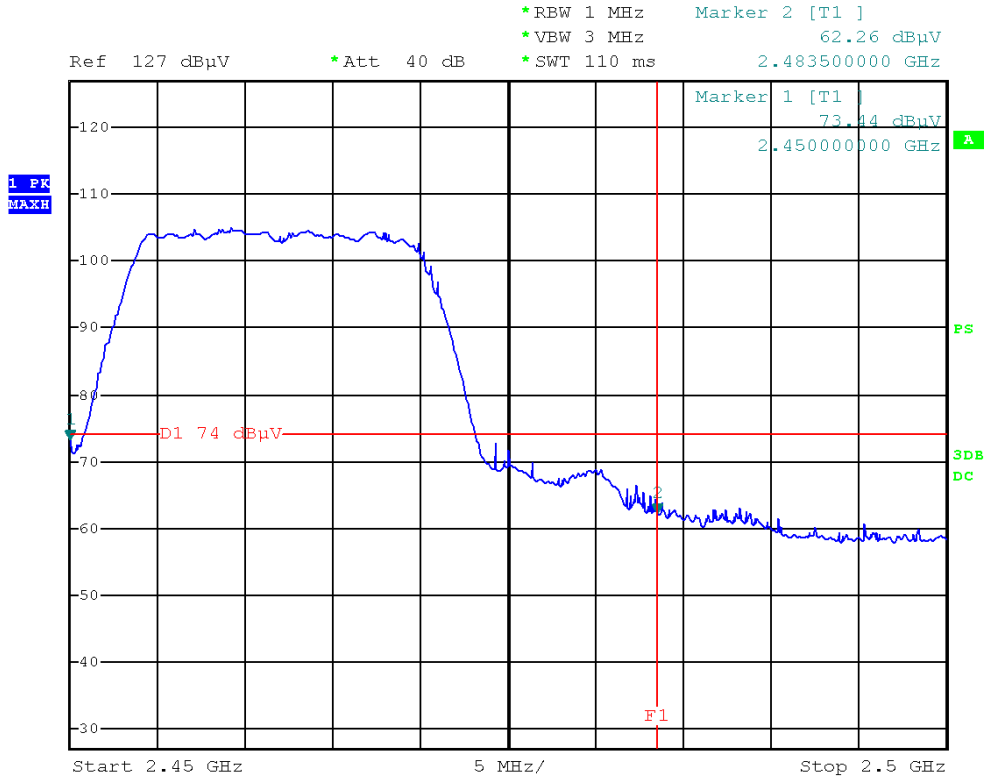

CH High (802.11g MODE-Vertical-Average)

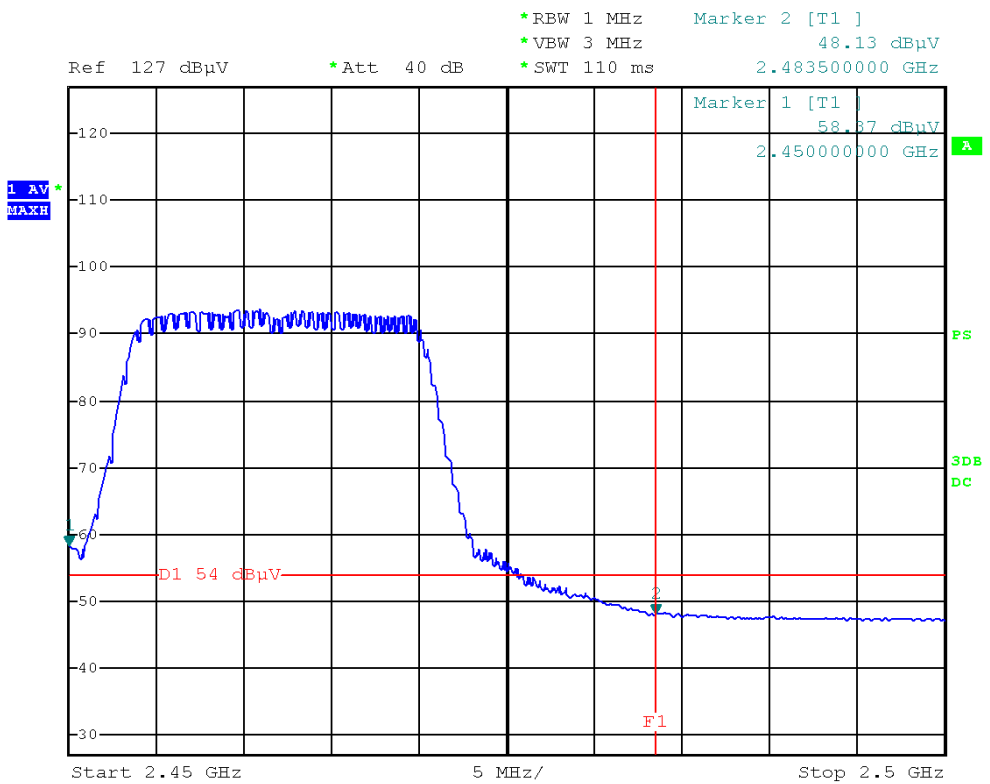

10. ANTENNA REQUIREMENT

10.1 Standard Applicable

Section 15.203:

An intentional radiator shall be designed to ensure that no antenna other than that furnished by the responsible party shall be used with the device. The use of a permanently attached antenna or of an antenna that uses a unique coupling to the intentional radiator shall be considered sufficient to comply with the provisions of this Section. The manufacturer may design the unit so that a broken antenna can be replaced by the user, but the use of a standard antenna jack or electrical connector is prohibited.

Section 15.247(b)/(c):

If transmitting antennas of directional gain greater than 6 dBi are used, the peak output power from the intentional radiator shall be reduced by the amount in dB that the directional gain of the antenna exceeds 6 dBi.

If the intentional radiator is used exclusively for fixed, point-to-point operations may employ transmitting antennas with directional gain greater than 6 dBi provided the maximum peak output power of the intentional radiator is reduced by 1 dB for every 3 dB that the directional gain of the antenna exceeds 6 dBi.

10.2 Antenna Connected Construction

The antenna connector is designed with permanent attachment and no consideration of replacement.