



## FCC PART 15 SUBPART C TEST REPORT

### FCC PART 15.247

**Report Reference No.**.....: **TRE1401002103 R/C: 88877**

**FCC ID**.....: **YPVITALCOMZEUZ-HD**

Compiled by

( position+printed name+signature)..: File administrators Eric Wang

*Eric Wang*

Supervised by

( position+printed name+signature)..: Test Engineer Yuchao Wang

*yuchao.wang*

Approved by

( position+printed name+signature)..: Manager Wenliang Li

*Wenliang Li*

Date of issue.....: Jan 15, 2014

**Testing Laboratory Name** .....: **Shenzhen Huatongwei International Inspection Co., Ltd**

Address .....: Keji Nan No.12 Road, Hi-tech Park, Shenzhen, China

**Applicant's name**.....: **ITALCOM GROUP**

Address .....: C1105-1107, Tiley Central Plaza, No3 Haide Road, Nanshan District, Shenzhen 518054

**Test specification** .....

Standard .....: **FCC Part 15.247: Operation within the bands 902-928 MHz, 2400-2483.5 MHz and 5725-5850 MHz**

TRF Originator.....: Shenzhen Huatongwei International Inspection CO., Ltd

Master TRF.....: Dated 2006-06

**Shenzhen Huatongwei International Inspection Co., Ltd. All rights reserved.**

This publication may be reproduced in whole or in part for non-commercial purposes as long as the Shenzhen Huatongwei International Inspection Co., Ltd is acknowledged as copyright owner and source of the material. Shenzhen Huatongwei International Inspection Co., Ltd takes no responsibility for and will not assume liability for damages resulting from the reader's interpretation of the reproduced material due to its placement and context.

**Test item description** .....

Trade Mark .....: NYX

Model/Type reference.....: ZEUZ-HD

Listed Models .....: /

**Manufacturer** .....: **ITALCOM GROUP**

Operation Frequency.....: From 2412MHz to 2462MHz

Rating .....: DC 3.70V

Hardware version .....: MT6582\_K28\_ZeuzHD

Software version .....: ZEUZ\_HD\_AMXNYX\_V001R

Android version .....: 4.2.2

Result.....: **PASS**

**T E S T   R E P O R T**

<b>Test Report No. :</b>	<b>TRE1401002103</b>	Jan 15, 2014
		Date of issue

Equipment under Test : mobile Phone

Model /Type : ZEUZ-HD

Listed Models : /

**Applicant** : **ITALCOM GROUP**

Address : 1728 Coral Way,Coral Gables,Miami,Florida,United States

**Manufacturer** : **ITALCOM GROUP**

Address : 1728 Coral Way,Coral Gables,Miami,Florida,United States

<b>Test Result</b>	<b>PASS</b>
--------------------	-------------

The test report merely corresponds to the test sample.

It is not permitted to copy extracts of these test result without the written permission of the test laboratory.

## Contents

<b>1.</b>	<b><u>TEST STANDARDS</u></b> .....	<b>4</b>
<b>2.</b>	<b><u>SUMMARY</u></b> .....	<b>5</b>
2.1.	General Remarks	5
2.2.	Product Description	5
2.3.	Equipment Under Test	5
2.4.	Description of the test mode	6
2.5.	Short description of the Equipment under Test (EUT)	6
2.6.	EUT operation mode	6
2.7.	EUT configuration	6
2.8.	Internal Identification of AE used during the test	6
2.9.	Related Submittal(s) / Grant (s)	6
2.10.	Modifications	7
2.11.	NOTE	7
<b>3.</b>	<b><u>TEST ENVIRONMENT</u></b> .....	<b>8</b>
3.1.	Address of the test laboratory	8
3.2.	Test Facility	8
3.3.	Environmental conditions	9
3.4.	Test Description	9
3.5.	Statement of the measurement uncertainty	9
3.6.	Equipments Used during the Test	10
<b>4.</b>	<b><u>TEST CONDITIONS AND RESULTS</u></b> .....	<b>11</b>
4.1.	AC Power Conducted Emission	11
4.2.	Radiated Emission	13
4.3.	Maximum Peak Output Power	21
4.4.	Power Spectral Density	30
4.5.	Band Edge Compliance of RF Emission	39
4.6.	Spurious RF Conducted Emission	50
4.7.	6dB Bandwidth	75
4.8.	Antenna Requirement	84
<b>5.</b>	<b><u>TEST SETUP PHOTOS OF THE EUT</u></b> .....	<b>85</b>
<b>6.</b>	<b><u>EXTERNAL AND INTERNAL PHOTOS OF THE EUT</u></b> .....	<b>87</b>

## 1. TEST STANDARDS

The tests were performed according to following standards:

[FCC Rules Part 15.247](#): Frequency Hopping, Direct Spread Spectrum and Hybrid Systems that are in operation within the bands of 902-928 MHz, 2400-2483.5 MHz, and 5725-5850 MHz.

[ANSI C63.10](#): American National Standard for Testing Unlicensed Wireless Devices

[KDB558074 D01 V03](#): Guidance for Performing Compliance Measurements on Digital Transmission Systems (DTS) Operating Under §15.247

## 2. SUMMARY

### 2.1. General Remarks

Date of receipt of test sample	:	Jan 07, 2014
Testing commenced on	:	Jan 07, 2014
Testing concluded on	:	Jan 15, 2014

### 2.2. Product Description

The **ITALCOM GROUP**'s Model: ZEUZ-HD or the "EUT" as referred to in this report; more general information as follows, for more details, refer to the user's manual of the EUT.

Name of EUT	mobile phone
Model Number	ZEUZ-HD
FCC ID	YPVITALCOMZEUZ-HD
Modulation Type	QPSK for WCDMA,GMSK for GSM/GPRS/EGPRS,8PSK only supported downlink
Antenna Type	Internal
Hardware version	MT6582_K28_ZeuzHD
Software version	ZEUZ_HD_AMXNYX_V001R
Android version	4.2.2
WLAN FCC Operation frequency	IEEE 802.11b: 2412MHz—2462MHz IEEE 802.11g: 2412MHz—2462MHz IEEE 802.11n HT20: 2412MHz—2462MHz IEEE 802.11n HT40: 2422MHz—2452MHz
Bluetooth FCC Operation frequency	2402MHz-2480MHz
WLAN Modulation	IEEE 802.11b: DSSS(CCK,DQPSK,DBPSK) IEEE 802.11g: OFDM(64QAM, 16QAM, QPSK, BPSK) IEEE 802.11n HT20: OFDM (64QAM, 16QAM, QPSK,BPSK) IEEE 802.11n HT40: OFDM (64QAM, 16QAM, QPSK,BPSK)
Bluetooth Modulation	GFSK,8PSK, $\pi$ /4DQPSK
GSM/EDGE/GPRS	Supported GSM/GPRS/EDGE
WCDMA Operation Frequency Band	FDD Band II, FDD Band V
HSDPA Release Version	Release 8
HSUPA Release Version	Release 6
WCDMA Release Version	R99
Bluetooth	Supported BT v2.1+EDR and BT 4.0
Extreme temp. Tolerance	-30°C to +60°C
Extreme vol. Limits	3.40VDC to 4.20VDC (nominal: 3.70VDC)
GSM/GPRS Operation Frequency Band	GSM850/PCS1900
GSM Release Version	R99
GPRS operation mode	Class B
GPRS Multislot Class	12
EGPRS Multislot Class	12

### 2.3. Equipment Under Test

#### Power supply system utilised

Power supply voltage	:	<input type="radio"/> 120V / 60 Hz	<input type="radio"/> 115V / 60Hz
		<input type="radio"/> 12 V DC	<input type="radio"/> 24 V DC
		<input checked="" type="radio"/> Other (specified in blank below)	

DC 3.70V/DC 5V From Adapter AC 120V/60Hz

## 2.4. Description of the test mode

IEEE 802.11b/g/n: The product support Third channels but only use Eleventh channels in USA.

Channel	Frequency(MHz)	Channel	Frequency(MHz)
1	2412	8	2447
2	2417	9	2452
3	2422	10	2457
4	2427	11	2462
5	2432		
6	2437		
7	2442		

## 2.5. Short description of the Equipment under Test (EUT)

2.4GHz (mobile Phone (M/N:ZEUZ-HD))

For more details, refer to the user's manual of the EUT.

## 2.6. EUT operation mode

The EUT has been tested under typical operating condition. The Applicant provides command to control the EUT for staying in continuous transmitting and receiving mode for testing.

## 2.7. EUT configuration

The following peripheral devices and interface cables were connected during the measurement:

- supplied by the manufacturer
- supplied by the lab

<input type="radio"/> Power Cable	Length (m) :	/
	Shield :	/
	Detachable :	/
<input type="radio"/> Multimeter	Manufacturer :	/
	Model No. :	/

## 2.8. Internal Identification of AE used during the test

AE ID*	Description
AE1	Battery
AE2	Charger and USB cable

AE1

Model:NYX1800A69X58  
 Manufacturer: ITALCOM GROUP.  
 Capacitance: 1800mAh  
 Nominal Voltage:3.70V

AE2:

Model: ZEUZ-HD  
 Manufacturer: ITALCOM GROUP.  
 Input: 100-240V~50/60Hz 0.15A  
 Output: OUTPUT: 5.0V DC 1.0A  
 Power Cable Length: 90cm  
 Shielded       Unshielded

\*AE ID: is used to identify the test sample in the lab internally.

## 2.9. Related Submittal(s) / Grant (s)

This submittal(s) (test report) is intended for **FCC ID: YPVITALCOMZEUZ-HD** filing to comply with Section 15.247 of

the FCC Part 15, Subpart C Rules.

## 2.10. Modifications

No modifications were implemented to meet testing criteria.

## 2.11. NOTE

1. The EUT is a mobile Phone WCDMA/HSUPA/HSDPA/GPRS/GSM,WLAN and Bluetooth function,The functions of the EUT listed as below:

	Test Standards	Reference Report
GSM/GPRS/EGPRS	FCC Part 22/FCC Part 24	TRE1401002101
WCDMA/HSUPA/HSDPA	FCC Part 22/FCC Part 24	TRE1401002102
WLAN	FCC Part 15 C 15.247	TRE1401002103
Bluetooth v2.1+EDR	FCC Part 15 C 15.247	TRE1401002104
Bluetooth 4.0	FCC Part 15 C 15.247	TRE1401002105
USB Port	FCC Part 15 B	TRE1401002106
SAR	FCC Part 2 §2.1093	TRE1401002107

2. The frequency bands used in this EUT are listed as follows:

Frequency Band(MHz)	2400-2483.5	5150-5350	5470-5725	5725-5850
802.11b	√	—	—	—
802.11g	√	—	—	—
802.11n(20MHz)	√	—	—	—
802.11n(40MHz)	√	—	—	—

3. The EUT incorporates a SISO function,Physically,the EUT provides one completed transmitter and one completed receiver.

Modulation Mode	TX Function
802.11b	1TX
802.11g	1TX
802.11n (20MHz)	1TX
802.11n (40MHz)	1TX

### **3. TEST ENVIRONMENT**

#### **3.1. Address of the test laboratory**

Shenzhen Huatongwei International Inspection Co., Ltd  
Keji Nan No.12 Road, Hi-tech Park, Shenzhen, China  
Phone: 86-755-26715686 Fax: 86-755-26748089

The sites are constructed in conformance with the requirements of ANSI C63.7, ANSI C63.4 (2009) and CISPR Publication 22.

#### **3.2. Test Facility**

The test facility is recognized, certified, or accredited by the following organizations:

##### **CNAS-Lab Code: L1225**

Shenzhen Huatongwei International Inspection Co., Ltd. has been assessed and proved to be in compliance with CNAS-CL01 Accreditation Criteria for Testing and Calibration Laboratories (identical to ISO/IEC 17025: 2005 General Requirements) for the Competence of Testing and Calibration Laboratories, Date of Registration: Mar. 29, 2012. Valid time is until Feb. 28, 2015.

##### **A2LA-Lab Cert. No. 2243.01**

Shenzhen Huatongwei International Inspection Co., Ltd. EMC Laboratory has been accredited by A2LA for technical competence in the field of electrical testing, and proved to be in compliance with ISO/IEC 17025: 2005 General Requirements for the Competence of Testing and Calibration Laboratories and any additional program requirements in the identified field of testing. Valid time is until Sept. 30, 2015.

##### **FCC-Registration No.: 662850**

Shenzhen Huatongwei International Inspection Co., Ltd. EMC Laboratory has been registered and fully described in a report filed with the FCC (Federal Communications Commission). The acceptance letter from the FCC is maintained in our files. Registration 662850, Renewal date Jun. 01, 2012, valid time is until Jun. 01, 2015.

##### **IC-Registration No.: 5377A**

The 3m Alternate Test Site of Shenzhen Huatongwei International Inspection Co., Ltd has been registered by Certification and Engineering Bureau of Industry Canada for the performance of radiated measurements with Registration No. 5377 on Dec 31, 2013. Valid time is until Dec 31, 2016.

##### **ACA**

Shenzhen Huatongwei International Inspection Co., Ltd. EMC Laboratory can also perform testing for the Australian C-Tick mark as a result of our A2LA accreditation.

##### **VCCI**

The 3m Semi-anechoic chamber (12.2m×7.95m×6.7m) and Shielded Room (8m×4m×3m) of Shenzhen Huatongwei International Inspection Co., Ltd has been registered in accordance with the Regulations for Voluntary Control Measures with Registration No.: R-2484. Date of Registration: December 20, 2013. Valid time is until December 19, 2016.

Main Ports Conducted Interference Measurement of Shenzhen Huatongwei International Inspection Co., Ltd has been registered in accordance with the Regulations for Voluntary Control Measures with Registration No.: C-2726. Date of Registration: December 20, 2013. Valid time is until December 19, 2016.

##### **DNV**

Shenzhen Huatongwei International Inspection Co., Ltd. has been found to comply with the requirements of DNV towards subcontractor of EMC and safety testing services in conjunction with the EMC and Low voltage Directives and in the voluntary field. The acceptance is based on a formal quality Audit and follow-ups according to relevant parts of ISO/IEC Guide 17025 (2005), in accordance with the requirements of the DNV Laboratory Quality Manual towards subcontractors. Valid time is until Aug. 24, 2016.



### 3.3. Environmental conditions

During the measurement the environmental conditions were within the listed ranges:

Temperature:	<u>15-35 ° C</u>
Humidity:	<u>30-60 %</u>
Atmospheric pressure:	<u>950-1050mbar</u>

### 3.4. Test Description

FCC PART 15 15.247		
FCC Part 15.207	AC Power Conducted Emission	PASS
FCC Part 15.247(a)(2)	6dB Bandwidth	PASS
FCC Part 15.247(d)	Spurious RF Conducted Emission	PASS
FCC Part 15.247(b)	Maximum Peak Output Power	PASS
FCC Part 15.247(e)	Power Spectral Density	PASS
FCC Part 15.109/ 15.205/ 15.209	Radiated Emissions	PASS
FCC Part 15.247(d)	Band Edge	PASS
FCC Part 15.203/15.247 (b)	Antenna Requirement	PASS

Remark: The measurement uncertainty is not included in the test result.

Preliminary tests were performed in different data rate to find the worst radiated emission. The data rate shown in the table below is the worst-case rate with respect to the specific test item. Investigation has been done on all the possible configurations for searching the worst cases. The following table is a list of the test modes shown in this test report.

Test Items	Mode	Data Rate	Channel
Maximum Peak Conducted Output Power	11b/DSSS	1 Mbps	1/6/11
Power Spectral Density	11g/OFDM	6 Mbps	1/6/11
6dB Bandwidth	11g/OFDM	6 Mbps	1/6/11
Spurious RF conducted emission	11n(20MHz)/OFDM	6.5Mbps	1/6/11
Radiated Emission 9KHz~1GHz& Radiated Emission 1GHz~10th Harmonic	11n(40MHz)/OFDM	13.5 Mbps	3/6/9
Band Edge	11b/DSSS	1 Mbps	1/11
	11g/OFDM	6 Mbps	1/11
	11n(20MHz)/OFDM	6.5Mbps	1/11
	11n(40MHz)/OFDM	13.5 Mbps	3/9

### 3.5. Statement of the measurement uncertainty

The data and results referenced in this document are true and accurate. The reader is cautioned that there may be errors within the calibration limits of the equipment and facilities. The measurement uncertainty was calculated for all measurements listed in this test report acc. to CISPR 16 - 4 „Specification for radio disturbance and immunity measuring apparatus and methods – Part 4: Uncertainty in EMC Measurements“ and is documented in the Shenzhen Huatongwei International Inspection Co., Ltd quality system acc. to DIN EN ISO/IEC 17025. Furthermore, component and process variability of devices similar to that tested may result in additional deviation. The manufacturer has the sole responsibility of continued compliance of the device.

Hereafter the best measurement capability for Shenzhen Huatongwei laboratory is reported:

Test Items	Measurement Uncertainty	Notes
Frequency stability	25 Hz	(1)
Transmitter power conducted	0.57 dB	(1)
Transmitter power Radiated	2.20 dB	(1)
Conducted spurious emission 9KHz-12.75 GHz	1.60 dB	(1)
Radiated spurious emission 9KHz-12.75 GHz	2.20 dB	(1)
Conducted Emission 9KHz-30MHz	3.39 dB	(1)
Radiated Emission 30~1000MHz	4.24 dB	(1)

Radiated Emissio 1~18GHz	5.16 dB	(1)
Radiated Emissio 18-40GHz	5.54 dB	(1)
Occupied Bandwidth	-----	(1)
Emission Mask	-----	(1)
Modulation Characteristic	-----	(1)
Transmitter Frequency Behavior	-----	(1)

(1) This uncertainty represents an expanded uncertainty expressed at approximately the 95% confidence level using a coverage factor of k=1.96.

### 3.6. Equipments Used during the Test

AC Power Conducted Emission					
Item	Test Equipment	Manufacturer	Model No.	Serial No.	Cal Due
1	Artificial Mains	Rohde&Schwarz	ESH2-Z5	100028	2014/10/25
2	EMI Test Receiver	Rohde&Schwarz	ESCI	100106	2014/10/25
3	Pulse Limiter	Rohde&Schwarz	ESHSZ2	100044	2014/10/25
4	EMI Test Software	Rohde&Schwarz	ES-K1 V1.71	N/A	N/A

Radiated Emission					
Item	Test Equipment	Manufacturer	Model No.	Serial No.	Cal Due
1	Ultra-Broadband Antenna	ShwarzBeck	VULB9163	538	2014/10/25
2	EMI TEST RECEIVER	Rohde&Schwarz	ESI 26	100009	2014/10/25
3	EMI TEST Software	Audix	E3	N/A	2014/10/25
4	TURNTABLE	ETS	2088	2149	N/A
5	ANTENNA MAST	ETS	2075	2346	N/A
6	EMI TEST Software	Rohde&Schwarz	ESK1	N/A	N/A
7	HORN ANTENNA	ShwarzBeck	9120D	1011	2014/10/25
8	Amplifer	Sonoma	310N	E009-13	2014/10/25
9	JS amplifer	Rohde&Schwarz	JS4-00101800-28-5A	F201504	2014/10/25
10	High pass filter	Compliance Direction systems	BSU-6	34202	2014/10/25
11	HORN ANTENNA	ShwarzBeck	9120D	1012	2014/10/25
12	Amplifer	Compliance Direction systems	PAP1-4060	120	2014/10/25
13	Loop Antenna	Rohde&Schwarz	HFH2-Z2	100020	2014/10/25
14	TURNTABLE	MATURO	TT2.0	----	N/A
15	ANTENNA MAST	MATURO	TAM-4.0-P	----	N/A
16	Horn Antenna	SCHWARZBECK	BBHA9170	25841	2014/10/25
17	HORN ANTENNA	Rohde&Schwarz	HF906	100039	2014/10/25
18	ULTRA-BROADBAND ANTENNA	Rohde&Schwarz	HL562	100015	2014/10/25

Maximum Peak Output Power / Power Spectral Density / 6dB Bandwidth / Band Edge Compliance of RF Emission / Spurious RF Conducted Emission					
Item	Test Equipment	Manufacturer	Model No.	Serial No.	Cal Due
1	Spectrum Analyzer	Rohde&Schwarz	FSP	1164.4391.40	2014/10/25

The Cal.Interval was one year

## 4. TEST CONDITIONS AND RESULTS

### 4.1. AC Power Conducted Emission

#### TEST CONFIGURATION

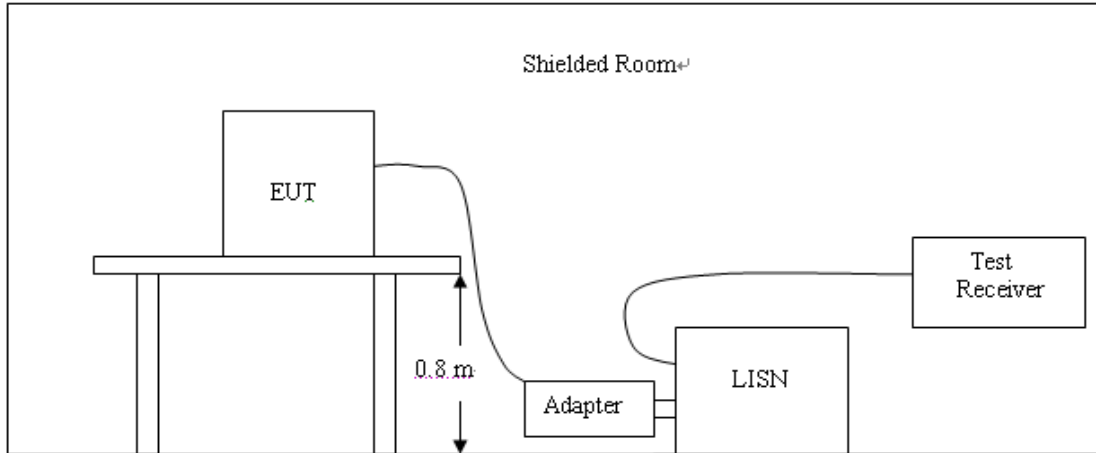

#### TEST PROCEDURE

1. The equipment was set up as per the test configuration to simulate typical actual usage per the user's manual. The EUT is a tabletop system, a wooden table with a height of 0.8 meters is used and is placed on the ground plane as per ANSI C63.10-2009.
2. Support equipment, if needed, was placed as per ANSI C63.10-2009
3. All I/O cables were positioned to simulate typical actual usage as per ANSI C63.10-2009
4. The EUT received DC5V power from the adapter, the adapter received AC120V/60Hz power through a Line Impedance Stabilization Network (LISN) which supplied power source and was grounded to the ground plane.
5. All support equipments received AC power from a second LISN, if any.
6. The EUT test program was started. Emissions were measured on each current carrying line of the EUT using a spectrum Analyzer / Receiver connected to the LISN powering the EUT. The LISN has two monitoring points: Line 1 (Hot Side) and Line 2 (Neutral Side). Two scans were taken: one with Line 1 connected to Analyzer / Receiver and Line 2 connected to a 50 ohm load; the second scan had Line 1 connected to a 50 ohm load and Line 2 connected to the Analyzer / Receiver.
7. Analyzer / Receiver scanned from 150 KHz to 30MHz for emissions in each of the test modes.
8. During the above scans, the emissions were maximized by cable manipulation.

#### AC Power Conducted Emission Limit

For intentional device, according to § 15.207(a) AC Power Conducted Emission Limits is as following :

Frequency (MHz)	Maximum RF Line Voltage (dBµV)			
	CLASS A		CLASS B	
	Q.P.	Ave.	Q.P.	Ave.
0.15 - 0.50	79	66	66-56*	56-46*
0.50 - 5.00	73	60	56	46
5.00 - 30.0	73	60	60	50

\* Decreasing linearly with the logarithm of the frequency

#### TEST RESULTS

The AC Power Conducted Emission measurement are performed the each test mode (b/g/n) and channel (low/mid/high), the datum recorded below (802.11b mode,the middle channel) is the worst case for all the test modes and channels.

**SCAN TABLE: "Voltage (9K-30M) FIN"**  
 Short Description: 150K-30M Voltage

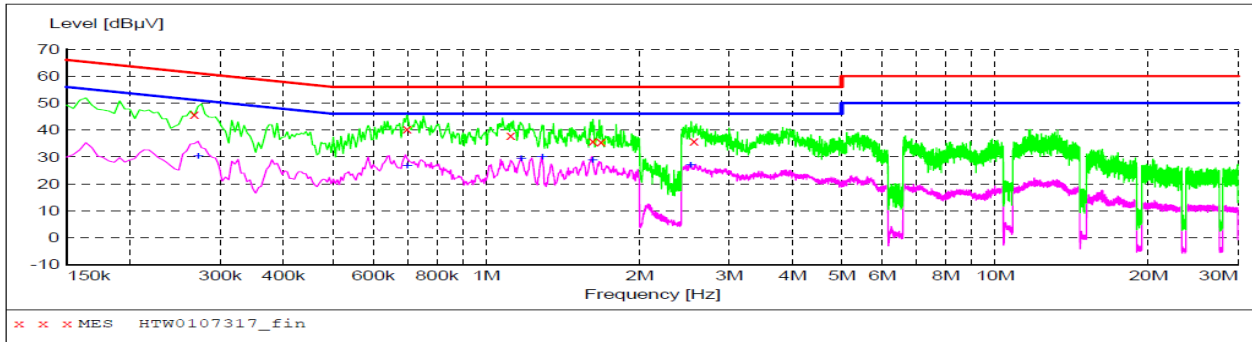

**MEASUREMENT RESULT: "HTW0107317\_fin"**

1/7/2014 2:48PM

Frequency MHz	Level dBµV	Transd dB	Limit dBµV	Margin dB	Detector	Line	PE
0.267000	45.80	10.6	61	15.4	QP	N	GND
0.699000	40.40	10.3	56	15.6	QP	N	GND
1.117500	37.90	10.3	56	18.1	QP	N	GND
1.621500	35.90	10.3	56	20.1	QP	N	GND
1.680000	35.40	10.3	56	20.6	QP	N	GND
2.562000	35.80	10.3	56	20.2	QP	N	GND

**MEASUREMENT RESULT: "HTW0107317\_fin2"**

1/7/2014 2:48PM

Frequency MHz	Level dBµV	Transd dB	Limit dBµV	Margin dB	Detector	Line	PE
0.271500	30.10	10.6	51	21.0	AV	N	GND
0.699000	26.40	10.3	46	19.6	AV	N	GND
1.171500	29.20	10.3	46	16.8	AV	N	GND
1.288500	29.70	10.3	46	16.3	AV	N	GND
1.617000	28.70	10.3	46	17.3	AV	N	GND
2.521500	26.90	10.3	46	19.1	AV	N	GND

**SCAN TABLE: "Voltage (9K-30M) FIN"**  
 Short Description: 150K-30M Voltage

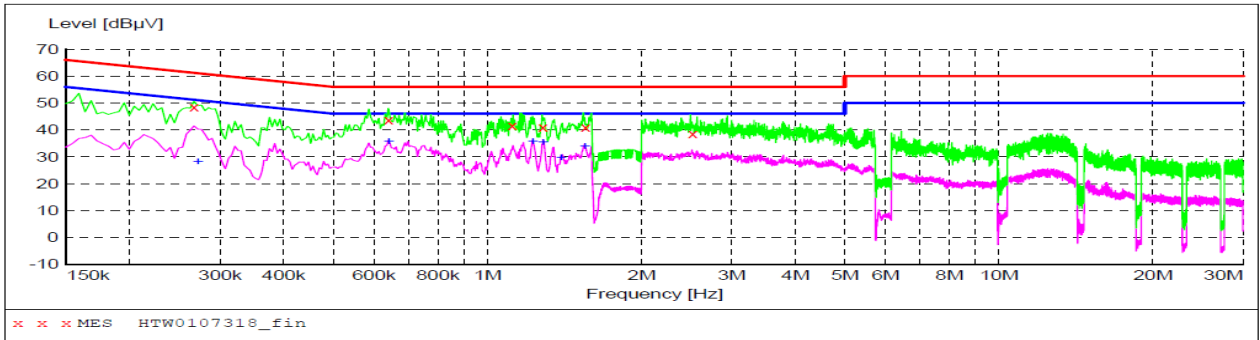

**MEASUREMENT RESULT: "HTW0107318\_fin"**

1/7/2014 2:51PM

Frequency MHz	Level dBµV	Transd dB	Limit dBµV	Margin dB	Detector	Line	PE
0.267000	48.40	10.6	61	12.8	QP	L1	GND
0.640500	43.60	10.3	56	12.4	QP	L1	GND
1.117500	41.60	10.3	56	14.4	QP	L1	GND
1.284000	41.00	10.3	56	15.0	QP	L1	GND
1.554000	41.00	10.3	56	15.0	QP	L1	GND
2.517000	38.70	10.3	56	17.3	QP	L1	GND

**MEASUREMENT RESULT: "HTW0107318\_fin2"**

1/7/2014 2:51PM

Frequency MHz	Level dBµV	Transd dB	Limit dBµV	Margin dB	Detector	Line	PE
0.271500	28.20	10.6	51	22.9	AV	L1	GND
0.640500	35.60	10.3	46	10.4	AV	L1	GND
1.225500	35.50	10.3	46	10.5	AV	L1	GND
1.284000	35.20	10.3	46	10.8	AV	L1	GND
1.392000	29.50	10.3	46	16.5	AV	L1	GND
1.549500	33.80	10.3	46	12.2	AV	L1	GND

## 4.2. Radiated Emission

### TEST CONFIGURATION

Frequency range 9KHz – 30MHz

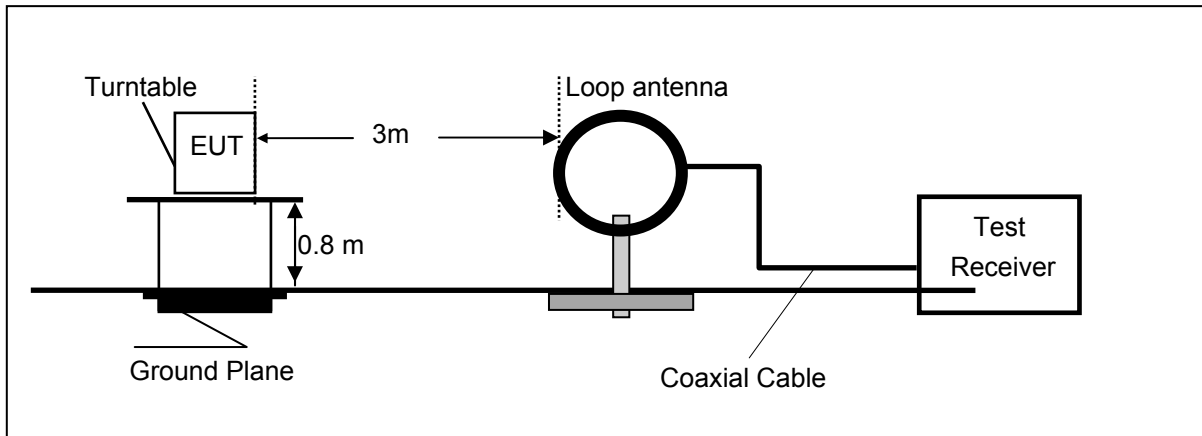

Frequency range 30MHz – 100MHz

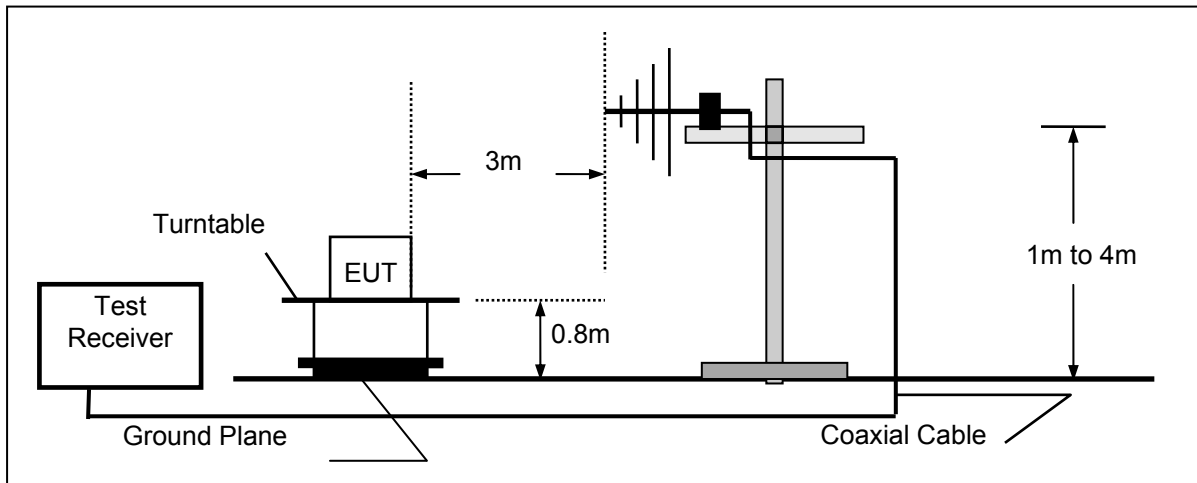

Frequency range above 1GHz-25GHz

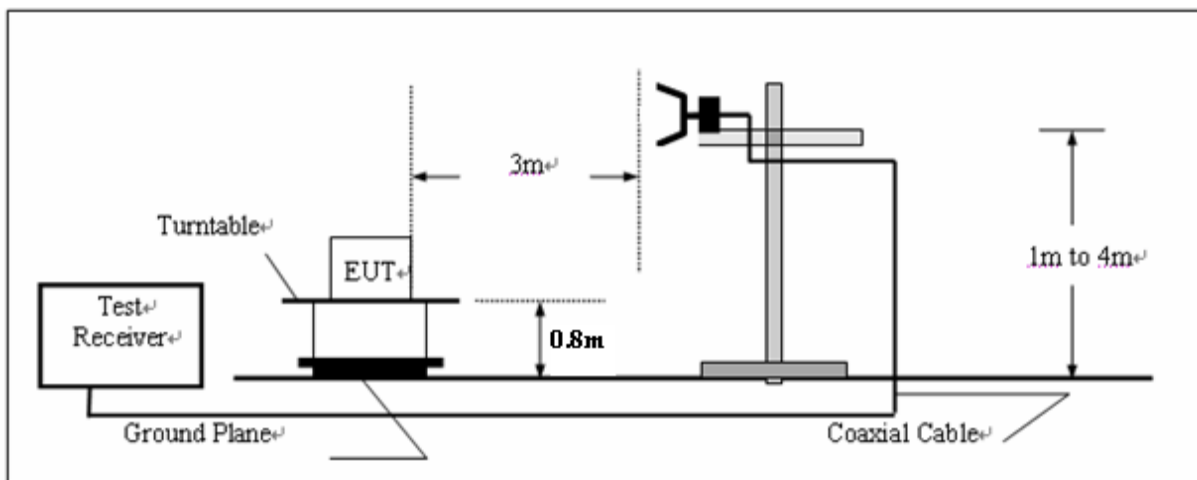

### TEST PROCEDURE

1. The EUT was placed on a turn table which is 0.8m above ground plane.
2. Maximum procedure was performed by raising the receiving antenna from 1m to 4m and rotating the turn table from 0° to 360° to acquire the highest emissions from EUT

3. And also, each emission was to be maximized by changing the polarization of receiving antenna both horizontal and vertical.
4. Repeat above procedures until all frequency measurements have been completed.
5. The EUT minimum operation frequency was 32.768KHz and maximum operation frequency was 2462MHz.so radiated emission test frequency band from 9KHz to 25GHz.

### Field Strength Calculation

The field strength is calculated by adding the Antenna Factor and Cable Factor and subtracting the Amplifier Gain and Duty Cycle Correction Factor(if any) from the measured reading. The basic equation with a sample calculation is as follows:

$$FS = RA + AF + CL - AG$$

Where FS = Field Strength	CL = Cable Attenuation Factor (Cable Loss)
RA = Reading Amplitude	AG = Amplifier Gain
AF = Antenna Factor	

### RADIATION LIMIT

For intentional device, according to § 15.209(a), the general requirement of field strength of radiated emission from intentional radiators at a distance of 3 meters shall not exceed the following table. According to § 15.247(d), in any 100kHz bandwidth outside the frequency band in which the EUT is operating, the radio frequency power that is produced by the intentional radiator shall be at least 20dB below that in the 100kHz bandwidth within the band that contains the highest level of desired power.

The frequency spectrum above 1 GHz for Transmitter was investigated. All emission not reported are much lower than the prescribed limits. Set the RBW=1MHz,VBW=3MHz for Peak Detector while the RBW=1MHz,VBW=10Hz for Average Detector,Readings are both peak and average values.

Frequency (MHz)	Distance (Meters)	Radiated (dBµV/m)	Radiated (µV/m)
0.009-0.49	300	$20\log(2400/F(\text{KHz}))+80$	$2400/F(\text{KHz})$
0.49-1.705	30	$20\log(24000/F(\text{KHz}))+40$	$24000/F(\text{KHz})$
1.705-30	30	$20\log(30)+40$	30
30-88	3	40.0	100
88-216	3	43.5	150
216-960	3	46.0	200
Above 960	3	54.0	500

### TEST RESULTS

Remark:

1. The radiated measurement are performed the each test mode (b/g/n) and channel (low/mid/high), the datum recorded below (802.11b mode,the middle channel) is the worst case for all the test mode and channel.
2. ULTRA-BROADBAND ANTENNA for the radiation emission test below 1G.
3. HORN ANTENNA for the radiation emission test above 1G.
4. We tested both battery powered and powered by adapter charging mode at three orientations,recored woest case at powered by adapter charging mode.

#### **For 9KHz to 30MHz**

Frequency (MHz)	Corrected Reading (dBµV/m)@3m	FCC Limit (dBµV/m) @3m	Margin (dB)	Detector	Result
12.00	41.56	69.54	27.98	QP	PASS
24.00	38.75	69.54	30.79	QP	PASS

For 30MHz to 1000MHz

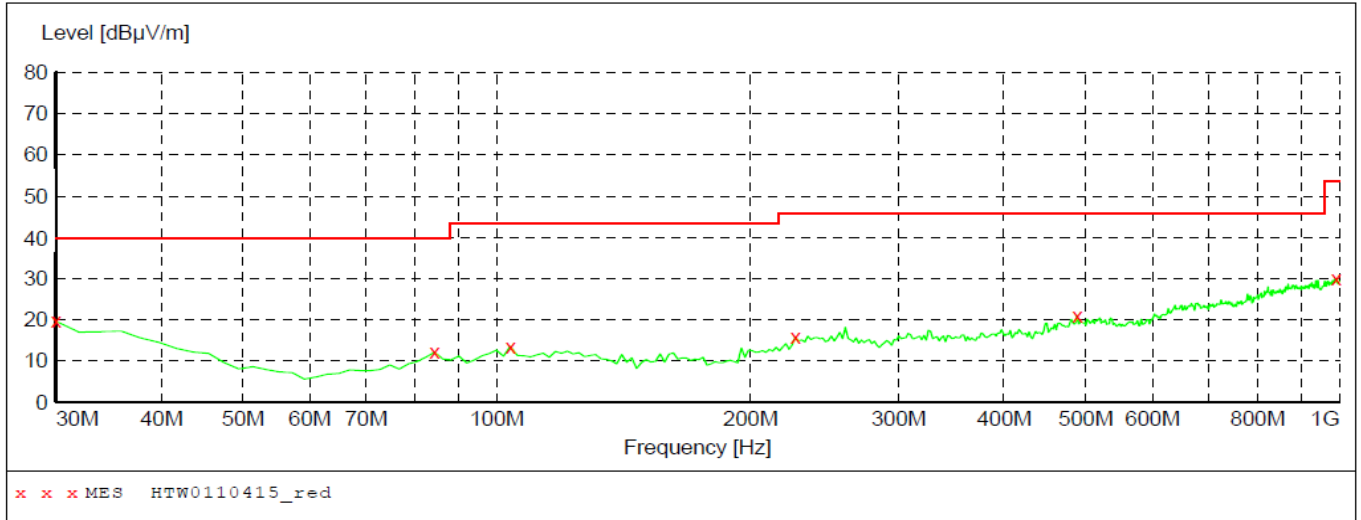

**MEASUREMENT RESULT: "HTW0110415\_red"**

1/10/2014 12:24PM

Frequency MHz	Level dBµV/m	Transd dB	Limit dBµV/m	Margin dB	Det.	Height cm	Azimuth deg	Polarization
30.000000	19.60	-10.0	40.0	20.4	P k	100.0	142.00	HORIZONTAL
84.428858	12.10	-19.7	40.0	27.9	P k	100.0	142.00	HORIZONTAL
103.867735	13.50	-18.3	43.5	30.0	P k	100.0	239.00	HORIZONTAL
226.332665	15.70	-18.4	46.0	30.3	P k	100.0	131.00	HORIZONTAL
488.757515	21.00	-11.6	46.0	25.0	P k	100.0	65.00	HORIZONTAL
992.224449	30.00	-3.1	54.0	24.0	P k	100.0	347.00	HORIZONTAL

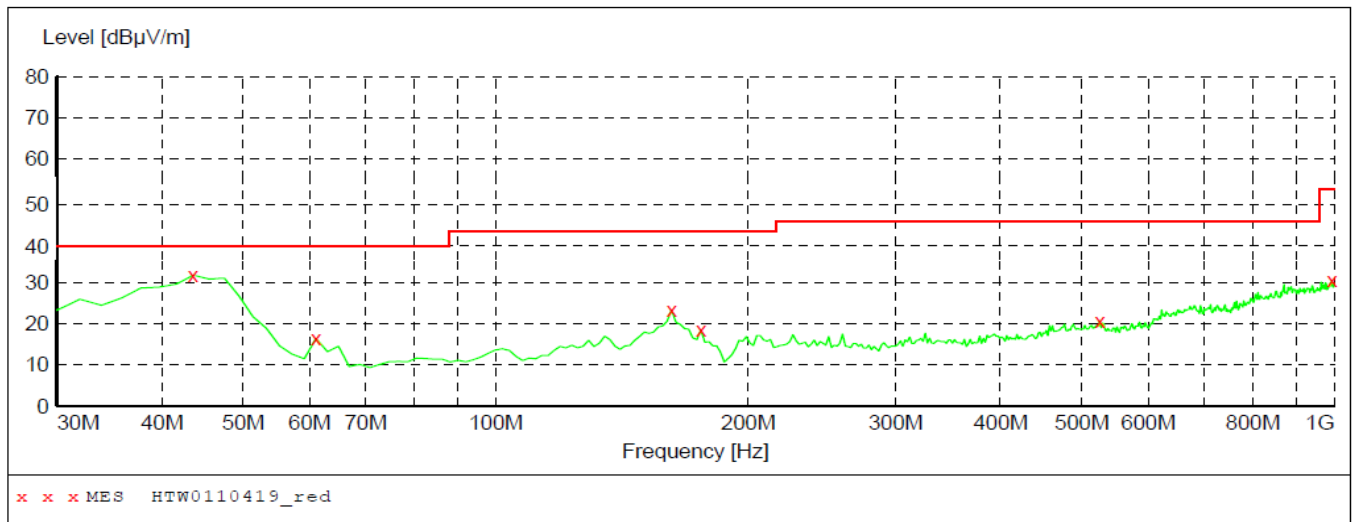

**MEASUREMENT RESULT: "HTW0110419\_red"**

1/10/2014 12:30PM

Frequency MHz	Level dBµV/m	Transd dB	Limit dBµV/m	Margin dB	Det.	Height cm	Azimuth deg	Polarization
43.607214	31.80	-17.2	40.0	8.2	P k	100.0	62.00	VERTICAL
61.102204	16.40	-23.4	40.0	23.6	P k	100.0	161.00	VERTICAL
162.184369	23.30	-21.6	43.5	20.2	P k	100.0	192.00	VERTICAL
175.791583	18.40	-21.0	43.5	25.1	P k	100.0	239.00	VERTICAL
525.691383	20.70	-11.0	46.0	25.3	P k	200.0	182.00	VERTICAL
994.168337	30.50	-3.0	54.0	23.5	P k	100.0	207.00	VERTICAL

For 1GHz to 25GHz

## 802.11b Mode(above 1GHz)

ANTENNA POLARITY & TEST DISTANCE: HORIZONTAL AT 3 M (802.11b--2412MHz)												
No.	Frequency (MHz)	Emission Level (dBuV/m)		Limit (dBuV/m)	Margin (dB)	Antenna Height (m)	Table Angle (Degree)	Raw Value (dBuV)	Antenna Factor (dB/m)	Cable Factor (dB)	Pre-amplifier	Correction Factor (dB/m)
1	4824.00	61.35	PK	74.00	12.65	1.00 H	39	59.25	31.60	7.00	36.5	2.10
1	4824.00	45.76	AV	54.00	8.24	1.00 H	39	43.66	31.60	7.00	36.5	2.10
2	7236.00	61.91	PK	74.00	12.09	1.00 H	131	50.98	37.33	8.90	35.3	10.93
2	7236.00	46.69	AV	54.00	7.31	1.00 H	131	35.76	37.33	8.90	35.3	10.93

ANTENNA POLARITY & TEST DISTANCE: VERTICAL AT 3 M (802.11b--2412MHz)												
No.	Frequency (MHz)	Emission Level (dBuV/m)		Limit (dBuV/m)	Margin (dB)	Antenna Height (m)	Table Angle (Degree)	Raw Value (dBuV)	Antenna Factor (dB/m)	Cable Factor (dB)	Pre-amplifier	Correction Factor (dB/m)
1	4824.00	62.35	PK	74.00	11.65	1.00 H	301	60.25	31.60	7.00	36.5	2.10
1	4824.00	50.16	AV	54.00	3.84	1.00 H	301	48.06	31.60	7.00	36.5	2.10
2	7236.00	60.07	PK	74.00	13.93	1.00 H	157	49.14	37.33	8.90	35.3	10.93
2	7236.00	50.09	AV	54.00	3.91	1.00 H	157	39.16	37.33	8.90	35.3	10.93

ANTENNA POLARITY & TEST DISTANCE: HORIZONTAL AT 3 M (802.11b--2437MHz)												
No.	Frequency (MHz)	Emission Level (dBuV/m)		Limit (dBuV/m)	Margin (dB)	Antenna Height (m)	Table Angle (Degree)	Raw Value (dBuV)	Antenna Factor (dB/m)	Cable Factor (dB)	Pre-amplifier	Correction Factor (dB/m)
1	4874.00	58.70	PK	74.00	15.30	1.00 H	215	56.58	31.02	7.60	36.5	2.12
1	4874.00	47.6	AV	54.00	6.40	1.00 H	215	45.48	31.02	7.60	36.5	2.12
2	7311.00	61.57	PK	74.00	12.43	1.00 H	193	50.49	37.28	8.60	34.8	11.08
2	7311.00	48.66	AV	54.00	5.34	1.00 H	193	37.58	37.28	8.60	34.8	11.08

ANTENNA POLARITY & TEST DISTANCE: VERTICAL AT 3 M (802.11b--2437MHz)												
No.	Frequency (MHz)	Emission Level (dBuV/m)		Limit (dBuV/m)	Margin (dB)	Antenna Height (m)	Table Angle (Degree)	Raw Value (dBuV)	Antenna Factor (dB/m)	Cable Factor (dB)	Pre-amplifier	Correction Factor (dB/m)
1	4874.00	58.70	PK	74.00	15.30	1.00 H	131	56.58	31.02	7.60	36.5	2.12
1	4874.00	47.61	AV	54.00	6.39	1.00 H	131	45.49	31.02	7.60	36.5	2.12
2	7311.00	57.66	PK	74.00	16.34	1.00 H	39	46.58	37.28	8.60	34.8	11.08
2	7311.00	47.57	AV	54.00	6.43	1.00 H	39	36.49	37.28	8.60	34.8	11.08

ANTENNA POLARITY & TEST DISTANCE: HORIZONTAL AT 3 M (802.11b--2462MHz)												
No.	Frequency (MHz)	Emission Level (dBuV/m)		Limit (dBuV/m)	Margin (dB)	Antenna Height (m)	Table Angle (Degree)	Raw Value (dBuV)	Antenna Factor (dB/m)	Cable Factor (dB)	Pre-amplifier	Correction Factor (dB/m)
1	4924.00	59.05	PK	74.00	14.95	1.00 H	319	56.67	31.58	7.00	36.2	2.38
1	4924.00	49.14	AV	54.00	4.86	1.00 H	319	46.76	31.58	7.00	36.2	2.38
2	7386.00	61.39	PK	74.00	12.61	1.00 H	127	49.68	38.51	8.50	35.3	11.71
2	7386.00	48.39	AV	54.00	5.61	1.00 H	127	36.68	38.51	8.50	35.3	11.71

ANTENNA POLARITY & TEST DISTANCE: VERTICAL AT 3 M (802.11b--2462MHz)												
No.	Frequency (MHz)	Emission Level (dBuV/m)		Limit (dBuV/m)	Margin (dB)	Antenna Height (m)	Table Angle (Degree)	Raw Value (dBuV)	Antenna Factor (dB/m)	Cable Factor (dB)	Pre-amplifier	Correction Factor (dB/m)
1	4924.00	62.24	PK	74.00	11.76	1.00 H	312	59.86	31.58	7.00	36.2	2.38
1	4924.00	48.67	AV	54.00	5.33	1.00 H	312	46.29	31.58	7.00	36.2	2.38
2	7386.00	63.44	PK	74.00	10.56	1.00 H	207	51.73	38.51	8.50	35.3	11.71
2	7386.00	48.38	AV	54.00	5.62	1.00 H	207	36.67	38.51	8.50	35.3	11.71



- REMARKS:**
1. Emission level (dBuV/m)=Raw Value(dBuV)+Correction Factor(dB/m)
  2. Correction Factor (dB/m) = Antenna Factor (dB/m)+Cable Factor (dB)-Pre-amplifier Factor
  3. The other emission levels were very low against the limit.
  4. Margin value = Limit value- Emission level.
  5. For Wireless 802.11b mode at 1Mbps.

**802.11g Mode(above 1GHz)**

ANTENNA POLARITY & TEST DISTANCE: HORIZONTAL AT 3 M (802.11g--2412MHz)												
No.	Frequency (MHz)	Emission Level (dBuV/m)		Limit (dBuV/m)	Margin (dB)	Antenna Height (m)	Table Angle (Degree)	Raw Value (dBuV)	Antenna Factor (dB/m)	Cable Factor (dB)	Pre-amplifier	Correction Factor (dB/m)
1	4824.00	56.78	PK	74.00	17.22	1.00 H	30	54.68	31.6	7.00	36.5	2.10
1	4824.00	48.88	AV	54.00	5.12	1.00 H	30	46.78	31.6	7.00	36.5	2.10
2	7236.00	61.35	PK	74.00	12.65	1.00 H	242	50.42	37.33	8.90	35.3	10.93
2	7236.00	48.57	AV	54.00	5.43	1.00 H	242	37.64	37.33	8.90	35.3	10.93

ANTENNA POLARITY & TEST DISTANCE: VERTICAL AT 3 M (802.11g--2412MHz)												
No.	Frequency (MHz)	Emission Level (dBuV/m)		Limit (dBuV/m)	Margin (dB)	Antenna Height (m)	Table Angle (Degree)	Raw Value (dBuV)	Antenna Factor (dB/m)	Cable Factor (dB)	Pre-amplifier	Correction Factor (dB/m)
1	4824.00	62.77	PK	74.00	11.23	1.00 H	49	60.67	31.60	7.00	36.5	2.10
1	4824.00	48.88	AV	54.00	5.12	1.00 H	49	46.78	31.60	7.00	36.5	2.10
2	7236.00	60.53	PK	74.00	13.47	1.00 H	290	49.6	37.33	8.90	35.3	10.93
2	7236.00	47.79	AV	54.00	6.21	1.00 H	290	36.86	37.33	8.90	35.3	10.93

ANTENNA POLARITY & TEST DISTANCE: HORIZONTAL AT 3 M (802.11g--2437MHz)												
No.	Frequency (MHz)	Emission Level (dBuV/m)		Limit (dBuV/m)	Margin (dB)	Antenna Height (m)	Table Angle (Degree)	Raw Value (dBuV)	Antenna Factor (dB/m)	Cable Factor (dB)	Pre-amplifier	Correction Factor (dB/m)
1	4874.00	62.04	PK	74.00	11.96	1.00 H	110	59.92	31.02	7.60	36.5	2.12
1	4874.00	48.71	AV	54.00	5.29	1.00 H	110	46.59	31.02	7.60	36.5	2.12
2	7311.00	59.78	PK	74.00	14.22	1.00 H	57	48.70	37.28	8.60	34.8	11.08
2	7311.00	47.65	AV	54.00	6.35	1.00 H	57	36.57	37.28	8.60	34.8	11.08

ANTENNA POLARITY & TEST DISTANCE: VERTICAL AT 3 M (802.11g--2437MHz)												
No.	Frequency (MHz)	Emission Level (dBuV/m)		Limit (dBuV/m)	Margin (dB)	Antenna Height (m)	Table Angle (Degree)	Raw Value (dBuV)	Antenna Factor (dB/m)	Cable Factor (dB)	Pre-amplifier	Correction Factor (dB/m)
1	4874.00	63.11	PK	74.00	10.89	1.00 H	135	60.99	31.02	7.60	36.5	2.12
1	4874.00	49.08	AV	54.00	4.92	1.00 H	135	46.96	31.02	7.60	36.5	2.12
2	7311.00	61.8	PK	74.00	12.20	1.00 H	279	50.72	37.28	8.60	34.8	11.08
2	7311.00	47.06	AV	54.00	6.94	1.00 H	279	35.98	37.28	8.60	34.8	11.08

ANTENNA POLARITY & TEST DISTANCE: HORIZONTAL AT 3 M (802.11g--2462MHz)												
No.	Frequency (MHz)	Emission Level (dBuV/m)		Limit (dBuV/m)	Margin (dB)	Antenna Height (m)	Table Angle (Degree)	Raw Value (dBuV)	Antenna Factor (dB/m)	Cable Factor (dB)	Pre-amplifier	Correction Factor (dB/m)
1	4924.00	59.29	PK	74.00	14.71	1.00 H	324	56.91	31.58	7.00	36.2	2.38
1	4924.00	47.15	AV	54.00	6.85	1.00 H	324	44.77	31.58	7.00	36.2	2.38
2	7311.00	61.78	PK	74.00	12.22	1.00 H	216	50.07	38.51	8.50	35.3	11.71
2	7311.00	48.49	AV	54.00	5.51	1.00 H	216	36.78	38.51	8.50	35.3	11.71

**ANTENNA POLARITY & TEST DISTANCE: VERTICAL AT 3 M (802.11g--2462MHz)**

No.	Frequency (MHz)	Emission Level (dBuV/m)		Limit (dBuV/m)	Margin (dB)	Antenna Height (m)	Table Angle (Degree)	Raw Value (dBuV)	Antenna Factor (dB/m)	Cable Factor (dB)	Pre-amplifier	Correction Factor (dB/m)
1	4924.00	61.02	PK	74.00	12.98	1.00 H	149	58.64	31.58	7.00	36.2	2.38
1	4924.00	48.06	AV	54.00	5.94	1.00 H	149	45.68	31.58	7.00	36.2	2.38
2	7386.00	63.38	PK	74.00	10.62	1.00 H	21	51.67	38.51	8.50	35.3	11.71
2	7386.00	48.39	AV	54.00	5.61	1.00 H	21	36.68	38.51	8.50	35.3	11.71

- REMARKS:**
1. Emission level (dBuV/m) = Raw Value (dBuV) + Correction Factor (dB/m)
  2. Correction Factor (dB/m) = Antenna Factor (dB/m) + Cable Factor (dB) - Pre-amplifier Factor
  3. The other emission levels were very low against the limit.
  4. Margin value = Limit value - Emission level.
  5. For Wireless 802.11g mode at 6Mbps.

**802.11n(20MHz) Mode(above 1GHz)****ANTENNA POLARITY & TEST DISTANCE: HORIZONTAL AT 3 M (802.11n20--2412MHz)**

No.	Frequency (MHz)	Emission Level (dBuV/m)		Limit (dBuV/m)	Margin (dB)	Antenna Height (m)	Table Angle (Degree)	Raw Value (dBuV)	Antenna Factor (dB/m)	Cable Factor (dB)	Pre-amplifier	Correction Factor (dB/m)
1	4824.00	63.24	PK	74.00	10.76	1.00 H	70	61.14	31.60	7.00	36.5	2.10
1	4824.00	47.88	AV	54.00	6.12	1.00 H	70	45.78	31.60	7.00	36.5	2.10
2	7236.00	61.6	PK	74.00	12.40	1.00 H	125	50.67	37.33	8.90	35.3	10.93
2	7236.00	47.91	AV	54.00	6.09	1.00 H	125	36.98	37.33	8.90	35.3	10.93

**ANTENNA POLARITY & TEST DISTANCE: VERTICAL AT 3 M (802.11n20--2412MHz)**

No.	Frequency (MHz)	Emission Level (dBuV/m)		Limit (dBuV/m)	Margin (dB)	Antenna Height (m)	Table Angle (Degree)	Raw Value (dBuV)	Antenna Factor (dB/m)	Cable Factor (dB)	Pre-amplifier	Correction Factor (dB/m)
1	4824.00	63.10	PK	74.00	10.90	1.00 H	49	61.00	31.60	7.00	36.5	2.10
1	4824.00	48.67	AV	54.00	5.33	1.00 H	49	46.57	31.60	7.00	36.5	2.10
2	7236.00	62.71	PK	74.00	11.29	1.00 H	105	51.78	37.33	8.90	35.3	10.93
2	7236.00	49.05	AV	54.00	4.95	1.00 H	105	38.12	37.33	8.90	35.3	10.93

**ANTENNA POLARITY & TEST DISTANCE: HORIZONTAL AT 3 M (802.11n20--2437MHz)**

No.	Frequency (MHz)	Emission Level (dBuV/m)		Limit (dBuV/m)	Margin (dB)	Antenna Height (m)	Table Angle (Degree)	Raw Value (dBuV)	Antenna Factor (dB/m)	Cable Factor (dB)	Pre-amplifier	Correction Factor (dB/m)
1	4874.00	59.18	PK	74.00	14.82	1.00 H	216	57.06	31.02	7.60	36.5	2.12
1	4874.00	48.80	AV	54.00	5.20	1.00 H	216	46.68	31.02	7.60	36.5	2.12
2	7311.00	61.87	PK	74.00	12.13	1.00 H	109	50.79	37.28	8.60	34.8	11.08
2	7311.00	48.81	AV	54.00	5.19	1.00 H	109	37.73	37.28	8.60	34.8	11.08

**ANTENNA POLARITY & TEST DISTANCE: VERTICAL AT 3 M (802.11n20--2437MHz)**

No.	Frequency (MHz)	Emission Level (dBuV/m)		Limit (dBuV/m)	Margin (dB)	Antenna Height (m)	Table Angle (Degree)	Raw Value (dBuV)	Antenna Factor (dB/m)	Cable Factor (dB)	Pre-amplifier	Correction Factor (dB/m)
1	4874.00	59.80	PK	74.00	14.20	1.00 H	240	57.68	31.02	7.60	36.5	2.12
1	4874.00	48.91	AV	54.00	5.09	1.00 H	240	46.79	31.02	7.60	36.5	2.12
2	7311.00	61.14	PK	74.00	12.86	1.00 H	201	50.06	37.28	8.60	34.8	11.08
2	7311.00	49.17	AV	54.00	4.83	1.00 H	201	38.09	37.28	8.60	34.8	11.08

**ANTENNA POLARITY & TEST DISTANCE: HORIZONTAL AT 3 M (802.11n20--2462MHz)**

No.	Frequency (MHz)	Emission Level (dBuV/m)		Limit (dBuV/m)	Margin (dB)	Antenna Height (m)	Table Angle (Degree)	Raw Value (dBuV)	Antenna Factor (dB/m)	Cable Factor (dB)	Pre-amplifier	Correction Factor (dB/m)
1	4924.00	58.25	PK	74.00	15.75	1.00 H	129	55.87	31.58	7.00	36.2	2.38
1	4924.00	45.36	AV	54.00	8.64	1.00 H	129	42.98	31.58	7.00	36.2	2.38
2	7386.00	60.39	PK	74.00	13.61	1.00 H	221	48.68	38.51	8.50	35.3	11.71
2	7386.00	48.51	AV	54.00	5.49	1.00 H	221	36.80	38.51	8.50	35.3	11.71

**ANTENNA POLARITY & TEST DISTANCE: VERTICAL AT 3 M (802.11n20--2462MHz)**

No.	Frequency (MHz)	Emission Level (dBuV/m)		Limit (dBuV/m)	Margin (dB)	Antenna Height (m)	Table Angle (Degree)	Raw Value (dBuV)	Antenna Factor (dB/m)	Cable Factor (dB)	Pre-amplifier	Correction Factor (dB/m)
1	4924.00	59.19	PK	74.00	14.81	1.00 H	146	56.81	31.58	7.00	36.2	2.38
1	4924.00	48.06	AV	54.00	5.94	1.00 H	146	45.68	31.58	7.00	36.2	2.38
2	7386.00	61.41	PK	74.00	12.59	1.00 H	258	49.70	38.51	8.50	35.3	11.71
2	7386.00	48.47	AV	54.00	5.53	1.00 H	258	36.76	38.51	8.50	35.3	11.71

- REMARKS:**
1. Emission level (dBuV/m) = Raw Value (dBuV) + Correction Factor (dB/m)
  2. Correction Factor (dB/m) = Antenna Factor (dB/m) + Cable Factor (dB) - Pre-amplifier Factor
  3. The other emission levels were very low against the limit.
  4. Margin value = Limit value - Emission level.
  5. For Wireless 802.11n (20MHz) mode at 6.5Mbps.

**802.11n(40MHz) Mode(above 1GHz)****ANTENNA POLARITY & TEST DISTANCE: HORIZONTAL AT 3 M (802.11n40--2422MHz)**

No.	Frequency (MHz)	Emission Level (dBuV/m)		Limit (dBuV/m)	Margin (dB)	Antenna Height (m)	Table Angle (Degree)	Raw Value (dBuV)	Antenna Factor (dB/m)	Cable Factor (dB)	Pre-amplifier	Correction Factor (dB/m)
1	4844.00	61.38	PK	74.00	12.62	1.00 H	48	59.27	31.01	7.30	36.2	2.11
1	4844.00	45.77	AV	54.00	8.23	1.00 H	48	43.66	31.01	7.30	36.2	2.11
2	7266.00	61.30	PK	74.00	12.70	1.00 H	157	50.50	36.70	8.90	34.8	10.80
2	7266.00	46.63	AV	54.00	7.37	1.00 H	157	35.83	36.70	8.90	34.8	10.80

**ANTENNA POLARITY & TEST DISTANCE: VERTICAL AT 3 M (802.11n40--2422MHz)**

No.	Frequency (MHz)	Emission Level (dBuV/m)		Limit (dBuV/m)	Margin (dB)	Antenna Height (m)	Table Angle (Degree)	Raw Value (dBuV)	Antenna Factor (dB/m)	Cable Factor (dB)	Pre-amplifier	Correction Factor (dB/m)
1	4844.00	59.73	PK	74.00	14.27	1.00 H	334	57.62	31.01	7.30	36.2	2.11
1	4844.00	47.11	AV	54.00	6.89	1.00 H	334	45.00	31.01	7.30	36.2	2.11
2	7266.00	62.04	PK	74.00	11.96	1.00 H	114	51.24	36.70	8.90	34.8	10.80
2	7266.00	47.03	AV	54.00	6.97	1.00 H	114	36.23	36.70	8.90	34.8	10.80

**ANTENNA POLARITY & TEST DISTANCE: HORIZONTAL AT 3 M (802.11n40--2437MHz)**

No.	Frequency (MHz)	Emission Level (dBuV/m)		Limit (dBuV/m)	Margin (dB)	Antenna Height (m)	Table Angle (Degree)	Raw Value (dBuV)	Antenna Factor (dB/m)	Cable Factor (dB)	Pre-amplifier	Correction Factor (dB/m)
1	4874.00	60.79	PK	74.00	13.21	1.00 H	229	58.67	31.02	7.60	36.5	2.12
1	4874.00	48.80	AV	54.00	5.20	1.00 H	229	46.68	31.02	7.60	36.5	2.12
2	7311.00	64.09	PK	74.00	9.91	1.00 H	147	53.01	37.28	8.60	34.8	11.08
2	7311.00	48.75	AV	54.00	5.25	1.00 H	147	37.67	37.28	8.60	34.8	11.08

ANTENNA POLARITY & TEST DISTANCE: VERTICAL AT 3 M (802.11n40--2437MHz)												
No.	Frequency (MHz)	Emission Level (dBuV/m)		Limit (dBuV/m)	Margin (dB)	Antenna Height (m)	Table Angle (Degree)	Raw Value (dBuV)	Antenna Factor (dB/m)	Cable Factor (dB)	Pre-amplifier	Correction Factor (dB/m)
1	4874.00	58.48	PK	74.00	15.52	1.00 H	307	56.36	31.02	7.60	36.5	2.12
1	4874.00	49.32	AV	54.00	4.68	1.00 H	307	47.20	31.02	7.60	36.5	2.12
2	7311.00	63.45	PK	74.00	10.55	1.00 H	159	52.37	37.28	8.60	34.8	11.08
2	7311.00	48.72	AV	54.00	5.28	1.00 H	159	37.64	37.28	8.60	34.8	11.08

ANTENNA POLARITY & TEST DISTANCE: HORIZONTAL AT 3 M (802.11n40--2452MHz)												
No.	Frequency (MHz)	Emission Level (dBuV/m)		Limit (dBuV/m)	Margin (dB)	Antenna Height (m)	Table Angle (Degree)	Raw Value (dBuV)	Antenna Factor (dB/m)	Cable Factor (dB)	Pre-amplifier	Correction Factor (dB/m)
1	4904.00	57.94	PK	74.00	16.06	1.00 H	38	55.67	31.47	7.00	36.2	2.27
1	4904.00	44.94	AV	54.00	9.06	1.00 H	38	42.67	31.47	7.00	36.2	2.27
2	7356.00	61.06	PK	74.00	12.94	1.00 H	178	49.41	38.45	8.50	35.3	11.65
2	7356.00	47.32	AV	54.00	6.68	1.00 H	178	35.67	38.45	8.50	35.3	11.65

ANTENNA POLARITY & TEST DISTANCE: VERTICAL AT 3 M (802.11n40--2452MHz)												
No.	Frequency (MHz)	Emission Level (dBuV/m)		Limit (dBuV/m)	Margin (dB)	Antenna Height (m)	Table Angle (Degree)	Raw Value (dBuV)	Antenna Factor (dB/m)	Cable Factor (dB)	Pre-amplifier	Correction Factor (dB/m)
1	4904.00	59.84	PK	74.00	14.16	1.00 H	178	57.57	31.47	7.00	36.2	2.27
1	4904.00	45.94	AV	54.00	8.06	1.00 H	178	43.67	31.47	7.00	36.2	2.27
2	7356.00	60.22	PK	74.00	13.78	1.00 H	173	48.57	38.45	8.50	35.3	11.65
2	7356.00	47.25	AV	54.00	6.75	1.00 H	173	35.6	38.45	8.50	35.3	11.65

- REMARKS:**
1. Emission level (dBuV/m) = Raw Value (dBuV) + Correction Factor (dB/m)
  2. Correction Factor (dB/m) = Antenna Factor (dB/m) + Cable Factor (dB) - Pre-amplifier Factor
  3. The other emission levels were very low against the limit.
  4. Margin value = Limit value - Emission level.
  5. For Wireless 802.11n (40MHz) mode at 13.5Mbps.

### 4.3. Maximum Peak Output Power

#### TEST CONFIGURATION

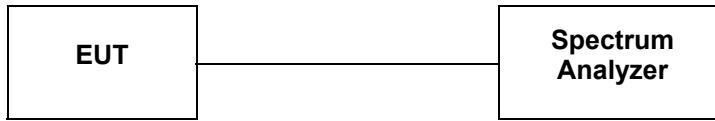

#### TEST PROCEDURE

The EUT was directly connected to the spectrum analyzer and antenna output port as show in the block diagram as TEST CONFIGURATION shows.

Accoding to KDB558074 D01 V03 Integrated band power method for this procedure may be used when the maximum available RBW of the measurement instrument is less than the DTS bandwidth.

1. Set the RBW = 1 MHz.
2. Set the VBW  $\geq$  3 RBW
3. Set the span  $\geq$  1.5 x DTS bandwidth.
4. Detector = peak.
5. Sweep time = auto couple.
6. Trace mode = max hold.
7. Allow trace to fully stabilize.
8. Use the instrument's band/channel power measurement function with the band limits set equal to the DTS bandwidth edges (for some instruments, this may require a manual override to select peak detector). If the instrument does not have a band power function, sum the spectrum levels (in linear power units) at intervals equal to the RBW extending across the DTS channel bandwidth.

#### LIMIT

The Maximum Peak Output Power Measurement is 30dBm.

#### TEST RESULTS

Remark:We measured output power at difference data rate for each mode and recorded woest case for each mode.

##### 4.3.1 802.11b Test Mode

###### A. Test Verdict

Channel	Frequency (MHz)	Measured Output Peak Power (dBm)	Refer to Plot	Limits (dBm)	Verdict
1	2412	20.05	Plot 4.3.1 A	30	PASS
6	2437	20.25	Plot 4.3.1 B	30	PASS
11	2462	20.54	Plot 4.3.1 C	30	PASS

- Note: 1. For 802.11b mode at finial test to get the worst-case emission at 1Mbps.  
2.The test results including the cable lose.

###### B. Test Plots

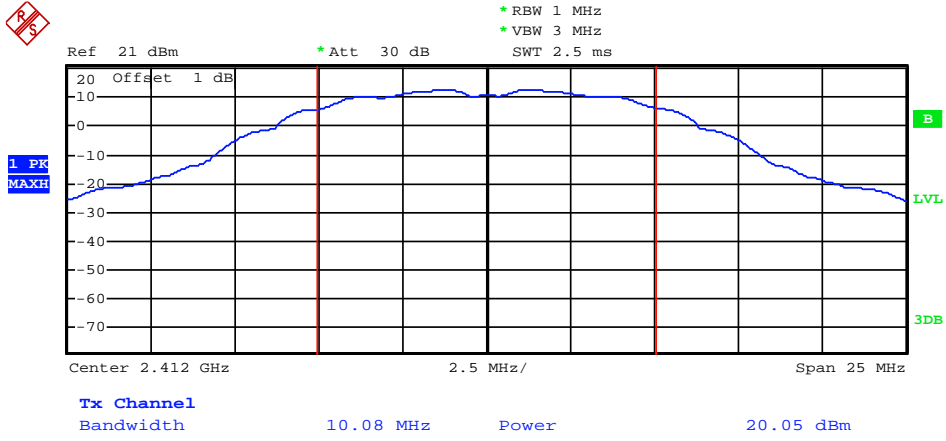

Date: 10.JAN.2014 17:38:04

(Plot 4.3.1 A: Channel 1: 2412MHz @ 802.11b)

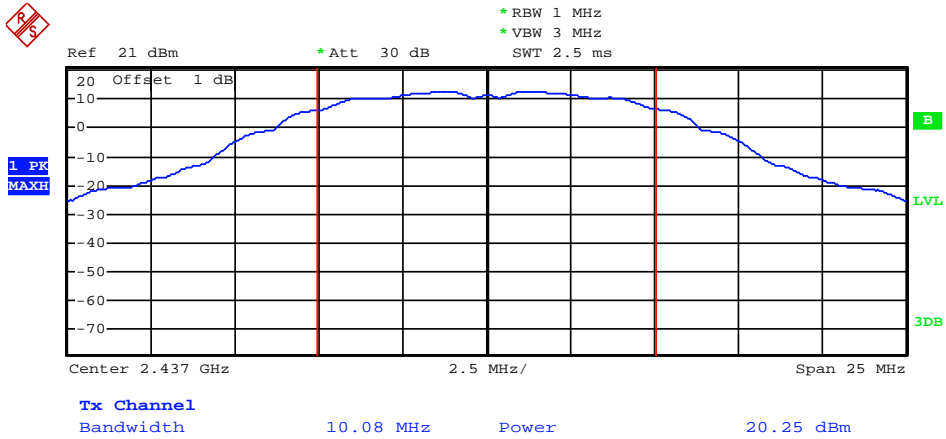

Date: 10.JAN.2014 17:38:23

(Plot 4.3.1 B: Channel 1: 2437MHz @ 802.11b)

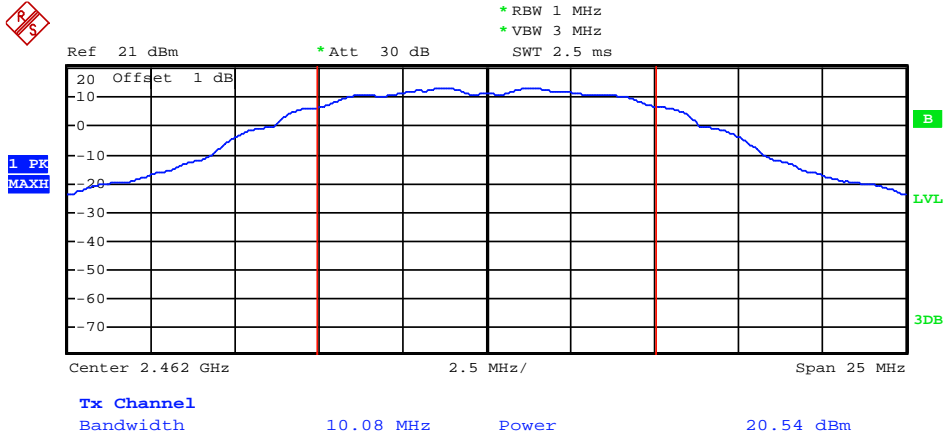

Date: 10.JAN.2014 17:38:46

(Plot 4.3.1 C: Channel 11: 2462MHz @ 802.11b)

**4.3.2 802.11g Test Mode**

**A. Test Verdict**

Channel	Frequency (MHz)	Measured Output Peak Power (dBm)	Refer to Plot	Limits (dBm)	Verdict
1	2412	21.27	Plot 4.3.2 A	30	PASS
6	2437	22.72	Plot 4.3.2 B	30	PASS
11	2462	21.53	Plot 4.3.2 C	30	PASS

Note: 1. For 802.11g mode at final test to get the worst-case emission at 6Mbps.  
 2. The test results including the cable loss.

**B. Test Plots**

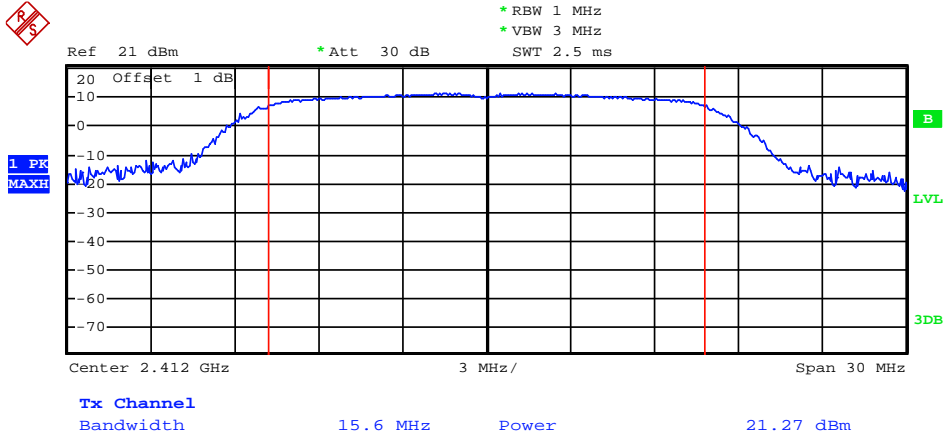

Date: 10.JAN.2014 17:39:42

(Plot 4.3.2 A: Channel 1: 2412MHz @ 802.11g)

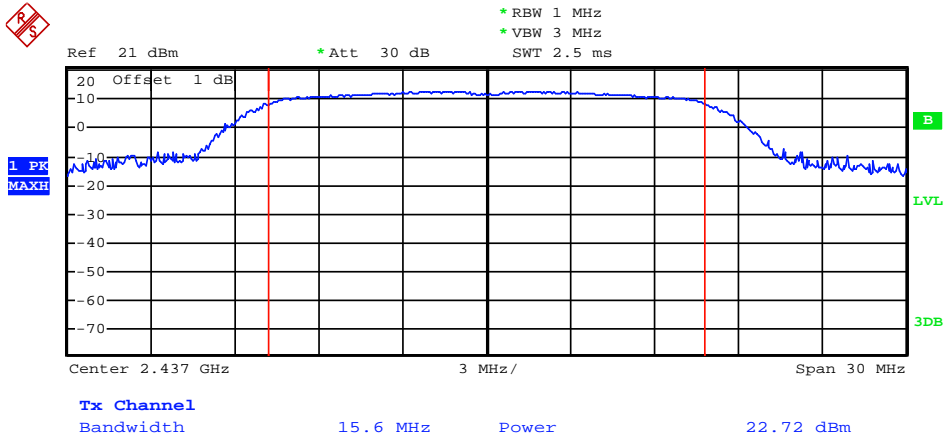

Date: 10.JAN.2014 17:40:30

(Plot 4.3.2 B: Channel 1: 2437MHz @ 802.11g)



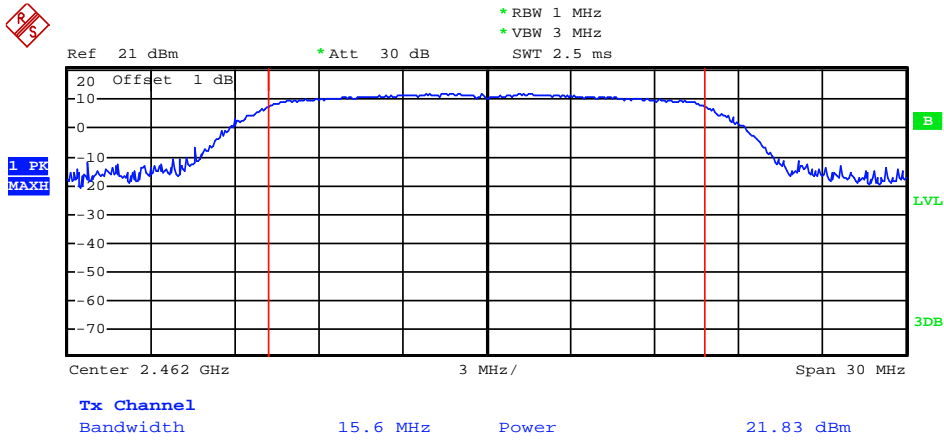

Date: 10.JAN.2014 17:41:05

(Plot 4.3.2 C: Channel 11: 2462MHz @ 802.11g)

**4.3.3 802.11n(20MHz) Test Mode**

**A. Test Verdict**

Channel	Frequency (MHz)	Measured Output Peak Power (dBm)	Refer to Plot	Limits (dBm)	Verdict
1	2412	21.29	Plot 4.3.3 A	30	PASS
6	2437	22.84	Plot 4.3.3 B	30	PASS
11	2462	22.02	Plot 4.3.3 C	30	PASS

Note: 1. For 802.11n(20MHz) mode at final test to get the worst-case emission at 6.5Mbps.  
 2. The test results including the cable lose.

**B. Test Plots**

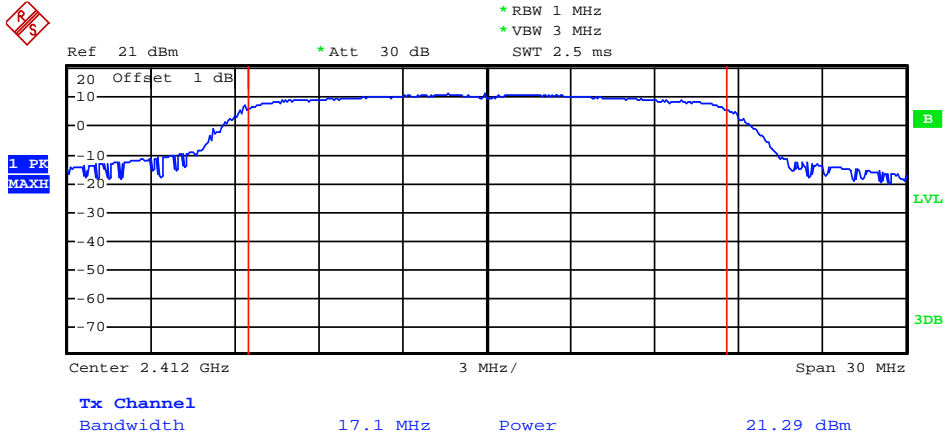

Date: 10.JAN.2014 17:42:27

(Plot 4.3.3 A: Channel 1: 2412MHz @ 802.11n(20MHz))

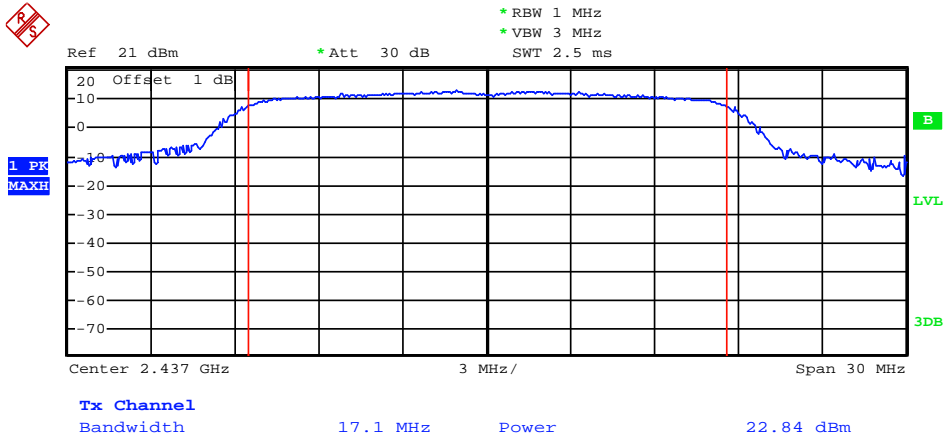

Date: 10.JAN.2014 17:42:52

(Plot 4.3.3 B: Channel 6: 2437MHz @ 802.11n(20MHz))

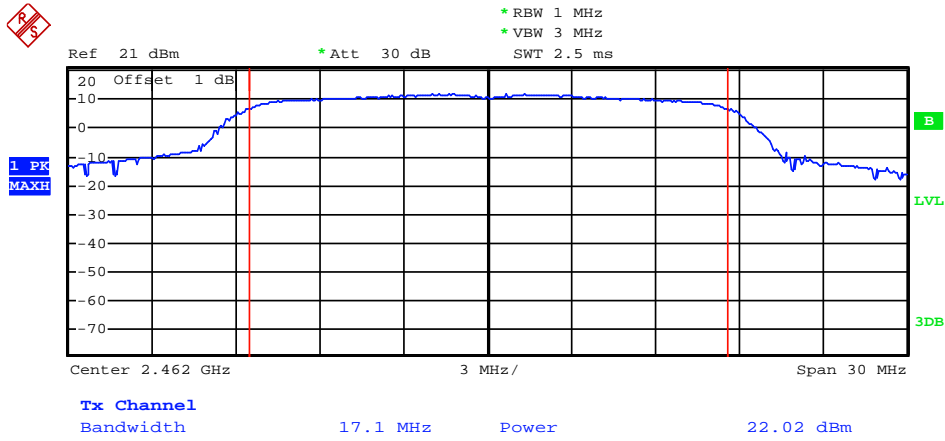

Date: 10.JAN.2014 17:43:14

(Plot 4.3.3 C: Channel 11: 2462MHz @ 802.11n(20MHz))

**4.3.4 802.11n(40MHz) Test Mode**

A. Test Verdict

Channel	Frequency (MHz)	Measured Output Peak Power (dBm)	Refer to Plot	Limits (dBm)	Verdict
3	2422	19.30	Plot 4.3.4 A	30	PASS
6	2437	21.09	Plot 4.3.4 B	30	PASS
9	2452	19.94	Plot 4.3.4 C	30	PASS

Note: 1. For 802.11n(40MHz) mode at final test to get the worst-case emission at 13.5Mbps.  
 2. The test results including the cable lose.

B. Test Plots

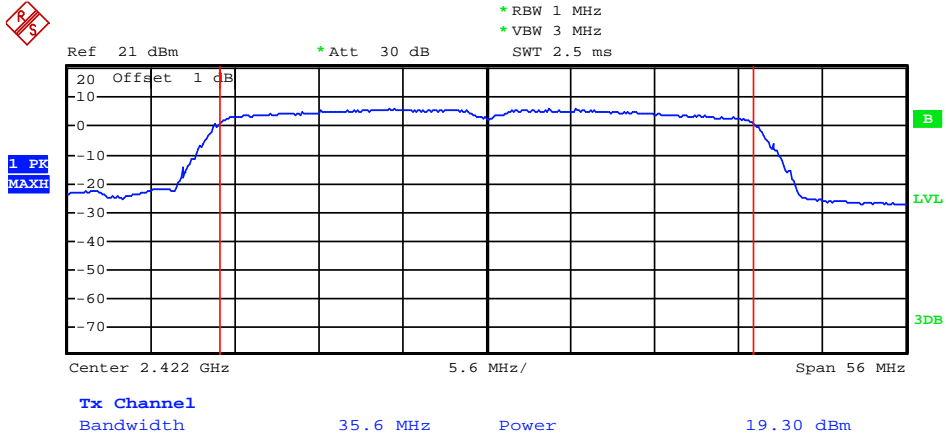

Date: 10.JAN.2014 17:44:09

(Plot 4.3.4 A: Channel 3: 2422MHz @ 802.11n(40MHz))

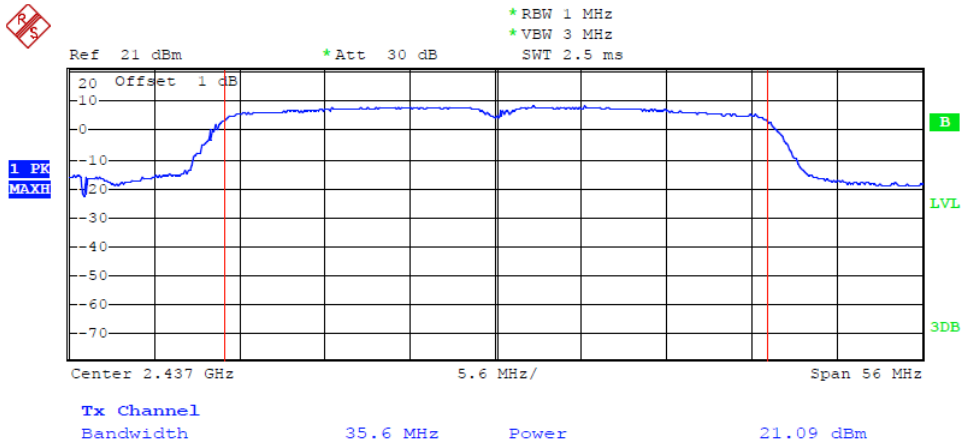

Date: 10.JAN.2014 17:45:06

(Plot 4.3.4 B: Channel 6: 2437MHz @ 802.11n(40MHz))

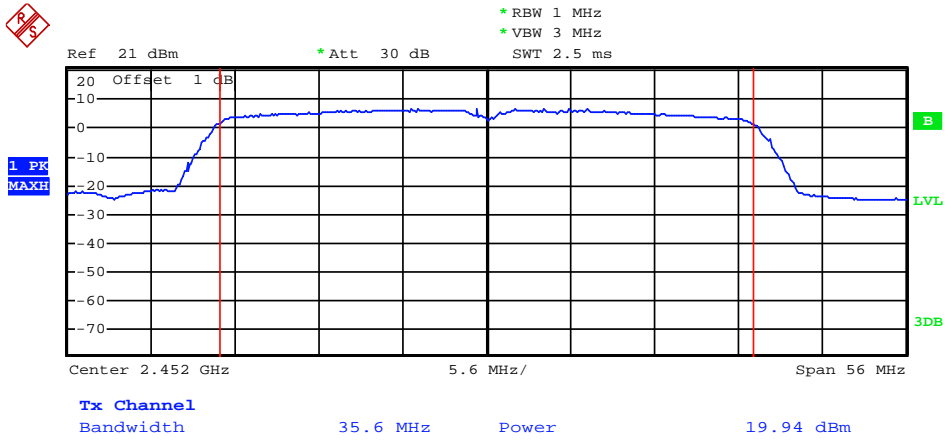

Date: 10.JAN.2014 17:45:46

(Plot 4.3.4 C: Channel 9: 2452MHz @ 802.11n(40MHz))

## 4.4. Power Spectral Density

### TEST CONFIGURATION

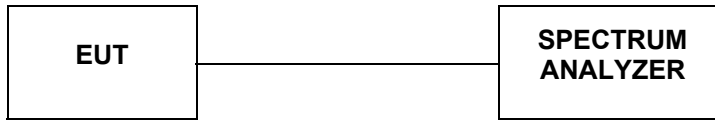

### TEST PROCEDURE

According to KDB 558074 D01 V03 Method PKPSD (peak PSD) This procedure shall be used if maximum peak conducted output power was used to demonstrate compliance, and is optional if the maximum conducted (average) output power was used to demonstrate compliance.

1. Set analyzer center frequency to DTS channel center frequency.
2. Set the span to 1.5 times the DTS bandwidth.
3. Set the RBW to:  $3 \text{ kHz} \leq \text{RBW} \leq 100 \text{ kHz}$ .
4. Set the VBW  $\geq 3 \text{ RBW}$ .
5. Detector = peak.
6. Sweep time = auto couple.
7. Trace mode = max hold.
8. Allow trace to fully stabilize.
9. Use the peak marker function to determine the maximum amplitude level within the RBW.
10. If measured value exceeds limit, reduce RBW (no less than 3 kHz) and repeat.

### LIMIT

For digitally modulated systems, the power spectral density conducted from the intentional radiator to the antenna shall not be greater than 8 dBm in any 3 kHz band during any time interval of continuous transmission.

### TEST RESULTS

#### 4.4.1 802.11b Test Mode

##### A. Test Verdict

Channel	Frequency (MHz)	Report PSD (dBm/3kHz)	Refer to Plot	Limits (dBm/3KHz)	Verdict
1	2412	-5.20	Plot 4.4.1 A	8	PASS
6	2437	-6.85	Plot 4.4.1 B	8	PASS
11	2462	-6.15	Plot 4.4.1 C	8	PASS

Note: 1. For 802.11b mode at final test to get the worst-case emission at 1Mbps.  
2. The test results including the cable loss.

##### B. Test Plots



\*RBW 3 kHz      Marker 1 [T1 ]  
\*VBW 10 kHz      -5.20 dBm  
SWT 1.7 s      2.412816480 GHz

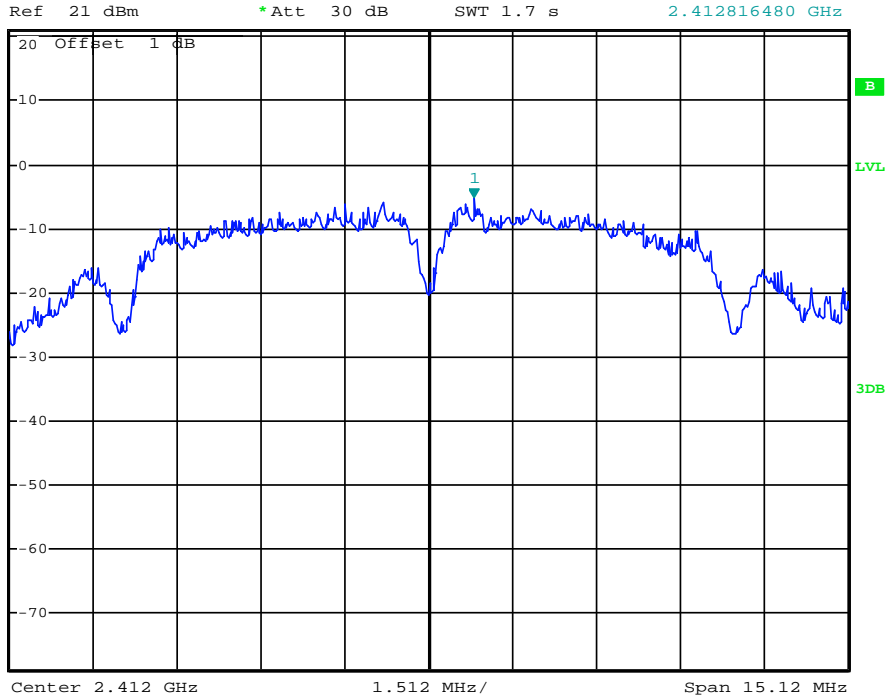

Date: 10.JAN.2014 17:48:03

(Plot 4.4.1 A: Channel 1: 2412MHz @ 802.11b)



\*RBW 3 kHz      Marker 1 [T1 ]  
\*VBW 10 kHz      -6.85 dBm  
SWT 1.7 s      2.435336800 GHz

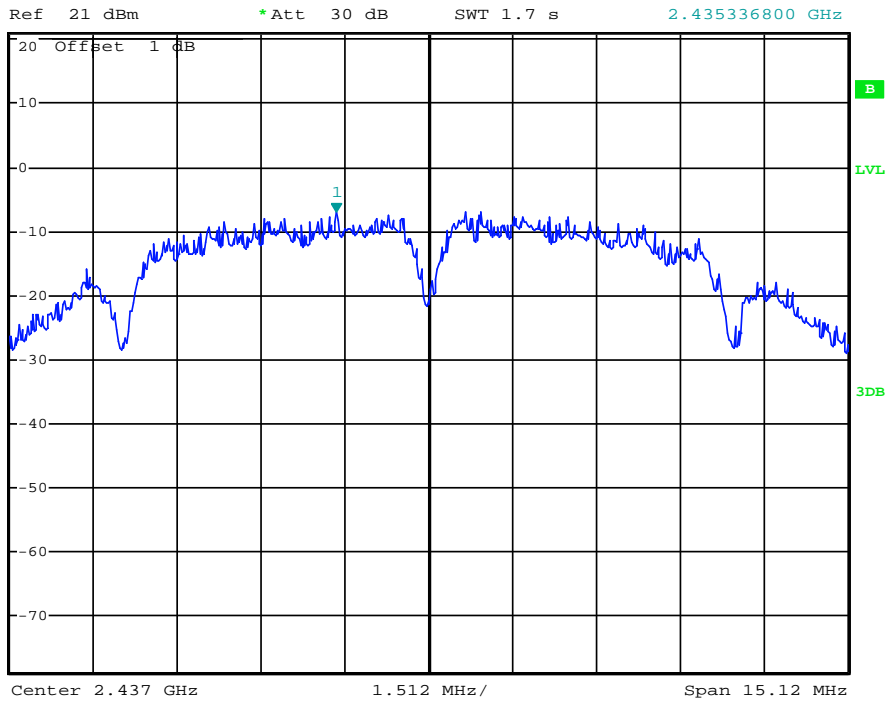

Date: 10.JAN.2014 17:48:27

(Plot 4.4.1 B: Channel 6: 2437MHz @ 802.11b)



\*RBW 3 kHz      Marker 1 [T1 ]  
 \*VBW 10 kHz      -6.15 dBm  
 SWT 1.7 s      2.460155360 GHz

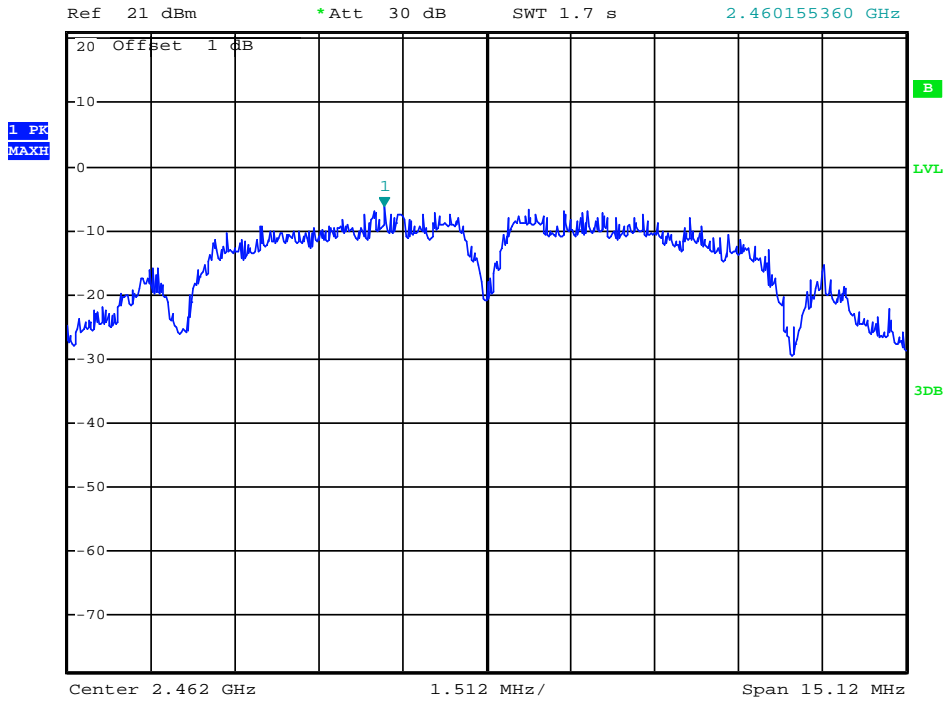

Date: 10.JAN.2014 17:48:51

(Plot 4.4.1 C: Channel 11: 2462MHz @ 802.11b)

**4.4.2 802.11g Test Mode**

**A. Test Verdict**

Channel	Frequency (MHz)	Report PSD (dBm/3kHz)	Refer to Plot	Limits (dBm/3KHz)	Verdict
1	2412	-12.84	Plot 4.4.2 A	8	PASS
6	2437	-11.42	Plot 4.4.2 B	8	PASS
11	2462	-12.09	Plot 4.4.2 C	8	PASS

Note: 1. For 802.11g mode at final test to get the worst-case emission at 6Mbps.  
 2. The test results including the cable lose.

**B. Test Plots**





Ref 21 dBm      \*Att 30 dB      \*RBW 3 kHz      Marker 1 [T1 ]  
\*VBW 10 kHz      -12.84 dBm  
SWT 2.6 s      2.411344800 GHz

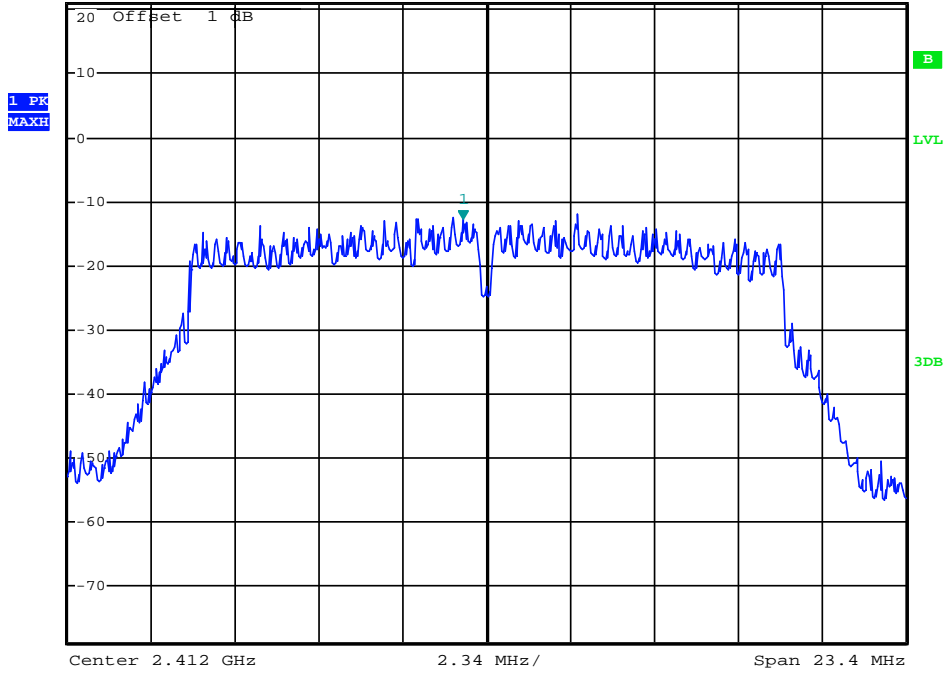

Date: 10.JAN.2014 17:49:51

(Plot 4.4.2 A: Channel 1: 2412MHz @ 802.11g)



Ref 21 dBm      \*Att 30 dB      \*RBW 3 kHz      Marker 1 [T1 ]  
\*VBW 10 kHz      -11.42 dBm  
SWT 2.6 s      2.438310400 GHz

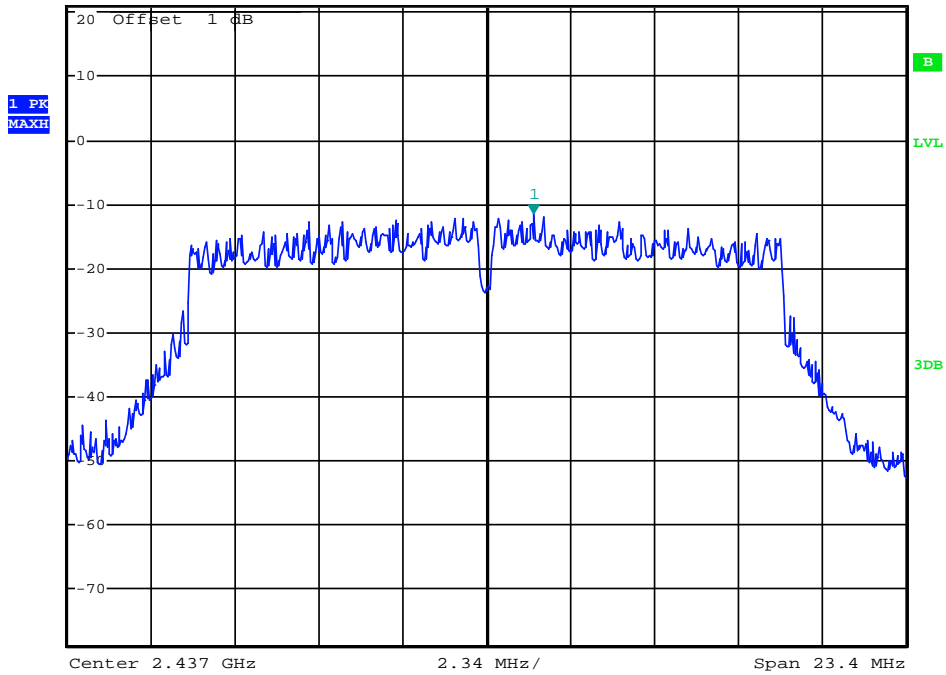

Date: 10.JAN.2014 17:50:13

(Plot 4.4.2 B: Channel 6: 2437MHz @ 802.11g)



\*RBW 3 kHz      Marker 1 [T1 ]  
 \*VBW 10 kHz      -12.09 dBm  
 SWI 2.6 s      2.462889200 GHz

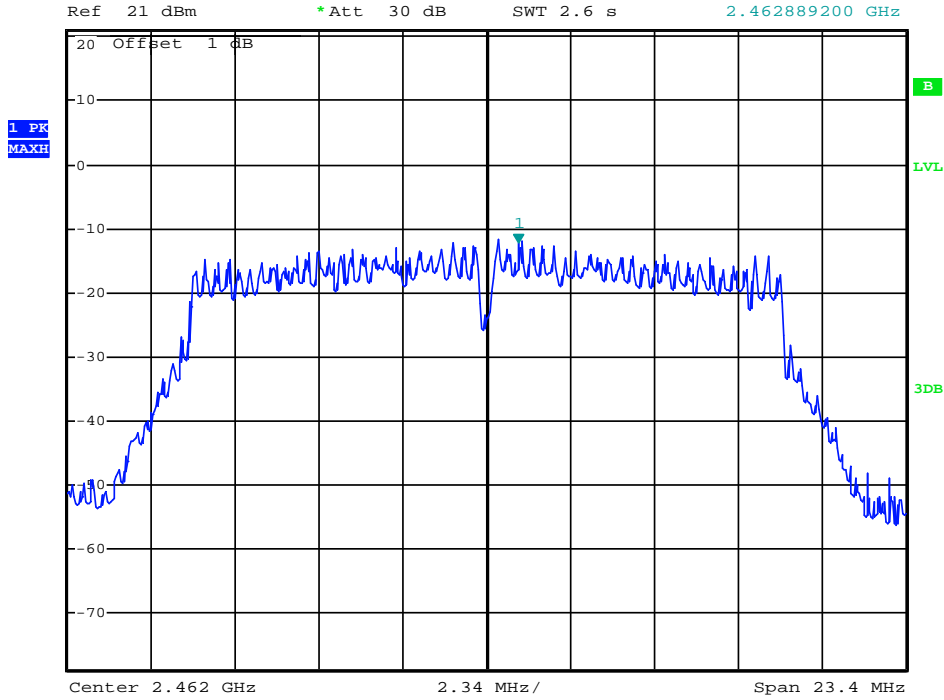

Date: 10.JAN.2014 17:50:31

(Plot 4.4.2 C: Channel 11: 2462MHz @ 802.11g)

**4.4.3 802.11n(20MHz) Test Mode**

**A. Test Verdict**

Channel	Frequency (MHz)	Report PSD (dBm/3kHz)	Refer to Plot	Limits (dBm/3KHz)	Verdict
1	2412	-11.50	Plot 4.4.3 A	8	PASS
6	2437	-10.59	Plot 4.4.3 B	8	PASS
11	2462	-12.28	Plot 4.4.3 C	8	PASS

Note: 1. For 802.11n(20MHz) mode at final test to get the worst-case emission at 6.5Mbps.  
 2.The test results including the cable lose.

**B. Test Plots**



Ref 21 dBm      \*Att 30 dB      \*RBW 3 kHz      Marker 1 [T1]      -11.50 dBm  
\*VBW 10 kHz      SWT 2.9 s      2.412615600 GHz

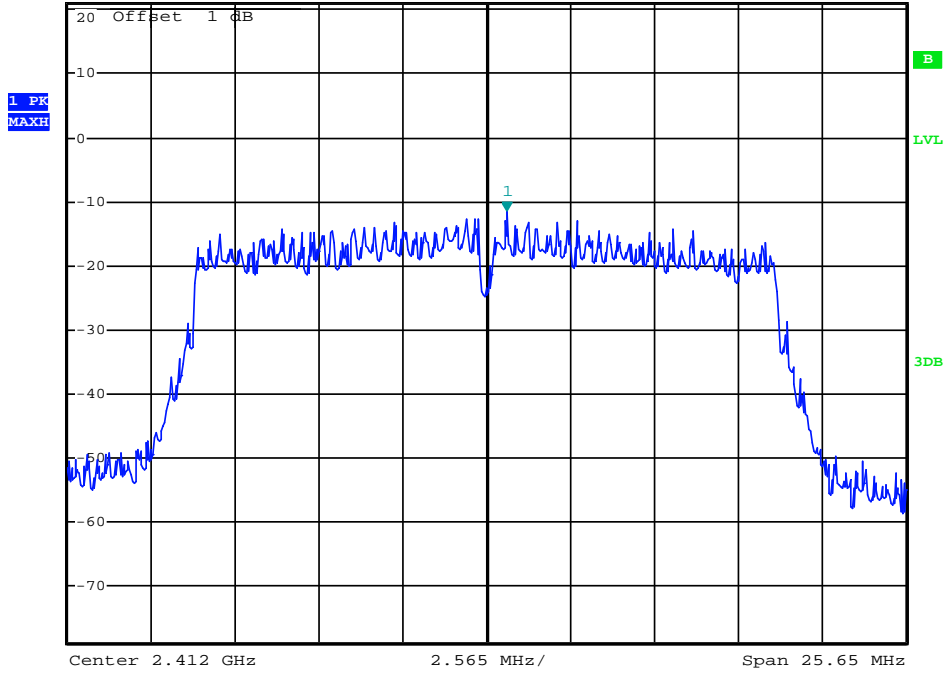

Date: 10.JAN.2014 17:51:27

(Plot 4.4.3 A: Channel 1: 2412MHz @ 802.11n(20MHz))



Ref 21 dBm      \*Att 30 dB      \*RBW 3 kHz      Marker 1 [T1]      -10.59 dBm  
\*VBW 10 kHz      SWT 2.9 s      2.437307800 GHz

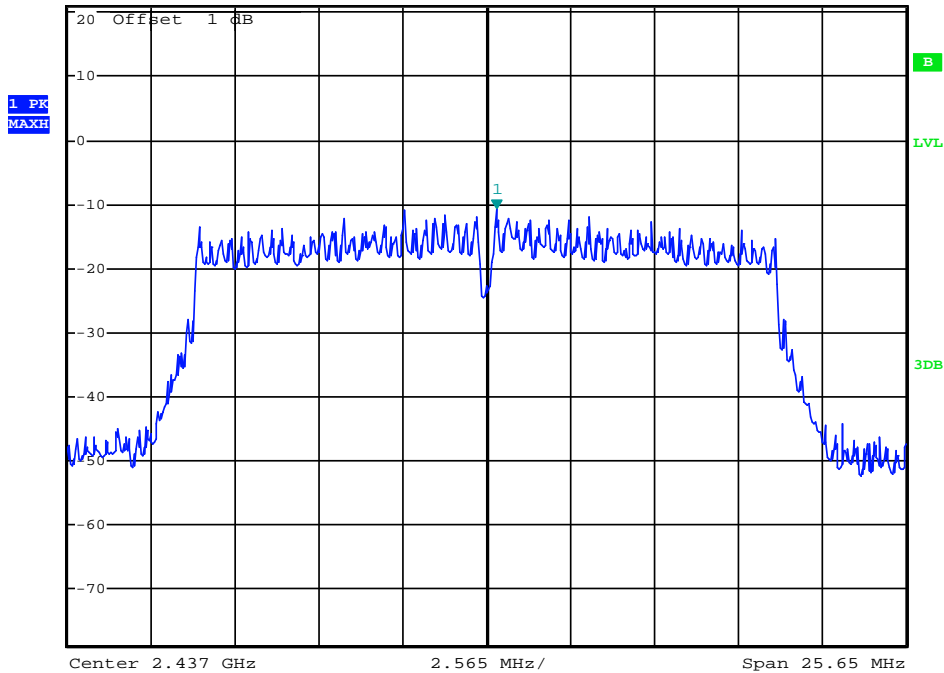

Date: 10.JAN.2014 17:51:47

(Plot 4.4.3 B: Channel 6: 2437MHz @ 802.11n(20MHz))



\*RBW 3 kHz      Marker 1 [T1 ]  
 \*VBW 10 kHz      -12.28 dBm  
 SWI 2.9 s      2.461384400 GHz

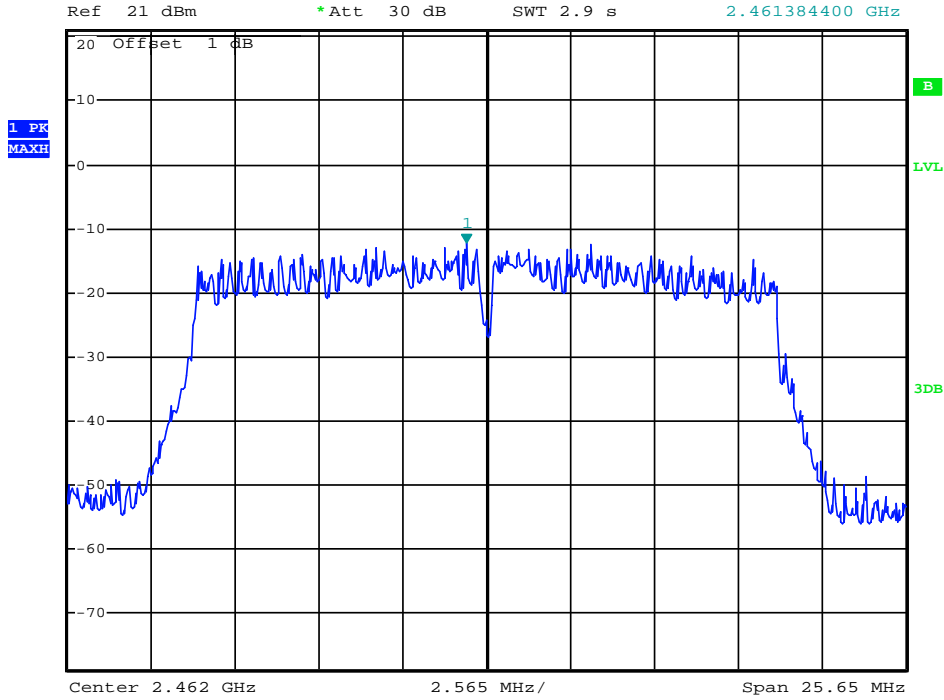

Date: 10.JAN.2014 17:52:06

(Plot 4.4.3 C: Channel 11: 2462MHz @ 802.11n(20MHz))

**4.4.4 802.11n(40MHz) Test Mode**

**A. Test Verdict**

Channel	Frequency (MHz)	Report PSD (dBm/3kHz)	Refer to Plot	Limits (dBm/3KHz)	Verdict
3	2422	-17.65	Plot 4.4.4 A	8	PASS
6	2437	-15.79	Plot 4.4.4 B	8	PASS
9	2452	-17.69	Plot 4.4.4 C	8	PASS

Note: 1. For 802.11n(40MHz) mode at final test to get the worst-case emission at 13.5Mbps.  
 2.The test results including the cable lose.

**B. Test Plots**



Ref 21 dBm      \*Att 30 dB      \*RBW 3 kHz      Marker 1 [T1 ]  
\*VBW 10 kHz      -17.65 dBm  
SWT 6 s      2.420184400 GHz

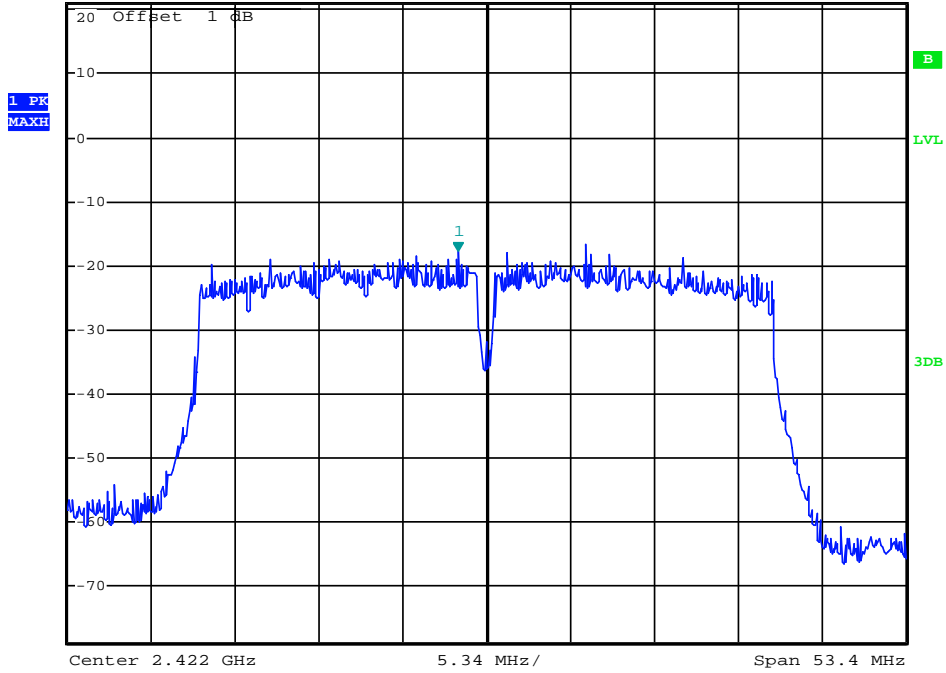

Date: 10.JAN.2014 17:53:07

(Plot 4.4.4 A: Channel 3: 2422MHz @ 802.11n(40MHz))



Ref 21 dBm      \*Att 30 dB      \*RBW 3 kHz      Marker 1 [T1 ]  
\*VBW 10 kHz      -15.79 dBm  
SWT 6 s      2.444582800 GHz

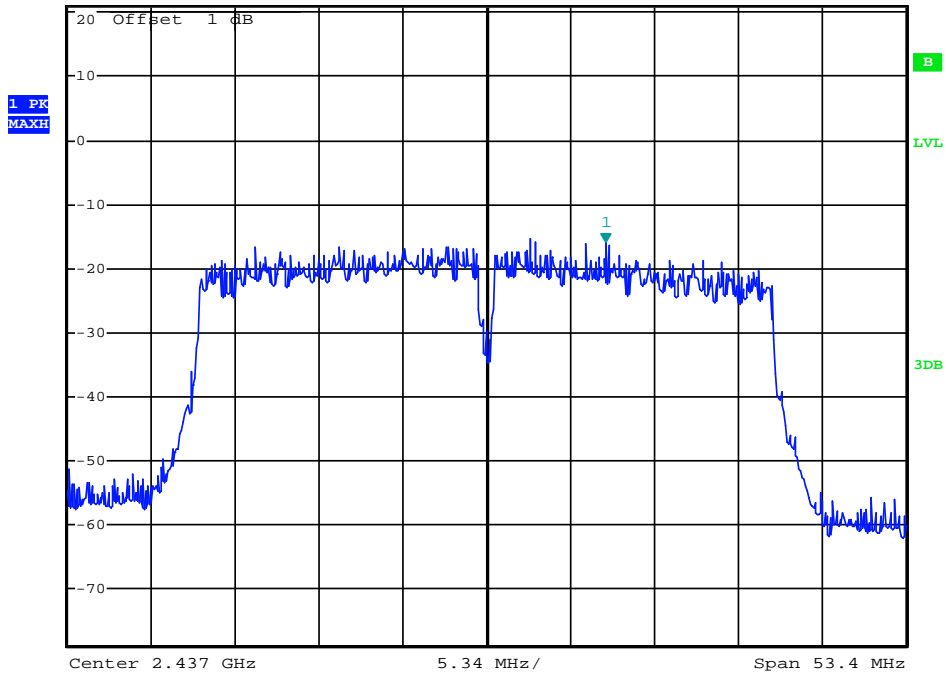

Date: 10.JAN.2014 17:53:28

(Plot 4.4.4 B: Channel 6: 2437MHz @ 802.11n(40MHz))



\*RBW 3 kHz      Marker 1 [T1 ]  
\*VBW 10 kHz      -17.69 dBm  
SWT 6 s            2.463534400 GHz

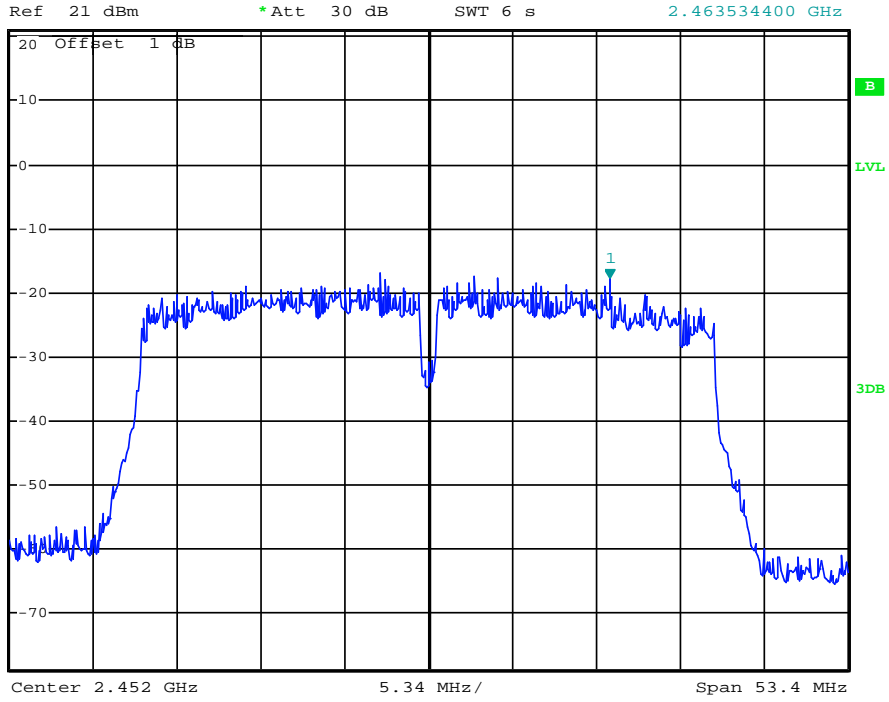

Date: 10.JAN.2014 17:53:54

(Plot 4.4.4 C: Channel 6: 2452MHz @ 802.11n(40MHz))

## 4.5. Band Edge Compliance of RF Emission

### TEST REQUIREMENT

In any 100 kHz bandwidth outside the frequency band in which the spread spectrum or digitally modulated intentional radiator is operating, the radio frequency power that is produced by the intentional radiator shall be at least 20 dB below that in the 100 kHz bandwidth within the band that contains the highest level of the desired power, based on either an RF conducted or a radiated measurement, provided the transmitter demonstrates compliance with the peak conducted power limits. If the transmitter complies with the conducted power limits based on the use of RMS averaging over a time interval, as permitted under paragraph (b)(3) of this section, the attenuation required under this paragraph shall be 30 dB instead of 20 dB. Attenuation below the general limits specified in §15.209(a) is not required. In addition, radiated emissions which fall in the restricted bands, as defined in §15.205(a), must also comply with the radiated emission limits specified in §15.209(a) (see §15.205(c)).

### TEST PROCEDURE

According to KDB 558074 D01 V03 for Antenna-port conducted measurement. Antenna-port conducted measurements may also be used as an alternative to radiated measurements for demonstrating compliance in the restricted frequency bands. If conducted measurements are performed, then proper impedance matching must be ensured and an additional radiated test for cabinet/case spurious emissions is required.

1. Check the calibration of the measuring instrument using either an internal calibrator or a known signal from an external generator.
2. Remove the antenna from the EUT and then connect to a low loss RF cable from the antenna port to a EMI test receiver, then turn on the EUT and make it operate in transmitting mode. Then set it to Low Channel and High Channel within its operating range, and make sure the instrument is operated in its linear range.
3. Set both RBW and VBW of spectrum analyzer to 100 kHz with a convenient frequency span including 100kHz bandwidth from band edge, for Radiated emissions restricted band RBW=1MHz, VBW=3MHz for peak detector and RBW=1MHz, VBW=10Hz for average detector.
4. Measure the highest amplitude appearing on spectral display and set it as a reference level. Plot the graph with marking the highest point and edge frequency.
5. Repeat above procedures until all measured frequencies were complete.
6. Measure the conducted output power (in dBm) using the detector specified by the appropriate regulatory agency (see 12.2.2, 12.2.3, and 12.2.4 for guidance regarding measurement procedures for determining quasi-peak, peak, and average conducted output power, respectively).
7. Add the maximum transmit antenna gain (in dBi) to the measured output power level to determine the EIRP level (see 12.2.5 for guidance on determining the applicable antenna gain)
8. Add the appropriate maximum ground reflection factor to the EIRP level (6 dB for frequencies  $\leq 30$  MHz, 4.7 dB for frequencies between 30 MHz and 1000 MHz, inclusive and 0 dB for frequencies  $> 1000$  MHz).
9. For devices with multiple antenna-ports, measure the power of each individual chain and sum the EIRP of all chains in linear terms (e.g., Watts, mW).
10. Convert the resultant EIRP level to an equivalent electric field strength using the following relationship:  
$$E = \text{EIRP} - 20\log D + 104.8$$

where:

E = electric field strength in dB $\mu$ V/m,

EIRP = equivalent isotropic radiated power in dBm

D = specified measurement distance in meters.

11. Since the out-of-band characteristics of the EUT transmit antenna will often be unknown, the use of a conservative antenna gain value is necessary. Thus, when determining the EIRP based on the measured conducted power, the upper bound on antenna gain for a device with a single RF output shall be selected as the maximum in-band gain of the antenna across all operating bands, or 2 dBi, whichever is greater. However, for devices that operate in multiple frequency bands while using the same transmit antenna, the highest gain of the antenna within the operating band nearest in frequency to the restricted band emission being measured may be used in lieu of the overall highest gain when the emission is at a frequency that is within 20 percent of the nearest band edge frequency, but in no case shall a value less than 2 dBi be used.
12. Compare the resultant electric field strength level to the applicable regulatory limit.
13. Perform radiated spurious emission test dures until all measured frequencies were complete.

### LIMIT

Below -20dB of the highest emission level in operating band.

Radiated emissions which fall in the restricted bands, as defined in § 15.205(a), must also comply with the radiated emission limits specified in § 15.209(a).

**TEST RESULTS**

Remark: The Bandedge was measured at difference data rate for each mode and recorded worst case for each mode.

**4.5.1 802.11b Test Mode**

A. Test Verdict

Frequency (MHz)	Conducted Power (dBm)	Antenna Gain (dBi)	Ground Reflection Factor (dB)	Covert Radiated E Level At 3m (dBuV/m)	Detector	Limit (dBuV/m)	Refer to Plot
2390.00	-40.64	2.00	0.00	56.92	Peak	74.00	Plot 4.5.1 A1
2390.00	-51.77	2.00	0.00	45.79	AV	54.00	Plot 4.5.1 A2
2410.80	12.76	2.00	0.00	110.32	Peak	---	Plot 4.5.1 A1
2410.80	6.32	2.00	0.00	103.88	AV	---	Plot 4.5.1 A2
2461.30	12.10	2.00	0.00	109.66	Peak	---	Plot 4.5.1 A3
2461.25	7.36	2.00	0.00	104.92	AV	---	Plot 4.5.1 A4
2483.50	-40.34	2.00	0.00	57.22	Peak	74.00	Plot 4.5.1 A3
2483.50	-46.43	2.00	0.00	51.13	AV	54.00	Plot 4.5.1 A4

- Note: 1. For 802.11b mode at final test to get the worst-case emission at 1Mbps.  
 2. The test results including the cable lose.  
 3. "----" means that the fundamental frequency not for 15.209 limits requirement.

B. Test Plots

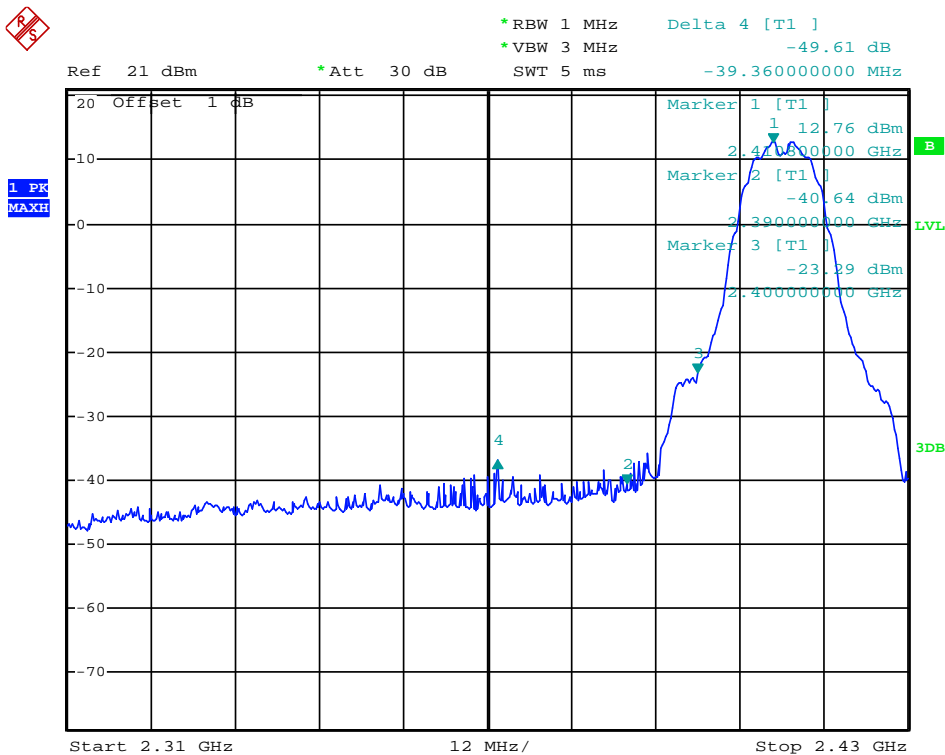

Date: 10.JAN.2014 18:15:52

(Plot 4.5.1 A1: Channel 1: 2412MHz @ 802.11b)







Date: 10.JAN.2014 18:26:43

(Plot 4.5.1 A4: Channel 11: 2462MHz @ 802.11b)

**4.5.2 802.11g Test Mode**

**A. Test Verdict**

Frequency (MHz)	Conducted Power (dBm)	Antenna Gain (dBi)	Ground Reflection Factor (dB)	Covert Radiated E Level At 3m (dBuV/m)	Detector	Limit (dBuV/m)	Refer to Plot
2390.00	-27.63	2.00	0.00	69.93	Peak	74.00	Plot 4.5.2 A1
2390.00	-43.92	2.00	0.00	53.64	AV	54.00	Plot 4.5.2 A2
2409.12	11.64	2.00	0.00	109.20	Peak	---	Plot 4.5.2 A1
2411.04	2.25	2.00	0.00	99.81	AV	---	Plot 4.5.2 A2
2460.50	12.13	2.00	0.00	109.69	Peak	---	Plot 4.5.2 A3
2460.90	2.02	2.00	0.00	99.58	AV	---	Plot 4.5.2 A4
2483.50	-24.73	2.00	0.00	72.83	Peak	74.00	Plot 4.5.2 A3
2483.50	-45.94	2.00	0.00	51.62	AV	54.00	Plot 4.5.2 A4

- Note: 1. For 802.11g mode at final test to get the worst-case emission at 6Mbps.  
 2. The test results including the cable lose.  
 3. “---” means that the fundamental frequency not for 15.209 limits requirement.

**B. Test Plots**



\*RBW 1 MHz      Marker 1 [T1 ]  
\*VBW 3 MHz      11.64 dBm  
SWT 5 ms      2.409120000 GHz

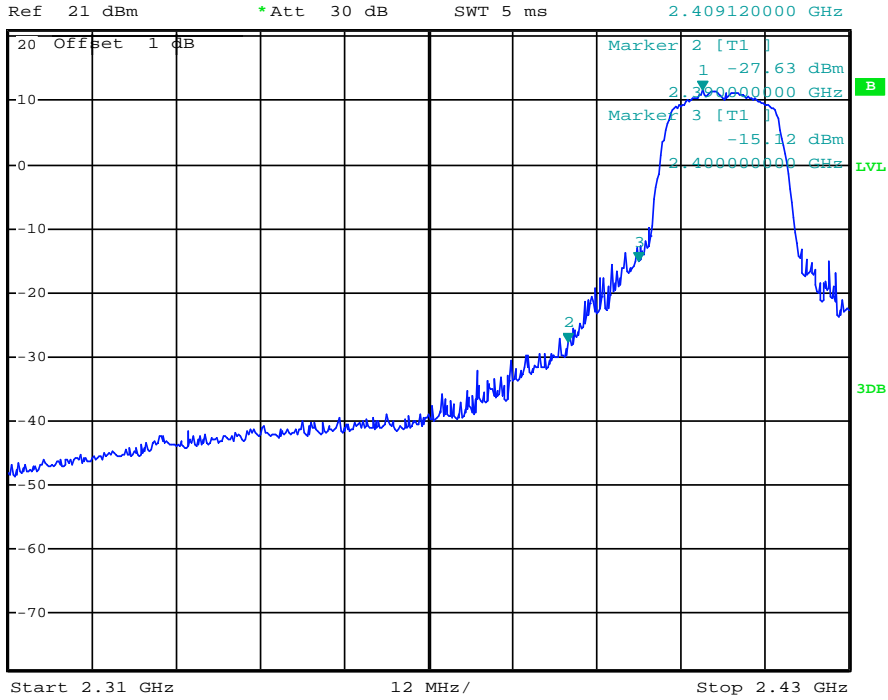

Date: 10.JAN.2014 18:18:09

(Plot 4.5.2 A1: Channel 1: 2412MHz @ 802.11g)



\*RBW 1 MHz      Marker 1 [T1 ]  
\*VBW 10 Hz      2.25 dBm  
SWT 9.6 s      2.411040000 GHz

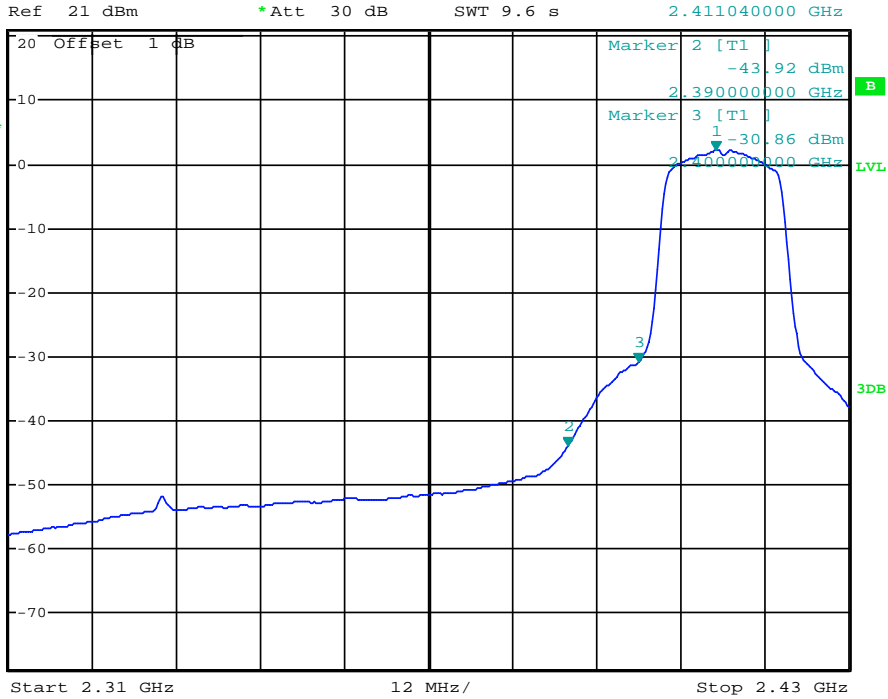

Date: 10.JAN.2014 18:17:15

(Plot 4.5.2 A2: Channel 1: 2412MHz @ 802.11g)



\*RBW 1 MHz      Marker 1 [T1 ]  
\*VBW 3 MHz      12.13 dBm  
SWT 2.5 ms      2.460500000 GHz

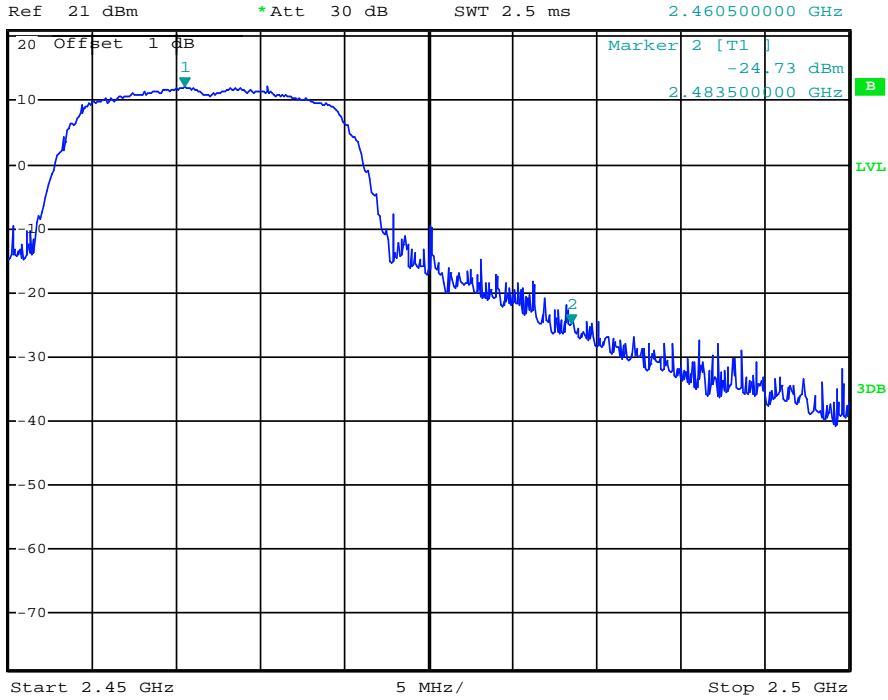

Date: 10.JAN.2014 18:28:35

(Plot 4.5.2 A3: Channel 11: 2462MHz @ 802.11g)



\*RBW 1 MHz      Marker 1 [T1 ]  
\*VBW 10 Hz      2.02 dBm  
SWT 5 s      2.460900000 GHz

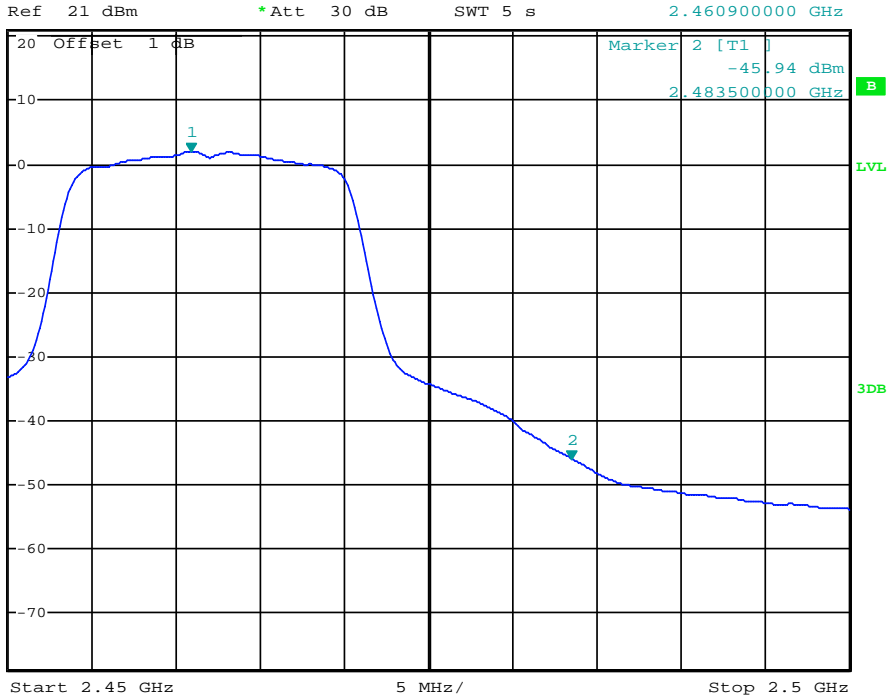

Date: 10.JAN.2014 18:30:24

(Plot 4.5.2 A4: Channel 11: 2462MHz @ 802.11g)

4.5.3 802.11n(20MHz) Test Mode

A. Test Verdict

Frequency (MHz)	Conducted Power (dBm)	Antenna Gain (dBi)	Ground Reflection Factor (dB)	Covert Radiated E Level At 3m (dBuV/m)	Detector	Limit (dBuV/m)	Refer to Plot
2390.00	-25.50	2.00	0.00	72.06	Peak	74.00	Plot 4.5.3 A1
2390.00	-46.37	2.00	0.00	51.19	AV	54.00	Plot 4.5.3 A2
2410.08	11.29	2.00	0.00	108.85	Peak	---	Plot 4.5.3 A1
2410.80	2.25	2.00	0.00	99.81	AV	---	Plot 4.5.3 A2
2463.40	11.20	2.00	0.00	108.76	Peak	---	Plot 4.5.3 A3
2460.50	2.44	2.00	0.00	100.00	AV	---	Plot 4.5.3 A4
2483.50	-24.65	2.00	0.00	72.91	Peak	74.00	Plot 4.5.3 A3
2483.50	-48.45	2.00	0.00	49.11	AV	54.00	Plot 4.5.3 A4

- Note: 1. For 802.11n(20MHz) mode at final test to get the worst-case emission at 6.5Mbps.  
 2. The test results including the cable loss.  
 3. "----" means that the fundamental frequency not for 15.209 limits requirement.

B. Test Plots

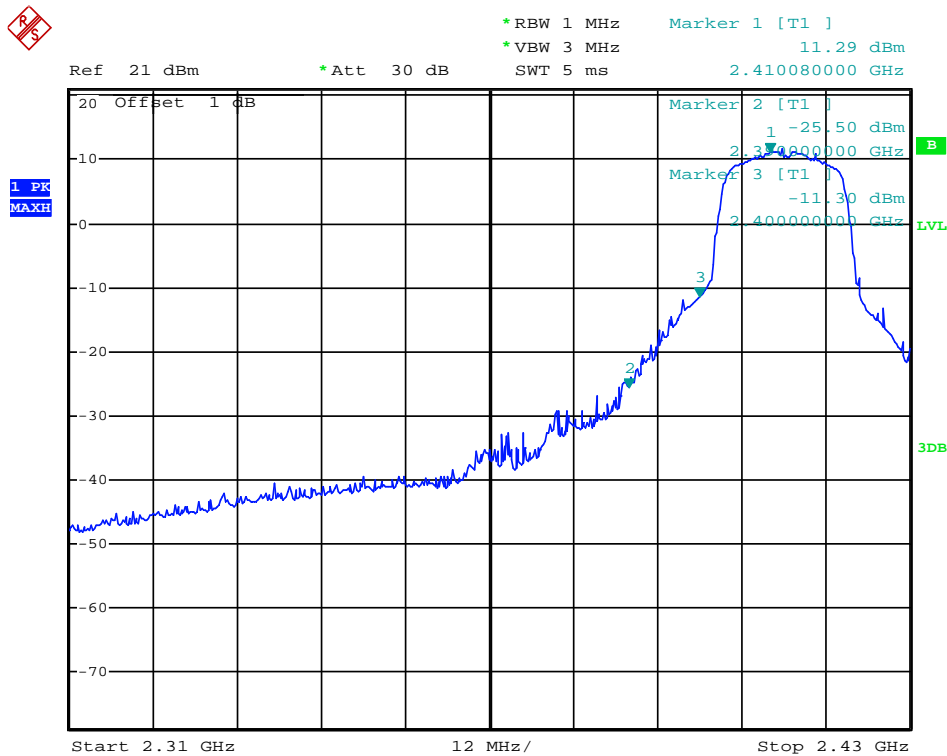

Date: 10.JAN.2014 18:22:54

(Plot 4.5.3 A1: Channel 1: 2412MHz @ 802.11n(20MHz))

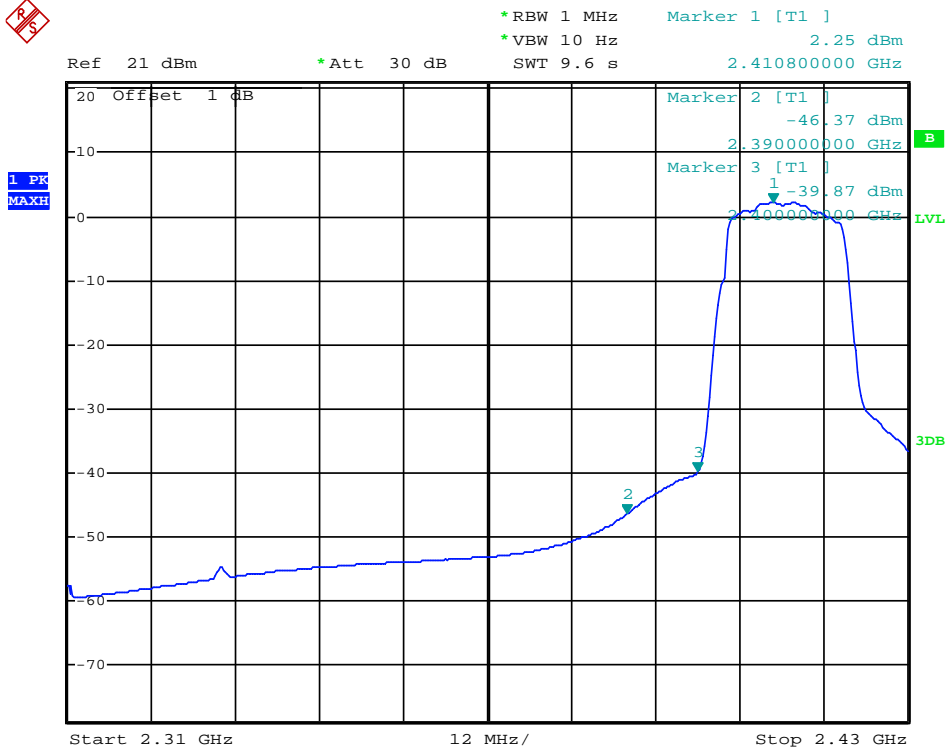

Date: 10.JAN.2014 18:25:24

(Plot 4.5.3 A2: Channel 1: 2412MHz @ 802.11n(20MHz))

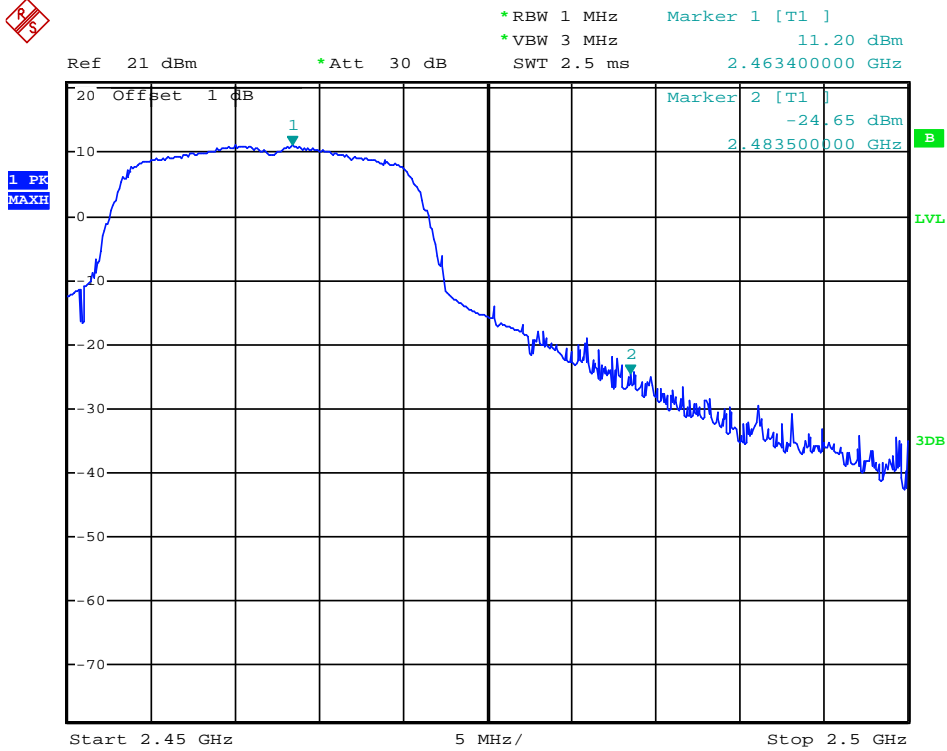

Date: 10.JAN.2014 18:35:00

(Plot 4.5.3 A3: Channel 11: 2462MHz @ 802.11n(20MHz))

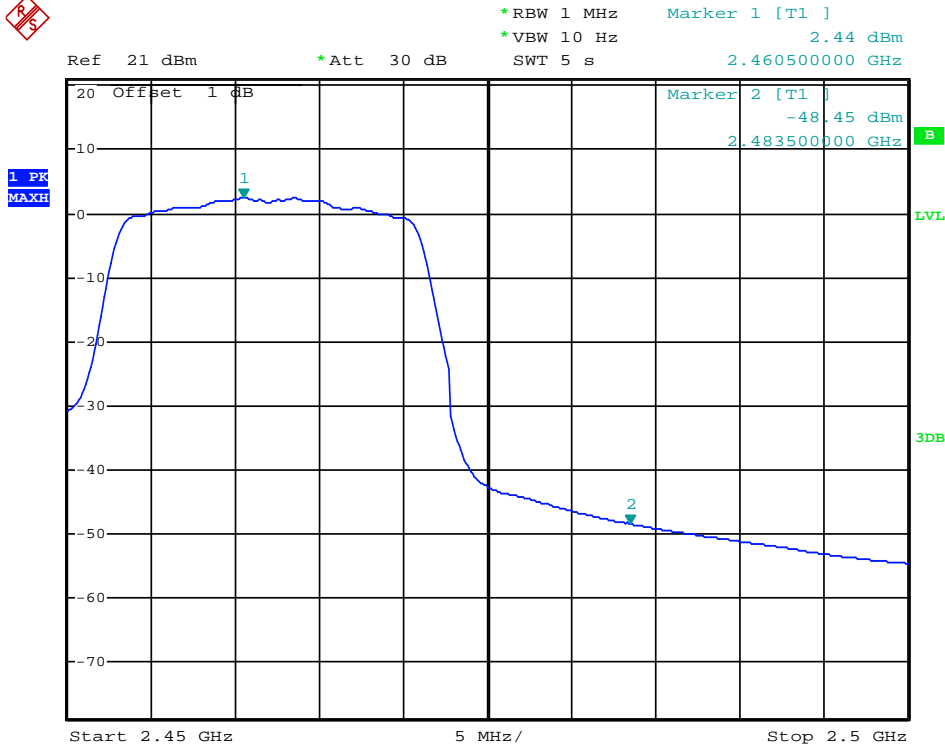

Date: 10.JAN.2014 18:33:13

(Plot 4.5.3 A4: Channel 11: 2462MHz @ 802.11n(20MHz))

**4.5.4 802.11n(40MHz) Test Mode**

**A. Test Verdict**

Frequency (MHz)	Conducted Power (dBm)	Antenna Gain (dBi)	Ground Reflection Factor (dB)	Covert Radiated E Level At 3m (dBuV/m)	Detector	Limit (dBuV/m)	Refer to Plot
2390.00	-28.71	2.00	0.00	68.85	Peak	74.00	Plot 4.5.4 A1
2390.00	-47.63	2.00	0.00	49.93	AV	54.00	Plot 4.5.4 A2
2424.80	6.86	2.00	0.00	104.42	Peak	---	Plot 4.5.4 A1
2416.40	-2.41	2.00	0.00	95.15	AV	---	Plot 4.5.4 A2
2454.92	7.21	2.00	0.00	104.77	Peak	---	Plot 4.5.4 A3
2446.38	-3.15	2.00	0.00	94.41	AV	---	Plot 4.5.4 A4
2483.50	-27.25	2.00	0.00	70.31	Peak	74.00	Plot 4.5.4 A3
2483.50	-44.94	2.00	0.00	52.62	AV	54.00	Plot 4.5.4 A4

Note: 1. For 802.11n(40MHz) mode at final test to get the worst-case emission at 13.5Mbps.  
 2. The test results including the cable loss.  
 3. "----" means that the fundamental frequency not for 15.209 limits requirement.

**B. Test Plots**



\*RBW 1 MHz      Marker 3 [T1 ]  
\*VBW 3 MHz      -24.79 dBm  
SWT 5 ms      2.40000000 GHz

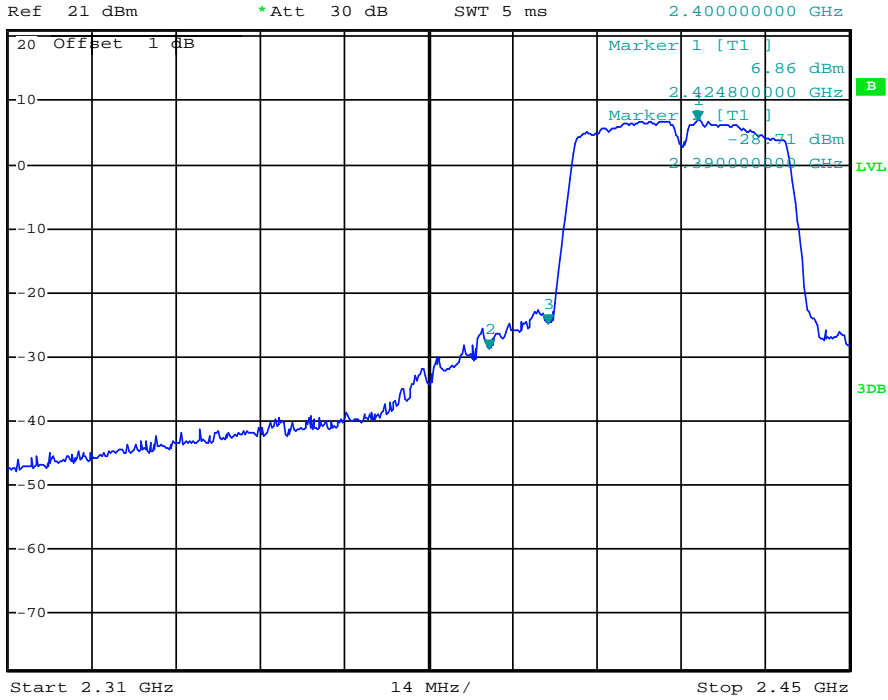

Date: 10.JAN.2014 18:36:55

(Plot 4.5.4 A1: Channel 3: 2422MHz @ 802.11n(40MHz))



\*RBW 1 MHz      Marker 3 [T1 ]  
\*VBW 10 Hz      -46.50 dBm  
SWT 11.5 s      2.40000000 GHz

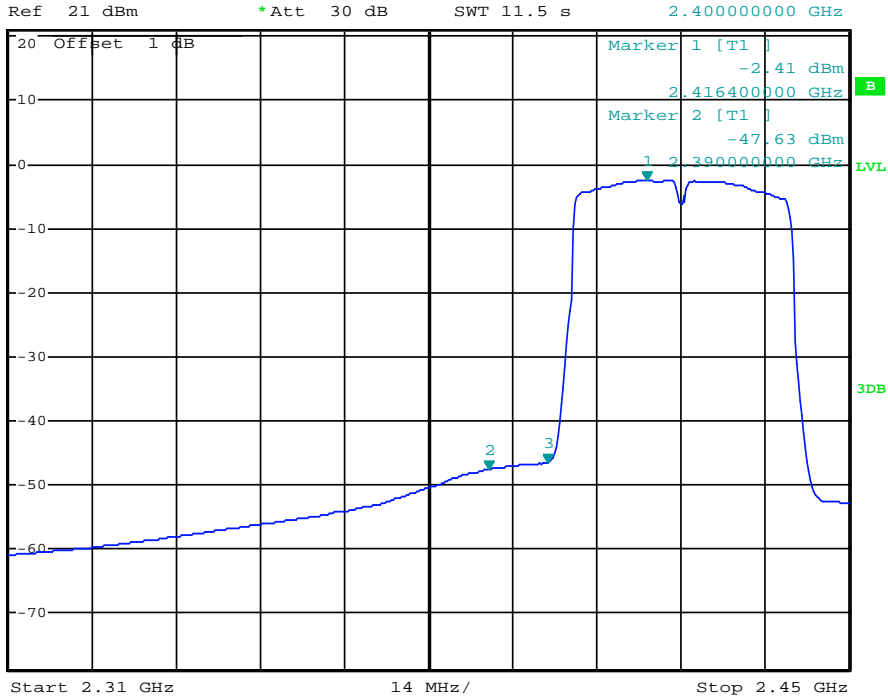

Date: 10.JAN.2014 18:41:20

(Plot 4.5.4 A2: Channel 3: 2422MHz @ 802.11n(40MHz))



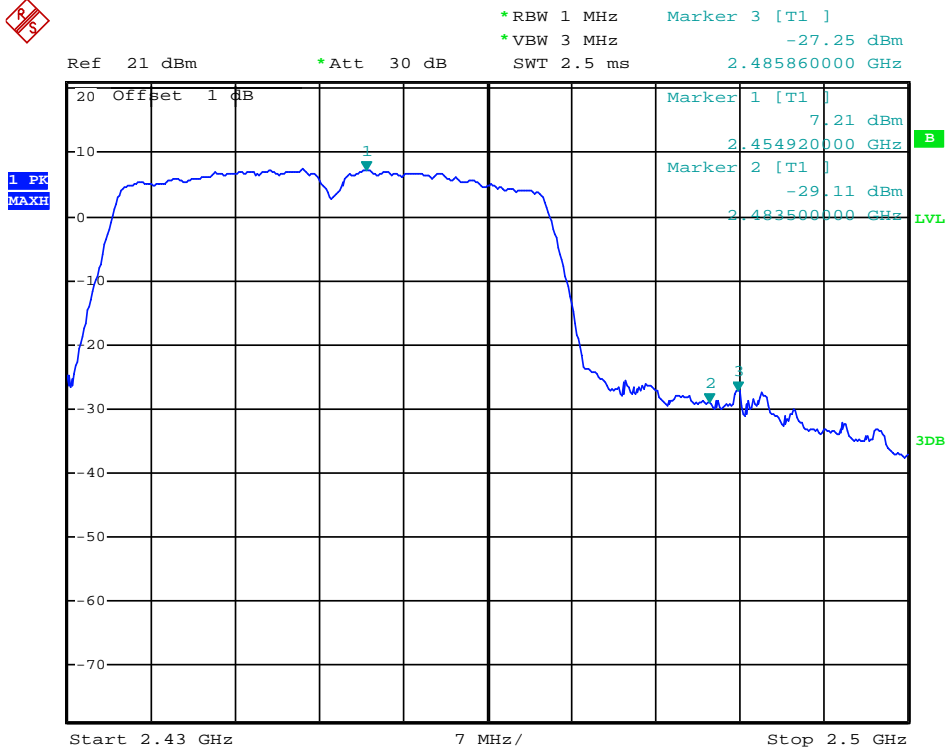

Date: 10.JAN.2014 18:38:28

(Plot 4.5.4 A3: Channel 9: 2452MHz @ 802.11n(40MHz))

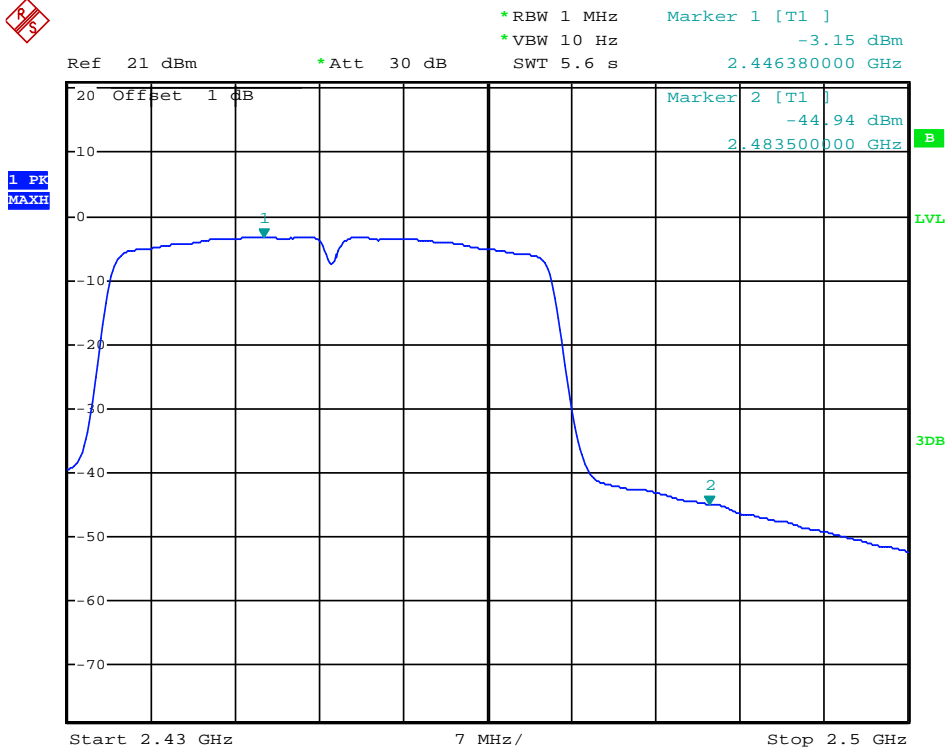

Date: 10.JAN.2014 18:38:02

(Plot 4.5.4 A4: Channel 9: 2452MHz @ 802.11n(40MHz))

## 4.6. Spurious RF Conducted Emission

### TEST CONFIGURATION

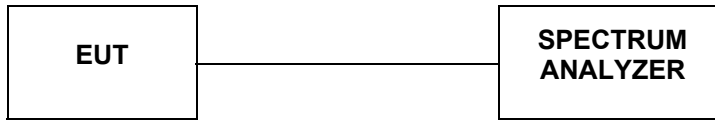

### TEST PROCEDURE

The Spurious RF conducted emissions compliance of RF radiated emission should be measured by following the guidance in ANSI C63.10-2009 with respect to maximizing the emission by rotating the EUT, measuring the emission while the EUT is situated in three orthogonal planes (if appropriate), adjusting the measurement antenna height and polarization etc. Set RBW=100kHz and VBM= 300KHz to measure the peak field strength, and measure frequency range from 30MHz to 26.5GHz.

### LIMIT

1. Below -20dB of the highest emission level in operating band.
2. Fall in the restricted bands listed in section 15.205. The maximum permitted average field strength is listed in section 15.209.

### TEST RESULTS

Remark: The measurement frequency range is from 30MHz to the 10<sup>th</sup> harmonic of the fundamental frequency. The lowest, middle and highest channels are tested to verify the spurious emissions and bandedge measurement data.

#### 4.6.1 802.11b Test Mode

##### A. Test Verdict

Channel	Frequency (MHz)	Refer to Plot	Limit (dBc)	Verdict
1	2412	Plot 4.6.1 A1	-20	PASS
		Plot 4.6.1 A2	-20	PASS
		Plot 4.6.1 A3	-20	PASS
6	2437	Plot 4.6.1 B1	-20	PASS
		Plot 4.6.1 B2	-20	PASS
		Plot 4.6.1 B3	-20	PASS
11	2462	Plot 4.6.1 C1	-20	PASS
		Plot 4.6.1 C2	-20	PASS
		Plot 4.6.1 C3	-20	PASS

Frequency (MHz)	Delta Peak to Band emission (dBc)	Detector	Limit (dBc)	Refer to Plot	Verdict
2400.00	-40.20	Peak	-20	Plot 4.6.1 D	PASS
2483.50	-53.57	Peak	-20	Plot 4.6.1 E	PASS

- Note: 1. For 802.11b mode at final test to get the worst-case emission at 1Mbps.  
2. The test results including the cable loss.

##### B. Test Plots



\*RBW 100 kHz Marker 1 [T1 ]  
\*VBW 300 kHz 6.54 dBm  
SWT 300 ms 2.417880000 GHz

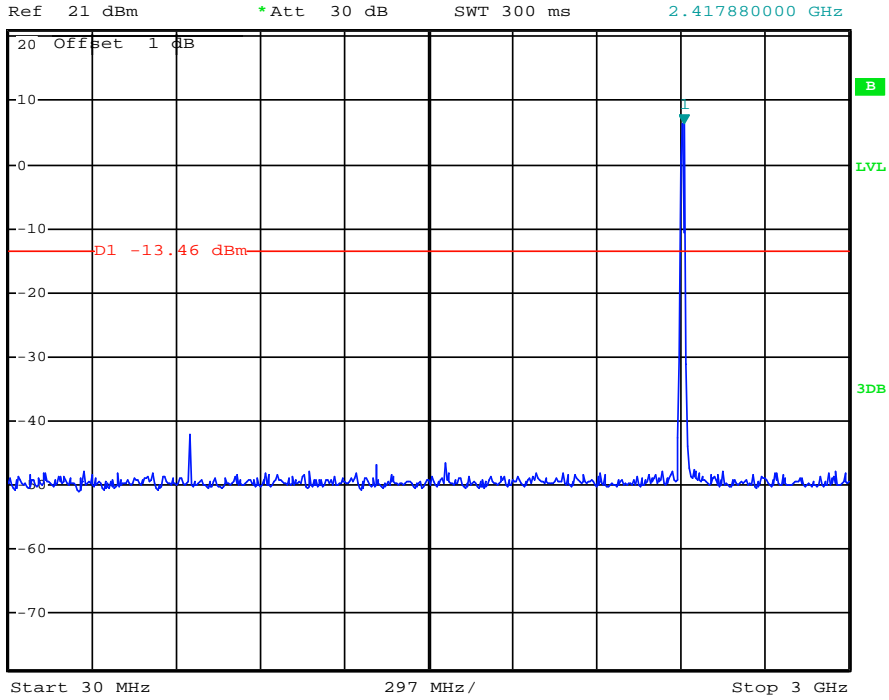

Date: 10.JAN.2014 18:43:42

(Plot 4.6.1 A1: Channel 1: 2412MHz @ 802.11b)



\*RBW 100 kHz Marker 1 [T1 ]  
\*VBW 300 kHz -44.18 dBm  
SWT 1.2 s 14.088000000 GHz

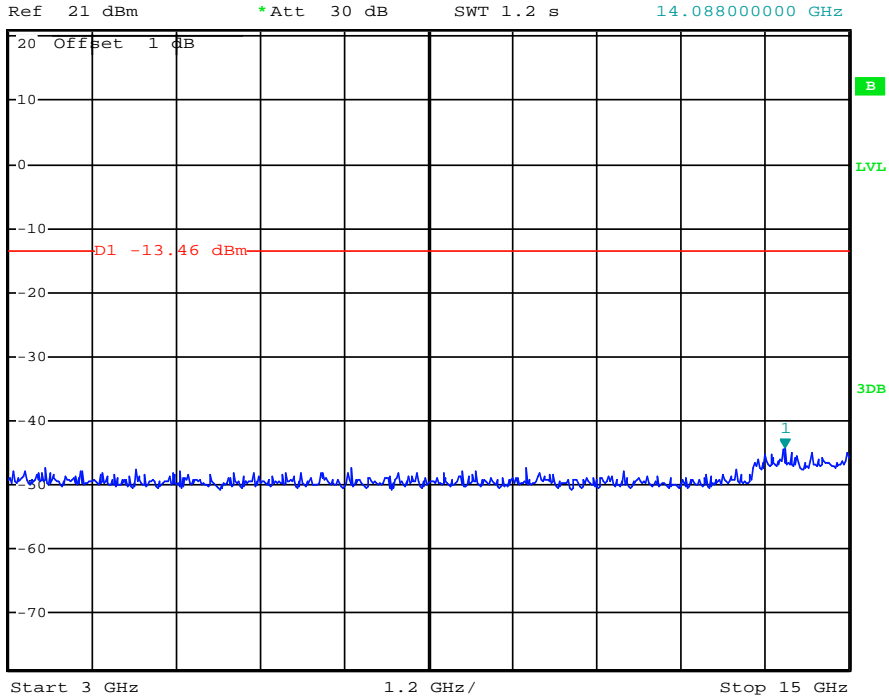

Date: 10.JAN.2014 18:43:57

(Plot 4.6.1 A2: Channel 1: 2412MHz @ 802.11b)



\*RBW 100 kHz Marker 1 [T1 ]  
\*VBW 300 kHz -43.06 dBm  
SWT 1 s 21.60000000 GHz

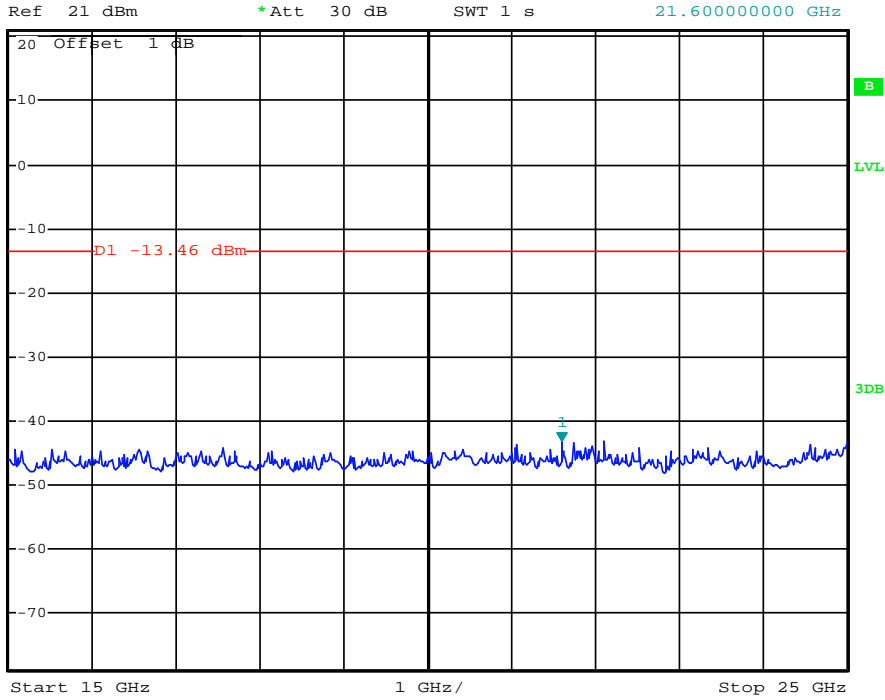

Date: 10.JAN.2014 18:44:08

(Plot 4.6.1 A3: Channel 1: 2412MHz @ 802.11b)



\*RBW 100 kHz Marker 1 [T1 ]  
\*VBW 300 kHz 8.35 dBm  
SWT 300 ms 2.441640000 GHz

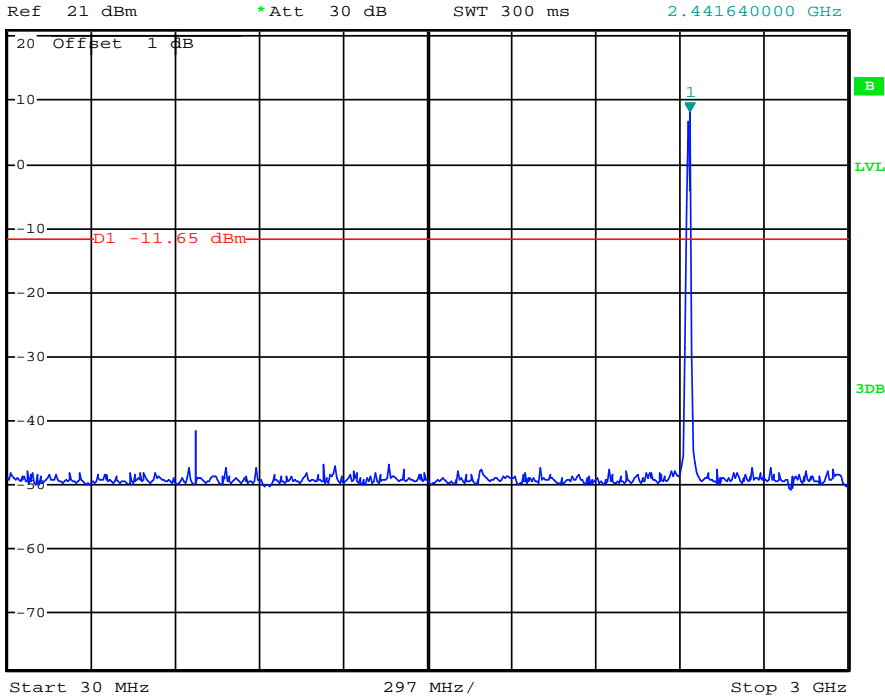

Date: 10.JAN.2014 18:45:02

(Plot 4.6.1 B1: Channel 6: 2437MHz @ 802.11b)



\*RBW 100 kHz Marker 1 [T1 ]  
\*VBW 300 kHz -45.69 dBm  
SWT 1.2 s 14.472000000 GHz

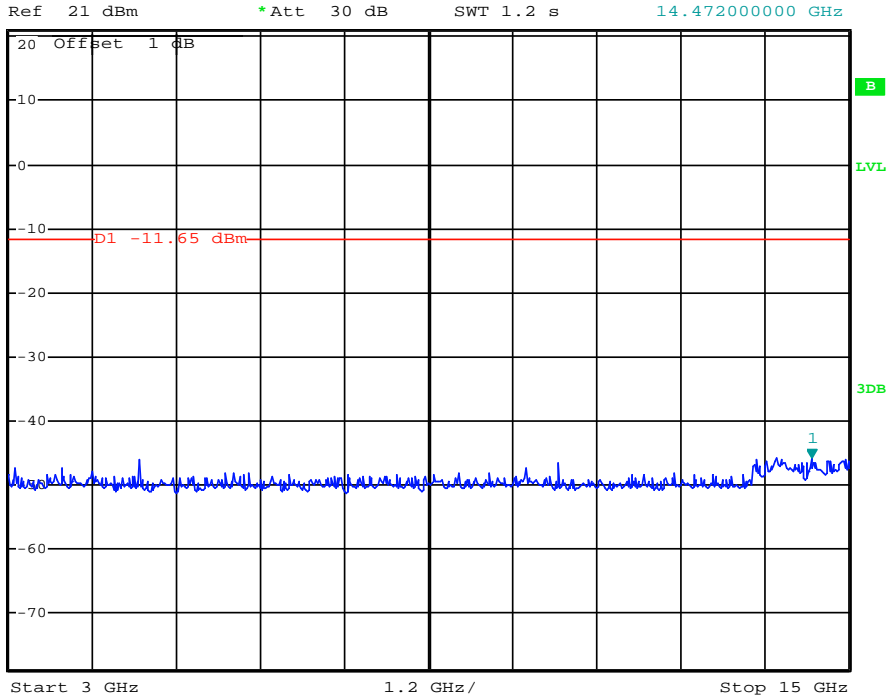

Date: 10.JAN.2014 18:45:13

(Plot 4.6.1 B2: Channel 6: 2437MHz @ 802.11b)



\*RBW 100 kHz Marker 1 [T1 ]  
\*VBW 300 kHz -42.71 dBm  
SWT 1 s 20.740000000 GHz

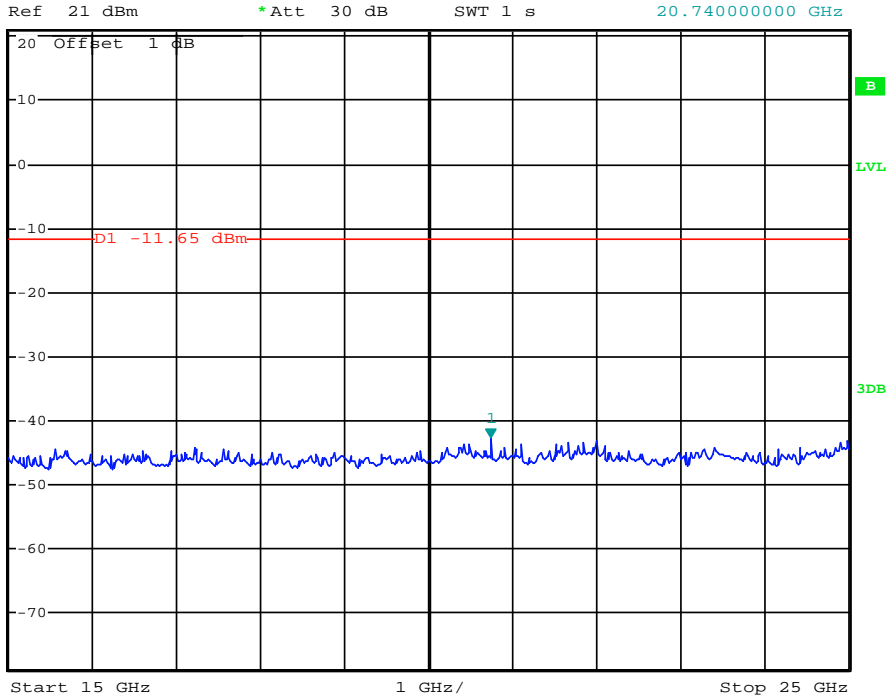

Date: 10.JAN.2014 18:45:25

(Plot 4.6.1 B3: Channel 6: 2437MHz @ 802.11b)

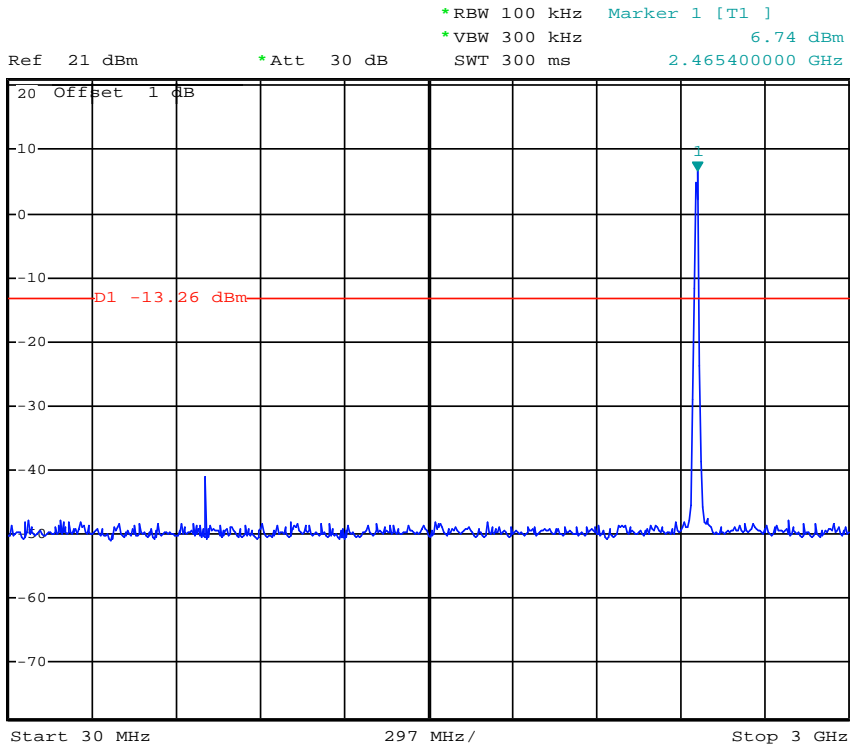

Date: 10.JAN.2014 18:46:08

(Plot 4.6.1 C1: Channel 11: 2462MHz @ 802.11b)

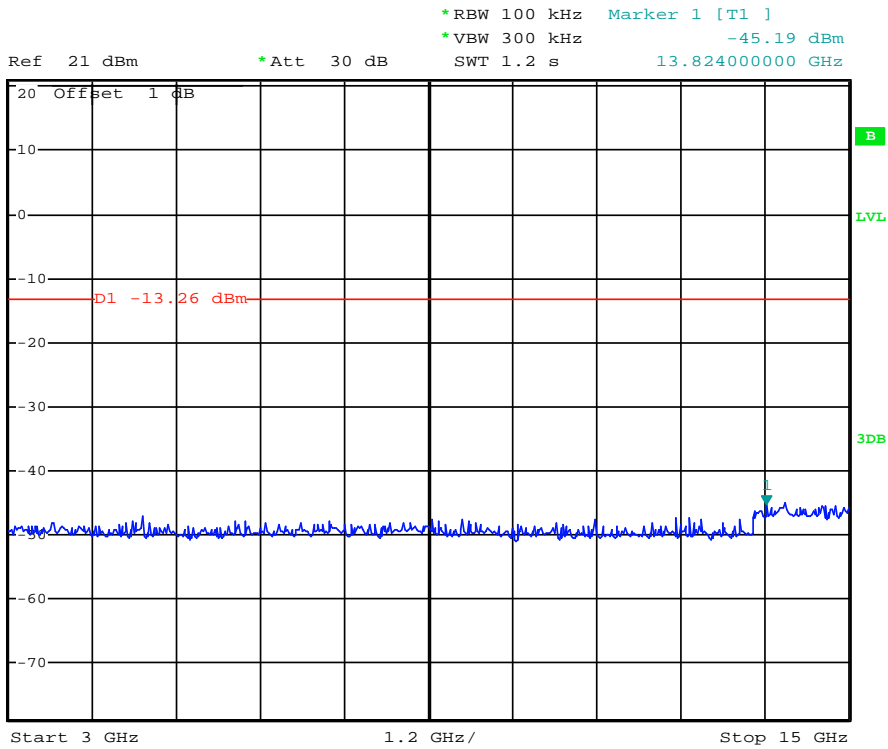

Date: 10.JAN.2014 18:46:21

(Plot 4.6.1 C2: Channel 11: 2462MHz @ 802.11b)



\*RBW 100 kHz Marker 1 [T1 ]  
\*VBW 300 kHz -42.59 dBm  
SWT 1 s 24.94000000 GHz

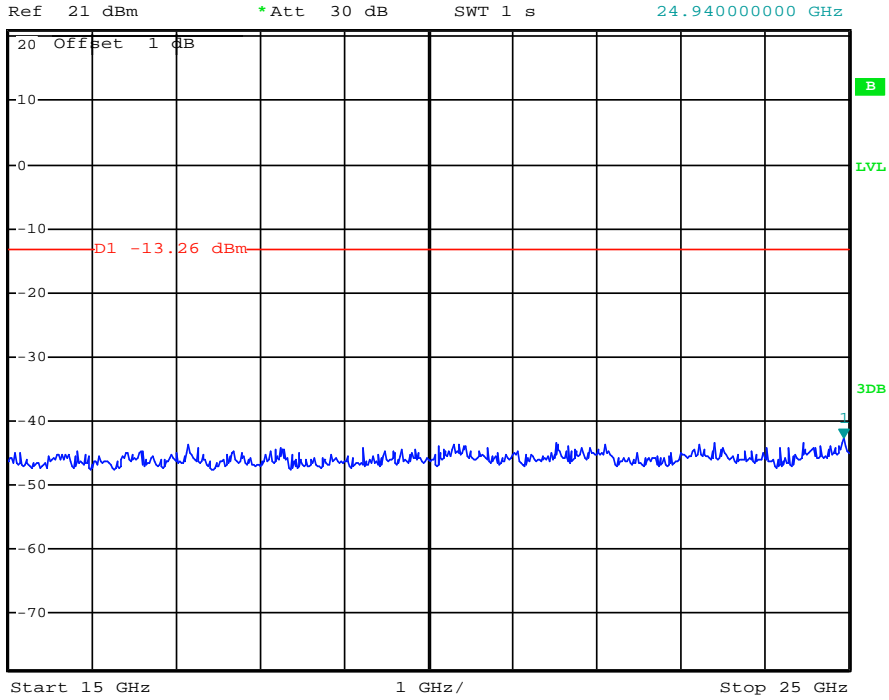

Date: 10.JAN.2014 18:46:31

(Plot 4.6.1 C3: Channel 11: 2462MHz @ 802.11b)



\*RBW 100 kHz Marker 3 [T1 ]  
\*VBW 300 kHz -48.04 dBm  
SWT 15 ms 2.390000000 GHz

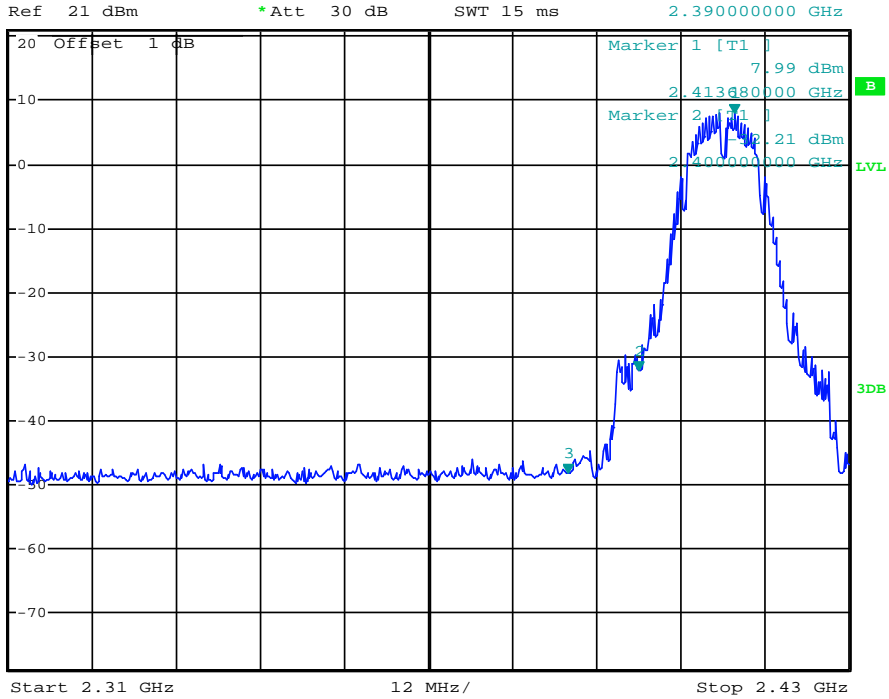

Date: 10.JAN.2014 18:09:18

(Plot 4.6.1 D: Channel 1: 2412MHz @ 802.11b)

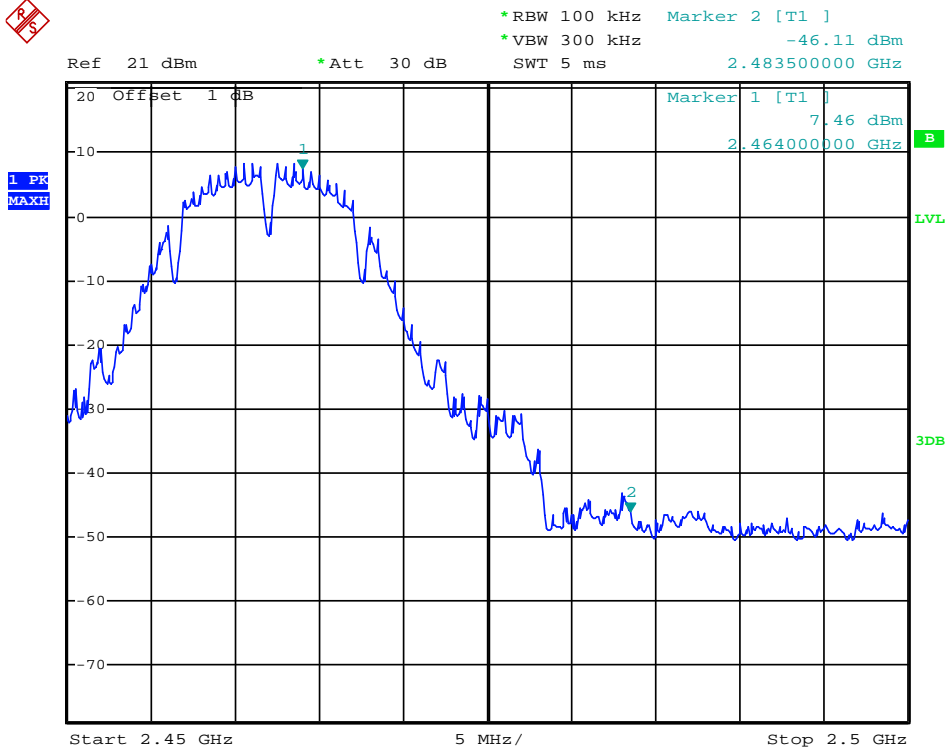

Date: 10.JAN.2014 18:11:03

(Plot 4.6.1 E: Channel 11: 2462MHz @ 802.11b)

4.6.2 802.11g Test Mode

A. Test Verdict

Channel	Frequency (MHz)	Refer to Plot	Limit (dBc)	Verdict
1	2412	Plot 4.6.2 A1	-20	PASS
		Plot 4.6.2 A2	-20	PASS
		Plot 4.6.2 A3	-20	PASS
6	2437	Plot 4.6.2 B1	-20	PASS
		Plot 4.6.2 B2	-20	PASS
		Plot 4.6.2 B3	-20	PASS
11	2462	Plot 4.6.2 C1	-20	PASS
		Plot 4.6.2 C2	-20	PASS
		Plot 4.6.2 C3	-20	PASS

Frequency (MHz)	Delta Peak to Band emission (dBc)	Detector	Limit (dBc)	Refer to Plot	Verdict
2400.00	-35.95	Peak	-20	Plot 4.6.2 D	PASS
2483.50	-43.16	Peak	-20	Plot 4.6.2 E	PASS

Note: 1. For 802.11g mode at final test to get the worst-case emission at 6Mbps.  
 2. The test results including the cable lose.

B. Test Plots





Ref 21 dBm \*Att 30 dB \*RBW 100 kHz Marker 1 [T1] -0.36 dBm  
\*VBW 300 kHz 2.411940000 GHz  
SWT 300 ms

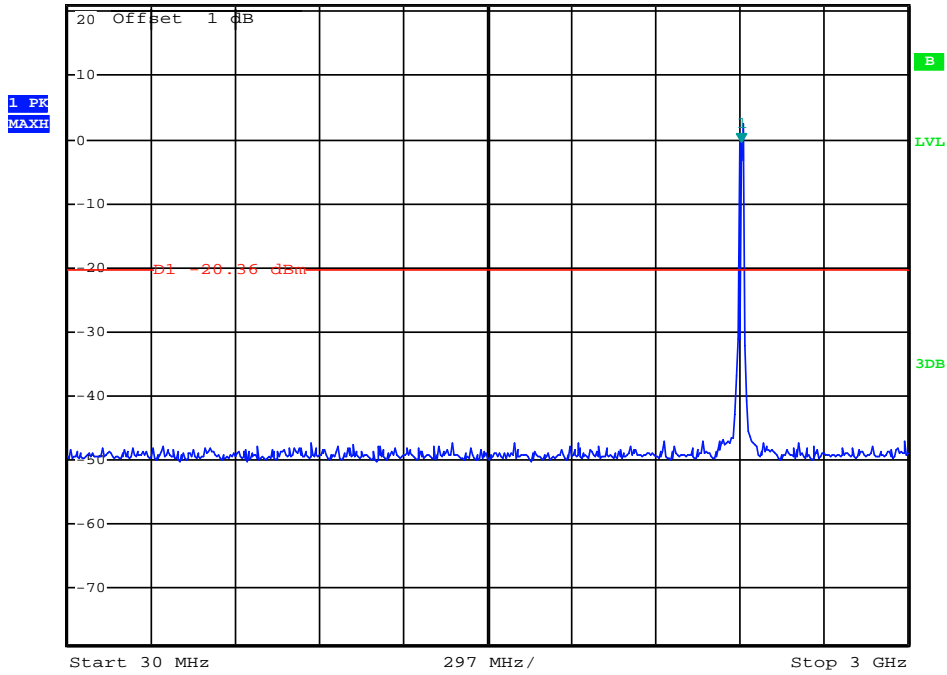

Date: 10.JAN.2014 18:47:29

(Plot 4.6.2 A1: Channel 1: 2412MHz @ 802.11g)



Ref 21 dBm \*Att 30 dB \*RBW 100 kHz Marker 1 [T1] -45.35 dBm  
\*VBW 300 kHz 13.944000000 GHz  
SWT 1.2 s

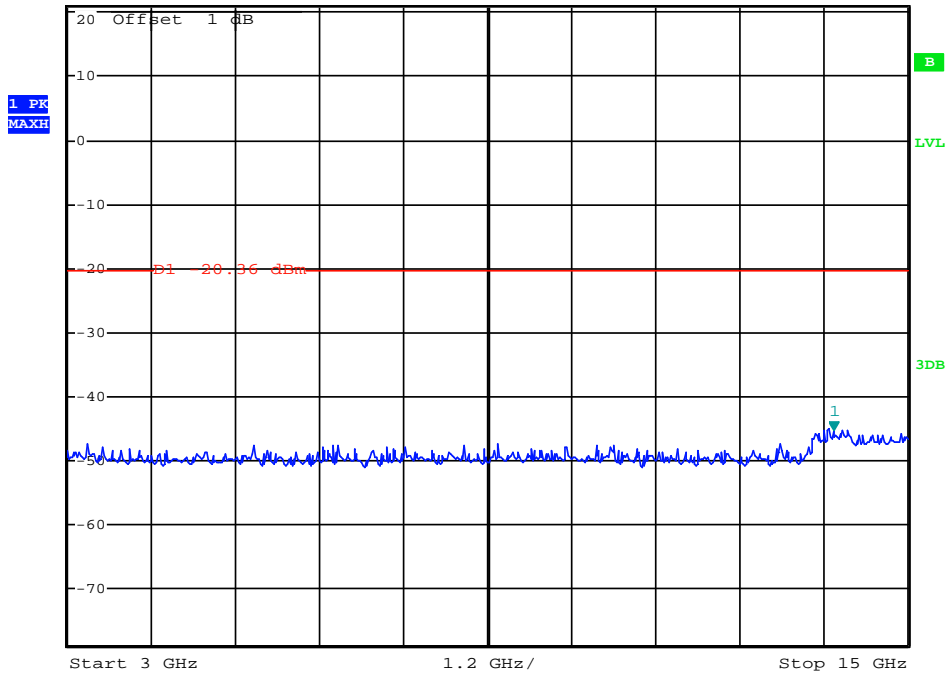

Date: 10.JAN.2014 18:47:46

(Plot 4.6.2 A2: Channel 1: 2412MHz @ 802.11g)



\*RBW 100 kHz Marker 1 [T1 ]  
\*VBW 300 kHz -43.11 dBm  
SWT 1 s 23.34000000 GHz

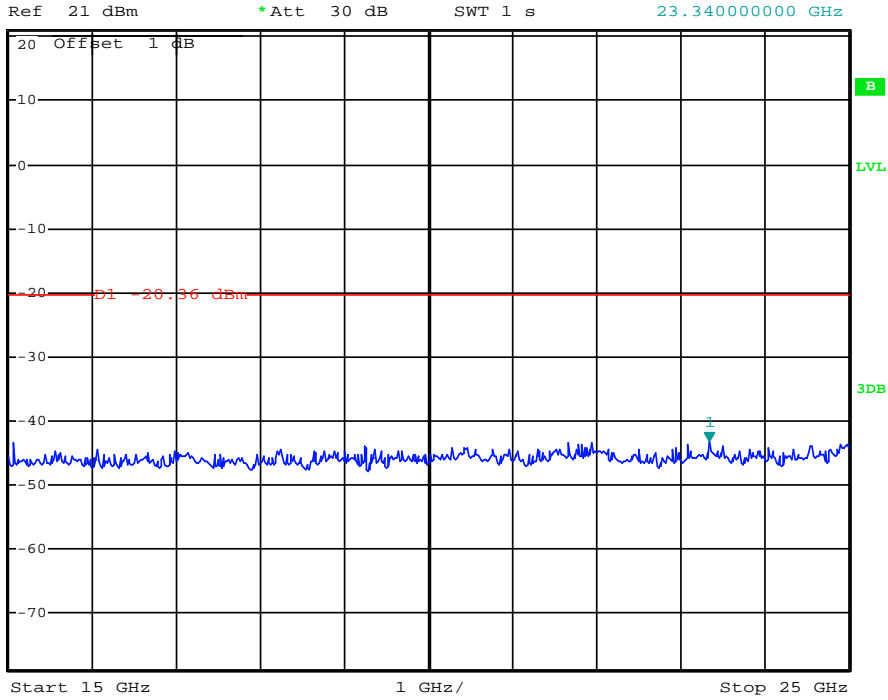

Date: 10.JAN.2014 18:47:57

(Plot 4.6.2 A3: Channel 1: 2412MHz @ 802.11g)



\*RBW 100 kHz Marker 1 [T1 ]  
\*VBW 300 kHz 1.29 dBm  
SWT 300 ms 2.435700000 GHz

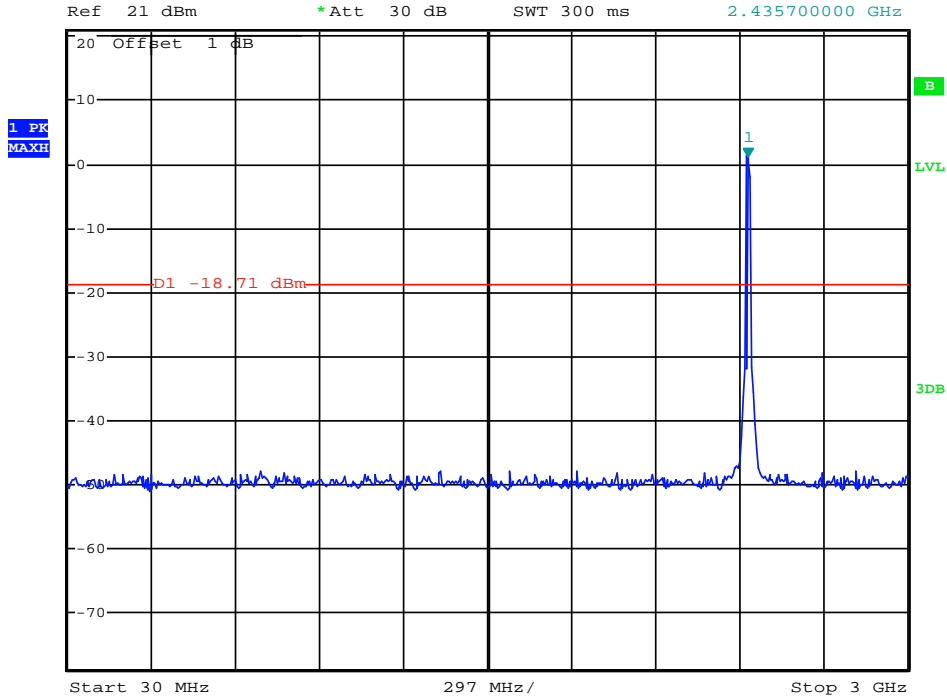

Date: 10.JAN.2014 18:48:34

(Plot 4.6.2 B1: Channel 6: 2437MHz @ 802.11g)



\*RBW 100 kHz Marker 1 [T1 ]  
\*VBW 300 kHz -44.60 dBm  
SWT 1.2 s 14.208000000 GHz

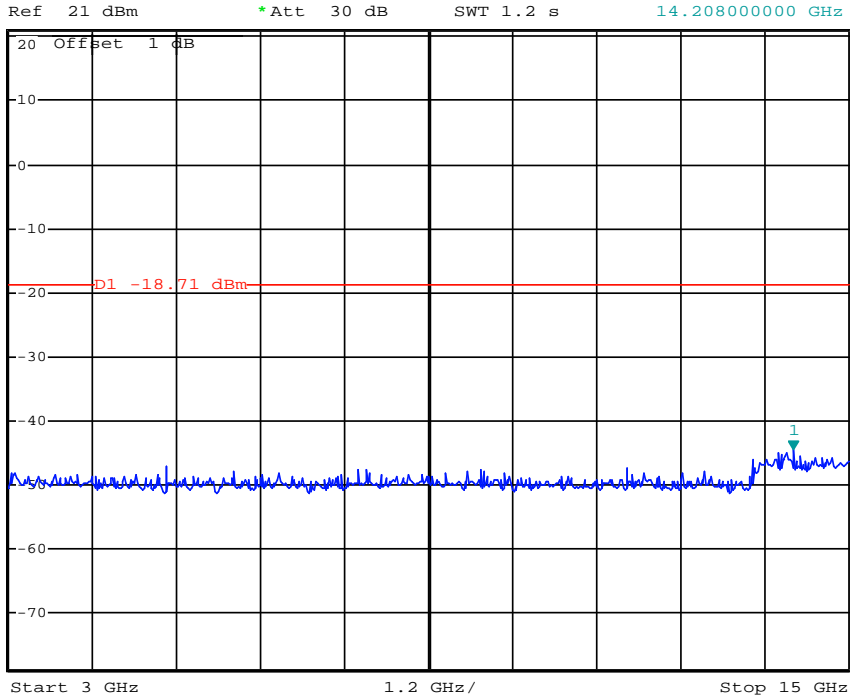

Date: 10.JAN.2014 18:48:47

(Plot 4.6.2 B2: Channel 6: 2437MHz @ 802.11g)



\*RBW 100 kHz Marker 1 [T1 ]  
\*VBW 300 kHz -43.10 dBm  
SWT 1 s 25.000000000 GHz

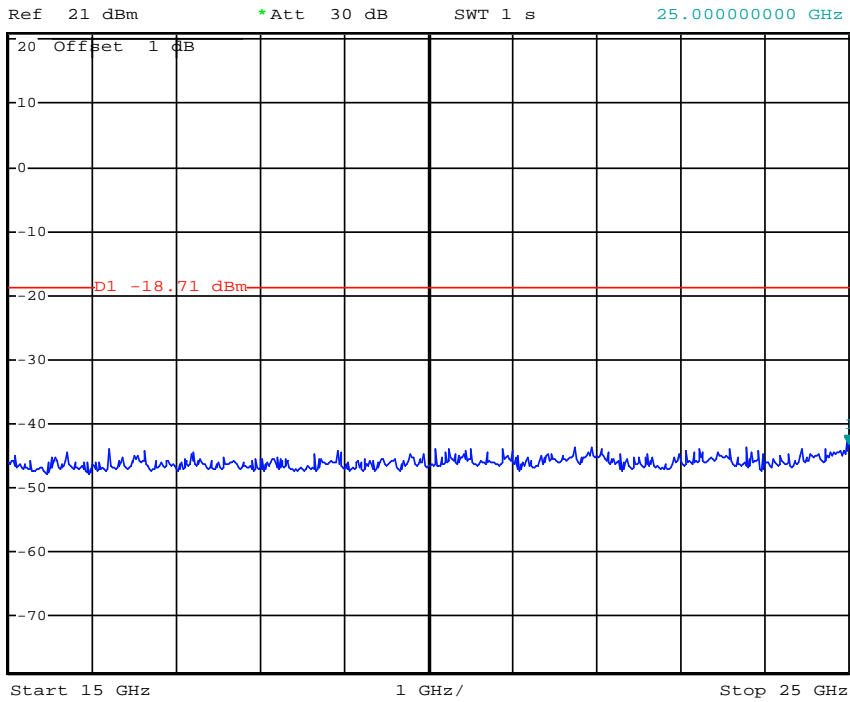

Date: 10.JAN.2014 18:48:59

(Plot 4.6.2 B3: Channel 6: 2437MHz @ 802.11g)

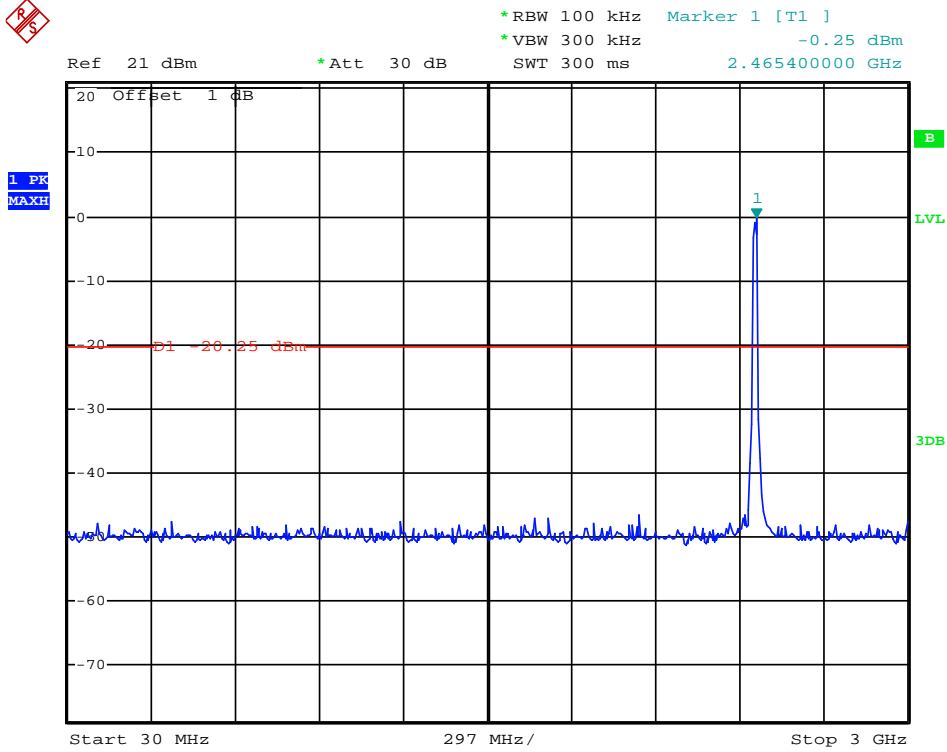

Date: 10.JAN.2014 18:49:25

(Plot 4.6.2 C1: Channel 11: 2462MHz @ 802.11g)

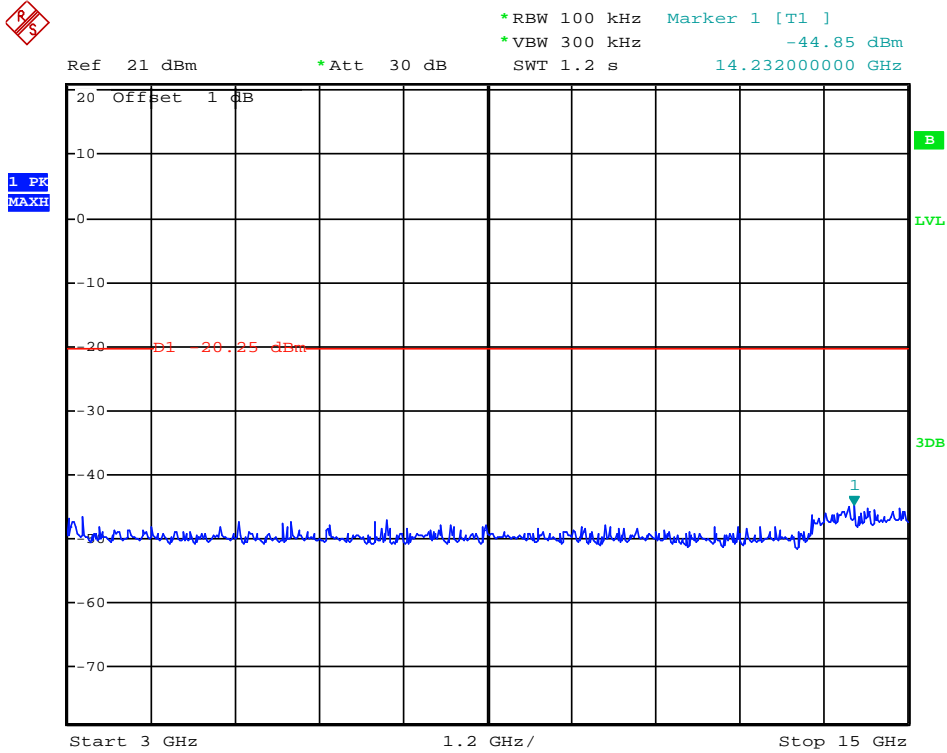

Date: 10.JAN.2014 18:49:35

(Plot 4.6.2 C2: Channel 11: 2462MHz @ 802.11g)



\*RBW 100 kHz Marker 1 [T1 ]  
\*VBW 300 kHz -43.49 dBm  
SWT 1 s 17.060000000 GHz

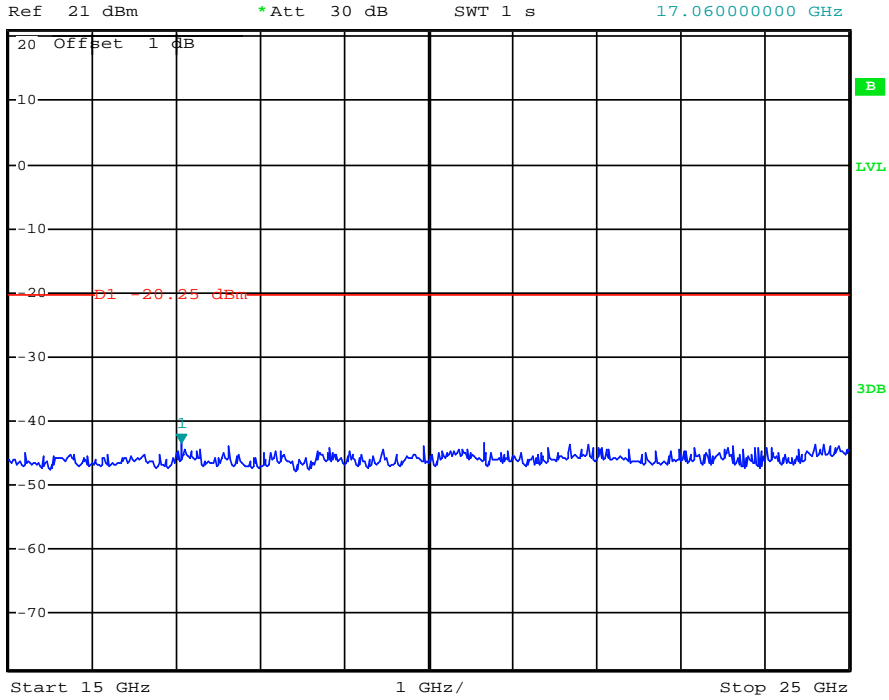

Date: 10.JAN.2014 18:49:48

(Plot 4.6.2 C3: Channel 11: 2462MHz @ 802.11g)



\*RBW 100 kHz Marker 1 [T1 ]  
\*VBW 300 kHz 2.86 dBm  
SWT 15 ms 2.413440000 GHz

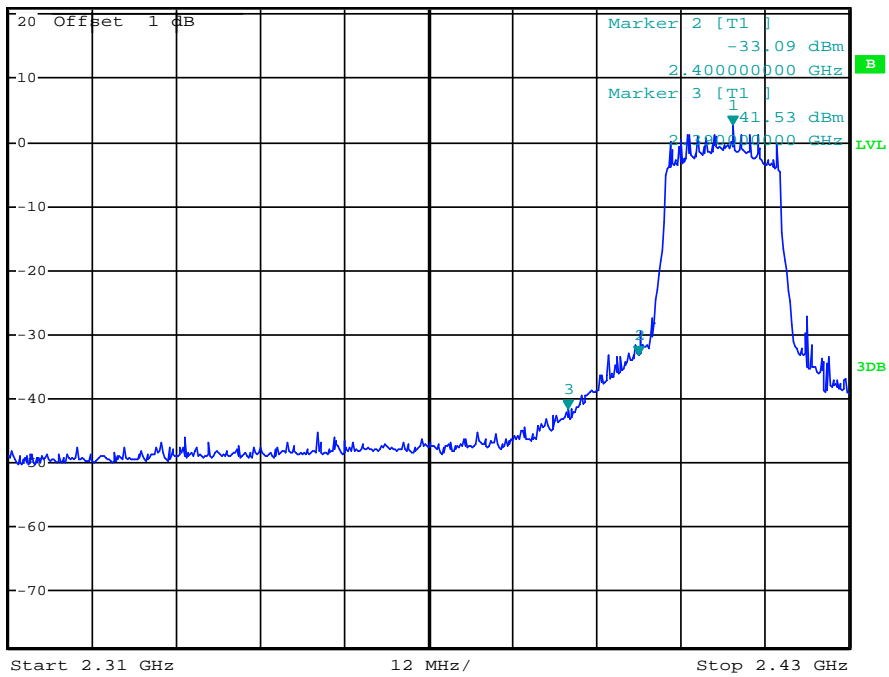

Date: 10.JAN.2014 18:09:45

(Plot 4.6.2 D: Channel 1: 2412MHz @ 802.11g)

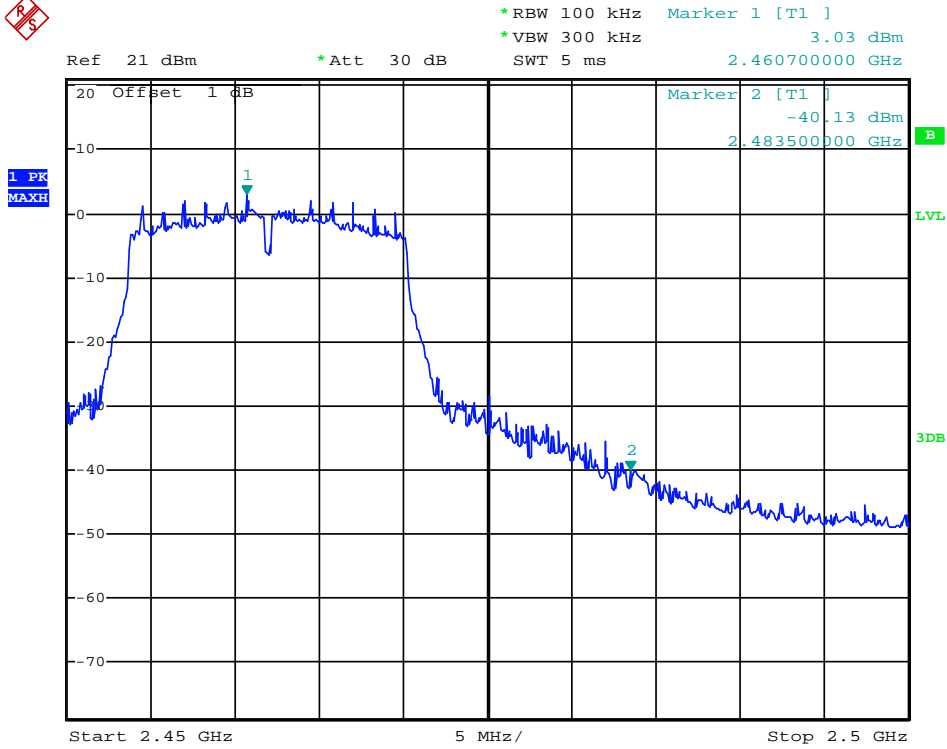

Date: 10.JAN.2014 18:11:43

(Plot 4.6.2 E: Channel 11: 2462MHz @ 802.11g)

**4.6.3 802.11n(20MHz) Test Mode**

**A. Test Verdict**

Channel	Frequency (MHz)	Refer to Plot	Limit (dBc)	Verdict
1	2412	Plot 4.6.3 A1	-20	PASS
		Plot 4.6.3 A2	-20	PASS
		Plot 4.6.3 A3	-20	PASS
6	2437	Plot 4.6.3 B1	-20	PASS
		Plot 4.6.3 B2	-20	PASS
		Plot 4.6.3 B3	-20	PASS
11	2462	Plot 4.6.3 C1	-20	PASS
		Plot 4.6.3 C2	-20	PASS
		Plot 4.6.3 C3	-20	PASS

Frequency (MHz)	Delta Peak to Band emission (dBc)	Detector	Limit (dBc)	Refer to Plot	Verdict
2400.00	-34.70	Peak	-20	Plot 4.6.3 D	PASS
2483.50	-42.51	Peak	-20	Plot 4.6.3 E	PASS

Note: 1. For 802.11n(20MHz) mode at final test to get the worst-case emission at 6.5Mbps.  
 2.The test results including the cable lose.

**B. Test Plots**



\*RBW 100 kHz Marker 1 [T1 ]  
\*VBW 300 kHz 0.90 dBm  
SWT 300 ms 2.411940000 GHz

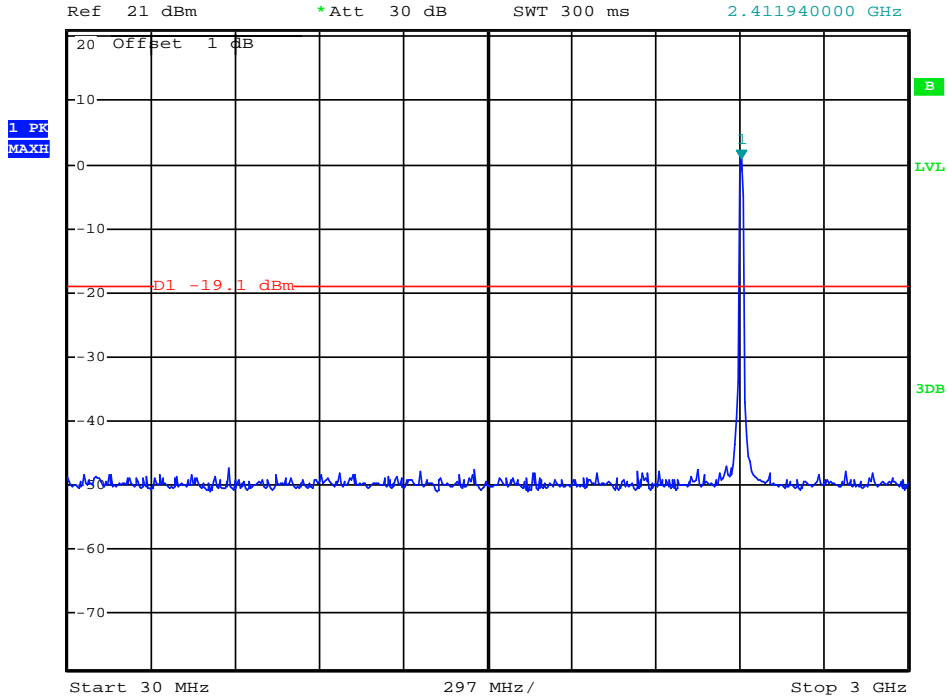

Date: 10.JAN.2014 18:50:20

(Plot 4.6.3 A1: Channel 1: 2412MHz @ 802.11n(20MHz))



\*RBW 100 kHz Marker 1 [T1 ]  
\*VBW 300 kHz -43.75 dBm  
SWT 1.2 s 14.568000000 GHz

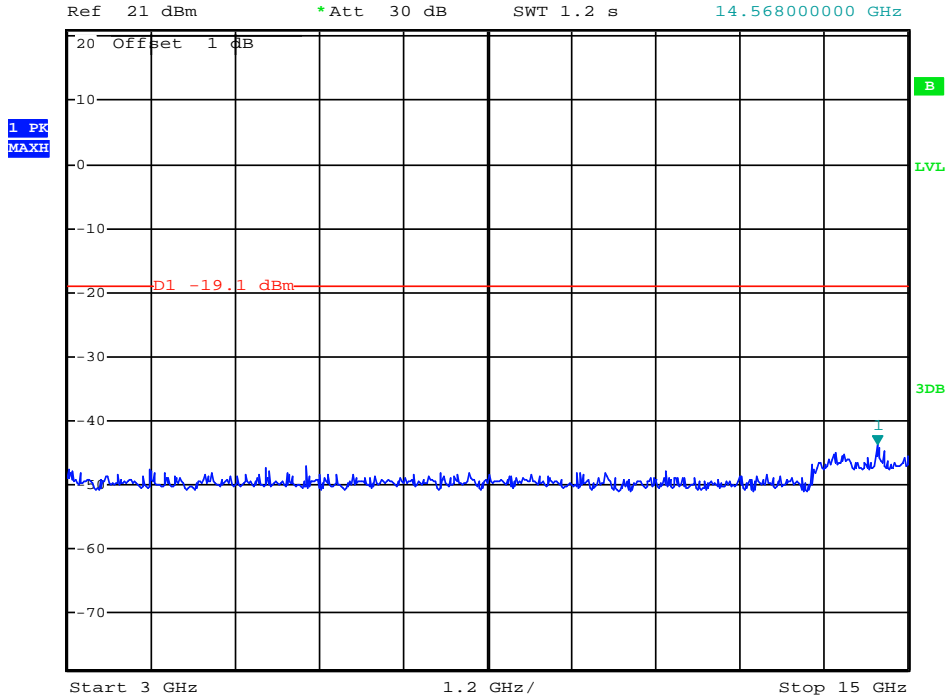

Date: 10.JAN.2014 18:50:31

(Plot 4.6.3 A2: Channel 1: 2412MHz @ 802.11n(20MHz))



\*RBW 100 kHz Marker 1 [T1 ]  
\*VBW 300 kHz -42.28 dBm  
SWT 1 s 20.40000000 GHz

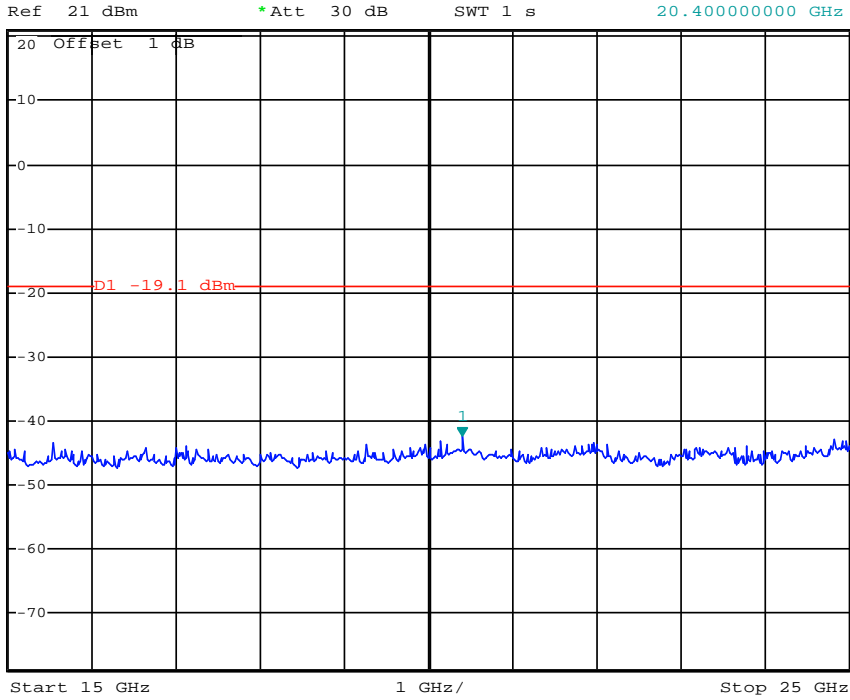

Date: 10.JAN.2014 18:50:53

(Plot 4.6.3 A3: Channel 1: 2412MHz @ 802.11n(20MHz))



\*RBW 100 kHz Marker 1 [T1 ]  
\*VBW 300 kHz 0.08 dBm  
SWT 300 ms 2.441640000 GHz

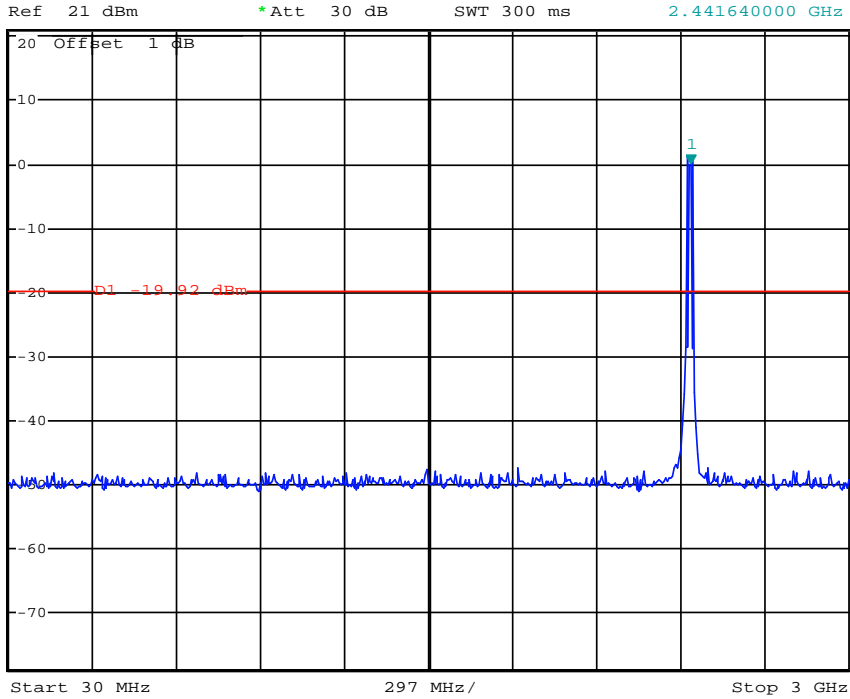

Date: 10.JAN.2014 18:51:22

(Plot 4.6.3 B1: Channel 6: 2437MHz @ 802.11n(20MHz))



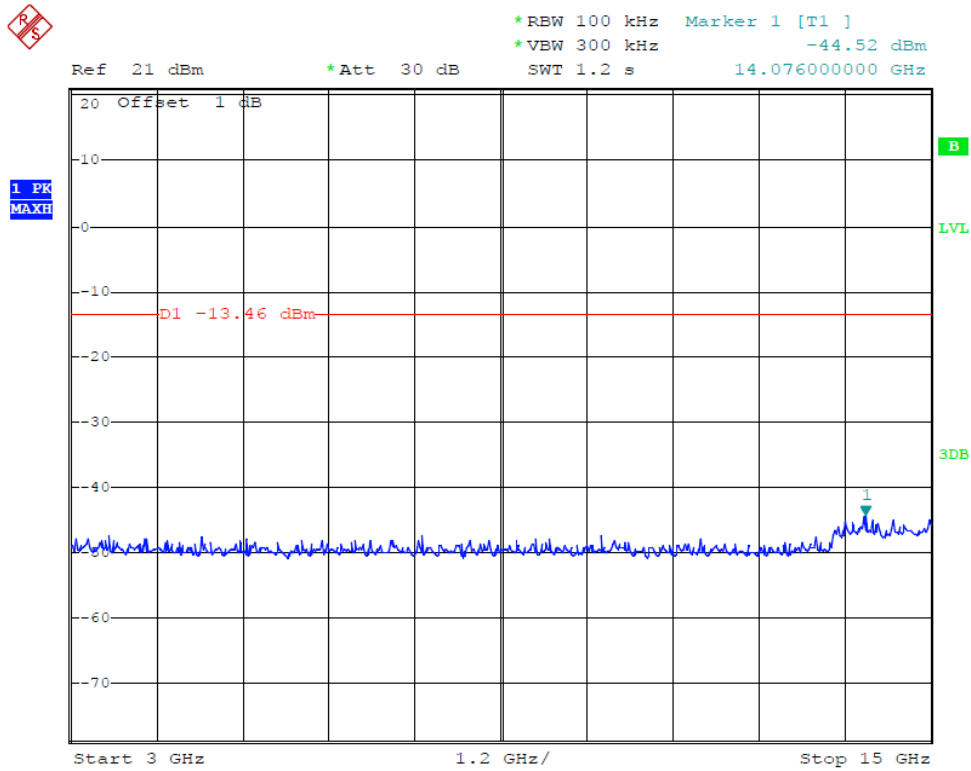

Date: 10.JAN.2014 19:43:43

(Plot 4.6.3 B2: Channel 6: 2437MHz @ 802.11n(20MHz))

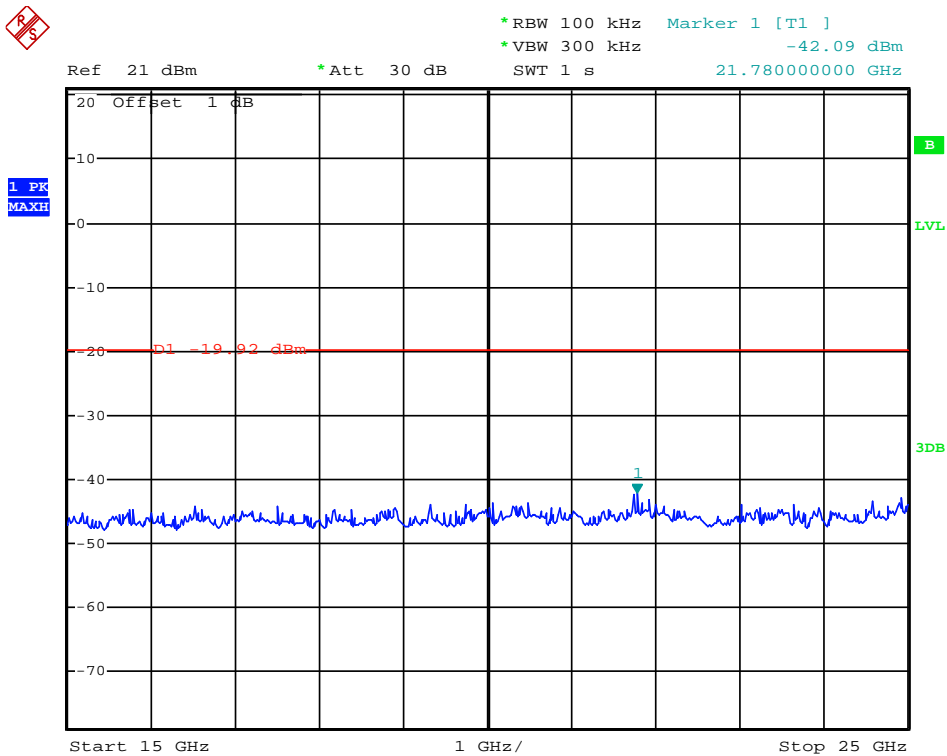

Date: 10.JAN.2014 18:51:42

(Plot 4.6.3 B3: Channel 6: 2437MHz @ 802.11n(20MHz))

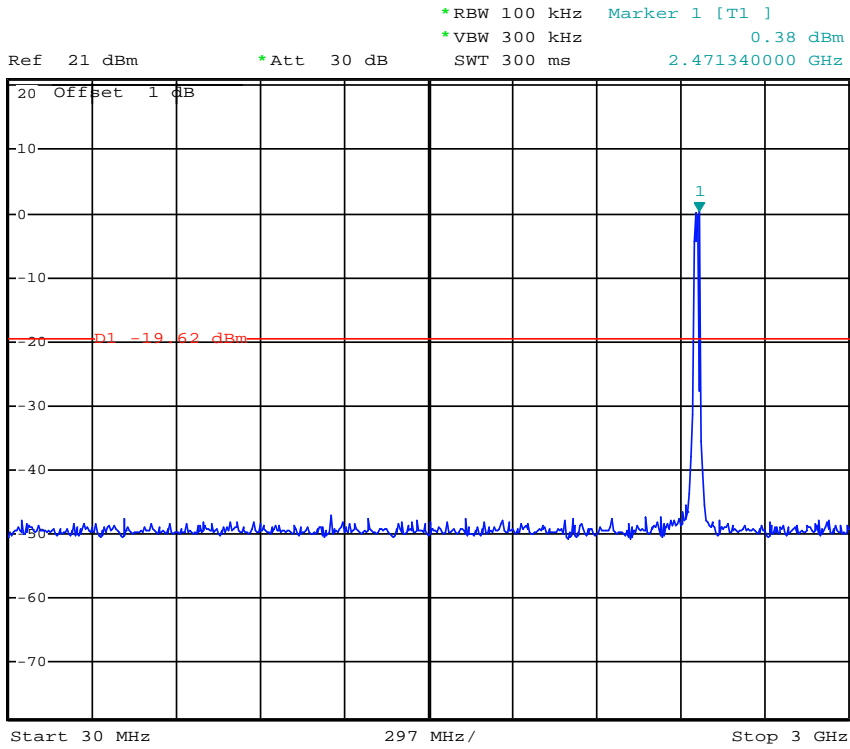

Date: 10.JAN.2014 18:52:16

(Plot 4.6.3 C1: Channel 11: 2462MHz @ 802.11n(20MHz))

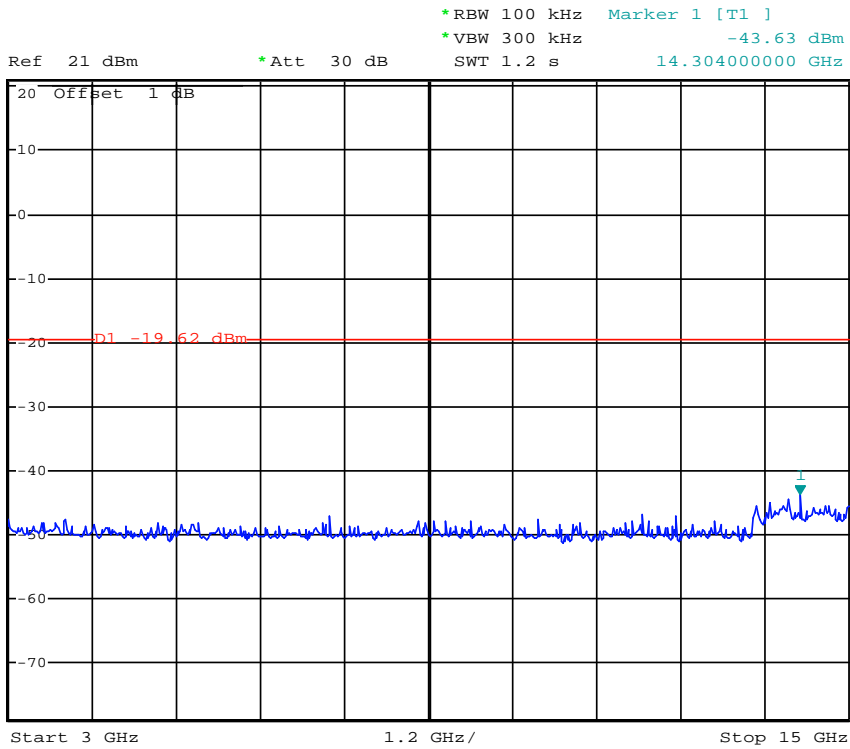

Date: 10.JAN.2014 18:52:28

(Plot 4.6.3 C2: Channel 11: 2462MHz @ 802.11n(20MHz))



\*RBW 100 kHz Marker 1 [T1 ]  
\*VBW 300 kHz -43.01 dBm  
SWT 1 s 24.92000000 GHz

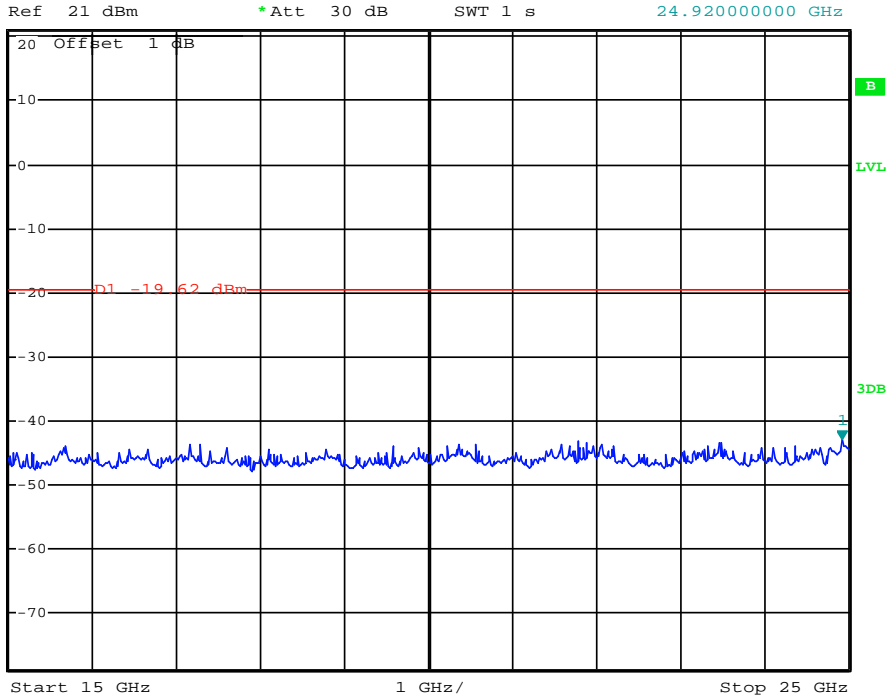

Date: 10.JAN.2014 18:52:40

(Plot 4.6.3 C3: Channel 11: 2462MHz @ 802.11n(20MHz))



\*RBW 100 kHz Marker 1 [T1 ]  
\*VBW 300 kHz 2.43 dBm  
SWT 15 ms 2.410800000 GHz

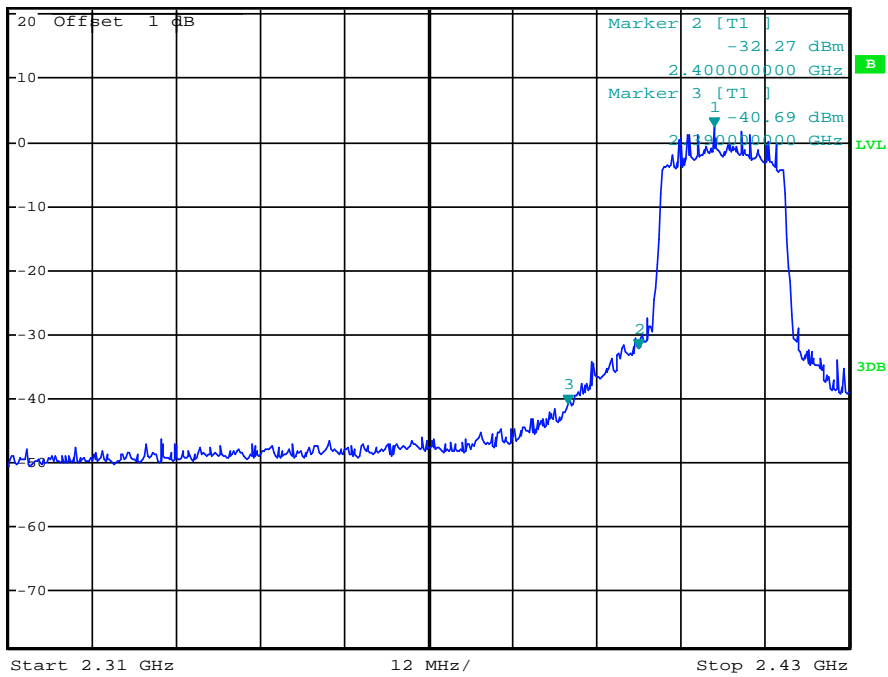

Date: 10.JAN.2014 18:10:13

(Plot 4.6.3 D: Channel 1: 2412MHz @ 802.11n(20MHz))

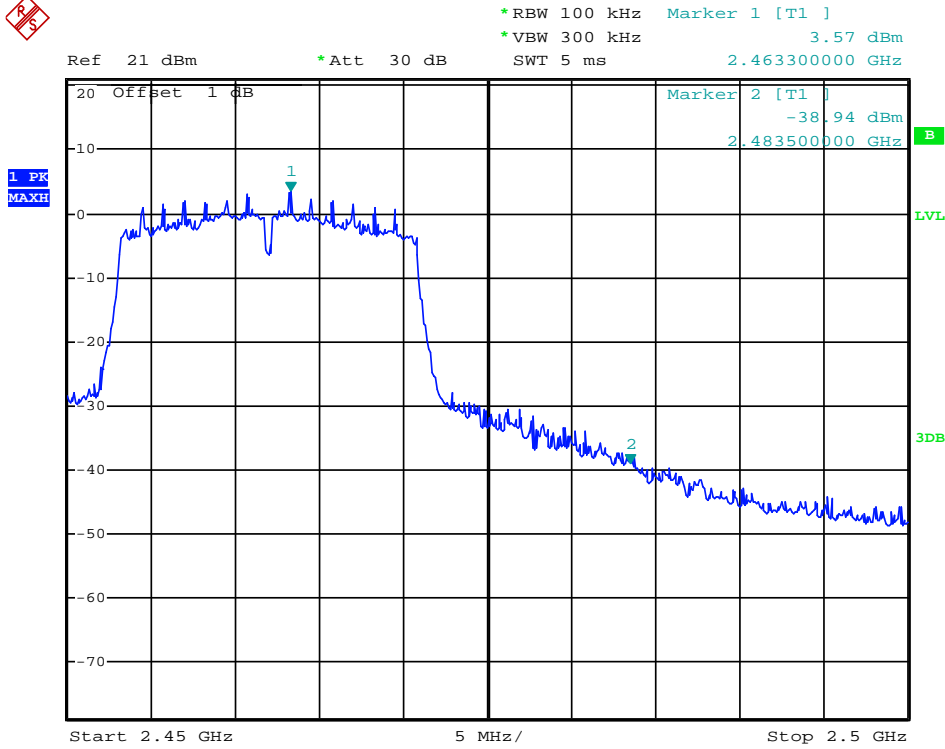

Date: 10.JAN.2014 18:12:34

(Plot 4.6.3 E: Channel 11: 2462MHz @ 802.11n(20MHz))

**4.6.4 802.11n(40MHz) Test Mode**

**A. Test Verdict**

Channel	Frequency (MHz)	Refer to Plot	Limit (dBc)	Verdict
3	2422	Plot 4.6.4 A1	-20	PASS
		Plot 4.6.4 A2	-20	PASS
		Plot 4.6.4 A3	-20	PASS
6	2437	Plot 4.6.4 B1	-20	PASS
		Plot 4.6.4 B2	-20	PASS
		Plot 4.6.4 B3	-20	PASS
9	2452	Plot 4.6.4 C1	-20	PASS
		Plot 4.6.4 C2	-20	PASS
		Plot 4.6.4 C3	-20	PASS

Frequency (MHz)	Delta Peak to Band emission (dBc)	Detector	Limit (dBc)	Refer to Plot	Verdict
2400.00	-34.34	Peak	-20	Plot 4.6.3 D	PASS
2483.50	-38.20	Peak	-20	Plot 4.6.3 E	PASS

Note: 1. For 802.11n(40MHz) mode at final test to get the worst-case emission at 13.5Mbps.  
 2. The test results including the cable lose.

**B. Test Plots**

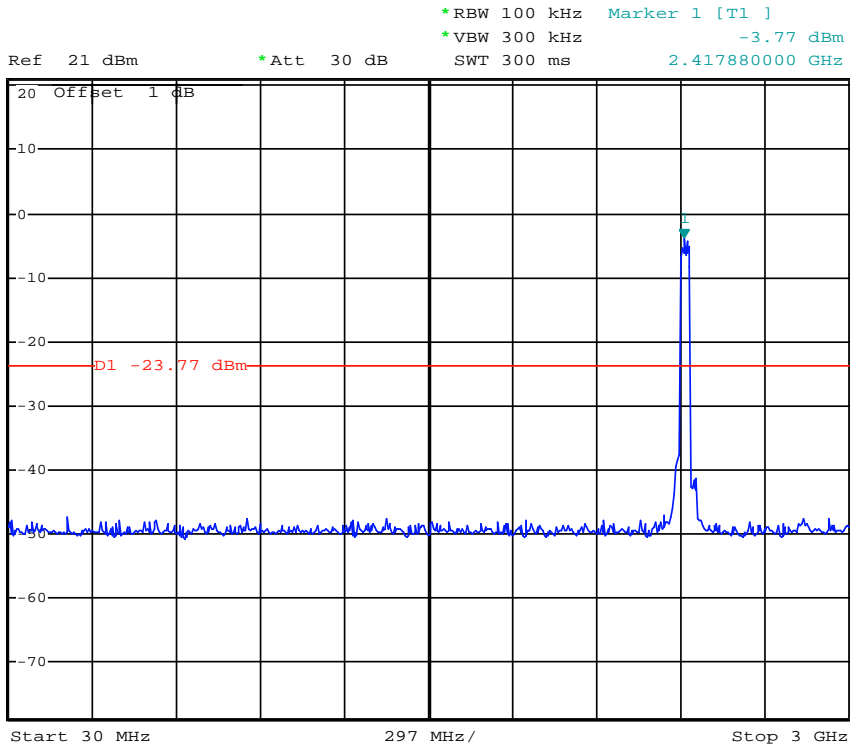

Date: 10.JAN.2014 18:53:20

(Plot 4.6.4 A1: Channel 3: 2422MHz @ 802.11n(40MHz))

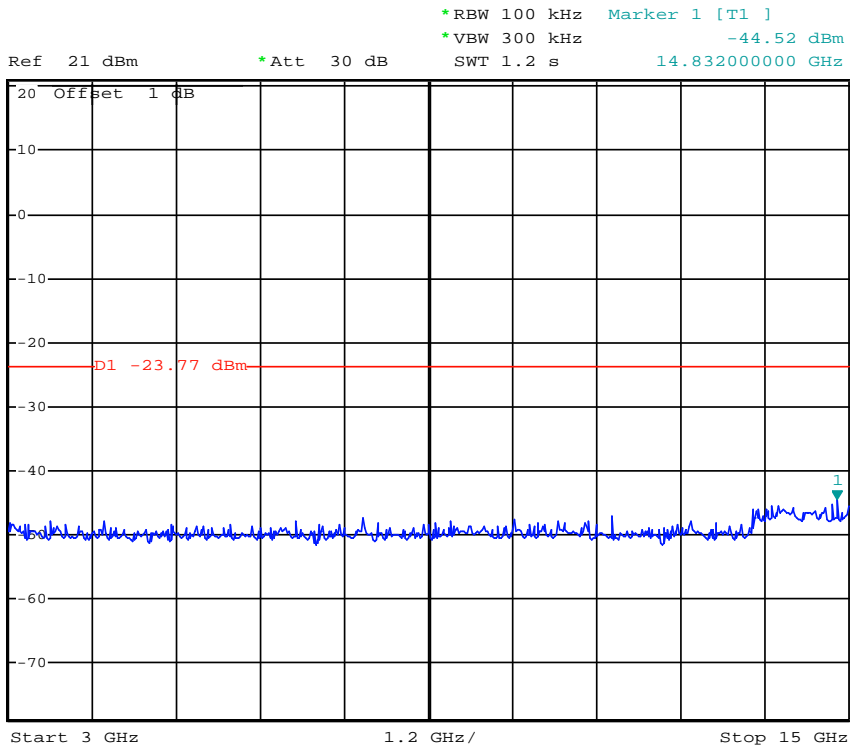

Date: 10.JAN.2014 18:53:33

(Plot 4.6.4 A2: Channel 3: 2422MHz @ 802.11n(40MHz))



\*RBW 100 kHz Marker 1 [T1 ]  
\*VBW 300 kHz -43.29 dBm  
SWT 1 s 21.64000000 GHz

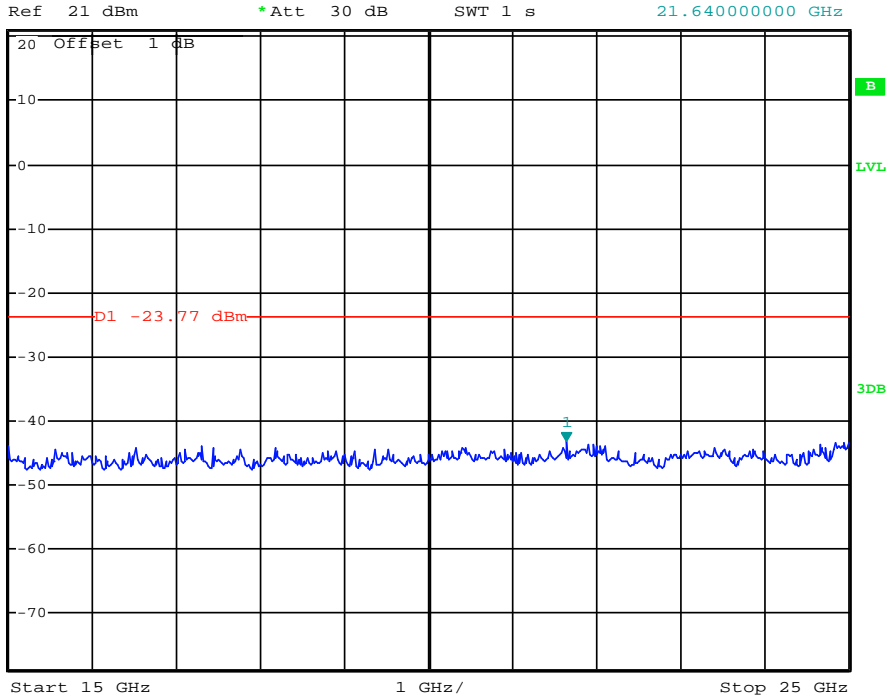

Date: 10.JAN.2014 18:53:44

(Plot 4.6.4 A3: Channel 3: 2422MHz @ 802.11n(40MHz))



\*RBW 100 kHz Marker 1 [T1 ]  
\*VBW 300 kHz -2.27 dBm  
SWT 300 ms 2.429760000 GHz

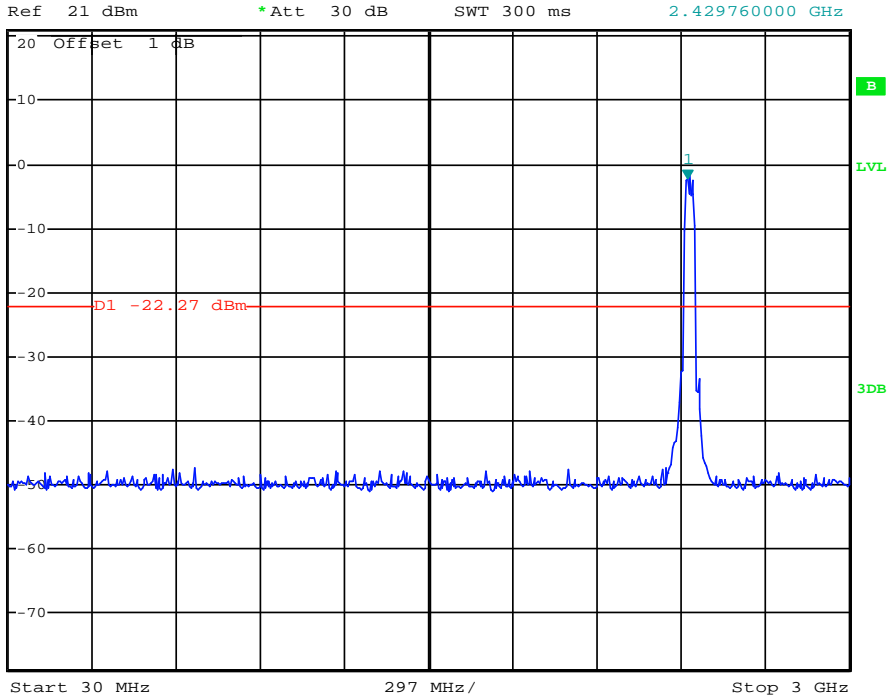

Date: 10.JAN.2014 18:54:07

(Plot 4.6.4 B1: Channel 6: 2437MHz @ 802.11n(40MHz))



\*RBW 100 kHz Marker 1 [T1 ]  
\*VBW 300 kHz -44.48 dBm  
SWT 1.2 s 14.064000000 GHz

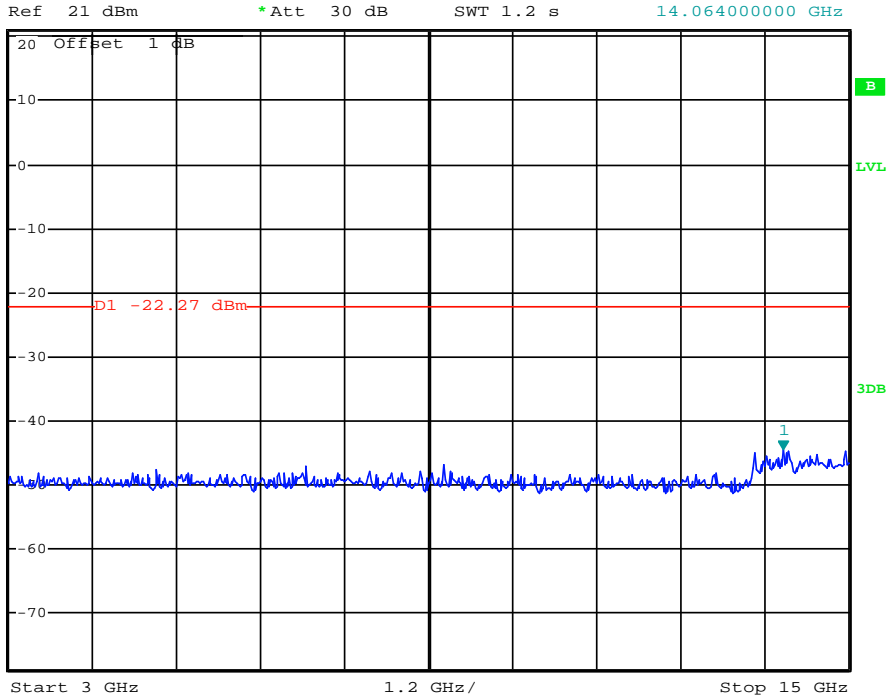

Date: 10.JAN.2014 18:54:20

(Plot 4.6.4 B2: Channel 6: 2437MHz @ 802.11n(40MHz))



\*RBW 100 kHz Marker 1 [T1 ]  
\*VBW 300 kHz -42.89 dBm  
SWT 1 s 21.820000000 GHz

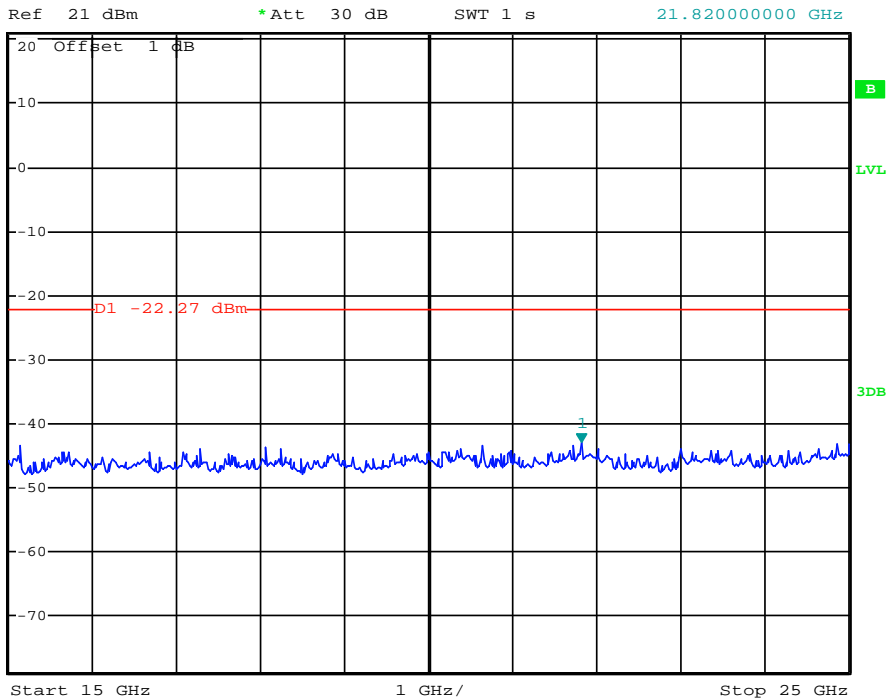

Date: 10.JAN.2014 18:54:30

(Plot 4.6.4 B3: Channel 6: 2437MHz @ 802.11n(40MHz))



\*RBW 100 kHz Marker 1 [T1 ]  
\*VBW 300 kHz -3.12 dBm  
SWT 300 ms 2.447580000 GHz

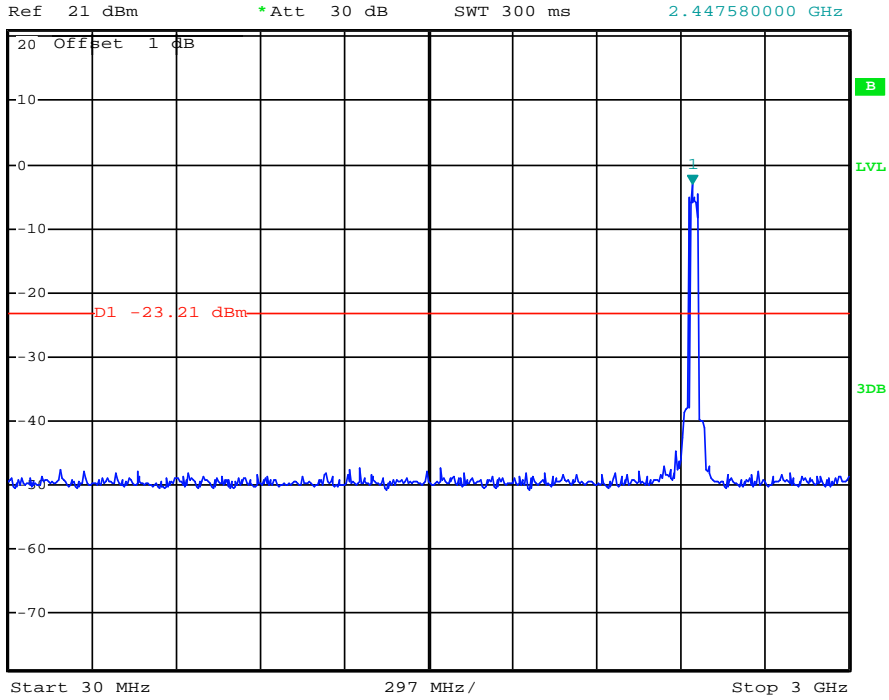

Date: 10.JAN.2014 18:54:59

(Plot 4.6.4 C1: Channel 9: 2452MHz @ 802.11n(40MHz))



\*RBW 100 kHz Marker 1 [T1 ]  
\*VBW 300 kHz -44.34 dBm  
SWT 1.2 s 15.000000000 GHz

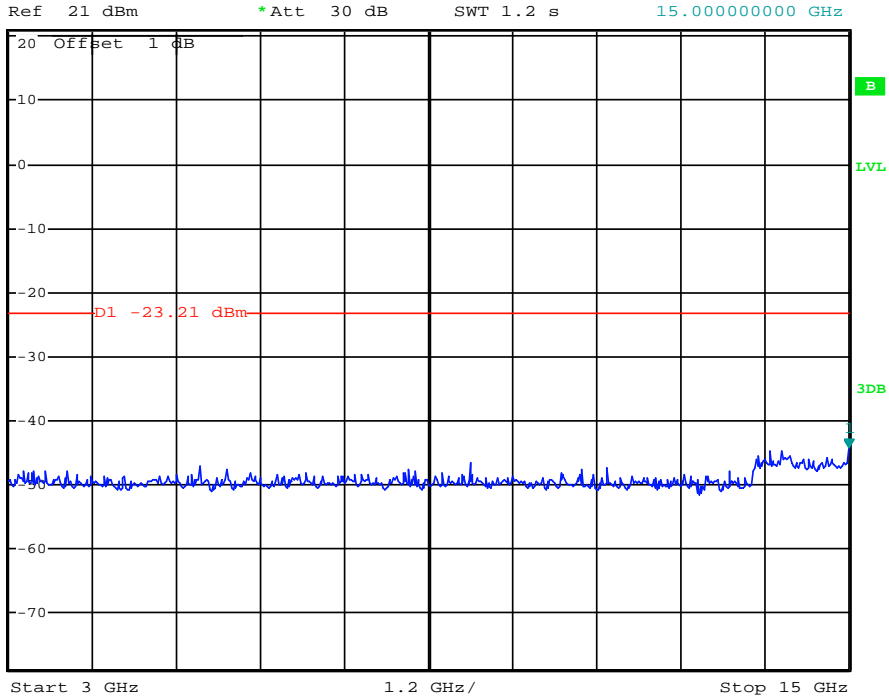

Date: 10.JAN.2014 18:55:11

(Plot 4.6.4 C2: Channel 9: 2452MHz @ 802.11n(40MHz))





\*RBW 100 kHz Marker 1 [T1 ]  
\*VBW 300 kHz -42.09 dBm  
SWT 1 s 20.52000000 GHz

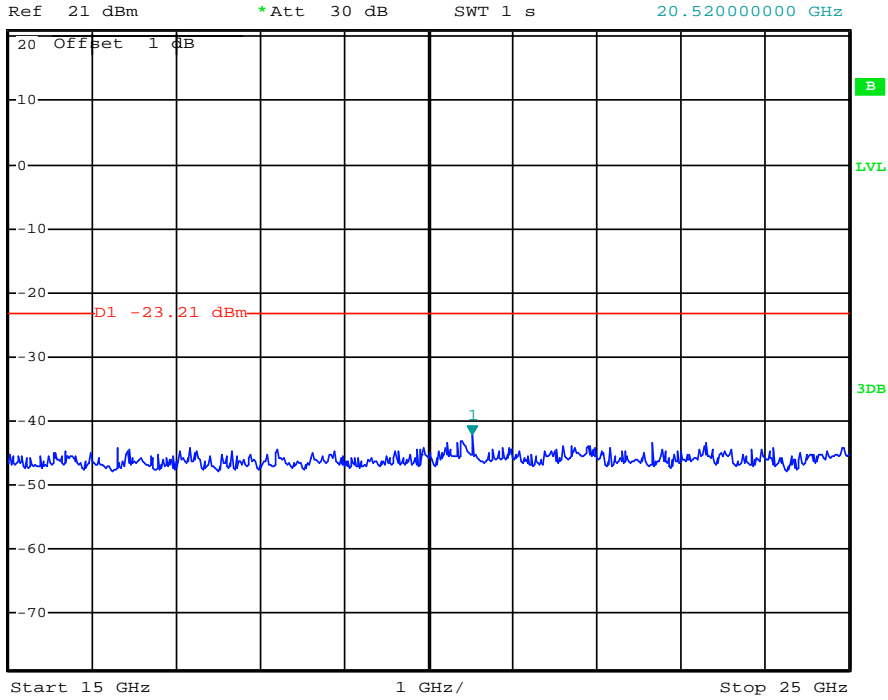

Date: 10.JAN.2014 18:55:20

(Plot 4.6.4 C3: Channel 9: 2452MHz @ 802.11n(40MHz))



\*RBW 100 kHz Marker 3 [T1 ]  
\*VBW 300 kHz -37.91 dBm  
SWT 15 ms 2.390000000 GHz

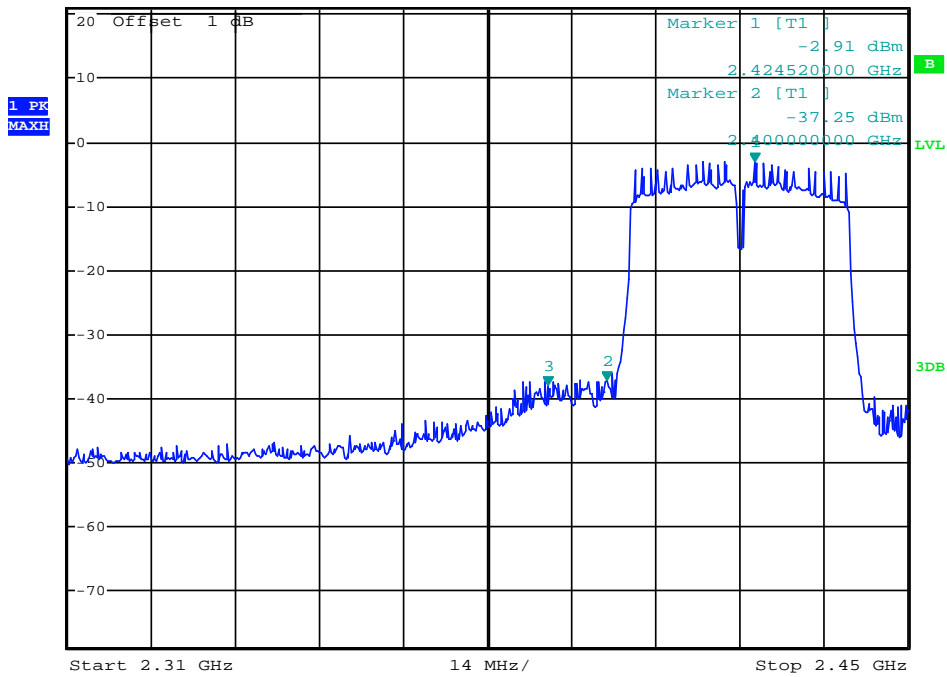

Date: 10.JAN.2014 18:13:28

(Plot 4.6.4 D: Channel 3: 2422MHz @ 802.11n(40MHz))



\*RBW 100 kHz    Marker 2 [T1 ]  
\*VBW 300 kHz    -40.85 dBm  
SWT 10 ms        2.483500000 GHz

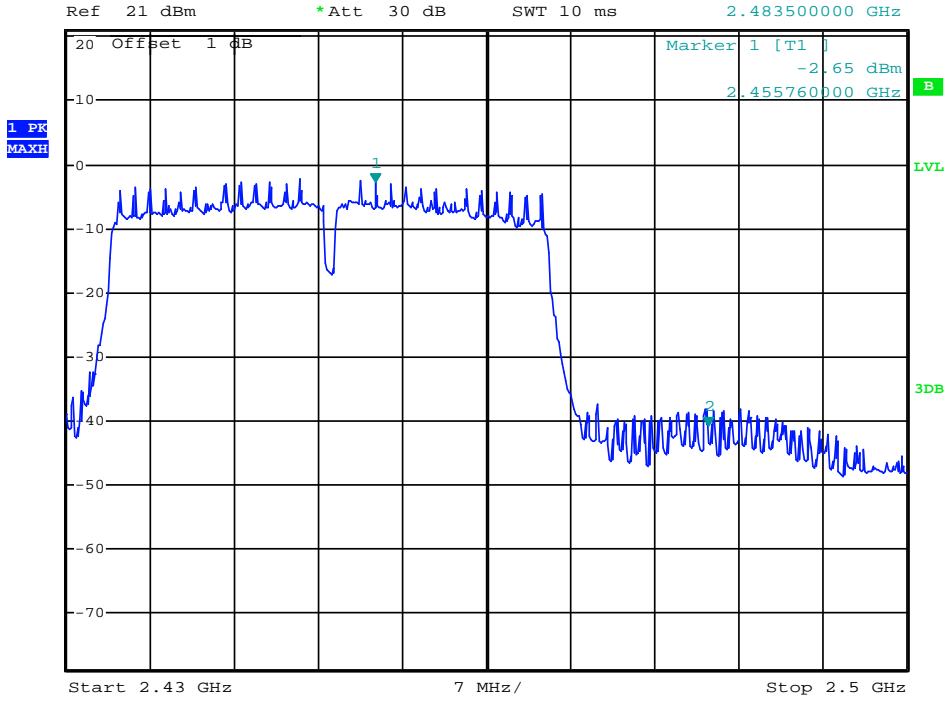

Date: 10.JAN.2014 18:14:16

(Plot 4.6.4 E: Channel 9: 2452MHz @ 802.11n(40MHz))

## 4.7. 6dB Bandwidth

### TEST CONFIGURATION

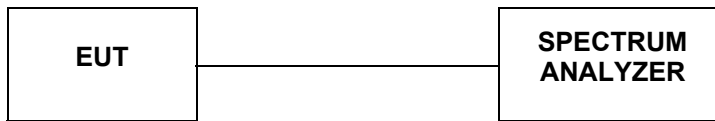

### TEST PROCEDURE

The transmitter output was connected to the spectrum analyzer through an attenuator. The bandwidth of the fundamental frequency was measured by spectrum analyzer with 100 KHz RBW and 300KHz VBW. The 6dB bandwidth is defined as the total spectrum the power of which is higher than peak power minus 6dB. According to KDB558074 D01 V03 for one of the following procedures may be used to determine the modulated DTS device signal bandwidth.

1. Set RBW = 100 kHz.
2. Set the video bandwidth (VBW)  $\geq 3$  RBW.
3. Detector = Peak.
4. Trace mode = max hold.
5. Sweep = auto couple.
6. Allow the trace to stabilize.
7. Measure the maximum width of the emission that is constrained by the frequencies associated with the two outermost amplitude points (upper and lower frequencies) that are attenuated by 6 dB relative to the maximum level measured in the fundamental emission.

### LIMIT

For digital modulation systems, the minimum 6 dB bandwidth shall be at least 500 kHz.

### TEST RESULTS

#### 4.7.1 801.11b Test Mode

##### A. Test Verdict

Channel	Frequency (MHz)	6 dB Bandwidth (MHz)	Refer to Plot	Limits (kHz)	Verdict
1	2412	10.08	Plot 4.7.1 A	$\geq 500$	PASS
6	2437	10.08	Plot 4.7.1 B	$\geq 500$	PASS
11	2462	10.08	Plot 4.7.1 C	$\geq 500$	PASS

Note: 1. For 802.11b mode at final test to get the worst-case emission at 1Mbps.  
2. The test results including the cable loss.

##### B. Test Plots

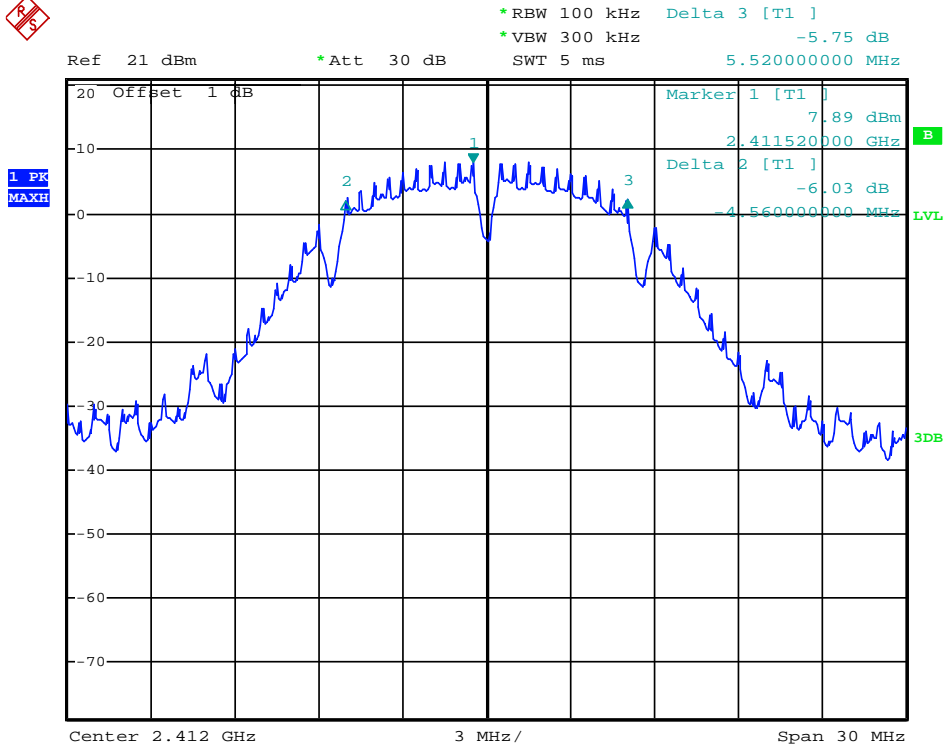

Date: 10.JAN.2014 17:26:36

(Plot 4.7.1 A: Channel 1: 2412MHz @ 802.11b)

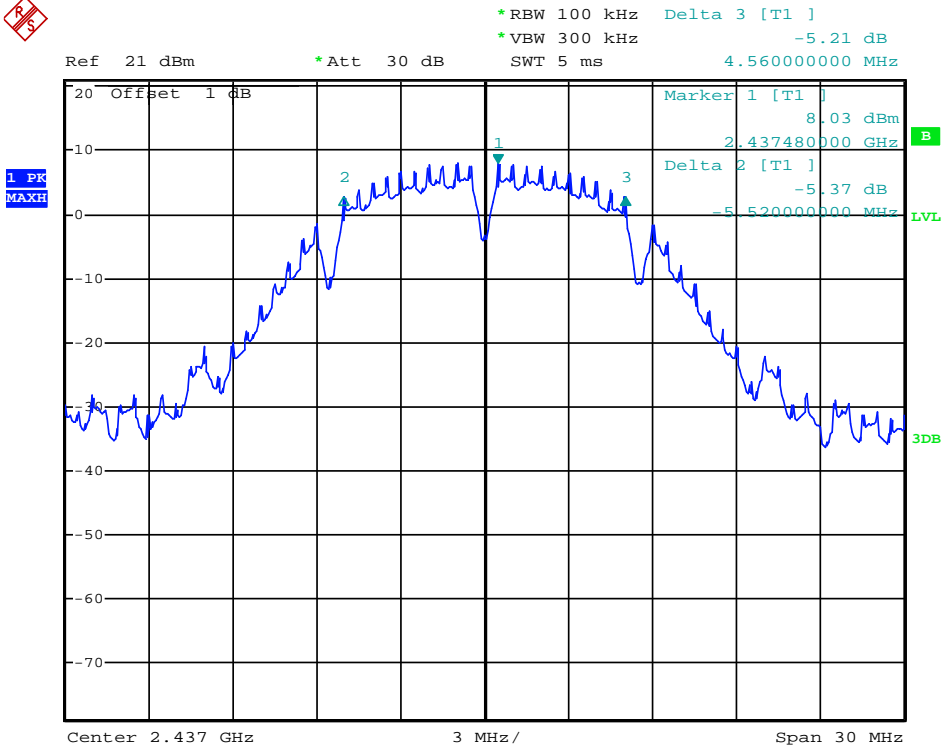

Date: 10.JAN.2014 17:27:13

(Plot 4.7.1 B: Channel 6: 2437MHz @ 802.11b)

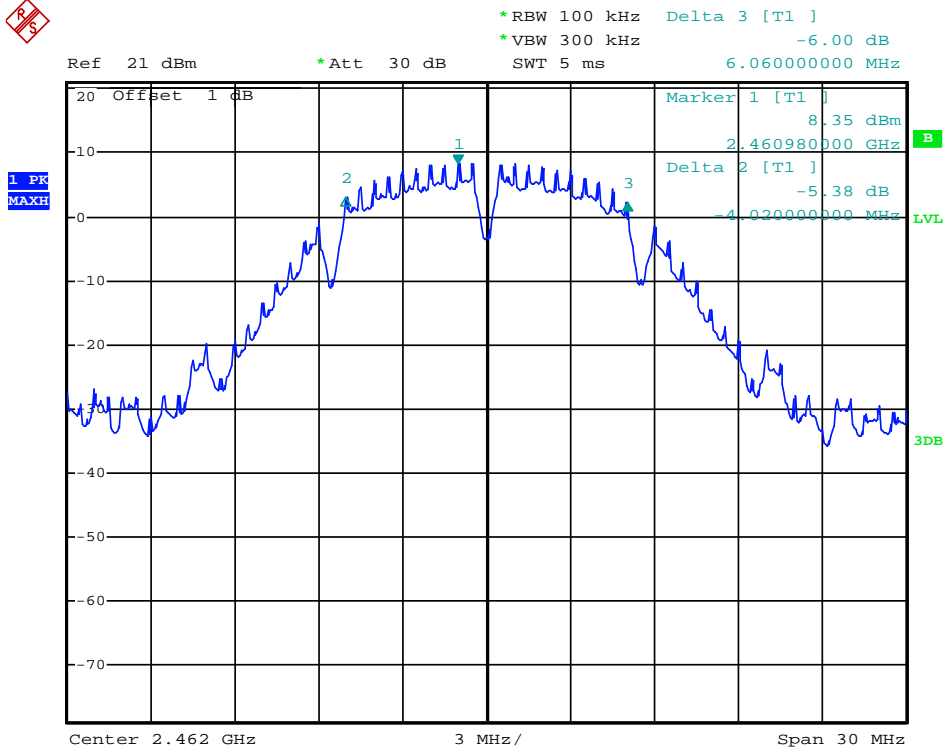

Date: 10.JAN.2014 17:27:51

(Plot 4.7.1 C: Channel 11: 2462MHz @ 802.11b)

**4.7.2 801.11g Test Mode**

**A. Test Verdict**

Channel	Frequency (MHz)	6 dB Bandwidth (MHz)	Refer to Plot	Limits (kHz)	Verdict
1	2412	15.64	Plot 4.7.2 A	≥500	PASS
6	2437	15.60	Plot 4.7.2 B	≥500	PASS
11	2462	15.60	Plot 4.7.2 C	≥500	PASS

Note: 1. For 802.11g mode at final test to get the worst-case emission at 6Mbps.  
 2. The test results including the cable lose.

**B. Test Plots**



Ref 21 dBm \*Att 30 dB \*RBW 100 kHz Delta 3 [T1 ]  
\*VBW 300 kHz -6.12 dB  
SWT 5 ms 6.480000000 MHz

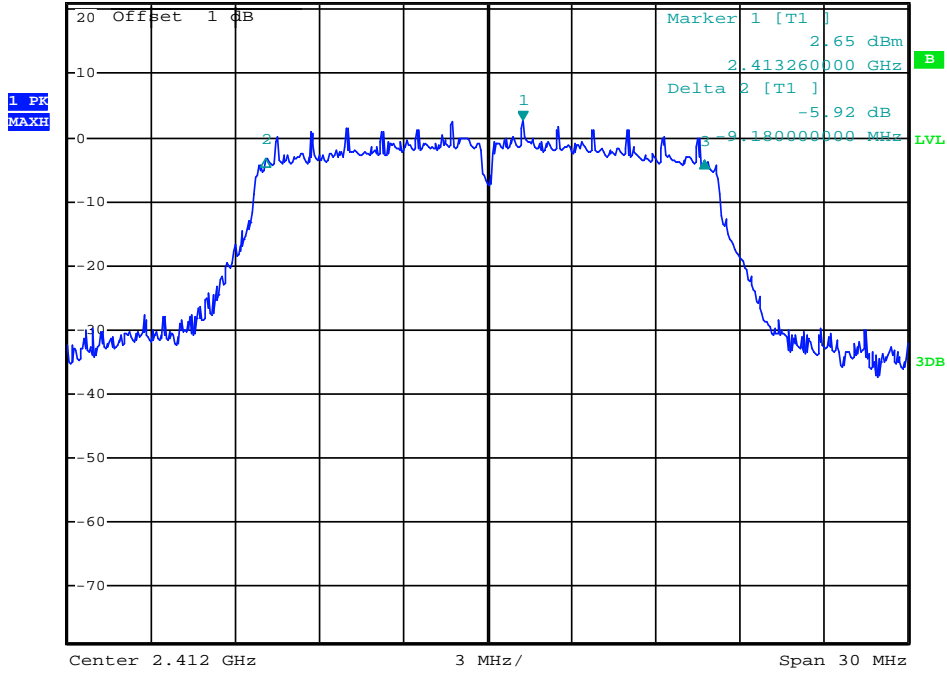

Date: 10.JAN.2014 17:29:14

(Plot 4.7.2 A: Channel 1: 2412MHz @ 802.11g)



Ref 21 dBm \*Att 30 dB \*RBW 100 kHz Delta 3 [T1 ]  
\*VBW 300 kHz -6.40 dB  
SWT 5 ms 6.480000000 MHz

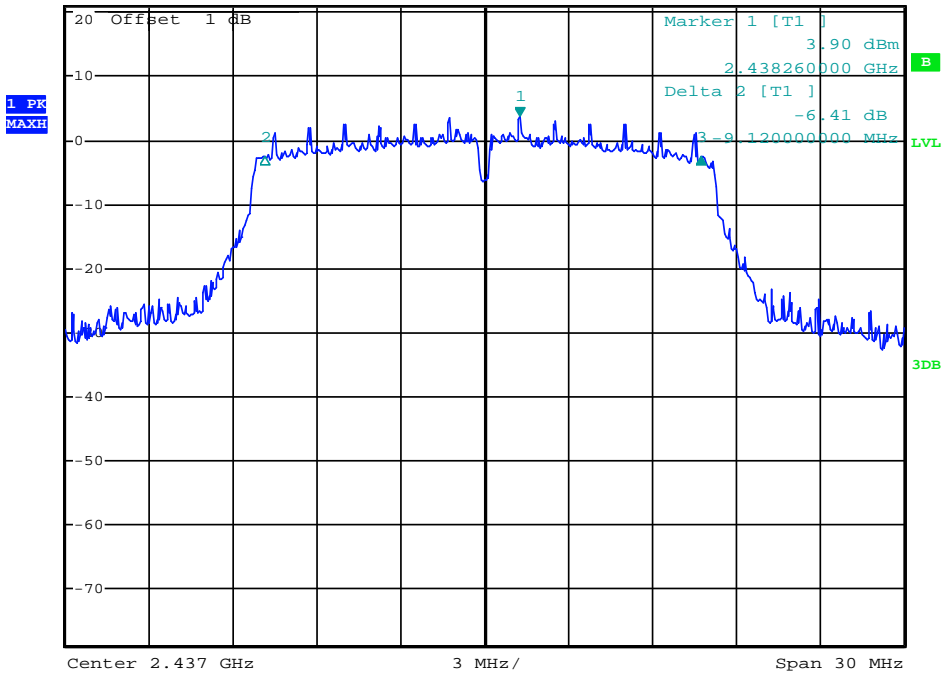

Date: 10.JAN.2014 17:30:38

(Plot 4.7.2 B: Channel 6: 2437MHz @ 802.11g)

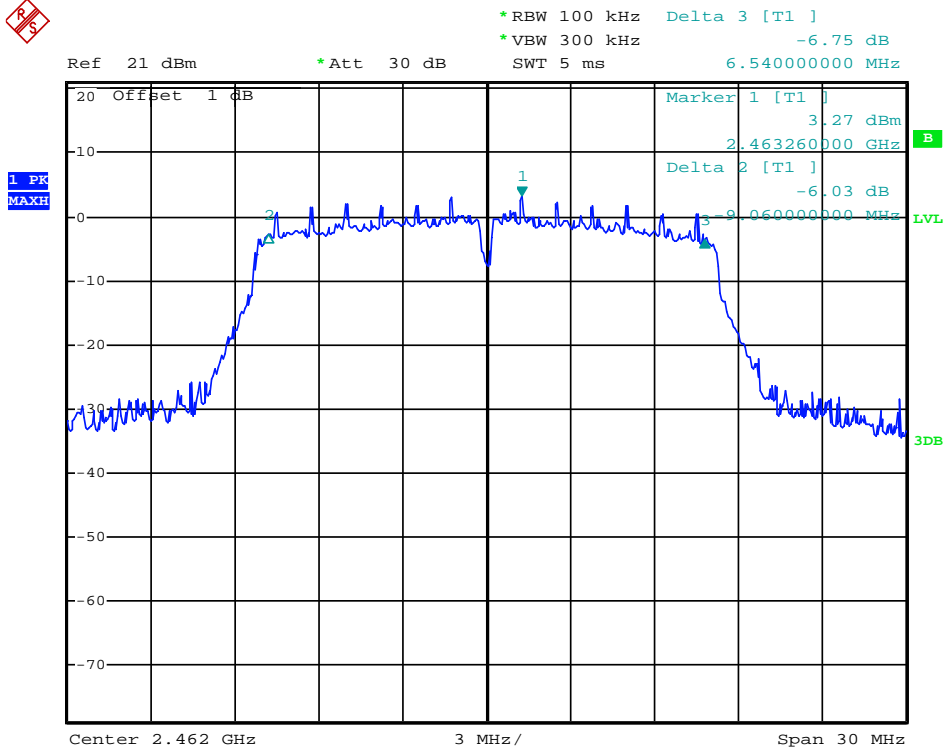

Date: 10.JAN.2014 17:31:38

(Plot 4.7.2 C: Channel 11: 2462MHz @ 802.11g)

**4.7.3 801.11n(20MHz) Test Mode**

**A. Test Verdict**

Channel	Frequency (MHz)	6 dB Bandwidth (MHz)	Refer to Plot	Limits (kHz)	Verdict
1	2412	17.10	Plot 4.7.3 A	≥500	PASS
6	2437	17.10	Plot 4.7.3 B	≥500	PASS
11	2462	17.04	Plot 4.7.3 C	≥500	PASS

Note: 1. For 802.11n(20MHz) mode at final test to get the worst-case emission at 6.5Mbps.  
 2. The test results including the cable lose.

**B. Test Plots**

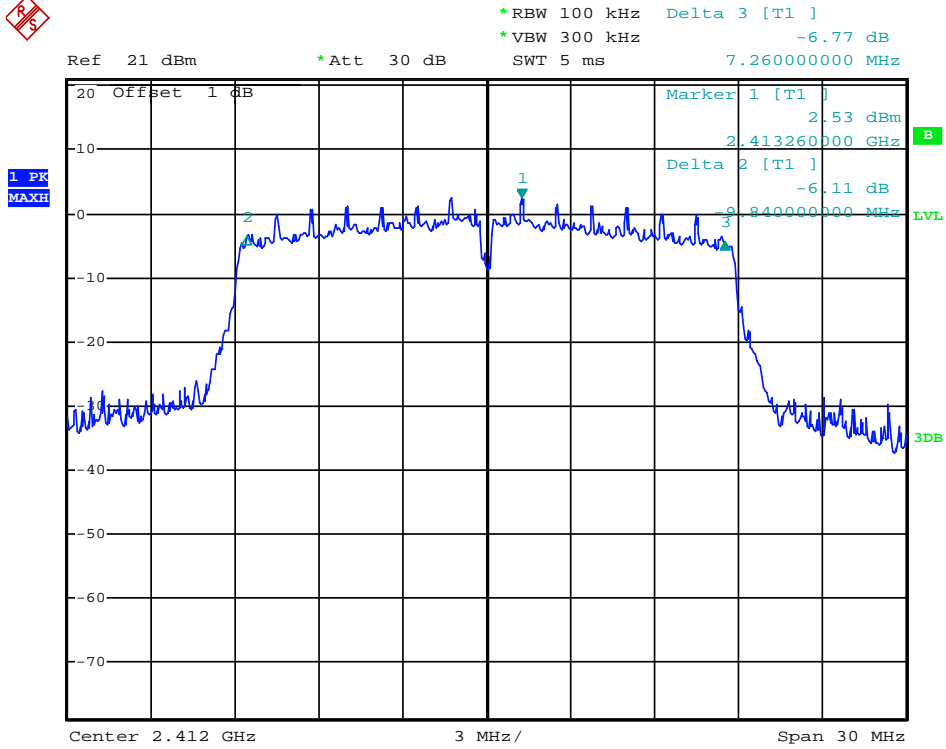

Date: 10.JAN.2014 17:32:41

(Plot 4.7.3 A: Channel 1: 2412MHz @ 802.11n(20MHz))

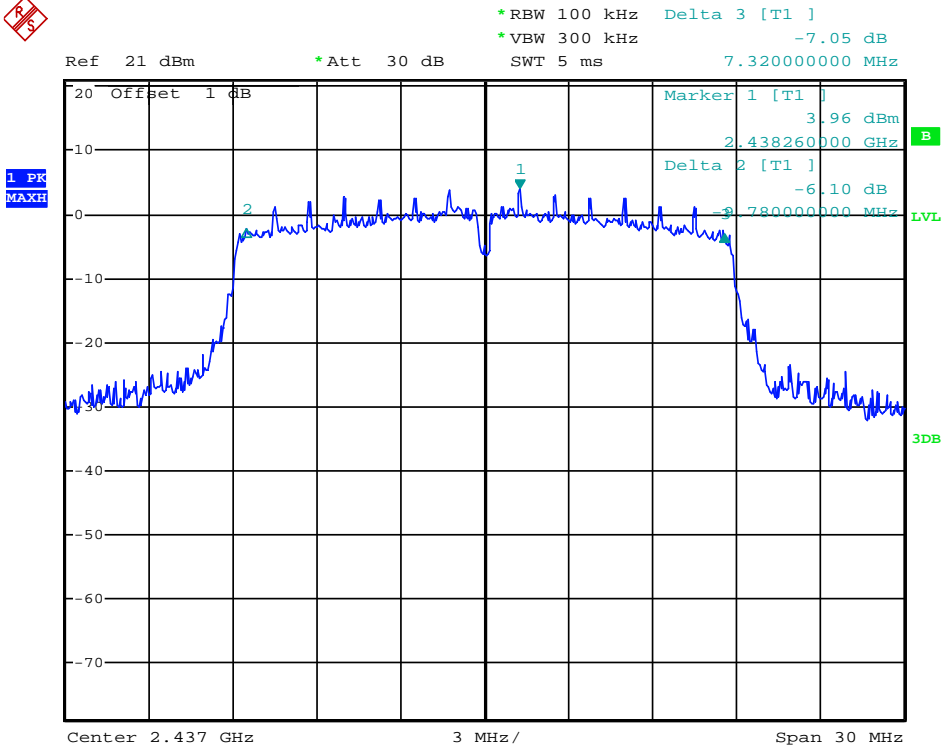

Date: 10.JAN.2014 17:33:29

(Plot 4.7.3 B: Channel 6: 2437MHz @ 802.11n(20MHz))



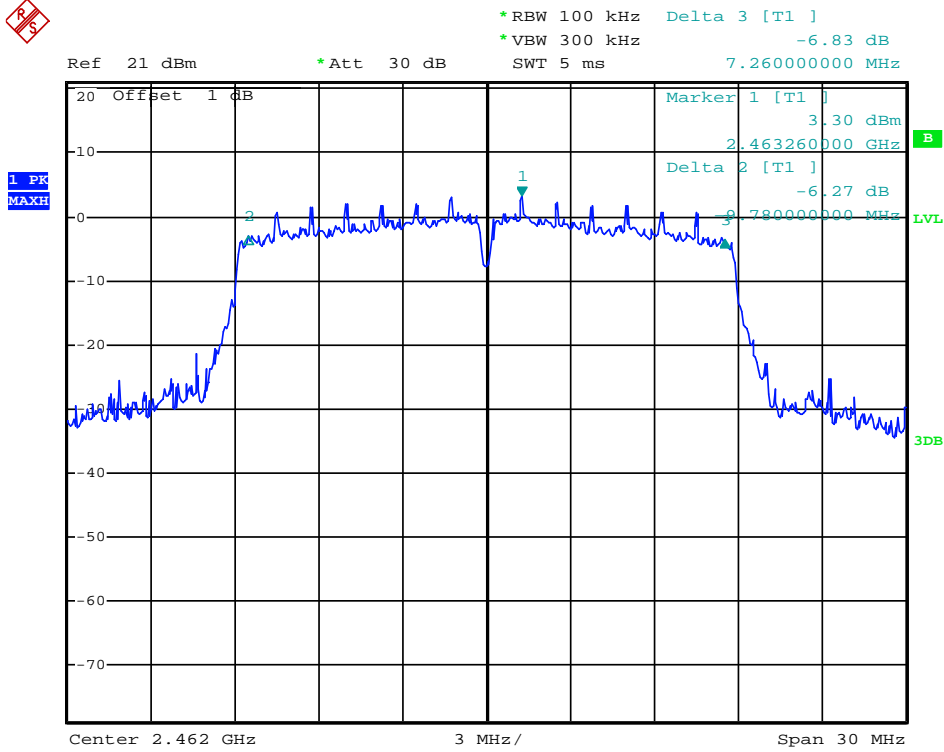

Date: 10.JAN.2014 17:34:22

(Plot 4.7.3 C: Channel 11: 2462MHz @ 802.11n(20MHz))

**4.7.4 801.11n(40MHz) Test Mode**

**A. Test Verdict**

Channel	Frequency (MHz)	6 dB Bandwidth (MHz)	Refer to Plot	Limits (kHz)	Verdict
3	2422	35.60	Plot 4.7.4 A	≥500	PASS
6	2437	35.60	Plot 4.7.4 B	≥500	PASS
9	2452	35.60	Plot 4.7.4 C	≥500	PASS

Note: 1. For 802.11n(40MHz) mode at final test to get the worst-case emission at 13.5Mbps.  
 2. The test results including the cable lose.

**B. Test Plots**

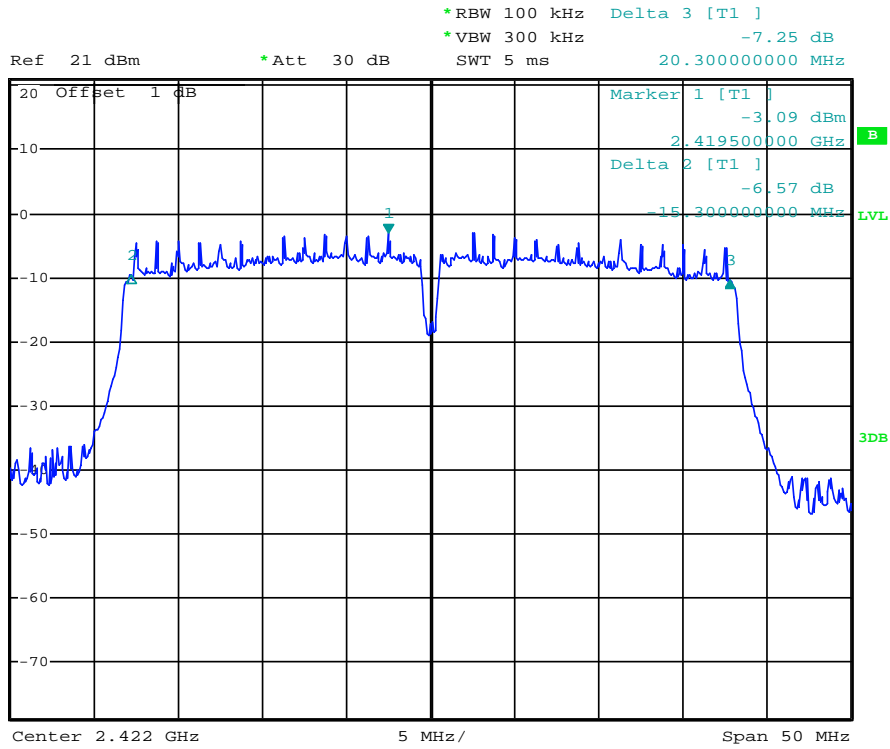

Date: 10.JAN.2014 17:35:17

(Plot 4.7.4 A: Channel 3: 2422MHz @ 802.11n(40MHz))

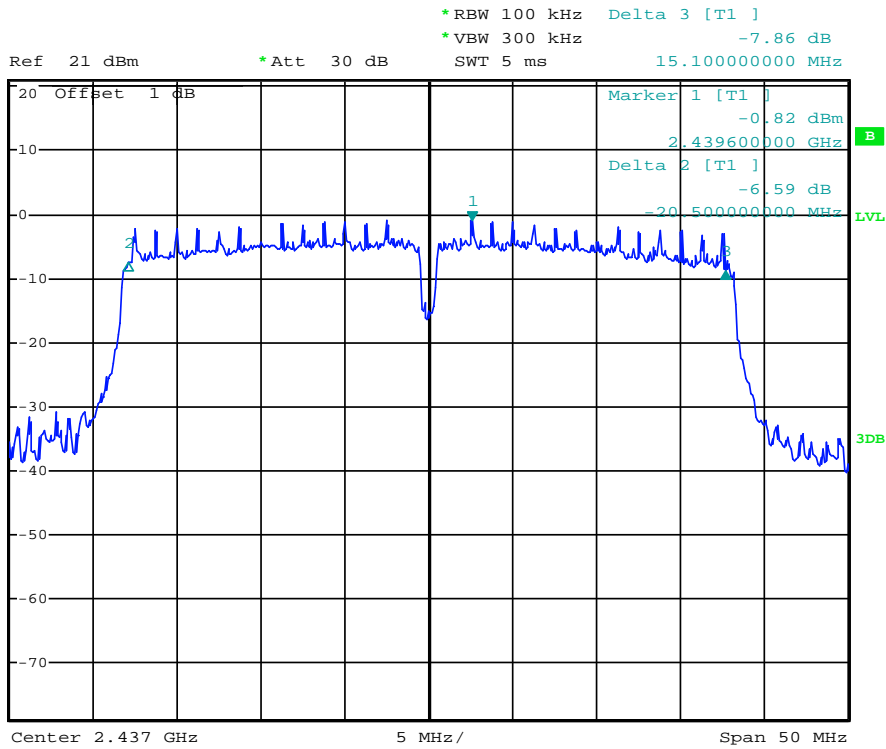

Date: 10.JAN.2014 17:35:59

(Plot 4.7.3 B: Channel 6: 2437MHz @ 802.11n(40MHz))



\*RBW 100 kHz Delta 3 [T1 ]  
\*VBW 300 kHz -7.37 dB  
SWT 5 ms 15.300000000 MHz

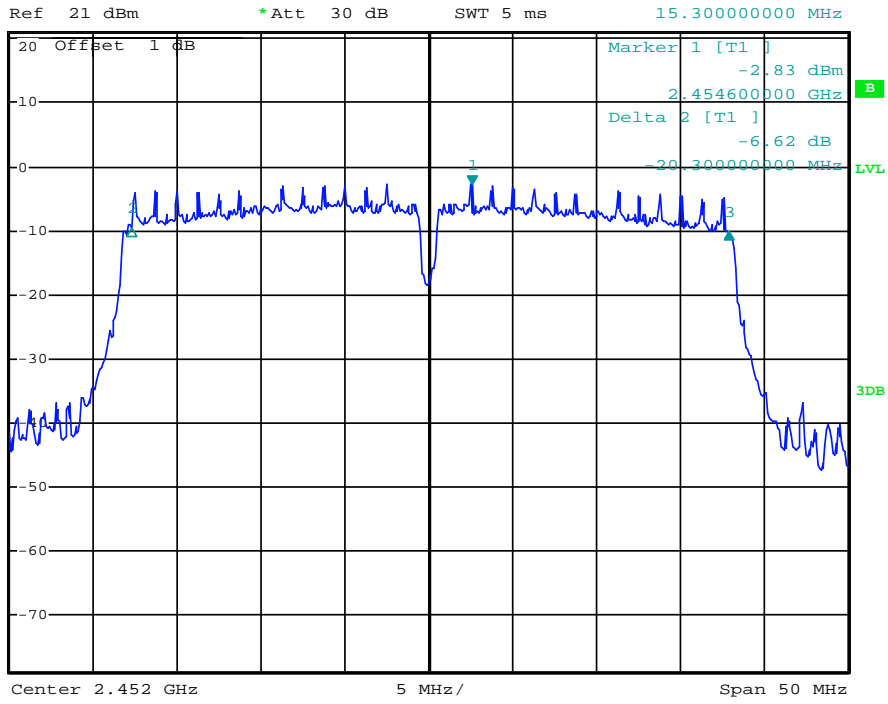

Date: 10.JAN.2014 17:36:35

(Plot 4.7.4 C: Channel 9: 2452MHz @ 802.11n(40MHz))

## 4.8. Antenna Requirement

### Standard Applicable

For intentional device, according to FCC 47 CFR Section 15.203, an intentional radiator shall be designed to ensure that no antenna other than that furnished by the responsible party shall be used with the device.

And according to FCC 47 CFR Section 15.247 (c), if transmitting antennas of directional gain greater than 6dBi are used, the power shall be reduced by the amount in dB that the directional gain of the antenna exceeds 6dBi.

### Refer to statement below for compliance

The manufacturer may design the unit so that the user can replace a broken antenna, but the use of a standard antenna jack or electrical connector is prohibited. Further, this requirement does not apply to intentional radiators that must be professionally installed.

### Antenna Connected Construction

The WLAN and Bluetooth sharing same antenna and the maximum antenna gain of WLAN used was 0.40 dBi.



## 5. Test Setup Photos of the EUT

Radiated Emission (30MHz-1GHz)



Radiated Emission (above 1GHz)



Radiated Emission (Below 30MHz)



Conducted Emission (AC Mains)



## 6. External and Internal Photos of the EUT

### External photos of the EUT











**Internal photos of the EUT**

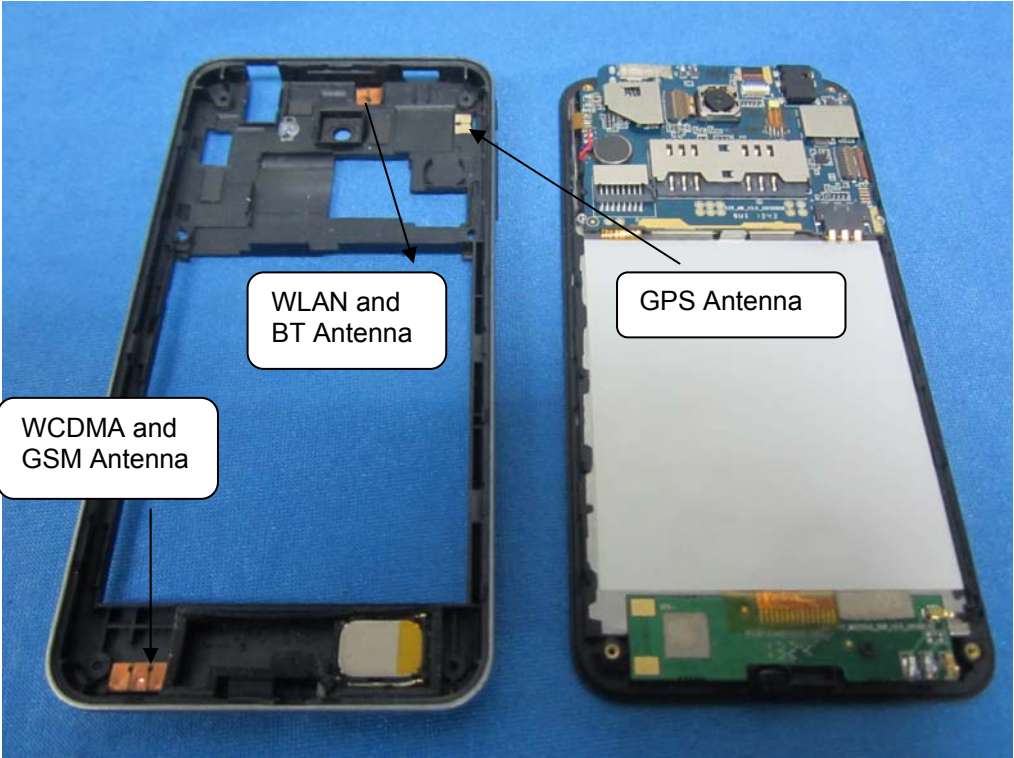



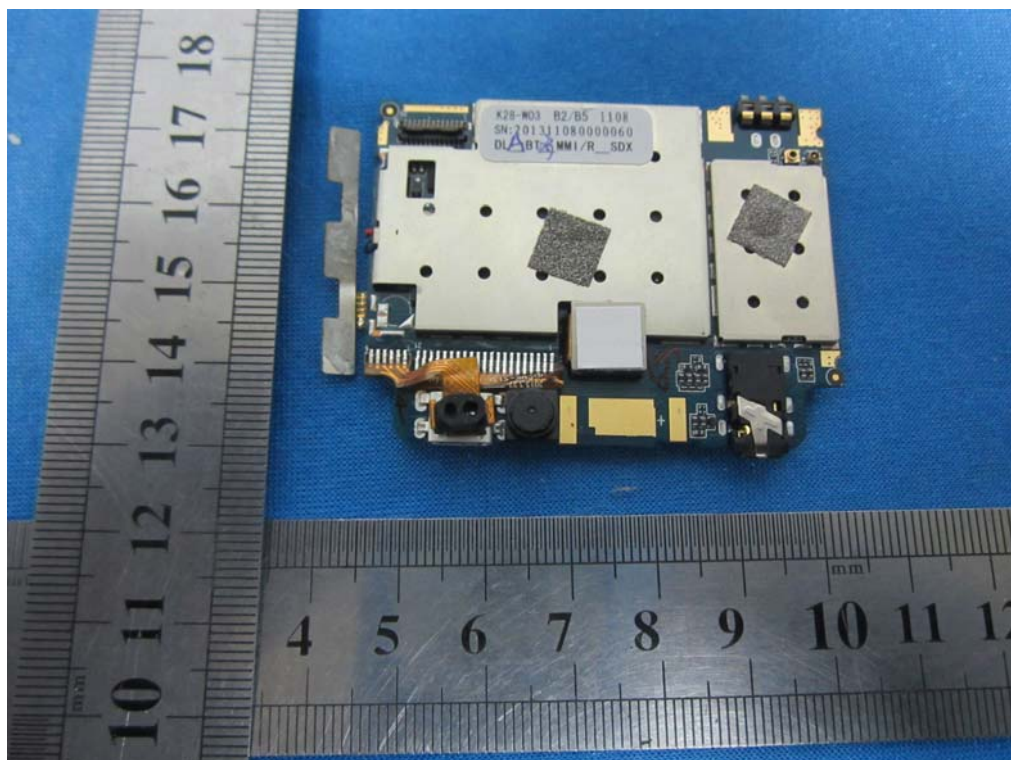
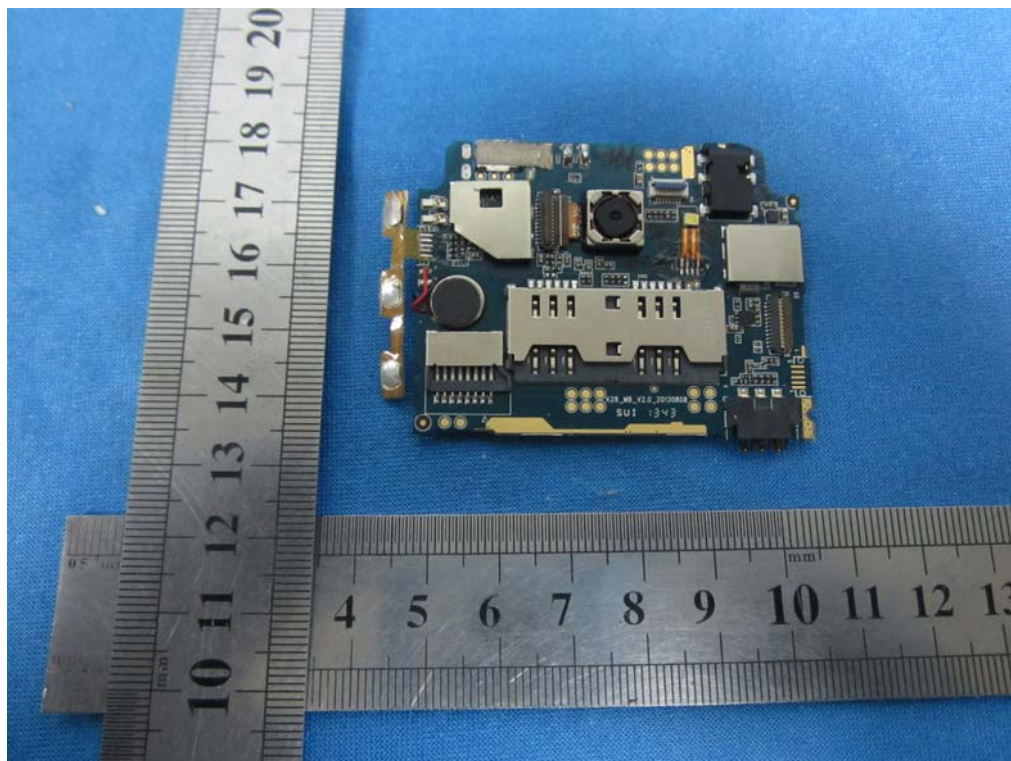

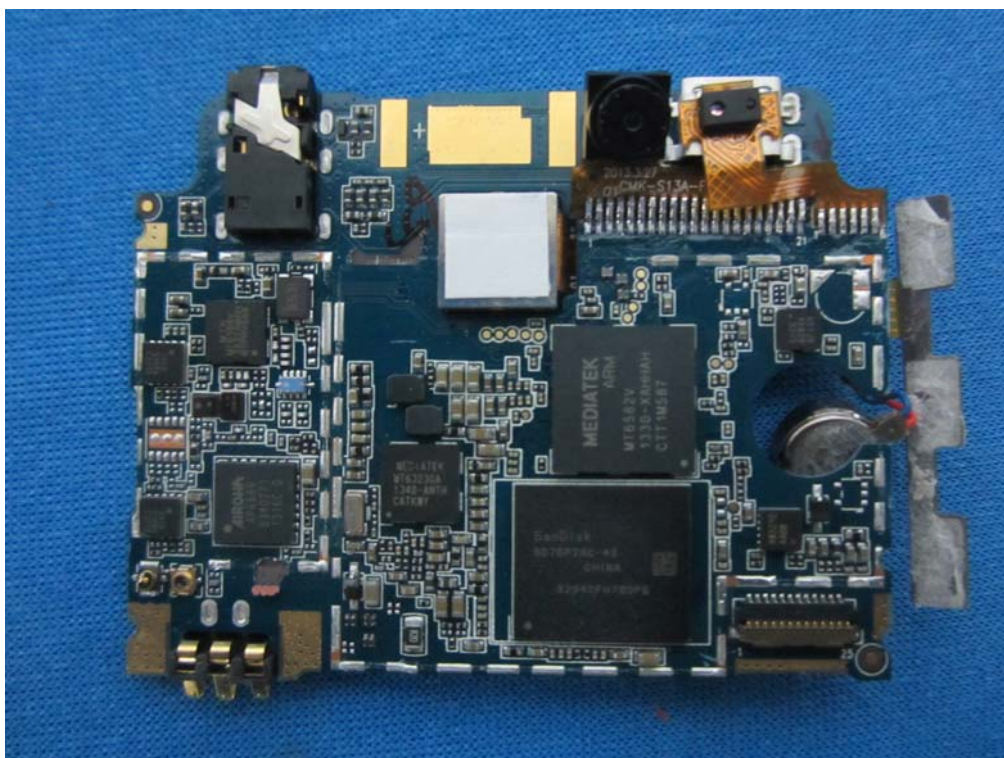
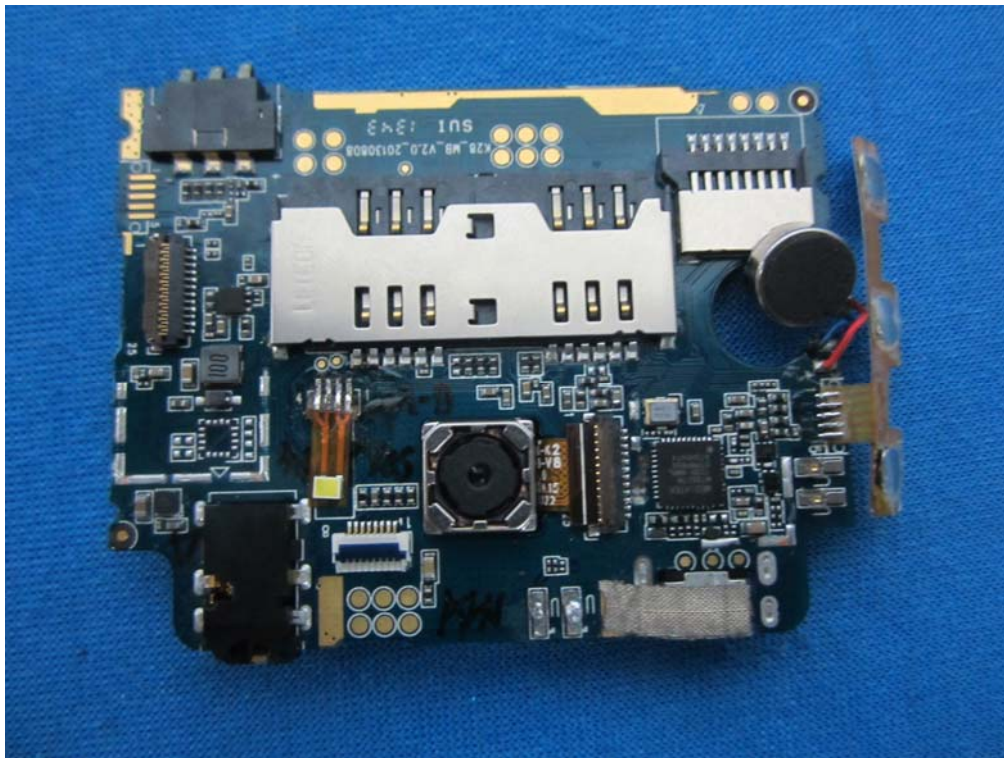

.....End of Report.....