



FCC PART 15 SUBPART C TEST REPORT

FCC PART 15.247

Report Reference No......: **TRE1401002104 R/C: 88877**

FCC ID..... : **YPVITALCOMZEUZ-HD**

Compiled by

(position+printed name+signature)..: File administrators Jerome Luo

Jerome Luo

Supervised by

(position+printed name+signature)..: Test Engineer Yuchao Wang

yuchao.wang

Approved by

(position+printed name+signature)..: Manager Wenliang Li

Wenliang Li

Date of issue.....: Jan 15, 2014

Testing Laboratory Name: **Shenzhen Huatongwei International Inspection Co., Ltd**

Address: Keji Nan No.12 Road, Hi-tech Park, Shenzhen, China

Applicant's name.....: **Star Computer Group**

Address: 2175 NORTHWEST 115TH AVE. DORAL FL 33172, USA

Test specification

Standard: **FCC Part 15.247: Operation within the bands 902-928 MHz, 2400-2483.5 MHz and 5725-5850 MHz**

TRF Originator.....: Shenzhen Huatongwei International Inspection CO., Ltd

Master TRF.....: Dated 2006-06

Shenzhen Huatongwei International Inspection Co., Ltd. All rights reserved.

This publication may be reproduced in whole or in part for non-commercial purposes as long as the Shenzhen Huatongwei International Inspection Co., Ltd is acknowledged as copyright owner and source of the material. Shenzhen Huatongwei International Inspection Co., Ltd takes no responsibility for and will not assume liability for damages resulting from the reader's interpretation of the reproduced material due to its placement and context.

Test item description

Trade Mark: NYX

Model/Type reference.....: ZEUZ-HD

Listed Models: /

Manufacturer

Modulation Type.....: GFSK,8DPSK, π /4DQPSK

Operation Frequency.....: From 2402MHz to 2480MHz

Rating: DC 3.70V

Hardware version: MT6582_K28_ZeuzHD

Software version: ZEUZ_HD_AMXNYX_V001R

Android version: 4.2.2

Result.....: **PASS**

T E S T R E P O R T

Test Report No. :	TRE1401002104	Jan 15, 2014
		Date of issue

Equipment under Test : Mobile Phone

Model /Type : ZEUZ-HD

Listed Models : /

Applicant : **ITALCOM GROUP**

Address : 1728 Coral Way,Coral Gables,Miami,Florida,United States

Manufacturer : **ITALCOM GROUP**

Address : 1728 Coral Way,Coral Gables,Miami,Florida,United States

Test Result	PASS
--------------------	-------------

The test report merely corresponds to the test sample.

It is not permitted to copy extracts of these test result without the written permission of the test laboratory.

Contents

1.	<u>TEST STANDARDS</u>	4
2.	<u>SUMMARY</u>	5
2.1.	General Remarks	5
2.2.	Product Description	5
2.3.	Equipment Under Test	5
2.4.	Short description of the Equipment under Test (EUT)	6
2.5.	EUT operation mode	6
2.6.	Internal Identification of AE used during the test	6
2.7.	Related Submittal(s) / Grant (s)	7
2.8.	Modifications	7
2.9.	NOTE	7
3.	<u>TEST ENVIRONMENT</u>	8
3.1.	Address of the test laboratory	8
3.2.	Test Facility	8
3.3.	Environmental conditions	9
3.4.	Test Description	9
3.5.	Statement of the measurement uncertainty	9
3.6.	Equipments Used during the Test	9
4.	<u>TEST CONDITIONS AND RESULTS</u>	11
4.1.	AC Power Conducted Emission	11
4.2.	Radiated Emission	13
4.3.	Maximum Peak Output Power	17
4.4.	20dB Bandwidth	23
4.5.	Band Edge	29
4.6.	Frequency Separation	50
4.7.	Number of hopping frequency	57
4.8.	Time Of Occupancy(Dwell Time)	60
4.9.	Spurious RF Conducted Emission	76
4.10.	Pseudorandom Frequency Hopping Sequence	92
4.11.	Antenna Requirement	93
5.	<u>TEST SETUP PHOTOS OF THE EUT</u>	94
6.	<u>EXTERNAL AND INTERNAL PHOTOS OF THE EUT</u>	96

1. TEST STANDARDS

The tests were performed according to following standards:

[FCC Rules Part 15.247](#): Frequency Hopping, Direct Spread Spectrum and Hybrid Systems that are in operation within the bands of 902-928 MHz, 2400-2483.5 MHz, and 5725-5850 MHz.

[ANSI C63.10-2009](#): American National Standard for Testing Unlicensed Wireless Devices

2. SUMMARY

2.1. General Remarks

Date of receipt of test sample	:	Jan 07, 2014
Testing commenced on	:	Jan 07, 2014
Testing concluded on	:	Jan 15, 2014

2.2. Product Description

The **ITALCOM GROUP**'s Model: ZEUZ-HD or the "EUT" as referred to in this report; more general information as follows, for more details, refer to the user's manual of the EUT.

Name of EUT	mobile phone
Model Number	ZEUZ-HD
FCC ID	YPVITALCOMZEUZ-HD
Modulation Type	QPSK for WCDMA,GMSK for GSM/GPRS/EGPRS,8PSK only supported downlink
Antenna Type	Internal
Hardware version	MT6582_K28_ZeuzHD
Software version	ZEUZ_HD_AMXNYX_V001R
Android version	4.2.2
WLAN FCC Operation frequency	IEEE 802.11b: 2412MHz—2462MHz IEEE 802.11g: 2412MHz—2462MHz IEEE 802.11n HT20: 2412MHz—2462MHz IEEE 802.11n HT40: 2422MHz—2452MHz
Bluetooth FCC Operation frequency	2402MHz-2480MHz
WLAN Modulation	IEEE 802.11b: DSSS(CCK,DQPSK,DBPSK) IEEE 802.11g: OFDM(64QAM, 16QAM, QPSK, BPSK) IEEE 802.11n HT20: OFDM (64QAM, 16QAM, QPSK,BPSK) IEEE 802.11n HT40: OFDM (64QAM, 16QAM, QPSK,BPSK)
Bluetooth Modulation	GFSK,8PSK, $\pi/4$ DQPSK
GSM/EDGE/GPRS	Supported GSM/GPRS/EDGE
WCDMA Operation Frequency Band	FDD Band II, FDD Band V
HSDPA Release Version	Release 8
HSUPA Release Version	Release 6
WCDMA Release Version	R99
Bluetooth	Supported BT v2.1+EDR and BT 4.0
Extreme temp. Tolerance	-30°C to +60°C
Extreme vol. Limits	3.40VDC to 4.20VDC (nominal: 3.70VDC)
GSM/GPRS Operation Frequency Band	GSM850/PCS1900
GSM Release Version	R99
GPRS operation mode	Class B
GPRS Multislot Class	12
EGPRS Multislot Class	12

2.3. Equipment Under Test

Power supply system utilised

Power supply voltage	:	<input type="radio"/> 120V / 60 Hz	<input type="radio"/> 115V / 60Hz
		<input type="radio"/> 12 V DC	<input type="radio"/> 24 V DC
		<input checked="" type="radio"/> Other (specified in blank below)	

DC 3.70V/DC 5V From Adapter AC 120V/60Hz

2.4. Short description of the Equipment under Test (EUT)

2.4GHz (Mobile Phone (M/N:ZEUZ-HD))

For more details, refer to the user's manual of the EUT.

2.5. EUT operation mode

The EUT has been tested under typical operating condition. There are EDR (Enhanced Data Rate) and BDR (Basic Data Rate) mode. The Applicant provides communication tools software to control the EUT for staying in continuous transmitting and receiving mode for testing. There are 79 channels of EUT, and the test carried out at the lowest channel, middle channel and highest channel.

Channel	Frequency(MHz)	Channel	Frequency(MHz)
00	2402	40	2442
01	2403	41	2443
02	2404	42	2444
03	2405	43	2445
04	2406	44	2446
05	2407	45	2447
06	2408	46	2448
07	2409	47	2449
08	2410	48	2450
09	2411	49	2451
10	2412	50	2452
11	2413	51	2453
12	2414	52	2454
13	2415	53	2455
14	2416	54	2456
15	2417	55	2457
16	2418	56	2458
17	2419	57	2459
18	2420	58	2460
19	2421	59	2461
20	2422	60	2462
21	2423	61	2463
22	2424	62	2464
23	2425	63	2465
24	2426	64	2466
25	2427	65	2467
26	2428	66	2468
27	2429	67	2469
28	2430	68	2470
29	2431	69	2471
30	2432	70	2472
31	2433	71	2473
32	2434	72	2474
33	2435	73	2475
34	2436	74	2476
35	2437	75	2477
36	2438	76	2478
37	2439	77	2479
38	2440	78	2480
39	2441		

2.6. Internal Identification of AE used during the test

AE ID*	Description
AE1	Battery
AE2	Charger and USB cable

AE1

Model: NYX1800A69X58
 Manufacturer: ITALCOM GROUP.
 Capacitance: 1800mAh
 Nominal Voltage: 3.70V

AE2:

Model: ZEUZ-HD
 Manufacturer: ITALCOM GROUP.
 Input: 100-240V~50/60Hz 0.15A
 Output: OUTPUT: 5.0V DC 1.0A
 Power Cable Length: 90cm
 Shielded Unshielded

*AE ID: is used to identify the test sample in the lab internally.

2.7. Related Submittal(s) / Grant (s)

This submittal(s) (test report) is intended for **FCC ID: YPVITALCOMZEUZ-HD** filing to comply with Section 15.247 of the FCC Part 15, Subpart C Rules.

2.8. Modifications

No modifications were implemented to meet testing criteria.

2.9. NOTE

- The EUT is a Mobile Phone WCDMA/HSUPA/HSDPA/GPRS/GSM, WLAN and Bluetooth function, The functions of the EUT listed as below:

	Test Standards	Reference Report
GSM/GPRS/EGPRS	FCC Part 22/FCC Part 24	TRE1401002101
WCDMA/HSUPA/HSDPA	FCC Part 22/FCC Part 24	TRE1401002102
WLAN	FCC Part 15 C 15.247	TRE1401002103
Bluetooth v2.1+EDR	FCC Part 15 C 15.247	TRE1401002104
Bluetooth 4.0	FCC Part 15 C 15.247	TRE1401002105
USB Port	FCC Part 15 B	TRE1401002106
SAR	FCC Part 2 §2.1093	TRE1401002107

3. TEST ENVIRONMENT

3.1. Address of the test laboratory

Shenzhen Huatongwei International Inspection Co., Ltd
Keji Nan No.12 Road, Hi-tech Park, Shenzhen, China
Phone: 86-755-26715686 Fax: 86-755-26748089

The sites are constructed in conformance with the requirements of ANSI C63.7, ANSI C63.4 (2009) and CISPR Publication 22.

3.2. Test Facility

The test facility is recognized, certified, or accredited by the following organizations:

CNAS-Lab Code: L1225

Shenzhen Huatongwei International Inspection Co., Ltd. has been assessed and proved to be in compliance with CNAS-CL01 Accreditation Criteria for Testing and Calibration Laboratories (identical to ISO/IEC 17025: 2005 General Requirements) for the Competence of Testing and Calibration Laboratories, Date of Registration: Mar. 01, 2012. Valid time is until Feb 28, 2015.

A2LA-Lab Cert. No. 2243.01

Shenzhen Huatongwei International Inspection Co., Ltd. EMC Laboratory has been accredited by A2LA for technical competence in the field of electrical testing, and proved to be in compliance with ISO/IEC 17025: 2005 General Requirements for the Competence of Testing and Calibration Laboratories and any additional program requirements in the identified field of testing. Valid time is until Sept. 30, 2015.

FCC-Registration No.: 662850

Shenzhen Huatongwei International Inspection Co., Ltd. EMC Laboratory has been registered and fully described in a report filed with the FCC (Federal Communications Commission). The acceptance letter from the FCC is maintained in our files. Registration 662850, Renewal date Jun. 01, 2012, valid time is until Jun. 01, 2015.

IC-Registration No.: 5377A

The 3m Alternate Test Site of Shenzhen Huatongwei International Inspection Co., Ltd has been registered by Certification and Engineering Bureau of Industry Canada for the performance of radiated measurements with Registration No. 5377 on Dec 31, 2013. Valid time is until Dec 31, 2016.

ACA

Shenzhen Huatongwei International Inspection Co., Ltd. EMC Laboratory can also perform testing for the Australian C-Tick mark as a result of our A2LA accreditation.

VCCI

The 3m Semi-anechoic chamber (12.2m×7.95m×6.7m) and Shielded Room (8m×4m×3m) of Shenzhen Huatongwei International Inspection Co., Ltd has been registered in accordance with the Regulations for Voluntary Control Measures with Registration No.: R-2484. Date of Registration: December 20, 2013. Valid time is until December 19, 2016.

Main Ports Conducted Interference Measurement of Shenzhen Huatongwei International Inspection Co., Ltd has been registered in accordance with the Regulations for Voluntary Control Measures with Registration No.: C-2726. Date of Registration: December 20, 2013. Valid time is until December 19, 2016.

DNV

Shenzhen Huatongwei International Inspection Co., Ltd. has been found to comply with the requirements of DNV towards subcontractor of EMC and safety testing services in conjunction with the EMC and Low voltage Directives and in the voluntary field. The acceptance is based on a formal quality Audit and follow-ups according to relevant parts of ISO/IEC Guide 17025 (2005), in accordance with the requirements of the DNV Laboratory Quality Manual towards subcontractors. Valid time is until Aug. 24, 2016.

3.3. Environmental conditions

During the measurement the environmental conditions were within the listed ranges:

Temperature:	<u>15-35 ° C</u>
Humidity:	<u>30-60 %</u>
Atmospheric pressure:	<u>950-1050mbar</u>

3.4. Test Description

FCC PART 15 15.247		
FCC Part 15.207	AC Power Conducted Emission	PASS
FCC Part 15.247(a)(1)(i)	20dB Bandwidth	PASS
FCC Part 15.247(d)	Spurious RF Conducted Emission	PASS
FCC Part 15.247(b)	Maximum Peak Output Power	PASS
FCC Part 15.247(b)	Pseudorandom Frequency Hopping Sequence	PASS
FCC Part 15.247(a)(1)(iii)	Number of hopping frequency& Time of Occupancy	PASS
FCC Part 15.247(a)(1)	Frequency Separation	PASS
FCC Part 15.109/ 15.205/ 15.209	Radiated Emissions	PASS
FCC Part 15.247(d)	Band Edge Compliance of RF Emission	PASS
FCC Part 15.203/15.247 (b)	Antenna Requirement	PASS

Remark: The measurement uncertainty is not included in the test result.

3.5. Statement of the measurement uncertainty

The data and results referenced in this document are true and accurate. The reader is cautioned that there may be errors within the calibration limits of the equipment and facilities. The measurement uncertainty was calculated for all measurements listed in this test report acc. to CISPR 16 - 4 „Specification for radio disturbance and immunity measuring apparatus and methods – Part 4: Uncertainty in EMC Measurements“ and is documented in the Shenzhen Huatongwei International Inspection Co., Ltd quality system acc. to DIN EN ISO/IEC 17025. Furthermore, component and process variability of devices similar to that tested may result in additional deviation. The manufacturer has the sole responsibility of continued compliance of the device.

Hereafter the best measurement capability for Shenzhen Huatongwei laboratory is reported:

Test Items	Measurement Uncertainty	Notes
Transmitter power conducted	0.57 dB	(1)
Transmitter power Radiated	2.20 dB	(1)
Conducted spurious emission 9KHz-40 GHz	1.60 dB	(1)
Radiated spurious emission 9KHz-40 GHz	2.20 dB	(1)
Conducted Emission 9KHz-30MHz	3.39 dB	(1)
Radiated Emission 30~1000MHz	4.24 dB	(1)
Radiated Emissio 1~18GHz	5.16 dB	(1)
Radiated Emissio 18-40GHz	5.54 dB	(1)
Occupied Bandwidth	-----	(1)

(1) This uncertainty represents an expanded uncertainty expressed at approximately the 95% confidence level using a coverage factor of k=1.96.

3.6. Equipments Used during the Test

AC Power Conducted Emission					
Item	Test Equipment	Manufacturer	Model No.	Serial No.	Cal Due
1	Artificial Mains	Rohde&Schwarz	ESH2-Z5	100028	2014/10/25
2	EMI Test Receiver	Rohde&Schwarz	ESCI3	100038	2014/10/25
3	Pulse Limiter	Rohde&Schwarz	ESHSZ2	100044	2014/10/25
4	EMI Test Software	Rohde&Schwarz	ES-K1 V1.71	N/A	N/A

Radiated Emission					
Item	Test Equipment	Manufacturer	Model No.	Serial No.	Cal Due
1	Ultra-Broadband Antenna	ShwarzBeck	VULB9163	538	2014/10/25
2	EMI TEST RECEIVER	Rohde&Schwarz	ESI 26	100009	2014/10/25
3	EMI TEST Software	Audix	E3	N/A	N/A
4	TURNTABLE	ETS	2088	2149	N/A
5	ANTENNA MAST	ETS	2075	2346	N/A
6	EMI TEST Software	Rohde&Schwarz	ESK1	N/A	N/A
7	HORN ANTENNA	ShwarzBeck	9120D	1011	2014/10/25
8	Amplifer	Sonoma	310N	E009-13	2014/10/25
9	JS amplifier	Rohde&Schwarz	JS4-00101800-28-5A	F201504	2014/10/25
10	High pass filter	Compliance Direction systems	BSU-6	34202	2014/10/25
11	HORN ANTENNA	ShwarzBeck	9120D	1012	2014/10/25
12	Amplifer	Compliance Direction systems	PAP1-4060	120	2014/10/25
13	Loop Antenna	Rohde&Schwarz	HFH2-Z2	100020	2014/10/25
14	TURNTABLE	MATURO	TT2.0	----	N/A
15	ANTENNA MAST	MATURO	TAM-4.0-P	----	N/A
16	Horn Antenna	SCHWARZBECK	BBHA9170	25841	2014/10/25
17	ULTRA-BROADBAND ANTENNA	Rohde&Schwarz	HL562	100015	2014/10/25

Maximum Peak Output Power / Power Spectral Density / 6dB Bandwidth / Band Edge Compliance of RF Emission / Spurious RF Conducted Emission					
Item	Test Equipment	Manufacturer	Model No.	Serial No.	Cal Due

1	Spectrum Analyzer	Rohde&Schwarz	FSP	1164.4391.40	2014/10/25
---	-------------------	---------------	-----	--------------	------------

The Cal.Interval was one year

4. TEST CONDITIONS AND RESULTS

4.1. AC Power Conducted Emission

TEST CONFIGURATION

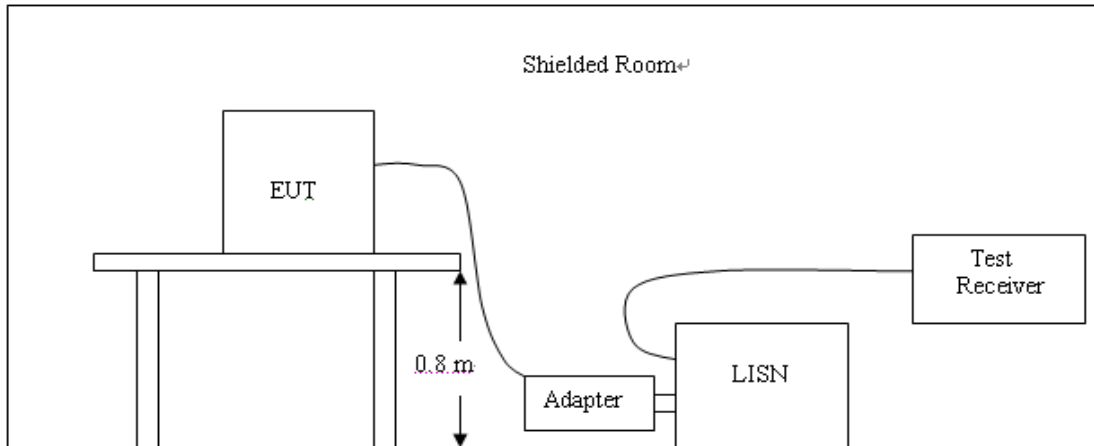

TEST PROCEDURE

1. The equipment was set up as per the test configuration to simulate typical actual usage per the user's manual. The EUT is a tabletop system, a wooden table with a height of 0.8 meters is used and is placed on the ground plane as per ANSI C63.10-2009.
2. Support equipment, if needed, was placed as per ANSI C63.10-2009
3. All I/O cables were positioned to simulate typical actual usage as per ANSI C63.10-2009
4. The EUT received DC5V power from the adapter, the adapter received AC120V/60Hz power through a Line Impedance Stabilization Network (LISN) which supplied power source and was grounded to the ground plane.
5. All support equipments received AC power from a second LISN, if any.
6. The EUT test program was started. Emissions were measured on each current carrying line of the EUT using a spectrum Analyzer / Receiver connected to the LISN powering the EUT. The LISN has two monitoring points: Line 1 (Hot Side) and Line 2 (Neutral Side). Two scans were taken: one with Line 1 connected to Analyzer / Receiver and Line 2 connected to a 50 ohm load; the second scan had Line 1 connected to a 50 ohm load and Line 2 connected to the Analyzer / Receiver.
7. Analyzer / Receiver scanned from 150 KHz to 30MHz for emissions in each of the test modes.
8. During the above scans, the emissions were maximized by cable manipulation.

AC Power Conducted Emission Limit

For intentional device, according to § 15.207(a) AC Power Conducted Emission Limits is as following :

Frequency (MHz)	Maximum RF Line Voltage (dBµV)			
	CLASS A		CLASS B	
	Q.P.	Ave.	Q.P.	Ave.
0.15 - 0.50	79	66	66-56*	56-46*
0.50 - 5.00	73	60	56	46
5.00 - 30.0	73	60	60	50

* Decreasing linearly with the logarithm of the frequency

TEST RESULTS

Note: We tested Conducted Emission of GFSK, $\pi/4$ DQPSK and 8DPSK mode from 0.15KHz to 30MHz and We recorded the worst case data at GFSK mode.

SCAN TABLE: "Voltage (9K-30M)FIN"
 Short Description: 150K-30M Voltage

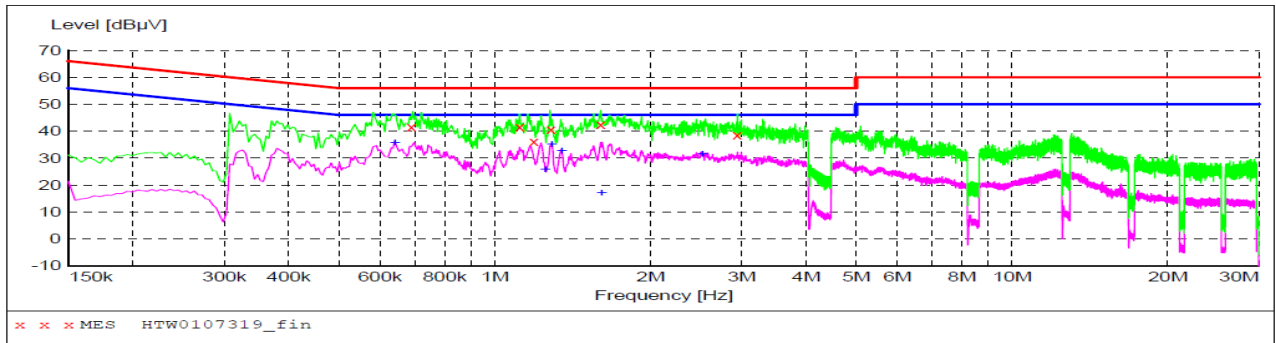

MEASUREMENT RESULT: "HTW0107319_fin"

1/7/2014 2:54PM

Frequency MHz	Level dBµV	Transd dB	Limit dBµV	Margin dB	Detector	Line	PE
0.690000	41.60	10.3	56	14.4	QP	L1	GND
1.117500	41.50	10.3	56	14.5	QP	L1	GND
1.189500	36.30	10.3	56	19.7	QP	L1	GND
1.284000	40.60	10.3	56	15.4	QP	L1	GND
1.603500	42.50	10.3	56	13.5	QP	L1	GND
2.940000	38.70	10.3	56	17.3	QP	L1	GND

MEASUREMENT RESULT: "HTW0107319_fin2"

1/7/2014 2:54PM

Frequency MHz	Level dBµV	Transd dB	Limit dBµV	Margin dB	Detector	Line	PE
0.640500	35.50	10.3	46	10.5	AV	L1	GND
1.252500	25.60	10.3	46	20.4	AV	L1	GND
1.288500	34.90	10.3	46	11.1	AV	L1	GND
1.347000	32.70	10.3	46	13.3	AV	L1	GND
1.608000	16.90	10.3	46	29.1	AV	L1	GND
2.521500	31.50	10.3	46	14.5	AV	L1	GND

SCAN TABLE: "Voltage (9K-30M)FIN"
 Short Description: 150K-30M Voltage

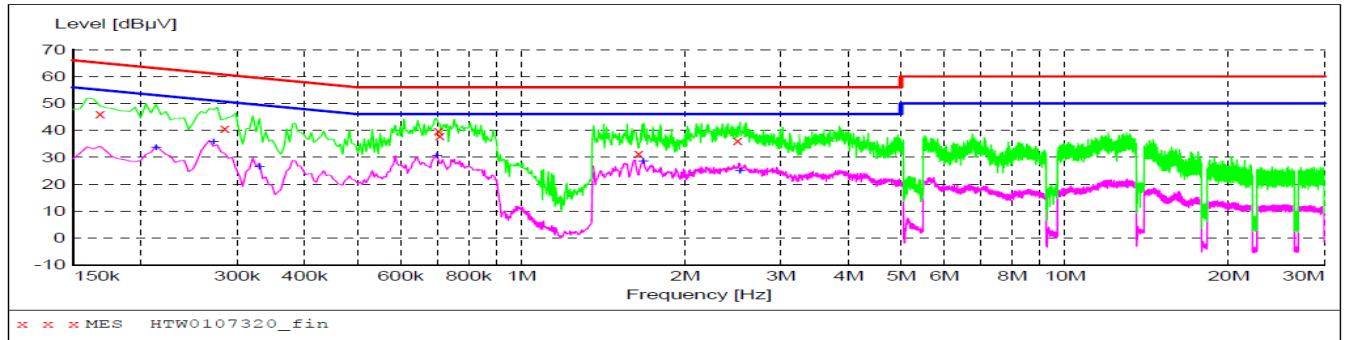

MEASUREMENT RESULT: "HTW0107320_fin"

1/7/2014 2:58PM

Frequency MHz	Level dBµV	Transd dB	Limit dBµV	Margin dB	Detector	Line	PE
0.168000	46.20	10.3	65	18.9	QP	N	GND
0.285000	40.80	10.6	61	19.9	QP	N	GND
0.703500	39.90	10.3	56	16.1	QP	N	GND
0.708000	38.00	10.3	56	18.0	QP	N	GND
1.644000	31.30	10.3	56	24.7	QP	N	GND
2.503500	36.10	10.3	56	19.9	QP	N	GND

MEASUREMENT RESULT: "HTW0107320_fin2"

1/7/2014 2:58PM

Frequency MHz	Level dBµV	Transd dB	Limit dBµV	Margin dB	Detector	Line	PE
0.213000	33.40	10.4	53	19.7	AV	N	GND
0.271500	35.50	10.6	51	15.6	AV	N	GND
0.330000	26.20	10.6	50	23.3	AV	N	GND
0.699000	30.40	10.3	46	15.6	AV	N	GND
1.675500	28.40	10.3	46	17.6	AV	N	GND
2.526000	24.80	10.3	46	21.2	AV	N	GND

4.2. Radiated Emission

TEST CONFIGURATION

Frequency range 9KHz – 30MHz

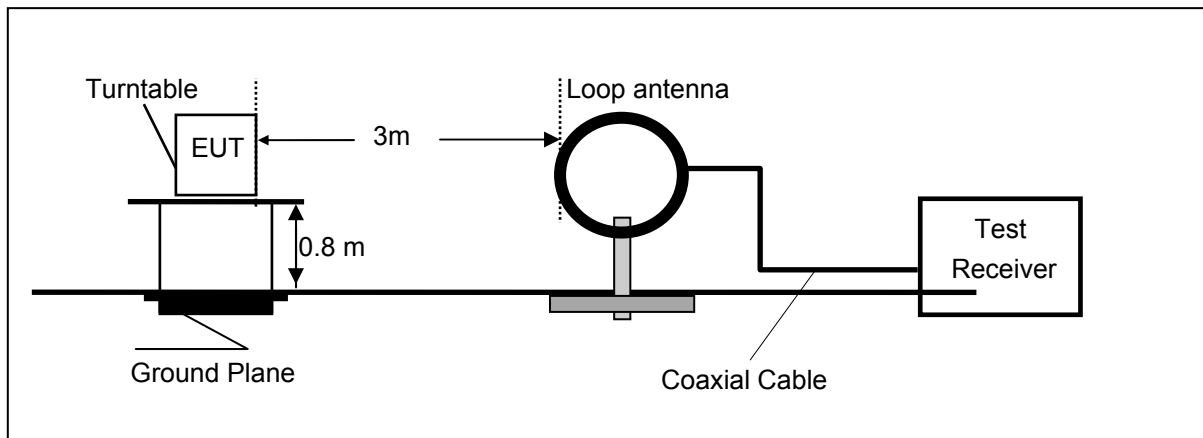

Frequency range 30MHz – 1000MHz

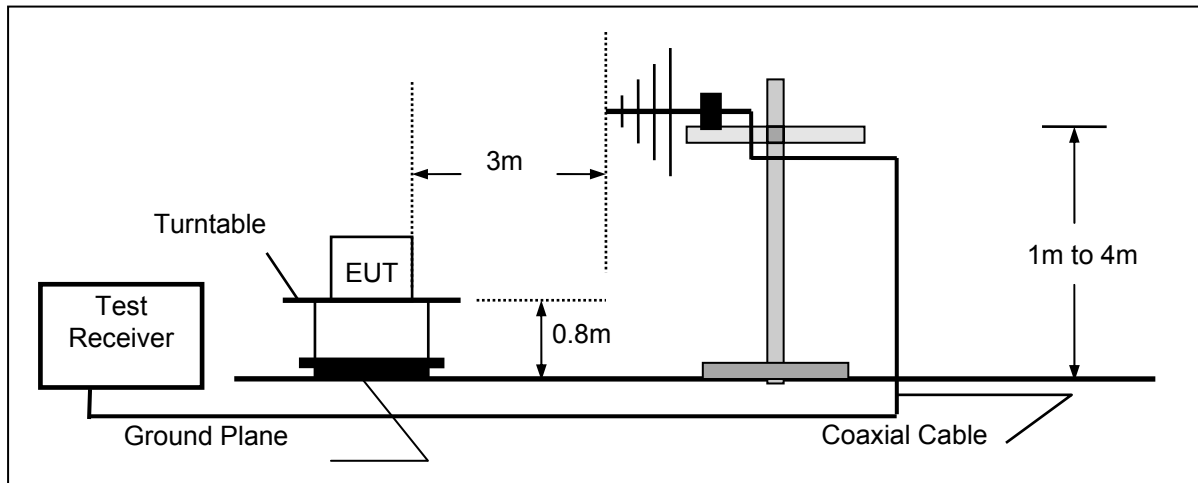

Frequency range above 1GHz-25GHz

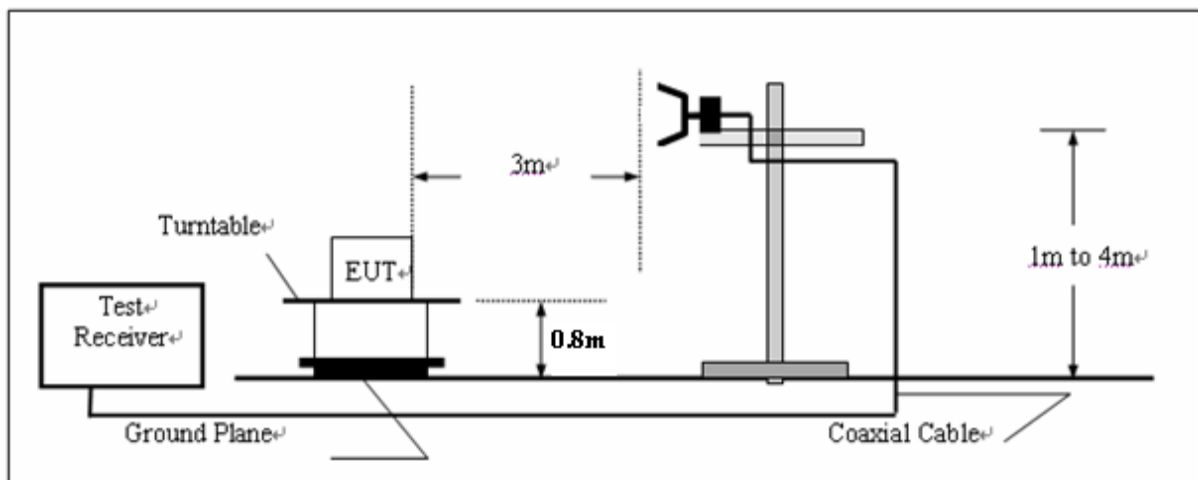

TEST PROCEDURE

1. The EUT was placed on a turn table which is 0.8m above ground plane.
2. Maximum procedure was performed by raising the receiving antenna from 1m to 4m and rotating the turn table from 0° to 360° to acquire the highest emissions from EUT

3. And also, each emission was to be maximized by changing the polarization of receiving antenna both horizontal and vertical.
4. Repeat above procedures until all frequency measurements have been completed.
5. The EUT minimum operation frequency was 32.768KHz and maximum operation frequency was 2480MHz.so radiated emission test frequency band from 9KHz to 25GHz.

Field Strength Calculation

The field strength is calculated by adding the Antenna Factor and Cable Factor and subtracting the Amplifier Gain and Duty Cycle Correction Factor(if any) from the measured reading. The basic equation with a sample calculation is as follows:

$$FS = RA + AF + CL - AG$$

Where FS = Field Strength	CL = Cable Attenuation Factor (Cable Loss)
RA = Reading Amplitude	AG = Amplifier Gain
AF = Antenna Factor	

For example

Frequency (MHz)	FS (dB μ V/m)	RA (dB μ V/m)	AF (dB)	CL (dB)	AG (dB)	Transd (dB)
300.00	40	58.1	12.2	1.6	31.90	-18.1

$$\text{Transd} = \text{AF} + \text{CL} - \text{AG}$$

RADIATION LIMIT

For intentional device, according to § 15.209(a), the general requirement of field strength of radiated emission from intentional radiators at a distance of 3 meters shall not exceed the following table. According to § 15.247(d), in any 100kHz bandwidth outside the frequency band in which the EUT is operating, the radio frequency power that is produced by the intentional radiator shall be at least 20dB below that in the 100kHz bandwidth within the band that contains the highest level of desired power.

The frequency spectrum above 1 GHz for Transmitter was investigated. All emission not reported are much lower than the prescribed limits. Set the RBW=1MHz,VBW=3MHz for Peak Detector while the RBW=1MHz,VBW=10Hz for Average Detector,Readings are both peak and average values. The pre-test have done for the EUT in three axes and found the worst emission at position shown in test setup photos.

Frequency (MHz)	Distance (Meters)	Radiated (dB μ V/m)	Radiated (μ V/m)
30-88	3	40.0	100
88-216	3	43.5	150
216-960	3	46.0	200
Above 960	3	54.0	500

TEST RESULTS

Note:1.We measured Radiated Emission at GFSK, $\pi/4$ DQPSK and 8DPSK mode from 9KHz to 25GHz and recorded worst case at GFSK mode.

2. We tested both battery powered and powered by adapter charging mode at three orientations,recored woest case at adapter charging mode.

For 9KHz to 30MHz

Frequency (MHz)	Corrected Reading (dB μ V/m)@3m	FCC Limit (dB μ V/m) @3m	Margin (dB)	Detector	Result
12.00	42.29	69.54	27.25	QP	PASS
24.00	41.18	69.54	28.36	QP	PASS

For 30MHz to 1000MHz

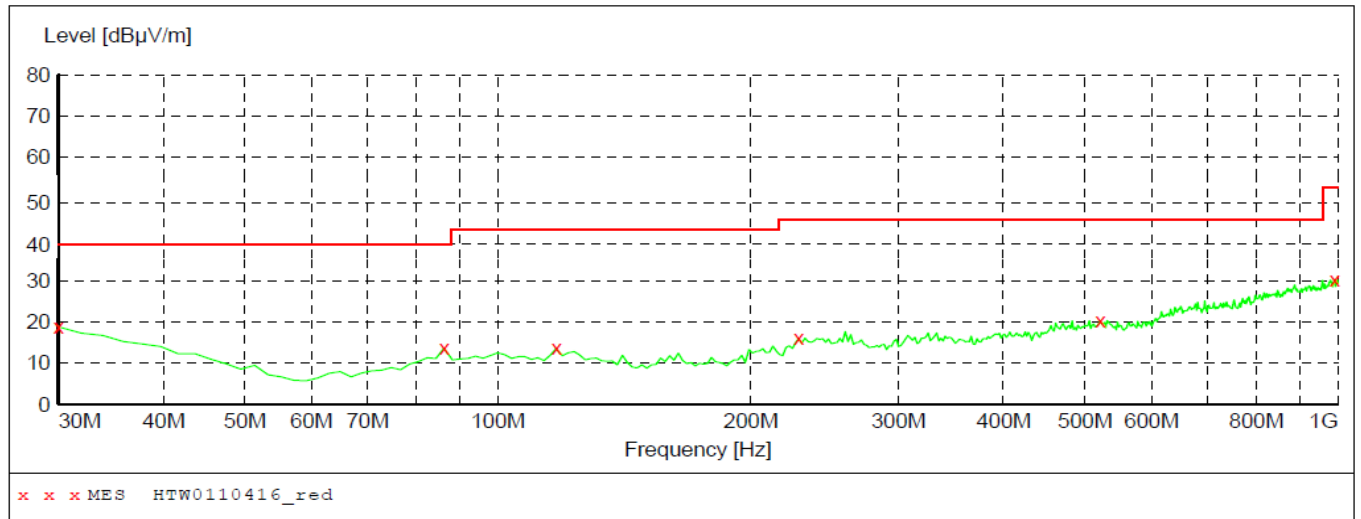

MEASUREMENT RESULT: "HTW0110416_red"

1/10/2014 12:26PM

Frequency MHz	Level dBµV/m	Transd dB	Limit dBµV/m	Margin dB	Det.	Height cm	Azimuth deg	Polarization
30.000000	18.80	-10.0	40.0	21.2	P k	100.0	152.00	HORIZONTAL
86.372745	13.60	-19.4	40.0	26.4	P K	200.0	141.00	HORIZONTAL
117.474950	13.60	-18.0	43.5	29.9	P K	100.0	347.00	HORIZONTAL
228.276553	16.00	-18.2	46.0	30.0	P K	100.0	270.00	HORIZONTAL
521.803607	20.40	-11.0	46.0	25.6	P K	200.0	83.00	HORIZONTAL
992.224449	30.30	-3.1	54.0	23.7	P K	100.0	103.00	HORIZONTAL

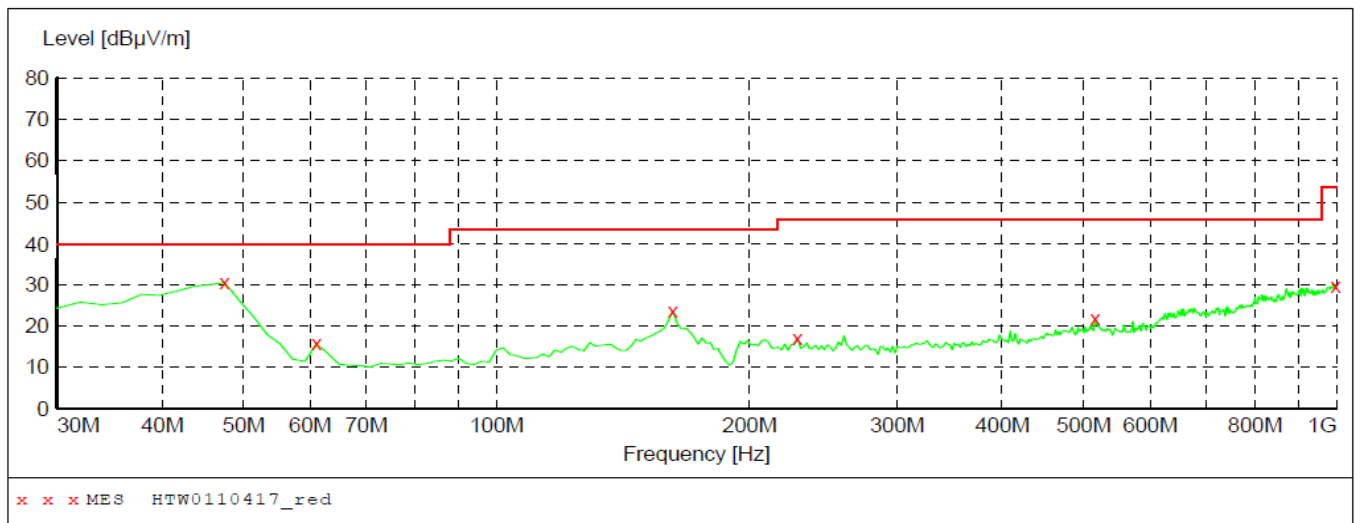

MEASUREMENT RESULT: "HTW0110417_red"

1/10/2014 12:28PM

Frequency MHz	Level dBµV/m	Transd dB	Limit dBµV/m	Margin dB	Det.	Height cm	Azimuth deg	Polarization
47.494990	30.50	-19.7	40.0	9.5	P k	100.0	290.00	VERTICAL
61.102204	15.70	-23.4	40.0	24.3	P k	100.0	102.00	VERTICAL
162.184369	23.60	-21.6	43.5	19.9	P k	200.0	219.00	VERTICAL
228.276553	17.10	-18.2	46.0	28.9	P k	100.0	71.00	VERTICAL
515.971944	21.80	-11.1	46.0	24.2	P k	200.0	285.00	VERTICAL
998.056112	29.70	-3.0	54.0	24.3	P k	100.0	311.00	VERTICAL

For 1GHz to 25GHz

Low Channel @ Channel 00 @ 2402 MHz

ANTENNA POLARITY & TEST DISTANCE: HORIZONTAL AT 3 M												
No.	Frequency (MHz)	Emission Level (dBuV/m)		Limit (dBuV/m)	Margin (dB)	Antenna Height (m)	Table Angle (Degree)	Raw Value (dBuV)	Antenna Factor (dB/m)	Cable Factor (dB)	Pre-amplifier	Correction Factor (dB/m)
1	4804.00	64.66	PK	74.00	9.34	1.00 H	216	62.58	31.58	7.00	36.5	2.08
2	4804.00	45.75	AV	54.00	8.25	1.00 H	216	43.67	31.58	7.00	36.5	2.08
3	7206.00	49.90	PK	74.00	24.1	1.00 H	207	39.24	37.06	8.90	35.3	10.66

ANTENNA POLARITY & TEST DISTANCE: VERTICAL AT 3 M												
No.	Frequency (MHz)	Emission Level (dBuV/m)		Limit (dBuV/m)	Margin (dB)	Antenna Height (m)	Table Angle (Degree)	Raw Value (dBuV)	Antenna Factor (dB/m)	Cable Factor (dB)	Pre-amplifier	Correction Factor (dB/m)
1	4804.00	64.41	PK	74.00	9.59	1.00 V	221	62.33	31.58	7.00	36.5	2.08
2	4804.00	45.27	AV	54.00	8.73	1.00 V	221	43.19	31.58	7.00	36.5	2.08
3	7206.00	49.62	PK	74.00	24.38	1.00 V	140	38.96	37.06	8.90	35.3	10.66

Middle Channel @ Channel 39 @ 2441 MHz

ANTENNA POLARITY & TEST DISTANCE: HORIZONTAL AT 3 M												
No.	Frequency (MHz)	Emission Level (dBuV/m)		Limit (dBuV/m)	Margin (dB)	Antenna Height (m)	Table Angle (Degree)	Raw Value (dBuV)	Antenna Factor (dB/m)	Cable Factor (dB)	Pre-amplifier	Correction Factor (dB/m)
1	4882.00	63.69	PK	74.00	10.31	1.00 H	19	61.55	31.04	7.60	36.5	2.14
2	4882.00	47.48	AV	54.00	6.52	1.00 H	19	45.34	31.04	7.60	36.5	2.14
3	7323.00	51.95	PK	74.00	22.05	1.00 H	254	40.81	37.84	8.60	35.3	11.14

ANTENNA POLARITY & TEST DISTANCE: VERTICAL AT 3 M												
No.	Frequency (MHz)	Emission Level (dBuV/m)		Limit (dBuV/m)	Margin (dB)	Antenna Height (m)	Table Angle (Degree)	Raw Value (dBuV)	Antenna Factor (dB/m)	Cable Factor (dB)	Pre-amplifier	Correction Factor (dB/m)
1	4882.00	62.59	PK	74.00	11.41	1.00 V	261	60.45	31.04	7.60	36.5	2.14
2	4882.00	47.66	AV	54.00	6.34	1.00 V	261	45.52	31.04	7.60	36.5	2.14
3	7323.00	52.06	PK	74.00	21.94	1.00 V	150	40.92	37.84	8.60	35.3	11.14

High Channel @ Channel 78 @ 2480 MHz

ANTENNA POLARITY & TEST DISTANCE: HORIZONTAL AT 3 M												
No.	Frequency (MHz)	Emission Level (dBuV/m)		Limit (dBuV/m)	Margin (dB)	Antenna Height (m)	Table Angle (Degree)	Raw Value (dBuV)	Antenna Factor (dB/m)	Cable Factor (dB)	Pre-amplifier	Correction Factor (dB/m)
1	4960.00	64.41	PK	74.00	9.59	1.00 H	260	61.98	31.63	7.00	36.2	2.43
2	4960.00	45.55	AV	54.00	8.45	1.00 H	260	43.12	31.63	7.00	36.2	2.43
3	7340.00	51.95	PK	74.00	22.05	1.00 H	113	40.35	38.40	8.50	35.3	11.60

ANTENNA POLARITY & TEST DISTANCE: VERTICAL AT 3 M												
No.	Frequency (MHz)	Emission Level (dBuV/m)		Limit (dBuV/m)	Margin (dB)	Antenna Height (m)	Table Angle (Degree)	Raw Value (dBuV)	Antenna Factor (dB/m)	Cable Factor (dB)	Pre-amplifier	Correction Factor (dB/m)
1	4960.00	63.98	PK	74.00	10.02	1.00 V	201	61.55	31.63	7.00	-36.2	2.43
2	4960.00	46.66	AV	54.00	7.34	1.00 V	201	44.23	31.63	7.00	-36.2	2.43
3	7340.00	52.70	PK	74.00	21.30	1.00 V	78	41.1	38.40	8.50	-35.3	11.60

REMARKS:

1. Emission level (dBuV/m) = Raw Value (dBuV) + Correction Factor (dB/m)
2. Correction Factor (dB/m) = Antenna Factor (dB/m) + Cable Factor (dB) - Pre-amplifier
3. The other emission levels were very low against the limit.
4. Margin value = Limit value - Emission level.
5. The average measurement was not performed when the peak measured data under the limit of average detection.

4.3. Maximum Peak Output Power

TEST CONFIGURATION

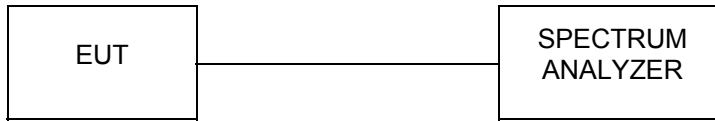

TEST PROCEDURE

Remove the antenna from the EUT and then connect a low loss RF cable from the antenna port to the spectrum.

LIMIT

The Maximum Peak Output Power Measurement is 30dBm.

TEST RESULTS

4.3.1 GFSK Test Mode

A. Test Verdict

Channel	Frequency (MHz)	Measured Output Peak Power (dBm)	Refer to Plot	Limits (dBm)	Verdict
00	2402	-1.16	Plot 4.3.1 A	30	PASS
39	2441	-1.01	Plot 4.3.1 B	30	PASS
78	2480	-0.91	Plot 4.3.1 C	30	PASS

Note: 1.The test results including the cable lose.

B. Test Plots

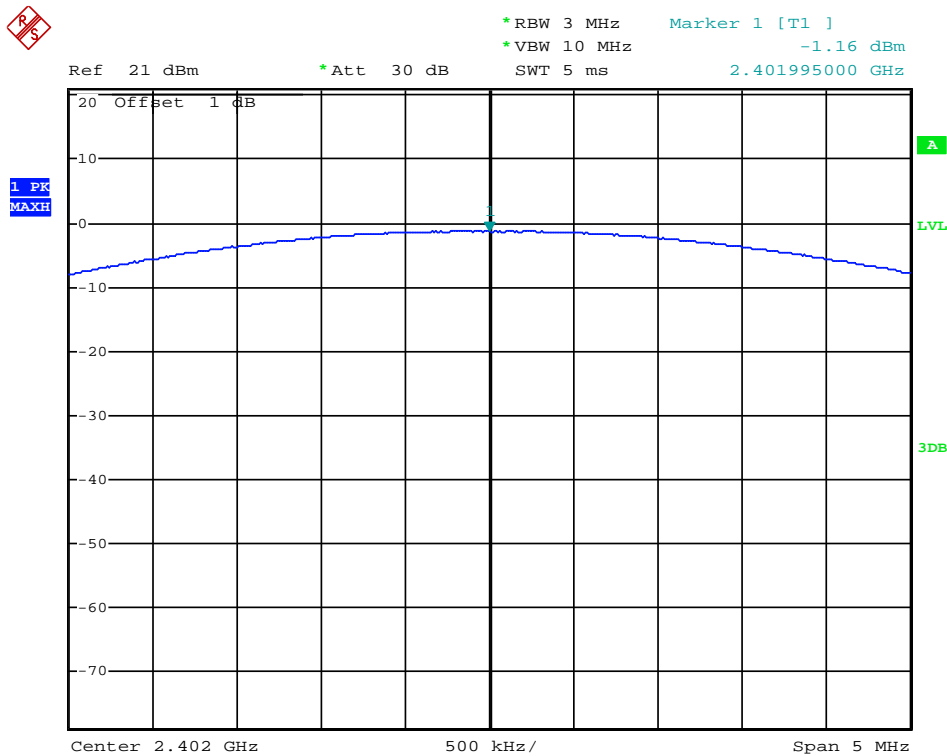

Date: 6.JAN.2014 15:49:43

(Plot 4.3.1 A: Channel 00: 2402MHz @ GFSK)



*RBW 3 MHz Marker 1 [T1]
*VBW 10 MHz -1.01 dBm
SWT 5 ms 2.440820000 GHz

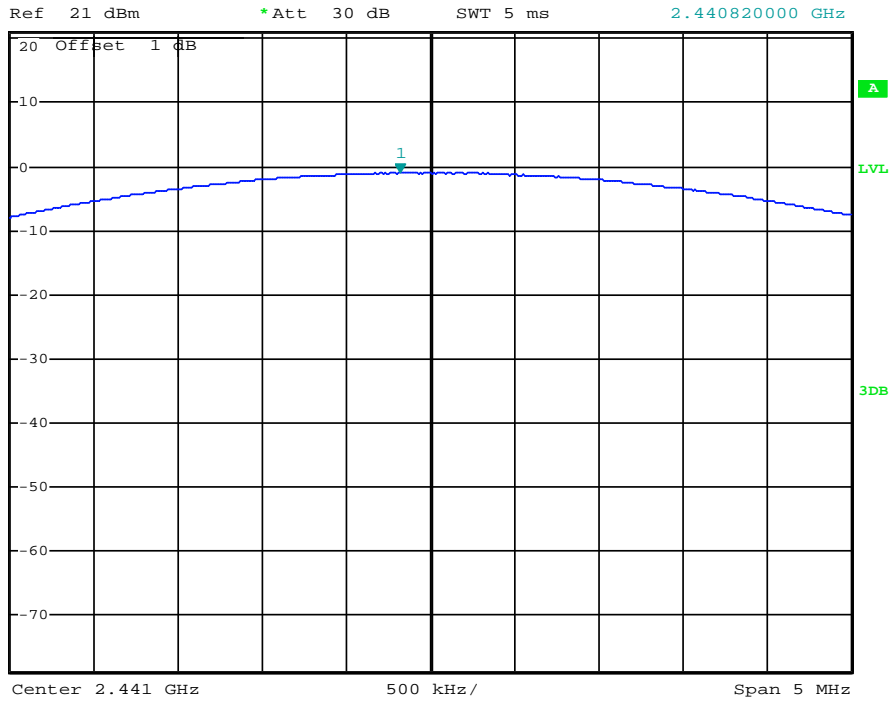

Date: 6.JAN.2014 15:50:13

(Plot 4.3.1 B: Channel 39: 2441MHz @ GFSK)



*RBW 3 MHz Marker 1 [T1]
*VBW 10 MHz -0.91 dBm
SWT 5 ms 2.480060000 GHz

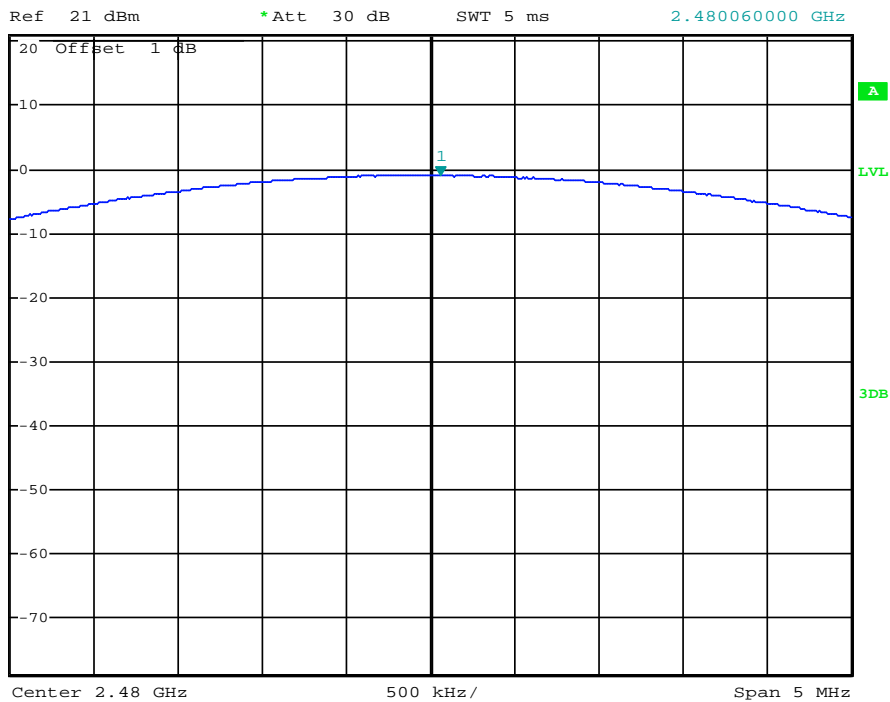

Date: 6.JAN.2014 15:50:32

(Plot 4.3.1 C: Channel 78: 2480MHz @ GFSK)

4.3.2 8DPSK Test Mode

A. Test Verdict

Channel	Frequency (MHz)	Measured Output Peak Power (dBm)	Refer to Plot	Limits (dBm)	Result
00	2402	-2.78	Plot 4.3.2 A	21	PASS
39	2441	-2.50	Plot 4.3.2 B	21	PASS
78	2480	-2.35	Plot 4.3.2 C	21	PASS

Note: 1.The test results including the cable lose.

B. Test Plots

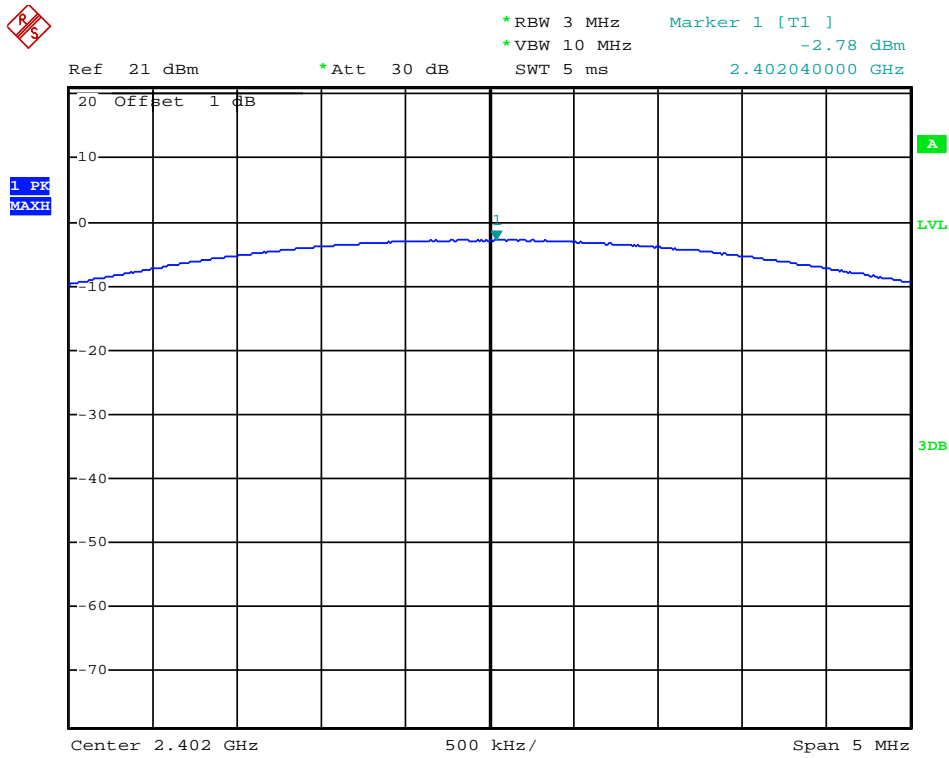

Date: 6.JAN.2014 15:51:35

(Plot 4.3.2 A: Channel 00: 2402MHz @ 8DPSK)



*RBW 3 MHz Marker 1 [T1]
*VBW 10 MHz -2.50 dBm
SWT 5 ms 2.440830000 GHz

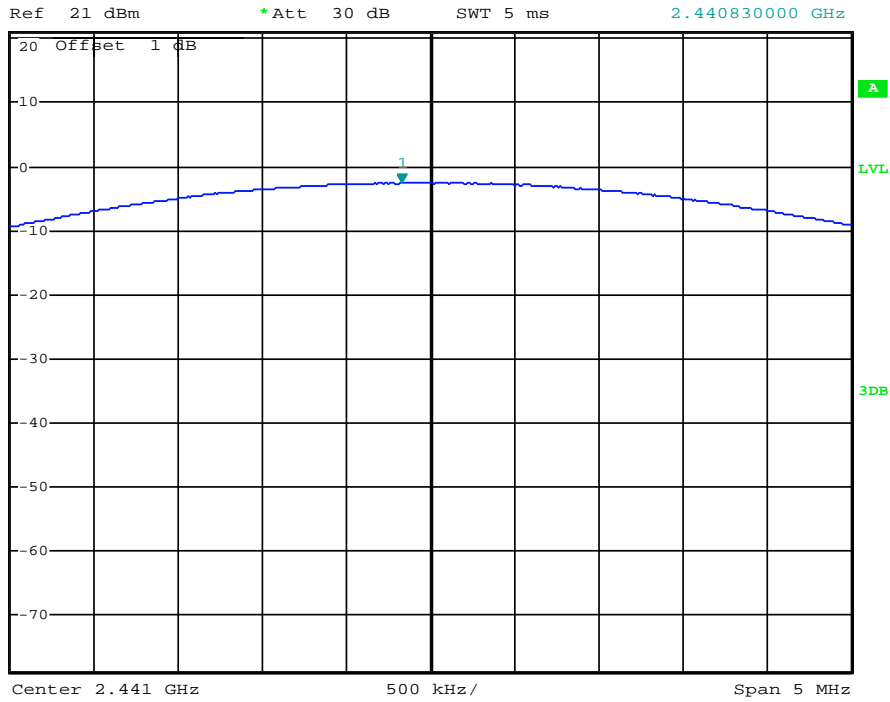

Date: 6.JAN.2014 15:52:54

(Plot 4.3.2 B: Channel 39: 2441MHz @ 8DPSK)



*RBW 3 MHz Marker 1 [T1]
*VBW 10 MHz -2.35 dBm
SWT 5 ms 2.480115000 GHz

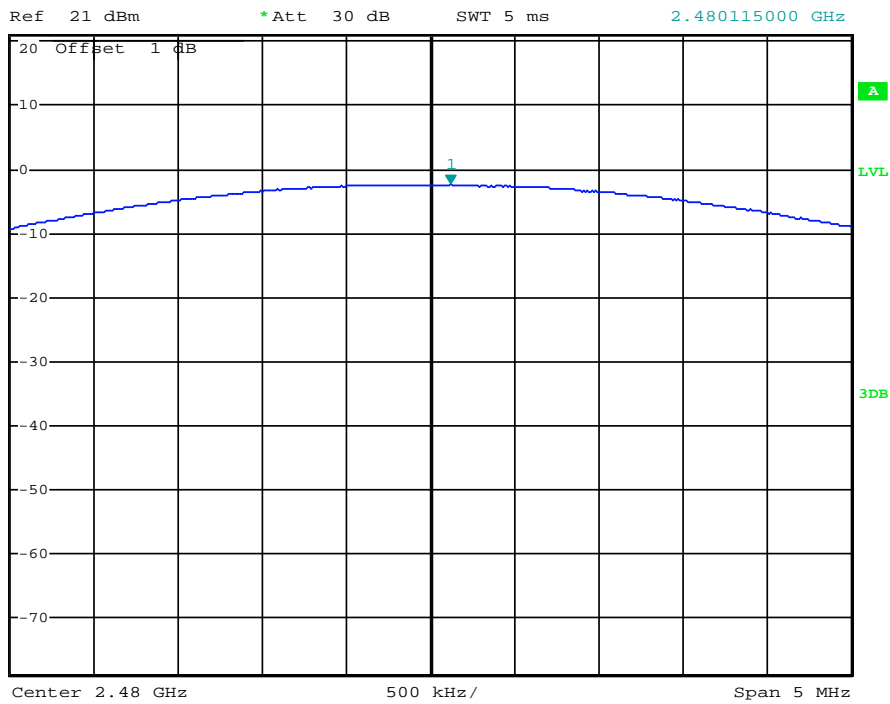

Date: 6.JAN.2014 15:53:33

(Plot 4.3.2 C: Channel 78: 2480MHz @ 8DPSK)

4.3.3 $\pi/4$ DQPSK Test Mode

A. Test Verdict

Channel	Frequency (MHz)	Measured Output Peak Power (dBm)	Refer to Plot	Limits (dBm)	Result
00	2402	-2.65	Plot 4.3.3 A	21	PASS
39	2441	-2.29	Plot 4.3.3 B	21	PASS
78	2480	-2.23	Plot 4.3.3 C	21	PASS

Note: 1.The test results including the cable lose.

B. Test Plots

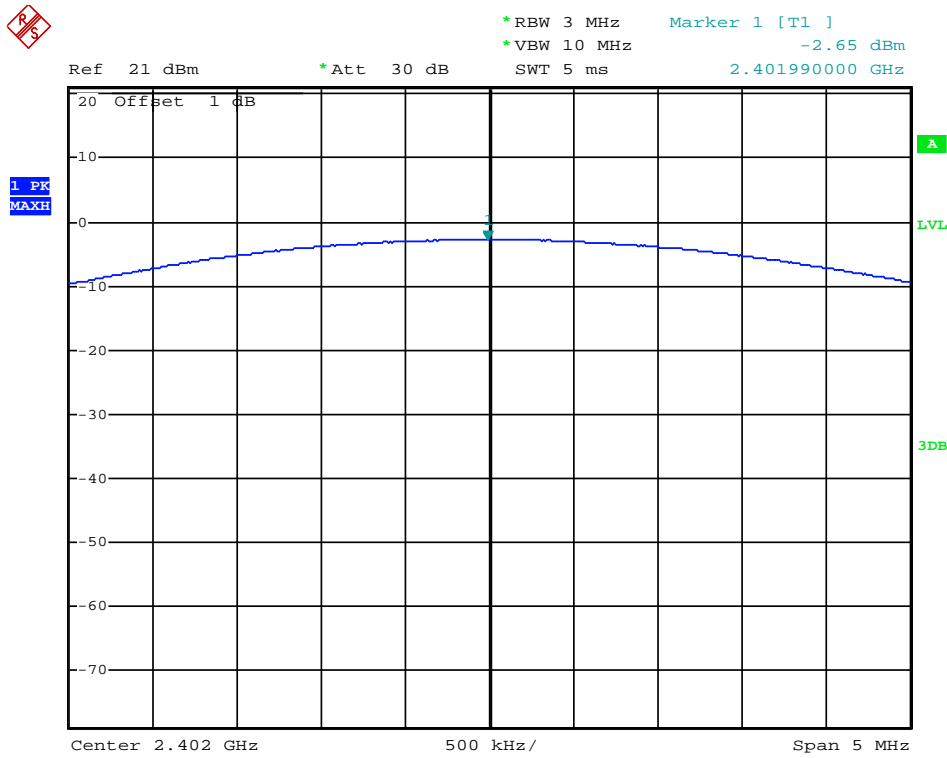

Date: 6.JAN.2014 15:54:49

(Plot 4.3.3 A: Channel 00: 2402MHz @ $\pi/4$ DQPSK)



*RBW 3 MHz Marker 1 [T1]
*VBW 10 MHz -2.29 dBm
SWT 5 ms 2.440985000 GHz

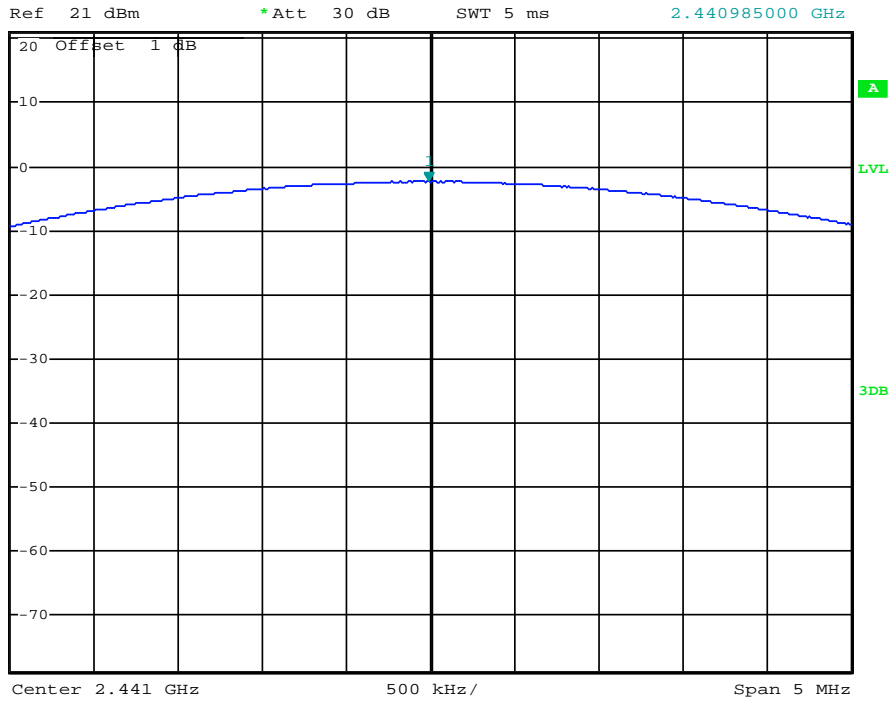

Date: 6.JAN.2014 15:55:31

(Plot 4.3.3 B: Channel 39: 2441MHz @ $\pi/4$ DQPSK)



*RBW 3 MHz Marker 1 [T1]
*VBW 10 MHz -2.23 dBm
SWT 5 ms 2.479890000 GHz

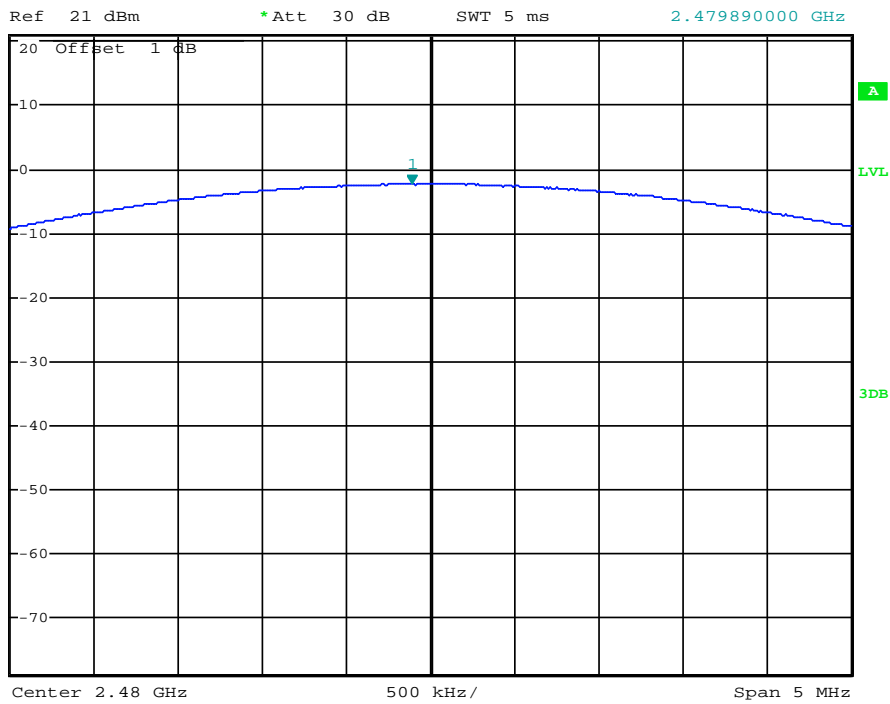

Date: 6.JAN.2014 15:56:08

(Plot 4.3.3 C: Channel 78: 2480MHz @ $\pi/4$ DQPSK)

4.4. 20dB Bandwidth

TEST CONFIGURATION

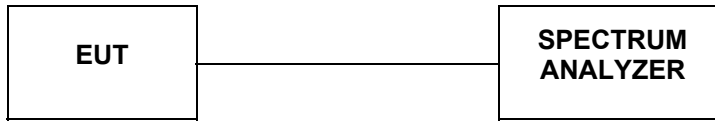

TEST PROCEDURE

The transmitter output was connected to the spectrum analyzer through an attenuator. The bandwidth of the fundamental frequency was measured by spectrum analyzer with RBW=30 KHz and VBW=100KHz.

The 20dB bandwidth is defined as the total spectrum the power of which is higher than peak power minus 20dB.

LIMIT

For frequency hopping systems operating in the 2400MHz-2483.5MHz no limit for 20dB bandwidth.

TEST RESULTS

4.4.1 GFSK Test Mode

A. Test Verdict

Channel	Frequency (MHz)	20dB Bandwidth (MHz)	Refer to Plot	Limits (MHz)	Verdict
00	2402	0.852	Plot 4.4.1 A	/	PASS
39	2441	0.840	Plot 4.4.1 B	/	PASS
78	2480	0.838	Plot 4.4.1 C	/	PASS

Note: 1.The test results including the cable lose.

B. Test Plots

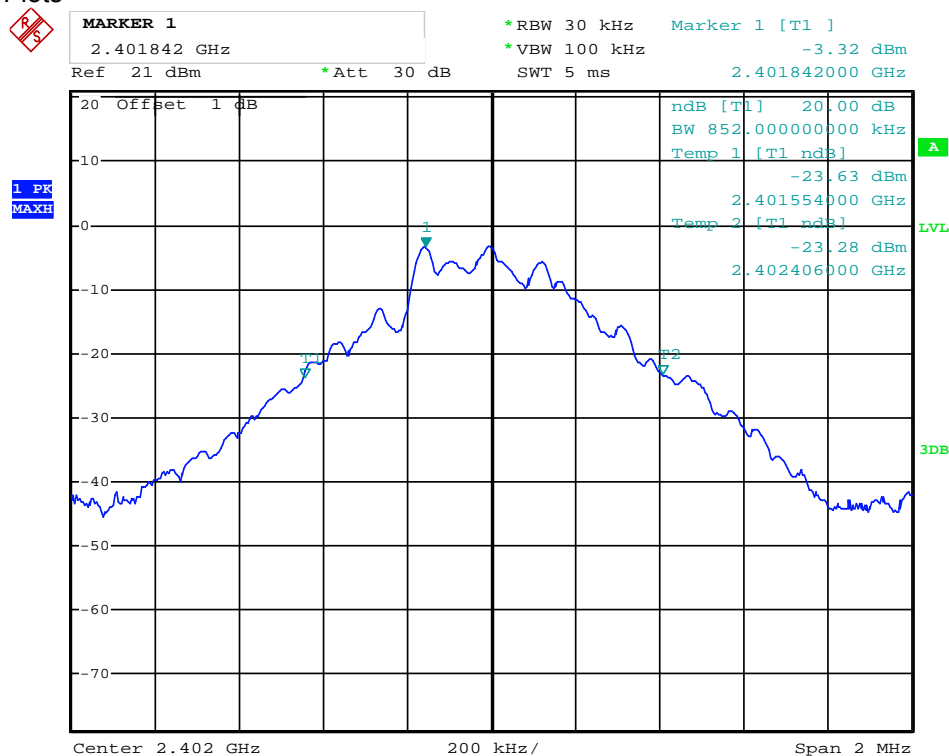

Date: 6.JAN.2014 15:59:25

(Plot 4.4.1 A: Channel 00: 2402MHz @ GFSK)



*RBW 30 kHz Marker 1 [T1]
*VBW 100 kHz -2.85 dBm
Ref 21 dBm *Att 30 dB SWI 5 ms 2.440994000 GHz

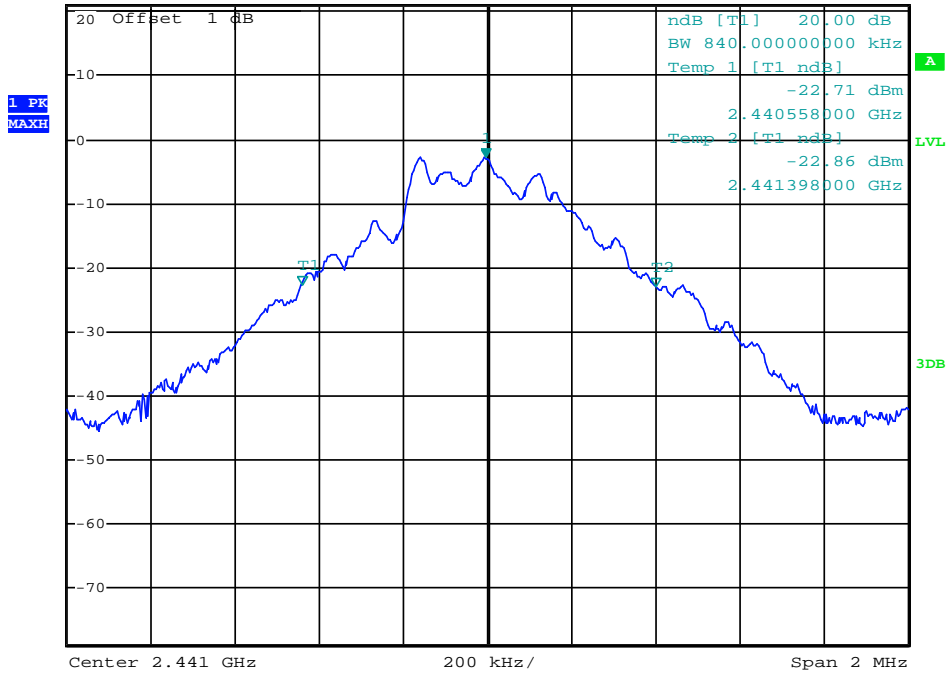

Date: 6.JAN.2014 15:59:59

(Plot 4.4.1 B: Channel 39: 2441MHz @ GFSK)



*RBW 30 kHz Marker 1 [T1]
*VBW 100 kHz -2.71 dBm
Ref 21 dBm *Att 30 dB SWI 5 ms 2.479996000 GHz

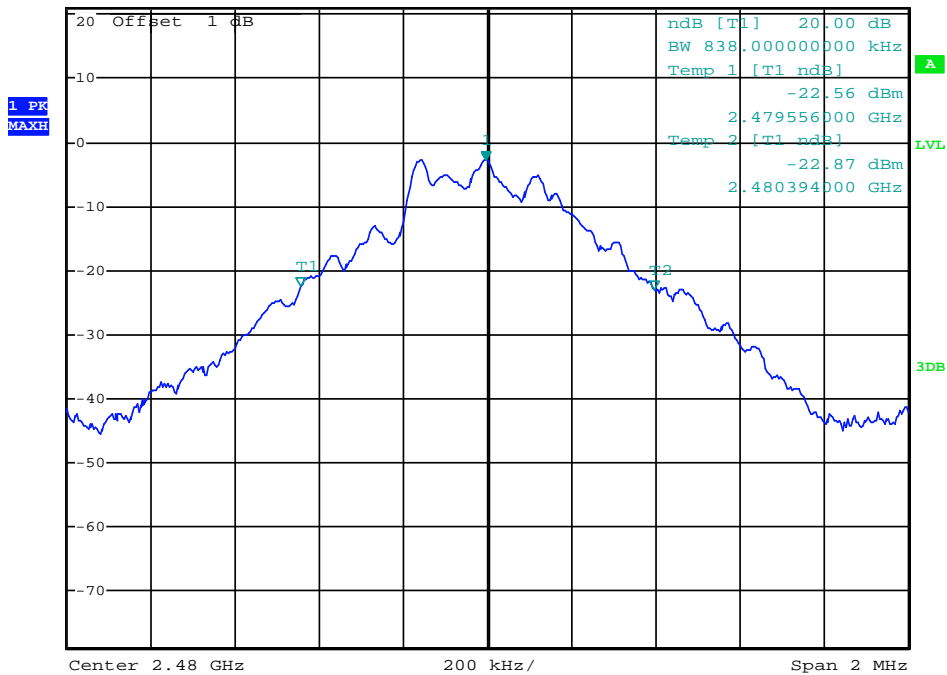

Date: 6.JAN.2014 16:00:42

(Plot 4.4.1 C: Channel 78: 2480MHz @ GFSK)

4.4.2 8DPSK Test Mode

A. Test Verdict

Channel	Frequency (MHz)	20dB Bandwidth (MHz)	Refer to Plot	Limits (MHz)	Verdict
00	2402	1.212	Plot 4.4.2 A	/	PASS
39	2441	1.214	Plot 4.4.2 B	/	PASS
78	2480	1.214	Plot 4.4.2 C	/	PASS

Note: 1.The test results including the cable lose.

B. Test Plots

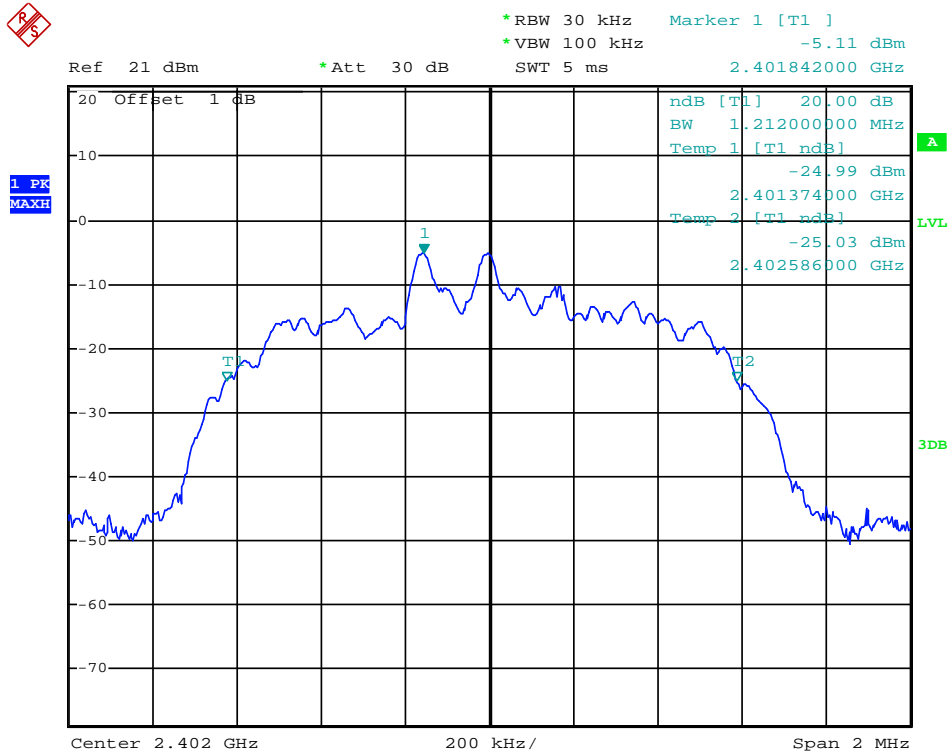

Date: 6.JAN.2014 16:01:24

(Plot 4.4.2 A: Channel 00: 2402MHz @ 8DPSK)



*RBW 30 kHz Marker 1 [T1]
*VBW 100 kHz -4.70 dBm
Ref 21 dBm *Att 30 dB SWT 5 ms 2.440840000 GHz

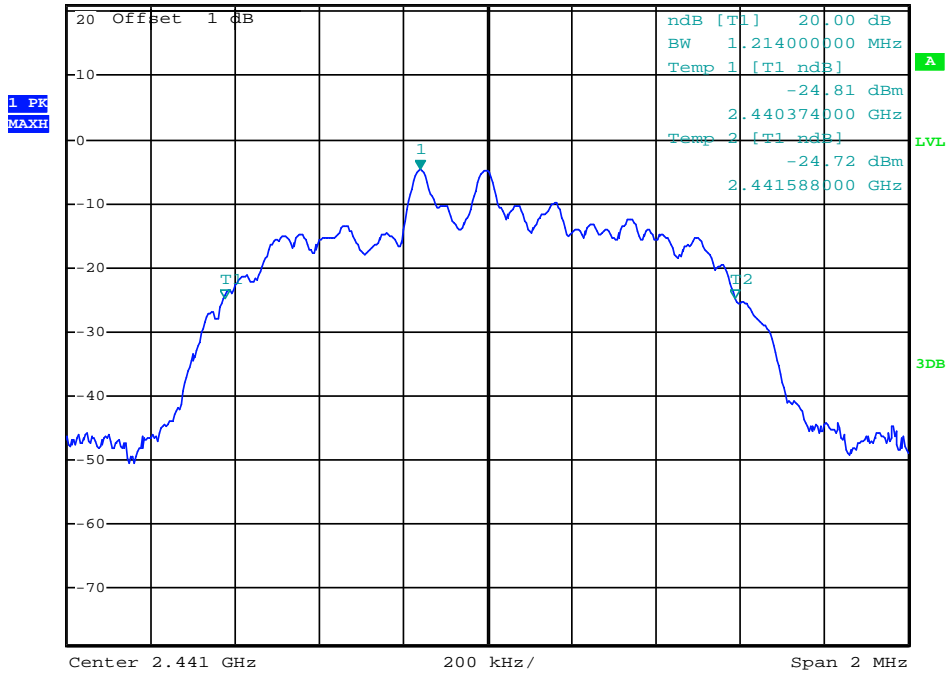

Date: 6.JAN.2014 16:02:02

(Plot 4.4.2 B: Channel 39: 2441MHz @ 8DPSK)



*RBW 30 kHz Marker 1 [T1]
*VBW 100 kHz -4.48 dBm
Ref 21 dBm *Att 30 dB SWT 5 ms 2.479840000 GHz

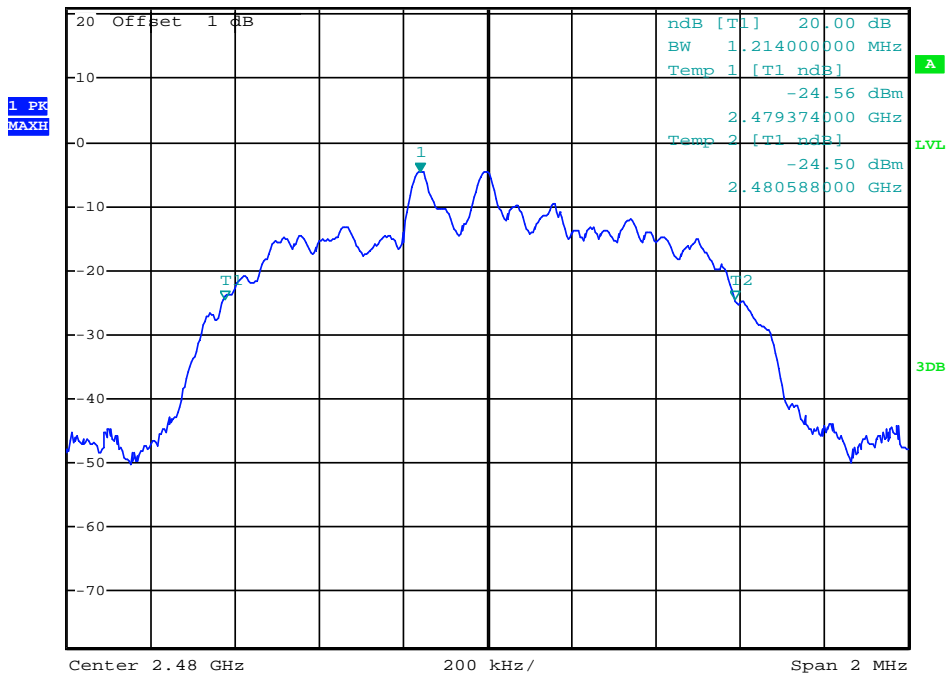

Date: 6.JAN.2014 16:02:39

(Plot 4.4.2 C: Channel 78: 2480MHz @ 8DPSK)

4.4.3 $\pi/4$ DQPSK Test Mode

A. Test Verdict

Channel	Frequency (MHz)	20dB Bandwidth (MHz)	Refer to Plot	Limits (MHz)	Verdict
00	2402	1.208	Plot 4.4.3 A	/	PASS
39	2441	1.208	Plot 4.4.3 B	/	PASS
78	2480	1.208	Plot 4.4.3 C	/	PASS

Note: 1.The test results including the cable lose.

B. Test Plots

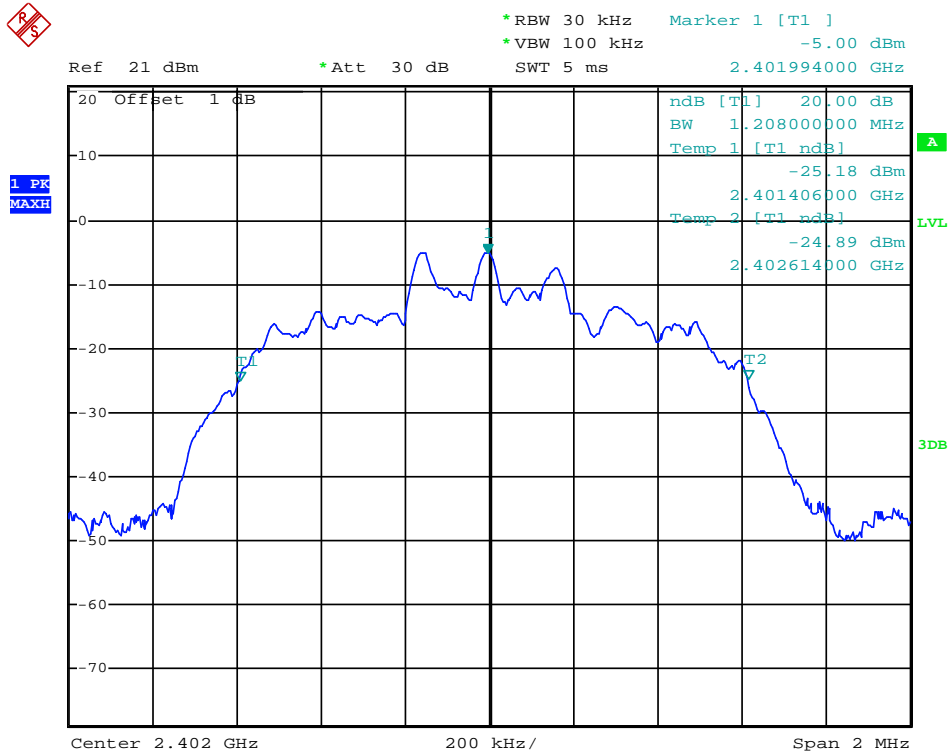

Date: 6.JAN.2014 16:03:31

(Plot 4.4.3 A: Channel 00: 2402MHz @ $\pi/4$ DQPSK)



*RBW 30 kHz Marker 1 [T1]
*VBW 100 kHz -4.64 dBm
Ref 21 dBm *Att 30 dB SWI 5 ms 2.440840000 GHz

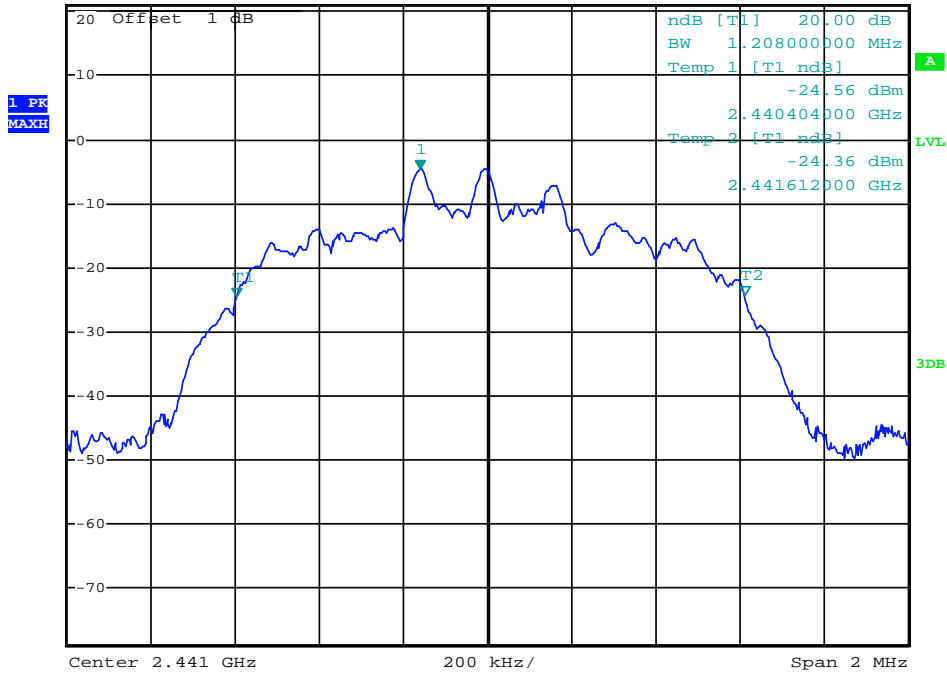

Date: 6.JAN.2014 16:04:07

(Plot 4.4.3 B: Channel 39: 2441MHz @ $\pi/4$ DQPSK)



*RBW 30 kHz Marker 1 [T1]
*VBW 100 kHz -4.48 dBm
Ref 21 dBm *Att 30 dB SWI 5 ms 2.479840000 GHz

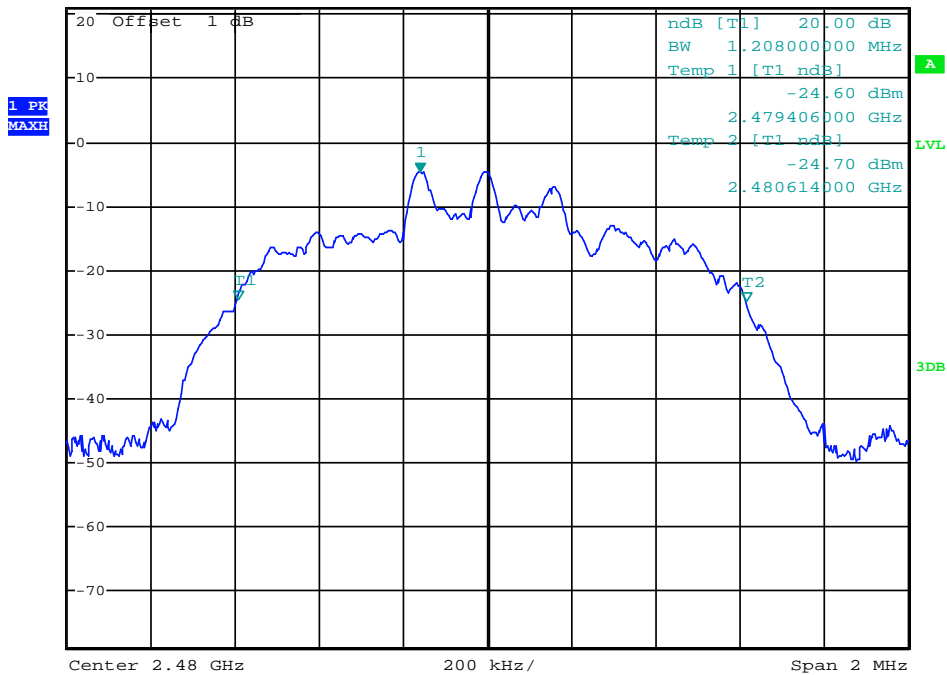

Date: 6.JAN.2014 16:04:38

(Plot 4.4.3 C: Channel 78: 2480MHz @ $\pi/4$ DQPSK)

4.5. Band Edge

Applicable Standard

In any 100 kHz bandwidth outside the frequency band in which the spread spectrum or digitally modulated intentional radiator is operating, the radio frequency power that is produced by the intentional radiator shall be at least 20 dB below that in the 100 kHz bandwidth within the band that contains the highest level of the desired power, based on either an RF conducted or a radiated measurement, provided the transmitter demonstrates compliance with the peak conducted power limits. If the transmitter complies with the conducted power limits based on the use of RMS averaging over a time interval, as permitted under paragraph (b)(3) of this section, the attenuation required under this paragraph shall be 30 dB instead of 20 dB. Attenuation below the general limits specified in §15.209(a) is not required. In addition, radiated emissions which fall in the restricted bands, as defined in §15.205(a), must also comply with the radiated emission limits specified in §15.209(a) (see §15.205(c)).

TEST PROCEDURE

1. Check the calibration of the measuring instrument using either an internal calibrator or a known signal from an external generator.
2. Remove the antenna from the EUT and then connect to a low loss RF cable from the antenna port to a EMI test receiver, then turn on the EUT and make it operate in transmitting mode. Then set it to Low Channel and High Channel within its operating range, and make sure the instrument is operated in its linear range.
3. Set both RBW and VBW of spectrum analyzer to 100 kHz with a convenient frequency span including 100kHz bandwidth from band edge, for Radiated emissions restricted band RBW=1MHz, VBW=3MHz.
4. Measure the highest amplitude appearing on spectral display and set it as a reference level. Plot the graph with marking the highest point and edge frequency.
5. Repeat above procedures until all measured frequencies were complete.

TEST RESULTS

Remark: we measured all conditions(DH1,DH3,DH5) and recorded worst case at DH1

4.5.1 For Radiated Bandedge Measurement

Remark: we tested radiated bandedge at both hopping and no-hopping modes,recorded worst case at no-hopping mode

4.5.1.1 GFSK Test Mode

Data: 235 File: D:\E3\HTW\0107.EM6 (235)

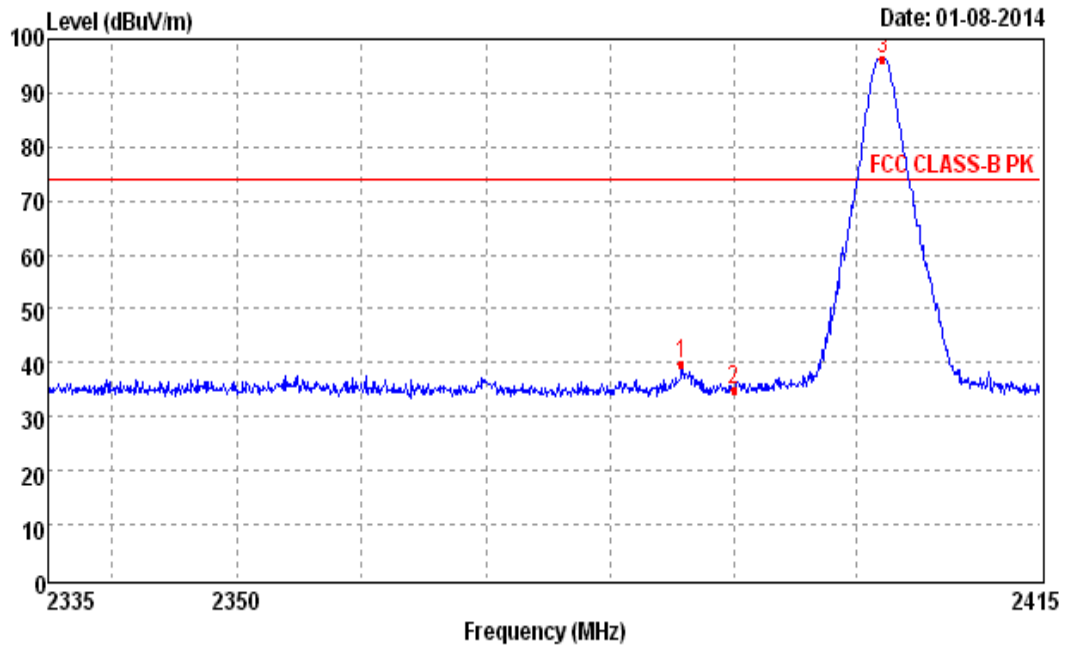

Mark	Frequency (MHz)	Level (dBuV/m)	Cable Loss (dB)	Antenna Factor (dB/m)	Preamp Factor (dB)	Reading Level (dBuV/m)	Limit (dBuV/m)	Margin (dB)	Antenna Polarization	Detector
1	2390.00	34.77	3.32	27.49	36.12	40.05	74.00	39.23	Hor	Peak
2	2402.25	99.77	3.32	27.49	36.12	101.67	74.00	-22.36	Hor	Peak

Data: 236 File: D:\E3\HTW\0107.EM6 (236)

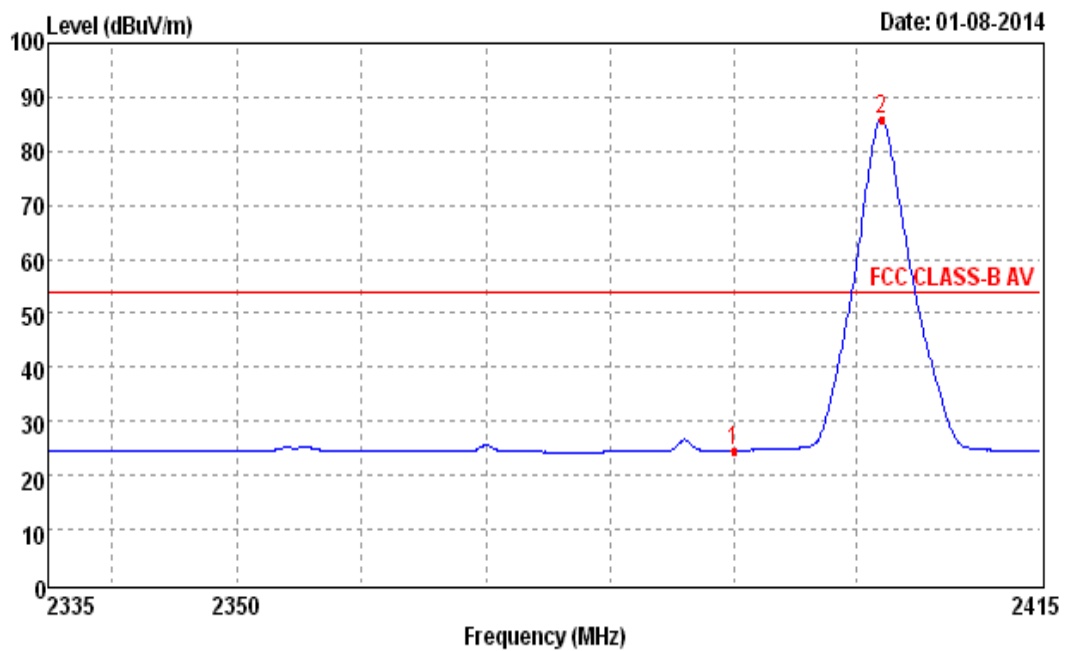

Mark	Frequency (MHz)	Level (dBuV/m)	Cable Loss (dB)	Antenna Factor (dB/m)	Preamp Factor (dB)	Reading Level (dBuV/m)	Limit (dBuV/m)	Margin (dB)	Antenna Polarization	Detector
1	2390.00	24.61	3.32	27.49	36.12	29.89	54.00	29.39	Hor	Average
2	2402.25	85.89	3.32	27.49	36.12	91.20	54.00	-31.89	Hor	Average

Data: 237 File: D:\E3\HTW\0107.EM6 (237)

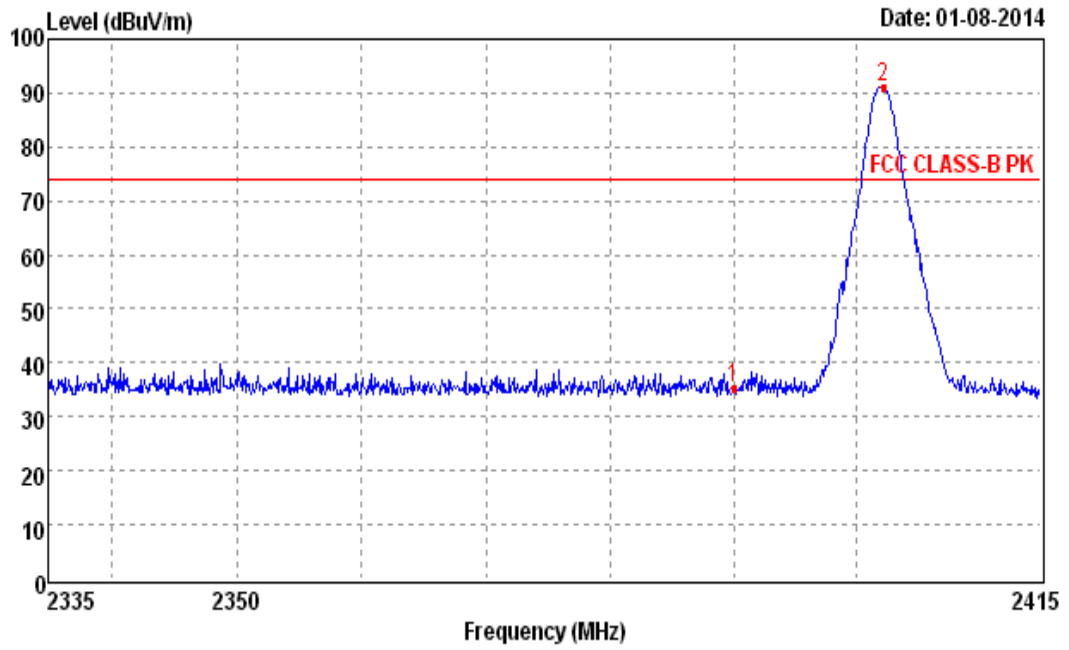

Mark	Frequency (MHz)	Level (dBuV/m)	Cable Loss (dB)	Antenna Factor (dB/m)	Preamp Factor (dB)	Reading Level (dBuV/m)	Limit (dBuV/m)	Margin (dB)	Antenna Polarization	Detector
1	2390.00	35.18	3.32	27.49	36.12	40.46	74.00	38.82	Ver	Peak
2	2402.25	91.07	3.32	27.49	36.12	96.38	74.00	-17.07	Ver	Peak

Data: 238 File: D:\E3\HTW\0107.EM6 (238)

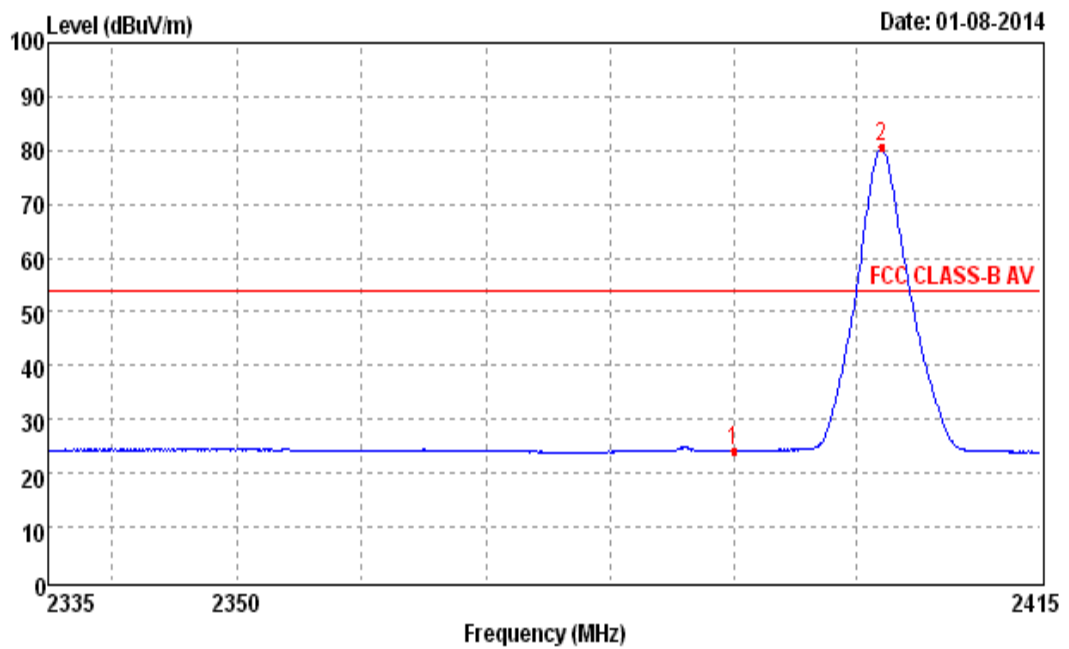

Mark	Frequency (MHz)	Level (dBuV/m)	Cable Loss (dB)	Antenna Factor (dB/m)	Preamp Factor (dB)	Reading Level (dBuV/m)	Limit (dBuV/m)	Margin (dB)	Antenna Polarization	Detector
1	2390.00	24.19	3.32	27.49	36.12	29.47	54.00	29.81	Ver	Average
2	2402.25	80.55	3.32	27.49	36.12	85.86	54.00	-26.55	Ver	Average

Data: 222 File: D:\E3\HTW\0107.EM6 (222)

Date: 01-08-2014

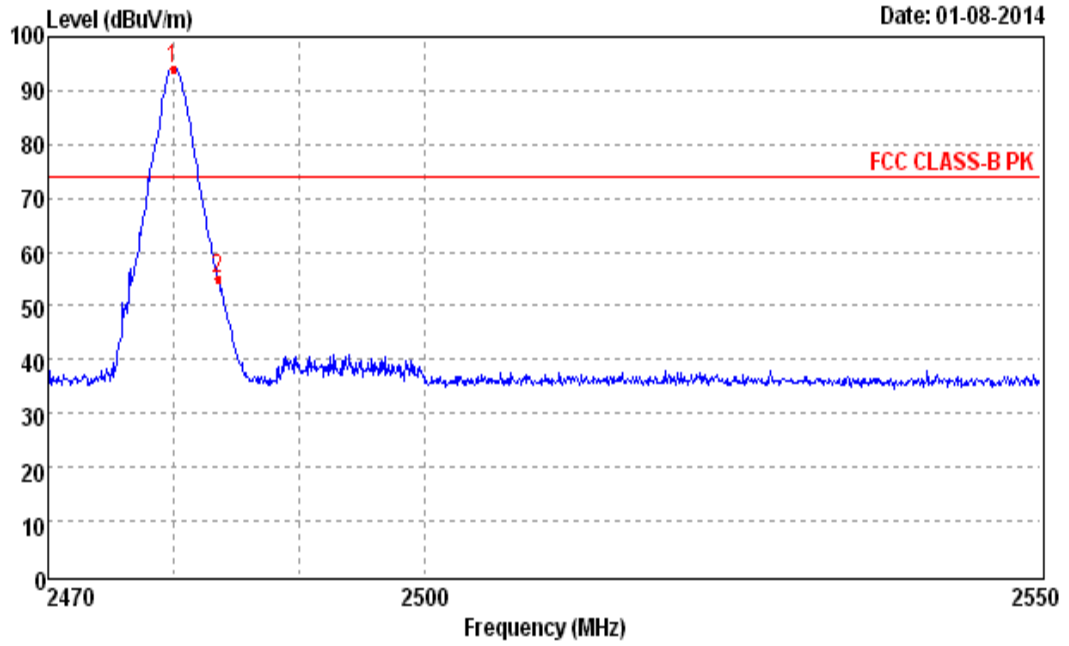

Mark	Frequency (MHz)	Level (dBUV/m)	Cable Loss (dB)	Antenna Factor (dB/m)	Preamp Factor (dB)	Reading Level (dBUV/m)	Limit (dBUV/m)	Margin (dB)	Antenna Polarization	Detector
1	2479.86	94.23	3.88	27.45	36.55	99.45	74.00	-20.23	Hor	Peak
2	2483.50	55.15	3.88	27.45	36.55	60.37	74.00	18.85	Hor	Peak

Data: 223 File: D:\E3\HTW\0107.EM6 (223)

Date: 01-08-2014

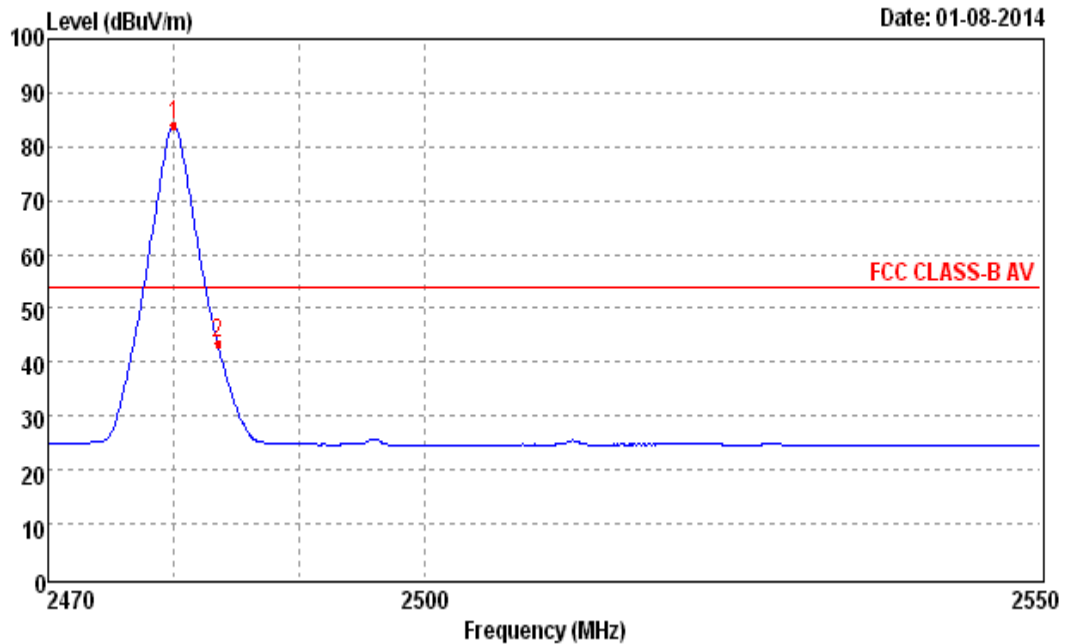

Mark	Frequency (MHz)	Level (dBUV/m)	Cable Loss (dB)	Antenna Factor (dB/m)	Preamp Factor (dB)	Reading Level (dBUV/m)	Limit (dBUV/m)	Margin (dB)	Antenna Polarization	Detector
1	2480.02	83.95	3.88	27.45	36.55	89.17	54.00	-29.95	Hor	Average
2	2483.50	43.52	3.88	27.45	36.55	48.74	54.00	10.48	Hor	Average

Data: 225 File: D:\E3\HTW\0107.EM6 (225)

Date: 01-08-2014

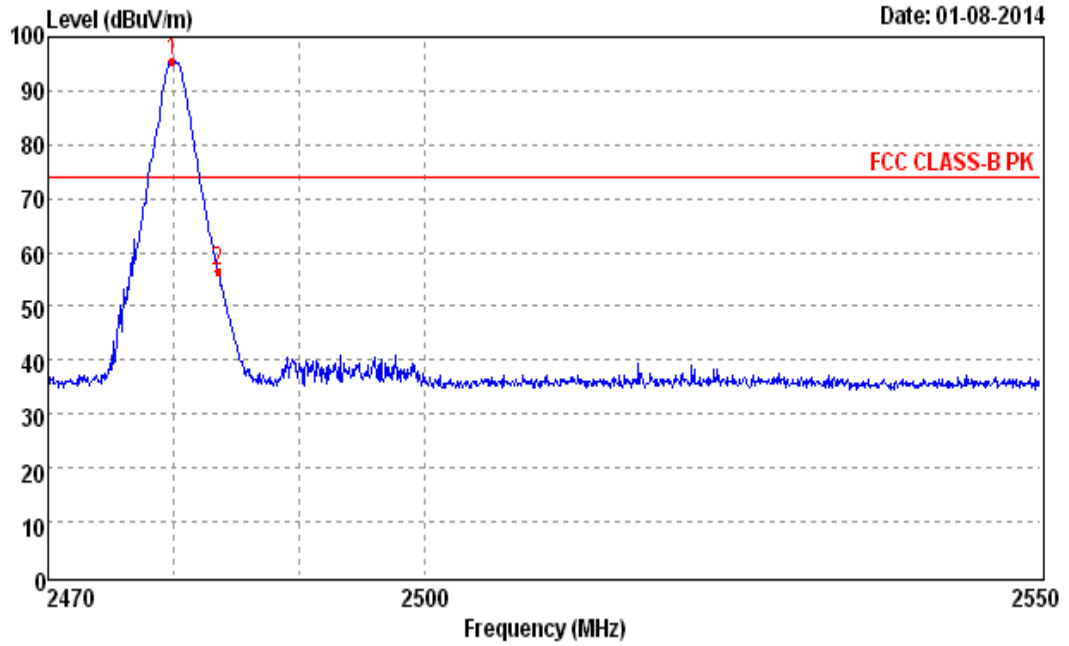

Mark	Frequency (MHz)	Level (dBuV/m)	Cable Loss (dB)	Antenna Factor (dB/m)	Preamp Factor (dB)	Reading Level (dBuV/m)	Limit (dBuV/m)	Margin (dB)	Antenna Polarization	Detector
1	2480.07	95.49	3.88	27.45	36.55	100.71	74.00	-21.49	Ver	Peak
2	2483.50	56.69	3.88	27.45	36.55	61.91	74.00	17.31	Ver	Peak

Data: 226 File: D:\E3\HTW\0107.EM6 (226)

Date: 01-08-2014

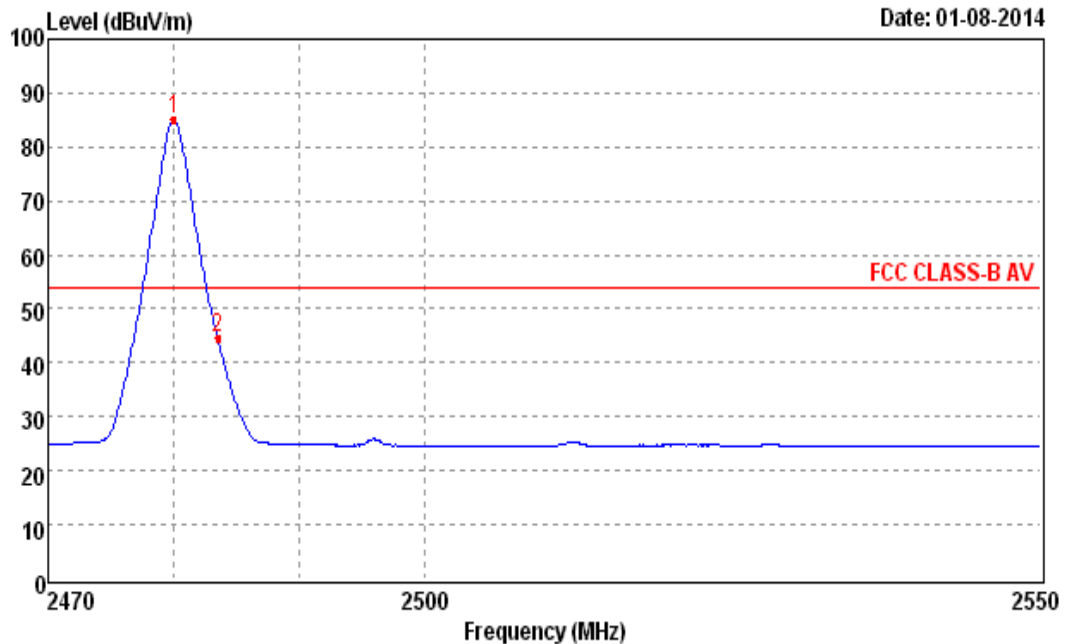

Mark	Frequency (MHz)	Level (dBuV/m)	Cable Loss (dB)	Antenna Factor (dB/m)	Preamp Factor (dB)	Reading Level (dBuV/m)	Limit (dBuV/m)	Margin (dB)	Antenna Polarization	Detector
1	2479.89	85.07	3.88	27.45	36.55	90.29	54.00	-31.07	Ver	Average
2	2483.50	44.46	3.88	27.45	36.55	49.68	54.00	9.54	Ver	Average

4.5.1.2 8DPSK Test Mode

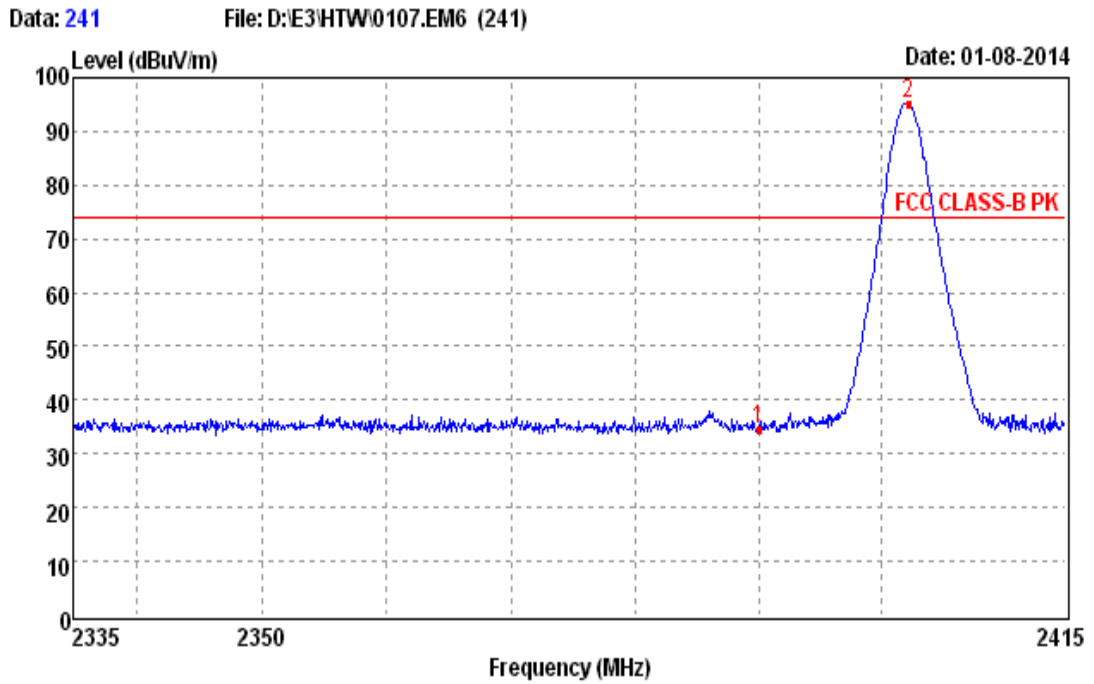

Mark	Frequency (MHz)	Level (dBuV/m)	Cable Loss (dB)	Antenna Factor (dB/m)	Preamp Factor (dB)	Reading Level (dBuV/m)	Limit (dBuV/m)	Margin (dB)	Antenna Polarization	Detector
1	2390.00	34.62	3.32	27.49	36.12	39.90	74.00	39.38	Hor	Peak
2	2402.15	95.17	3.32	27.49	36.12	100.48	74.00	-21.17	Hor	Peak

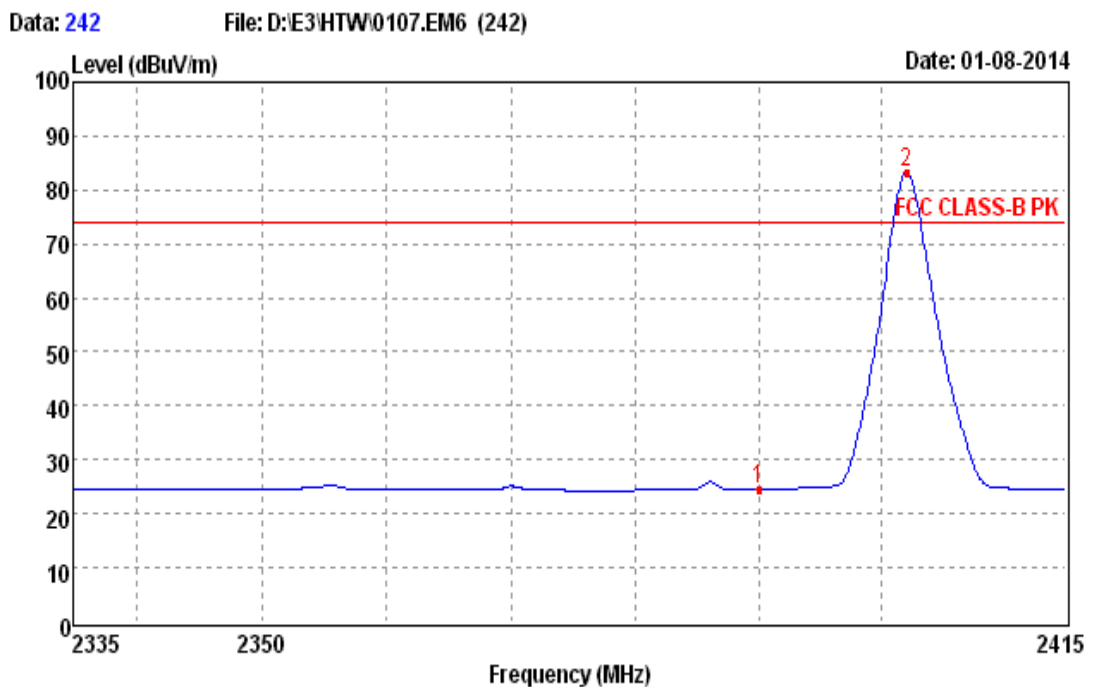

Mark	Frequency (MHz)	Level (dBuV/m)	Cable Loss (dB)	Antenna Factor (dB/m)	Preamp Factor (dB)	Reading Level (dBuV/m)	Limit (dBuV/m)	Margin (dB)	Antenna Polarization	Detector
1	2390.00	24.59	3.32	27.49	36.12	29.87	54.00	29.41	Hor	Average
2	2402.15	83.28	3.32	27.49	36.12	88.59	54.00	-23.28	Hor	Average

Data: 239 File: D:\E3\HTW\0107.EM6 (239)

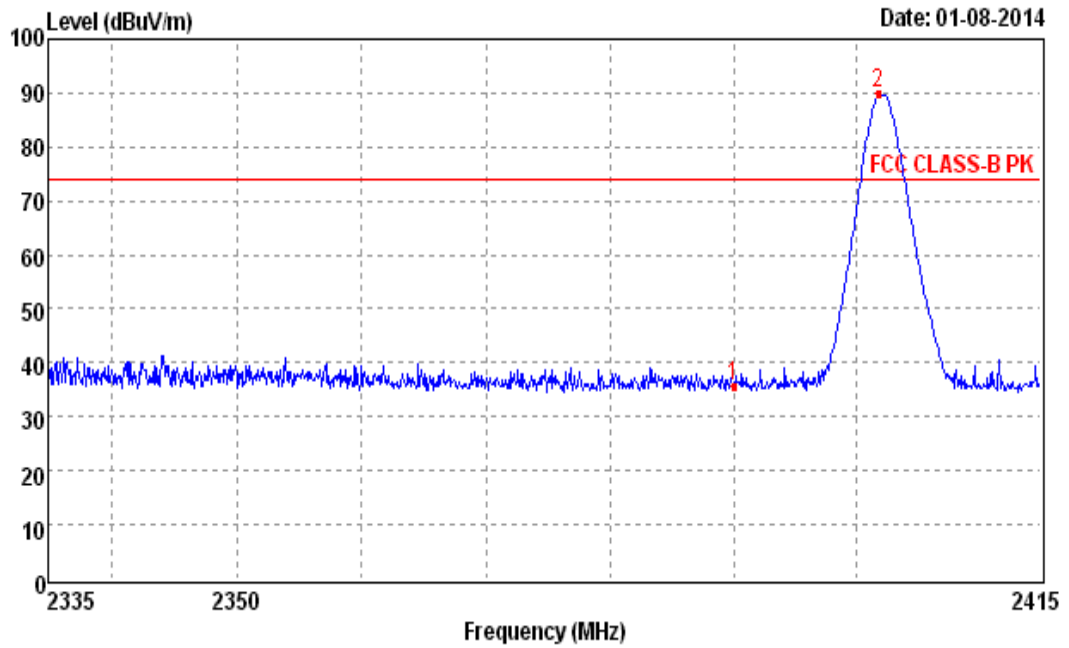

Mark	Frequency (MHz)	Level (dBuV/m)	Cable Loss (dB)	Antenna Factor (dB/m)	Preamp Factor (dB)	Reading Level (dBuV/m)	Limit (dBuV/m)	Margin (dB)	Antenna Polarization	Detector
1	2390.00	35.82	3.32	27.49	36.12	41.10	74.00	38.18	Ver	Peak
2	2402.05	89.84	3.32	27.49	36.12	95.15	74.00	-15.84	Ver	Peak

Data: 240 File: D:\E3\HTW\0107.EM6 (240)

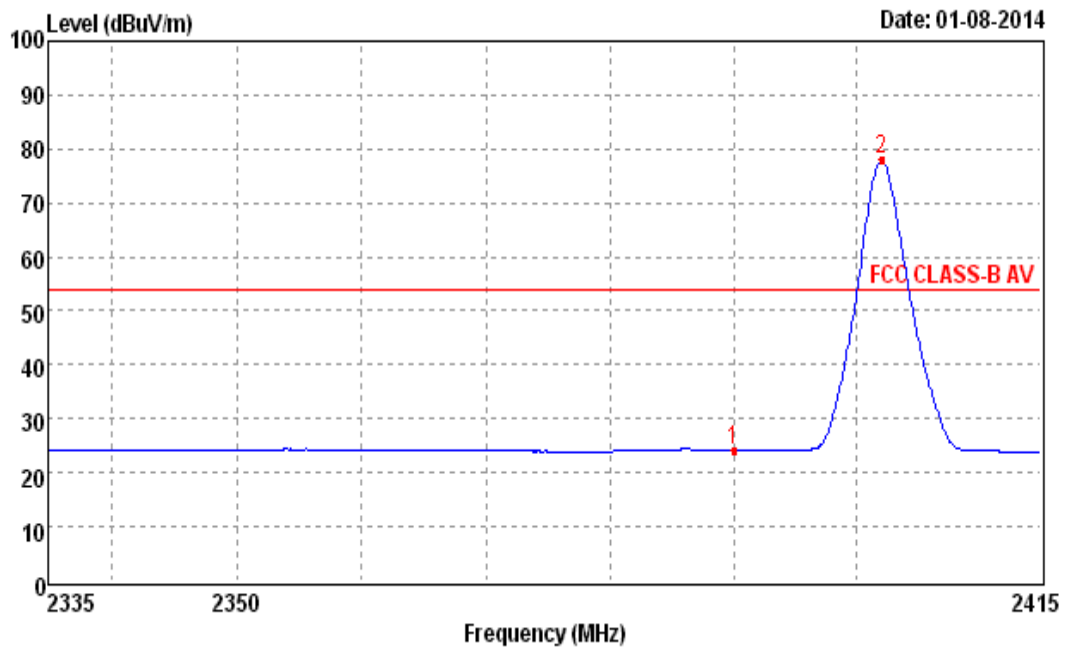

Mark	Frequency (MHz)	Level (dBuV/m)	Cable Loss (dB)	Antenna Factor (dB/m)	Preamp Factor (dB)	Reading Level (dBuV/m)	Limit (dBuV/m)	Margin (dB)	Antenna Polarization	Detector
1	2390.00	24.09	3.32	27.49	36.12	29.37	54.00	29.91	Ver	Average
2	2402.15	77.90	3.32	27.49	36.12	83.21	54.00	-23.90	Ver	Average

Data: 227 File: D:\E3\HTW\0107.EM6 (227)

Date: 01-08-2014

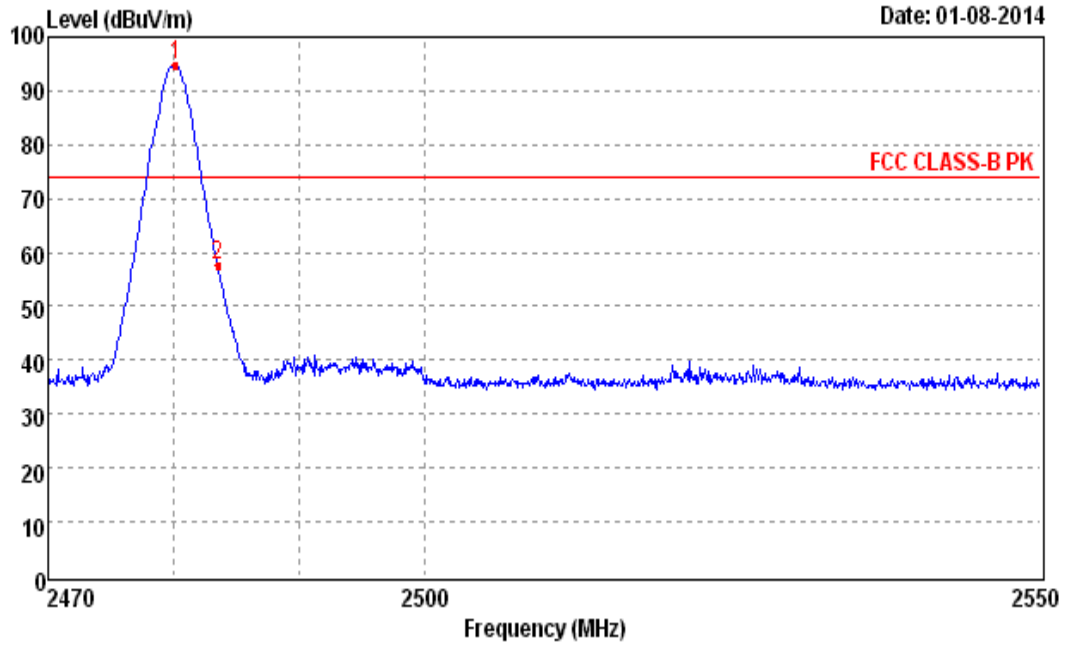

Mark	Frequency (MHz)	Level (dBuV/m)	Cable Loss (dB)	Antenna Factor (dB/m)	Preamp Factor (dB)	Reading Level (dBuV/m)	Limit (dBuV/m)	Margin (dB)	Antenna Polarization	Detector
1	2480.04	94.66	3.88	27.45	36.55	99.88	74.00	-20.66	Hor	Peak
2	2483.50	57.47	3.88	27.45	36.55	62.69	74.00	16.53	Hor	Peak

Data: 228 File: D:\E3\HTW\0107.EM6 (228)

Date: 01-08-2014

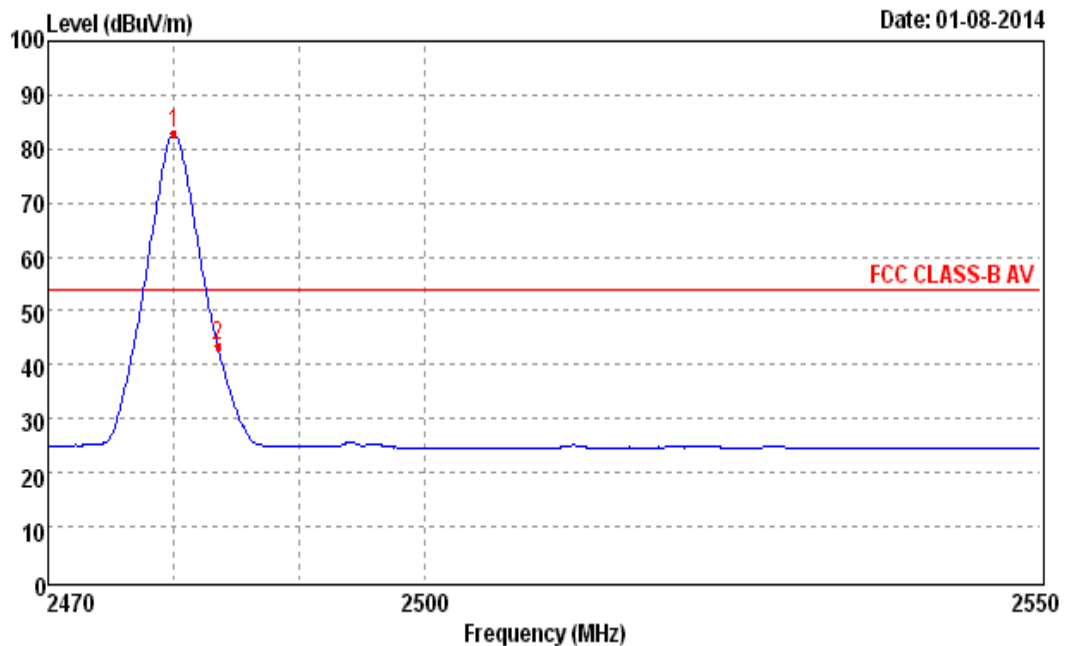

Mark	Frequency (MHz)	Level (dBuV/m)	Cable Loss (dB)	Antenna Factor (dB/m)	Preamp Factor (dB)	Reading Level (dBuV/m)	Limit (dBuV/m)	Margin (dB)	Antenna Polarization	Detector
1	2749.92	82.88	3.88	27.45	36.55	88.10	54.00	-28.88	Hor	Average
2	2483.50	43.63	3.88	27.45	36.55	48.85	54.00	10.37	Hor	Average

Data: 229 File: D:\E3\HTW\0107.EM6 (229)

Date: 01-08-2014

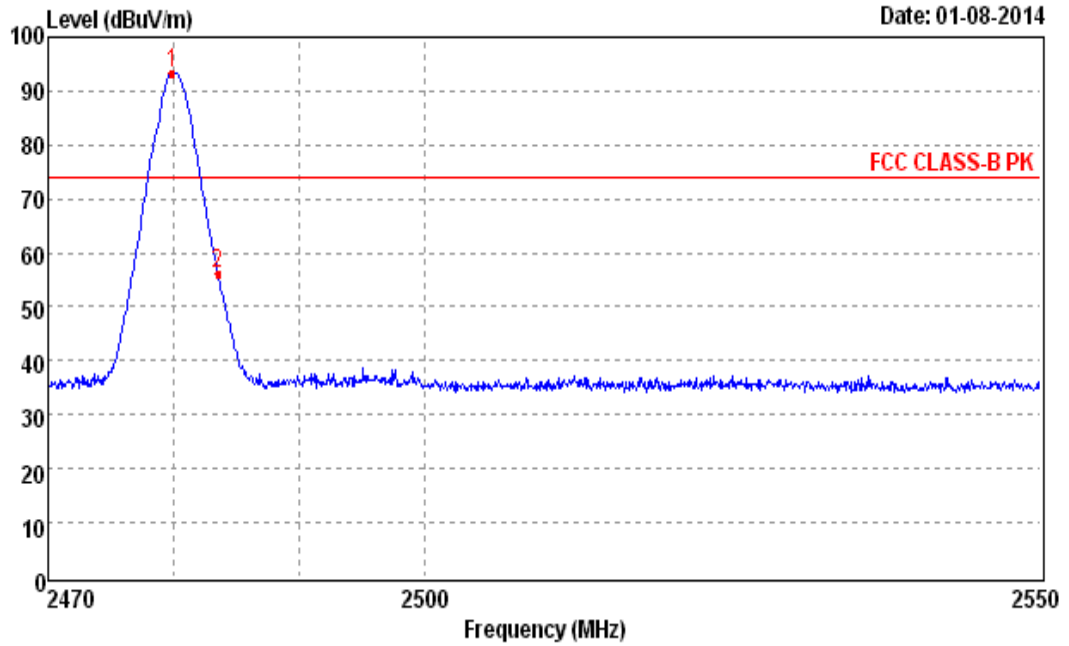

Mark	Frequency (MHz)	Level (dBuV/m)	Cable Loss (dB)	Antenna Factor (dB/m)	Preamp Factor (dB)	Reading Level (dBuV/m)	Limit (dBuV/m)	Margin (dB)	Antenna Polarization	Detector
1	2480.04	93.42	3.88	27.45	36.55	99.64	74.00	-19.42	Ver	Peak
2	2483.50	55.98	3.88	27.45	36.55	61.20	74.00	18.02	Ver	Peak

Data: 230 File: D:\E3\HTW\0107.EM6 (230)

Date: 01-08-2014

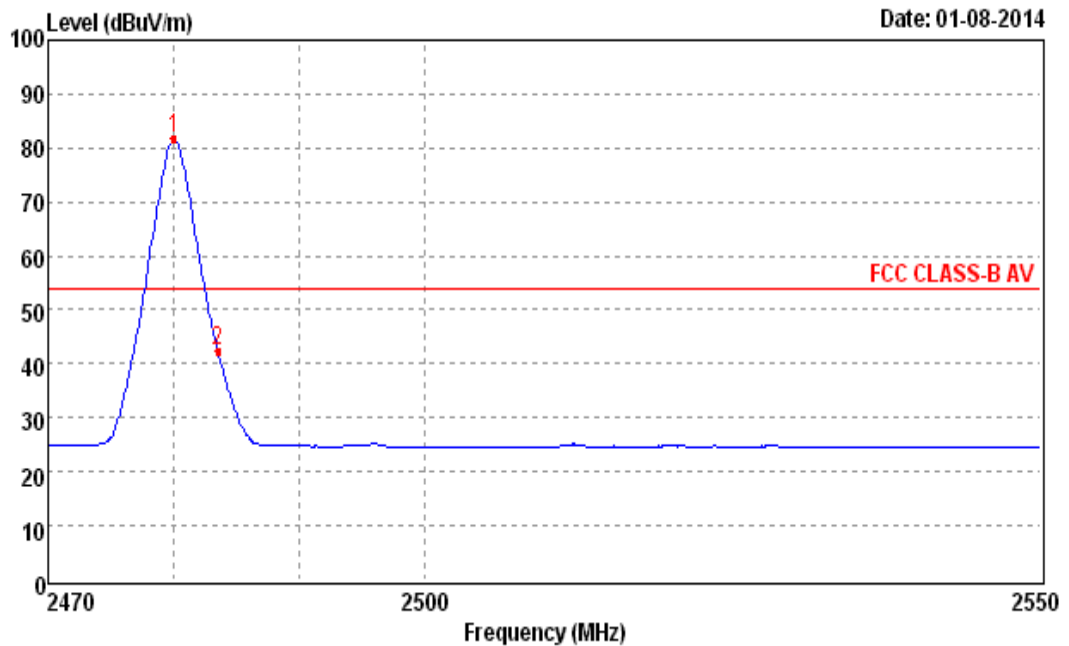

Mark	Frequency (MHz)	Level (dBuV/m)	Cable Loss (dB)	Antenna Factor (dB/m)	Preamp Factor (dB)	Reading Level (dBuV/m)	Limit (dBuV/m)	Margin (dB)	Antenna Polarization	Detector
1	2480.07	81.68	3.88	27.45	36.55	86.90	54.00	-27.68	Ver	Average
2	2483.50	42.54	3.88	27.45	36.55	47.76	54.00	11.46	Ver	Average

4.5.1.3 $\pi/4$ DQPSK Test Mode

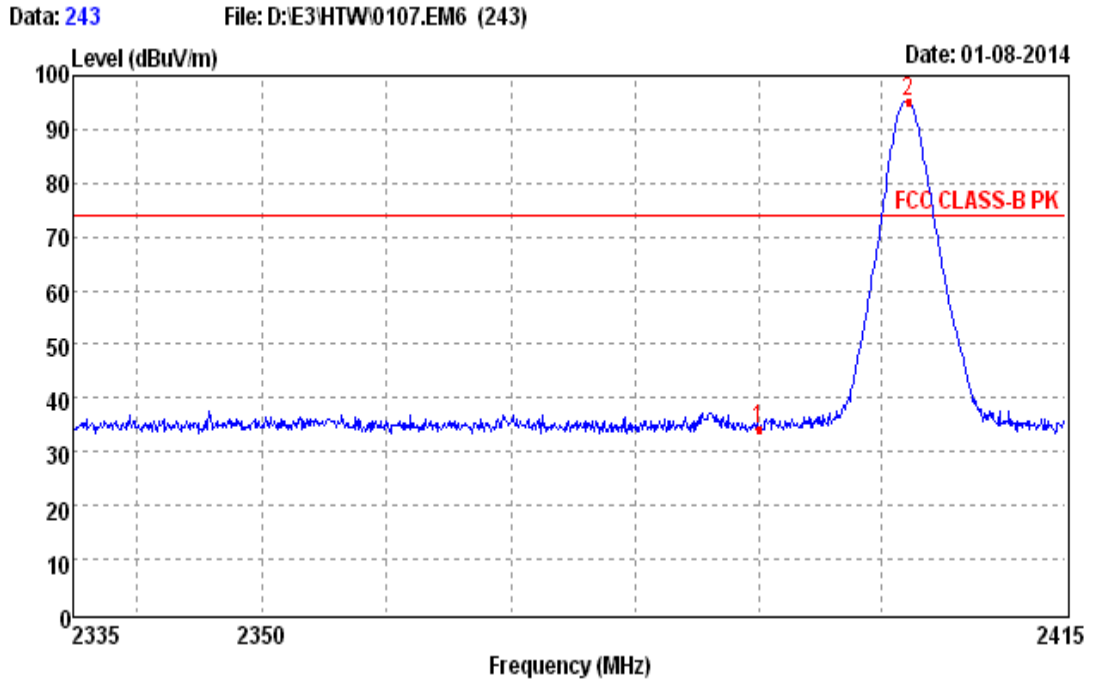

Mark	Frequency (MHz)	Level (dBuV/m)	Cable Loss (dB)	Antenna Factor (dB/m)	Preamp Factor (dB)	Reading Level (dBuV/m)	Limit (dBuV/m)	Margin (dB)	Antenna Polarization	Detector
1	2390.00	34.12	3.32	27.49	36.12	39.40	74.00	39.88	Hor	Peak
2	2402.05	95.15	3.32	27.49	36.12	100.46	74.00	-21.15	Hor	Peak

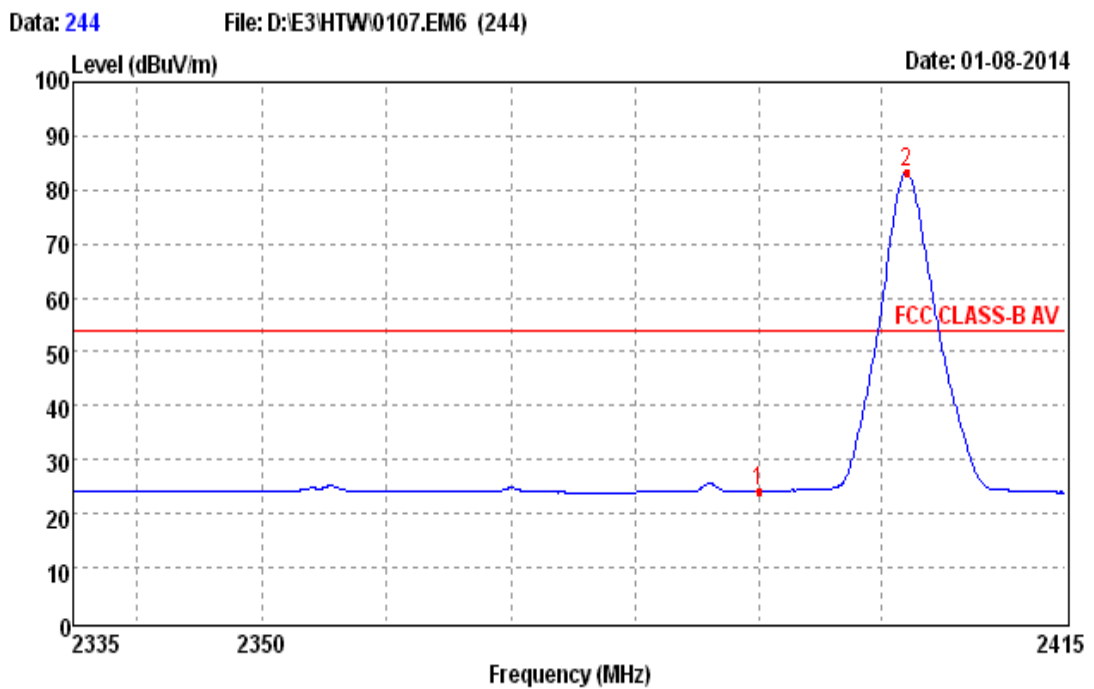

Mark	Frequency (MHz)	Level (dBuV/m)	Cable Loss (dB)	Antenna Factor (dB/m)	Preamp Factor (dB)	Reading Level (dBuV/m)	Limit (dBuV/m)	Margin (dB)	Antenna Polarization	Detector
1	2390.00	24.23	3.32	27.49	36.12	29.51	54.00	29.77	Hor	Average
2	2402.25	83.25	3.32	27.49	36.12	88.56	54.00	-29.25	Hor	Average

Data: 246 File: D:\E3\HTW\0107.EM6 (246)

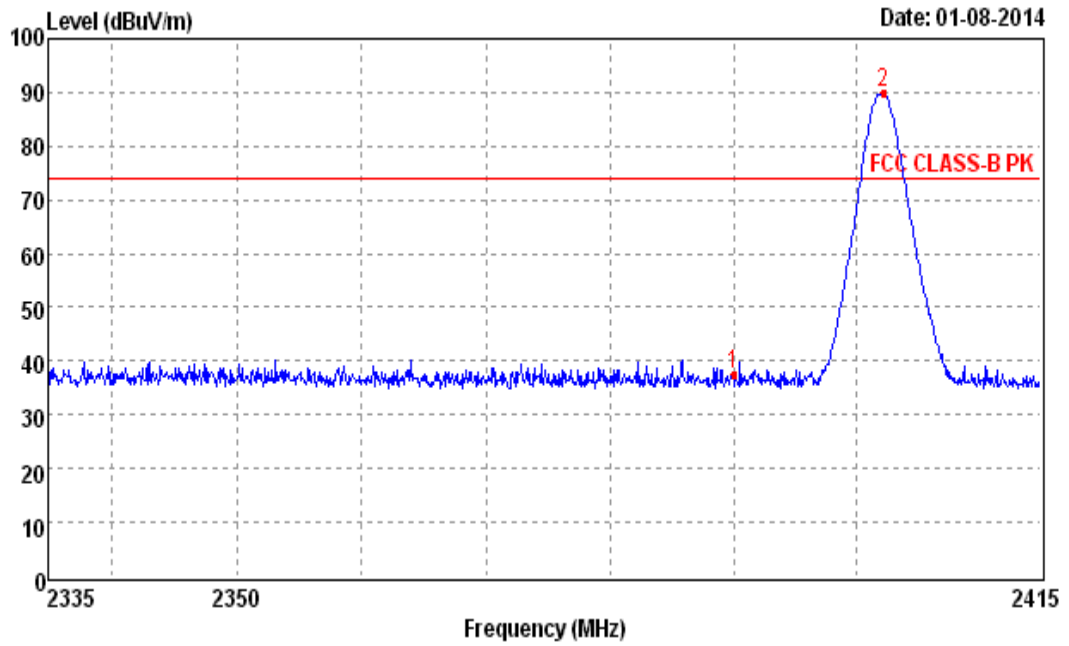

Mark	Frequency (MHz)	Level (dBuV/m)	Cable Loss (dB)	Antenna Factor (dB/m)	Preamp Factor (dB)	Reading Level (dBuV/m)	Limit (dBuV/m)	Margin (dB)	Antenna Polarization	Detector
1	2390.00	37.40	3.32	27.49	36.12	42.68	74.00	36.60	Ver	Peak
2	2402.15	89.80	3.32	27.49	36.12	95.11	74.00	-15.80	Ver	Peak

Data: 247 File: D:\E3\HTW\0107.EM6 (247)

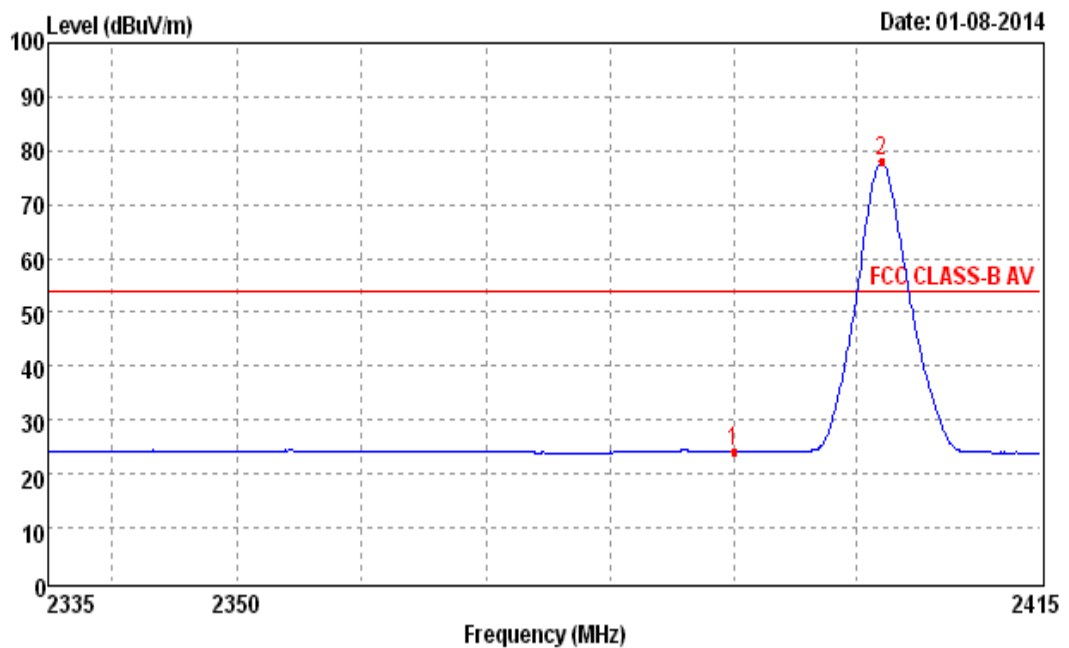

Mark	Frequency (MHz)	Level (dBuV/m)	Cable Loss (dB)	Antenna Factor (dB/m)	Preamp Factor (dB)	Reading Level (dBuV/m)	Limit (dBuV/m)	Margin (dB)	Antenna Polarization	Detector
1	2390.00	24.05	3.32	27.49	36.12	29.33	54.00	29.95	Ver	Average
2	2402.25	77.89	3.32	27.49	36.12	83.20	54.00	-23.89	Ver	Average

Data: 233 File: D:\E3\HTW\0107.EM6 (233)

Date: 01-08-2014

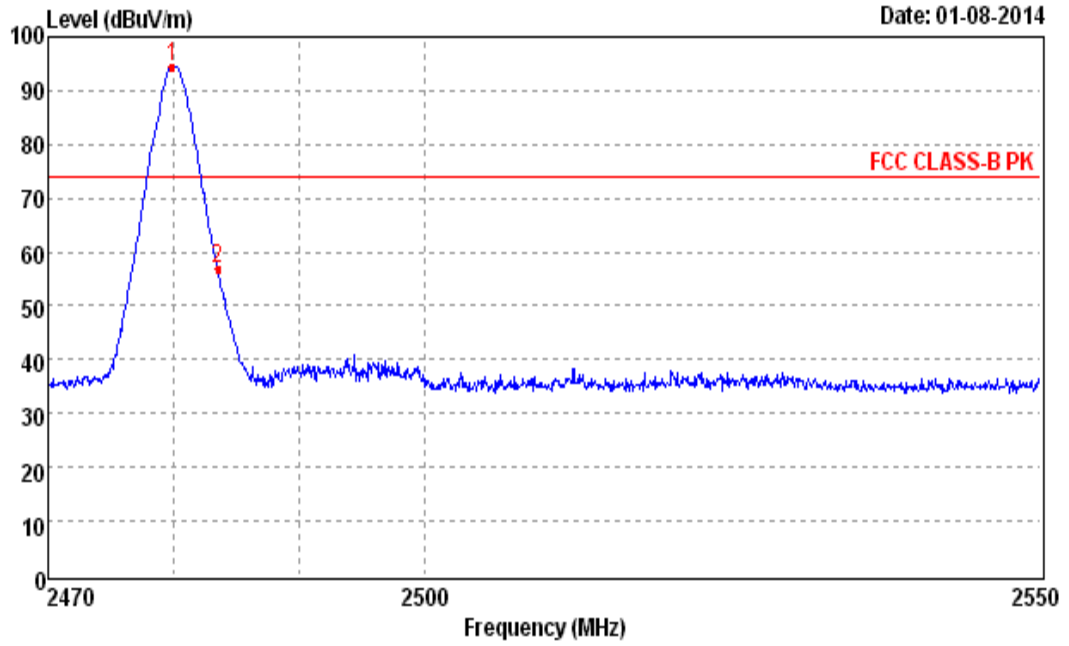

Mark	Frequency (MHz)	Level (dBuV/m)	Cable Loss (dB)	Antenna Factor (dB/m)	Preamp Factor (dB)	Reading Level (dBuV/m)	Limit (dBuV/m)	Margin (dB)	Antenna Polarization	Detector
1	2479.80	94.46	3.88	27.45	36.55	99.68	74.00	-20.46	Hor	Peak
2	2483.50	56.97	3.88	27.45	36.55	62.19	74.00	17.03	Hor	Peak

Data: 234 File: D:\E3\HTW\0107.EM6 (234)

Date: 01-08-2014

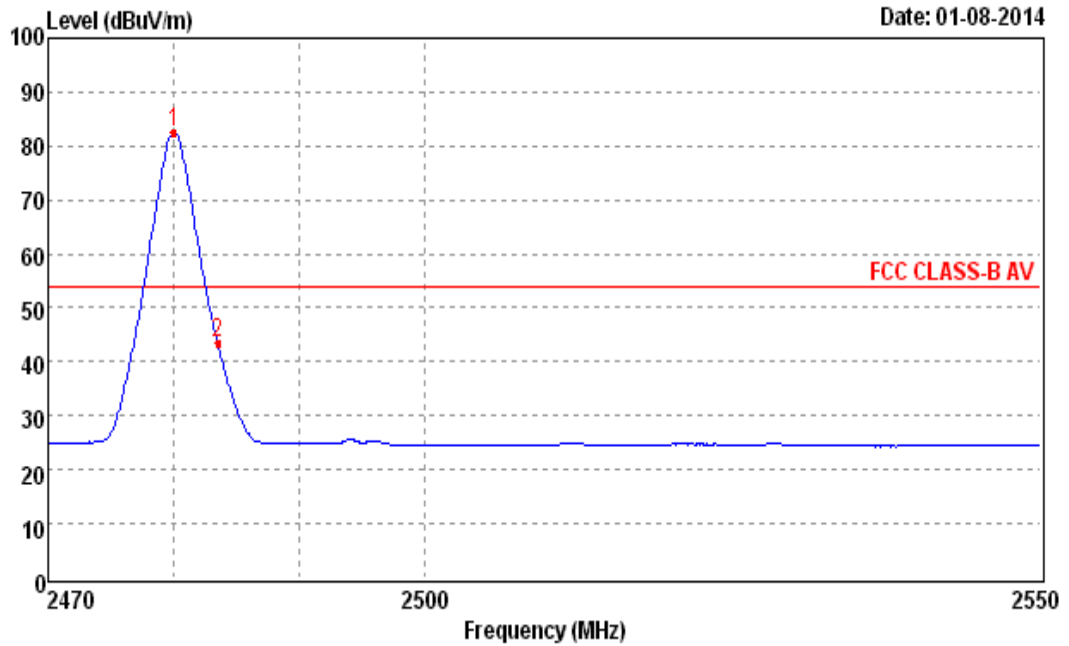

Mark	Frequency (MHz)	Level (dBuV/m)	Cable Loss (dB)	Antenna Factor (dB/m)	Preamp Factor (dB)	Reading Level (dBuV/m)	Limit (dBuV/m)	Margin (dB)	Antenna Polarization	Detector
1	2480.13	82.70	3.88	27.45	36.55	87.92	54.00	-28.70	Hor	Average
2	2483.50	43.34	3.88	27.45	36.55	48.56	54.00	10.66	Hor	Average

Data: 231 File: D:\E3\HTW\0107.EM6 (231)

Date: 01-08-2014

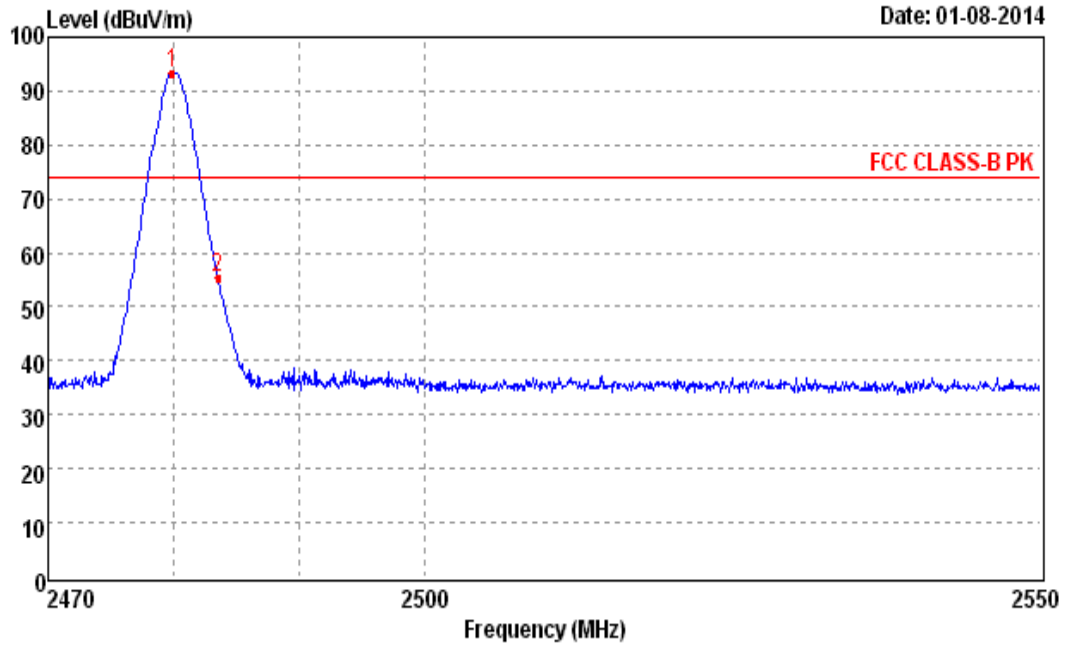

Mark	Frequency (MHz)	Level (dBuV/m)	Cable Loss (dB)	Antenna Factor (dB/m)	Preamp Factor (dB)	Reading Level (dBuV/m)	Limit (dBuV/m)	Margin (dB)	Antenna Polarization	Detector
1	2480.07	93.37	3.88	27.45	36.55	98.59	74.00	-19.37	Ver	Peak
2	2483.50	55.34	3.88	27.45	36.55	60.56	74.00	18.66	Ver	Peak

Data: 232 File: D:\E3\HTW\0107.EM6 (232)

Date: 01-08-2014

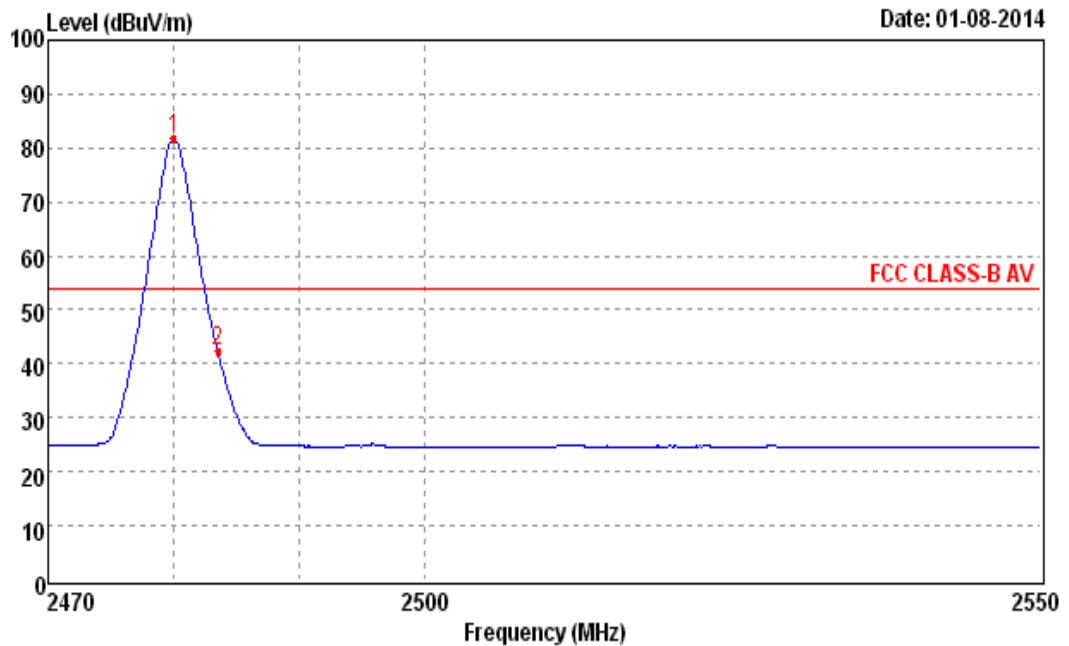

Mark	Frequency (MHz)	Level (dBuV/m)	Cable Loss (dB)	Antenna Factor (dB/m)	Preamp Factor (dB)	Reading Level (dBuV/m)	Limit (dBuV/m)	Margin (dB)	Antenna Polarization	Detector
1	2480.22	81.60	3.88	27.45	36.55	86.82	54.00	-27.60	Ver	Average
2	2483.50	42.29	3.88	27.45	36.55	47.51	54.00	11.71	Ver	Average

4.5.2 For Conducted Bandedge Measurement

4.5.2.1 GFSK Test Mode

A. Test Verdict

Frequency (MHz)	Delta Peak to Band emission (dBc)	Hopping Mode	Detector	Limit (dBc)	Refer to Plot	Verdict
2400.00	-43.70	OFF	Peak	-20	Plot 4.5.2.1 A	PASS
2400.00	-46.56	ON	Peak	-20	Plot 4.5.2.1 B	PASS
2483.50	-48.79	OFF	Peak	-20	Plot 4.5.2.1 C	PASS
2483.50	-46.89	ON	Peak	-20	Plot 4.5.2.1 D	PASS

B. Test Plots

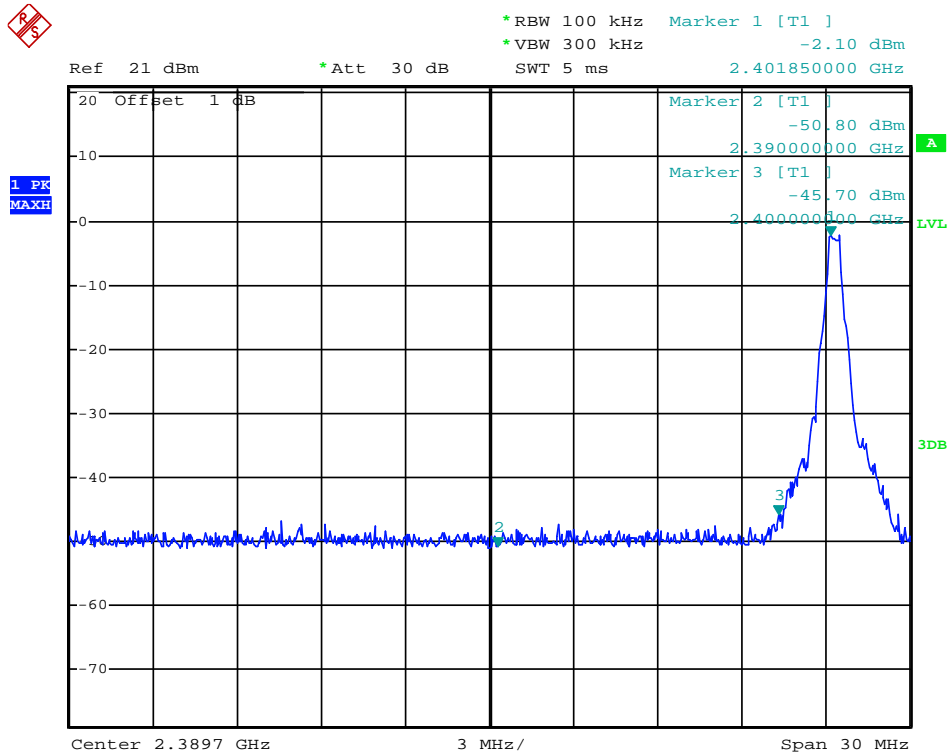

Date: 6.JAN.2014 16:20:29

(Plot 4.5.2.1 A: Channel 00: 2402MHz @ GFSK)



*RBW 100 kHz Marker 1 [T1]
*VBW 300 kHz -2.09 dBm
SWT 5 ms 2.403860000 GHz

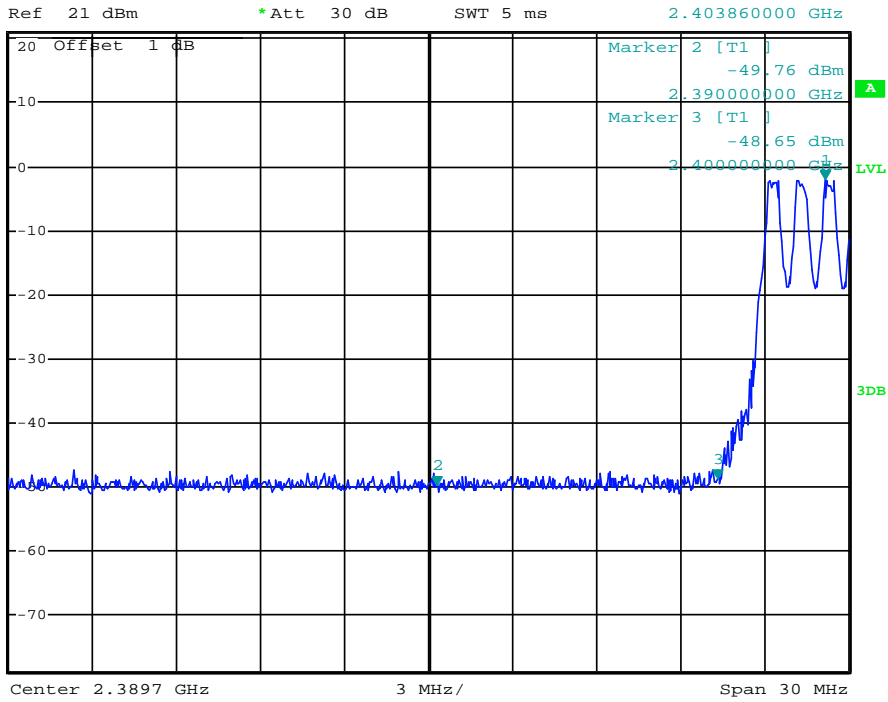

Date: 6.JAN.2014 16:21:37

(Plot 4.5.2.1 B: Hopping Mode @ GFSK)



*RBW 100 kHz Marker 1 [T1]
*VBW 300 kHz -1.79 dBm
SWT 5 ms 2.479850000 GHz

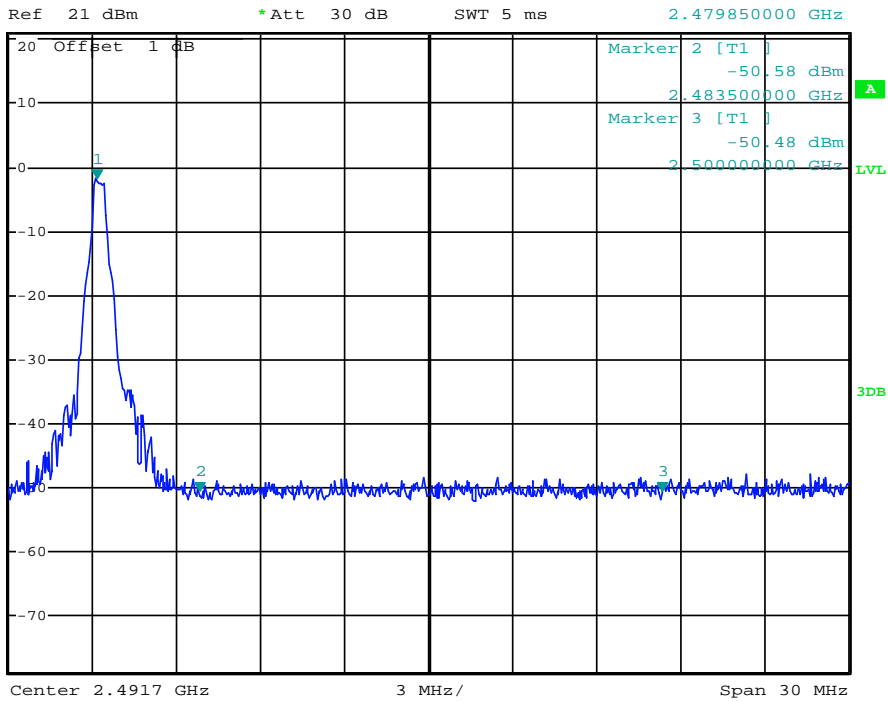

Date: 6.JAN.2014 16:28:57

(Plot 4.5.2.1 C: Channel 78: 2480MHz @ GFSK)

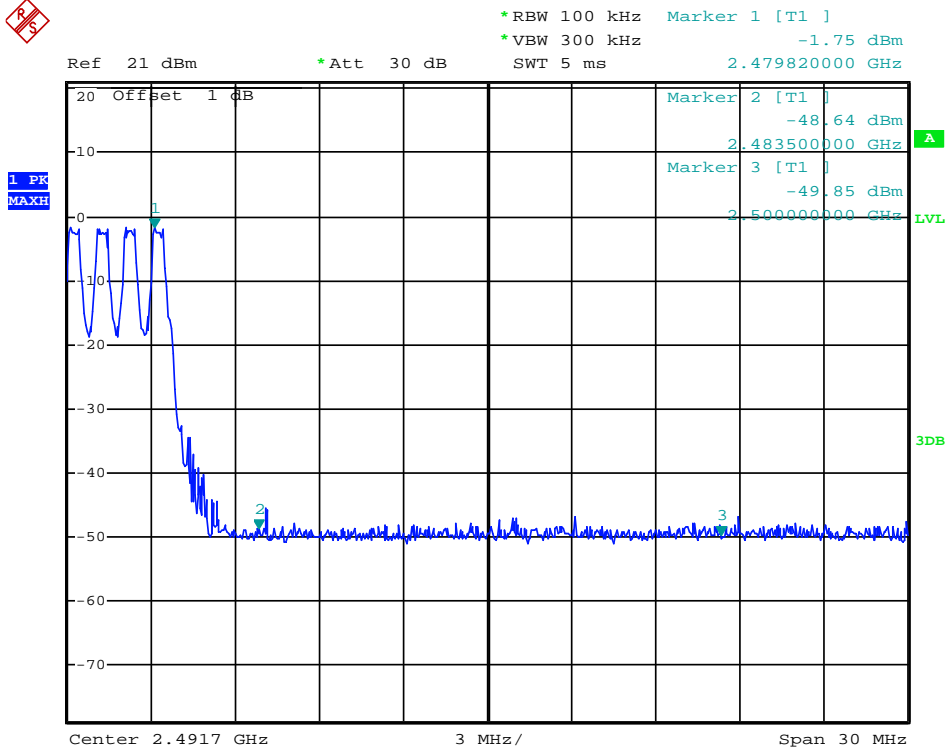

Date: 6.JAN.2014 16:30:06

(Plot 4.5.2.1 D: Hopping Mode @ GFSK)

4.5.2.2 8DPSK Test Mode

A. Test Verdict

Frequency (MHz)	Delta Peak to Band emission (dBc)	Hopping Mode	Detector	Limit (dBc)	Refer to Plot	Verdict
2400.00	-46.35	OFF	Peak	-20	Plot 4.5.2.2 A	PASS
2400.00	-45.64	ON	Peak	-20	Plot 4.5.2.2 B	PASS
2483.50	-48.18	OFF	Peak	-20	Plot 4.5.2.2 C	PASS
2483.50	-46.06	ON	Peak	-20	Plot 4.5.2.2 D	PASS

B. Test Plots

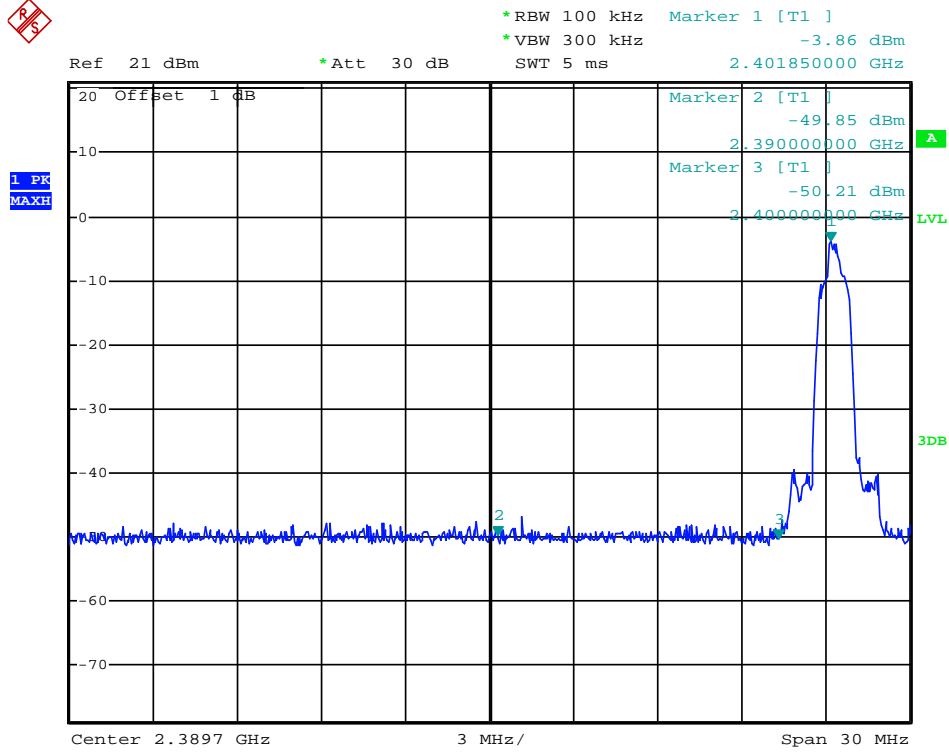

Date: 6.JAN.2014 16:22:17

(Plot 4.5.2.2 A: Channel 00: 2402MHz @ 8DPSK)

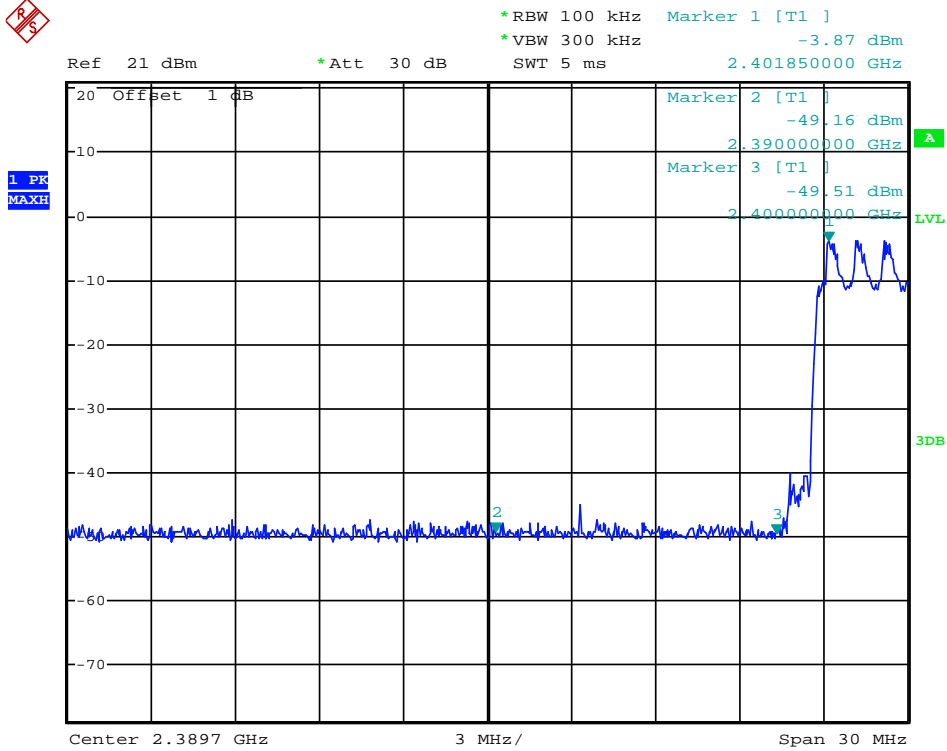

Date: 6.JAN.2014 16:23:43

(Plot 4.5.2.2 B: Hopping Mode @ 8DPSK)



*RBW 100 kHz Marker 1 [T1]
*VBW 300 kHz -3.33 dBm
SWT 5 ms 2.479820000 GHz

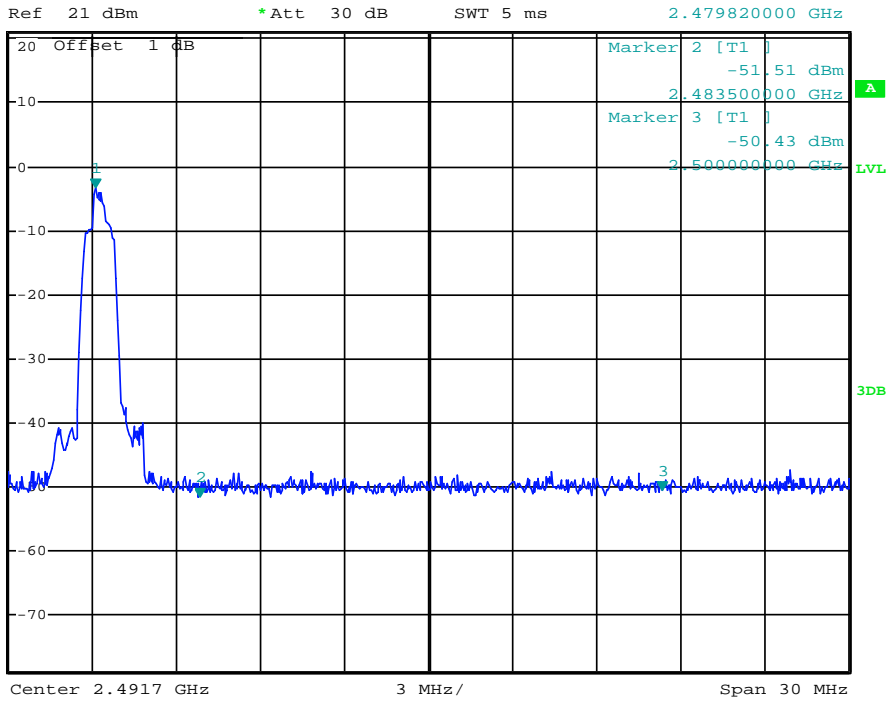

Date: 6.JAN.2014 16:30:59

(Plot 4.5.2.2 C: Channel 78: 2480MHz @ 8DPSK)



*RBW 100 kHz Marker 1 [T1]
*VBW 300 kHz -3.58 dBm
SWT 5 ms 2.478830000 GHz

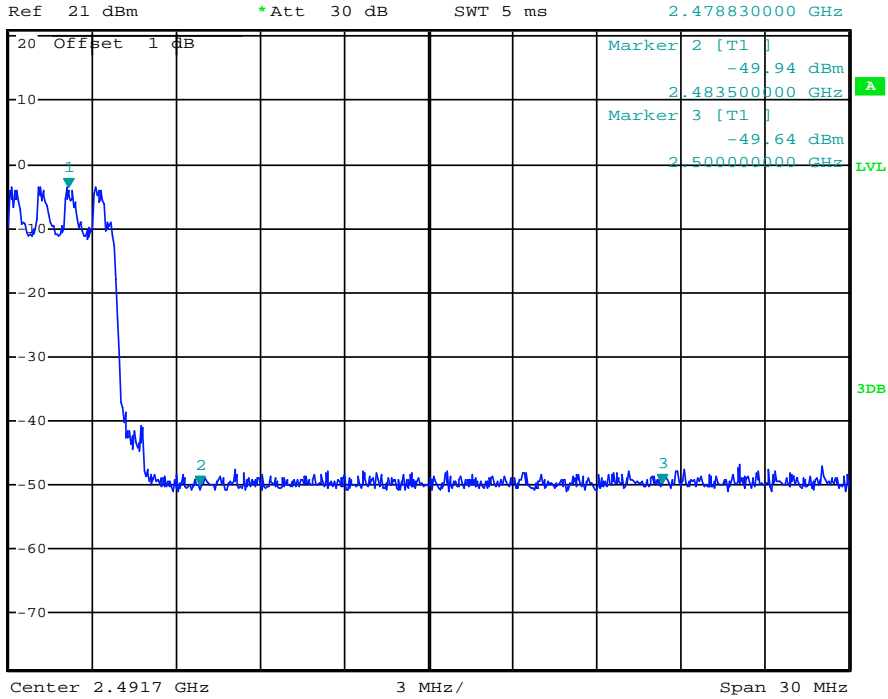

Date: 6.JAN.2014 16:32:03

(Plot 4.5.2.2 D: Hopping Mode @ 8DPSK)

4.5.2.3 $\pi/4$ DQPSK Test Mode

A. Test Verdict

Frequency (MHz)	Delta Peak to Band emission (dBc)	Hopping Mode	Detector	Limit (dBc)	Refer to Plot	Verdict
2400.00	-44.56	OFF	Peak	-20	Plot 4.5.2.3 A	PASS
2400.00	-44.85	ON	Peak	-20	Plot 4.5.2.3 B	PASS
2483.50	-46.07	OFF	Peak	-20	Plot 4.5.2.3 C	PASS
2483.50	-45.86	ON	Peak	-20	Plot 4.5.2.3 D	PASS

B. Test Plots

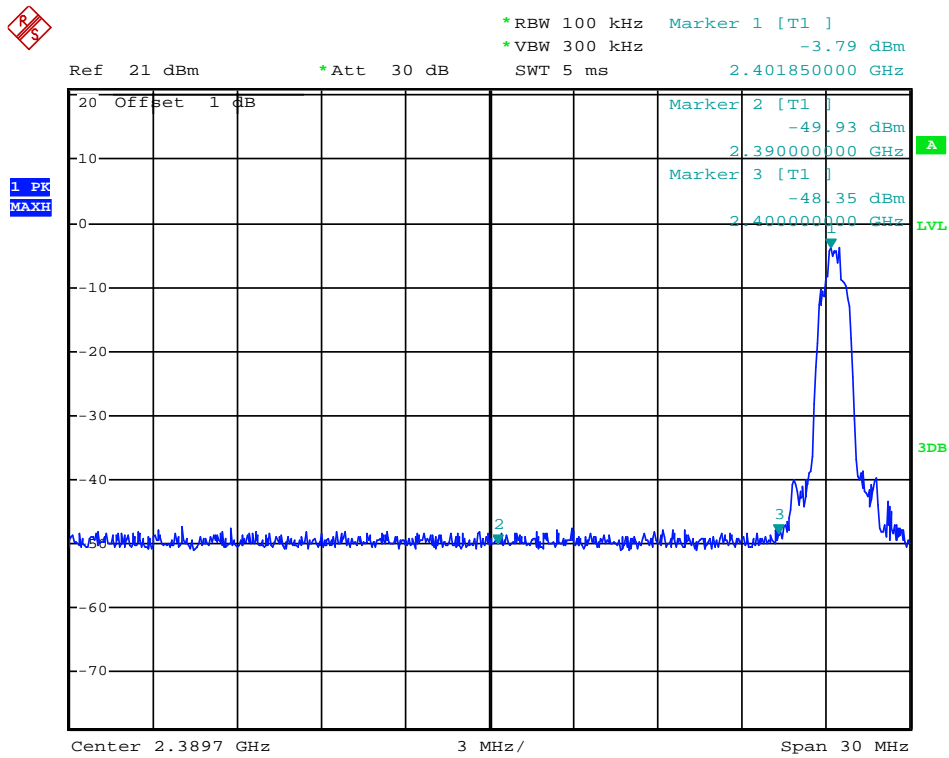

Date: 6.JAN.2014 16:24:39

(Plot 4.5.2.3 A: Channel 00: 2402MHz @ $\pi/4$ DQPSK)

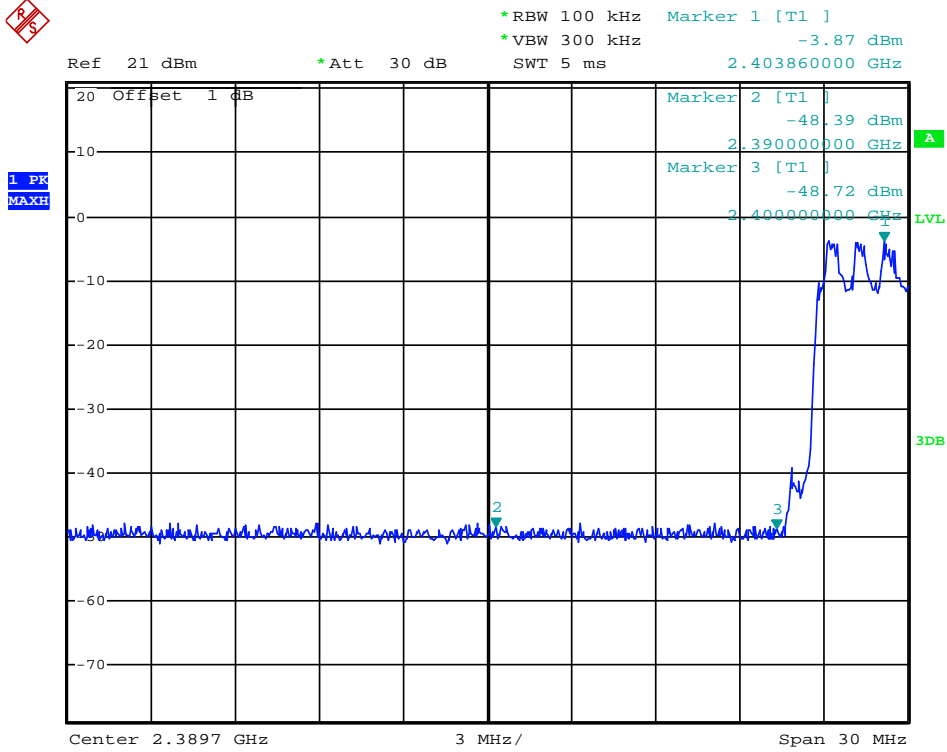

Date: 6.JAN.2014 16:25:40

(Plot 4.5.2.3 B: Hopping Mode @ $\pi/4$ DQPSK)

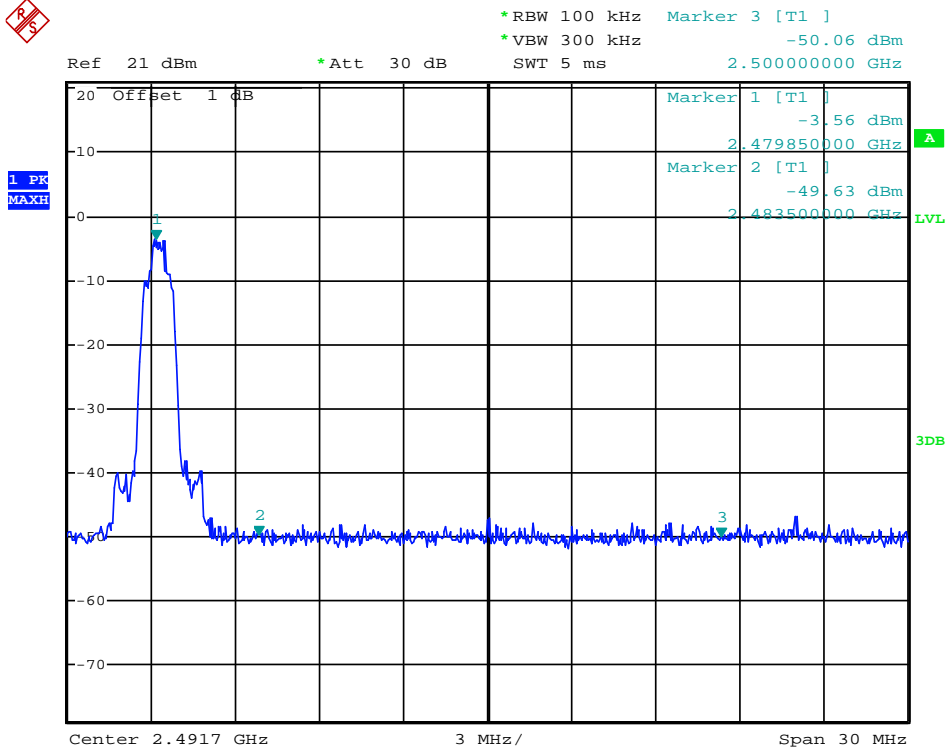

Date: 6.JAN.2014 16:26:26

(Plot 4.5.2.3 C: Channel 78: 2480MHz @ $\pi/4$ DQPSK)



*RBW 100 kHz Marker 1 [T1]
*VBW 300 kHz -3.55 dBm
SWT 5 ms 2.478830000 GHz

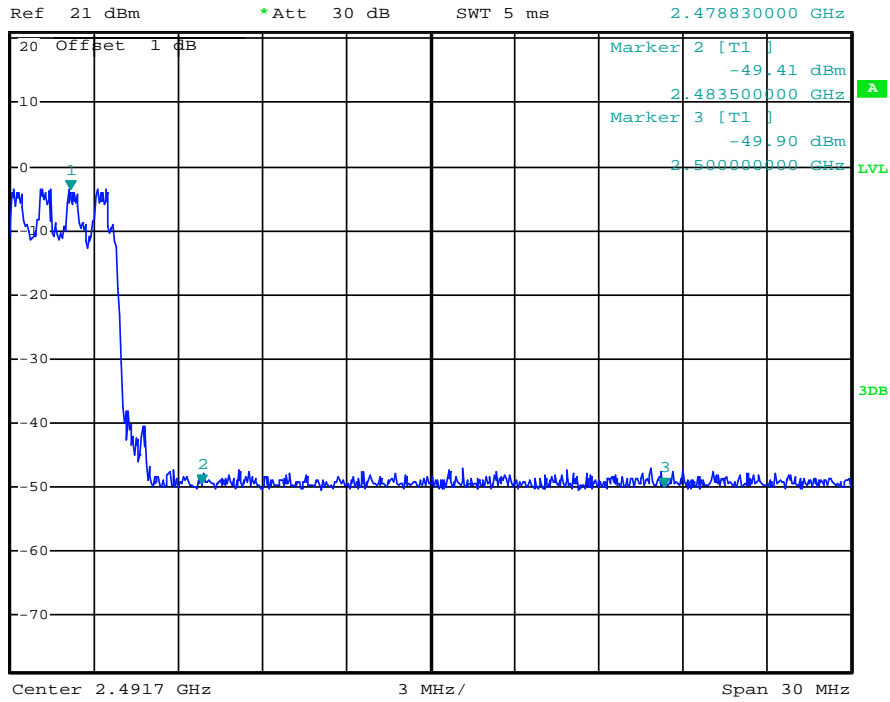

Date: 6.JAN.2014 16:28:13

(Plot 4.5.2.3 D: Hopping Mode @ $\pi/4$ DQPSK)

4.6. Frequency Separation

TEST CONFIGURATION

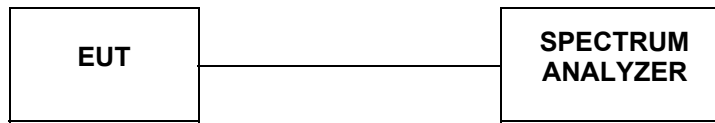

TEST PROCEDURE

The transmitter output was connected to the spectrum analyzer through an attenuator. The bandwidth of the fundamental frequency was measured by spectrum analyzer with RBW=30 KHz and VBW=100KHz.

LIMIT

According to 15.247(a)(1), frequency hopping systems shall have hopping channel carrier frequencies separated by minimum of 25KHz or the $2/3 \times 20\text{dB}$ bandwidth of the hopping channel, whichever is greater.

TEST RESULTS

4.6.1 GFSK Test Mode

A. Test Verdict

Channel	Frequency (MHz)	Channel Separation (MHz)	Refer to Plot	Limits (KHz)	Verdict
00	2402	1.004	Plot 4.6.1 A	768	PASS
01	2403				
38	2440	1.004	Plot 4.6.1 B	764	PASS
39	2441				
77	2479	1.004	Plot 4.6.1 C	768	PASS
78	2480				

B. Test Plots

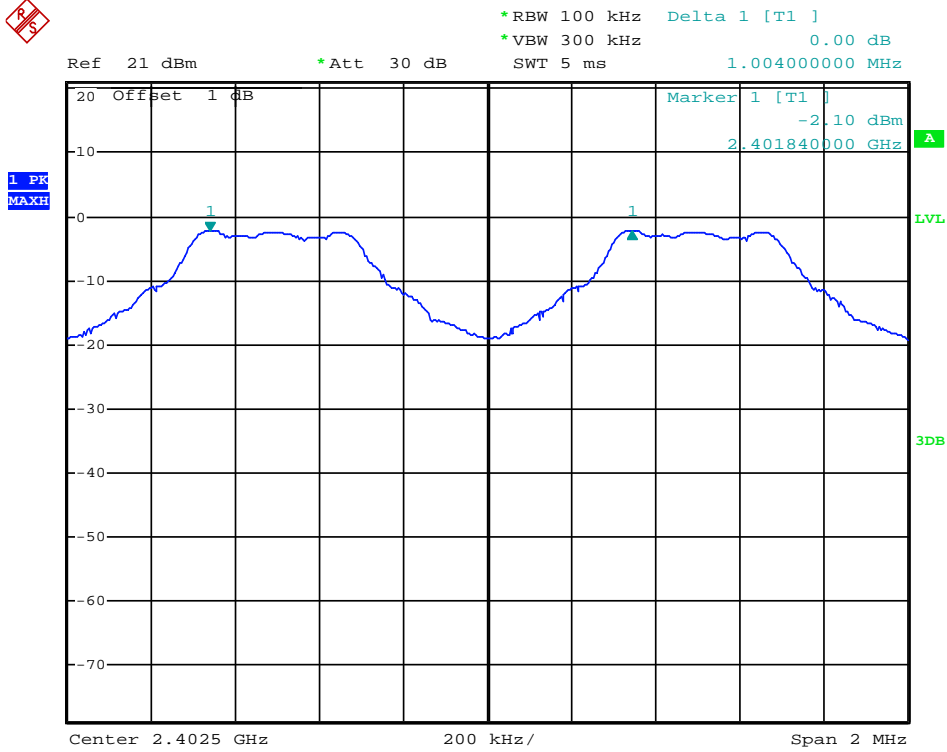

Date: 6.JAN.2014 16:09:14

(Plot 4.6.1 A: Channel 00: 2402MHz @ GFSK)

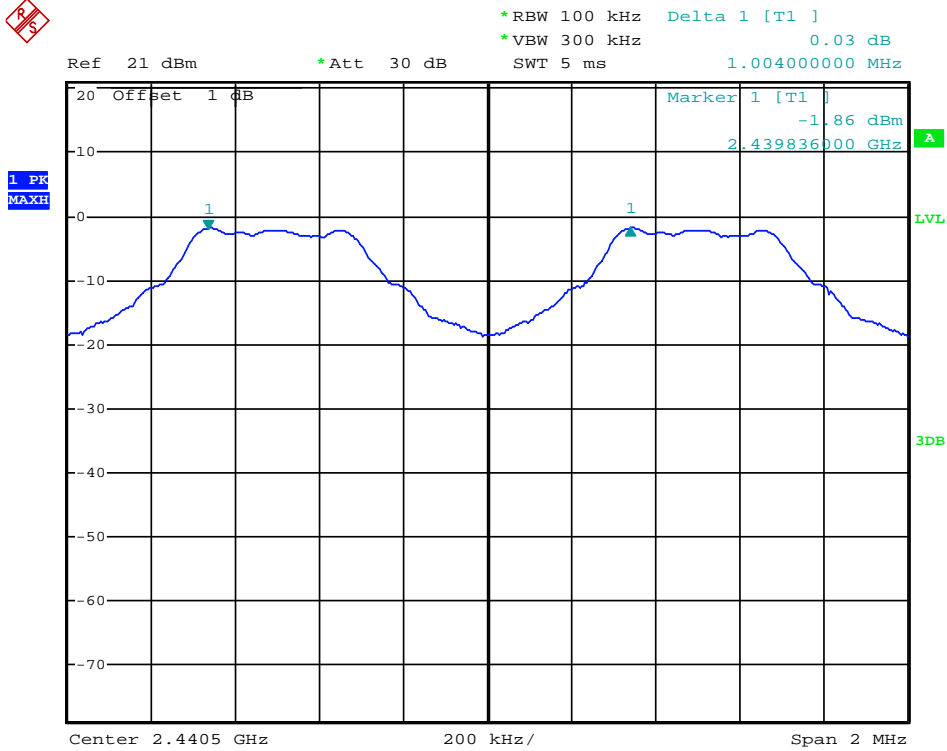

Date: 6.JAN.2014 16:10:51

(Plot 4.6.1 B: Channel 39: 2441MHz @ GFSK)

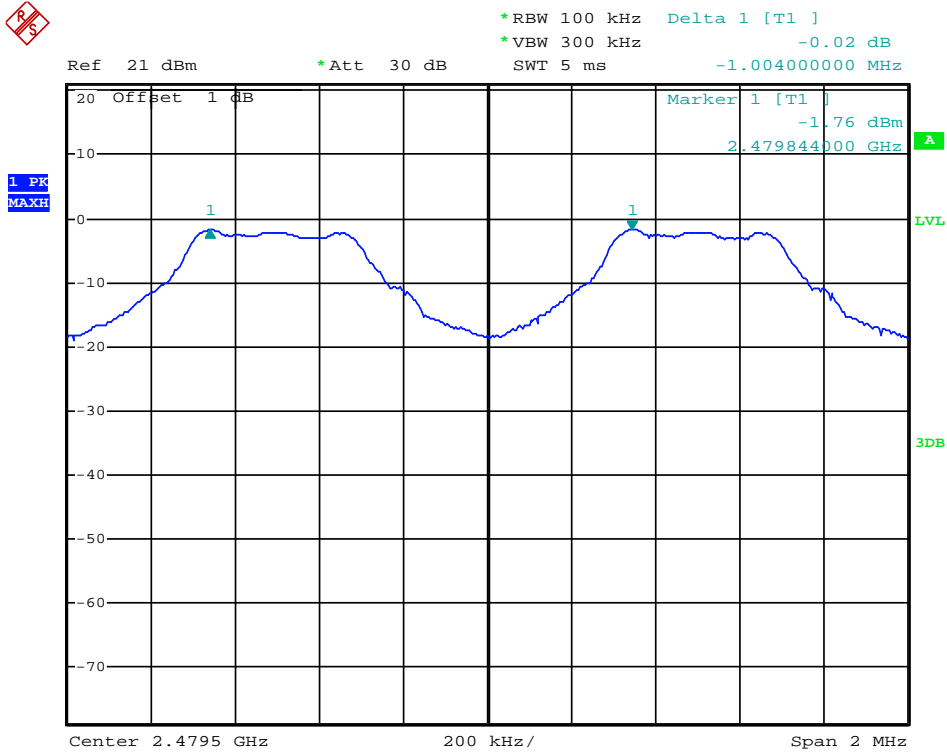

Date: 6.JAN.2014 16:11:54

(Plot 4.6.1 C: Channel 78: 2480MHz @ GFSK)

4.6.2 8DPSK Test Mode

A. Test Verdict

Channel	Frequency (MHz)	Channel Separation (MHz)	Refer to Plot	Limits (KHz)	Verdict
00	2402	1.004	Plot 4.6.2 A	747	PASS
01	2403				
38	2440	1.004	Plot 4.6.2 B	747	PASS
39	2441				
77	2479	1.004	Plot 4.6.2 C	747	PASS
78	2480				

B. Test Plots



*RBW 100 kHz Marker 1 [T1]
*VBW 300 kHz -3.87 dBm
SWT 5 ms 2.401840000 GHz

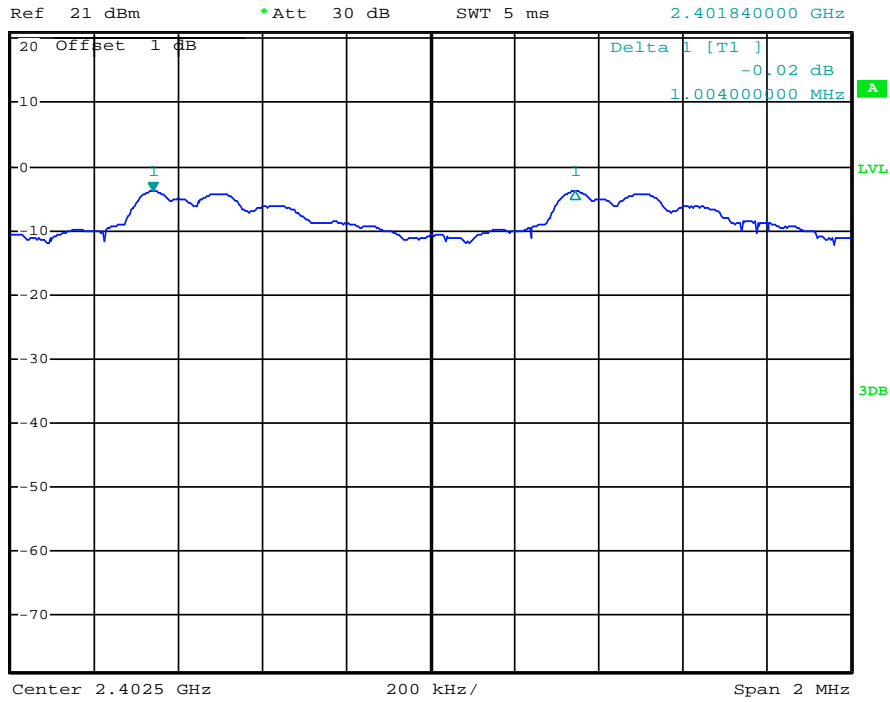

Date: 6.JAN.2014 16:16:57

(Plot 4.6.2 A: Channel 00: 2402MHz @ 8DPSK)



*RBW 100 kHz Delta 1 [T1]
*VBW 300 kHz -0.00 dB
SWT 5 ms -1.004000000 MHz

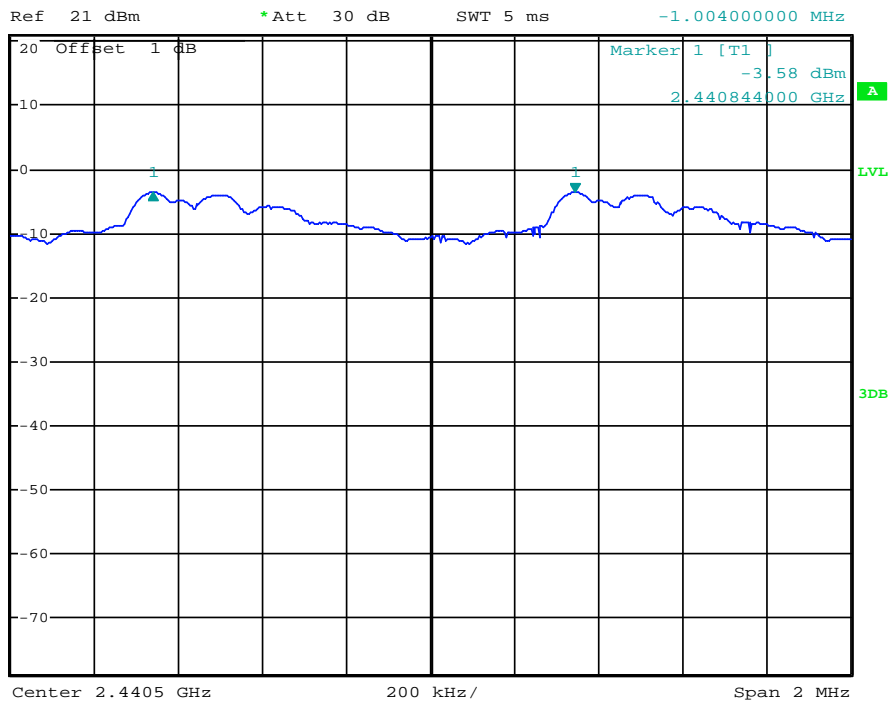

Date: 6.JAN.2014 16:17:55

(Plot 4.6.2 B: Channel 39: 2441MHz @ 8DPSK)

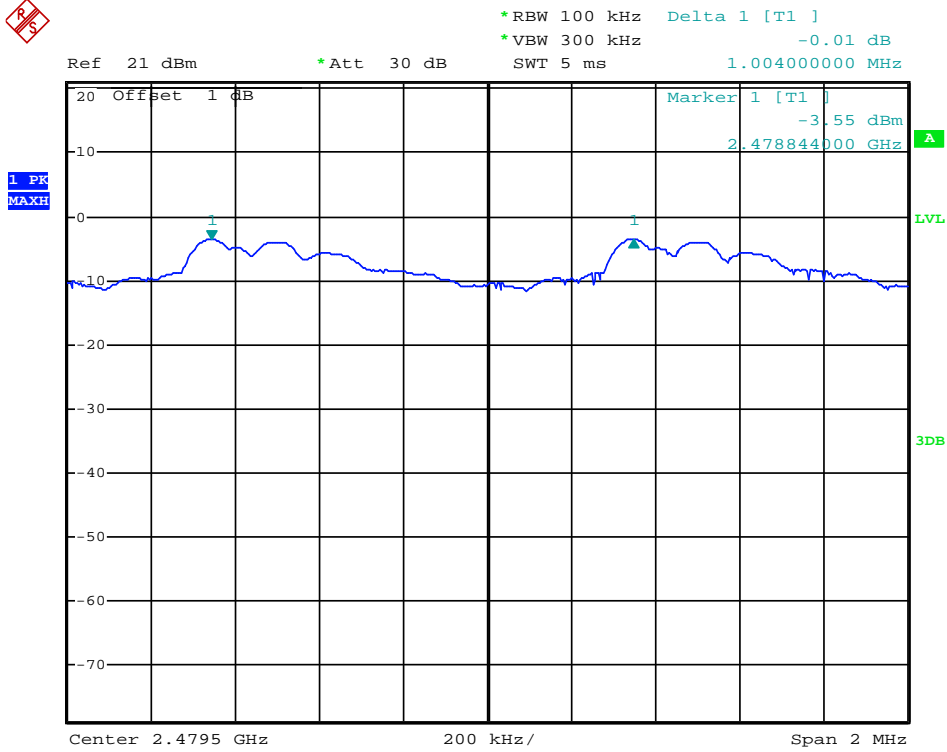

Date: 6.JAN.2014 16:18:47

(Plot 4.6.2 C: Channel 78: 2480MHz @ 8DPSK)

4.6.3 $\pi/4$ DQPSK Test Mode

A. Test Verdict

Channel	Frequency (MHz)	Channel Separation (MHz)	Refer to Plot	Limits (KHz)	Verdict
00	2402	1.004	Plot 4.6.3 A	768	PASS
01	2403				
38	2440	1.004	Plot 4.6.3 B	771	PASS
39	2441				
77	2479	1.004	Plot 4.6.3 C	768	PASS
78	2480				

B. Test Plots



*RBW 100 kHz Delta 1 [T1]
*VBW 300 kHz -0.01 dB
SWT 5 ms -1.004000000 MHz

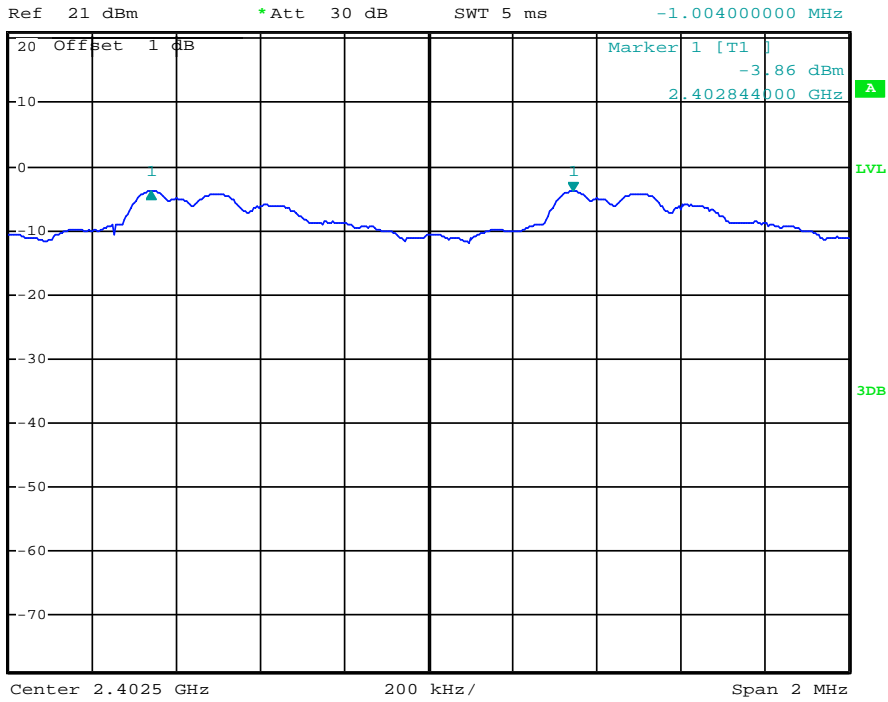

Date: 6.JAN.2014 16:13:01

(Plot 4.6.3 A: Channel 00: 2402MHz @ $\pi/4$ DQPSK)



*RBW 100 kHz Delta 1 [T1]
*VBW 300 kHz 0.01 dB
SWT 5 ms 1.004000000 MHz

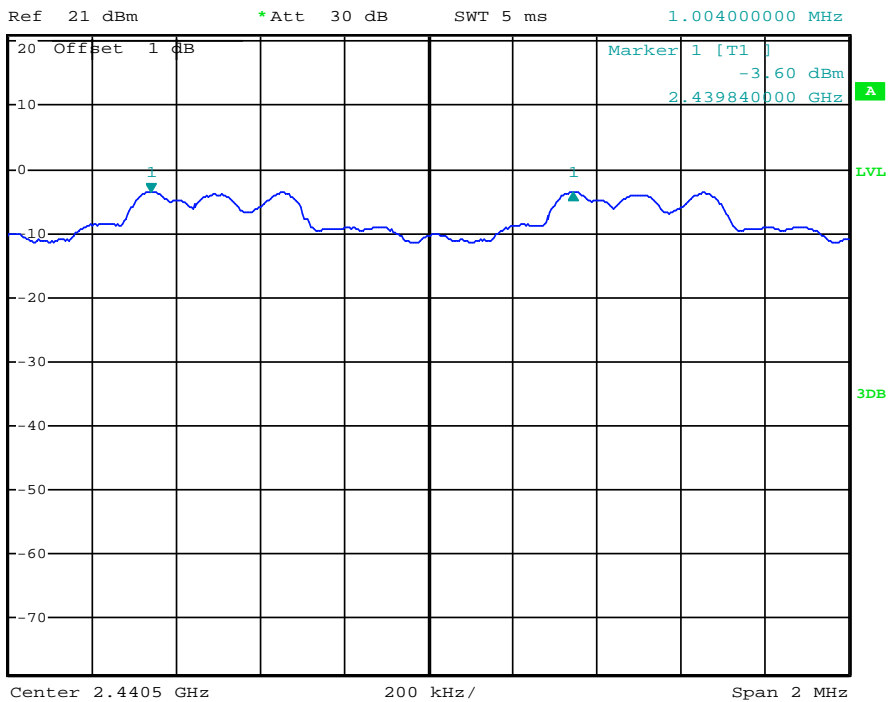

Date: 6.JAN.2014 16:14:24

(Plot 4.6.3 B: Channel 39: 2441MHz @ $\pi/4$ DQPSK)



*RBW 100 kHz Delta 1 [T1]
*VBW 300 kHz -0.01 dB
SWT 5 ms 1.004000000 MHz

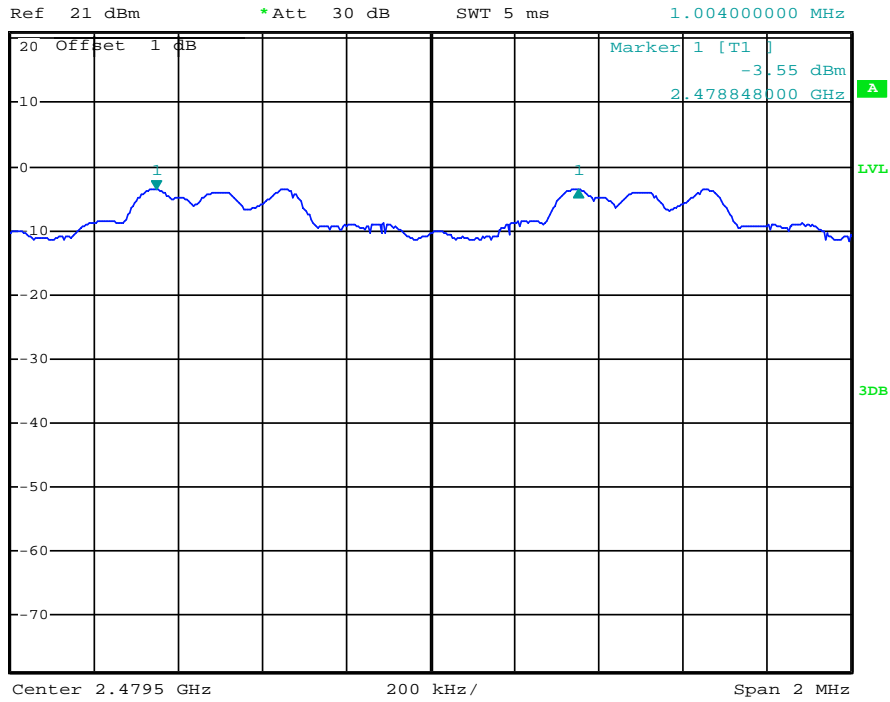

Date: 6.JAN.2014 16:15:22

(Plot 4.6.3 C: Channel 78: 2480MHz @ $\pi/4$ DQPSK)

4.7. Number of hopping frequency

TEST CONFIGURATION

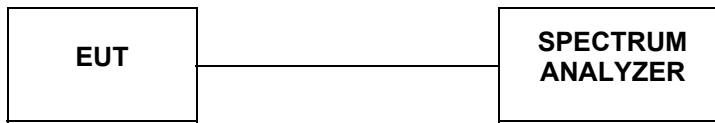

TEST PROCEDURE

The transmitter output was connected to the spectrum analyzer through an attenuator. Set spectrum analyzer start 2400MHz to 2483.5MHz with RBW= 30 KHz and VBW=100KHz.

LIMIT

Frequency hopping systems in the 2400–2483.5 MHz band shall use at least 15 channels.

TEST RESULTS

4.7.1 GFSK Test Mode

A. Test Verdict

Hopping Channel Frequency Range (MHz)	Number of Hopping Channel	Refer to Plot	Limit	Verdict
2400-2483.5	79	Plot 4.7.1 A	≥15	PASS

B. Test Plots

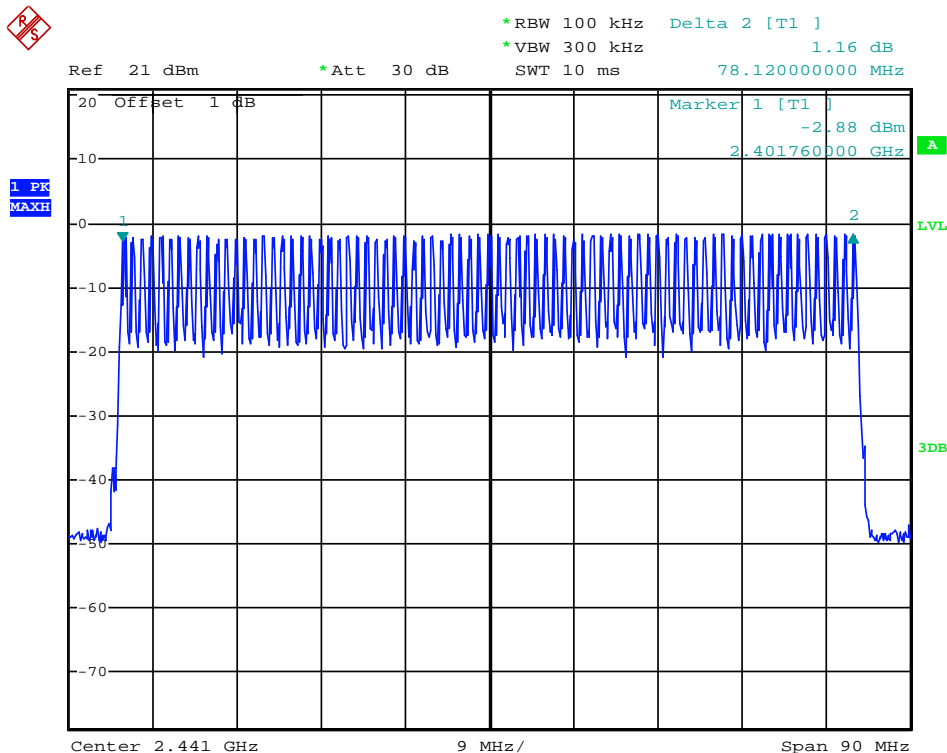

Date: 6.JAN.2014 15:40:39

(Plot 4.7.1 A: @ GFSK)

4.7.2 8DPSKTest Mode

A. Test Verdict

Hopping Channel Frequency Range (MHz)	Number of Hopping Channel	Refer to Plot	Limit	Verdict
2400-2483.5	79	Plot 4.7.2 A	≥15	PASS

B. Test Plots

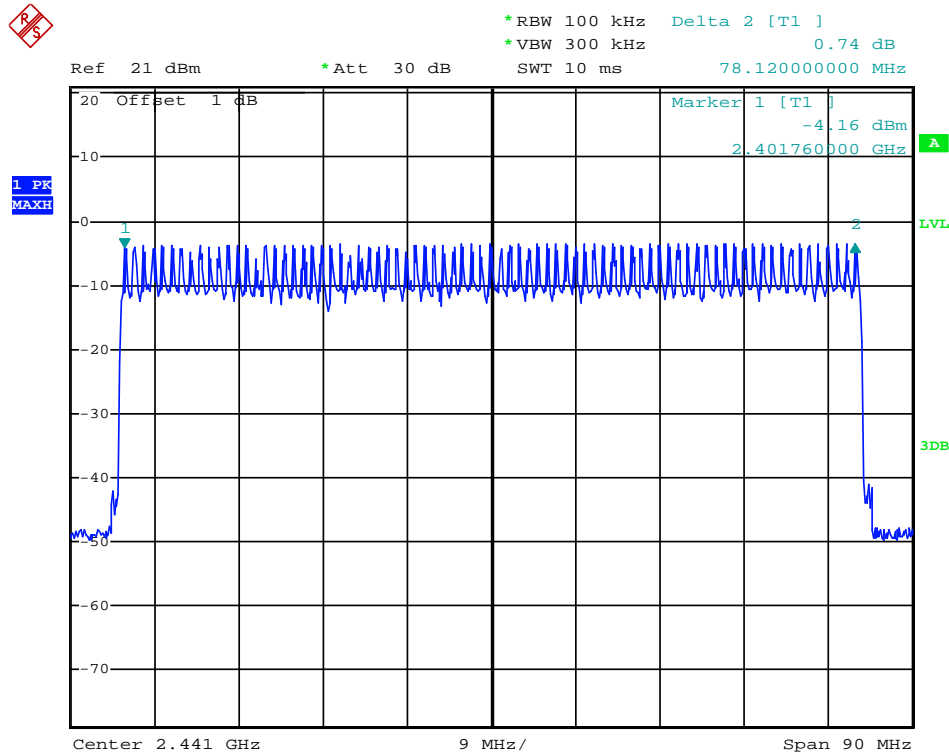

Date: 6.JAN.2014 15:43:55

(Plot 4.7.2 A: @ 8DPSK)

4.7.3 π/4DQPSKTest Mode

A. Test Verdict

Hopping Channel Frequency Range (MHz)	Number of Hopping Channel	Refer to Plot	Limit	Verdict
2400-2483.5	79	Plot 4.7.3 A	≥15	PASS

B. Test Plots



*RBW 100 kHz Delta 2 [T1]
*VBW 300 kHz 1.97 dB
SWT 10 ms 78.30000000 MHz

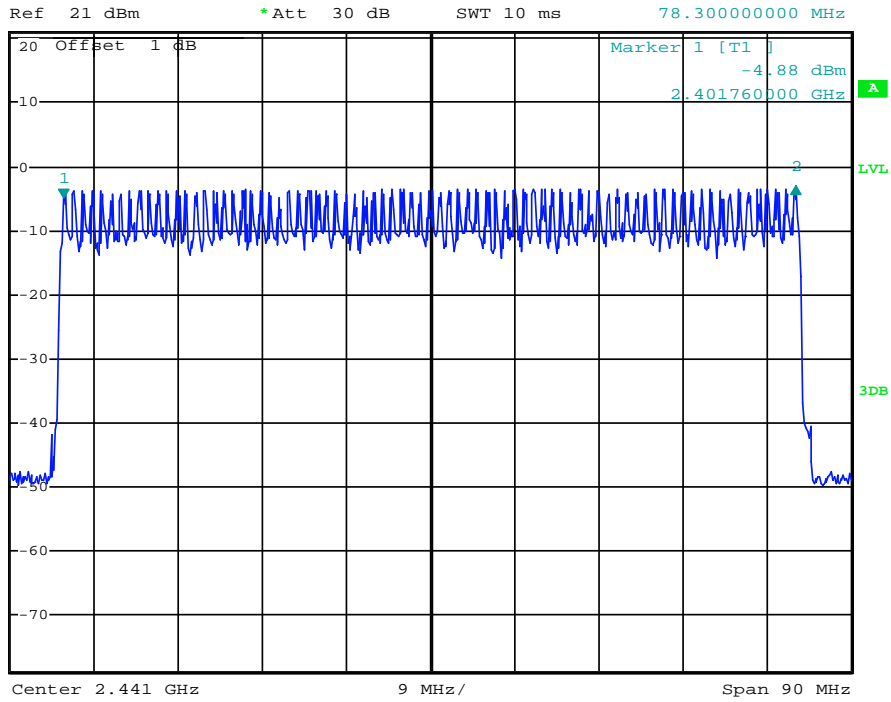

Date: 6.JAN.2014 15:48:23

(Plot 4.7.3 A: @ $\pi/4$ DQPSK)

4.8. Time Of Occupancy(Dwell Time)

TEST CONFIGURATION

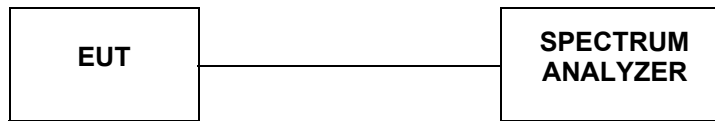

TEST PROCEDURE

The transmitter output was connected to the spectrum analyzer through an attenuator. Set center frequency of spectrum analyzer=operating frequency with RBW=1MHz and VBW=3MHz, Span=0Hz.

LIMIT

The average time of occupancy on any channel shall not be greater than 0.4 seconds within a pe-riod of 0.4 seconds multiplied by the number of hopping channels employed.

TEST RESULTS

4.8.1 GFSK Test Mode

A. Test Verdict

Mode	Frequency (MHz)	Pulse Width (ms)	Dwell Time (S)	Limit (S)	Refer to Plot	Verdict
DH 1	2402	0.415	0.1328	0.4	Plot 4.8.1 A1	PASS
	2441	0.415	0.1328	0.4	Plot 4.8.1 A2	PASS
	2480	0.415	0.1328	0.4	Plot 4.8.1 A3	PASS
Note: Dwell time=Pulse time (ms) × (1600 ÷ 2 ÷ 79) ×31.6 Second						
DH 3	2402	1.685	0.2696	0.4	Plot 4.8.1 B1	PASS
	2441	1.685	0.2696	0.4	Plot 4.8.1 B2	PASS
	2480	1.685	0.2696	0.4	Plot 4.8.1 B3	PASS
Note: Dwell time=Pulse time (ms) × (1600 ÷ 4 ÷ 79) ×31.6 Second						
DH 5	2402	2.940	0.3136	0.4	Plot 4.8.1 C1	PASS
	2441	2.940	0.3136	0.4	Plot 4.8.1 C2	PASS
	2480	2.940	0.3136	0.4	Plot 4.8.1 C3	PASS
Note: Dwell time=Pulse Time (ms) × (1600 ÷ 6 ÷ 79) ×31.6 Second						

B. Test Plots

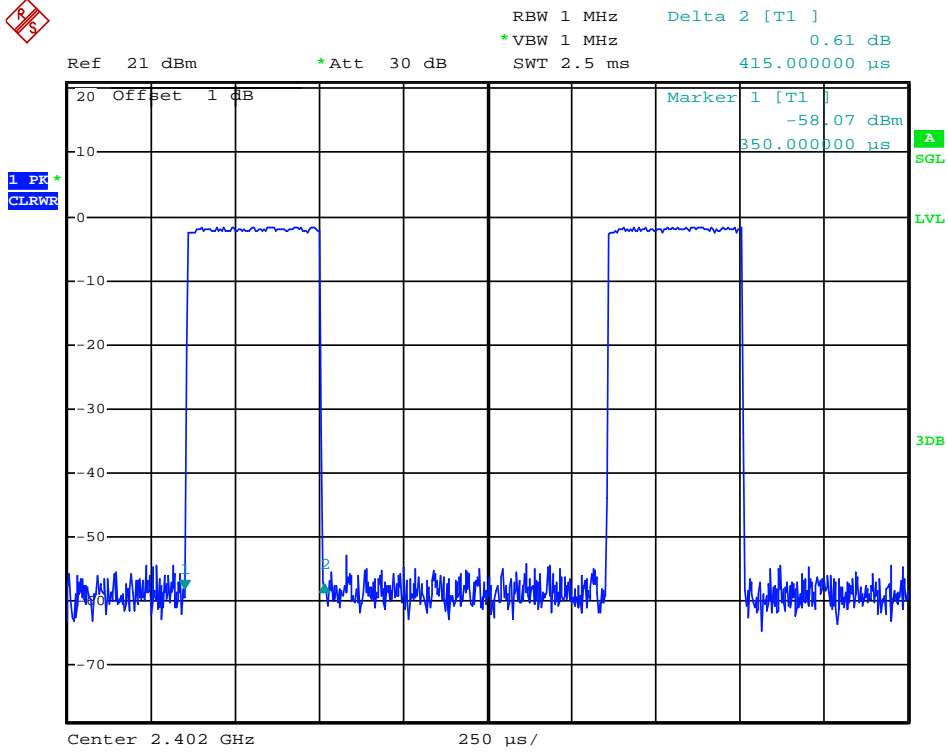

Date: 6.JAN.2014 16:34:22

(Plot 4.8.1.A1: Channel 00: 2402MHz @ GFSK @ DH1)

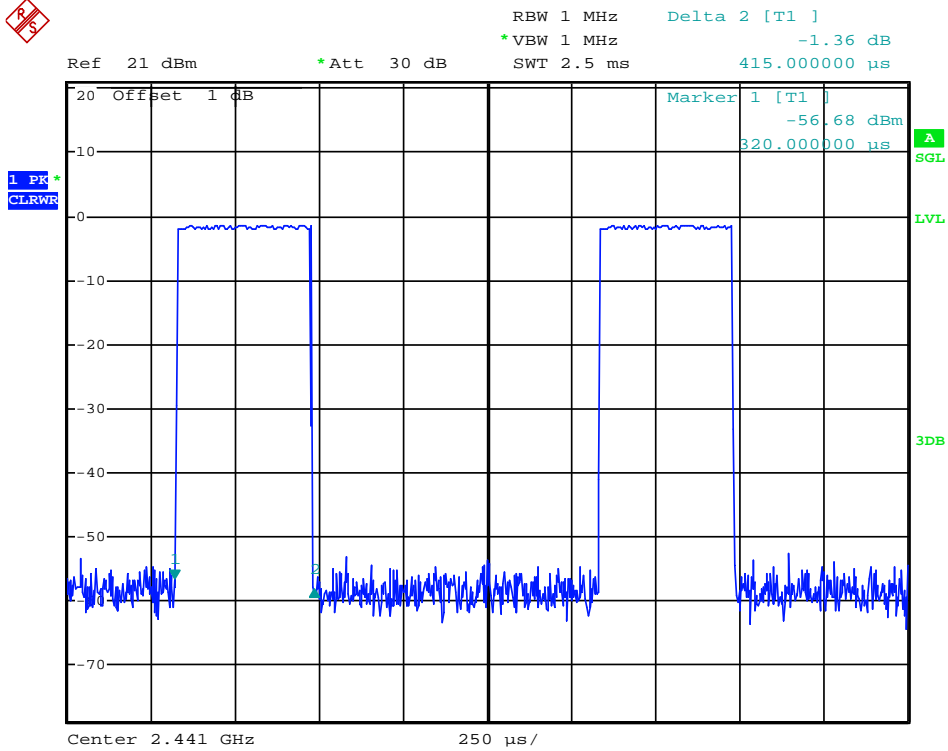

Date: 6.JAN.2014 16:34:50

(Plot 4.8.1.A2: Channel 39: 2441MHz @ GFSK @ DH1)

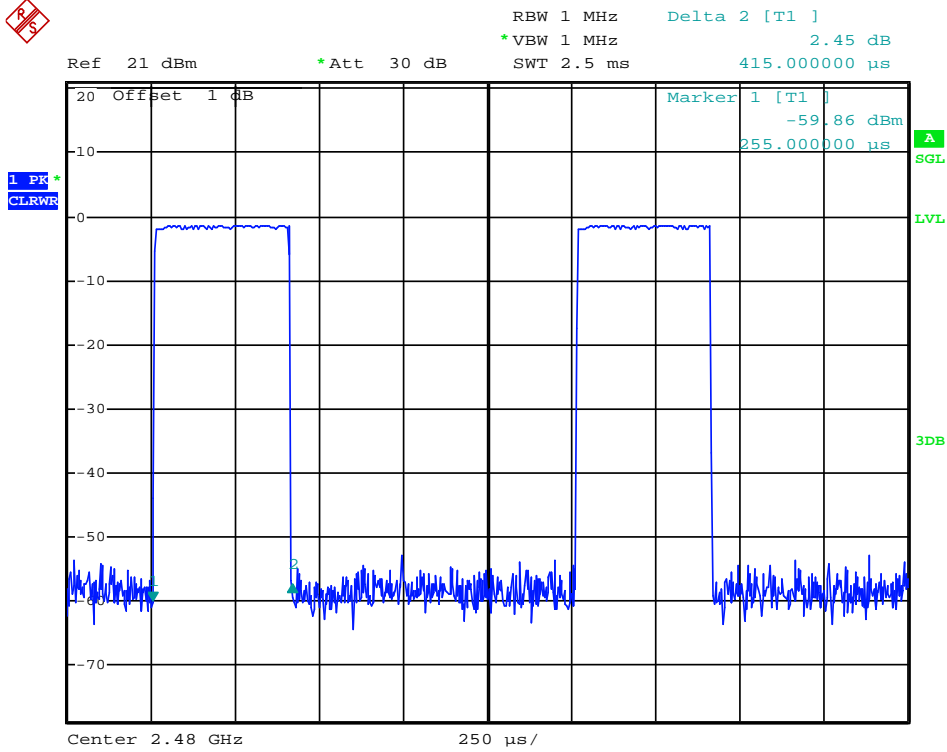

Date: 6.JAN.2014 16:35:15

(Plot 4.8.1.A3: Channel 78: 2480MHz @ GFSK @ DH1)

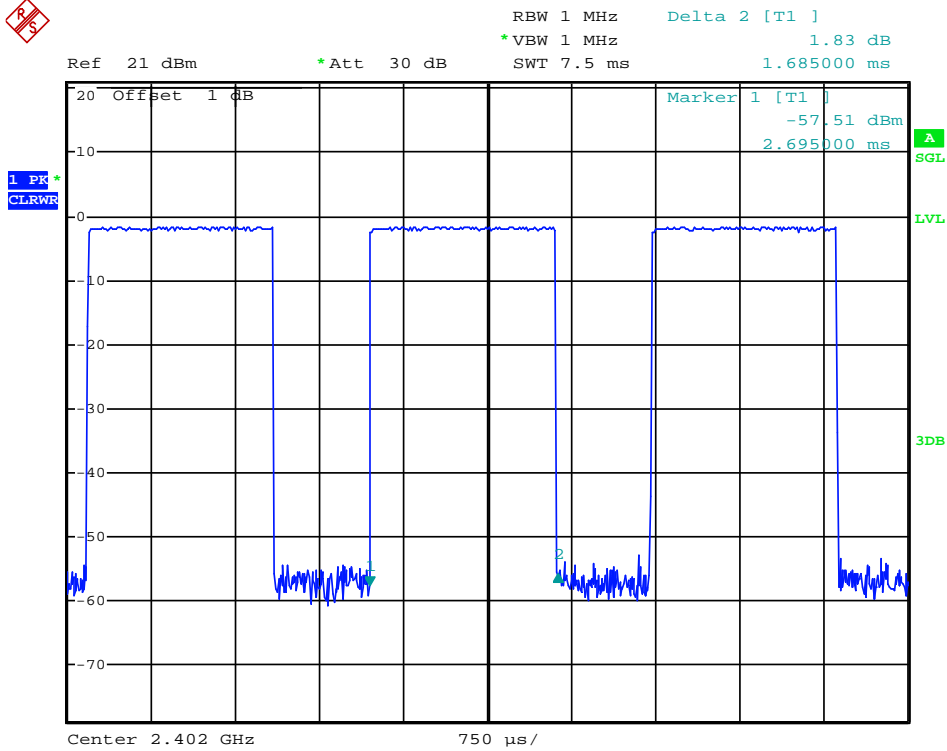

Date: 6.JAN.2014 16:41:09

(Plot 4.8.1.B1: Channel 00: 2402MHz @ GFSK @ DH3)

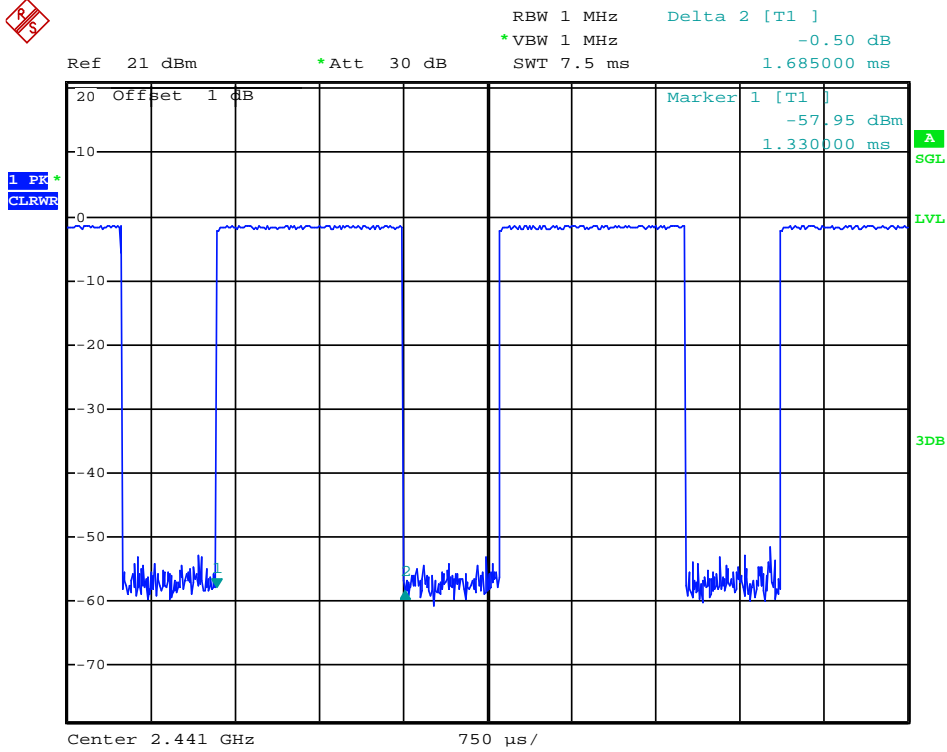

Date: 6.JAN.2014 16:42:00

(Plot 4.8.1.B2: Channel 39: 2441MHz @ GFSK @ DH3)

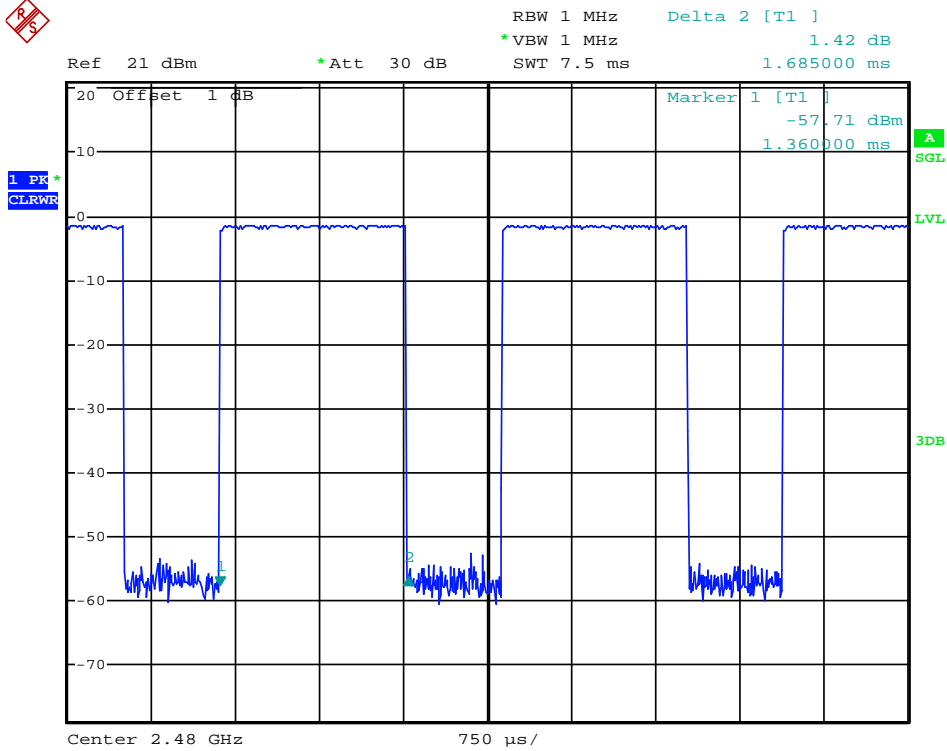

Date: 6.JAN.2014 16:42:22

(Plot 4.8.1.B3: Channel 78: 2480MHz @ GFSK @ DH3)



RBW 1 MHz Delta 2 [T1]
*VBW 1 MHz -1.40 dB
Ref 21 dBm *Att 30 dB SWT 10 ms 2.940000 ms

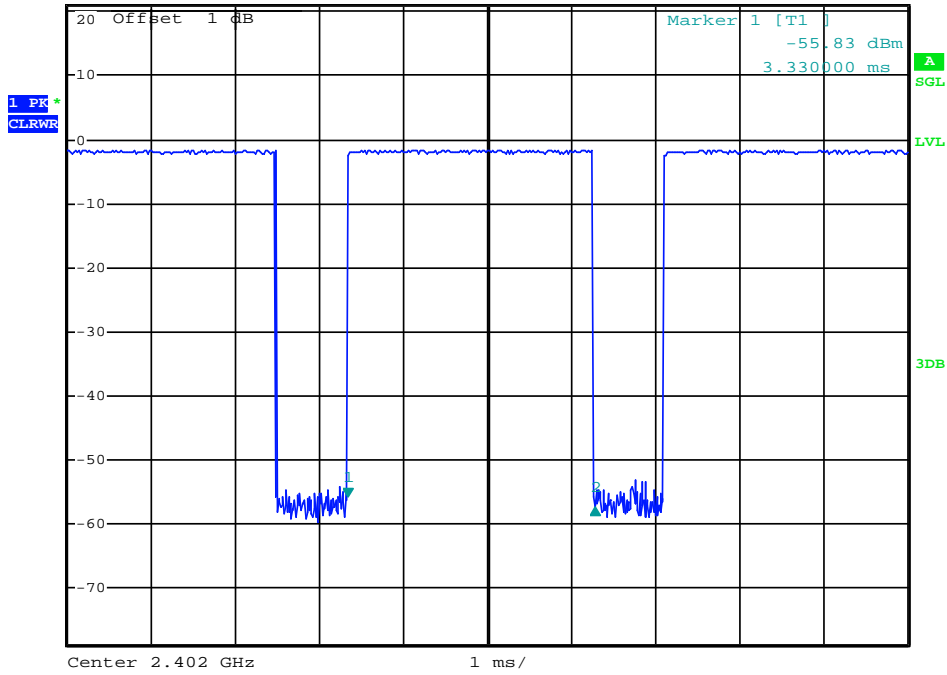

Date: 6.JAN.2014 16:50:48

(Plot 4.8.1.C1: Channel 00: 2402MHz @ GFSK @ DH5)



RBW 1 MHz Delta 2 [T1]
*VBW 1 MHz -1.40 dB
Ref 21 dBm *Att 30 dB SWT 10 ms 2.940000 ms

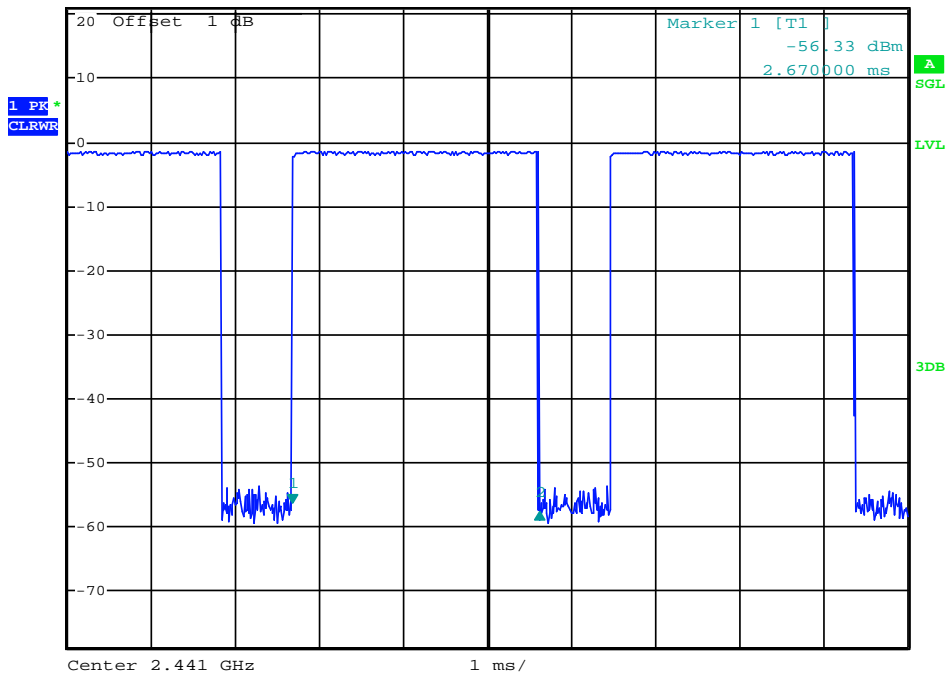

Date: 6.JAN.2014 16:51:12

(Plot 4.8.1.C2: Channel 39: 2441MHz @ GFSK @ DH5)

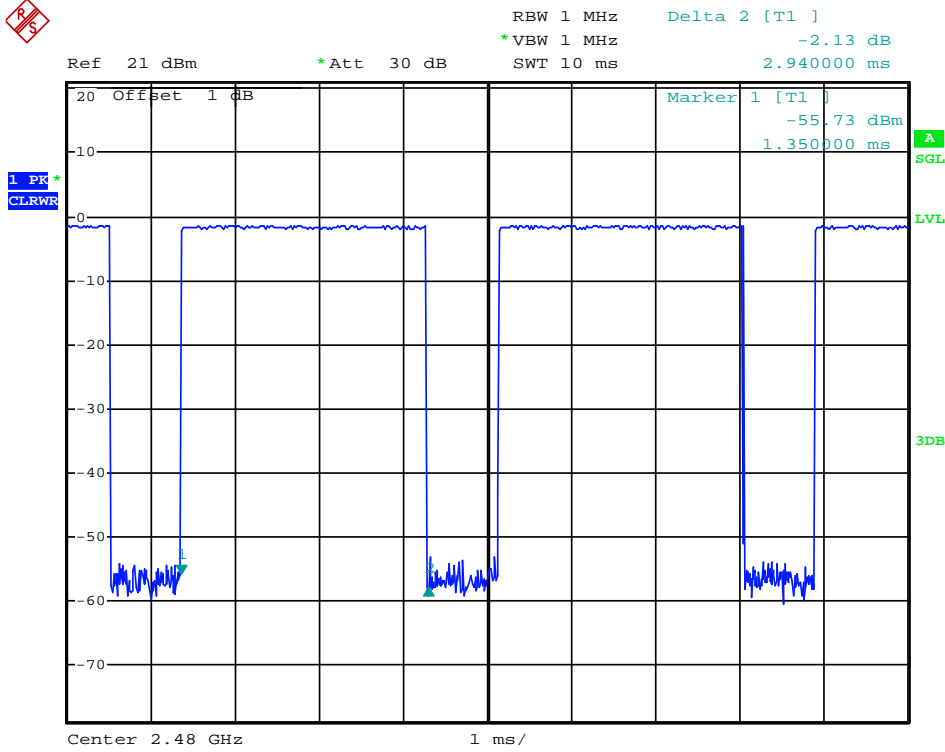

Date: 6.JAN.2014 16:51:37

(Plot 4.8.1.C3: Channel 78: 2480MHz @ GFSK @ DH5)

4.8.2 8DPSK Test Mode

A. Test Verdict

Mode	Frequency (MHz)	Pulse Width (ms)	Dwell Time (S)	Limit (S)	Refer to Plot	Verdict
DH 1	2402	0.425	0.1360	0.4	Plot 4.8.1 A1	PASS
	2441	0.425	0.1360	0.4	Plot 4.8.1 A2	PASS
	2480	0.430	0.1376	0.4	Plot 4.8.1 A3	PASS
Note: Dwell time=Pulse time (ms) × (1600 ÷ 2 ÷ 79) ×31.6 Second						
DH 3	2402	1.700	0.2720	0.4	Plot 4.8.1 B1	PASS
	2441	1.685	0.2696	0.4	Plot 4.8.1 B2	PASS
	2480	1.700	0.2720	0.4	Plot 4.8.1 B3	PASS
Note: Dwell time=Pulse time (ms) × (1600 ÷ 4 ÷ 79) ×31.6 Second						
DH 5	2402	2.940	0.3136	0.4	Plot 4.8.1 C1	PASS
	2441	2.960	0.3157	0.4	Plot 4.8.1 C2	PASS
	2480	2.960	0.3157	0.4	Plot 4.8.1 C3	PASS
Note: Dwell time=Pulse Time (ms) × (1600 ÷ 6 ÷ 79) ×31.6 Second						

B. Test Plots

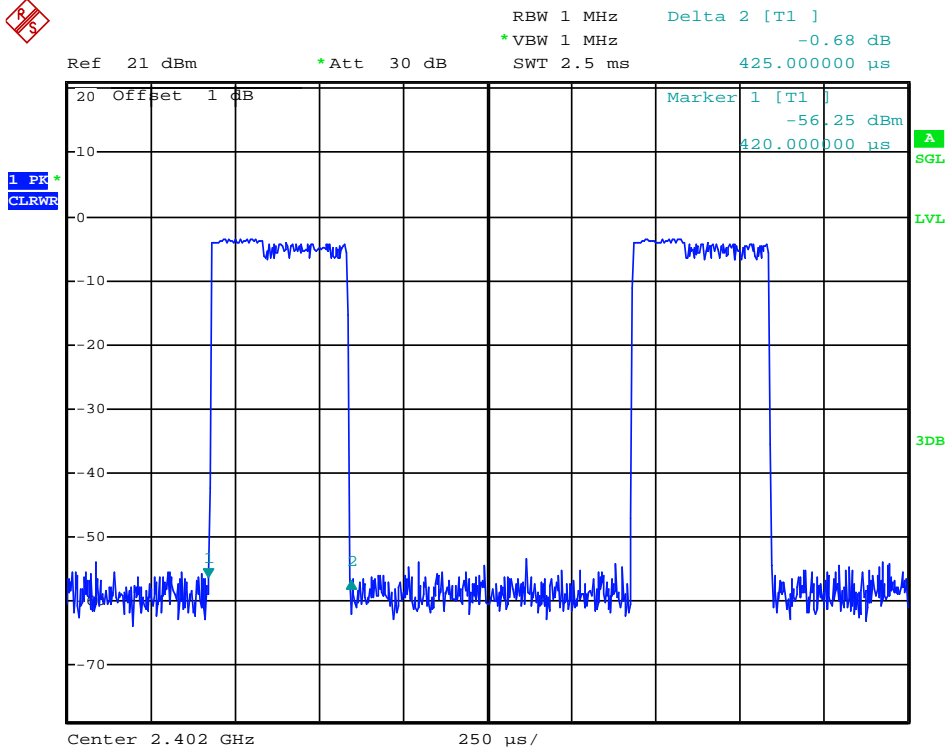

Date: 6.JAN.2014 16:36:00

(Plot 4.8.2.A1: Channel 00: 2402MHz @ 8DPSK @ DH1)

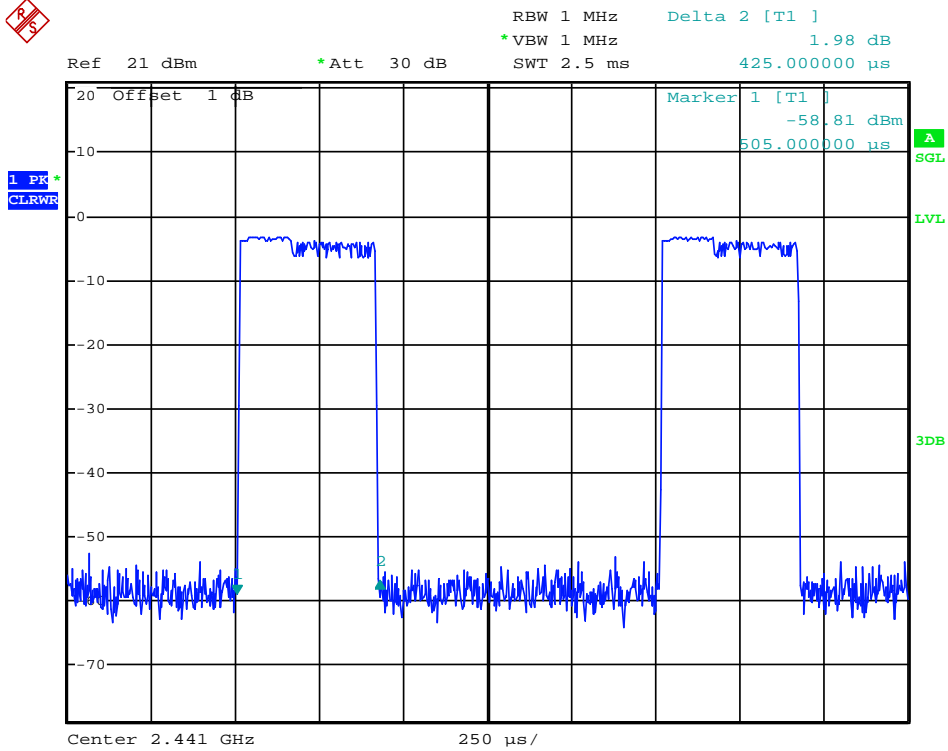

Date: 6.JAN.2014 16:36:25

(Plot 4.8.2.A2: Channel 39: 2441MHz @ 8DPSK @ DH1)



RBW 1 MHz Delta 2 [T1]
*VBW 1 MHz -3.23 dB
Ref 21 dBm *Att 30 dB SWT 2.5 ms 430.000000 μ s

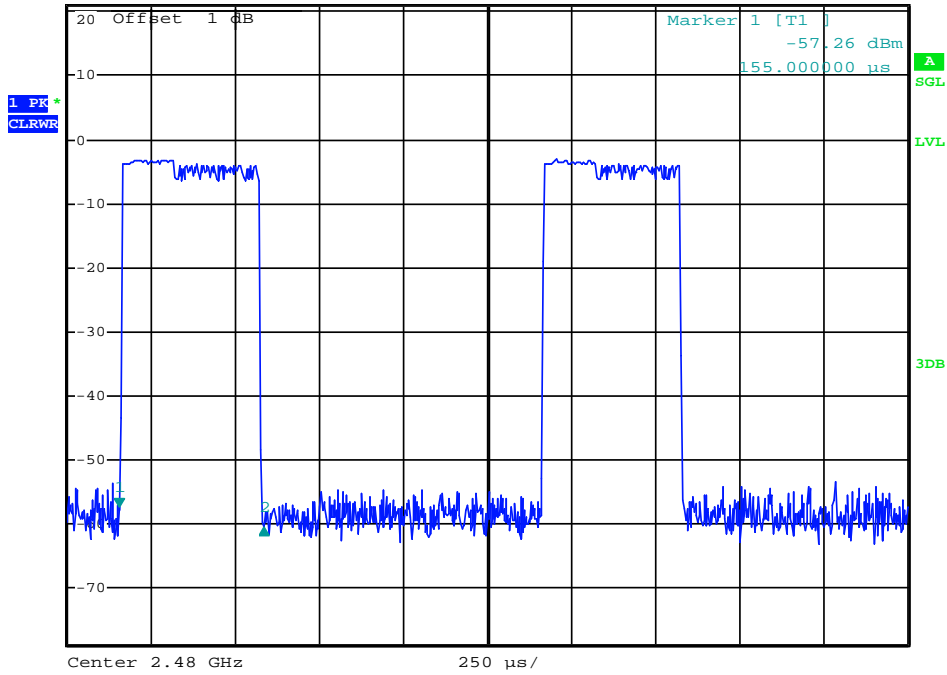

Date: 6.JAN.2014 16:37:02

(Plot 4.8.2.A3: Channel 78: 2480MHz @ 8DPSK @ DH1)



RBW 1 MHz Delta 2 [T1]
*VBW 1 MHz 0.72 dB
Ref 21 dBm *Att 30 dB SWT 7.5 ms 1.700000 ms

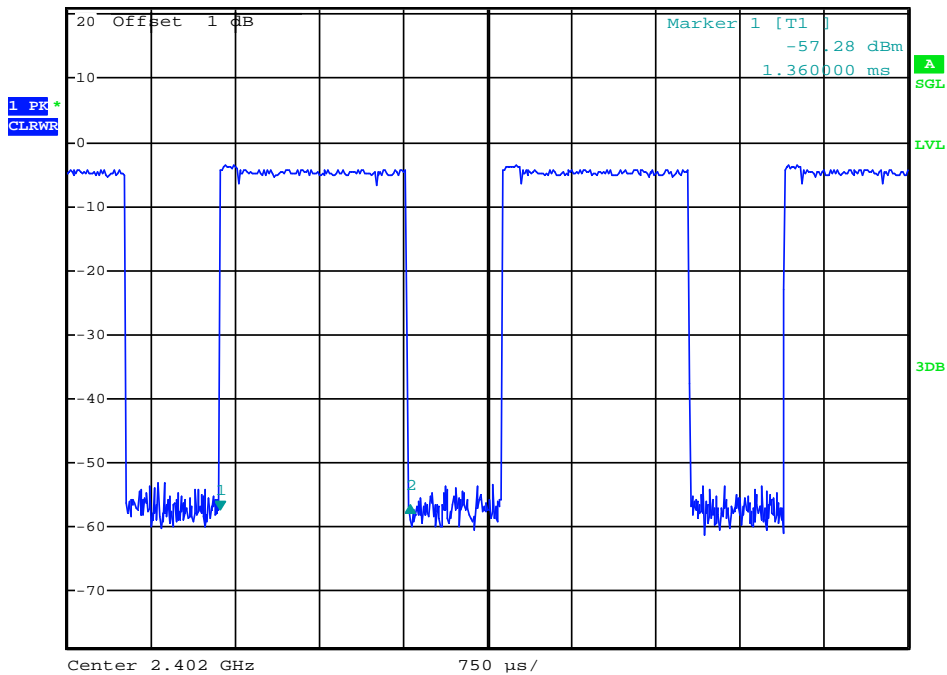

Date: 6.JAN.2014 16:45:41

(Plot 4.8.2.B1: Channel 00: 2402MHz @ 8DPSK @ DH3)

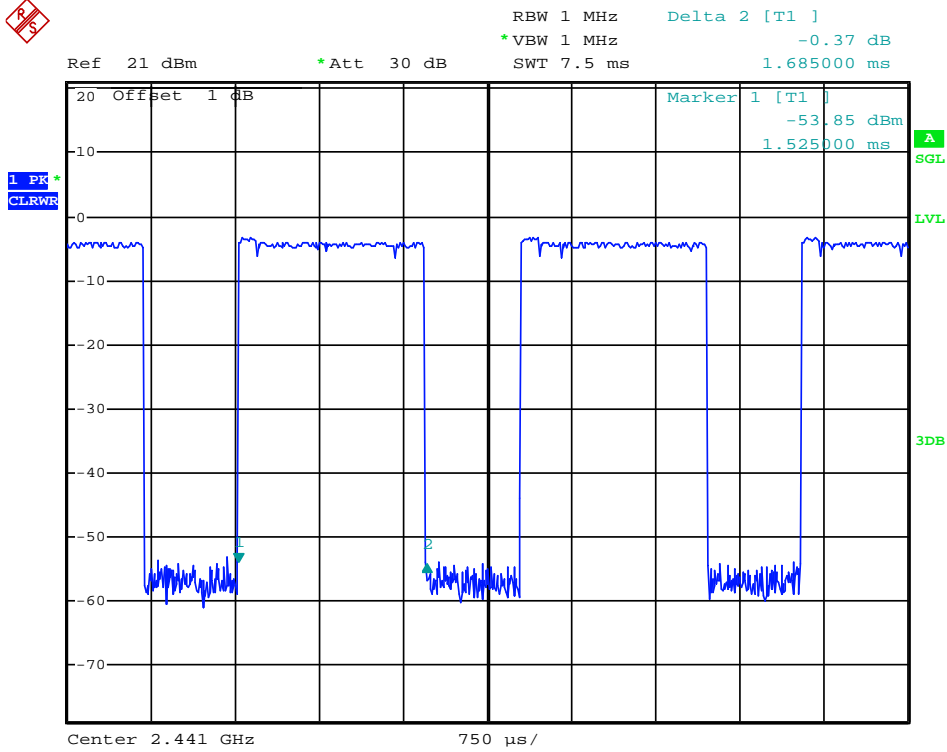

Date: 6.JAN.2014 16:46:03

(Plot 4.8.2.B2: Channel 39: 2441MHz @ 8DPSK @ DH3)

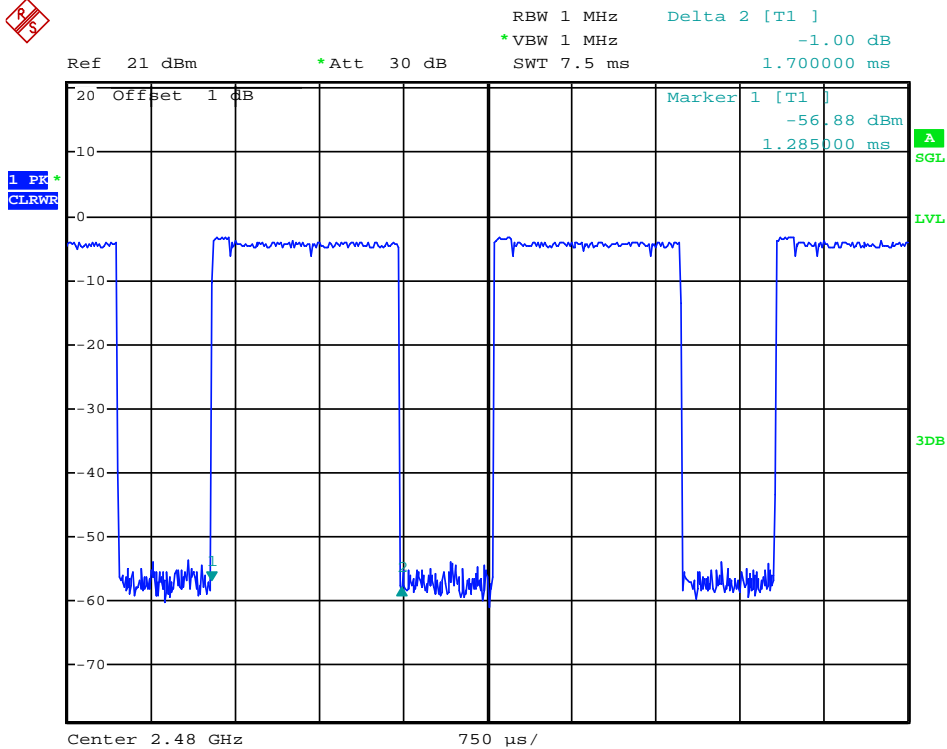

Date: 6.JAN.2014 16:46:26

(Plot 4.8.2.B3: Channel 78: 2480MHz @ 8DPSK @ DH3)

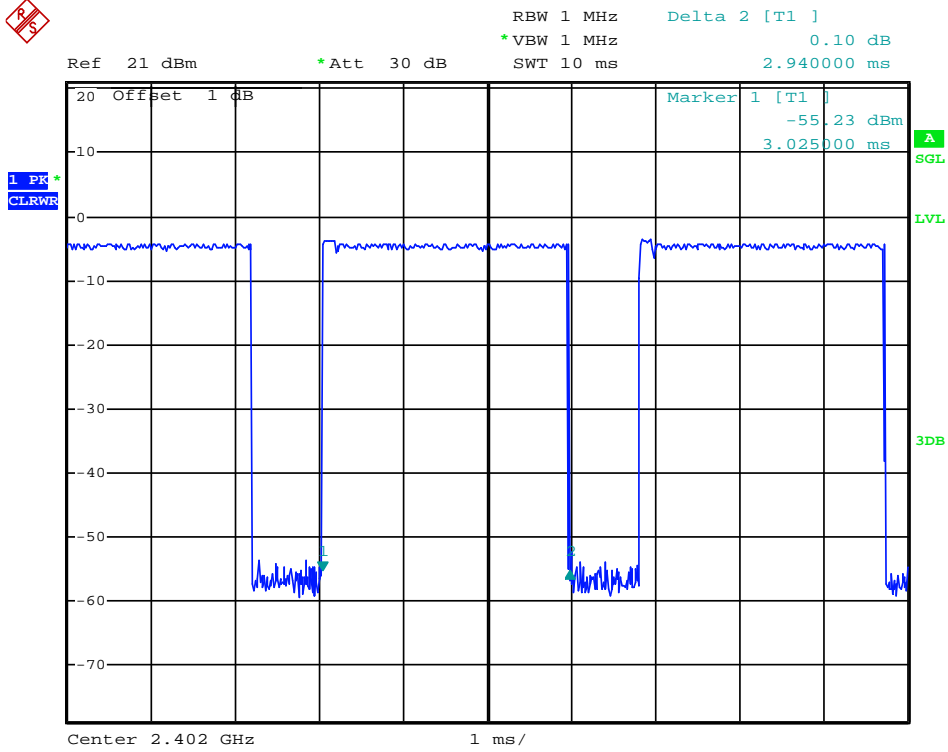

Date: 6.JAN.2014 16:47:03

(Plot 4.8.2.C1: Channel 00: 2402MHz @ 8DPSK @ DH5)

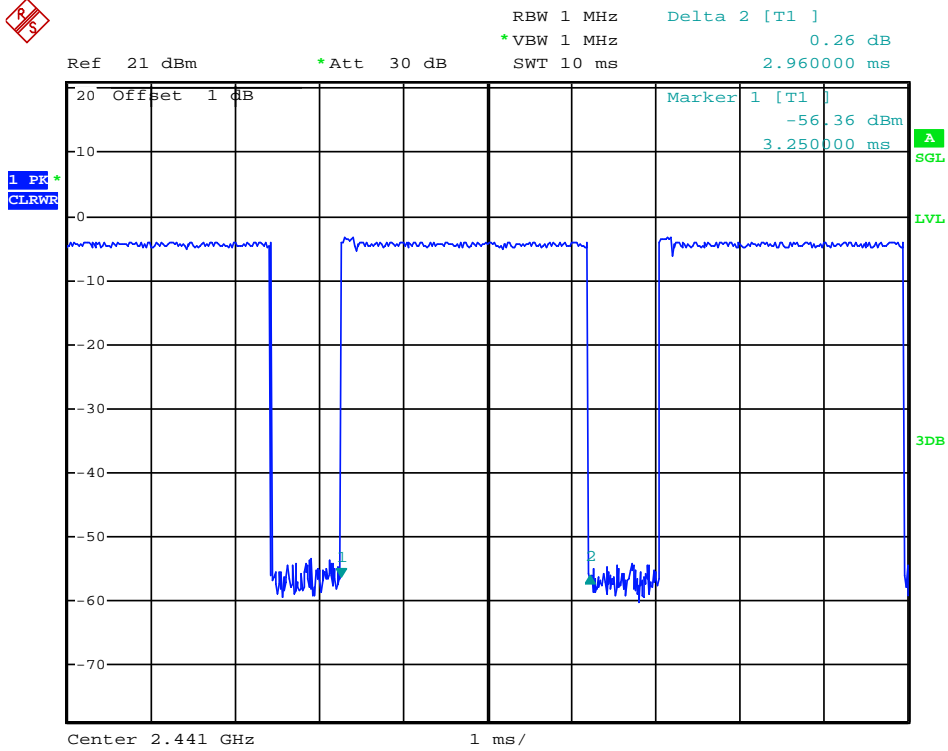

Date: 6.JAN.2014 16:47:45

(Plot 4.8.2.C2: Channel 39: 2441MHz @ 8DPSK @ DH5)

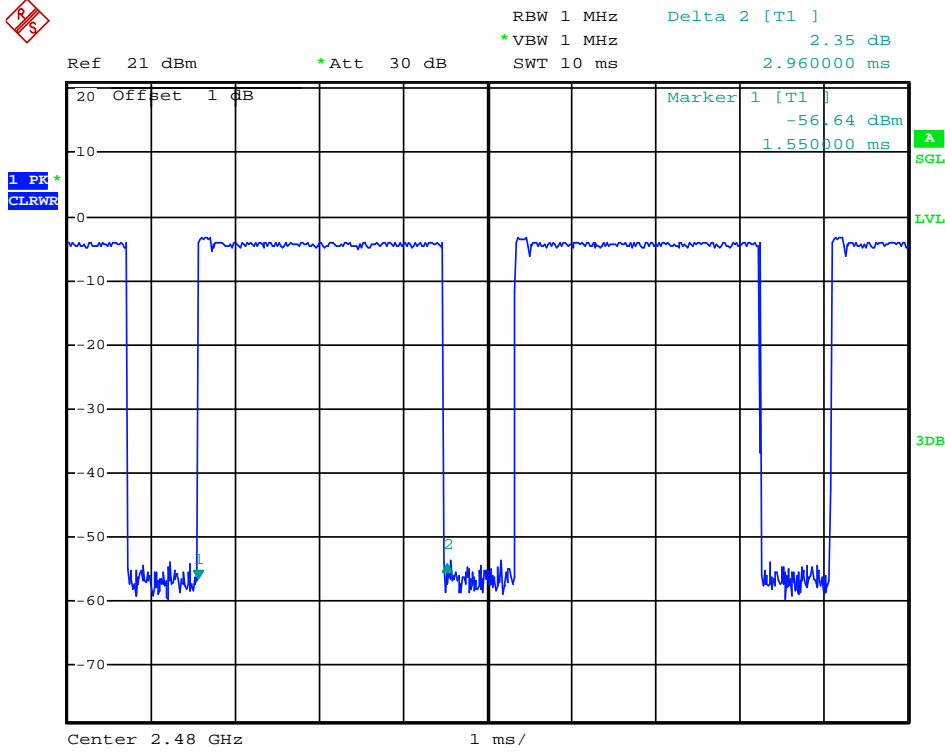

Date: 6.JAN.2014 16:48:17

(Plot 4.8.2.C3: Channel 78: 2480MHz @ 8DPSK @ DH5)

4.8.3 π/4DQPSK Test Mode

A. Test Verdict

Mode	Frequency (MHz)	Pulse Width (ms)	Dwell Time (S)	Limit (S)	Refer to Plot	Verdict
DH 1	2402	0.425	0.1360	0.4	Plot 4.8.1 A1	PASS
	2441	0.425	0.1360	0.4	Plot 4.8.1 A2	PASS
	2480	0.425	0.1360	0.4	Plot 4.8.1 A3	PASS
Note: Dwell time=Pulse time (ms) × (1600 ÷ 2 ÷ 79) ×31.6 Second						
DH 3	2402	1.685	0.2696	0.4	Plot 4.8.1 B1	PASS
	2441	1.700	0.2720	0.4	Plot 4.8.1 B2	PASS
	2480	1.700	0.2720	0.4	Plot 4.8.1 B3	PASS
Note: Dwell time=Pulse time (ms) × (1600 ÷ 4 ÷ 79) ×31.6 Second						
DH 5	2402	2.960	0.3157	0.4	Plot 4.8.1 C1	PASS
	2441	2.960	0.3157	0.4	Plot 4.8.1 C2	PASS
	2480	2.960	0.3157	0.4	Plot 4.8.1 C3	PASS
Note: Dwell time=Pulse Time (ms) × (1600 ÷ 6 ÷ 79) ×31.6 Second						

B. Test Plots



RBW 1 MHz Delta 2 [T1]
*VBW 1 MHz -2.43 dB
Ref 21 dBm *Att 30 dB SWT 2.5 ms 425.000000 μ s

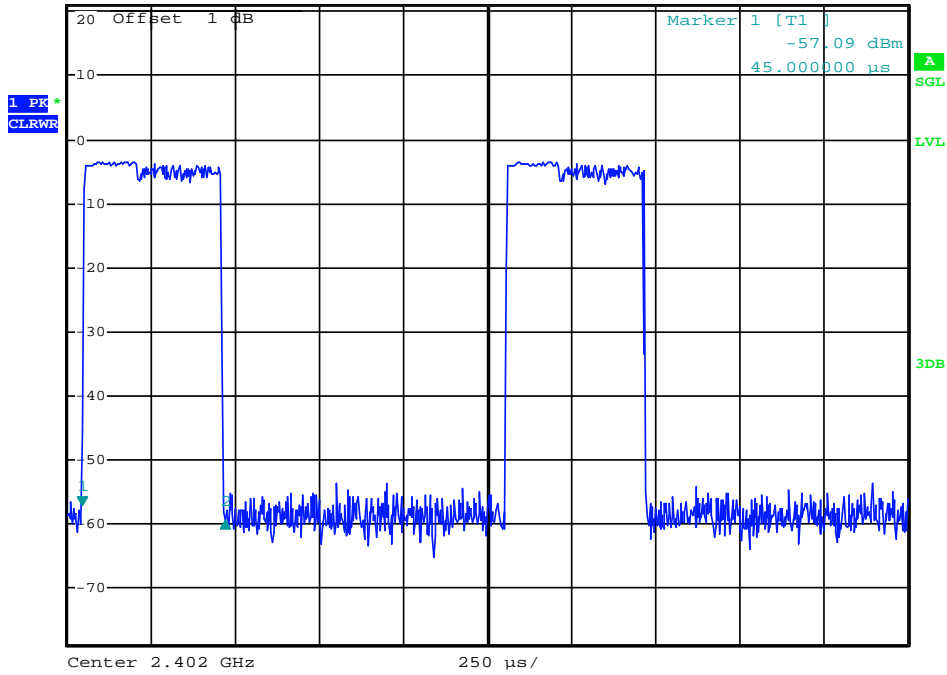

Date: 6.JAN.2014 16:37:38

(Plot 4.8.3.A1: Channel 00: 2402MHz @ $\pi/4$ DQPSK @ DH1)



RBW 1 MHz Delta 2 [T1]
*VBW 1 MHz 0.90 dB
Ref 21 dBm *Att 30 dB SWT 2.5 ms 425.000000 μ s

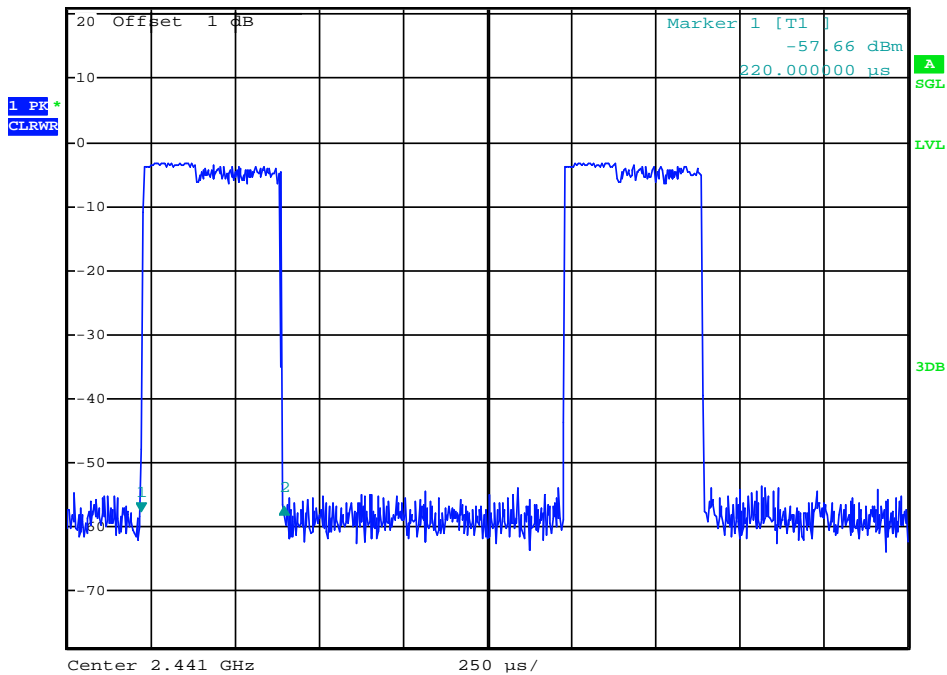

Date: 6.JAN.2014 16:38:01

(Plot 4.8.3.A2: Channel 39: 2441MHz @ $\pi/4$ DQPSK @ DH1)

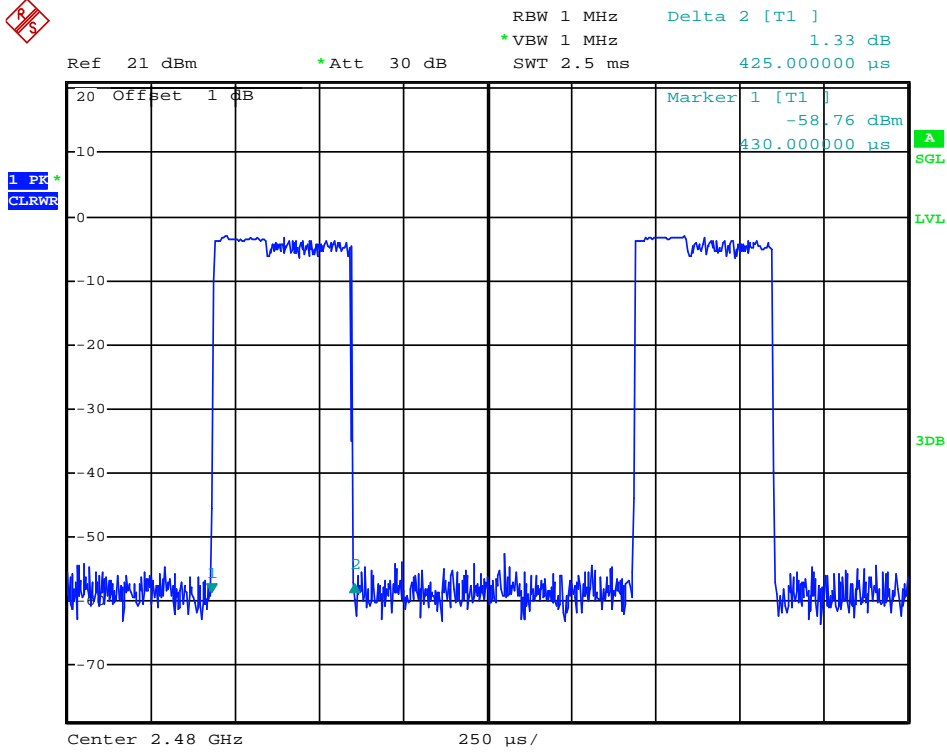

Date: 6.JAN.2014 16:38:24

(Plot 4.8.3.A3: Channel 78: 2480MHz @ $\pi/4$ DQPSK @ DH1)

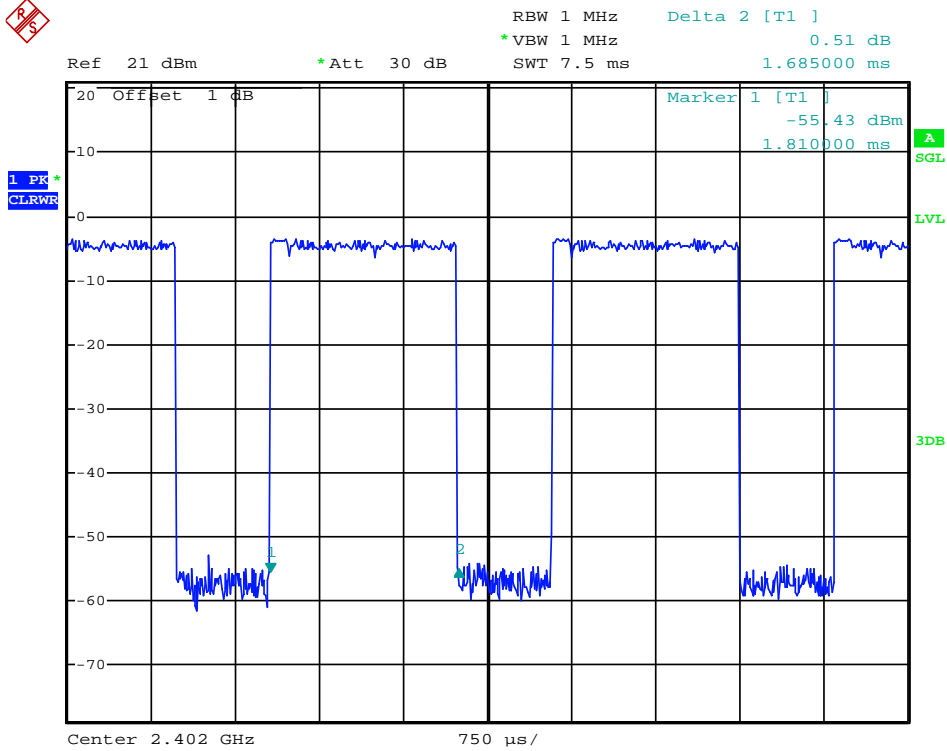

Date: 6.JAN.2014 16:39:20

(Plot 4.8.3.B1: Channel 00: 2402MHz @ $\pi/4$ DQPSK @ DH3)

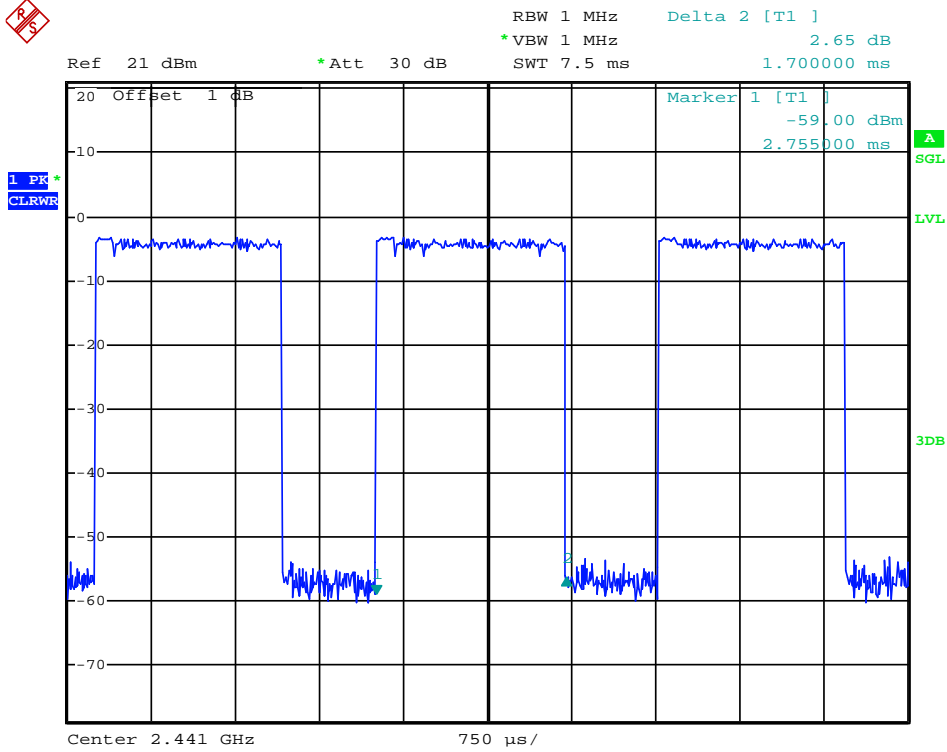

Date: 6.JAN.2014 16:39:58

(Plot 4.8.3.B2: Channel 39: 2441MHz @ $\pi/4$ DQPSK @ DH3)

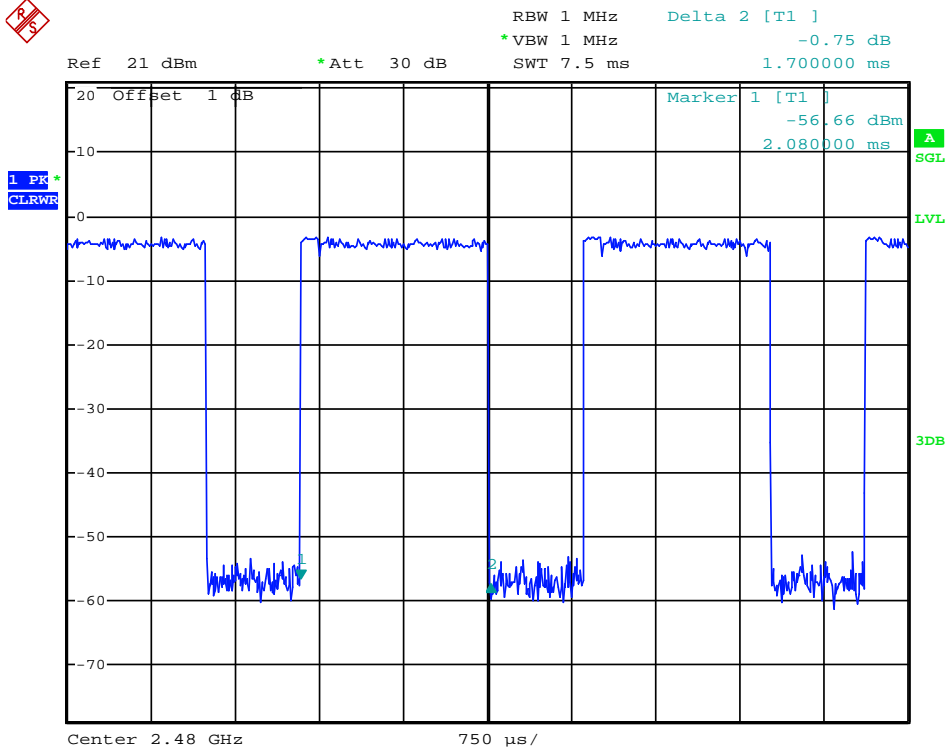

Date: 6.JAN.2014 16:40:25

(Plot 4.8.3.B3: Channel 78: 2480MHz @ $\pi/4$ DQPSK @ DH3)

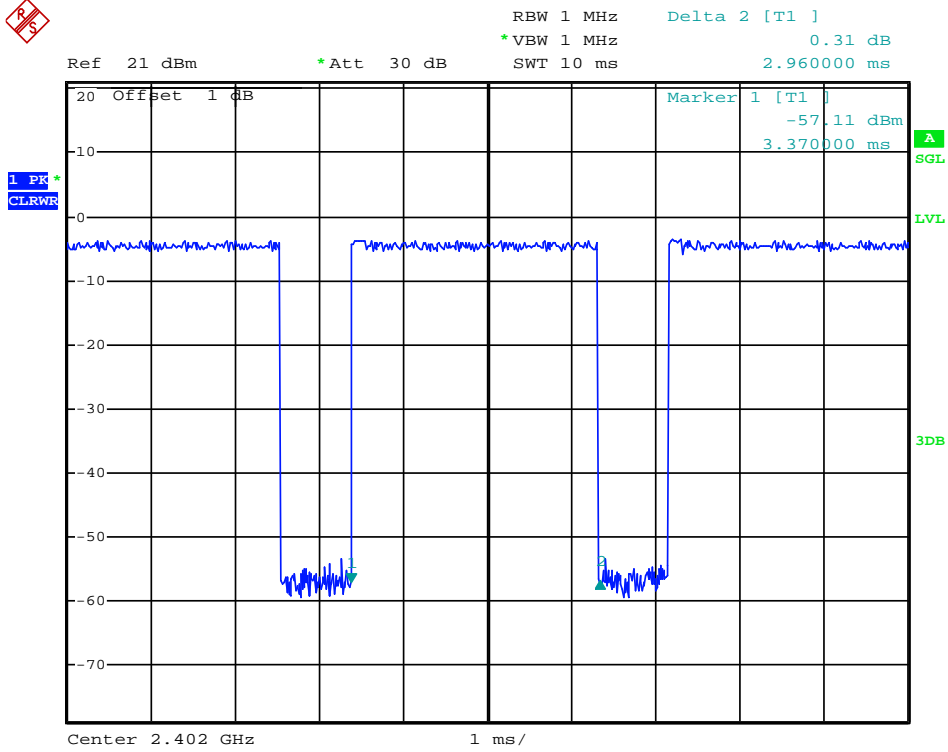

Date: 6.JAN.2014 16:48:52

(Plot 4.8.3.C1: Channel 00: 2402MHz @ $\pi/4$ DQPSK @ DH5)

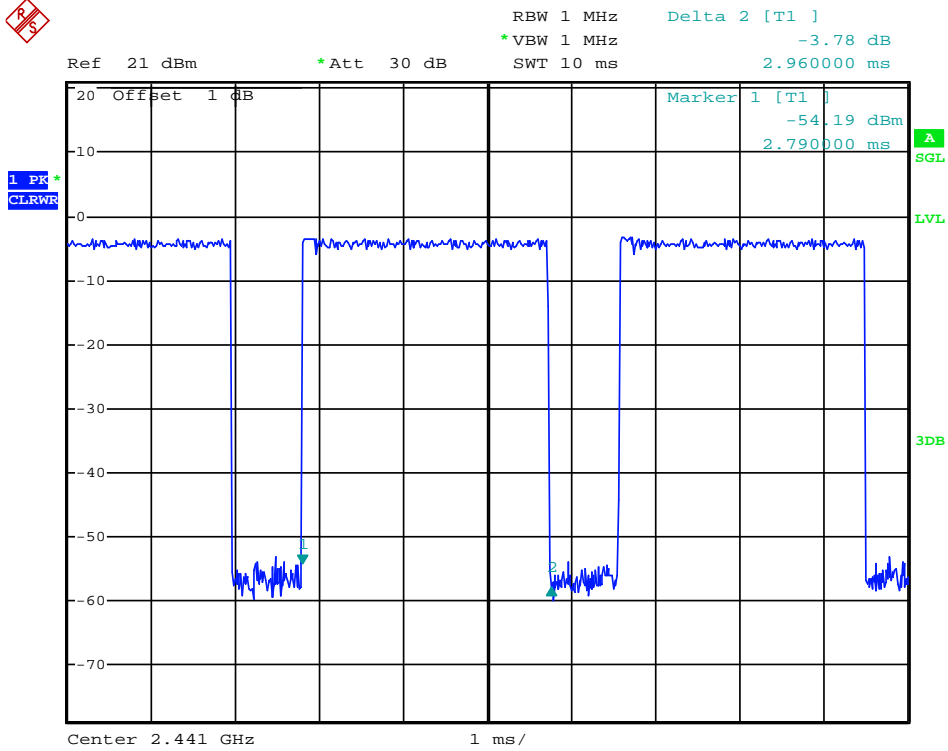

Date: 6.JAN.2014 16:49:40

(Plot 4.8.3.C2: Channel 39: 2441MHz @ $\pi/4$ DQPSK @ DH5)

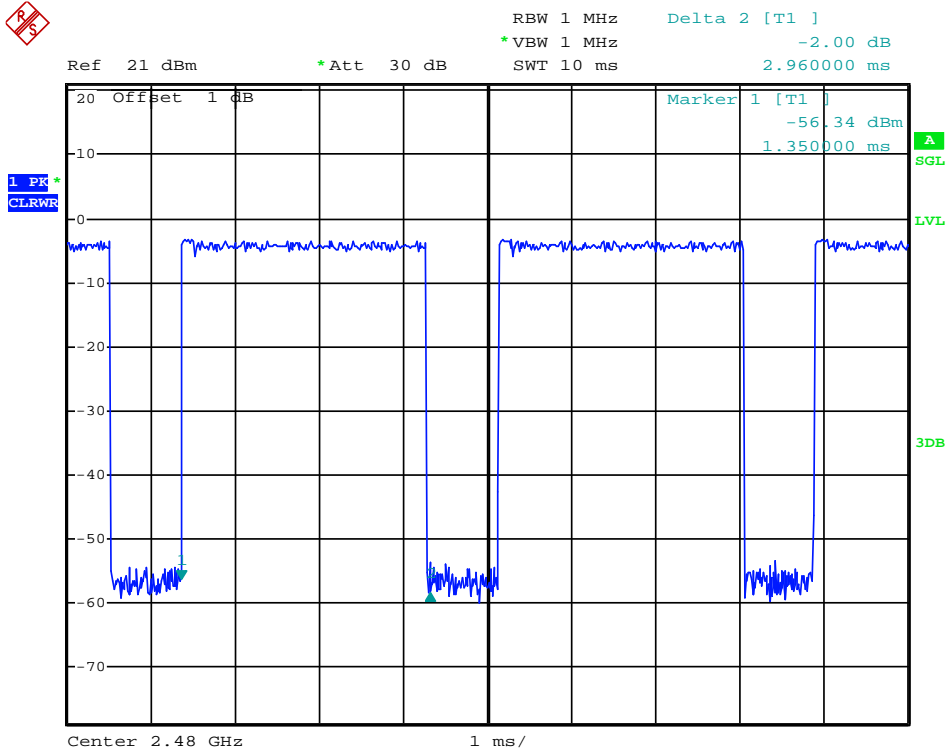

Date: 6.JAN.2014 16:50:07

(Plot 4.8.3.C3: Channel 78: 2480MHz @ $\pi/4$ DQPSK @ DH5)

4.9. Spurious RF Conducted Emission

TEST CONFIGURATION

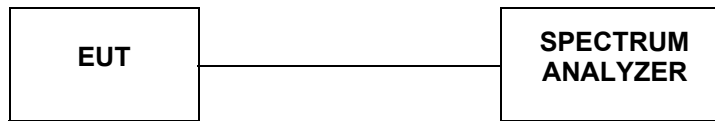

TEST PROCEDURE

The Spurious RF conducted emissions compliance of RF radiated emission should be measured by following the guidance in ANSI C63.10-2009 with respect to maximizing the emission by rotating the EUT, measuring the emission while the EUT is situated in three orthogonal planes (if appropriate), adjusting the measurement antenna height and polarization etc. Set RBW=100kHz and VBM= 300KHz to measure the peak field strength , and measurement frequency range from 30MHz to 26.5GHz.

LIMIT

1. Below -20dB of the highest emission level in operating band.
2. Fall in the restricted bands listed in section 15.205. The maximum permitted average field strength is listed in section 15.209.

TEST RESULTS

Remark: we measured all conditions(DH1,DH3,DH5) and recorded worst case at DH1

4.9.1 GFSK Test Mode

A. Test Verdict

Channel	Frequency (MHz)	Refer to Plot	Limit (dBc)	Verdict
00	2402	Plot 4.9.1 A1	-20	PASS
		Plot 4.9.1 A2	-20	PASS
		Plot 4.9.1 A3	-20	PASS
		Plot 4.9.1 A4	-20	PASS
39	2441	Plot 4.9.1 B1	-20	PASS
		Plot 4.9.1 B2	-20	PASS
		Plot 4.9.1 B3	-20	PASS
		Plot 4.9.1 B1	-20	PASS
78	2480	Plot 4.9.1 C1	-20	PASS
		Plot 4.9.1 C2	-20	PASS
		Plot 4.9.1 C3	-20	PASS
		Plot 4.9.1 C4	-20	PASS

Note: 1. The test results including the cable lose.

B. Test Plots



*RBW 100 kHz Marker 2 [T1]
*VBW 300 kHz -47.21 dBm
SWT 300 ms 1.042770000 GHz

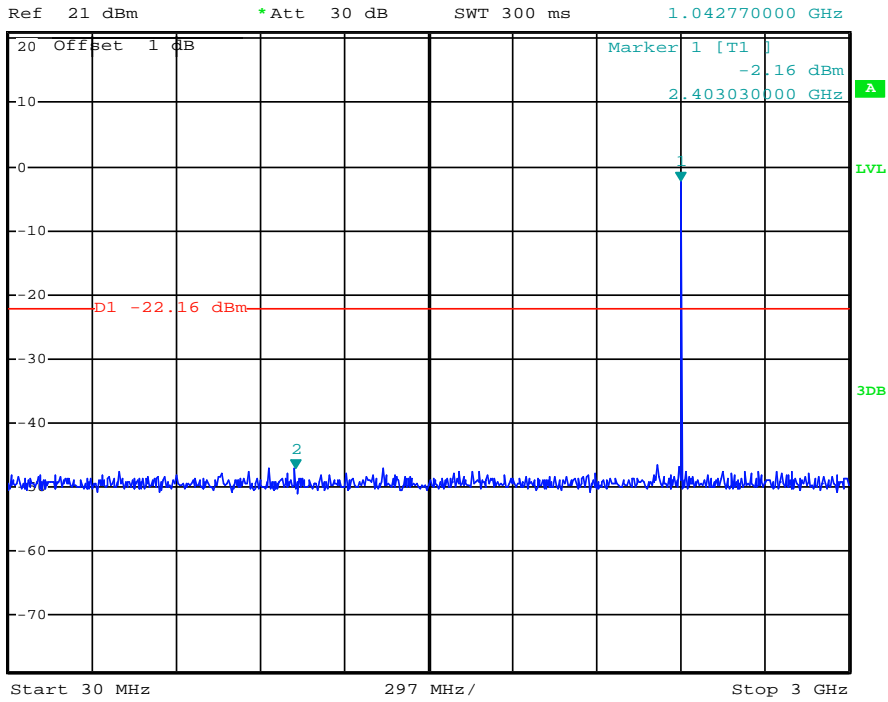

Date: 6.JAN.2014 16:52:58

(Plot 4.9.1.A1: Channel 00: 2402MHz @ GFSK)



*RBW 100 kHz Marker 1 [T1]
*VBW 300 kHz -44.11 dBm
SWT 1.2 s 14.184000000 GHz

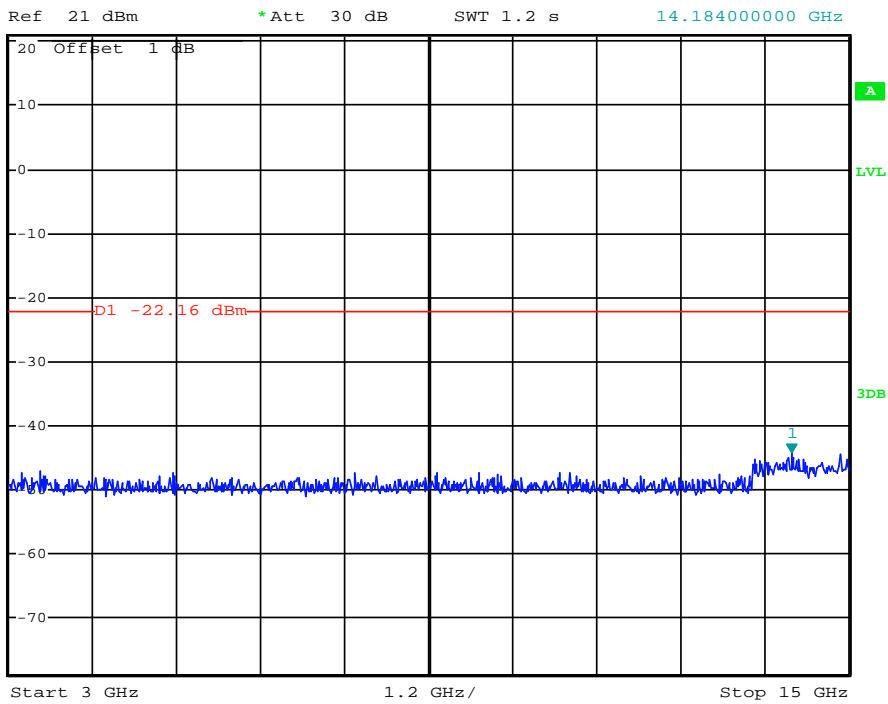

Date: 6.JAN.2014 16:53:21

(Plot 4.9.1.A2: Channel 00: 2402MHz @ GFSK)



*RBW 100 kHz Marker 1 [T1]
*VBW 300 kHz -42.35 dBm
SWT 1 s 24.98000000 GHz

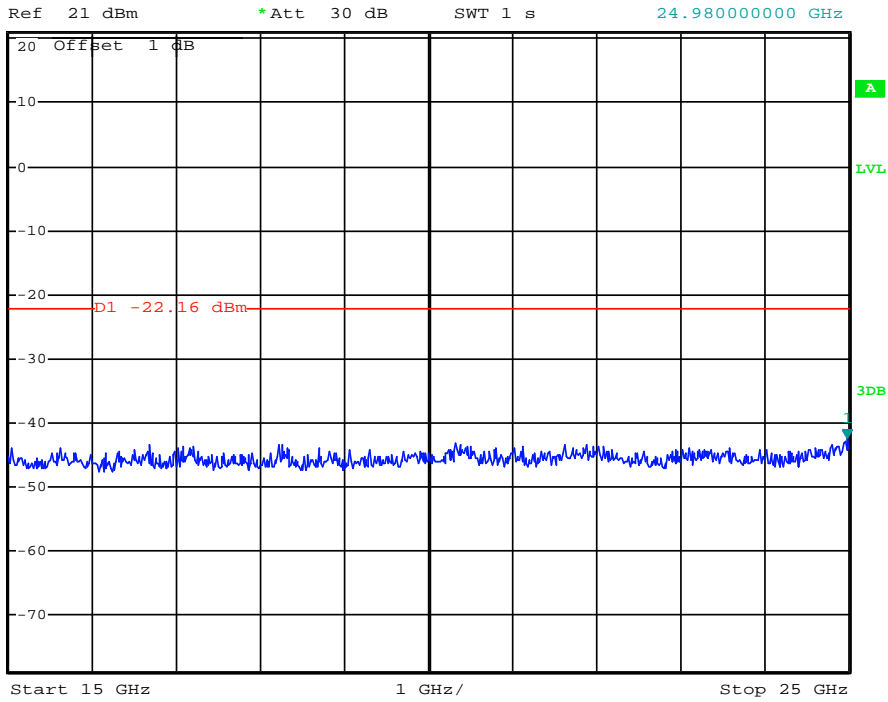

Date: 6.JAN.2014 16:53:42

(Plot 4.9.1.A3: Channel 00: 2402MHz @ GFSK)



*RBW 100 kHz Marker 2 [T1]
*VBW 300 kHz -47.19 dBm
SWT 300 ms 1.77636000 GHz

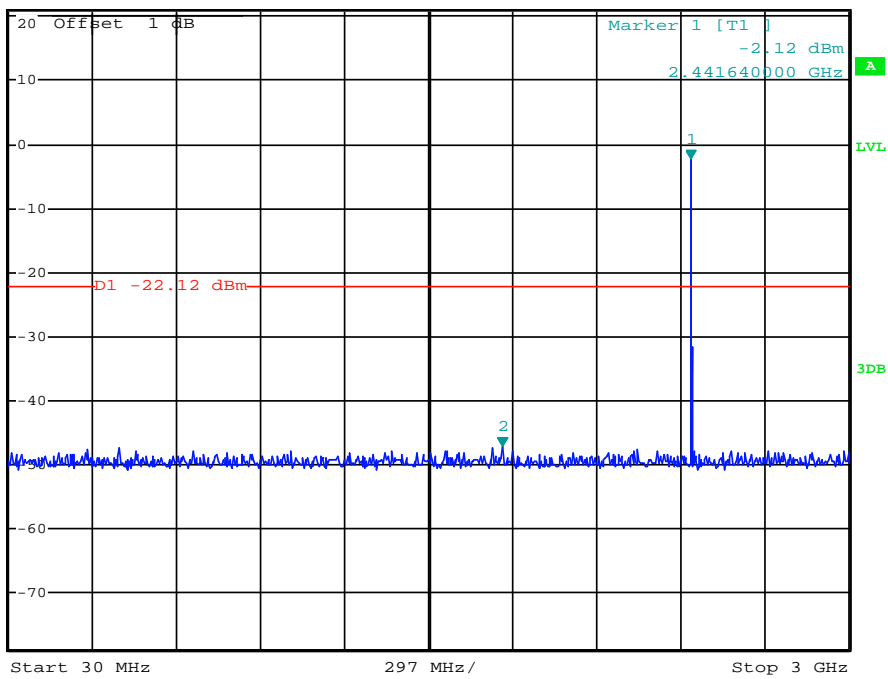

Date: 6.JAN.2014 16:54:35

(Plot 4.9.1.B1: Channel 39: 2441MHz @ GFSK)



*RBW 100 kHz Marker 1 [T1]
*VBW 300 kHz -44.77 dBm
SWT 1.2 s 14.52000000 GHz

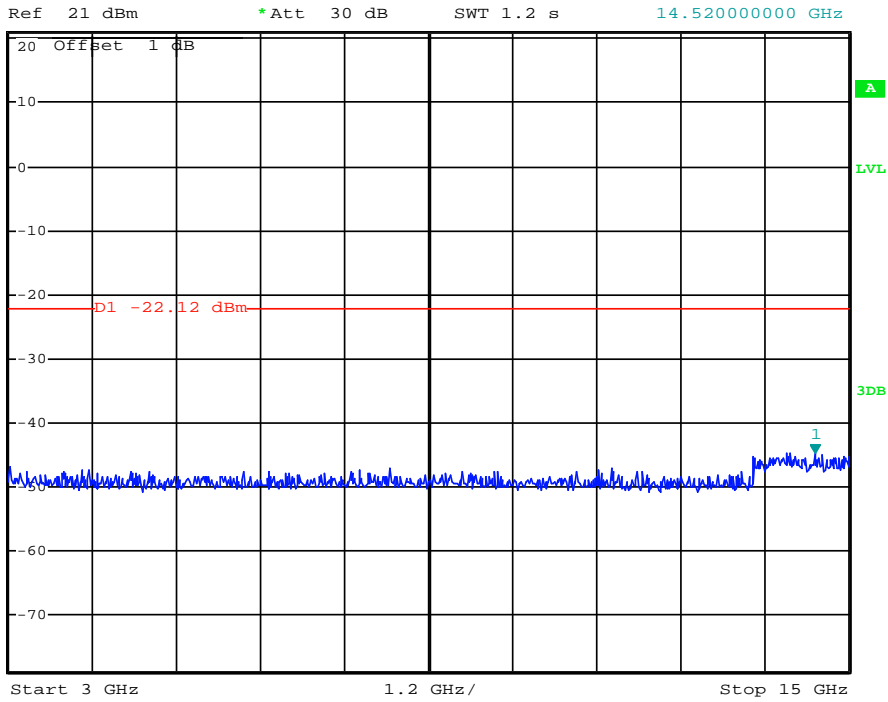

Date: 6.JAN.2014 16:55:00

(Plot 4.9.1.B2: Channel 39: 2441MHz @ GFSK)



*RBW 100 kHz Marker 1 [T1]
*VBW 300 kHz -42.97 dBm
SWT 1 s 18.78000000 GHz

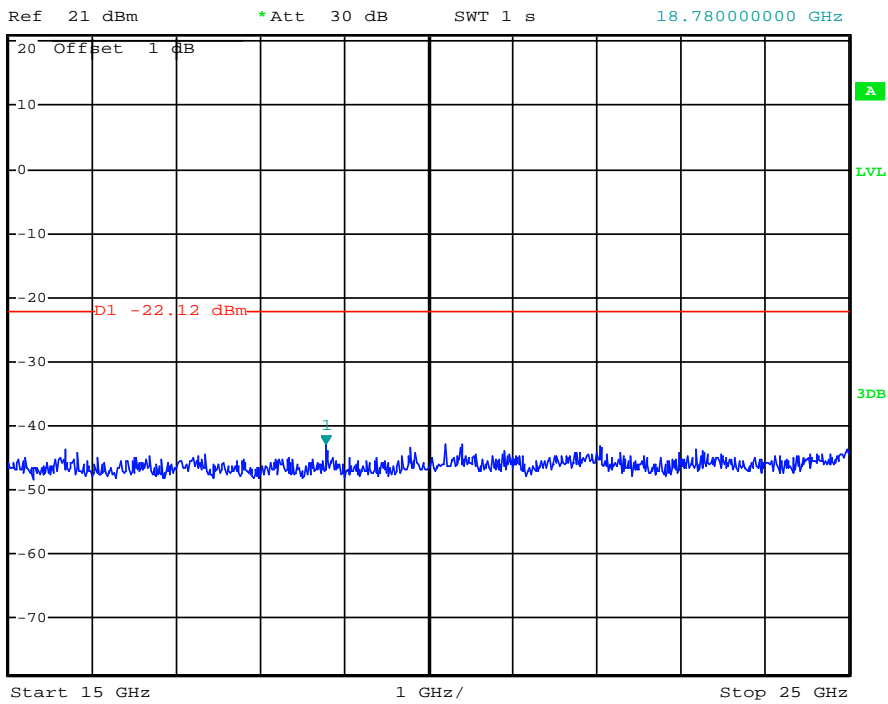

Date: 6.JAN.2014 16:55:15

(Plot 4.9.1.B3: Channel 39: 2441MHz @ GFSK)

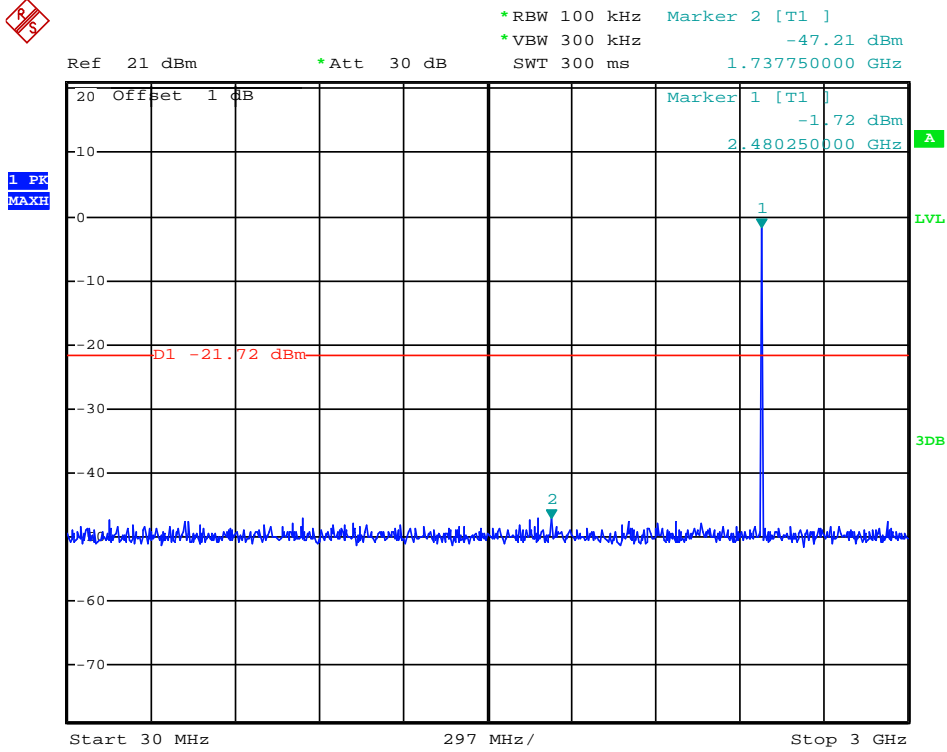

Date: 6.JAN.2014 16:55:50

(Plot 4.9.1.C1: Channel 78: 2480MHz @ GFSK)

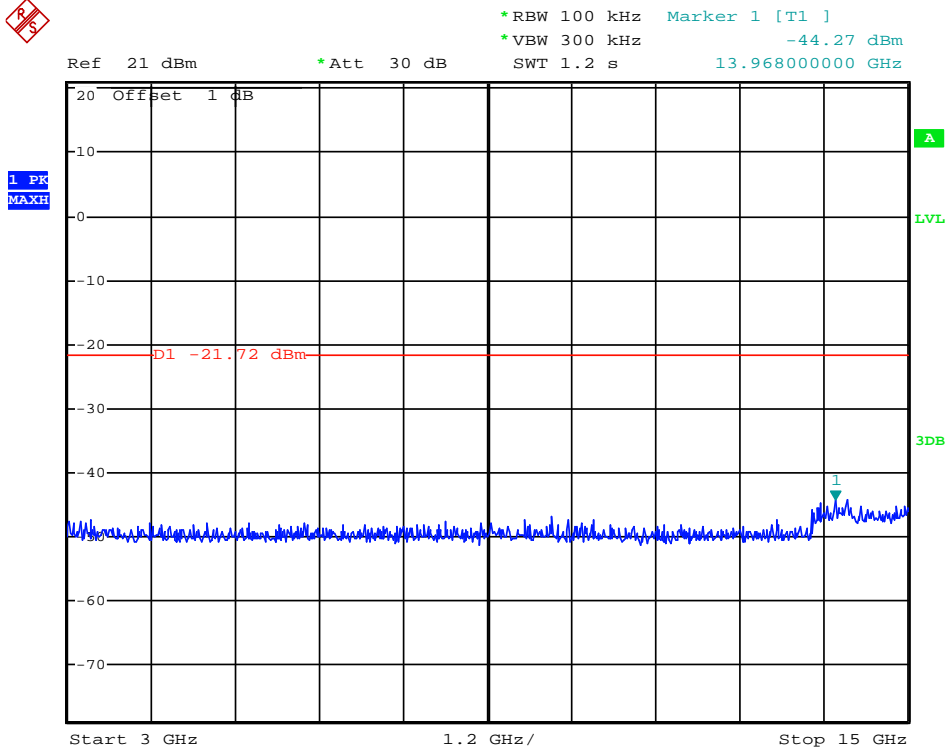

Date: 6.JAN.2014 16:56:08

(Plot 4.9.1.C2: Channel 78: 2480MHz @ GFSK)



*RBW 100 kHz Marker 1 [T1]
*VBW 300 kHz -42.99 dBm
SWT 1 s 21.66000000 GHz

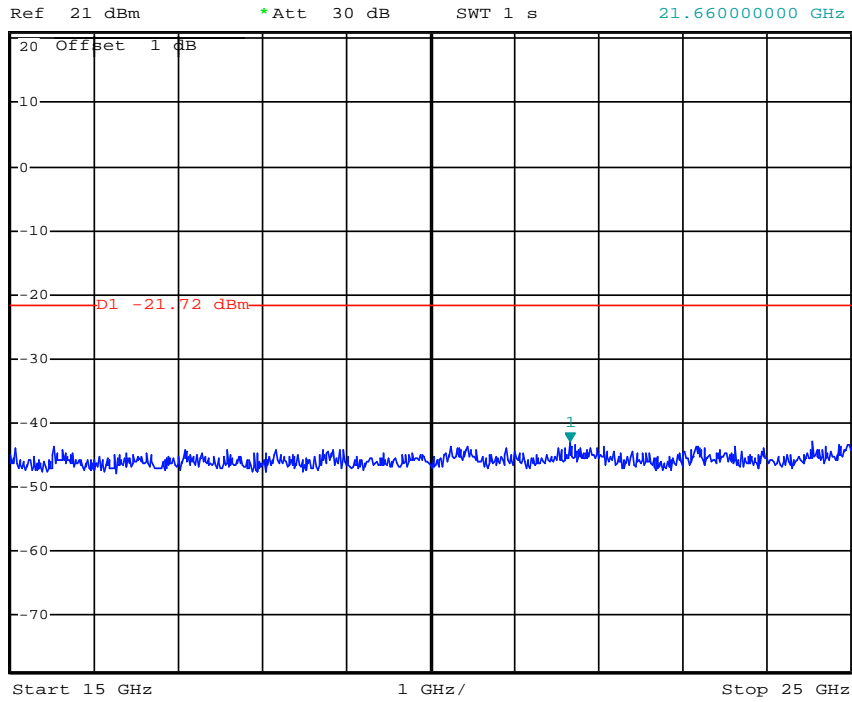

Date: 6.JAN.2014 16:56:24

(Plot 4.9.1.C3: Channel 78: 2480MHz @ GFSK)

4.9.2 8DPSK Test Mode

A. Test Verdict

Channel	Frequency (MHz)	Refer to Plot	Limit (dBc)	Verdict
00	2402	Plot 4.9.2 A1	-20	PASS
		Plot 4.9.2 A2	-20	PASS
		Plot 4.9.2 A3	-20	PASS
		Plot 4.9.2 A4	-20	PASS
39	2441	Plot 4.9.2 B1	-20	PASS
		Plot 4.9.2 B2	-20	PASS
		Plot 4.9.2 B3	-20	PASS
		Plot 4.9.2 B1	-20	PASS
78	2480	Plot 4.9.2 C1	-20	PASS
		Plot 4.9.2 C2	-20	PASS
		Plot 4.9.2 C3	-20	PASS
		Plot 4.9.2 C4	-20	PASS

Note: 1. The test results including the cable lose.

B. Test Plots

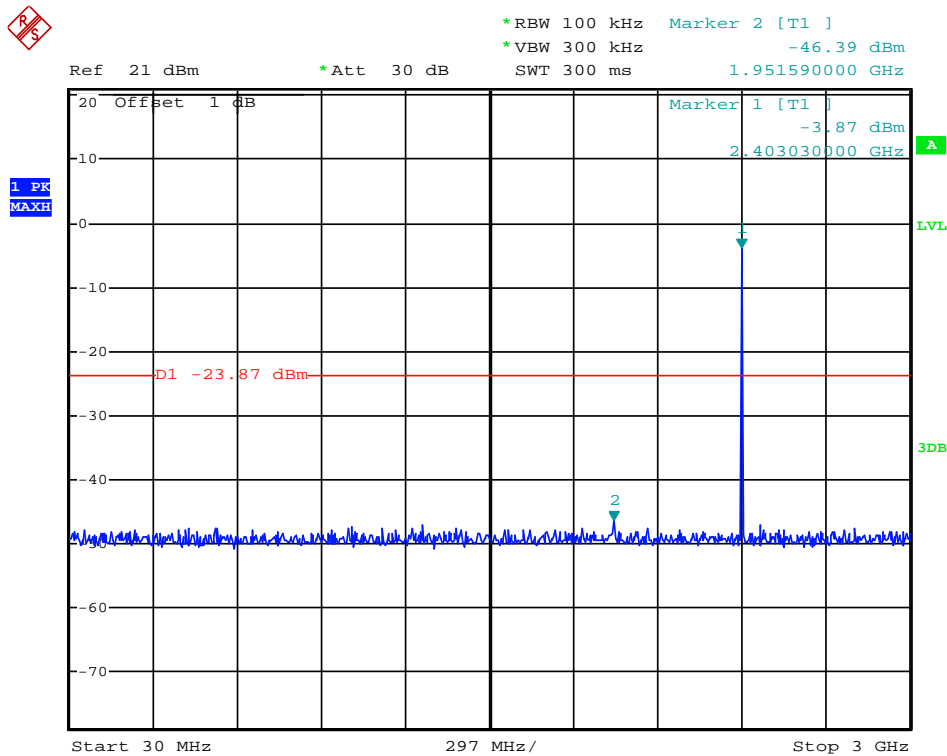

Date: 6.JAN.2014 16:57:40

(Plot 4.9.2.A1: Channel 00: 2402MHz @ 8DPSK)



*RBW 100 kHz Marker 1 [T1]
*VBW 300 kHz -44.92 dBm
SWT 1.2 s 14.016000000 GHz

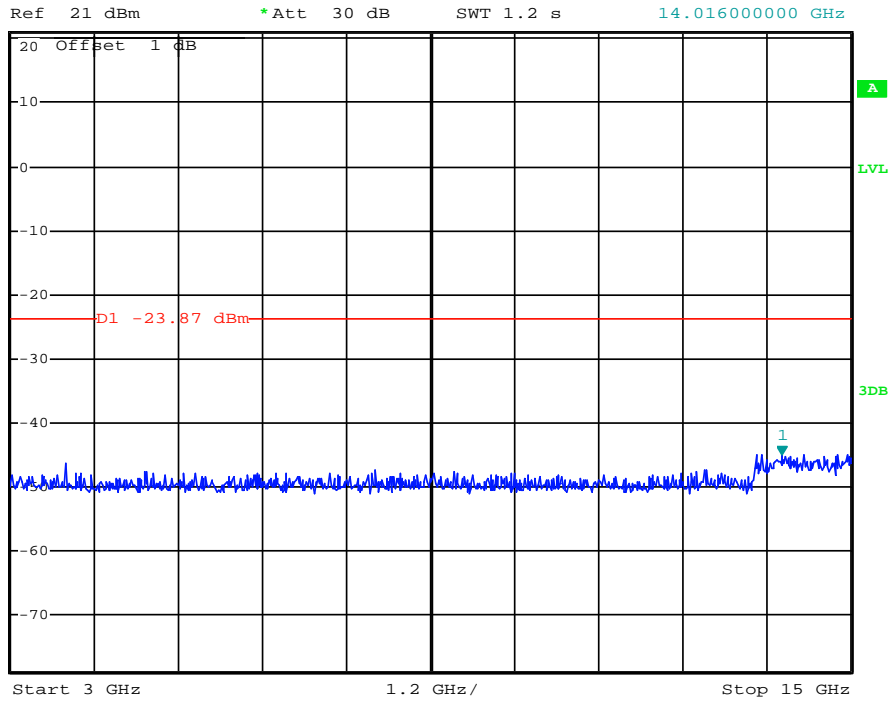

Date: 6.JAN.2014 16:58:40

(Plot 4.9.2.A2: Channel 00: 2402MHz @ 8DPSK)



*RBW 100 kHz Marker 1 [T1]
*VBW 300 kHz -42.68 dBm
SWT 1 s 22.050000000 GHz

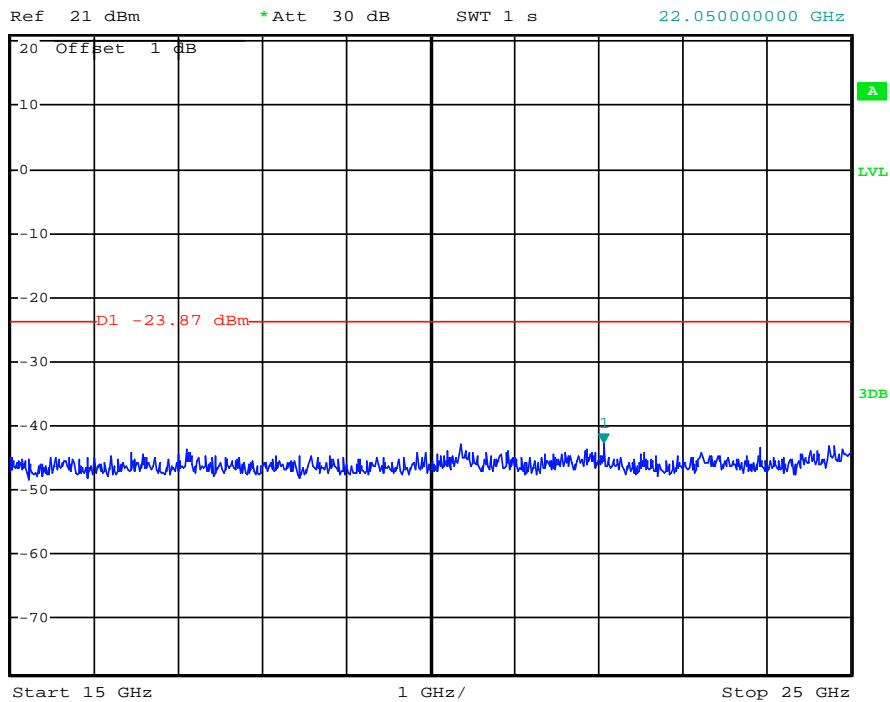

Date: 6.JAN.2014 16:58:55

(Plot 4.9.2.A3: Channel 00: 2402MHz @ 8DPSK)



*RBW 100 kHz Marker 1 [T1]
*VBW 300 kHz -3.44 dBm
SWT 300 ms 2.441640000 GHz

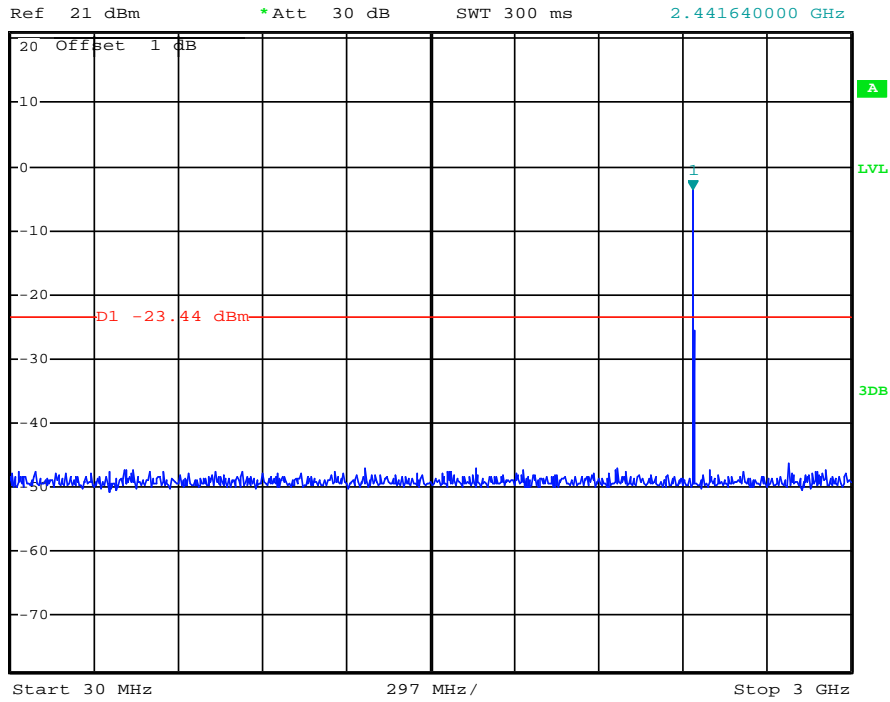

Date: 6.JAN.2014 17:00:13

(Plot 4.9.2.B1: Channel 39: 2441MHz @ 8DPSK)



*RBW 100 kHz Marker 1 [T1]
*VBW 300 kHz -44.31 dBm
SWT 1.2 s 14.112000000 GHz

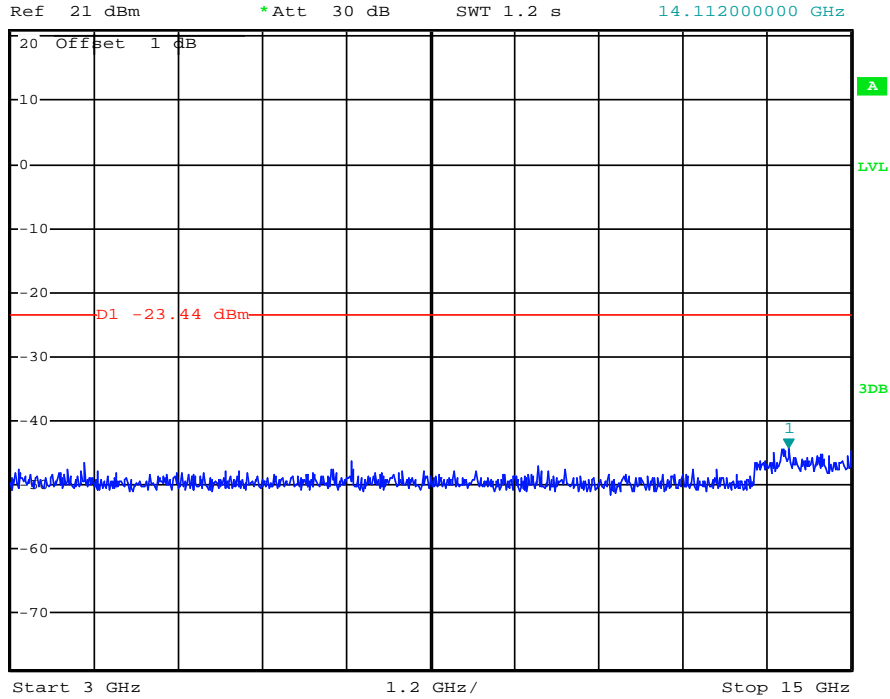

Date: 6.JAN.2014 17:00:31

(Plot 4.9.2.B2: Channel 39: 2441MHz @ 8DPSK)



*RBW 100 kHz Marker 1 [T1]
*VBW 300 kHz -43.00 dBm
SWT 1 s 24.99000000 GHz

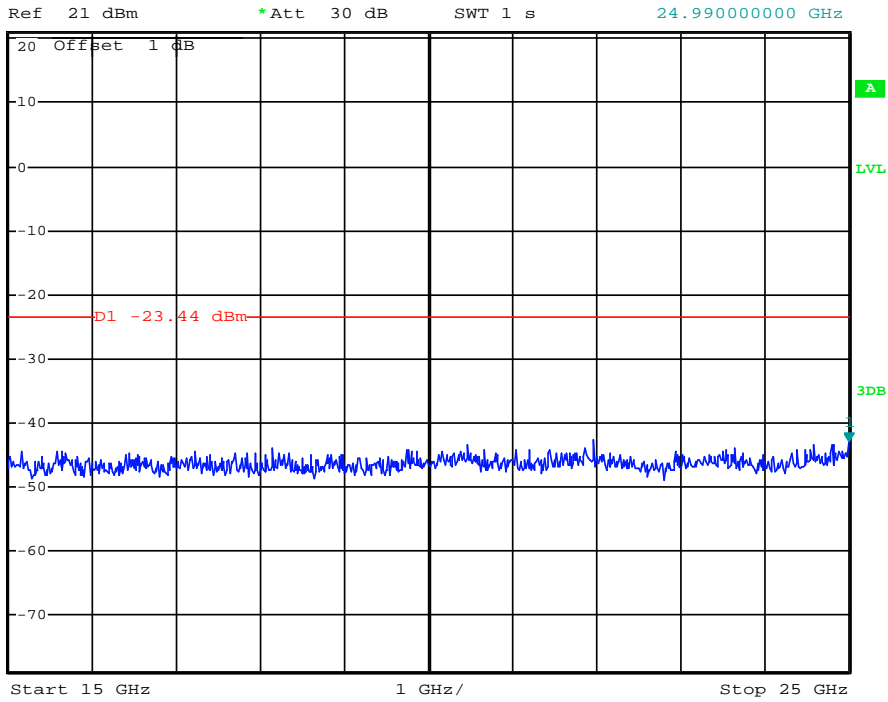

Date: 6.JAN.2014 17:00:41

(Plot 4.9.2.B3: Channel 39: 2441MHz @ 8DPSK)



*RBW 100 kHz Marker 1 [T1]
*VBW 300 kHz -3.63 dBm
SWT 300 ms 2.48025000 GHz

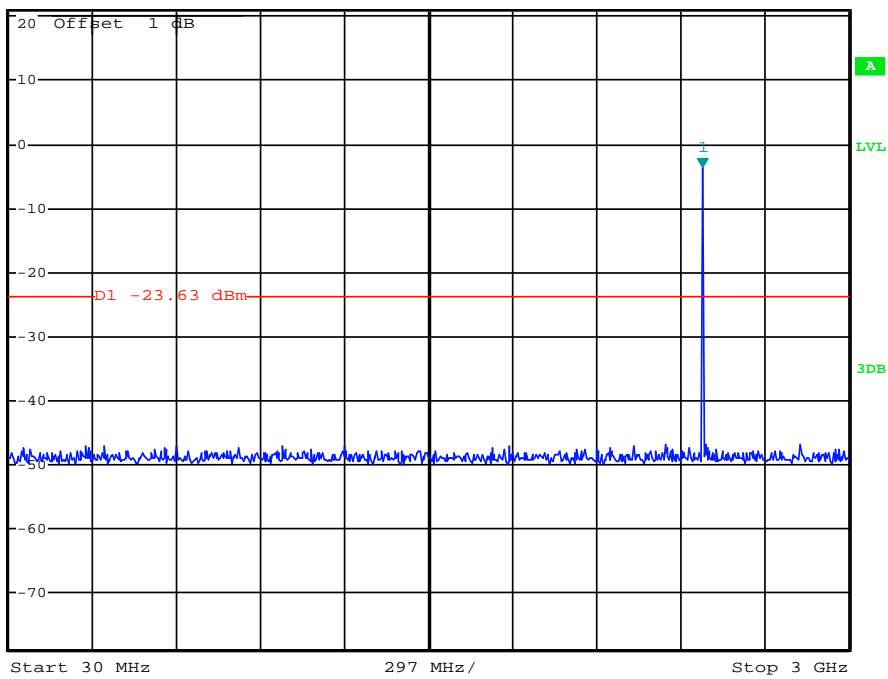

Date: 6.JAN.2014 17:03:06

(Plot 4.9.2.C1: Channel 78: 2480MHz @ 8DPSK)



*RBW 100 kHz Marker 1 [T1]
*VBW 300 kHz -44.84 dBm
SWT 1.2 s 14.076000000 GHz

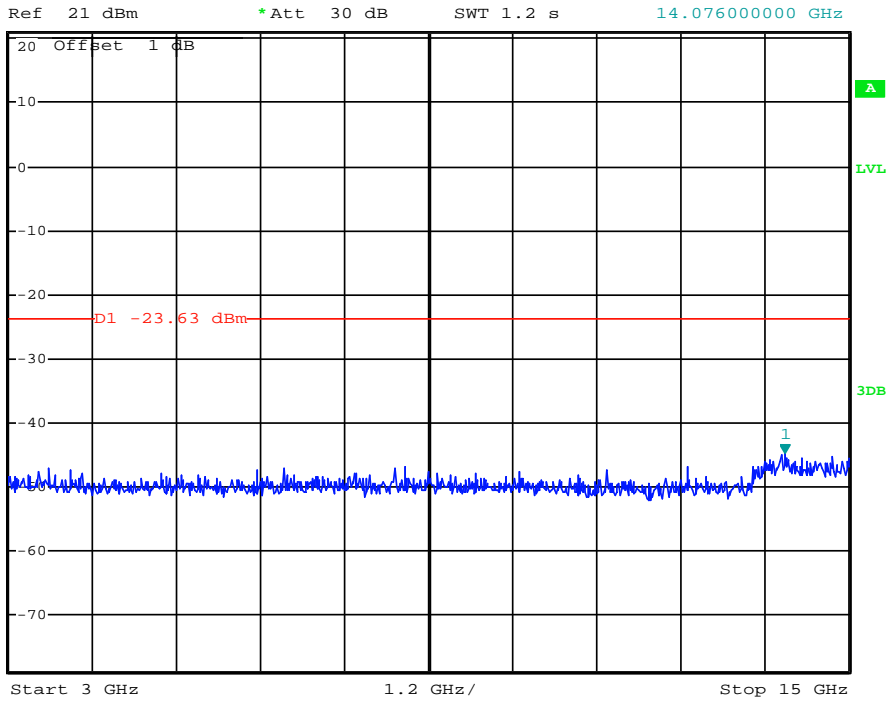

Date: 6.JAN.2014 17:03:18

(Plot 4.9.2.C2: Channel 78: 2480MHz @ 8DPSK)



*RBW 100 kHz Marker 1 [T1]
*VBW 300 kHz -43.16 dBm
SWT 1 s 21.770000000 GHz

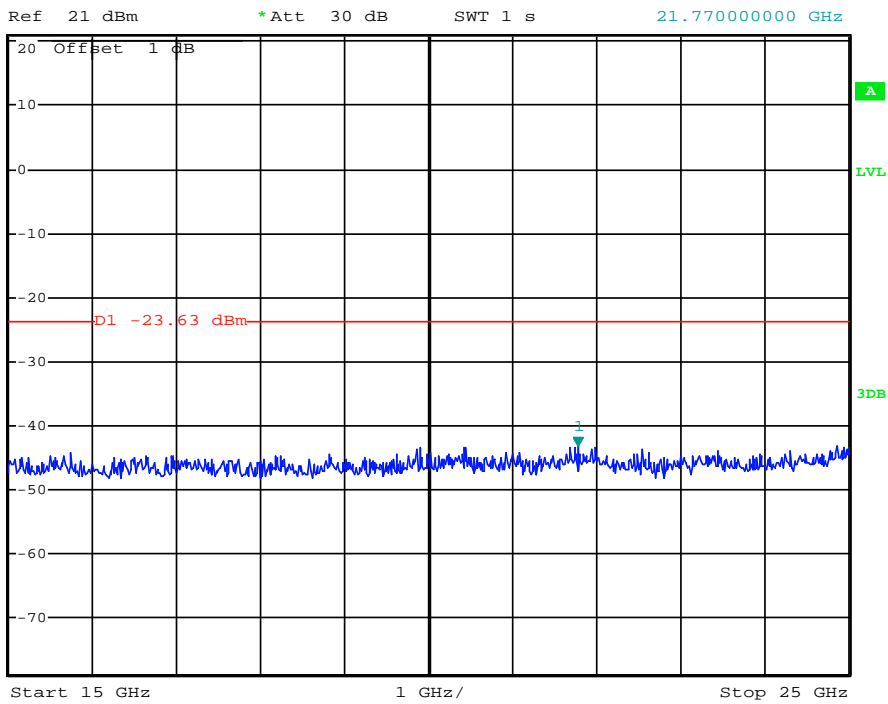

Date: 6.JAN.2014 17:03:29

(Plot 4.9.2.C3: Channel 78: 2480MHz @ 8DPSK)

4.9.3 $\pi/4$ DQPSK Test Mode

A. Test Verdict

Channel	Frequency (MHz)	Refer to Plot	Limit (dBc)	Verdict
00	2402	Plot 4.9.3 A1	-20	PASS
		Plot 4.9.3 A2	-20	PASS
		Plot 4.9.3 A3	-20	PASS
		Plot 4.9.3 A4	-20	PASS
39	2441	Plot 4.9.3 B1	-20	PASS
		Plot 4.9.3 B2	-20	PASS
		Plot 4.9.3 B3	-20	PASS
		Plot 4.9.3 B1	-20	PASS
78	2480	Plot 4.9.3 C1	-20	PASS
		Plot 4.9.3 C2	-20	PASS
		Plot 4.9.3 C3	-20	PASS
		Plot 4.9.3 C4	-20	PASS

Note: 1. The test results including the cable lose.

B. Test Plots

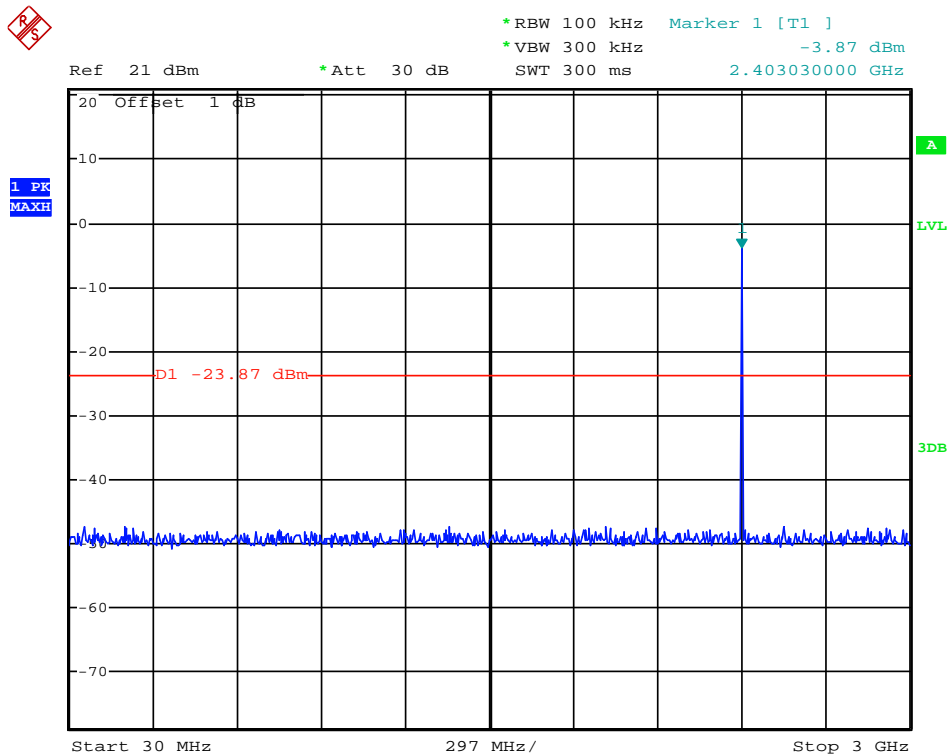

Date: 6.JAN.2014 17:04:58

(Plot 4.9.3.A1: Channel 00: 2402MHz @ $\pi/4$ DQPSK)



*RBW 100 kHz Marker 1 [T1]
*VBW 300 kHz -44.54 dBm
SWT 1.2 s 14.616000000 GHz

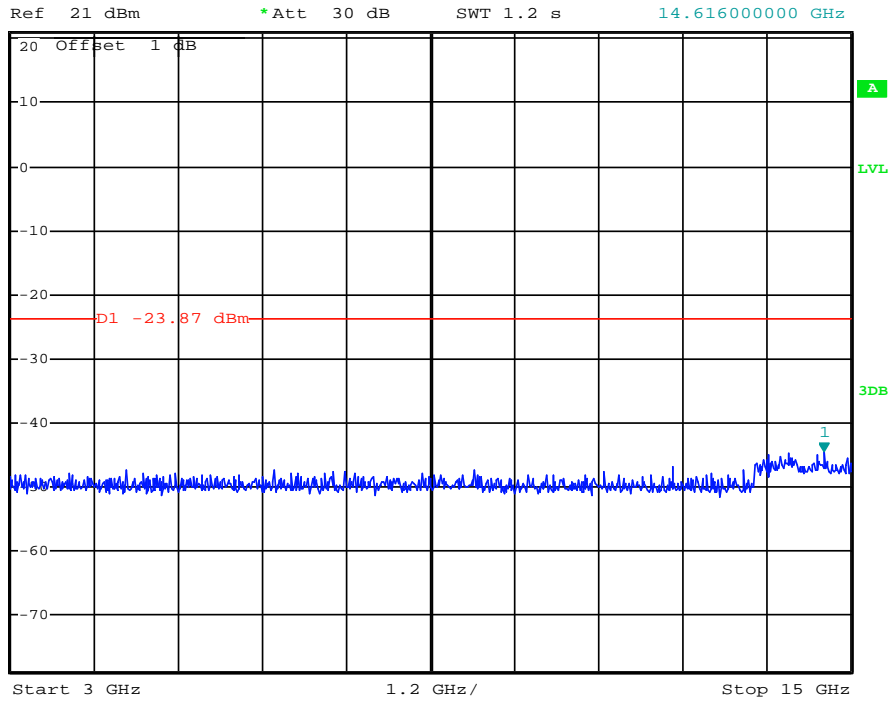

Date: 6.JAN.2014 17:05:12

(Plot 4.9.3.A2: Channel 00: 2402MHz @ $\pi/4$ DQPSK)



*RBW 100 kHz Marker 1 [T1]
*VBW 300 kHz -42.63 dBm
SWT 1 s 24.850000000 GHz

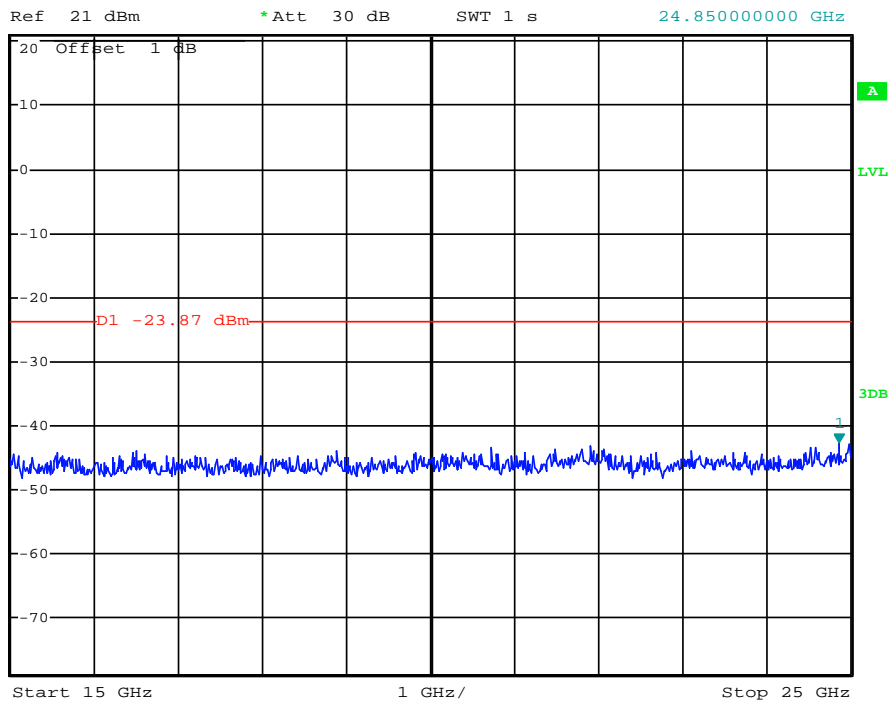

Date: 6.JAN.2014 17:05:24

(Plot 4.9.3.A3: Channel 00: 2402MHz @ $\pi/4$ DQPSK)



*RBW 100 kHz Marker 1 [T1]
*VBW 300 kHz -3.90 dBm
SWT 300 ms 2.441640000 GHz

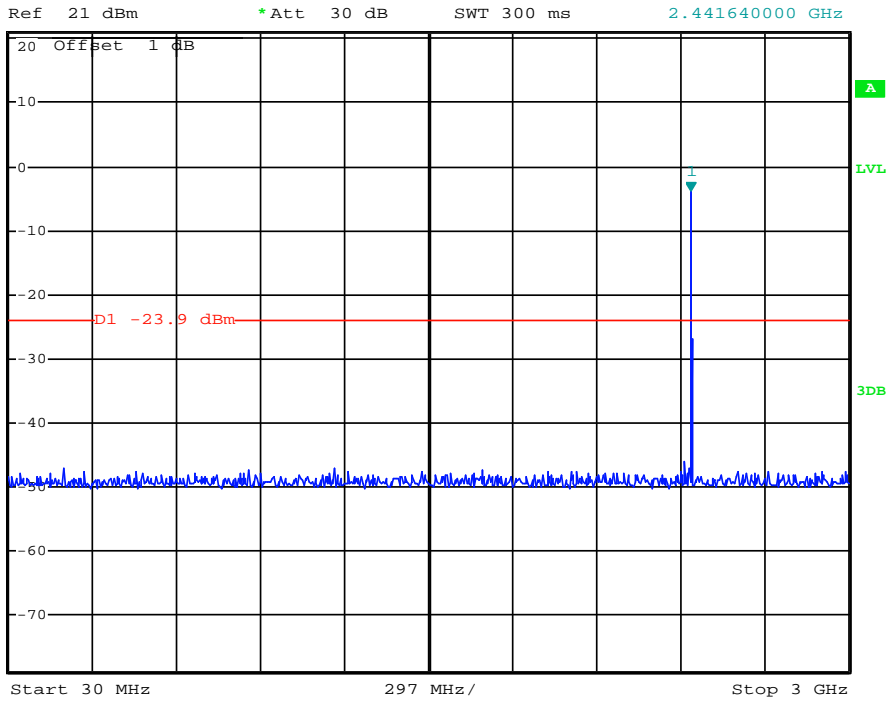

Date: 6.JAN.2014 17:06:38

(Plot 4.9.3.B1: Channel 39: 2441MHz @ $\pi/4$ DQPSK)



*RBW 100 kHz Marker 1 [T1]
*VBW 300 kHz -44.94 dBm
SWT 1.2 s 14.040000000 GHz

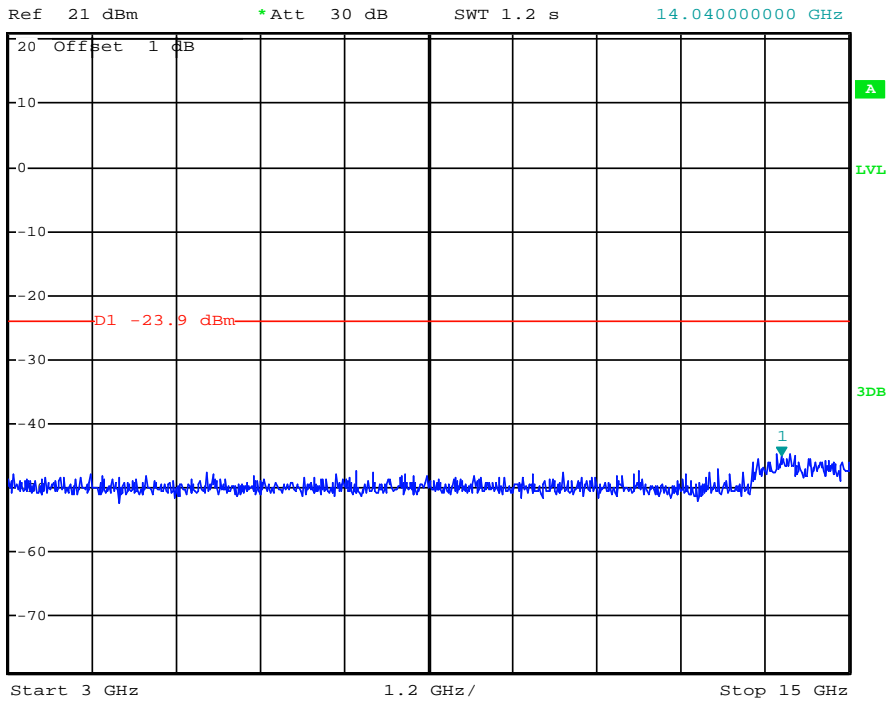

Date: 6.JAN.2014 17:06:50

(Plot 4.9.3.B2: Channel 39: 2441MHz @ $\pi/4$ DQPSK)



*RBW 100 kHz Marker 1 [T1]
*VBW 300 kHz -42.78 dBm
SWT 1 s 24.85000000 GHz

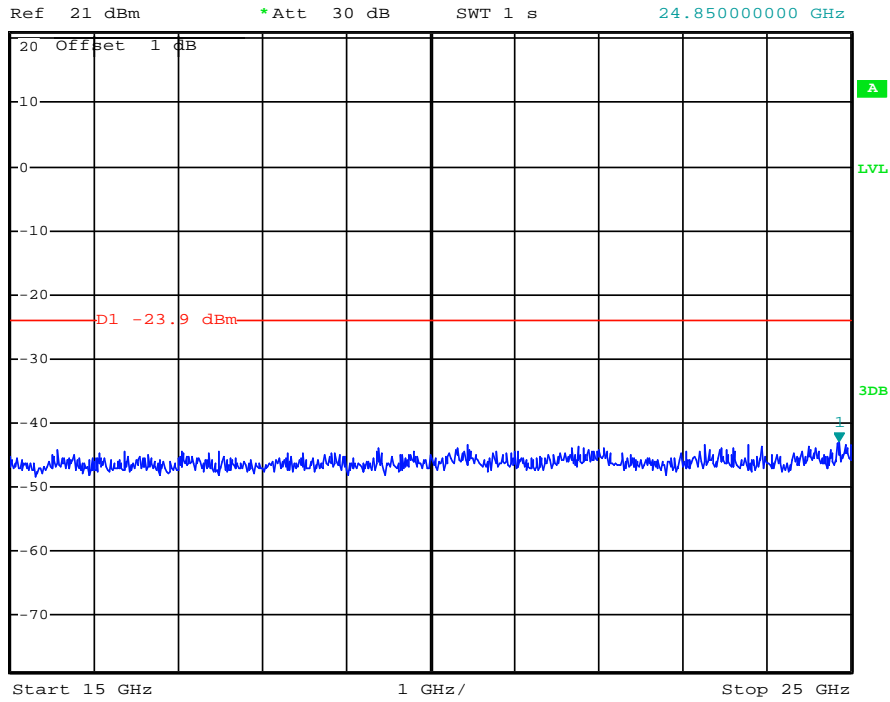

Date: 6.JAN.2014 17:07:01

(Plot 4.9.3.B3: Channel 39: 2441MHz @ $\pi/4$ DQPSK)



*RBW 100 kHz Marker 1 [T1]
*VBW 300 kHz -3.51 dBm
SWT 300 ms 2.48025000 GHz

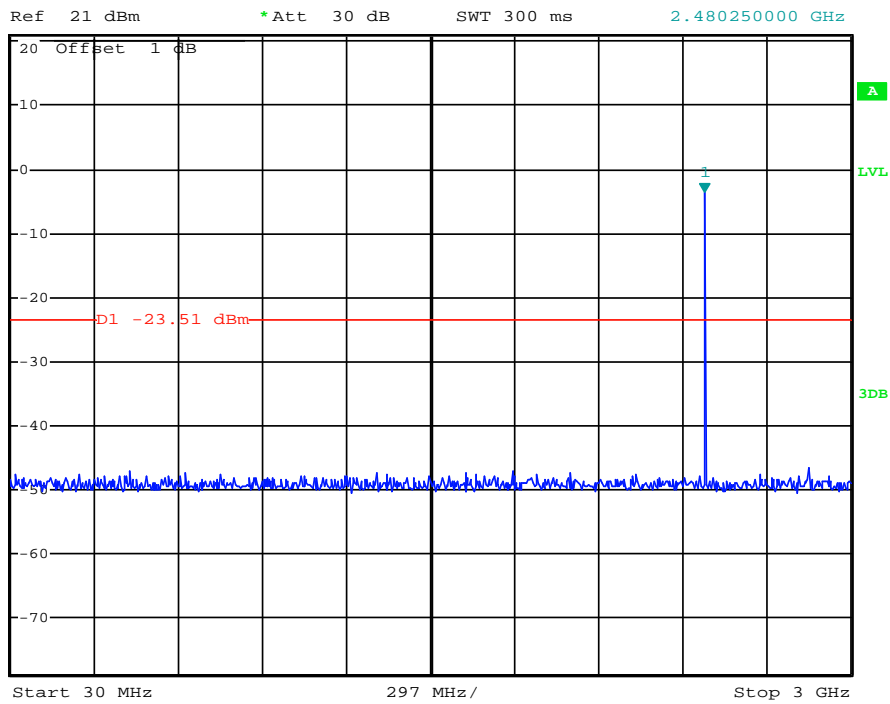

Date: 6.JAN.2014 17:08:18

(Plot 4.9.3.C1: Channel 78: 2480MHz @ $\pi/4$ DQPSK)



*RBW 100 kHz Marker 1 [T1]
*VBW 300 kHz -44.40 dBm
SWT 1.2 s 14.016000000 GHz

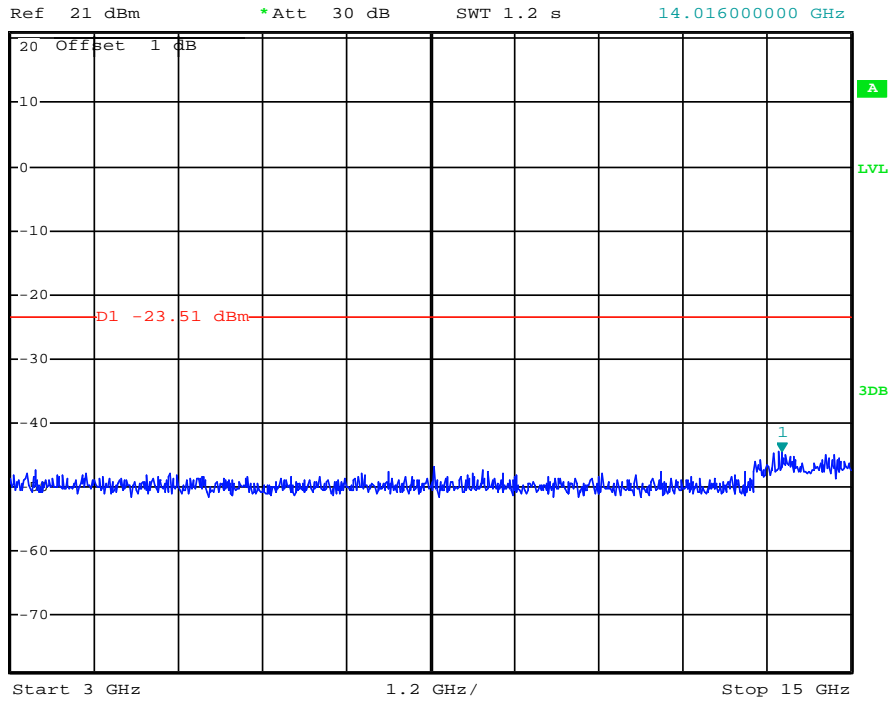

Date: 6.JAN.2014 17:08:32

(Plot 4.9.3.C2: Channel 78: 2480MHz @ $\pi/4$ DQPSK)



*RBW 100 kHz Marker 1 [T1]
*VBW 300 kHz -42.44 dBm
SWT 1 s 24.950000000 GHz

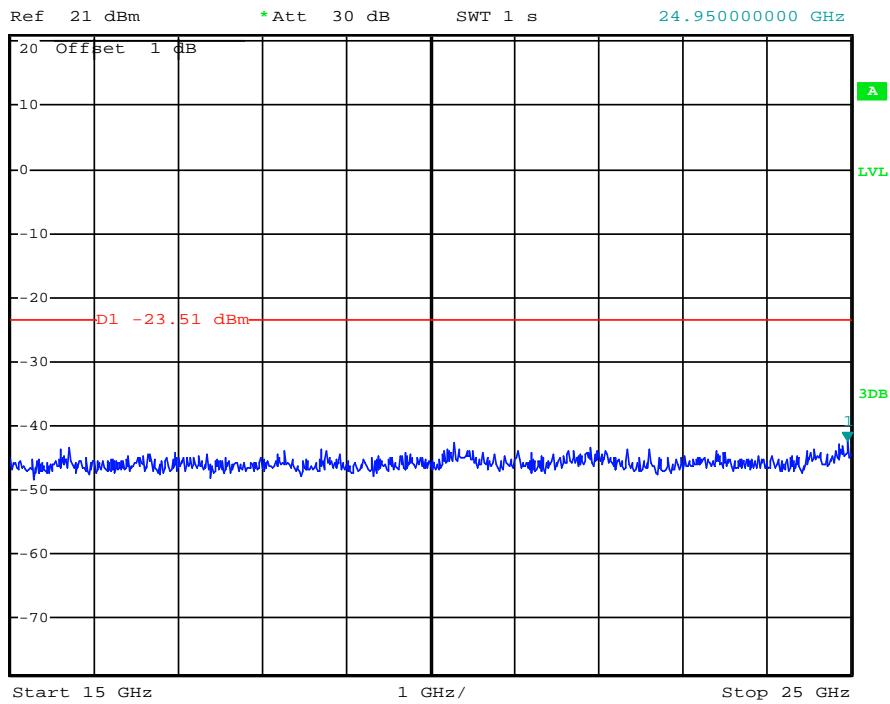

Date: 6.JAN.2014 17:08:47

(Plot 4.9.3.C3: Channel 78: 2480MHz @ $\pi/4$ DQPSK)

4.10. Pseudorandom Frequency Hopping Sequence

TEST APPLICABLE

For 47 CFR Part 15C section 15.247 (a)(1) requirement:

Frequency hopping systems shall have hopping channel carrier frequencies separated by a minimum of 25 kHz or the 20 dB bandwidth of the hopping channel, whichever is greater. Alternatively, frequency hopping systems operating in the 2400–2483.5 MHz band may have hopping channel carrier frequencies that are separated by 25 kHz or two-thirds of the 20 dB bandwidth of the hopping channel, whichever is greater, provided the systems operate with an output power no greater than 125 mW. The system shall hop to channel frequencies that are selected at the system hopping rate from a pseudo randomly ordered list of hopping frequencies. Each frequency must be used equally on the average by each transmitter. The system receivers shall have input bandwidths that match the hopping channel bandwidths of their corresponding transmitters and shall shift frequencies in synchronization with the transmitted signals.

EUT Pseudorandom Frequency Hopping Sequence Requirement

The pseudorandom frequency hopping sequence may be generated in a nine-stage shift register whose 5th and 9th stage outputs are added in a modulo-two addition stage. And the result is fed back to the input of the first stage. The sequence begins with the first one of 9 consecutive ones, for example: the shift register is initialized with nine ones.

- Number of shift register stages:9
- Length of pseudo-random sequence:29-1=511 bits
- Longest sequence of zeros:8(non-inverted signal)

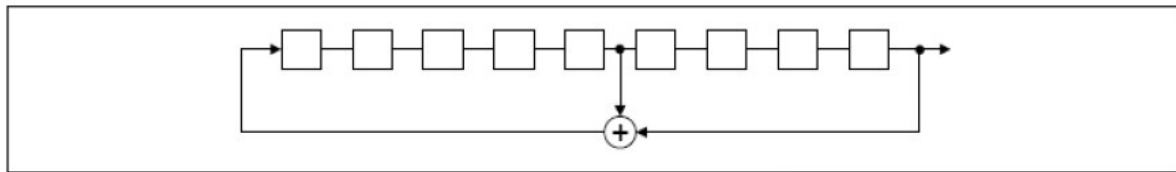

Linear Feedback Shift Register for Generation of the PRBS sequence

An example of pseudorandom frequency hopping sequence as follows:

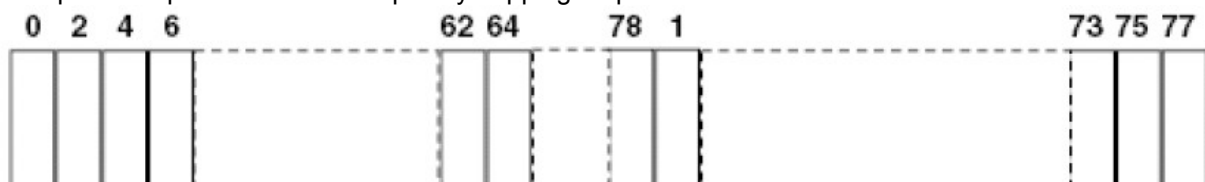

Each frequency used equally on the average by each transmitter. The system receiver has input bandwidths that match the hopping channel bandwidths of their corresponding transmitter and shifts frequencies in synchronization with the transmitted signals.

4.11. Antenna Requirement

Standard Applicable

For intentional device, according to FCC 47 CFR Section 15.203, an intentional radiator shall be designed to ensure that no antenna other than that furnished by the responsible party shall be used with the device.

And according to FCC 47 CFR Section 15.247 (c), if transmitting antennas of directional gain greater than 6dBi are used, the power shall be reduced by the amount in dB that the directional gain of the antenna exceeds 6dBi.

Refer to statement below for compliance.

The manufacturer may design the unit so that the user can replace a broken antenna, but the use of a standard antenna jack or electrical connector is prohibited. Further, this requirement does not apply to intentional radiators that must be professionally installed.

Antenna Connected Construction

The WLAN and Bluetooth sharing same antenna and the maximum antenna gain of Bluetooth used was 0.40 dBi.



5. Test Setup Photos of the EUT

Radiated Emission (30MHz-1GHz)



Radiated Emission (above 1GHz)



Radiated Emission (Below 30MHz)



Conducted Emission (AC Mains)



6. External and Internal Photos of the EUT

External photos of the EUT









Internal photos of the EUT

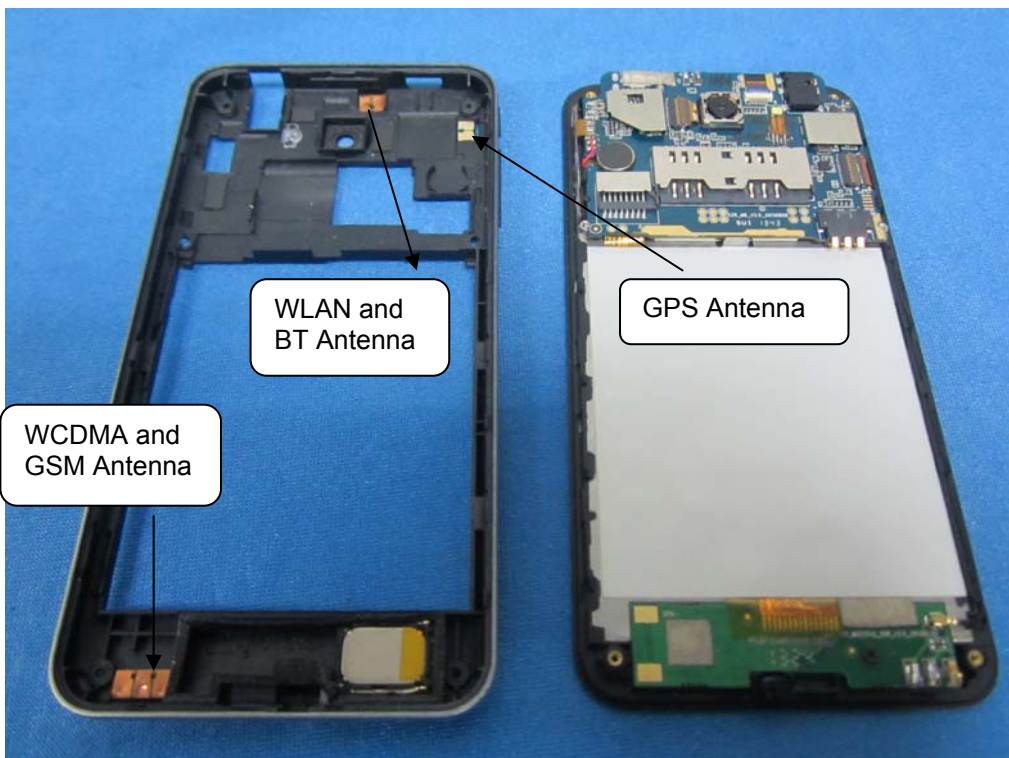



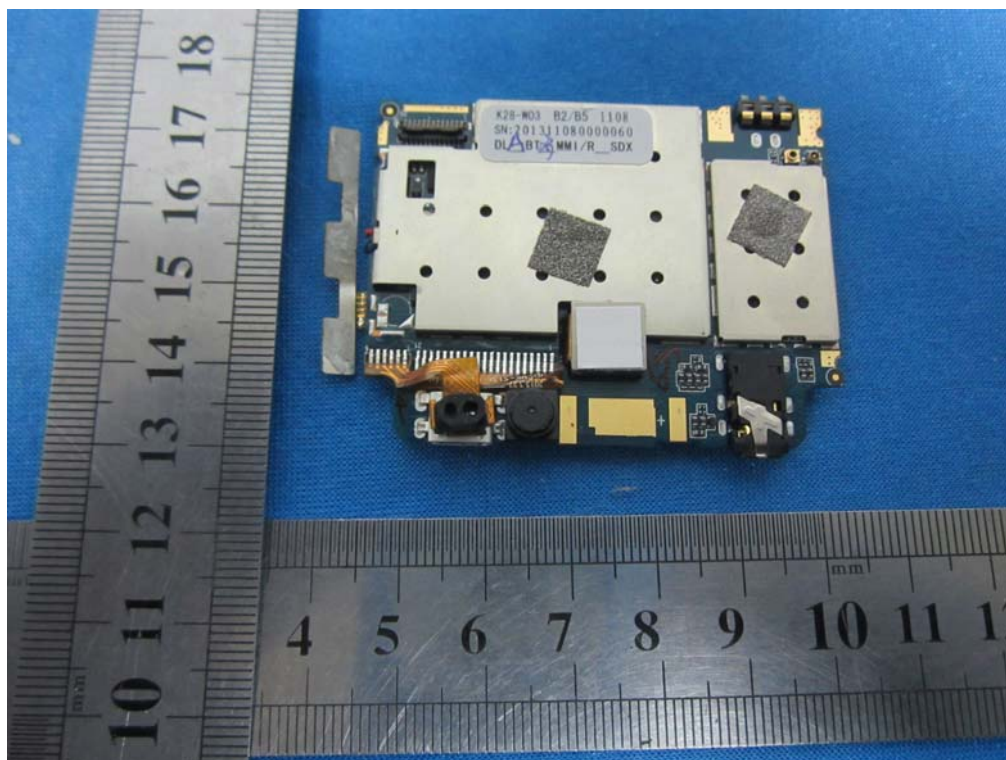
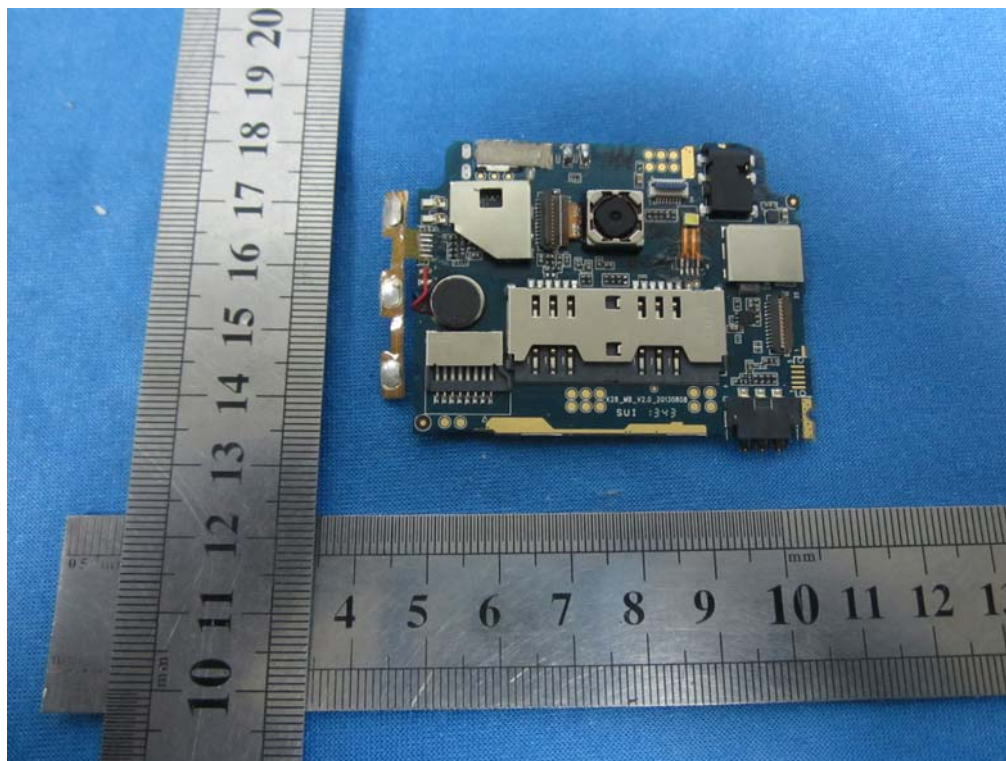

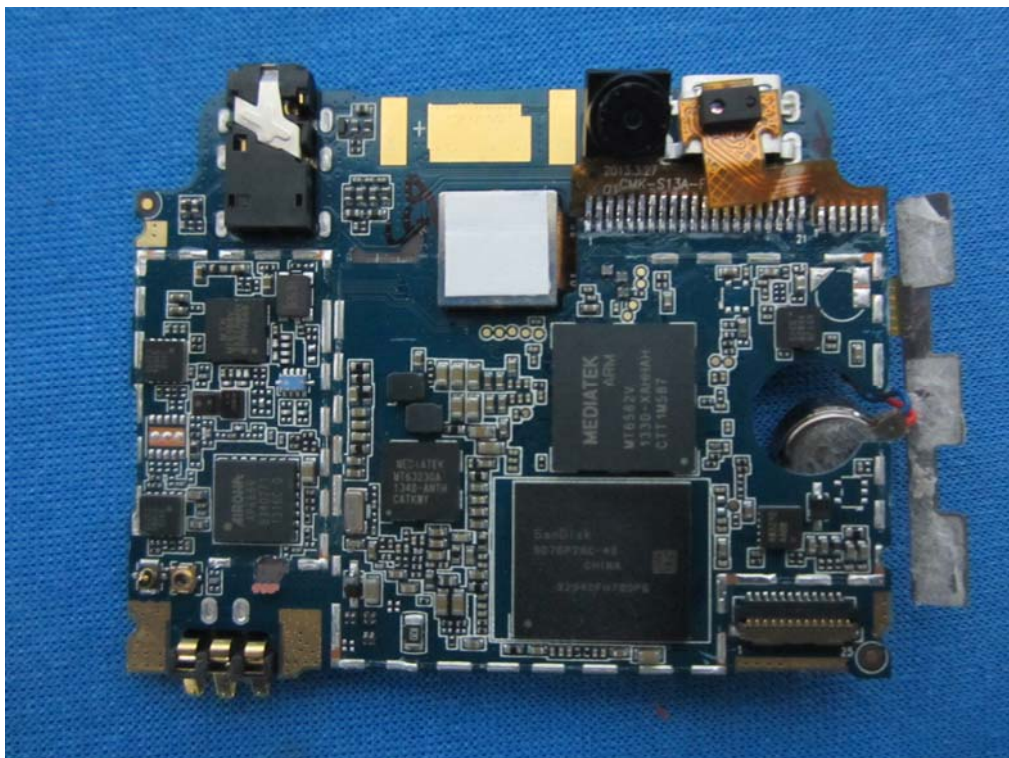
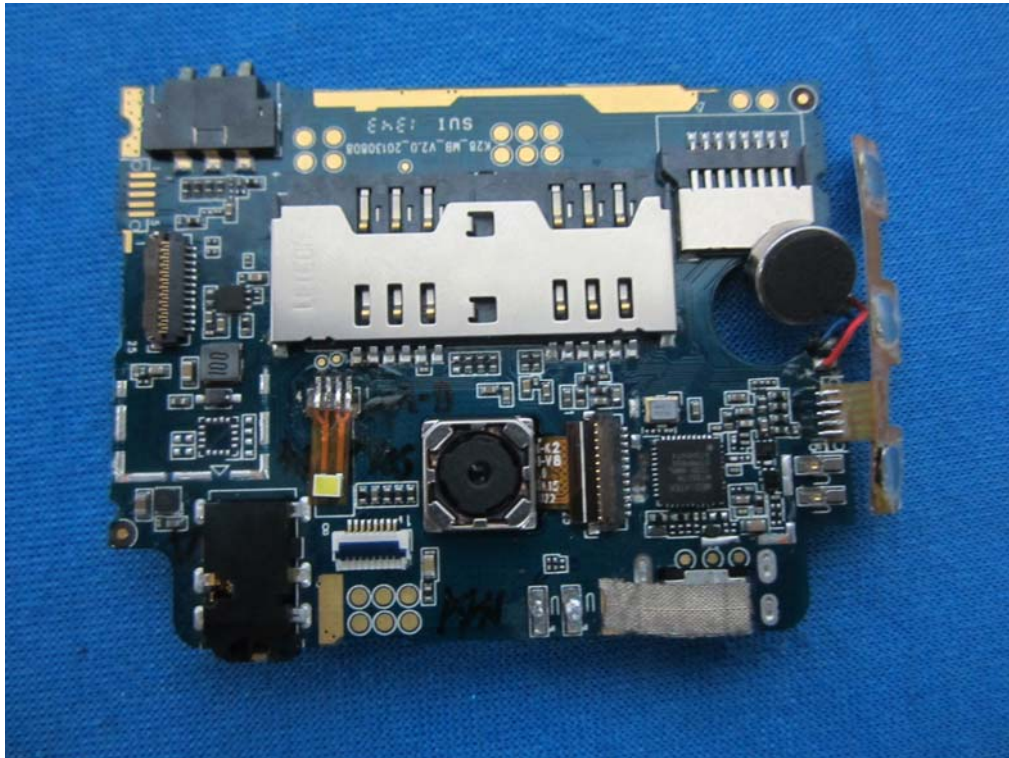

.....End of Report.....