



FCC PART 22/24 TEST REPORT

FCC Part 22 /Part 24

Report Reference No..... : TRE1401002102 R/C: 88877

FCC ID..... : YPVITALCOMZEUZ-HD

Compiled by

(position+printed name+signature)..: File administrators Jerome Luo

Jerome Luo

Supervised by

(position+printed name+signature)..: Test Engineer Yuchao Wang

yuchao.wang

Approved by

(position+printed name+signature)..: Manager Wenliang Li

Wenliang Li

Date of issue..... : Jan 15, 2014

Testing Laboratory Name : Shenzhen Huatongwei International Inspection Co., Ltd

Address..... : Keji Nan No.12 Road, Hi-tech Park, Shenzhen, China

Applicant's name : ITALCOM GROUP

Address..... : 2175 NORTHWEST 115TH AVE. DORAL FL 33172, USA

Test specification

Standard : FCC Part 22: PUBLIC MOBILE SERVICES

Standard : FCC Part 24: PERSONAL COMMUNICATIONS SERVICES

TRF Originator..... : Shenzhen Huatongwei International Inspection CO., Ltd

Master TRF..... : Dated 2006-06

Shenzhen Huatongwei International Inspection Co., Ltd. All rights reserved.

This publication may be reproduced in whole or in part for non-commercial purposes as long as the Shenzhen Huatongwei International Inspection Co., Ltd is acknowledged as copyright owner and source of the material. Shenzhen Huatongwei International Inspection Co., Ltd takes no responsibility for and will not assume liability for damages resulting from the reader's interpretation of the reproduced material due to its placement and context.

Test item description : mobile phone

Trade Mark : NYX

Manufacturer..... : ITALCOM GROUP

Model/Type reference..... : ZEUZ-HD

Listed Models : /

Ratings..... : DC 3.70V

Modulation : QPSK

Hardware version : 8061-MB-V0.3

Software version : SKY_AMXNYX_V001R

Android version : 4.2.2

Frequency..... : FDD WCDMA Band II,FDD WCDMA Band V

Result..... : **PASS**

T E S T R E P O R T

Test Report No. :	TRE1401002102	Jan 15, 2014
		Date of issue

Equipment under Test : mobile phone

Model /Type : ZEUZ-HD

Listed Models : /

Applicant : **ITALCOM GROUP**

Address : 1728 Coral Way,Coral Gables,Miami,Florida,United States

Manufacturer : **ITALCOM GROUP**

Address : 1728 Coral Way,Coral Gables,Miami,Florida,United States

Test Result	PASS
--------------------	-------------

The test report merely corresponds to the test sample.
It is not permitted to copy extracts of these test result without the written permission of the test laboratory.

Contents

1.	<u>TEST STANDARDS</u>	4
2.	<u>SUMMARY</u>	5
2.1.	General Remarks	5
2.2.	Product Description	5
2.3.	Equipment under Test	5
2.4.	Short description of the Equipment under Test (EUT)	6
2.5.	Internal Identification of EUT used during the test	6
2.6.	Internal Identification of AE used during the test	6
2.7.	Normal Accessory setting	6
2.8.	EUT configuration	6
2.9.	Related Submittal(s) / Grant (s)	7
2.10.	Modifications	7
2.11.	Note	7
3.	<u>TEST ENVIRONMENT</u>	8
3.1.	Address of the test laboratory	8
3.2.	Test Facility	8
3.3.	Environmental conditions	9
3.4.	Statement of the measurement uncertainty	9
3.5.	Test Description	9
3.6.	Equipments Used during the Test	10
4.	<u>TEST CONDITIONS AND RESULTS</u>	11
4.1.	Conducted Emissions Test	11
4.2.	OUTPUT POWER	16
4.3.	Radiated Spurious Emssion	19
4.4.	OCCUPIED BANDWIDTH	23
4.5.	EMISSION BANDWIDTH	28
4.6.	BAND EDGE COMPLIANCE	33
4.7.	Spurious Emssion on Antenna Port	37
4.8.	Frequency Stability Test	60
5.	<u>TEST SETUP PHOTOS OF THE EUT</u>	62
6.	<u>EXTERNAL AND INTERNAL PHOTOS OF THE EUT</u>	64

1. TEST STANDARDS

The tests were performed according to following standards:

[FCC Part 22 \(10-1-12 Edition\)](#): PRIVATE LAND MOBILE RADIO SERVICES.

[FCC Part 24\(10-1-12 Edition\)](#): PUBLIC MOBILE SERVICES

[TIA/EIA 603 D June 2010](#): Land Mobile FM or PM Communications Equipment Measurement and Performance Standards.

[47 CFR FCC Part 15 Subpart B](#): - Unintentional Radiators

[FCC Part 2](#): FREQUENCY ALLOCA-TIONS AND RADIO TREATY MAT-TERS; GENERAL RULES AND REG-ULATIONS

[KDB971168 D01:201](#): Procedures for Compliance Measurement of the Fundamental Emission Power of Licensed Wideband (> 1 MHz) Digital Transmission Systems

[ANSI C63.4:2009](#): Methods of Measurement of Radio-Noise Emissions from Low-Voltage Electrical and Electronic Equipment in the Range of 9 kHz to 40 GHz

2. SUMMARY

2.1. General Remarks

Date of receipt of test sample	:	Jan 07, 2014
Testing commenced on	:	Jan 07, 2014
Testing concluded on	:	Jan 15, 2014

2.2. Product Description

The **ITALCOM GROUP**'s Model: ZEUZ-HD or the "EUT" as referred to in this report; more general information as follows, for more details, refer to the user's manual of the EUT.

Name of EUT	mobile phone
Model Number	ZEUZ-HD
FCC ID	YPVITALCOMZEUZ-HD
Modulation Type	QPSK for WCDMA,GMSK for GSM/GPRS/EGPRS,8PSK only supported downlink
Antenna Type	Internal
Hardware version	MT6582_K28_ZeuzHD
Software version	ZEUZ_HD_AMXNYX_V001R
Android version	4.2.2
WLAN FCC Operation frequency	IEEE 802.11b: 2412MHz—2462MHz IEEE 802.11g: 2412MHz—2462MHz IEEE 802.11n HT20: 2412MHz—2462MHz IEEE 802.11n HT40: 2422MHz—2452MHz
Bluetooth FCC Operation frequency	2402MHz-2480MHz
WLAN Modulation	IEEE 802.11b: DSSS(CCK,DQPSK,DBPSK) IEEE 802.11g: OFDM(64QAM, 16QAM, QPSK, BPSK) IEEE 802.11n HT20: OFDM (64QAM, 16QAM, QPSK,BPSK) IEEE 802.11n HT40: OFDM (64QAM, 16QAM, QPSK,BPSK)
Bluetooth Modulation	GFSK,8PSK, π /4DQPSK
GSM/EDGE/GPRS	Supported GSM/GPRS/EDGE
WCDMA Operation Frequency Band	FDD Band II, FDD Band V
HSDPA Release Version	Release 8
HSUPA Release Version	Release 6
WCDMA Release Version	R99
Bluetooth	Supported BT v2.1+EDR and BT 4.0
Extreme temp. Tolerance	-30°C to +60°C
Extreme vol. Limits	3.40VDC to 4.20VDC (nominal: 3.70VDC)
GSM/GPRS Operation Frequency Band	GSM850/PCS1900
GSM Release Version	R99
GPRS operation mode	Class B
GPRS Multislot Class	12
EGPRS Multislot Class	12

2.3. Equipment under Test

Power supply system utilised

Power supply voltage	:	<input type="radio"/> 120V / 60 Hz	<input type="radio"/> 115V / 60Hz
		<input type="radio"/> 12 V DC	<input type="radio"/> 24 V DC
		<input checked="" type="radio"/> Other (specified in blank below)	

DC 3.70V/DC 5V From Adapter AC 120V/60Hz

Test frequency list

Modulation Type	Test Channel	Channel Number	Test Frequency
FDD Band II	Low	9262	1852.4 MHz
	Middle	9400	1880.0 MHz
	High	9538	1907.6 MHz
FDD Band V	Low	4132	826.40 MHz
	Middle	4182	836.60 MHz
	High	4233	846.60 MHz

2.4. Short description of the Equipment under Test (EUT)

The Equipment Under Test (EUT) is a model of mobile phone with

WCDMA/HSUPA/HSDPA/GPRS/GSM,WLAN and Bluetooth function and integrated antenna. Manual and specifications of the EUT were provided to fulfil the test.

Samples undergoing test were selected by the Client.

2.5. Internal Identification of EUT used during the test

SN or IMEI	HW Version	SW Version
403729161378583	8061-MB-V0.3	SKY_AMXNYX_V001R

2.6. Internal Identification of AE used during the test

AE ID*	Description
AE1	Battery
AE2	Charger and USB cable

AE1

Model:NYX1800A69X58
 Manufacturer: ITALCOM GROUP.
 Capacitance: 1800mAh
 Nominal Voltage:3.70V

AE2:

Model: ZEUZ-HD
 Manufacturer: ITALCOM GROUP.
 Input: 100-240V~50/60Hz 0.15A
 Output: OUTPUT: 5.0V DC 1.0A
 Power Cable Length: 90cm
 Shielded Unshielded

*AE ID: is used to identify the test sample in the lab internally.

2.7. Normal Accessory setting

Fully charged battery was used during the test.

2.8. EUT configuration

The following peripheral devices and interface cables were connected during the measurement:

● - supplied by the manufacturer

○ - supplied by the lab

<input type="radio"/>	Power Cable	Length (m) :	/
		Shield :	/
		Detachable :	/
<input type="radio"/>	Multimeter	Manufacturer :	/
		Model No. :	/

2.9. Related Submittal(s) / Grant (s)

This submittal(s) (test report) is intended for **FCC ID: YPVITALCOMZEUZ-HD** filing to comply with FCC Part 22 and Part 24 Rules

2.10. Modifications

No modifications were implemented to meet testing criteria.

2.11. Note

- The EUT is a mobile phone WCDMA/HSUPA/HSDPA/GPRS/GSM,WLAN and Bluetooth function,The functions of the EUT listed as below:

	Test Standards	Reference Report
GSM/GPRS/EGPRS	FCC Part 22/FCC Part 24	TRE1401002101
WCDMA/HSUPA/HSDPA	FCC Part 22/FCC Part 24	TRE1401002102
WLAN	FCC Part 15 C 15.247	TRE1401002103
Bluetooth v2.1+EDR	FCC Part 15 C 15.247	TRE1401002104
Bluetooth 4.0	FCC Part 15 C 15.247	TRE1401002105
USB Port	FCC Part 15 B	TRE1401002106
SAR	FCC Part 2 §2.1093	TRE1401002107

3. TEST ENVIRONMENT

3.1. Address of the test laboratory

Shenzhen Huatongwei International Inspection Co., Ltd
Keji Nan No.12 Road, Hi-tech Park, Shenzhen, China
Phone: 86-755-26715686 Fax: 86-755-26748089

The sites are constructed in conformance with the requirements of ANSI C63.7, ANSI C63.4 (2009) and CISPR Publication 22.

3.2. Test Facility

The test facility is recognized, certified, or accredited by the following organizations:

CNAS-Lab Code: L1225

Shenzhen Huatongwei International Inspection Co., Ltd has been assessed and proved to be in compliance with CNAS-CL01 Accreditation Criteria for Testing and Calibration Laboratories (identical to ISO/IEC 17025: 2005 General Requirements) for the Competence of Testing and Calibration Laboratories, Date of Registration: Mar 01, 2012. Valid time is until Feb 28, 2015.

A2LA-Lab Cert. No. 2243.01

Shenzhen Huatongwei International Inspection Co., Ltd, EMC Laboratory has been accredited by A2LA for technical competence in the field of electrical testing, and proved to be in compliance with ISO/IEC 17025: 2005 General Requirements for the Competence of Testing and Calibration Laboratories and any additional program requirements in the identified field of testing. Valid time is until Sept 30, 2015.

FCC-Registration No.: 662850

Shenzhen Huatongwei International Inspection Co., Ltd, EMC Laboratory has been registered and fully described in a report filed with the FCC (Federal Communications Commission). The acceptance letter from the FCC is maintained in our files. Registration 662850, Renewal date June 01, 2015.

IC-Registration No.: 5377

The 3m Alternate Test Site of Shenzhen Huatongwei International Inspection Co., Ltd has been registered by Certification and Engineering Bureau of Industry Canada for the performance of radiated measurements with Registration No. 5377 on Dec 31, 2013. Valid time is until Dec 31, 2016

ACA

Shenzhen Huatongwei International Inspection Co., Ltd, EMC Laboratory can also perform testing for the Australian C-Tick mark as a result of our A2LA accreditation.

VCCI

The 3m Semi-anechoic chamber (12.2m×7.95m×6.7m) and Shielded Room (8m×4m×3m) of Shenzhen Huatongwei International Inspection Co., Ltd has been registered in accordance with the Regulations for Voluntary Control Measures with Registration No.: R-2484. Date of Registration: December 20, 2013. Valid time is until December 19, 2016.

Main Ports Conducted Interference Measurement of Shenzhen Huatongwei International Inspection Co., Ltd has been registered in accordance with the Regulations for Voluntary Control Measures with Registration No.: C-2726. Date of Registration: December 20, 2013. Valid time is until December 19, 2016.

DNV

Shenzhen Huatongwei International Inspection Co Ltd has been found to comply with the requirements of DNV towards subcontractor of EMC and safety testing services in conjunction with the EMC and Low voltage Directives and in the voluntary field. The acceptance is based on a formal quality Audit and follow-ups according to relevant parts of ISO/IEC Guide 17025(2005), in accordance with the requirements of the DNV Laboratory Quality Manual towards subcontractors. Valid time is until Aug 24, 2016.

3.3. Environmental conditions

During the measurement the environmental conditions were within the listed ranges:

Temperature:	15-35 ° C
Humidity:	30-60 %
Atmospheric pressure:	950-1050mbar

3.4. Statement of the measurement uncertainty

The data and results referenced in this document are true and accurate. The reader is cautioned that there may be errors within the calibration limits of the equipment and facilities. The measurement uncertainty was calculated for all measurements listed in this test report acc. to CISPR 16 - 4 „Specification for radio disturbance and immunity measuring apparatus and methods – Part 4: Uncertainty in EMC Measurements“ and is documented in the Shenzhen Huatongwei International Inspection Co., Ltd quality system acc. to DIN EN ISO/IEC 17025. Furthermore, component and process variability of devices similar to that tested may result in additional deviation. The manufacturer has the sole responsibility of continued compliance of the device.

Hereafter the best measurement capability for Shenzhen Huatongwei laboratory is reported:

Test Items	Measurement Uncertainty	Notes
Frequency stability	25 Hz	(1)
Transmitter power conducted	0.57 dB	(1)
Transmitter power Radiated	2.20 dB	(1)
Conducted spurious emission 9KHz-12.75 GHz	1.60 dB	(1)
Conducted Emission 9KHz-30MHz	3.39 dB	(1)
Radiated Emission 30~1000MHz	4.24 dB	(1)
Radiated Emission 1~18GHz	5.16 dB	(1)
Radiated Emission 18-40GHz	5.54 dB	(1)
Occupied Bandwidth	-----	(1)
Emission Mask	-----	(1)
Modulation Characteristic	-----	(1)
Transmitter Frequency Behavior	-----	(1)

- (1) This uncertainty represents an expanded uncertainty expressed at approximately the 95% confidence level using a coverage factor of k=1.96.

3.5. Test Description

Test Items	Clause in FCC rules	Verdict
Conducted Emission	15.107/15.207	PASS
Output Power	22.913(a)/24.232(c)	PASS
Radiated Spurious Emission	2.1051/22.917/24.238	PASS
Frequency Stability	2.1055/24.235	PASS
Occupied Bandwidth	2.1049(h)(i)	PASS
Emission Bandwidth	22.917(b)/24.238(b)	PASS
Band Edge Compliance	22.917(b)/24.238(b)	PASS
Conducted Spurious Emission	2.1057/22.917/24.238	PASS

Remark:

1. The measurement uncertainty is not included in the test result.

3.6. Equipments Used during the Test

AC Power Conducted Emission					
No.	Equipment	Manufacturer	Model No.	Serial No.	Cal Due
1	Artificial Mains	Rohde&Schwarz	ESH2-Z5	100028	2014/10/25
2	EMI Test Receiver	Rohde&Schwarz	ESCS 30	100038	2014/10/25
3	Pulse Limiter	Rohde&Schwarz	ESHSZ2	100044	2014/10/25
4	EMI Test Software	Rohde&Schwarz	ES-K1 V1.71	N/A	N/A
5	UNIVERSAL RADIO COMMUNICATION	Rohde&Schwarz	CMU200	112012	2014/10/25

Output Power(Conducted) & Occupied Bandwidth & Emission Bandwidth & Band Edge Compliance & Conducted Spurious Emission					
No.	Equipment	Manufacturer	Model No.	Serial No.	Cal Due
1	UNIVERSAL RADIO COMMUNICATION	Rohde&Schwarz	CMU200	112012	2014/10/25
2	Spectrum Analyzer	Rohde&Schwarz	FSU26	201141	2014/10/25
3	Splitter	Mini-Circuit	ZAPD-4	400059	2014/10/25

Frequency Stability					
No.	Equipment	Manufacturer	Model No.	Serial No.	Cal Due
1	UNIVERSAL RADIO COMMUNICATION	Rohde&Schwarz	CMU200	112012	2014/10/25
2	Spectrum Analyzer	Rohde&Schwarz	FSU26	201141	2014/10/25
3	Climate Chamber	ESPEC	EL-10KA	05107008	2014/10/25
4	Splitter	Mini-Circuit	ZAPD-4	400059	2014/10/25

Output Power (Radiated) & Radiated Spurious Emission					
No.	Equipment	Manufacturer	Model No.	Serial No.	Cal Due
1	UNIVERSAL RADIO COMMUNICATION	Rohde&Schwarz	CMU200	112012	2014/10/25
2	Spectrum Analyzer	Rohde&Schwarz	FSU26	201141	2014/10/25
3	HORN ANTENNA	ShwarzBeck	9120D	1012	2014/10/25
4	HORN ANTENNA	ShwarzBeck	9120D	1011	2014/10/25
5	Ultra-Broadband Antenna	ShwarzBeck	VULB9163	538	2014/10/25
6	Ultra-Broadband Antenna	ShwarzBeck	VULB9163	539	2014/10/25
7	TURNTABLE	MATURO	TT2.0	----	N/A
8	ANTENNA MAST	MATURO	TAM-4.0-P	----	N/A
9	EMI Test Software	Audix	E3	N/A	N/A
10	EMI Test Receiver	Rohde&Schwarz	ESIB 26	100009	2014/10/25
11	RF Test Panel	Rohde&Schwarz	TS / RSP	335015/ 0017	N/A
12	High pass filter	Compliance Direction systems	BSU-6	34202	2014/10/25
13	Splitter	Mini-Circuit	ZAPD-4	400059	2014/10/25
14	Horn Antenna	SCHWARZBECK	BBHA9170	25841	2014/10/25
15	Horn Antenna	SCHWARZBECK	BBHA9170	25842	2014/10/25
16	Preamplifier	ShwarzBeck	BBV 9718	BBV 9718	2014/10/25
17	Broadband Preamplifier	ShwarzBeck	BBV743	9743-0079	2014/10/25
18	Signal Generator	Rohde&Schwarz	SMF100A	101932	2014/10/25
19	Amplifier	Compliance Direction systems	PAP1-4060	120	2014/10/25
20	TURNTABLE	ETS	2088	2149	N/A
21	ANTENNA MAST	ETS	2075	2346	N/A
22	HORN ANTENNA	Rohde&Schwarz	HF906	100068	2014/10/25
23	HORN ANTENNA	Rohde&Schwarz	HF906	100039	2014/10/25

The calibration interval was one year.

4. TEST CONDITIONS AND RESULTS

4.1. Conducted Emissions Test

TEST APPLICABLE

The EUT was tested according to ANSI C63.4 - 2009. The frequency spectrum from 0.15 MHz to 30 MHz was investigated. The LISN used was 50 ohm / 50 u Henry as specified by section 5.1 of ANSI C63.4 - 2009. Cables and peripherals were moved to find the maximum emission levels for each frequency.

TEST CONFIGURATION

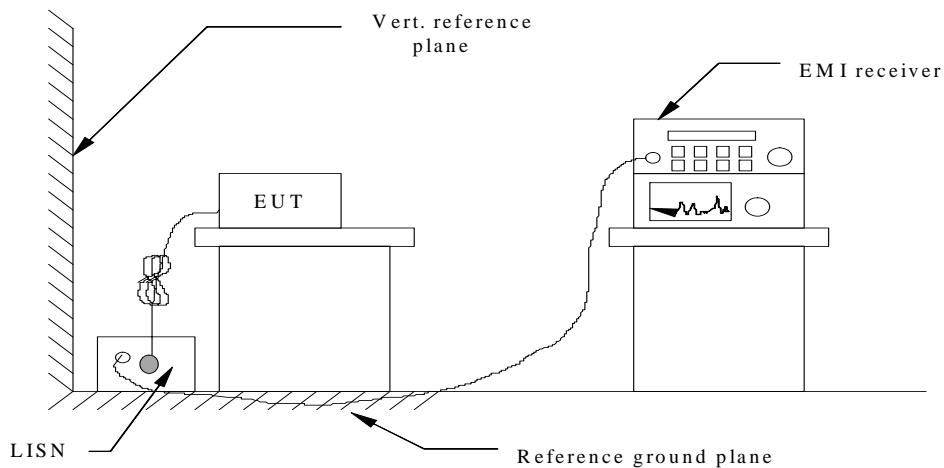

TEST PROCEDURE

1. The equipment was set up as per the test configuration to simulate typical actual usage per the user's manual. The EUT is a tabletop system; a wooden table with a height of 0.8 meters is used and is placed on the ground plane as per ANSI C63.4-2009.
2. Support equipment, if needed, was placed as per ANSI C63.4-2009.
3. All I/O cables were positioned to simulate typical actual usage as per ANSI C63.4-2009.
4. If EUT received DC power from the adapter, the adapter received AC120V/60Hz power through a Line Impedance Stabilization Network (LISN) which supplied power source and was grounded to the ground plane.
5. All support equipments received AC power from a second LISN, if any.
6. The EUT test program was started. Emissions were measured on each current carrying line of the EUT using a spectrum Analyzer / Receiver connected to the LISN powering the EUT. The LISN has two monitoring points: Line 1 (Hot Side) and Line 2 (Neutral Side). Two scans were taken: one with Line 1 connected to Analyzer / Receiver and Line 2 connected to a 50 ohm load; the second scan had Line 1 connected to a 50 ohm load and Line 2 connected to the Analyzer / Receiver.
7. Analyzer / Receiver scanned from 150 KHz to 30MHz for emissions in each of the test modes.
8. During the above scans, the emissions were maximized by cable manipulation.

Conducted Power Line Emission Limit

For unintentional device, according to § 15.107(a) Line Conducted Emission Limits is as following :

Frequency (MHz)	Maximum RF Line Voltage (dB μ V)			
	CLASS A		CLASS B	
	Q.P.	Ave.	Q.P.	Ave.
0.15 - 0.50	79	66	66-56*	56-46*
0.50 - 5.00	73	60	56	46
5.00 - 30.0	73	60	60	50

* Decreasing linearly with the logarithm of the frequency

For intentional device, according to §15.207(a) Line Conducted Emission Limit is same as above table.

TEST RESULTS

WCDMA Band II-AE2

SCAN TABLE: "Voltage (9K-30M)FIN"
 Short Description: 150K-30M Voltage

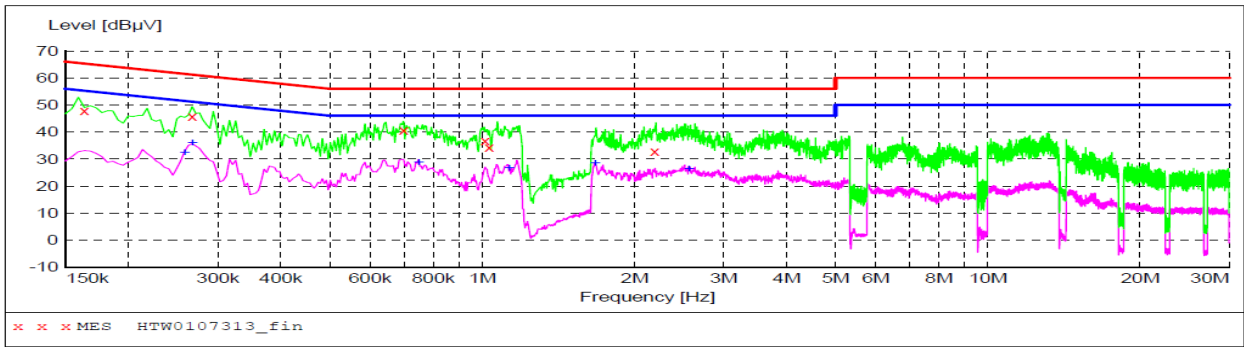

MEASUREMENT RESULT: "HTW0107313_fin"

1/7/2014 2:35PM

Frequency MHz	Level dBµV	Transd dB	Limit dBµV	Margin dB	Detector	Line	PE
0.163500	47.90	10.3	65	17.4	QP	N	GND
0.267000	45.80	10.6	61	15.4	QP	N	GND
0.699000	40.60	10.3	56	15.4	QP	N	GND
1.014000	36.70	10.3	56	19.3	QP	N	GND
1.032000	34.40	10.3	56	21.6	QP	N	GND
2.193000	32.90	10.3	56	23.1	QP	N	GND

MEASUREMENT RESULT: "HTW0107313_fin2"

1/7/2014 2:35PM

Frequency MHz	Level dBµV	Transd dB	Limit dBµV	Margin dB	Detector	Line	PE
0.258000	32.40	10.5	52	19.1	AV	N	GND
0.267000	35.90	10.6	51	15.3	AV	N	GND
0.748500	28.70	10.2	46	17.3	AV	N	GND
1.131000	26.50	10.3	46	19.5	AV	N	GND
1.671000	28.40	10.3	46	17.6	AV	N	GND
2.562000	26.10	10.3	46	19.9	AV	N	GND

SCAN TABLE: "Voltage (9K-30M)FIN"
 Short Description: 150K-30M Voltage

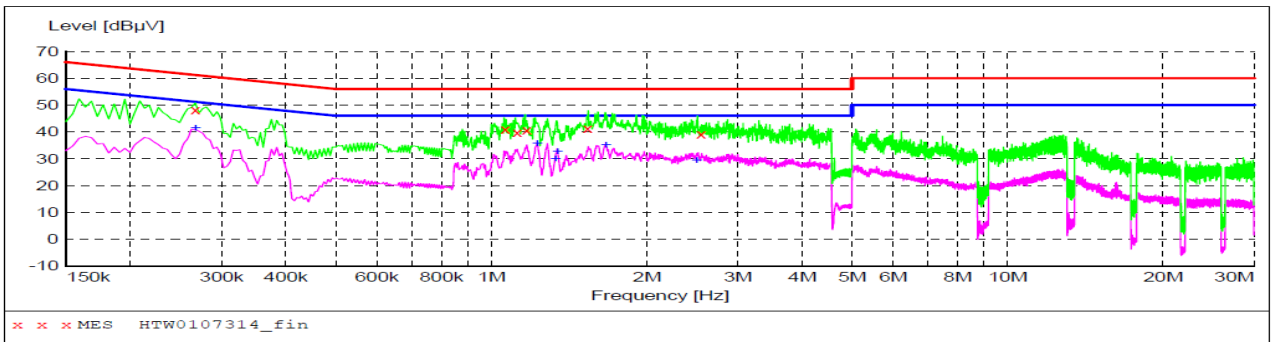

MEASUREMENT RESULT: "HTW0107314_fin"

1/7/2014 2:38PM

Frequency MHz	Level dBµV	Transd dB	Limit dBµV	Margin dB	Detector	Line	PE
0.267000	48.30	10.6	61	12.9	QP	L1	GND
1.063500	41.10	10.3	56	14.9	QP	L1	GND
1.122000	39.90	10.3	56	16.1	QP	L1	GND
1.171500	40.70	10.3	56	15.3	QP	L1	GND
1.536000	41.40	10.3	56	14.6	QP	L1	GND
2.548500	39.10	10.3	56	16.9	QP	L1	GND

MEASUREMENT RESULT: "HTW0107314_fin2"

1/7/2014 2:38PM

Frequency MHz	Level dBµV	Transd dB	Limit dBµV	Margin dB	Detector	Line	PE
0.267000	41.30	10.6	51	9.9	AV	L1	GND
1.225500	35.40	10.3	46	10.6	AV	L1	GND
1.329000	30.00	10.3	46	16.0	AV	L1	GND
1.342500	32.60	10.3	46	13.4	AV	L1	GND
1.666500	34.90	10.3	46	11.1	AV	L1	GND
2.499000	29.30	10.3	46	16.7	AV	L1	GND

WCDMA Band V-AE2

SCAN TABLE: "Voltage (9K-30M) FIN"
 Short Description: 150K-30M Voltage

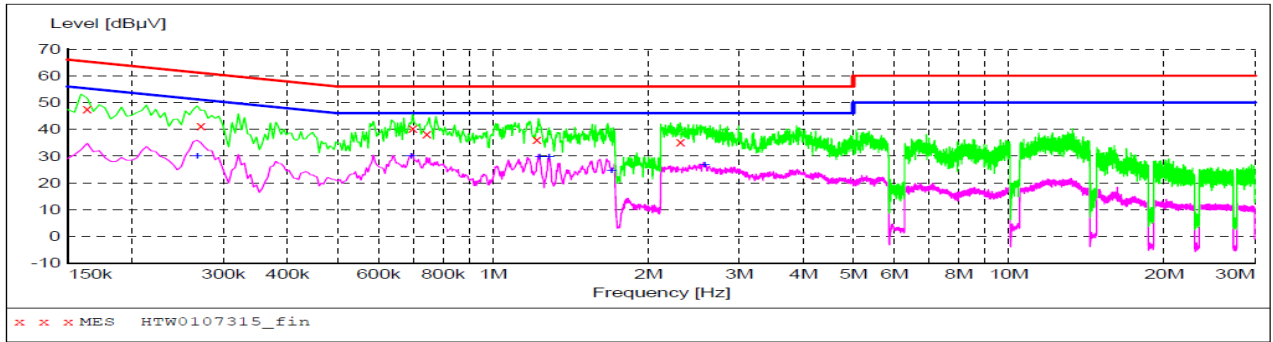

MEASUREMENT RESULT: "HTW0107315_fin"

1/7/2014 2:43PM

Frequency MHz	Level dBµV	Transd dB	Limit dBµV	Margin dB	Detector	Line	PE
0.163500	47.70	10.3	65	17.6	QP	N	GND
0.271500	41.30	10.6	61	19.8	QP	N	GND
0.699000	40.50	10.3	56	15.5	QP	N	GND
0.744000	38.30	10.2	56	17.7	QP	N	GND
1.216500	36.20	10.3	56	19.8	QP	N	GND
2.310000	35.30	10.3	56	20.7	QP	N	GND

MEASUREMENT RESULT: "HTW0107315_fin2"

1/7/2014 2:43PM

Frequency MHz	Level dBµV	Transd dB	Limit dBµV	Margin dB	Detector	Line	PE
0.267000	29.70	10.6	51	21.5	AV	N	GND
0.694500	29.90	10.3	46	16.1	AV	N	GND
1.230000	29.60	10.3	46	16.4	AV	N	GND
1.284000	29.40	10.3	46	16.6	AV	N	GND
1.698000	24.60	10.3	46	21.4	AV	N	GND
2.571000	26.50	10.3	46	19.5	AV	N	GND

SCAN TABLE: "Voltage (9K-30M) FIN"
 Short Description: 150K-30M Voltage

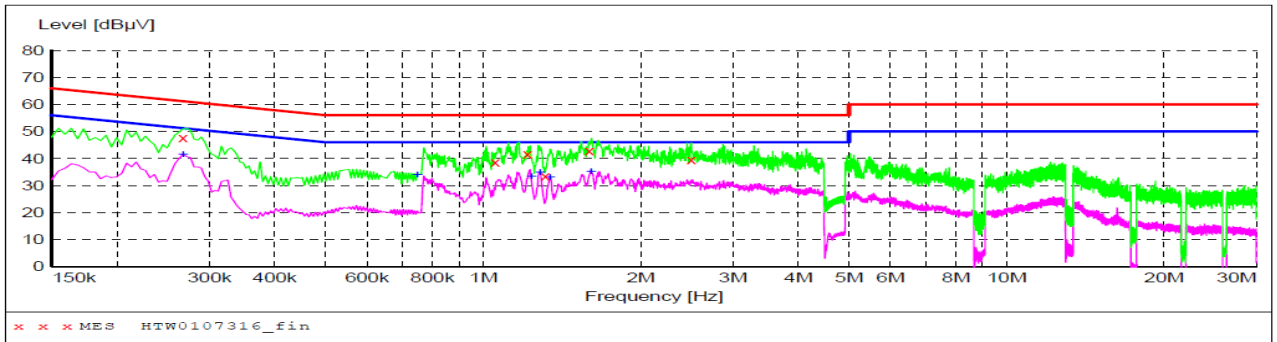

MEASUREMENT RESULT: "HTW0107316_fin"

1/7/2014 2:46PM

Frequency MHz	Level dBµV	Transd dB	Limit dBµV	Margin dB	Detector	Line	PE
0.267000	47.80	10.6	61	13.4	QP	L1	GND
1.054500	38.60	10.3	56	17.4	QP	L1	GND
1.216500	41.60	10.3	56	14.4	QP	L1	GND
1.315500	33.60	10.3	56	22.4	QP	L1	GND
1.594500	42.80	10.3	56	13.2	QP	L1	GND
2.499000	39.60	10.3	56	16.4	QP	L1	GND

MEASUREMENT RESULT: "HTW0107316_fin2"

1/7/2014 2:46PM

Frequency MHz	Level dBµV	Transd dB	Limit dBµV	Margin dB	Detector	Line	PE
0.267000	41.30	10.6	51	9.9	AV	L1	GND
0.748500	33.80	10.2	46	12.2	AV	L1	GND
1.234500	33.30	10.3	46	12.7	AV	L1	GND
1.284000	34.90	10.3	46	11.1	AV	L1	GND
1.342500	32.80	10.3	46	13.2	AV	L1	GND
1.608000	35.00	10.3	46	11.0	AV	L1	GND

MP3-AE2

SCAN TABLE: "Voltage (9K-30M) FIN"
 Short Description: 150K-30M Voltage

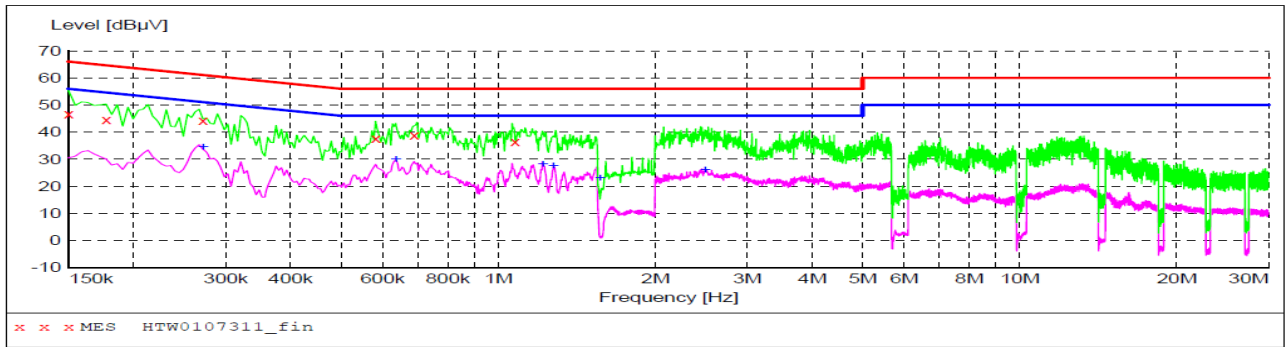

MEASUREMENT RESULT: "HTW0107311_fin"

1/7/2014 2:29PM

Frequency MHz	Level dBµV	Transd dB	Limit dBµV	Margin dB	Detector	Line	PE
0.150000	46.60	10.3	66	19.4	QP	N	GND
0.177000	44.70	10.3	65	19.9	QP	N	GND
0.271500	44.40	10.6	61	16.7	QP	N	GND
0.582000	37.80	10.3	56	18.2	QP	N	GND
0.690000	38.90	10.3	56	17.1	QP	N	GND
1.077000	36.40	10.3	56	19.6	QP	N	GND

MEASUREMENT RESULT: "HTW0107311_fin2"

1/7/2014 2:29PM

Frequency MHz	Level dBµV	Transd dB	Limit dBµV	Margin dB	Detector	Line	PE
0.271500	34.40	10.6	51	16.7	AV	N	GND
0.636000	29.80	10.3	46	16.2	AV	N	GND
1.216500	28.20	10.3	46	17.8	AV	N	GND
1.275000	27.40	10.3	46	18.6	AV	N	GND
1.567500	23.00	10.3	46	23.0	AV	N	GND
2.494500	25.80	10.3	46	20.2	AV	N	GND

SCAN TABLE: "Voltage (9K-30M) FIN"
 Short Description: 150K-30M Voltage

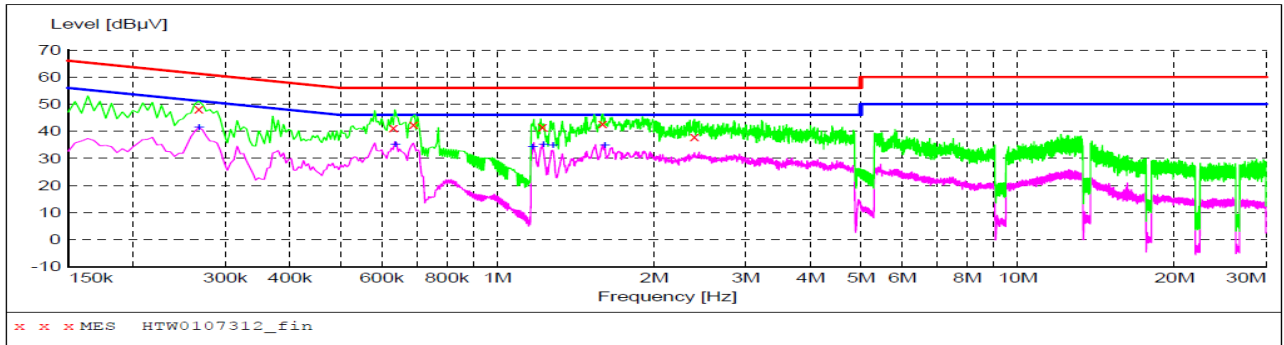

MEASUREMENT RESULT: "HTW0107312_fin"

1/7/2014 2:32PM

Frequency MHz	Level dBµV	Transd dB	Limit dBµV	Margin dB	Detector	Line	PE
0.267000	48.20	10.6	61	13.0	QP	L1	GND
0.631500	41.30	10.3	56	14.7	QP	L1	GND
0.690000	42.60	10.3	56	13.4	QP	L1	GND
1.221000	41.50	10.3	56	14.5	QP	L1	GND
1.594500	42.70	10.3	56	13.3	QP	L1	GND
2.395500	38.00	10.3	56	18.0	QP	L1	GND

MEASUREMENT RESULT: "HTW0107312_fin2"

1/7/2014 2:32PM

Frequency MHz	Level dBµV	Transd dB	Limit dBµV	Margin dB	Detector	Line	PE
0.267000	41.40	10.6	51	9.8	AV	L1	GND
0.636000	35.00	10.3	46	11.0	AV	L1	GND
1.167000	34.20	10.3	46	11.8	AV	L1	GND
1.225500	34.90	10.3	46	11.1	AV	L1	GND
1.279500	34.70	10.3	46	11.3	AV	L1	GND
1.608000	34.80	10.3	46	11.2	AV	L1	GND

CAMERA-AE2

SCAN TABLE: "Voltage (9K-30M)FIN"
 Short Description: 150K-30M Voltage

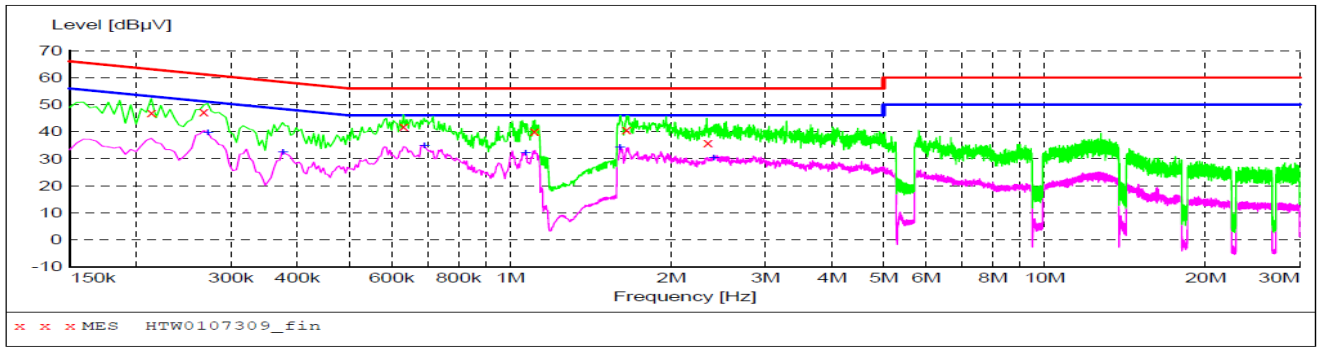

MEASUREMENT RESULT: "HTW0107309_fin"

1/7/2014 2:22PM

Frequency MHz	Level dBµV	Transd dB	Limit dBµV	Margin dB	Detector	Line	PE
0.213000	47.10	10.4	63	16.0	QP	L1	GND
0.267000	47.20	10.6	61	14.0	QP	L1	GND
0.631500	41.80	10.3	56	14.2	QP	L1	GND
1.108500	40.20	10.3	56	15.8	QP	L1	GND
1.648500	40.80	10.3	56	15.2	QP	L1	GND
2.341500	36.00	10.3	56	20.0	QP	L1	GND

MEASUREMENT RESULT: "HTW0107309_fin2"

1/7/2014 2:22PM

Frequency MHz	Level dBµV	Transd dB	Limit dBµV	Margin dB	Detector	Line	PE
0.271500	39.50	10.6	51	11.6	AV	L1	GND
0.375000	32.20	10.5	48	16.2	AV	L1	GND
0.690000	34.60	10.3	46	11.4	AV	L1	GND
1.068000	31.90	10.3	46	14.1	AV	L1	GND
1.603500	34.00	10.3	46	12.0	AV	L1	GND
2.400000	30.10	10.3	46	15.9	AV	L1	GND

SCAN TABLE: "Voltage (9K-30M)FIN"
 Short Description: 150K-30M Voltage

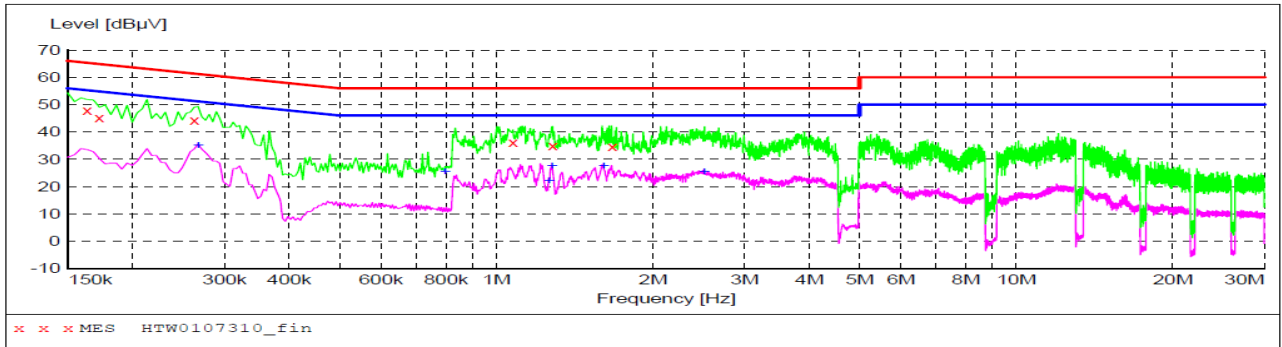

MEASUREMENT RESULT: "HTW0107310_fin"

1/7/2014 2:25PM

Frequency MHz	Level dBµV	Transd dB	Limit dBµV	Margin dB	Detector	Line	PE
0.163500	47.80	10.3	65	17.5	QP	N	GND
0.172500	45.30	10.3	65	19.5	QP	N	GND
0.262500	44.30	10.6	61	17.1	QP	N	GND
1.077000	36.10	10.3	56	19.9	QP	N	GND
1.284000	35.10	10.3	56	20.9	QP	N	GND
1.671000	34.70	10.3	56	21.3	QP	N	GND

MEASUREMENT RESULT: "HTW0107310_fin2"

1/7/2014 2:25PM

Frequency MHz	Level dBµV	Transd dB	Limit dBµV	Margin dB	Detector	Line	PE
0.267000	35.00	10.6	51	16.2	AV	N	GND
0.798000	25.20	10.2	46	20.8	AV	N	GND
1.261500	21.90	10.3	46	24.1	AV	N	GND
1.279500	27.30	10.3	46	18.7	AV	N	GND
1.608000	27.30	10.3	46	18.7	AV	N	GND
2.512500	25.30	10.3	46	20.7	AV	N	GND

4.2. OUTPUT POWER

TEST APPLICABLE

During the process of testing, the EUT was controlled via Rhode & Schwarz Digital Radio Communication tester (CMU-200) to ensure max power transmission and proper modulation. This result contains output power and EIRP measurements for the EUT. In all cases, output power is within the specified limits.

4.2.1. Conducted Output Power

TEST CONFIGURATION

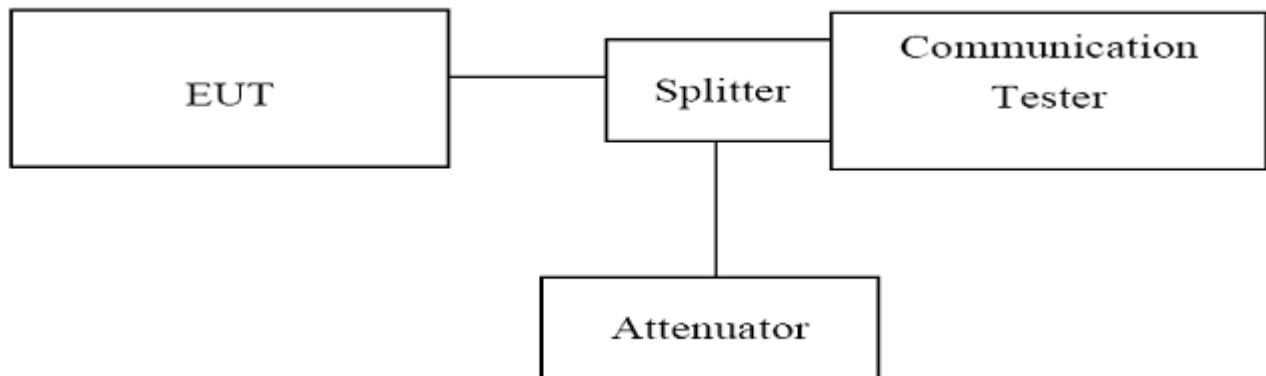

TEST PROCEDURE

1. The EUT was set up for the max output power with pseudo random data modulation.
2. The power was measured with Rhode & Schwarz Spectrum Analyzer FSU (peak)
3. These measurements were done at 3 frequencies, 1850.20 MHz, 1880.00 MHz and 1907.60 MHz for WCDMA band II; 826.40 MHz, 836.60 MHz and 846.60 MHz for WCDMA band V. (low, middle and high of operational frequency range).

TEST CONDITION

RBW	VBW	Sweep Time	Span
10MHz	10MHz	800ms	50MHz

TEST RESULTS

WCDMA V		
Channel	Frequency (MHz)	Output Power(dBm)
4132	826.40	23.46
4183	836.60	23.20
4233	846.60	23.12

WCDMA II		
Channel	Frequency (MHz)	Output Power(dBm)
9262	1852.40	23.32
9400	1880.00	23.78
9538	1907.60	23.19

4.2.2. Radiated Output Power

TEST DESCRIPTION

This is the test for the maximum radiated power from the EUT.

Rule Part 24.232(c) specifies, "Mobile/portable stations are limited to 2 watts e.i.r.p. Peak power" and 24.232(e) specifies that "Peak transmit power must be measured over any interval of continuous transmission using instrumentation calibrated in terms of an rms-equivalent voltage." Rule Part 22.913(a) specifies "The ERP of mobile transmitters and auxiliary test transmitters must not exceed 7 Watts." and Rule Part 27.50(d)(2) specifies, "Fixed, mobile, and portable (handheld) stations operating in the 1710–1755 MHz band are limited to a peak EIRP of 1 watt."

TEST CONFIGURATION

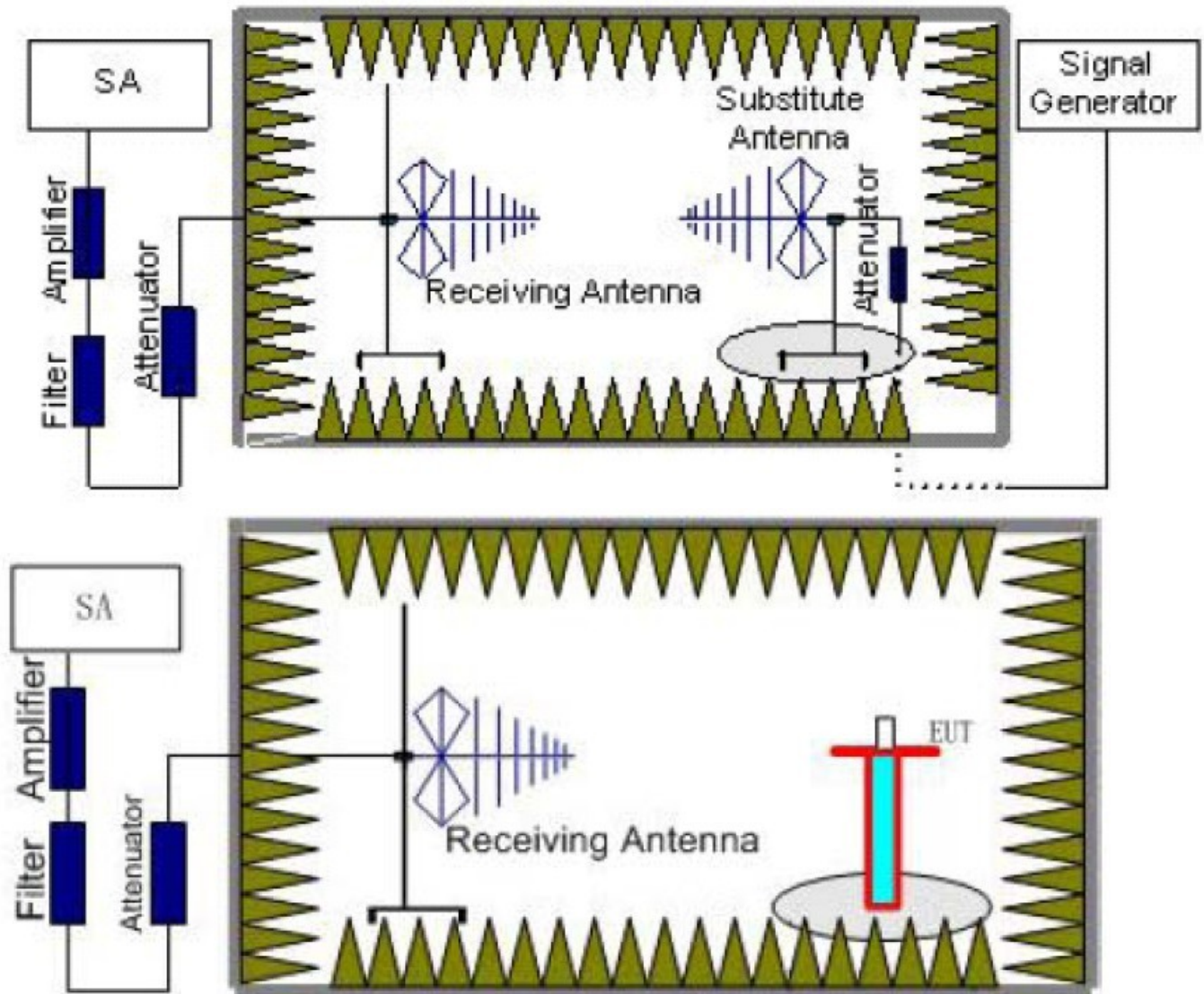

TEST PROCEDURE

1. EUT was placed on a 0.80 meter high non-conductive stand at a 3 meter test distance from the receive antenna. A receiving antenna was placed on the antenna mast 3 meters from the EUT for emission measurements. The height of receiving antenna is 0.80m. Detected emissions were maximized at each frequency by rotating the EUT through 360° and adjusting the receiving antenna polarization. The radiated emission measurements of all transmit frequencies in three channels (High, Middle, Low) were measured with peak detector.
2. A log-periodic antenna or double-ridged waveguide horn antenna shall be substituted in place of the EUT. The log-periodic antenna will be driven by a signal generator and the level will be adjusted till the same power value on the spectrum analyzer or receiver. The level of the spurious emissions can be calculated through the level of the signal generator, cable loss, the gain of the substitution antenna and the reading of the spectrum analyzer or receiver.

3. The EUT is then put into continuously transmitting mode at its maximum power level during the test. Set Test Receiver or Spectrum RBW=10MHz, VBW=10MHz, And the maximum value of the receiver should be recorded as (P_r).
4. The EUT shall be replaced by a substitution antenna. In the chamber, an substitution antenna for the frequency band of interest is placed at the reference point of the chamber. An RF Signal source for the frequency band of interest is connected to the substitution antenna with a cable that has been constructed to not interfere with the radiation pattern of the antenna. A power (P_{Mea}) is applied to the input of the substitution antenna, and adjust the level of the signal generator output until the value of the receiver reach the previously recorded (P_r). The power of signal source (P_{Mea}) is recorded. The test should be performed by rotating the test item and adjusting the receiving antenna polarization.
5. A amplifier should be connected to the Signal Source output port. And the cable should be connect between the Amplifier and the Substitution Antenna. The cable loss (P_{cl}), the Substitution Antenna Gain (G_a) and the Amplifier Gain (P_{Ag}) should be recorded after test.
The measurement results are obtained as described below:
Power(EIRP)= $P_{Mea} - P_{Ag} - P_{cl} - G_a$
We used SMF100A microwave signal generator which signal level can up to 33dBm, so we not used power Amplifier for substitution test; The measurement results are amend as described below:
Power(EIRP)= $P_{Mea} - P_{cl} - G_a$
6. This value is EIRP since the measurement is calibrated using an antenna of known gain (2.15 dBi) and known input power.
7. ERP can be calculated from EIRP by subtracting the gain of the dipole, ERP = EIRP-2.15dBi.

TEST LIMIT

According to 22.913(a) and 24.232(c), the ERP should be not exceed following table limits:

	Burst Peak EIRP
WCDMA Band II	33dBm (2W)
	Burst Peak ERP
WCDMA Band V	38.45dBm (7W)

TEST RESULTS

WCDMA Band II						
Frequency (MHz)	P_{Mea} (dBm)	P_{cl} (dB)	G_a Antenna Gain (dB)	Correction (dB)	EIRP (dBm)	Polarization
1852.4	17.63	3.52	8.35	2.15	22.46	H
1880.0	18.36	3.61	8.29	2.15	23.04	H
1907.6	17.51	3.67	8.37	2.15	22.21	H
1852.4	17.63	3.52	8.35	2.15	22.46	V
1880.0	18.35	3.61	8.29	2.15	23.03	V
1907.6	17.57	3.67	8.37	2.15	22.27	V

WCDMA Band V						
Frequency (MHz)	P_{Mea} (dBm)	P_{cl} (dB)	G_a Antenna Gain (dB)	Correction (dB)	ERP (dBm)	Polarization
826.40	16.81	1.56	8.45	2.15	21.55	H
836.60	16.51	1.50	8.45	2.15	21.31	H
846.60	16.42	1.67	8.39	2.15	20.99	H
826.40	16.71	1.56	8.45	2.15	21.45	V
836.60	16.50	1.50	8.45	2.15	21.30	V
846.60	16.48	1.67	8.39	2.15	21.05	V

4.3. Radiated Spurious Emission

TEST APPLICABLE

According to the TIA/EIA 603D:2010 test method, The Receiver or Spectrum was scanned from 30 MHz to the 10th harmonic of the highest frequency generated within the equipment, which is the transmitted carrier that can be as high as 1910 MHz. The resolution bandwidth is set as outlined in Part 24.238 and Part 22.917. The spectrum is scanned with the mobile station transmitting at carrier frequencies that pertain to low, mid and high channels of WCDMA Band II and WCDMA Band V.

TEST CONFIGURATION

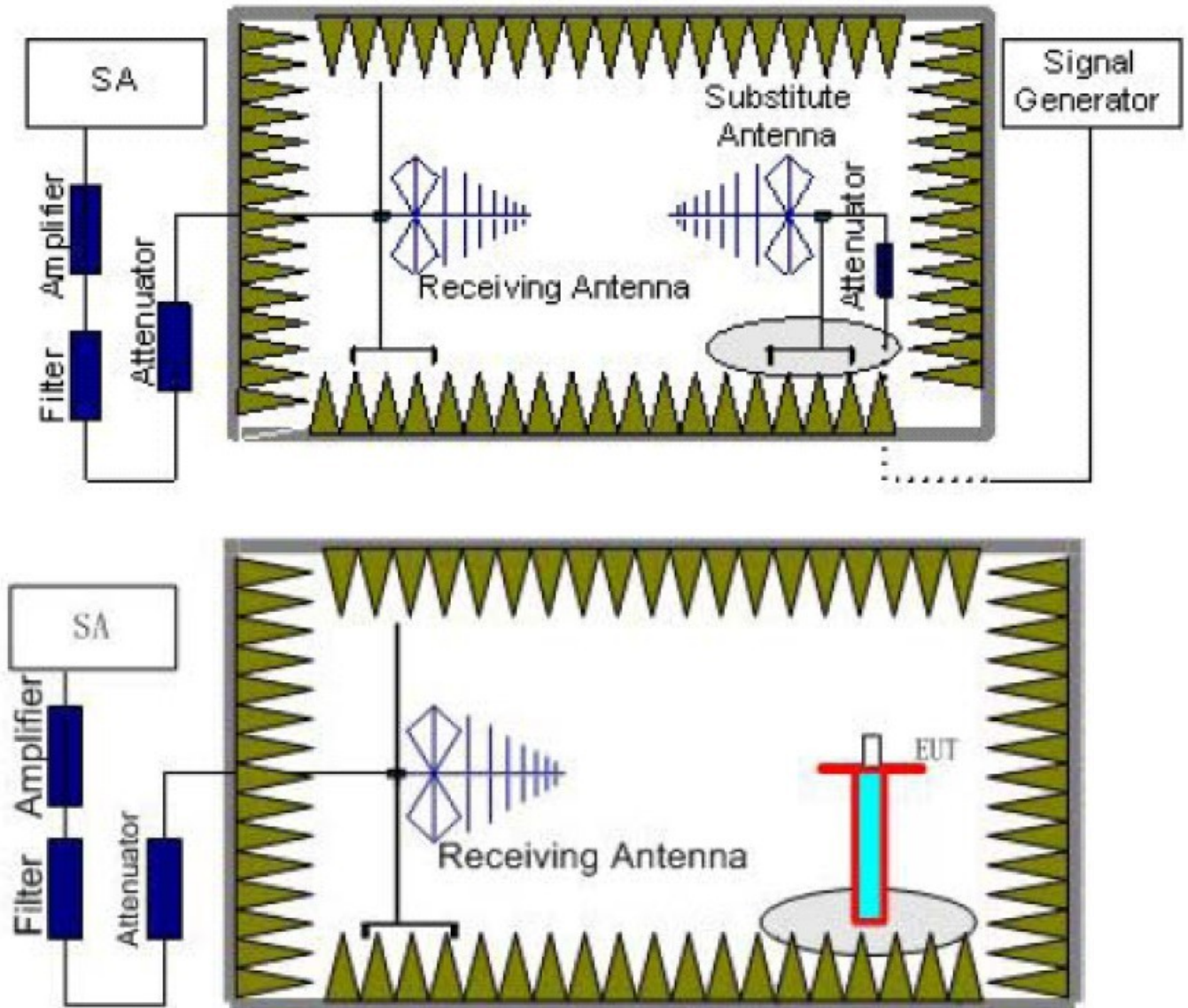

TEST PROCEDURE

1. EUT was placed on a 0.80 meter high non-conductive stand at a 3 meter test distance from the receive antenna. A receiving antenna was placed on the antenna mast 3 meters from the EUT for emission measurements. The height of receiving antenna is 0.80m. Detected emissions were maximized at each frequency by rotating the EUT through 360° and adjusting the receiving antenna polarization. The radiated emission measurements of all transmit frequencies in three channels (High, Middle, Low) were measured with peak detector.
2. A log-periodic antenna or double-ridged waveguide horn antenna shall be substituted in place of the EUT. The log-periodic antenna will be driven by a signal generator and the level will be adjusted till the same power value on the spectrum analyzer or receiver. The level of the spurious emissions can be calculated through the level of the signal generator, cable loss, the gain of the substitution antenna and the reading of the spectrum analyzer or receiver.

3. The EUT is then put into continuously transmitting mode at its maximum power level during the test. Set Test Receiver or Spectrum RBW=1MHz, VBW=3MHz, And the maximum value of the receiver should be recorded as (P_r).
4. The EUT shall be replaced by a substitution antenna. In the chamber, an substitution antenna for the frequency band of interest is placed at the reference point of the chamber. An RF Signal source for the frequency band of interest is connected to the substitution antenna with a cable that has been constructed to not interfere with the radiation pattern of the antenna. A power (P_{Mea}) is applied to the input of the substitution antenna, and adjust the level of the signal generator output until the value of the receiver reach the previously recorded (P_r). The power of signal source (P_{Mea}) is recorded. The test should be performed by rotating the test item and adjusting the receiving antenna polarization.
5. A amplifier should be connected to the Signal Source output port. And the cable should be connect between the Amplifier and the Substitution Antenna. The cable loss (P_{cl}), the Substitution Antenna Gain (G_a) and the Amplifier Gain (P_{Ag}) should be recorded after test. The measurement results are obtained as described below:
Power(EIRP)= $P_{Mea} - P_{Ag} - P_{cl} + G_a$
6. This value is EIRP since the measurement is calibrated using an antenna of known gain (2.15 dBi) and known input power.
7. ERP can be calculated from EIRP by subtracting the gain of the dipole, ERP = EIRP -2.15dBi.
8. In order to make sure test results more clearly, we set frequency range and sweep time for difference frequency range as follows table:

Working Frequency	Subrange (GHz)	RBW	VBW	Sweep time (s)
850MHz	0.03~1	100KHz	300KHz	10
	1-2	1 MHz	3 MHz	2
	2~5	1 MHz	3 MHz	3
	5~8	1 MHz	3 MHz	3
	8~10	1 MHz	3 MHz	3
94000MHz	0.03~1	100KHz	300KHz	10
	1-2	1 MHz	3 MHz	2
	2~5	1 MHz	3 MHz	3
	5~8	1 MHz	3 MHz	3
	8~11	1 MHz	3 MHz	3
	11~14	1 MHz	3 MHz	3
	14~18	1 MHz	3 MHz	3
18~20	1 MHz	3 MHz	2	

TEST LIMITS

According to 24.238 and 22.917 specify that the power of any emission outside of the authorized operating frequency ranges must be attenuated below the transmitting power (P) by a factor of at least $43 + 10 \log(P)$ dB.

The specification that emissions shall be attenuated below the transmitter power (P) by at least $43 + 10 \log(P)$ dB, translates in the relevant power range (1 to 0.001 W) to -13 dBm. At 1 W the specified minimum attenuation becomes 43 dB and relative to a 30 dBm (1 W) carrier becomes a limit of -13 dBm. At 0.001 W (0 dBm) the minimum attenuation is 13 dB, which again yields a limit of -13 dBm. In this way a translation of the specification from relative to absolute terms is carried out.

Frequency	Channel	Frequency Range	Verdict
GSM 850MHz	Low	30MHz-10GHz	PASS
	Middle	30MHz-10GHz	PASS
	High	30MHz-10GHz	PASS
GSM 94000MHz	Low	30MHz-20GHz	PASS
	Middle	30MHz-20GHz	PASS
	High	30MHz-20GHz	PASS

WCDMA Band II							
Channel Number: 9262				Test Frequency: 1852.40 MHz			
Frequency (MHz)	P _{Mea} (dBm)	Path Loss	Antenna Gain	Correction (dB)	Peak ERP(dBm)	Limit (dBm)	Polarization
3704.80	-33.87	4.55	12.34	2.15	-28.23	-13.00	H
5557.20	-30.39	5.05	13.53	2.15	-24.06	-13.00	H
7409.60	-31.66	4.64	11.60	2.15	-26.85	-13.00	H
3704.80	-30.35	4.55	12.34	2.15	-24.71	-13.00	V
5557.20	-27.76	5.05	13.53	2.15	-21.43	-13.00	V
7409.60	-28.38	4.64	11.60	2.15	-23.57	-13.00	V

WCDMA Band II							
Channel Number: 9400				Test Frequency: 1880.00 MHz			
Frequency (MHz)	P _{Mea} (dBm)	Path Loss	Antenna Gain	Correction (dB)	Peak ERP(dBm)	Limit (dBm)	Polarization
3760.00	-34.36	4.55	12.40	2.15	-28.66	-13.00	H
5640.00	-31.28	4.96	13.60	2.15	-24.79	-13.00	H
7520.00	-31.19	4.71	11.89	2.15	-26.16	-13.00	H
3760.00	-30.40	4.55	12.40	2.15	-24.70	-13.00	V
5640.00	-28.05	4.96	13.60	2.15	-21.56	-13.00	V
7520.00	-28.23	4.71	11.89	2.15	-23.20	-13.00	V

WCDMA Band II							
Channel Number: 9538				Test Frequency: 1907.60 MHz			
Frequency (MHz)	P _{Mea} (dBm)	Path Loss	Antenna Gain	Correction (dB)	Peak ERP(dBm)	Limit (dBm)	Polarization
3815.20	-32.16	4.51	12.43	2.15	-26.39	-13.00	H
5722.80	-29.60	4.90	13.61	2.15	-23.04	-13.00	H
7630.40	-29.60	4.78	12.00	2.15	-24.53	-13.00	H
3815.20	-28.45	4.51	12.43	2.15	-22.68	-13.00	V
5722.80	-27.20	4.90	13.61	2.15	-20.64	-13.00	V
7630.40	-26.87	4.78	12.00	2.15	-21.80	-13.00	V

WCDMA Band V							
Channel Number: 4132				Test Frequency: 826.40 MHz			
Frequency (MHz)	P _{Mea} (dBm)	Path Loss	Antenna Gain	Correction (dB)	Peak ERP(dBm)	Limit (dBm)	Polarization
2479.20	-25.44	4.32	6.77	2.15	-25.14	-13.00	H
3305.60	-28.61	4.55	12.25	2.15	-23.06	-13.00	H
4958.40	-31.37	4.70	12.92	2.15	-25.30	-13.00	H
2479.20	-23.79	4.32	6.77	2.15	-23.49	-13.00	V
3305.60	-26.68	4.55	12.25	2.15	-21.13	-13.00	V
4958.40	-29.37	4.59	12.76	2.15	-23.35	-13.00	V

WCDMA Band V							
Channel Number: 4183				Test Frequency: 836.60 MHz			
Frequency (MHz)	P _{Mea} (dBm)	Path Loss	Antenna Gain	Correction (dB)	Peak ERP(dBm)	Limit (dBm)	Polarization
3342.30	-32.98	4.55	12.25	2.15	-27.43	-13.00	H
4183.00	-30.38	4.59	12.76	2.15	-24.36	-13.00	H
5014.44	-31.35	4.78	12.88	2.15	-25.40	-13.00	H
3342.30	-29.56	4.55	12.25	2.15	-24.01	-13.00	V
4183.00	-27.66	4.59	12.76	2.15	-21.64	-13.00	V
5014.44	-28.06	4.78	12.88	2.15	-22.11	-13.00	V

WCDMA Band V							
Channel Number: 4233				Test Frequency: 846.60 MHz			
Frequency (MHz)	P _{Mea} (dBm)	Path Loss	Antenna Gain	Correction (dB)	Peak ERP(dBm)	Limit (dBm)	Polarization
2539.80	-28.49	4.29	6.83	2.15	-28.10	-13.00	H
3394.40	-31.35	4.58	12.59	2.15	-25.49	-13.00	H
4233.00	-32.85	4.59	12.76	2.15	-26.83	-13.00	H
2539.80	-25.81	4.29	6.83	2.15	-25.42	-13.00	V
3394.40	-28.52	4.58	12.59	2.15	-22.66	-13.00	V
4233.00	-31.03	4.59	12.76	2.15	-25.01	-13.00	V

Note: 1. In general, the worse case attenuation requirement shown above was applied.

3. *** means that the emission level is too low to be measured or at least 20 dB down than the limit.

4.4. OCCUPIED BANDWIDTH

TEST APPLICABLE

Similar to conducted emissions; occupied bandwidth measurements are only provided for selected frequencies in order to reduce the amount of submitted data. Data were taken at the extreme and mid frequencies of WCDMA Band II and WCDMA band V. The table below lists the measured 99% BW.

TEST CONFIGURATION

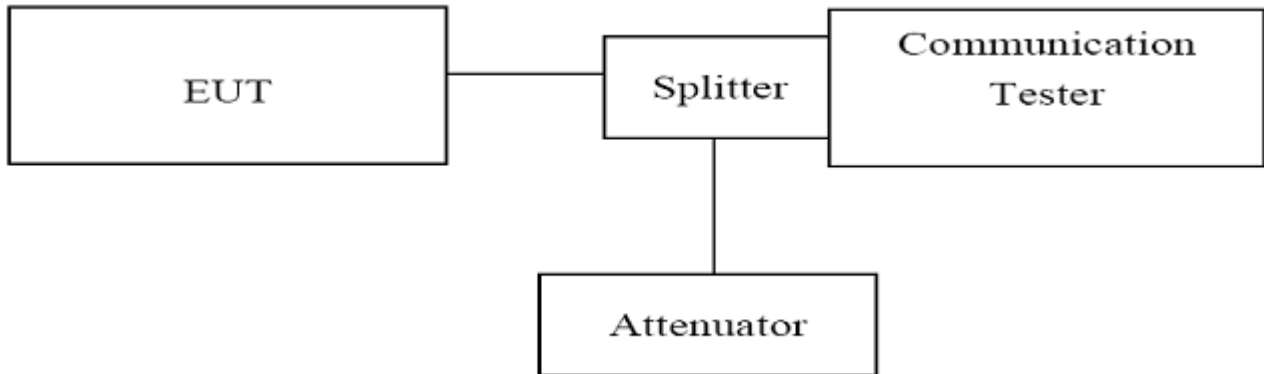

TEST PROCEDURE

1. The EUT was set up for the max output power with pseudo random data modulation;
2. The Occupied bandwidth was measured with Rhode & Schwarz Spectrum Analyzer FSU (peak);
3. Set RBW=5KHz,VBW=50KHz,Span=500KHz,SWT=20ms;
4. Set SPA Max hold. Mark peak, Set 99% Occupied Bandwidth
5. These measurements were done at 3 frequencies, 1850.20 MHz, 1880.00 MHz and 1709.80 MHz for WCDMA band II; 826.40 MHz, 836.60 MHz and 846.60 MHz for WCDMA band V. (low, middle and high of operational frequency range).

TEST RESULTS

WCDMA Band II				
Channel Number	Frequency (MHz)	Occupied Bandwidth (99% BW) (kHz)	Refer to Plot	Verdict
9262	1852.4	4246.79	Plot 4.4.1 A	PASS
9400	1880.0	4166.67	Plot 4.4.1 B	PASS
9538	1907.6	4182.69	Plot 4.4.1 C	PASS

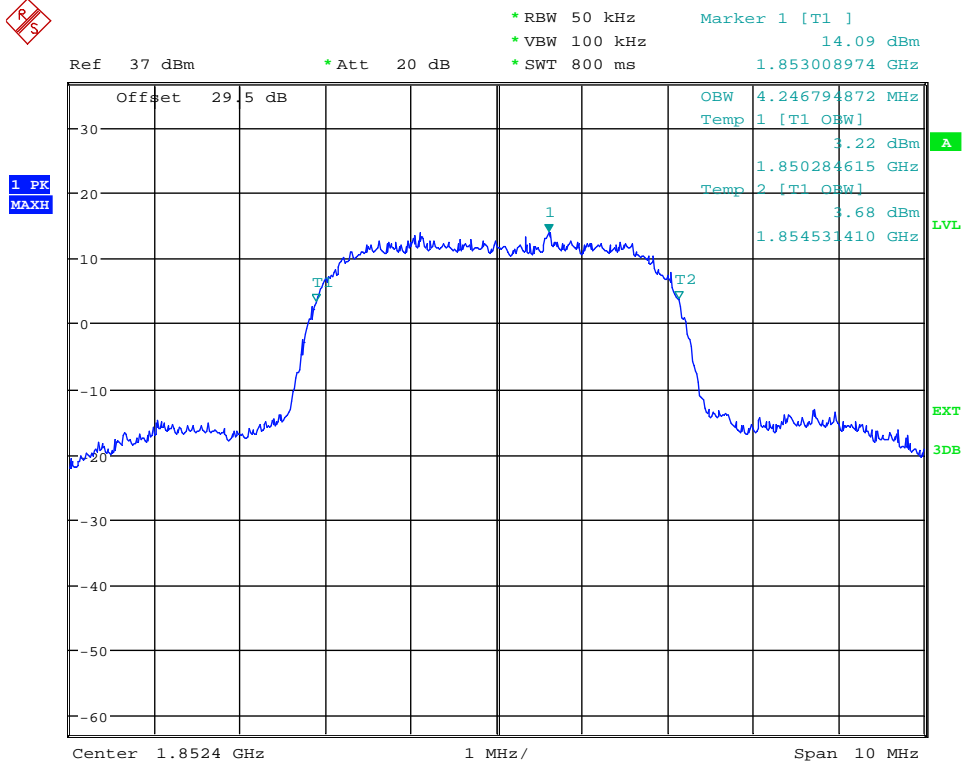

Date: 8.JAN.2014 13:27:42

(Plot 4.4.1 A: Channel 9262: 1852.4MHz WCDMA Band II)

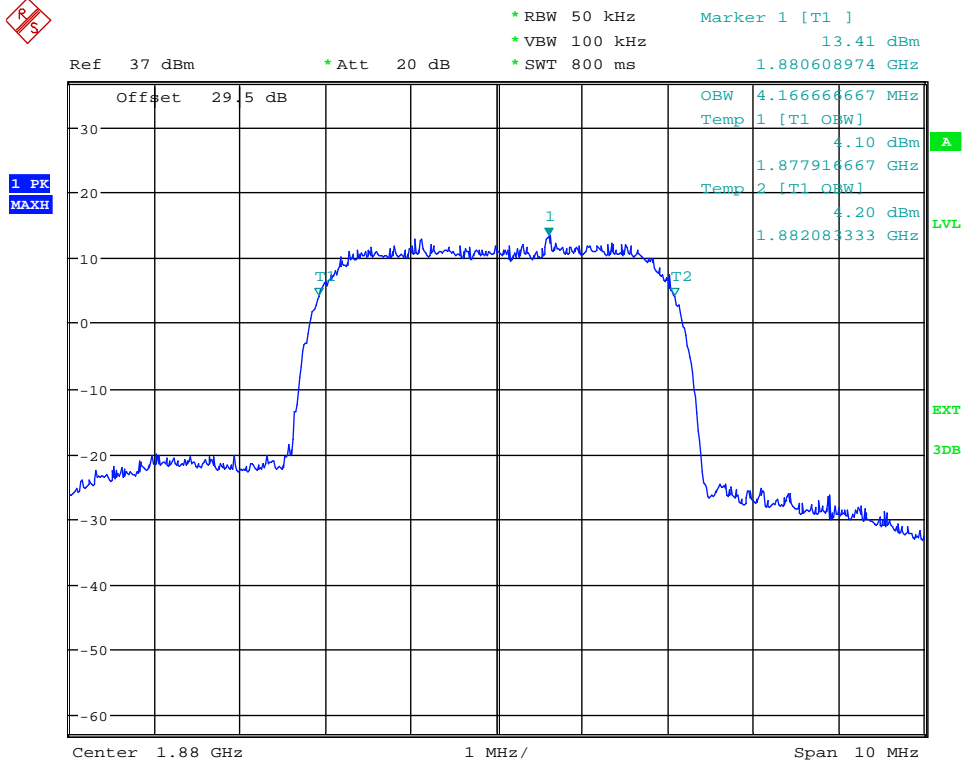

Date: 8.JAN.2014 13:28:37

(Plot 4.4.1 B: Channel 9400: 1880.0MHz WCDMA Band II)

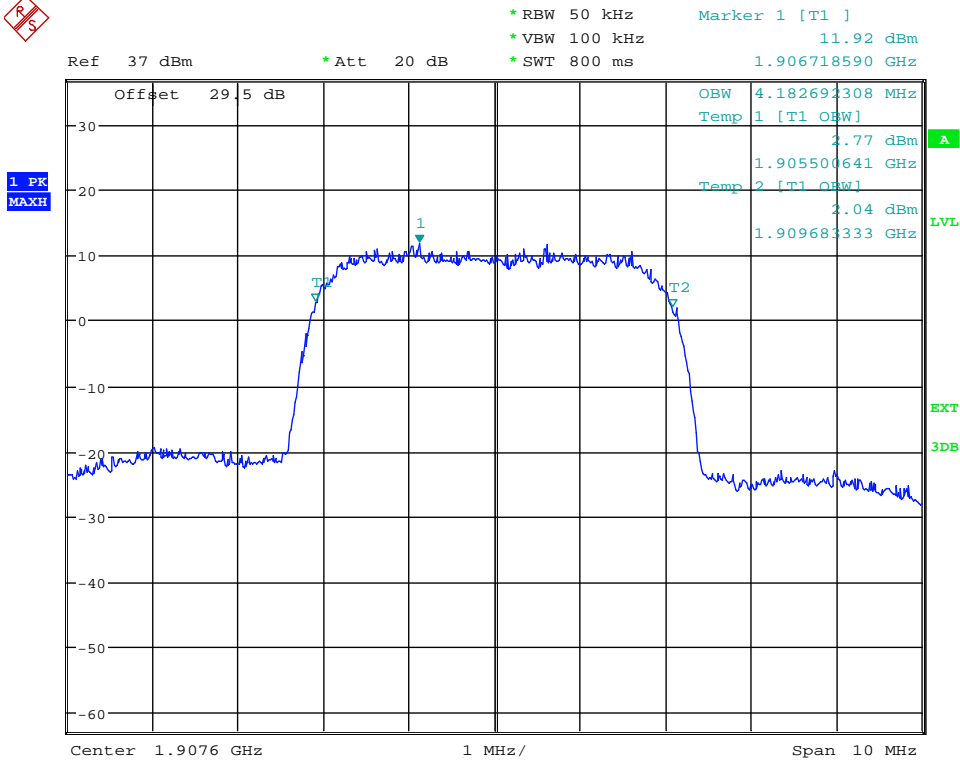

Date: 8.JAN.2014 13:29:11

(Plot 4.4.1 C: Channel 9538: 1907.6MHz WCDMA Band II)

WCDMA Band V				
Channel Number	Frequency (MHz)	Occupied Bandwidth (99% BW) (kHz)	Refer to Plot	Verdict
4132	826.4	4166.67	Plot 4.4.2 A	PASS
4183	836.6	4166.67	Plot 4.4.2 B	PASS
4233	846.6	4246.79	Plot 4.4.2 C	PASS

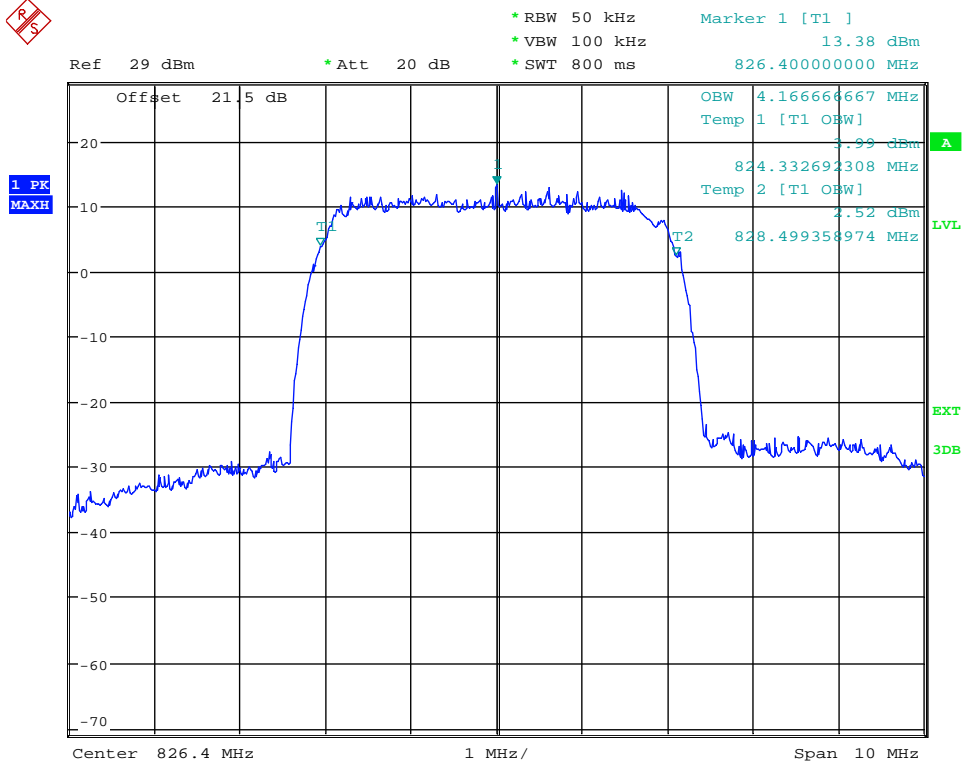

Date: 8.JAN.2014 14:10:42

(Plot 4.4.2 A: Channel 4132:826.4MHz @ WCDMA Band V)

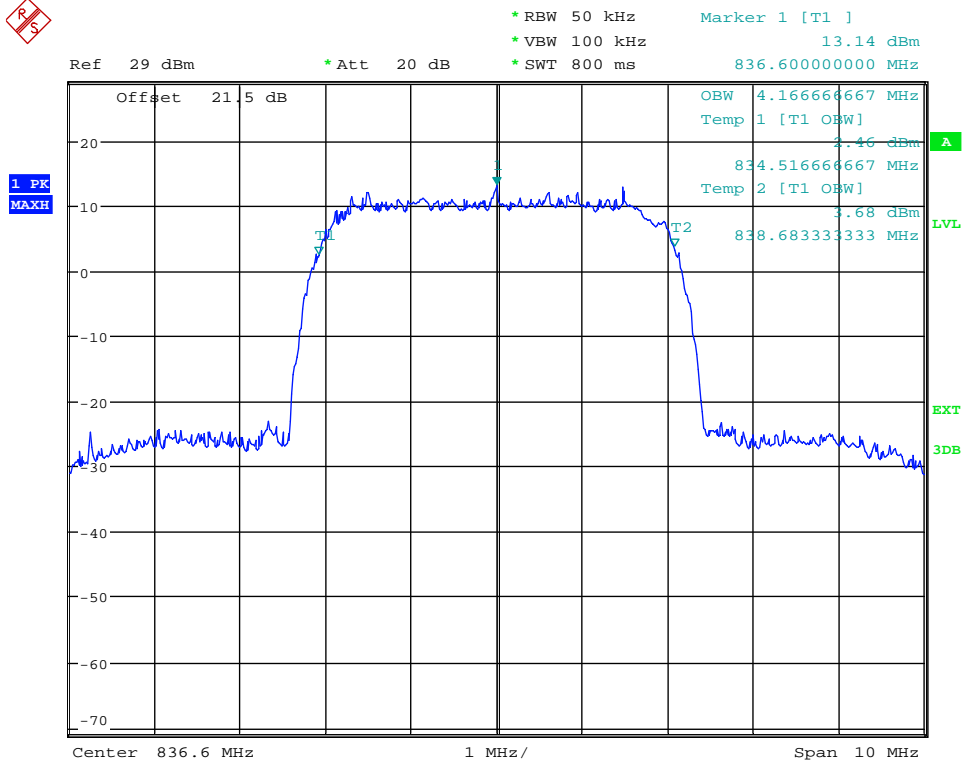

Date: 8.JAN.2014 14:09:44

(Plot 4.4.2 B: Channel 4183:836.6MHz @ WCDMA Band V)



*RBW 50 kHz Marker 1 [T1]
*VBW 100 kHz 12.23 dBm
*SWT 800 ms 847.192948718 MHz

Ref 29 dBm *Att 20 dB

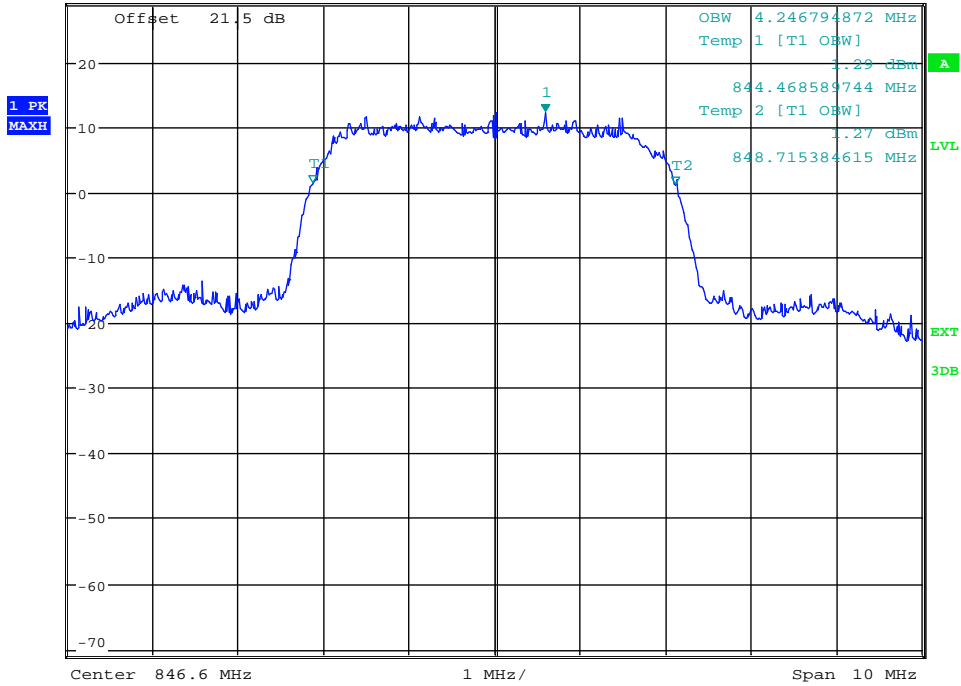

Date: 8.JAN.2014 14:08:18

(Plot 4.4.4 C: Channel 4233:846.6MHz @ WCDMA Band V)

4.5. EMISSION BANDWIDTH

TEST APPLICABLE

Similar to conducted emissions; occupied bandwidth measurements are only provided for selected frequencies in order to reduce the amount of submitted data. Data were taken at the extreme and mid frequencies of PCS94000 band and WCDMA II band. The table below lists the measured -26dBc BW.

TEST CONFIGURATION

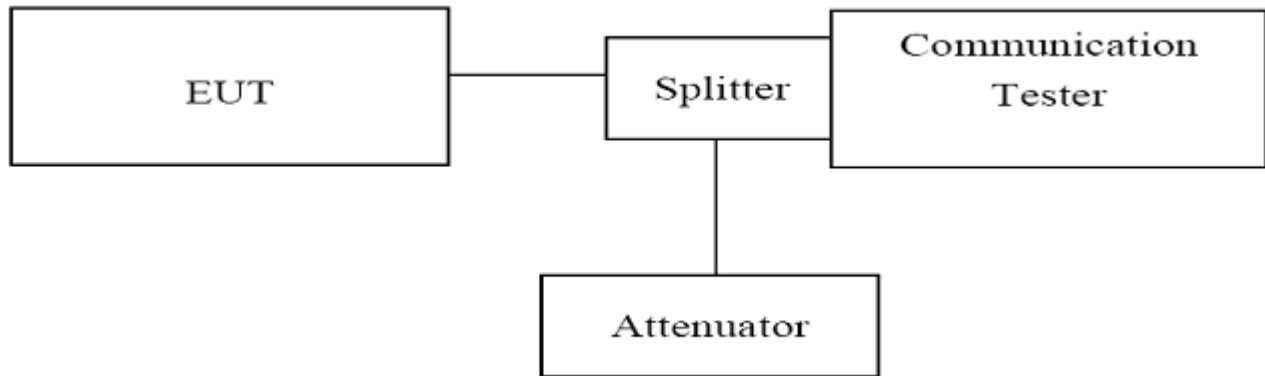

TEST PROCEDURE

1. The EUT was set up for the max output power with pseudo random data modulation;
2. The Occupied bandwidth was measured with Rhode & Schwarz Spectrum Analyzer FSU (peak);
3. Set RBW=5KHz,VBW=50KHz,Span=500KHz,SWT=20ms;
4. Set SPA Max hold. Mark peak, Set -26dBc Occupied Bandwidth
5. These measurements were done at 3 frequencies, 1850.20 MHz, 1880.00 MHz and 94009.80 MHz for WCDMA band II; 826.40 MHz, 836.60 MHz and 846.60 MHz for WCDMA band V. (low, middle and high of operational frequency range).

TEST RESULTS

WCDMA Band II				
Channel Number	Frequency (MHz)	EMISSION BANDWIDTH (-26dBc BW) (kHz)	Refer to Plot	Verdict
9262	1852.4	4855.77	Plot 4.5.1 A	PASS
9400	1880.0	4679.49	Plot 4.5.1 B	PASS
9538	1907.6	4695.51	Plot 4.5.1 C	PASS



MARKER 1
1.853025 GHz
Ref 37 dBm * Att 20 dB

* RBW 50 kHz
* VBW 100 kHz
* SWT 800 ms
Marker 1 [T1]
14.04 dBm
1.853025000 GHz

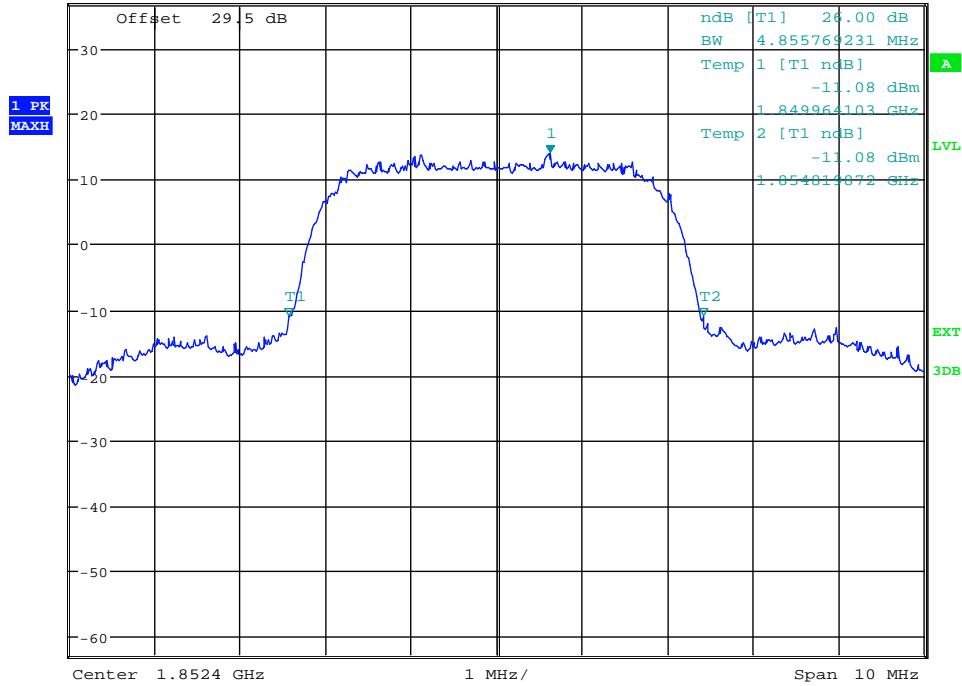

Date: 8.JAN.2014 13:31:39

(Plot 4.5.1 A: Channel 9262: 1852.4MHz WCDMA Band II)



MARKER 1 [T1]
13.36 dBm
1.879102564 GHz
Ref 37 dBm * Att 20 dB
* RBW 50 kHz
* VBW 100 kHz
* SWT 800 ms

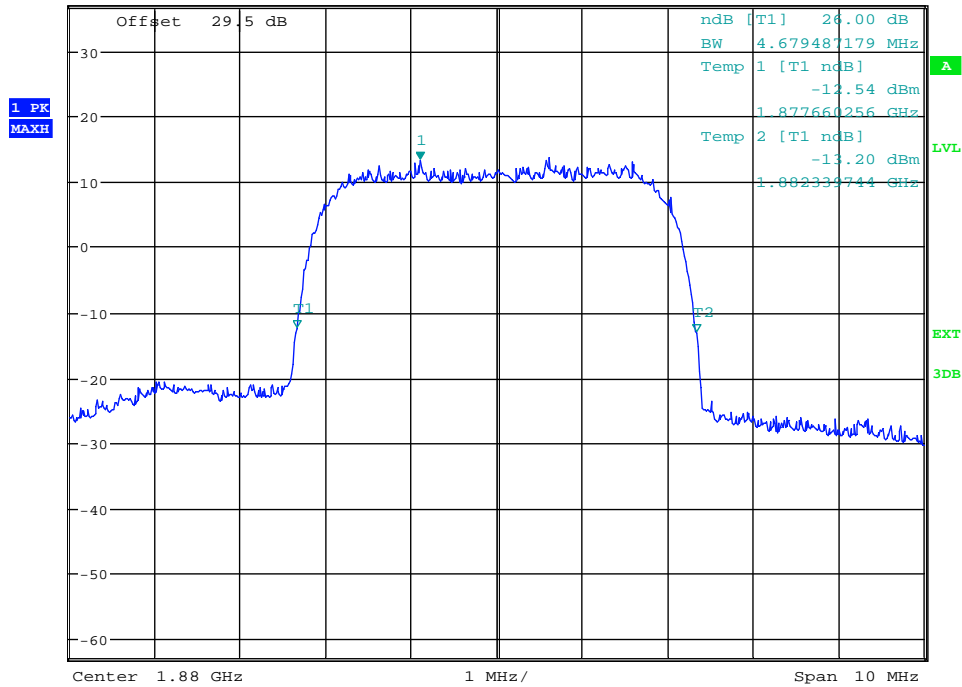

Date: 8.JAN.2014 13:30:31

(Plot 4.5.1 B: Channel 9400: 1880.0MHz WCDMA Band II)

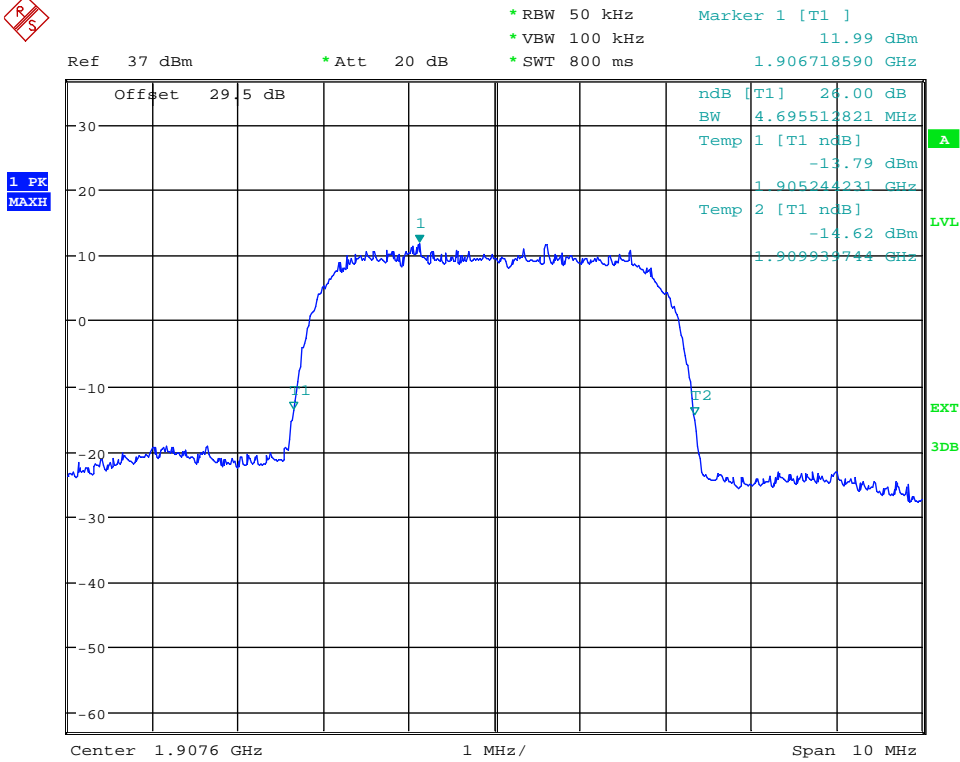

Date: 8.JAN.2014 13:29:55

(Plot 4.5.1 C: Channel 9538: 1907.6MHz WCDMA Band II)

WCDMA Band V				
Channel Number	Frequency (MHz)	EMISSION BANDWIDTH (-26dBc BW) (kHz)	Refer to Plot	Verdict
4132	826.4	4695.51	Plot 4.5.2 A	PASS
4183	836.6	4695.51	Plot 4.5.2 B	PASS
4233	846.6	4775.64	Plot 4.5.2 C	PASS



*RBW 50 kHz Marker 1 [T1]
*VBW 100 kHz 11.88 dBm
*SWT 800 ms 848.074358974 MHz

Ref 29 dBm *Att 20 dB

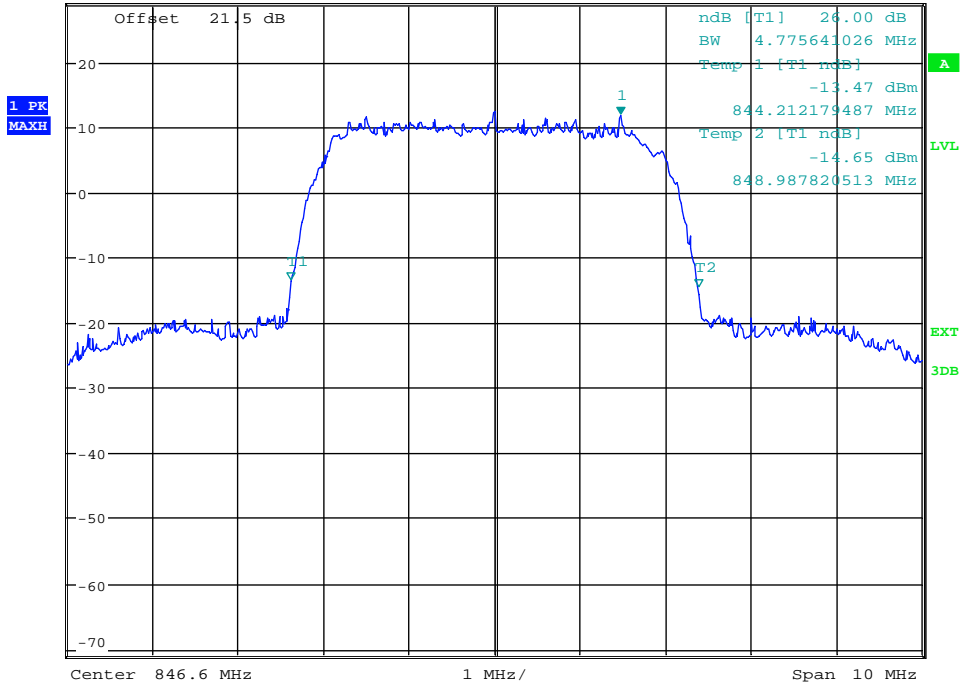

Date: 8.JAN.2014 14:12:55

(Plot 4.5.2 C: Channel 4233:846.6MHz @ WCDMA Band V)

4.6. BAND EDGE COMPLIANCE

TEST APPLICABLE

During the process of testing, the EUT was controlled via Rhode & Schwarz Digital Radio Communication tester (CMU-200) to ensure max power transmission and proper modulation.

TEST CONFIGURATION

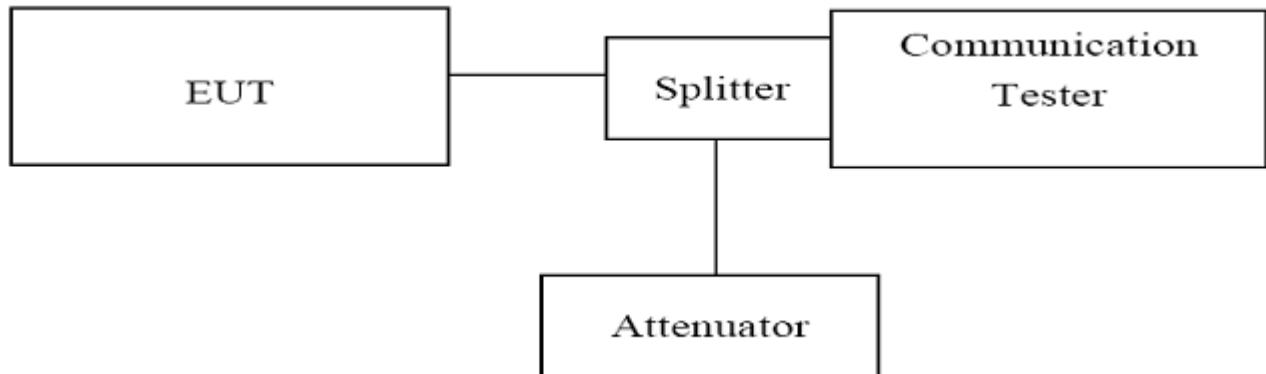

TEST PROCEDURE

1. The EUT was set up for the max output power with pseudo random data modulation;
2. The power was measured with Rhode & Schwarz Spectrum Analyzer FSU (peak);
3. Set RBW=5KHz,VBW=50KHz,Span=1MHz,SWT=300ms;
4. These measurements were done at 3 frequencies, 1850.20 MHz, 1880.00 MHz and 94009.80 MHz for WCDMA band II; 826.4 MHz, 836.6 MHz and 846.6 MHz for WCDMA band V. (low, middle and high of operational frequency range).

TEST RESULTS

WCDMA Band II						
Channel Number	Frequency (MHz)	Measurement Results		Limit (dBm)	Refer to Plot	Verdict
		Frequency (MHz)	Values (dBm)			
9262	1852.4	1850.00	-17.37	-13.00	Plot 4.6.1 A	PASS
9538	1907.6	1910.69	-20.85	-13.00	Plot 4.6.1 B	PASS



*RBW 50 kHz Marker 1 [T1]
*VBW 100 kHz -17.37 dBm
*SWT 800 ms 1.850000000 GHz

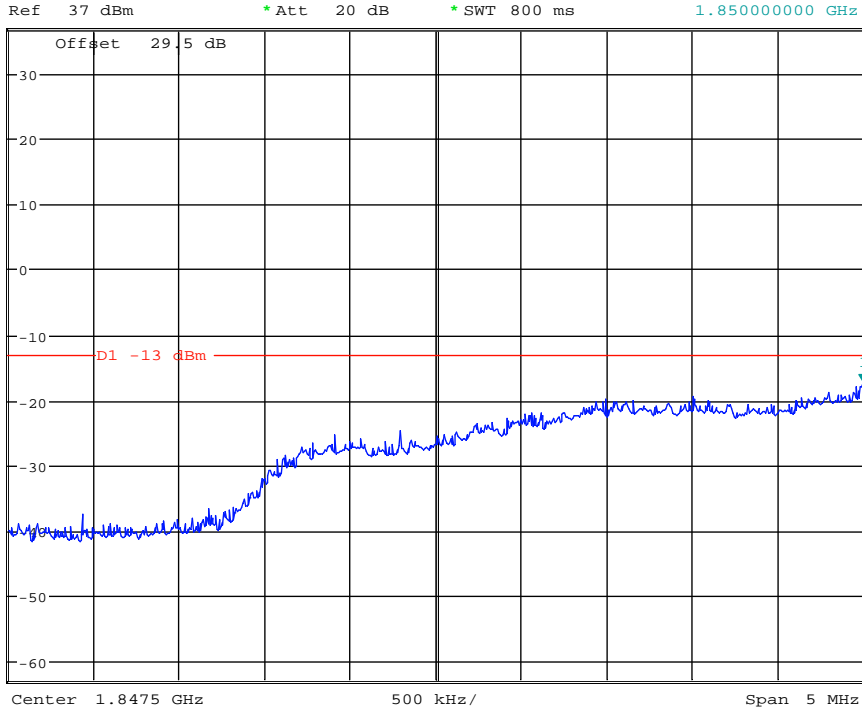

Date: 8.JAN.2014 13:35:06

(Plot 4.6.1 A: Channel 9262: 1852.4MHz WCDMA Band II)



*RBW 50 kHz Marker 1 [T1]
*VBW 100 kHz -20.85 dBm
*SWT 800 ms 1.910000000 GHz

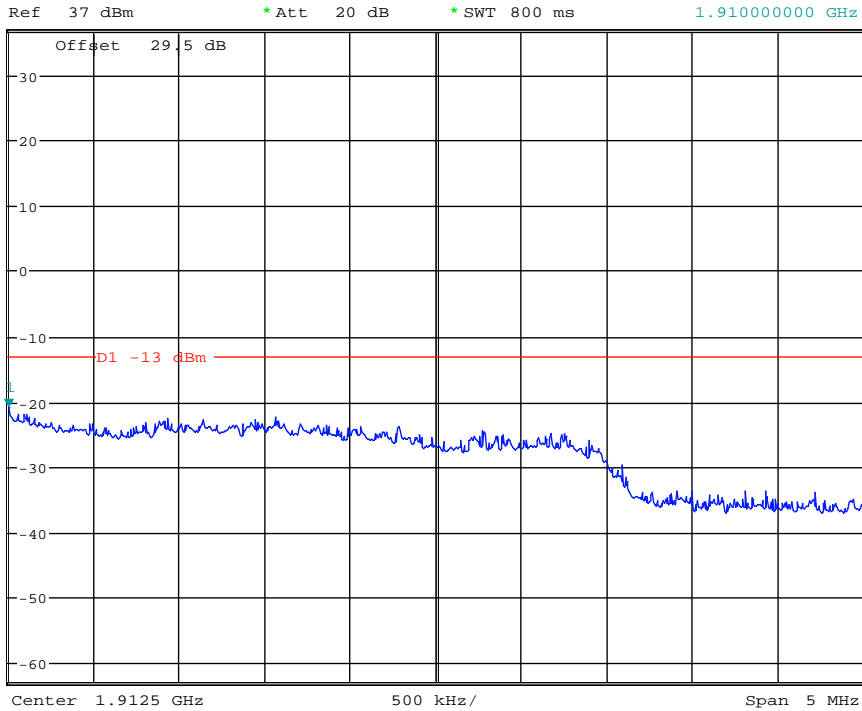

Date: 8.JAN.2014 13:36:08

(Plot 4.6.1 B: Channel 9538: 1907.6MHz WCDMA Band II)

WCDMA Band V						
Channel Number	Frequency (MHz)	Measurement Results		Limit (dBm)	Refer to Plot	Verdict
		Frequency (MHz)	Values (dBm)			
4132	826.4	823.99	-22.23	-13.00	Plot 4.6.2 A	PASS
4233	846.6	849.00	-17.51	-13.00	Plot 4.6.2 B	PASS

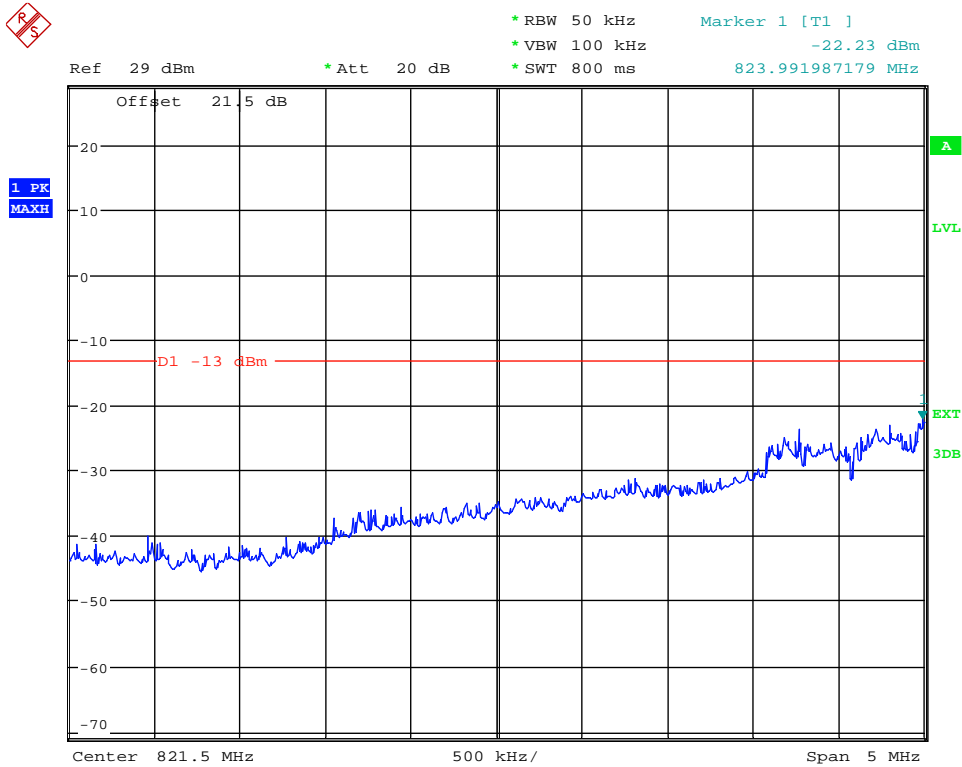

Date: 8.JAN.2014 14:15:24

(Plot 4.6.2 A: Channel 4132: 826.4MHz @ WCDMA Band V)



*RBW 50 kHz Marker 1 [T1]
*VBW 100 kHz -17.51 dBm
*SWT 800 ms 849.00000000 MHz

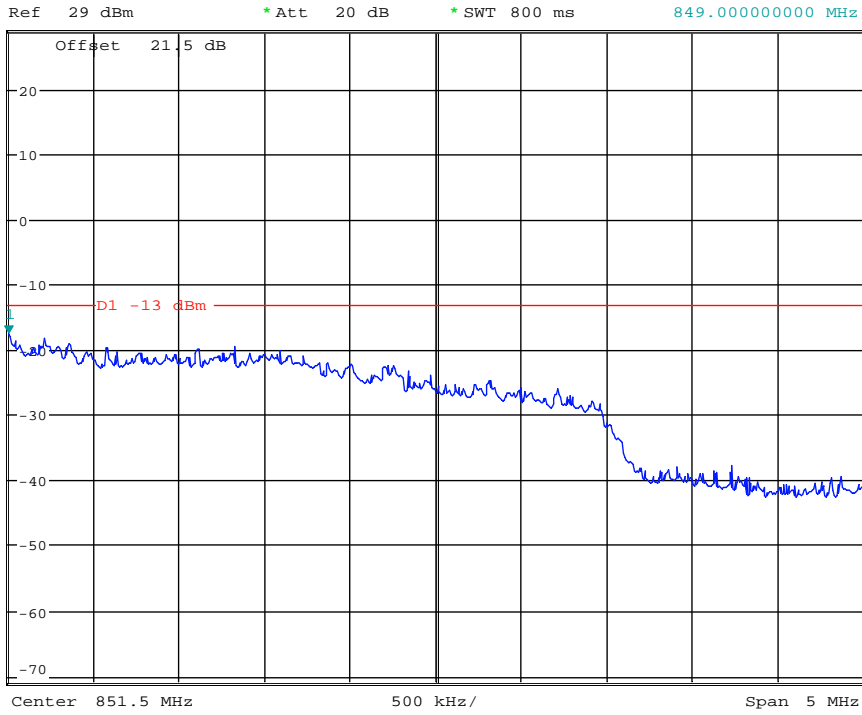

Date: 8.JAN.2014 14:14:38

(Plot 4.6.2 B: Channel 4233: 846.6MHz @ WCDMA Band V)

4.7. Spurious Emission on Antenna Port

TEST APPLICABLE

The following steps outline the procedure used to measure the conducted emissions from the EUT.

1. Determine frequency range for measurements: From CFR 2.1057 the spectrum should be investigated from the lowest radio frequency generated in the equipment up to at least the 10th harmonic of the carrier frequency. For the equipment of WCDMA band II, this equates to a frequency range of 30 MHz to 20GHz, data taken from 30 MHz to 20 GHz. For WCDMA Band V, data taken from 30 MHz to 10 GHz.
2. The sweep time is set automatically by instrument itself. That should be the optimal sweep time for the span and the RBW. If the sweep time is too short, that is sweep is too fast, the sweep result is not accurate; if the sweep time is too long, that is sweep is too low, some frequency components may be lost. The instrument will give a optimal sweep time according the selected span and RBW.
3. The procedure to get the conducted spurious emission is as follows:
The trace mode is set to MaxHold to get the highest signal at each frequency;
Wait 25 seconds;
Get the result.
4. Determine EUT transmit frequencies: below outlines the band edge frequencies pertinent to conducted emissions testing.

TEST CONFIGURATION

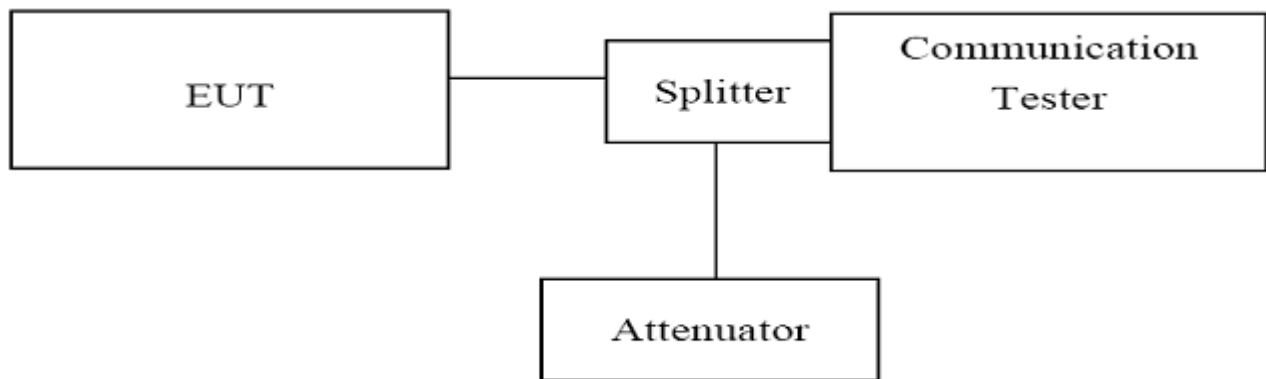

TEST PROCEDURE

1. The EUT was set up for the max output power with pseudo random data modulation;
2. The power was measured with Rhode & Schwarz Spectrum Analyzer FSU (peak);
3. These measurements were done at 3 frequencies, 1850.20 MHz, 1880.00 MHz and 1709.80 MHz for WCDMA band II; 826.4 MHz, 836.6 MHz and 846.6 MHz for WCDMA band V. (low, middle and high of operational frequency range).

TEST LIMIT

Part 24.238 and Part 22.917 specify that the power of any emission outside of the authorized operating frequency ranges must be attenuated below the transmitting power (P) by a factor of at least $43 + 10 \log(P)$ dB.

The specification that emissions shall be attenuated below the transmitter power (P) by at least $43 + 10 \log(P)$ dB, translates in the relevant power range (1 to 0.001 W) to -13 dBm. At 1 W the specified minimum attenuation becomes 43 dB and relative to a 30 dBm (1 W) carrier becomes a limit of -13 dBm. At 0.001 W (0 dBm) the minimum attenuation is 13 dB, which again yields a limit of -13 dBm. In this way a translation of the specification from relative to absolute terms is carried out.

TEST RESULTS

WCDMA Band II						
Channel Number: 9262		Test Frequency: 1852.4 MHz			Test Mode: Traffic	
Start Frequency (MHz)	Stop Frequency (MHz)	Measurement Results		Limit (dBm)	Refer to Plot	Verdict
		Frequency (MHz)	Values (dBm)			
30	1000	407.74	-32.20	-13.00	Plot 4.7.1 A1	PASS
1000	2500	***	***	-13.00	Plot 4.7.1 A2	PASS
2500	7500	9557.69	-27.70	-13.00	Plot 4.7.1 A3	PASS
7500	10000	9923.88	-30.28	-13.00	Plot 4.7.1 A4	PASS
10000	15000	13509.62	-29.70	-13.00	Plot 4.7.1 A5	PASS
15000	20000	17363.78	-29.29	-13.00	Plot 4.7.1 A6	PASS

WCDMA Band II						
Channel Number: 9400		Test Frequency: 1880.0 MHz			Test Mode: Traffic	
Start Frequency (MHz)	Stop Frequency (MHz)	Measurement Results		Limit (dBm)	Refer to Plot	Verdict
		Frequency (MHz)	Values (dBm)			
30	1000	757.50	-31.74	-13.00	Plot 4.7.2 A1	PASS
1000	2500	***	***	-13.00	Plot 4.7.2 A2	PASS
2500	7500	3589.74	-28.47	-13.00	Plot 4.7.2 A3	PASS
7500	10000	8926.28	-30.22	-13.00	Plot 4.7.2 A4	PASS
10000	15000	13597.76	-29.59	-13.00	Plot 4.7.2 A5	PASS
15000	20000	17299.68	-28.76	-13.00	Plot 4.7.2 A6	PASS

WCDMA Band II						
Channel Number: 9538		Test Frequency: 1907.6 MHz			Test Mode: Traffic	
Start Frequency (MHz)	Stop Frequency (MHz)	Measurement Results		Limit (dBm)	Refer to Plot	Verdict
		Frequency (MHz)	Values (dBm)			
30	1000	796.36	-32.23	-13.00	Plot 4.7.3 A1	PASS
1000	2500	***	***	-13.00	Plot 4.7.3 A2	PASS
2500	7500	3277.24	-28.82	-13.00	Plot 4.7.3 A3	PASS
7500	10000	9519.23	-30.33	-13.00	Plot 4.7.3 A4	PASS
10000	15000	14174.68	-29.88	-13.00	Plot 4.7.3 A5	PASS
15000	20000	17788.46	-29.32	-13.00	Plot 4.7.3 A6	PASS

WCDMA Band II						
Test Mode: Idle						
Start Frequency (MHz)	Stop Frequency (MHz)	Measurement Results		Limit (dBm)	Refer to Plot	Verdict
		Frequency (MHz)	Values (dBm)			
30	1000	951.81	-31.78	-13.00	Plot 4.7.4 A1	PASS
1000	2500	2468.75	-29.85	-13.00	Plot 4.7.4 A2	PASS
2500	7500	3517.63	-28.97	-13.00	Plot 4.7.4 A3	PASS
7500	10000	9527.24	-30.27	-13.00	Plot 4.7.4 A4	PASS
10000	15000	11602.56	-30.58	-13.00	Plot 4.7.4 A5	PASS
15000	20000	17259.62	-28.34	-13.00	Plot 4.7.4 A6	PASS

Note: 1. In general, the worse case attenuation requirement shown above was applied.

2. *** means that the emission level is too low to be measured or at least 20 dB down than the limit.



*RBW 1 MHz Marker 1 [T1]
*VBW 3 MHz -32.20 dBm
SWT 2.5 ms 407.740384615 MHz

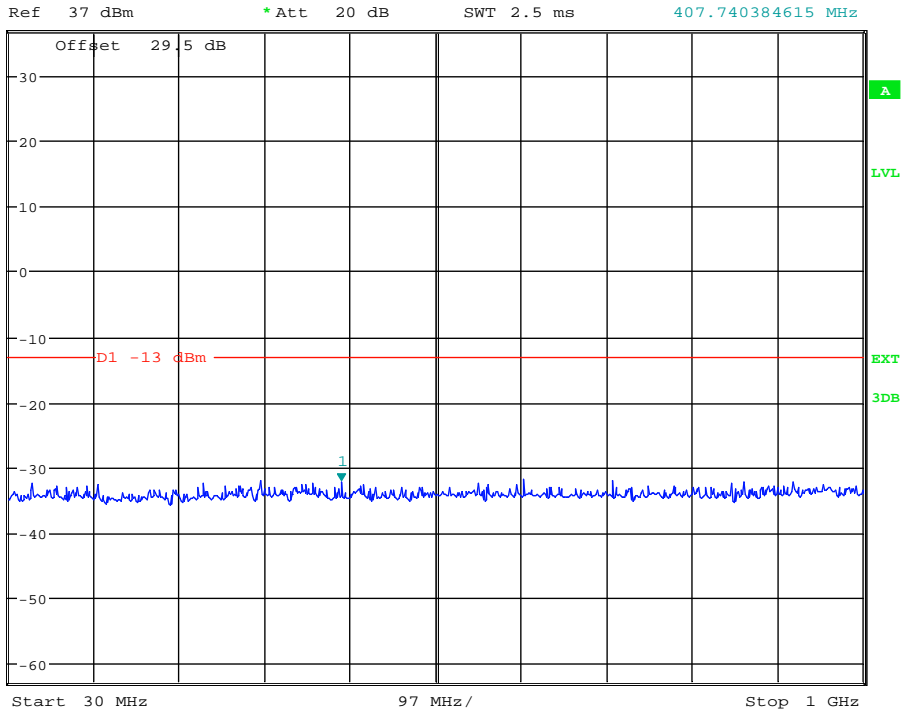

Date: 8.JAN.2014 13:45:47

(Plot 4.7.1 A1: Channel 9262: 1852.4MHz @ Traffic WCDMA Band II)



*RBW 1 MHz Marker 1 [T1]
*VBW 3 MHz 21.62 dBm
SWT 5 ms 1.853365385 GHz

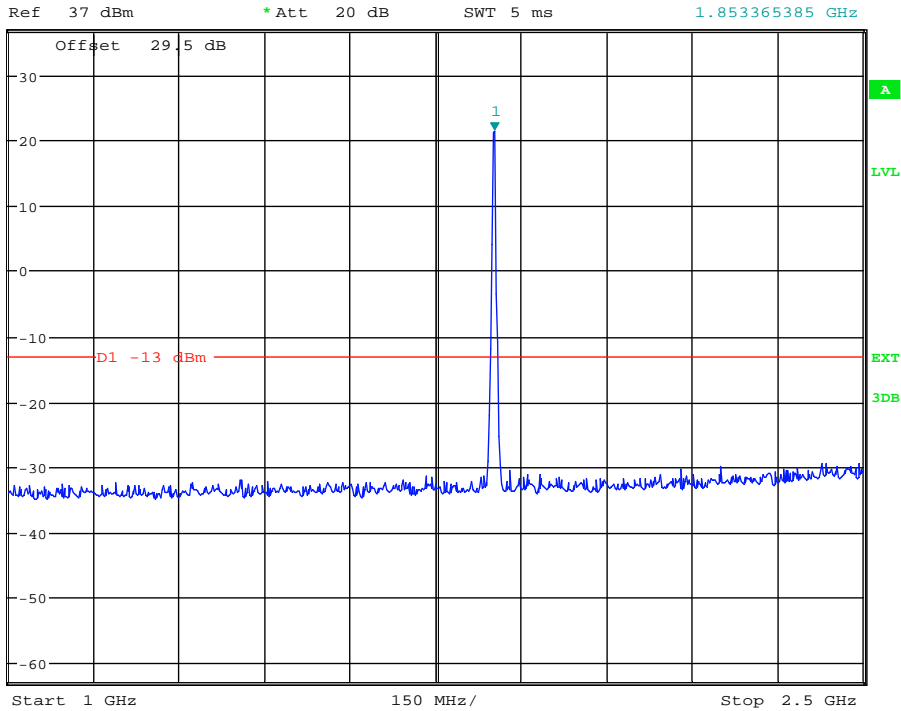

Date: 8.JAN.2014 13:46:02

(Plot 4.7.1 A2: Channel 9262: 1852.4MHz @ Traffic WCDMA Band II)



*RBW 1 MHz Marker 1 [T1]
*VBW 3 MHz -27.70 dBm
SWT 30 ms 3.557692308 GHz

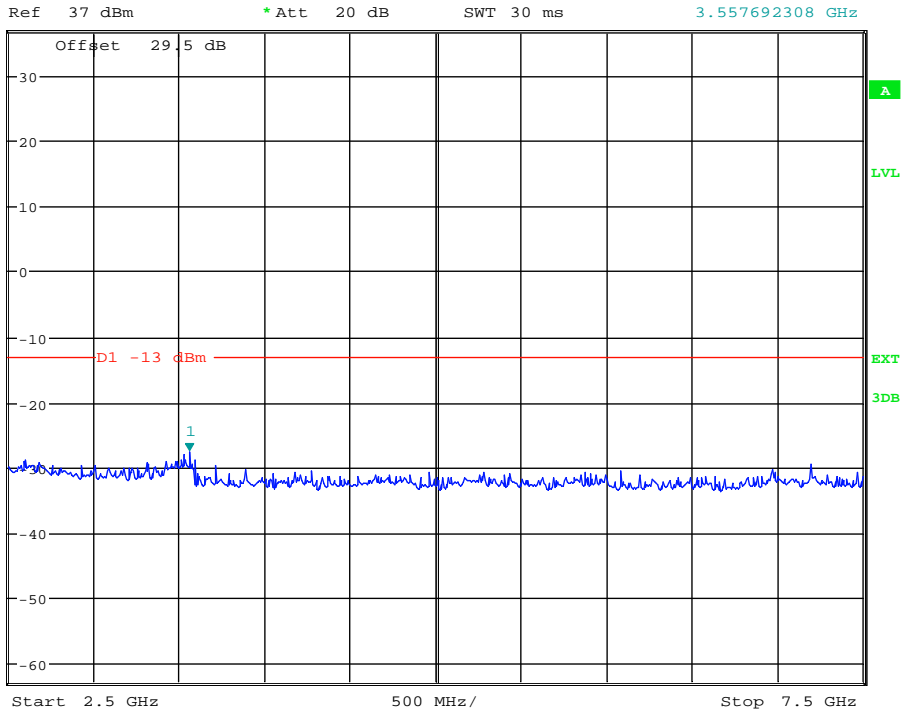

Date: 8.JAN.2014 13:46:25

(Plot 4.7.1 A3: Channel 9262: 1852.4MHz @ Traffic WCDMA Band II)



*RBW 1 MHz Marker 1 [T1]
*VBW 3 MHz -30.28 dBm
SWT 20 ms 9.923878205 GHz

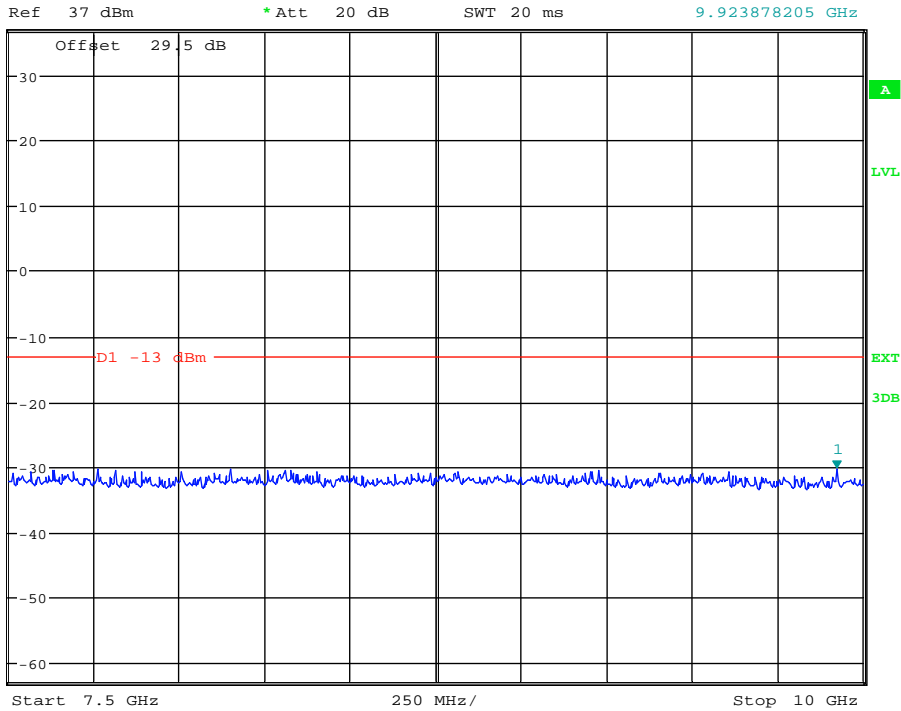

Date: 8.JAN.2014 13:46:48

(Plot 4.7.1 A4: Channel 9262: 1852.4MHz @ Traffic WCDMA Band II)



Ref 37 dBm * Att 20 dB * RBW 1 MHz Marker 1 [T1]
* VBW 3 MHz -29.70 dBm
SWT 30 ms 13.509615385 GHz

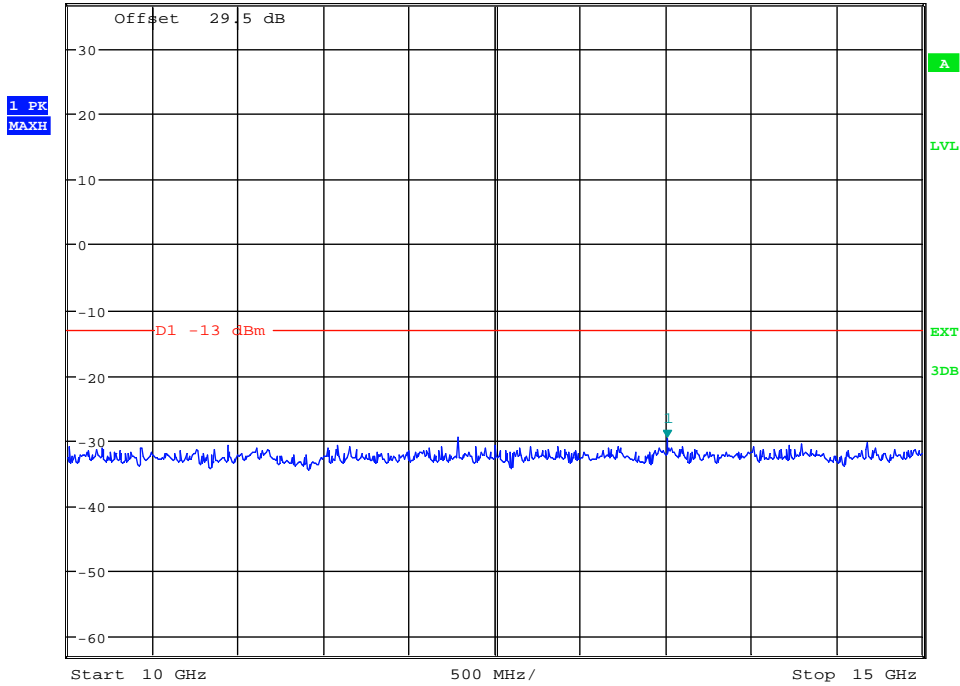

Date: 8.JAN.2014 13:45:32

(Plot 4.7.1 A5: Channel 9262: 1852.4MHz @ Traffic WCDMA Band II)



Ref 37 dBm * Att 20 dB * RBW 1 MHz Marker 1 [T1]
* VBW 3 MHz -29.29 dBm
SWT 30 ms 17.363782051 GHz

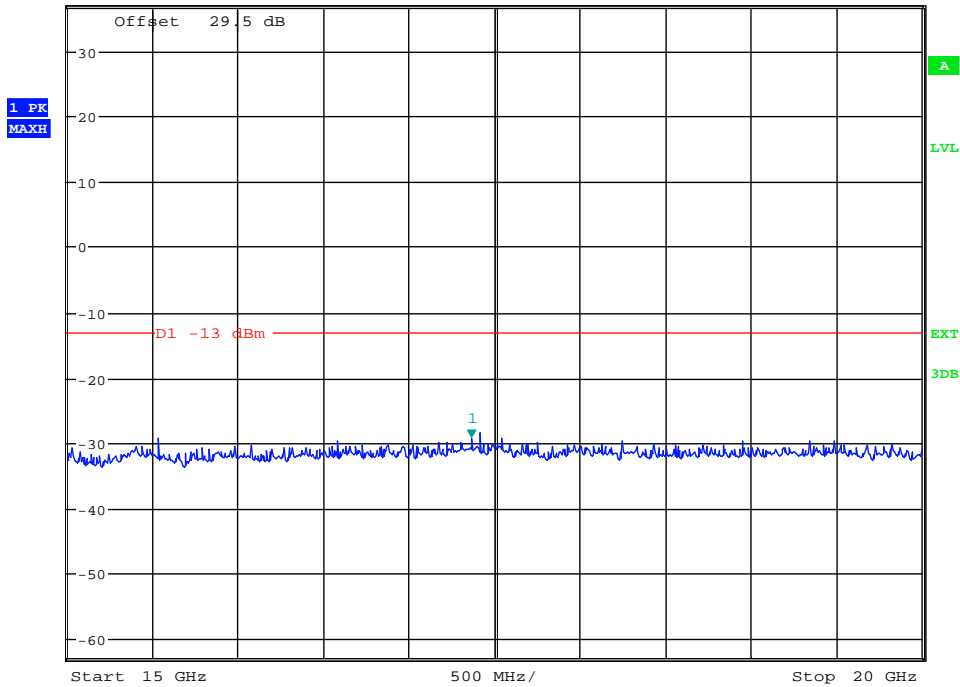

Date: 8.JAN.2014 13:45:02

(Plot 4.7.1 A6: Channel 9262: 1852.4MHz @ Traffic WCDMA Band II)



*RBW 1 MHz Marker 1 [T1]
*VBW 3 MHz -31.74 dBm
SWT 2.5 ms 757.50000000 MHz

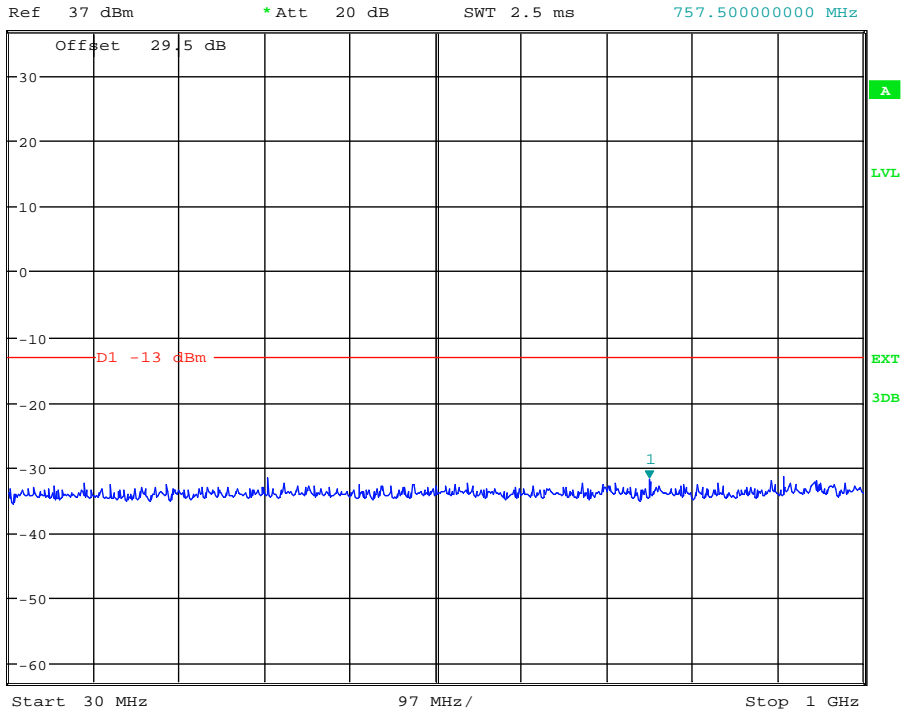

Date: 8.JAN.2014 13:42:36

(Plot 4.7.2 A1: Channel 9400: 1880.0MHz @ Traffic WCDMA Band II)



*RBW 1 MHz Marker 1 [T1]
*VBW 3 MHz 21.26 dBm
SWT 5 ms 1.882211538 GHz

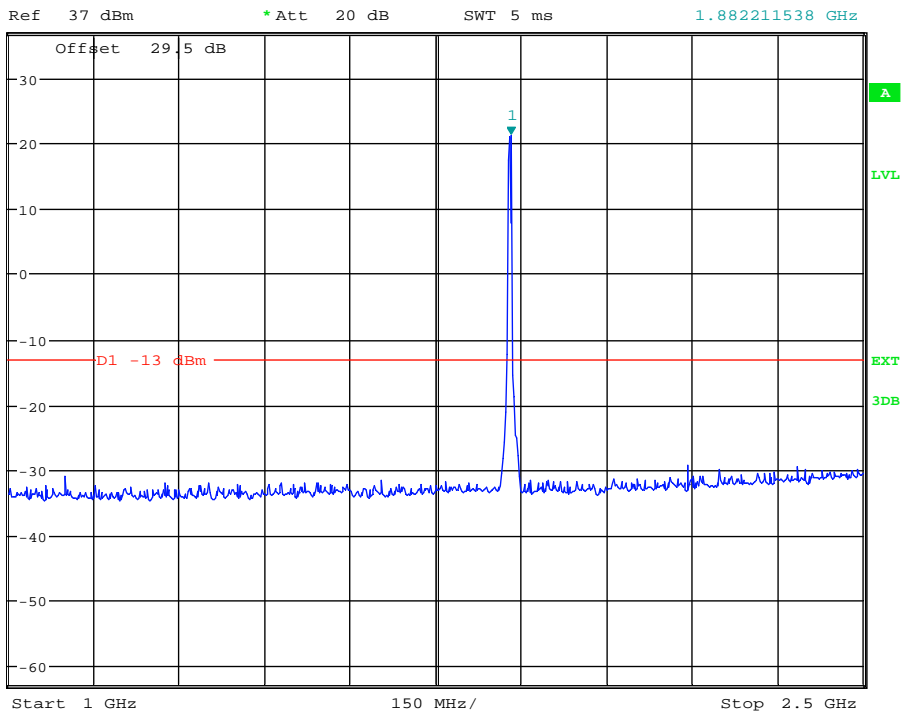

Date: 8.JAN.2014 13:42:54

(Plot 4.7.2 A2: Channel 9400: 1880.0MHz @ Traffic WCDMA Band II)



*RBW 1 MHz Marker 1 [T1]
*VBW 3 MHz -28.47 dBm
SWT 30 ms 3.589743590 GHz

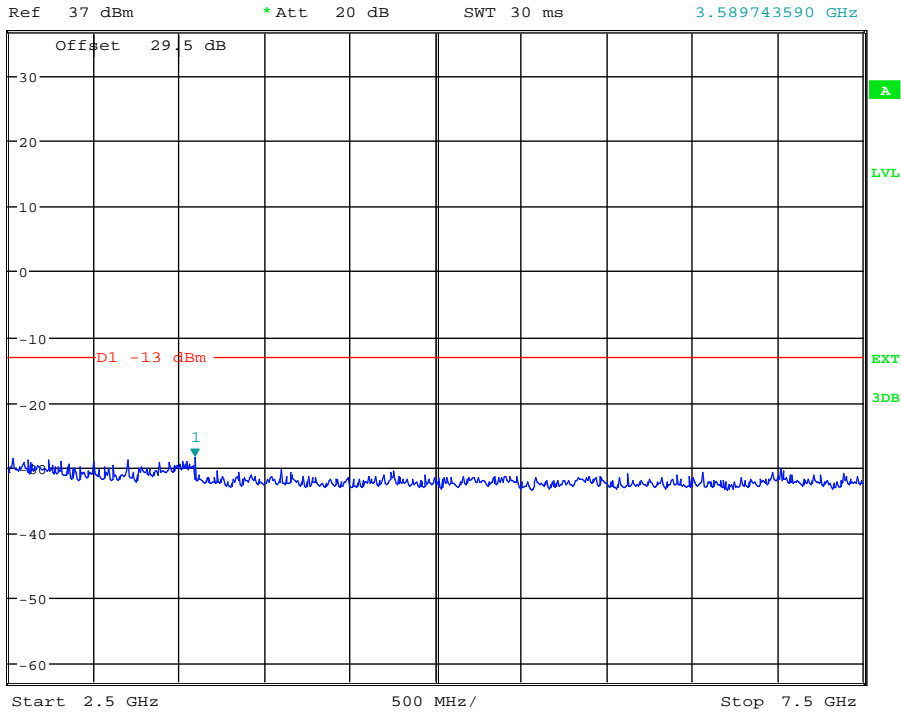

Date: 8.JAN.2014 13:43:15

(Plot 4.7.2 A3: Channel 9400: 1880.0MHz @ Traffic WCDMA Band II)



*RBW 1 MHz Marker 1 [T1]
*VBW 3 MHz -30.22 dBm
SWT 20 ms 8.926282051 GHz

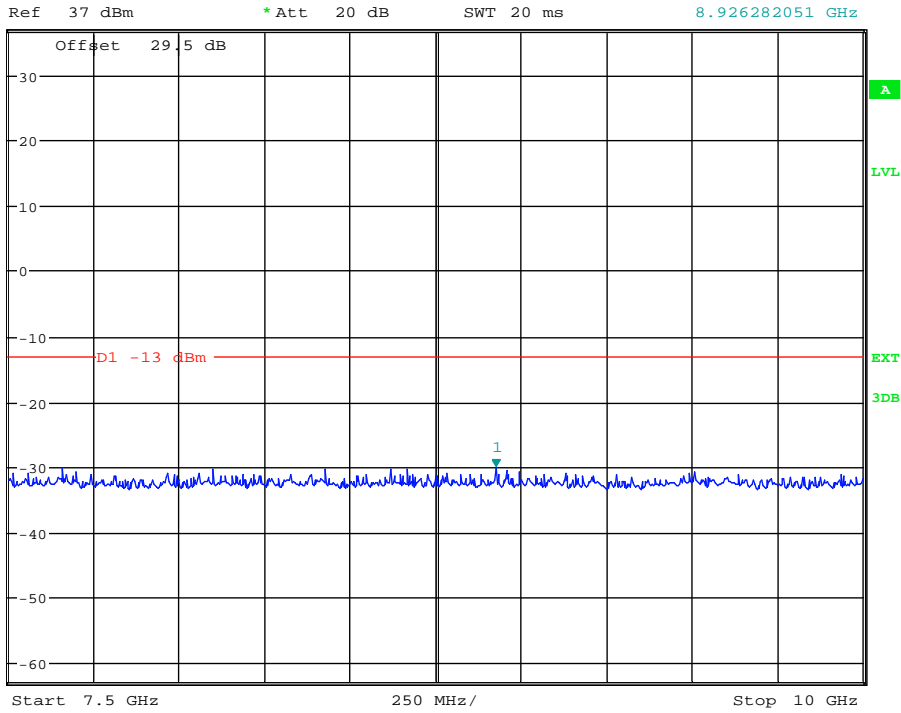

Date: 8.JAN.2014 13:44:14

(Plot 4.7.2 A4: Channel 9400: 1880.0MHz @ Traffic WCDMA Band II)



*RBW 1 MHz Marker 1 [T1]
*VBW 3 MHz -29.59 dBm
SWT 30 ms 13.597756410 GHz

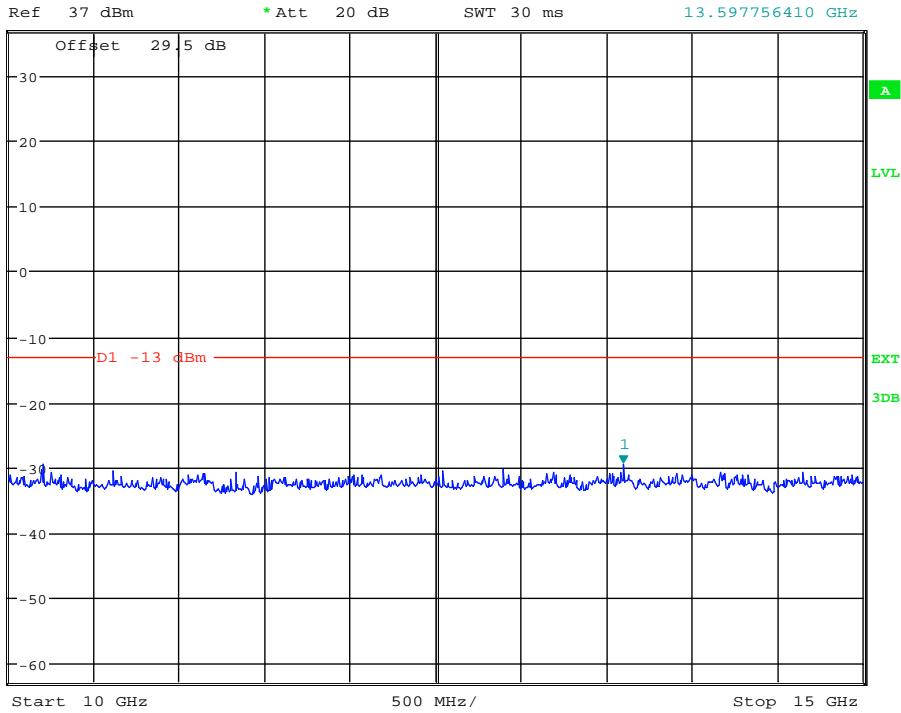

Date: 8.JAN.2014 13:42:12

(Plot 4.7.2 A5: Channel 9400: 1880.0MHz @ Traffic WCDMA Band II)



*RBW 1 MHz Marker 1 [T1]
*VBW 3 MHz -28.76 dBm
SWT 30 ms 17.299679487 GHz

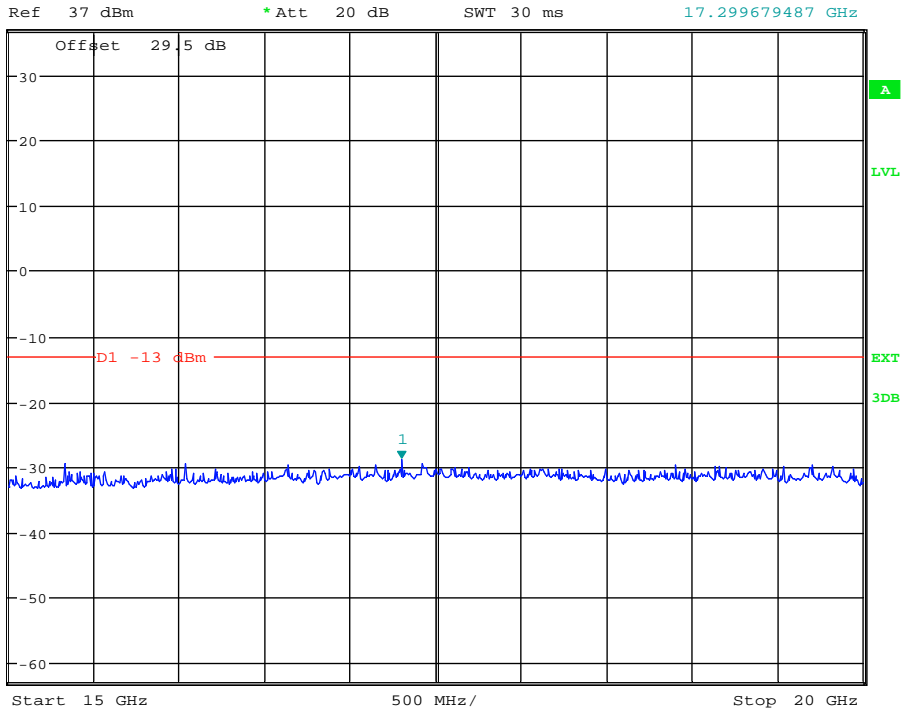

Date: 8.JAN.2014 13:44:36

(Plot 4.7.2 A6: Channel 9400: 1880.0MHz @ Traffic WCDMA Band II)



*RBW 1 MHz Marker 1 [T1]
*VBW 3 MHz -32.23 dBm
SWT 2.5 ms 796.362179487 MHz

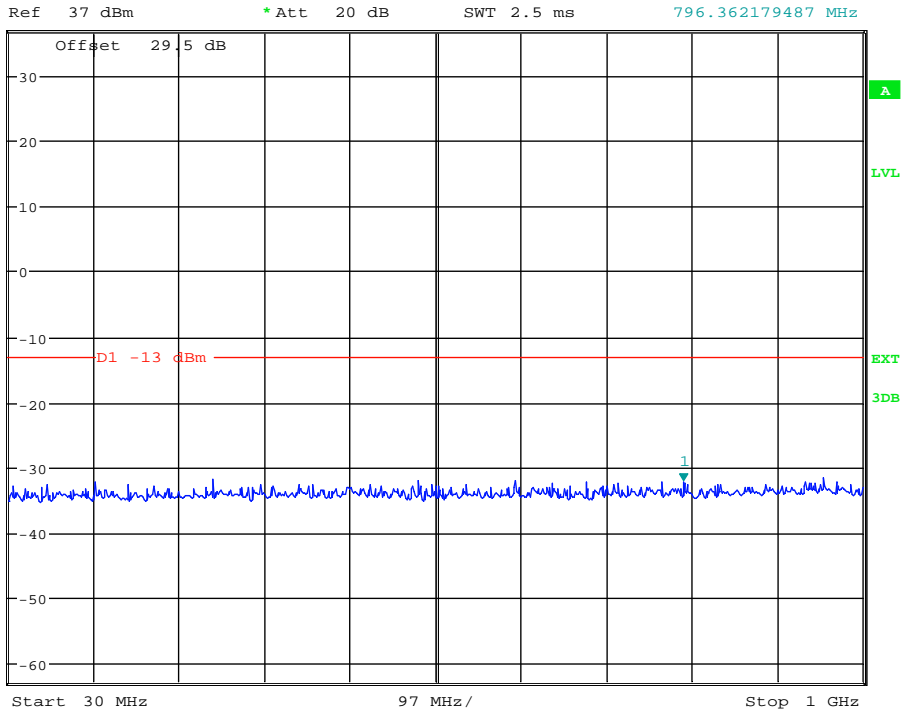

Date: 8.JAN.2014 13:37:46

(Plot 4.7.3 A1: Channel 9538: 1907.6MHz @ Traffic WCDMA Band II)



*RBW 1 MHz Marker 1 [T1]
*VBW 3 MHz 20.22 dBm
SWT 5 ms 1.908653846 GHz

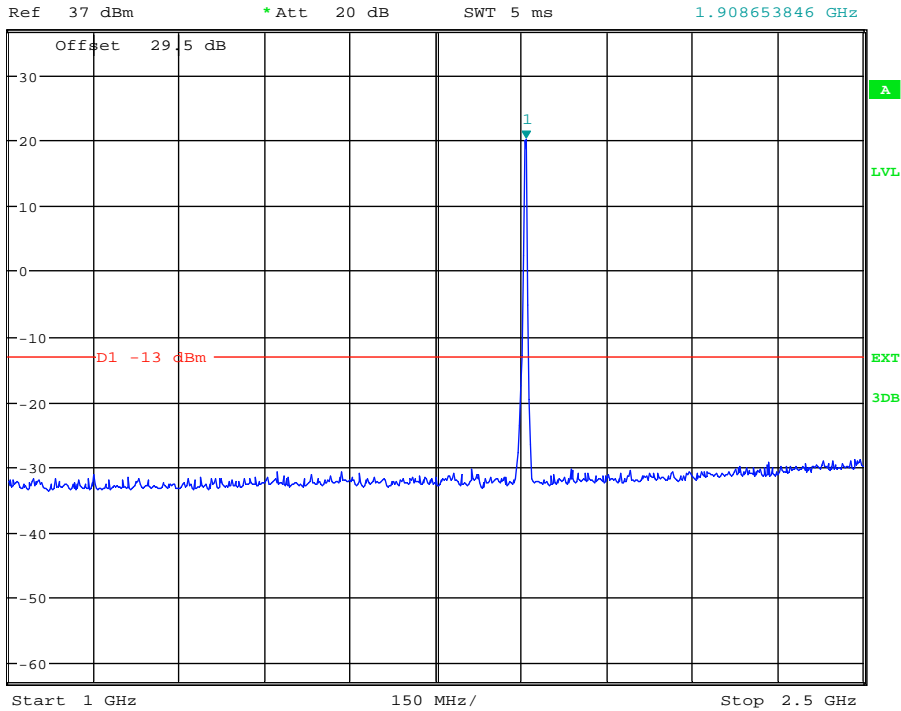

Date: 8.JAN.2014 13:39:02

(Plot 4.7.3 A2: Channel 9538: 1907.6MHz @ Traffic WCDMA Band II)



*RBW 1 MHz Marker 1 [T1]
*VBW 3 MHz -28.82 dBm
SWT 30 ms 3.277243590 GHz

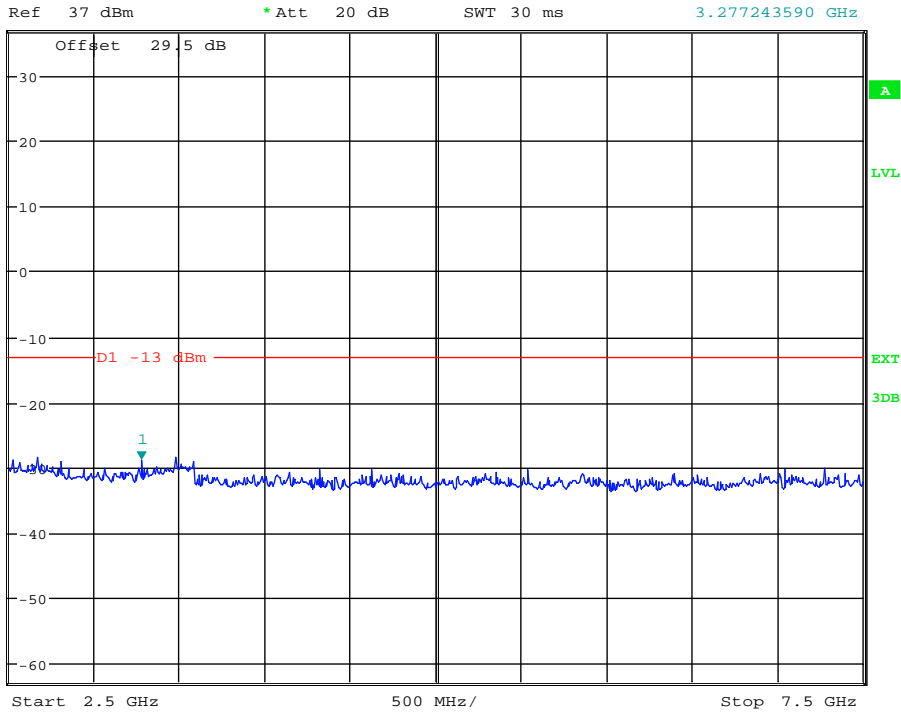

Date: 8.JAN.2014 13:39:21

(Plot 4.7.3 A3: Channel 9538: 1907.6MHz @ Traffic WCDMA Band II)



*RBW 1 MHz Marker 1 [T1]
*VBW 3 MHz -30.33 dBm
SWT 20 ms 9.519230769 GHz

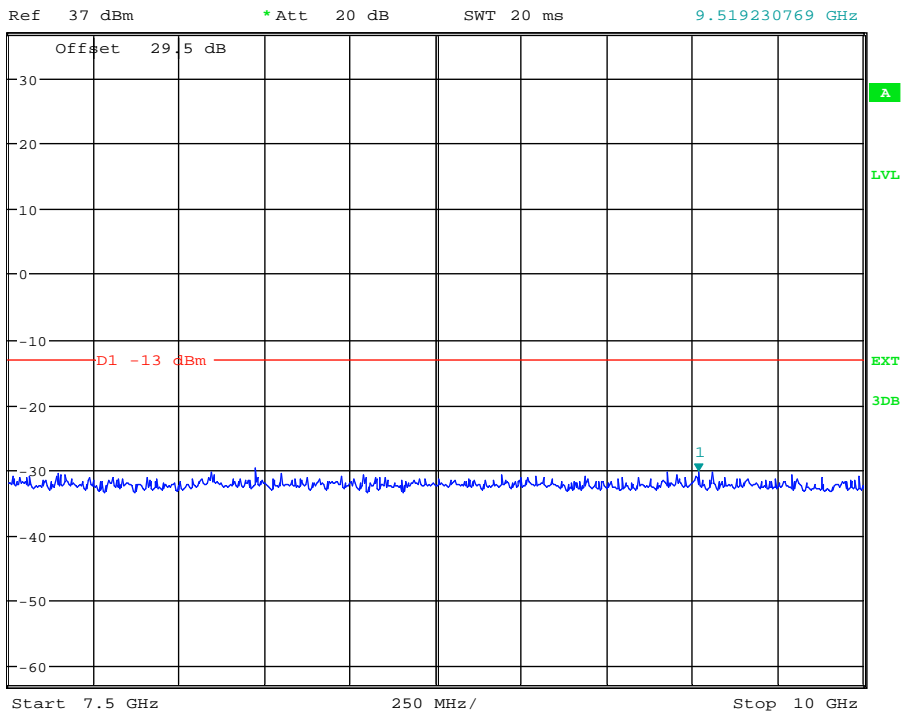

Date: 8.JAN.2014 13:39:45

(Plot 4.7.3 A4: Channel 9538: 1907.6MHz @ Traffic WCDMA Band II)



*RBW 1 MHz Marker 1 [T1]
*VBW 3 MHz -29.88 dBm
SWT 30 ms 14.174679487 GHz

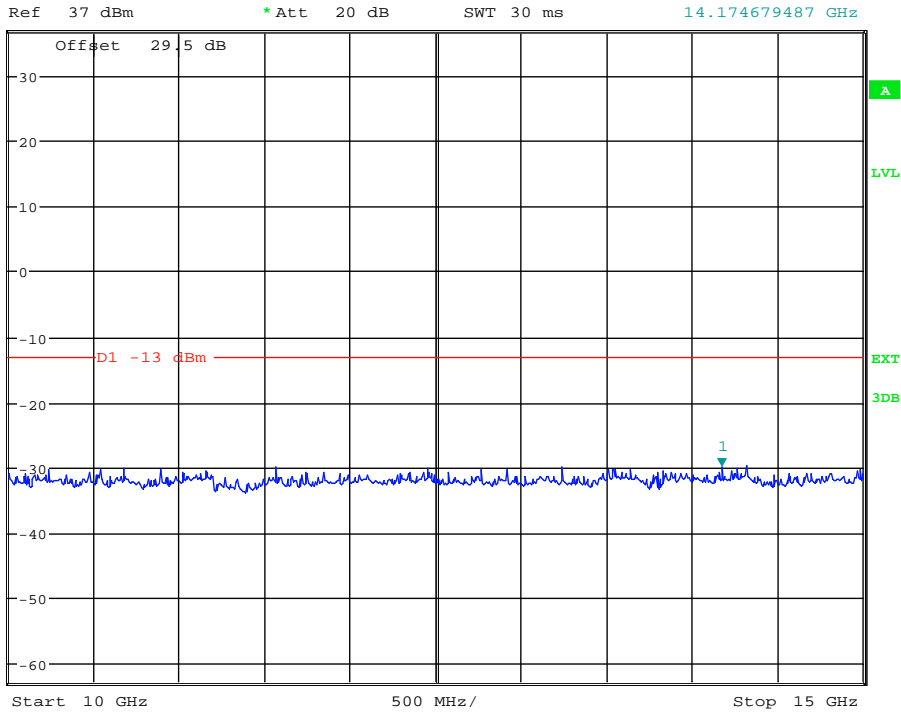

Date: 8.JAN.2014 13:40:40

(Plot 4.7.3 A5: Channel 9538: 1907.6MHz @ Traffic WCDMA Band II)



*RBW 1 MHz Marker 1 [T1]
*VBW 3 MHz -29.32 dBm
SWT 30 ms 17.788461538 GHz

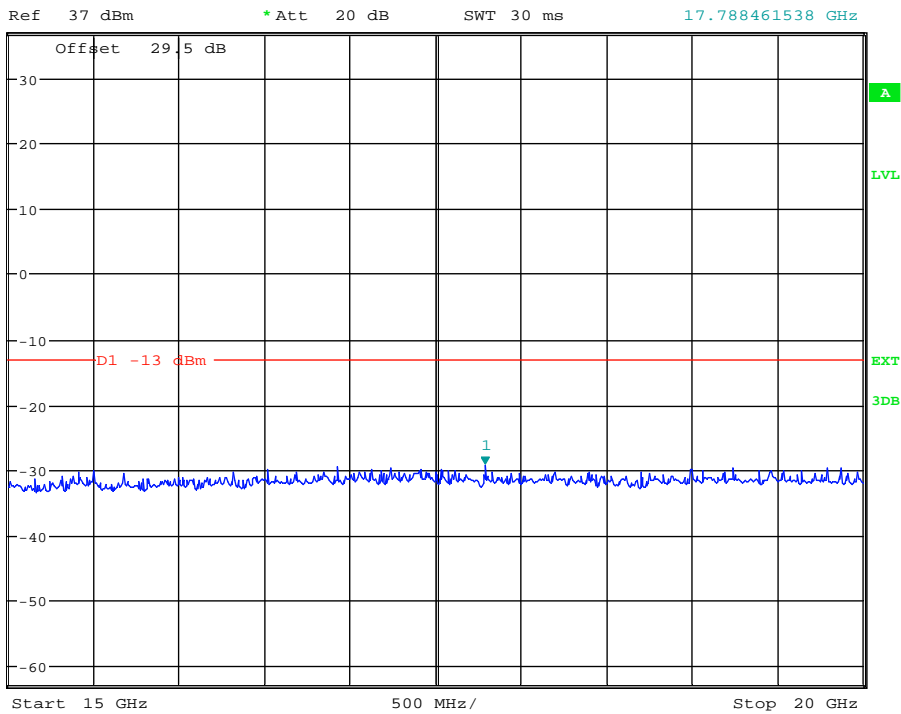

Date: 8.JAN.2014 13:40:01

(Plot 4.7.3 A6: Channel 9538: 1907.6MHz @ Traffic WCDMA Band II)



*RBW 1 MHz Marker 1 [T1]
*VBW 3 MHz -31.78 dBm
SWT 2.5 ms 951.810897436 MHz

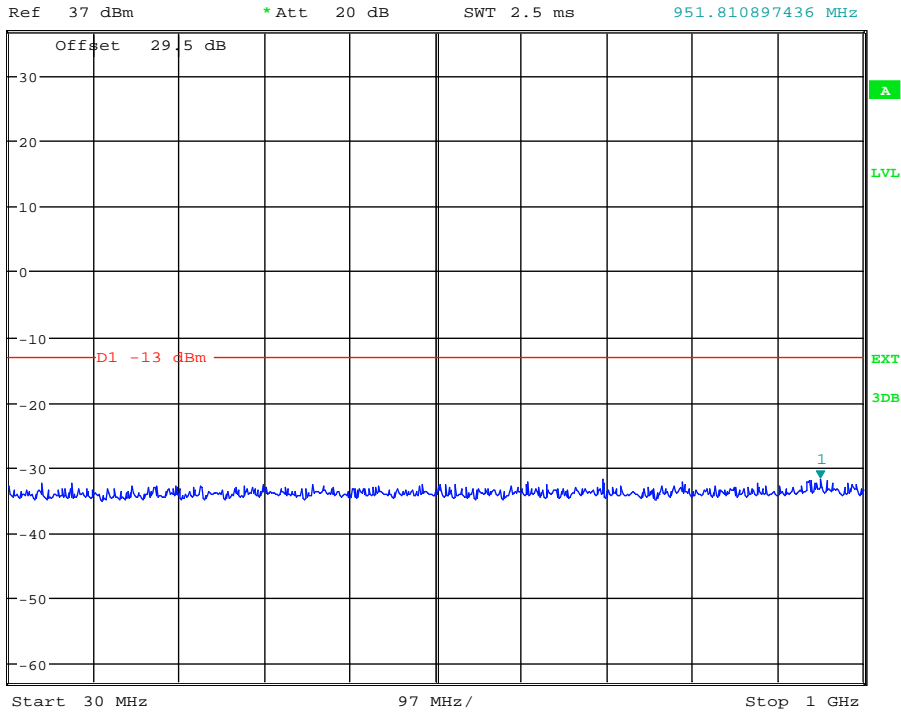

Date: 8.JAN.2014 13:47:39

(Plot 4.7.4 A1: Idle WCDMA Band II)



*RBW 1 MHz Marker 1 [T1]
*VBW 3 MHz -29.85 dBm
SWT 5 ms 2.468750000 GHz

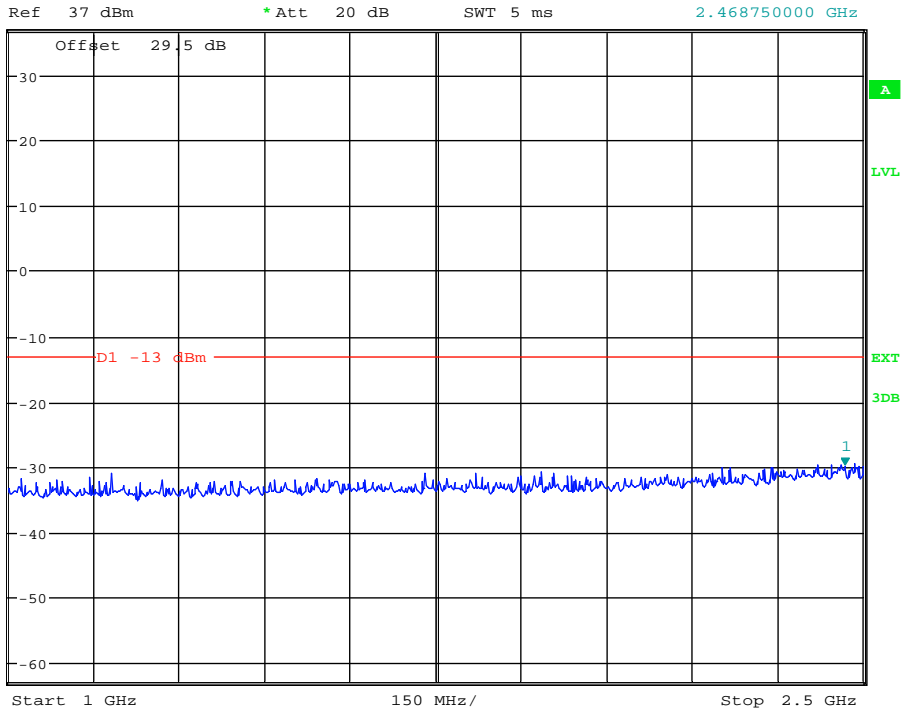

Date: 8.JAN.2014 13:47:56

(Plot 4.7.4 A2: Idle WCDMA Band II)



Ref 37 dBm * Att 20 dB * RBW 1 MHz Marker 1 [T1]
* VBW 3 MHz -28.97 dBm
SWT 30 ms 3.517628205 GHz

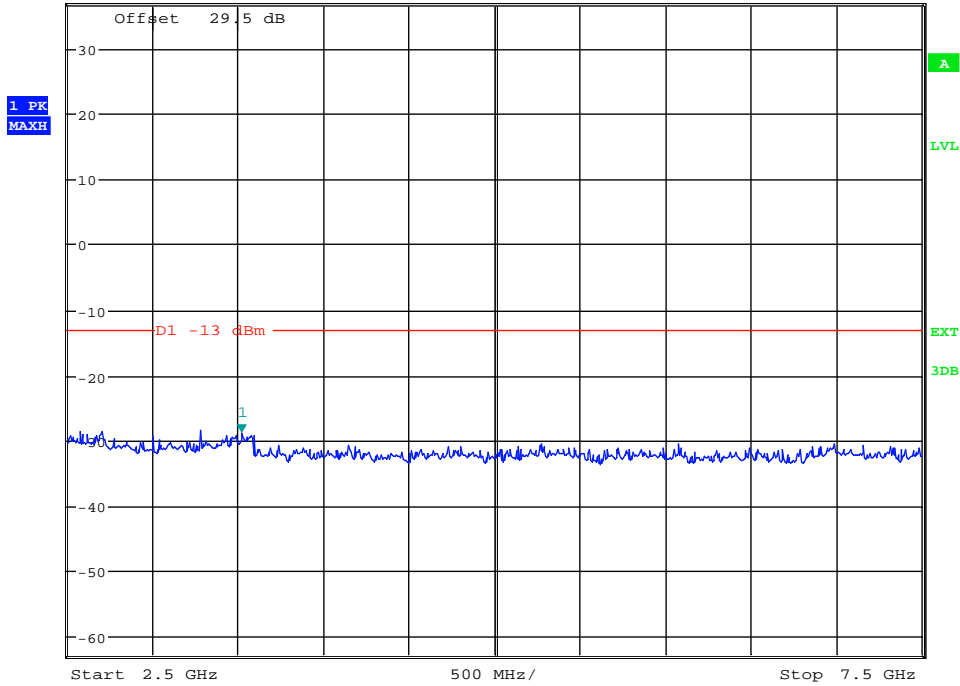

Date: 8.JAN.2014 13:48:21

(Plot 4.7.4 A3: Idle WCDMA Band II)



Ref 37 dBm * Att 20 dB * RBW 1 MHz Marker 1 [T1]
* VBW 3 MHz -30.27 dBm
SWT 20 ms 9.527243590 GHz

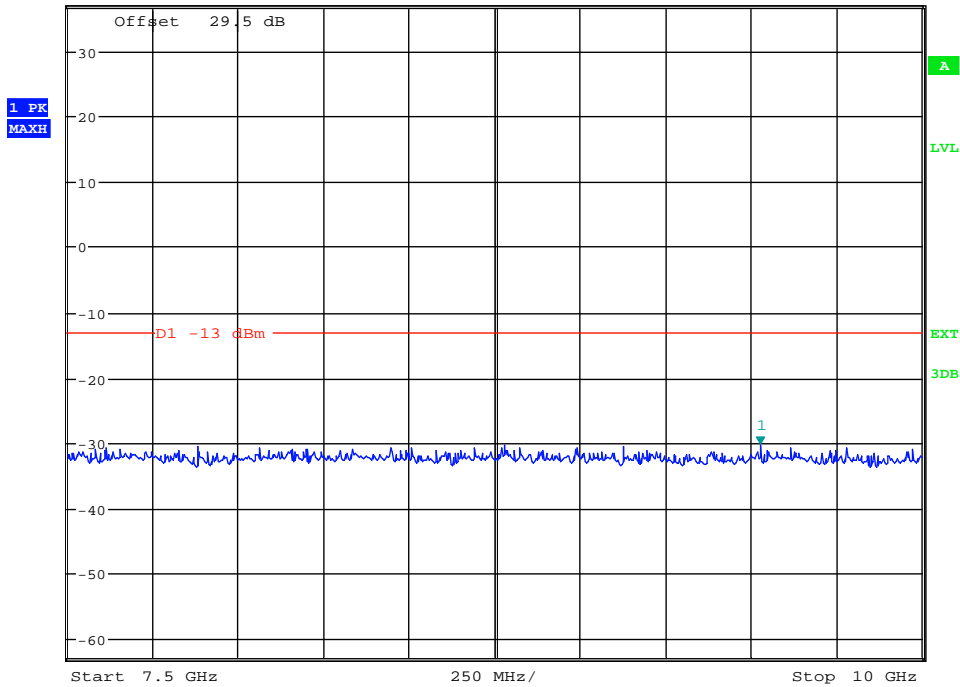

Date: 8.JAN.2014 13:47:20

(Plot 4.7.4 A4: Idle WCDMA Band II)



Ref 37 dBm * Att 20 dB * RBW 1 MHz Marker 1 [T1]
* VBW 3 MHz -30.58 dBm
SWT 30 ms 11.602564103 GHz

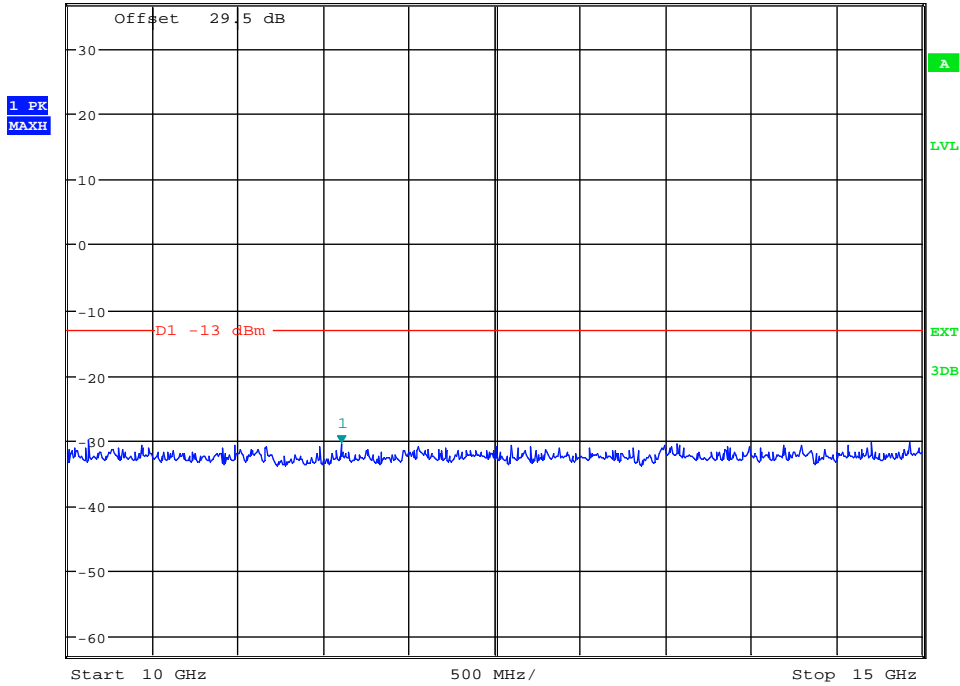

Date: 8.JAN.2014 13:48:42

(Plot 4.7.4 A5: Idle WCDMA Band II)



Ref 37 dBm * Att 20 dB * RBW 1 MHz Marker 1 [T1]
* VBW 3 MHz -28.34 dBm
SWT 30 ms 17.259615385 GHz

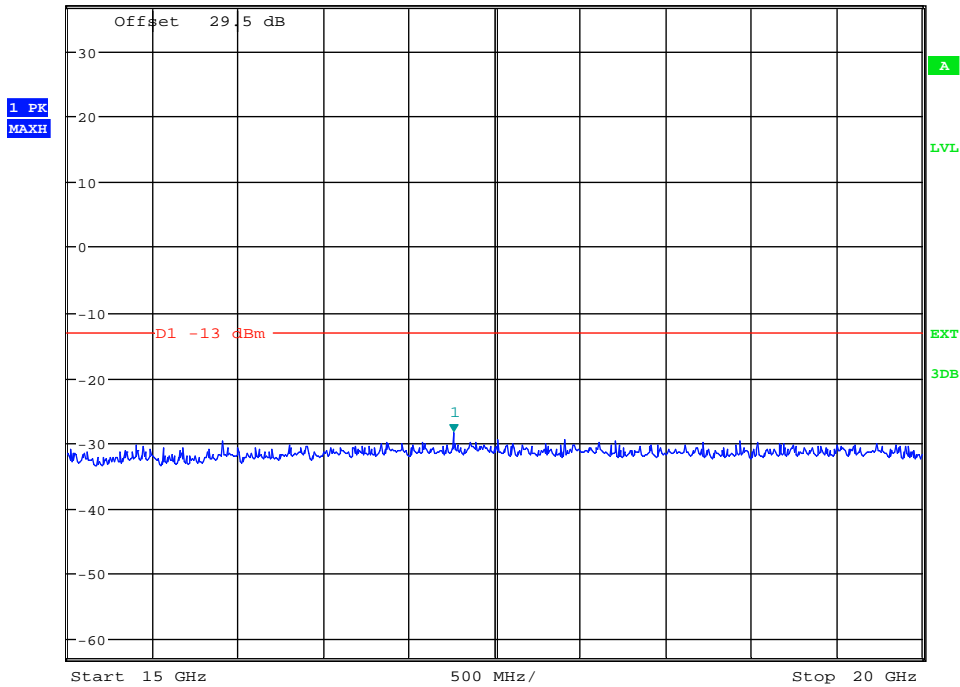

Date: 8.JAN.2014 13:49:03

(Plot 4.7.4 A6: Idle WCDMA Band II)

WCDMA Band V						
Channel Number: 4132		Test Frequency: 826.40 MHz			Test Mode: Traffic	
Start Frequency (MHz)	Stop Frequency (MHz)	Measurement Results		Limit (dBm)	Refer to Plot	Verdict
		Frequency (MHz)	Values (dBm)			
30	1000	***	***	-13.00	Plot 4.7.5 A1	PASS
1000	2500	2495.19	-37.61	-13.00	Plot 4.7.5 A2	PASS
2500	7500	3517.63	-35.68	-13.00	Plot 4.7.5 A3	PASS
7500	10000	9935.90	-38.27	-13.00	Plot 4.7.5 A4	PASS

WCDMA Band V						
Channel Number: 4183		Test Frequency: 836.60 MHz			Test Mode: Traffic	
Start Frequency (MHz)	Stop Frequency (MHz)	Measurement Results		Limit (dBm)	Refer to Plot	Verdict
		Frequency (MHz)	Values (dBm)			
30	1000	***	***	-13.00	Plot 4.7.6 A1	PASS
1000	2500	1716.35	-34.95	-13.00	Plot 4.7.6 A2	PASS
2500	7500	3592.95	-36.95	-13.00	Plot 4.7.6 A3	PASS
7500	10000	8088.94	-37.99	-13.00	Plot 4.7.6 A4	PASS

WCDMA Band V						
Channel Number: 4233		Test Frequency: 846.60 MHz			Test Mode: Traffic	
Start Frequency (MHz)	Stop Frequency (MHz)	Measurement Results		Limit (dBm)	Refer to Plot	Verdict
		Frequency (MHz)	Values (dBm)			
30	1000	***	***	-13.00	Plot 4.7.7 A1	PASS
1000	2500	2480.77	-32.68	-13.00	Plot 4.7.7 A2	PASS
2500	7500	3261.22	-36.09	-13.00	Plot 4.7.7 A3	PASS
7500	10000	8120.99	-38.11	-13.00	Plot 4.7.7 A4	PASS

WCDMA Band V						
Test Mode: Idle						
Start Frequency (MHz)	Stop Frequency (MHz)	Measurement Results		Limit (dBm)	Refer to Plot	Verdict
		Frequency (MHz)	Values (dBm)			
30	1000	951.81	-31.08	-13.00	Plot 4.7.8 A1	PASS
1000	2500	2497.60	-38.01	-13.00	Plot 4.7.8 A2	PASS
2500	7500	3589.74	-36.93	-13.00	Plot 4.7.8 A3	PASS
7500	10000	8125.00	-37.13	-13.00	Plot 4.7.8 A4	PASS

Note: 1. In general, the worse case attenuation requirement shown above was applied.

2. *** means that the emission level is too low to be measured or at least 20 dB down than the limit.



*RBW 1 MHz Marker 1 [T1]
*VBW 3 MHz 21.25 dBm
SWT 2.5 ms 825.897435897 MHz

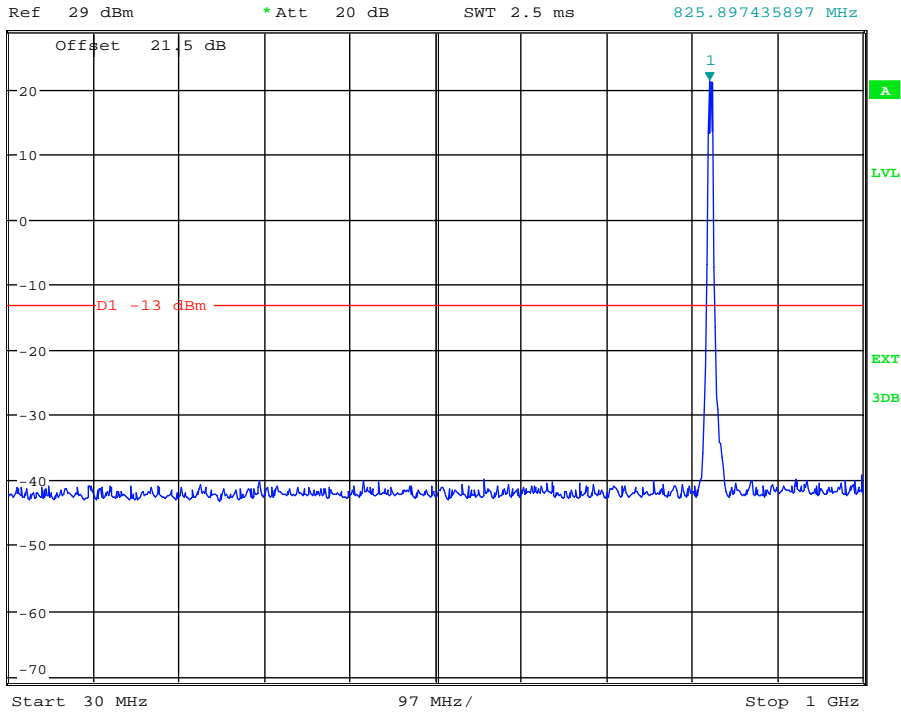

Date: 8.JAN.2014 14:16:08

(Plot 4.7.5 A1: Channel 4132: 826.40 MHz @ WCDMA Band V)



*RBW 1 MHz Marker 1 [T1]
*VBW 3 MHz -37.61 dBm
SWT 5 ms 2.495192308 GHz

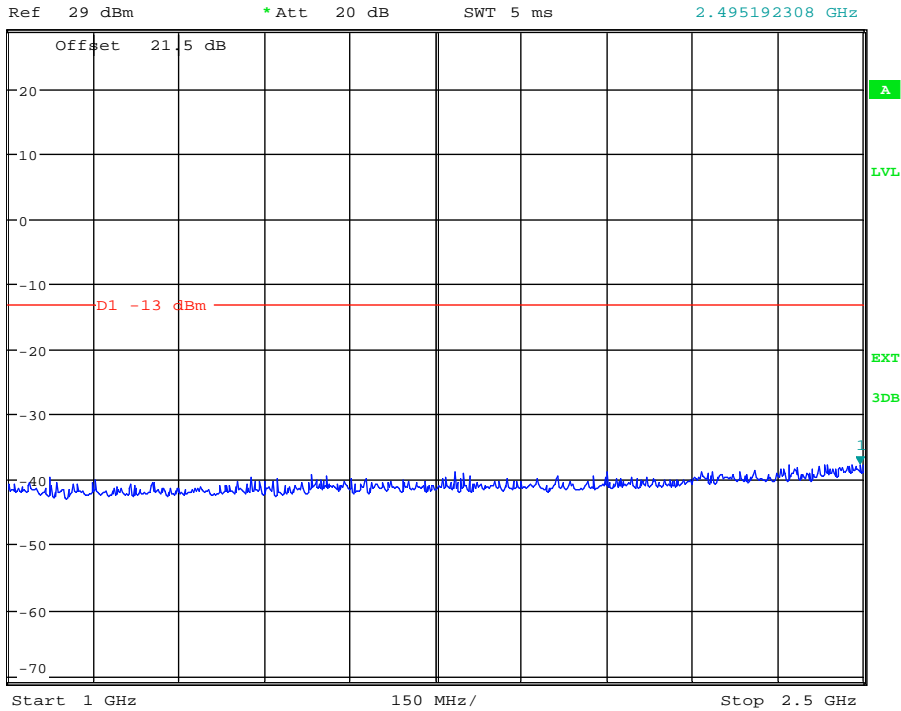

Date: 8.JAN.2014 14:16:28

(Plot 4.7.5 A2: Channel 4132: 826.40 MHz @ WCDMA Band V)



*RBW 1 MHz Marker 1 [T1]
*VBW 3 MHz -35.68 dBm
SWT 30 ms 3.517628205 GHz

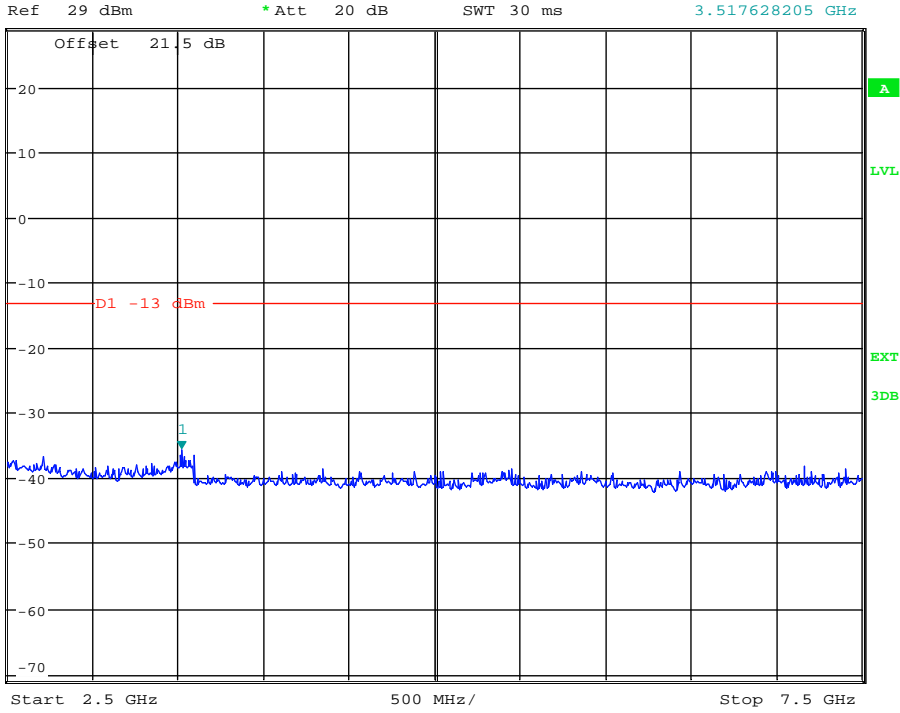

Date: 8.JAN.2014 14:16:44

(Plot 4.7.5 A3: Channel 4132: 826.40 MHz @ WCDMA Band V)



*RBW 1 MHz Marker 1 [T1]
*VBW 3 MHz -38.27 dBm
SWT 20 ms 9.935897436 GHz

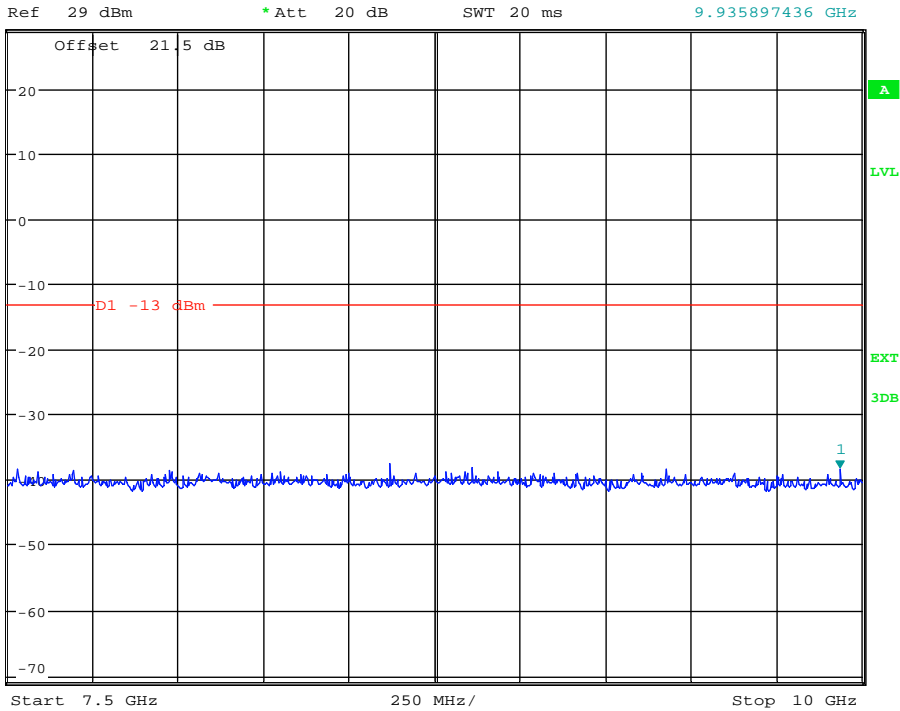

Date: 8.JAN.2014 14:17:03

(Plot 4.7.5 A4: Channel 4132: 826.40 MHz @ WCDMA Band V)



Ref 29 dBm * Att 20 dB * RBW 1 MHz Marker 1 [T1]
* VBW 3 MHz 20.89 dBm
SWT 2.5 ms 836.778846154 MHz

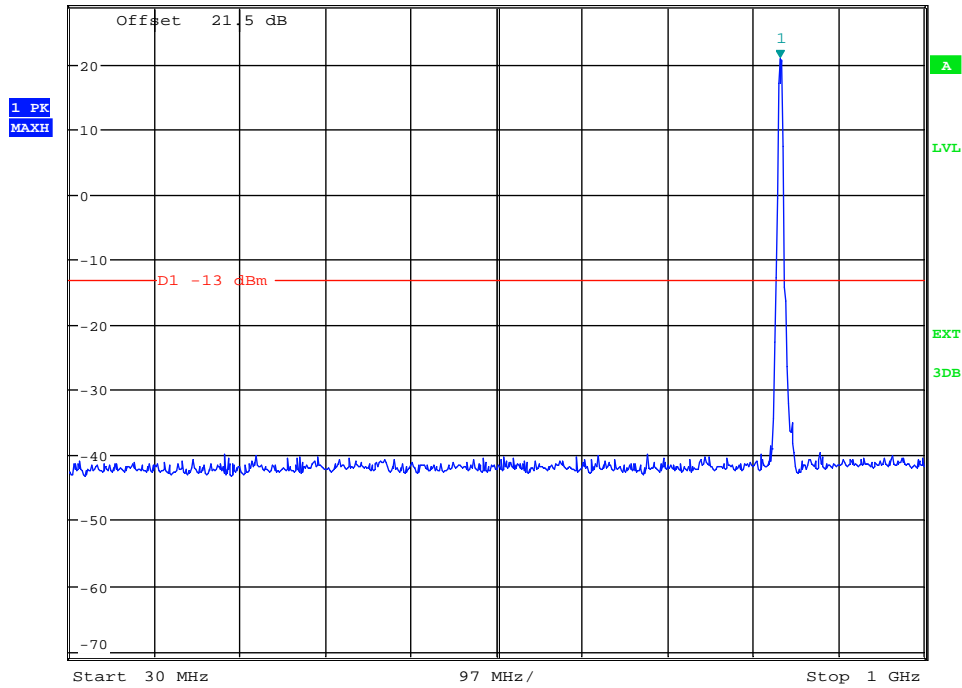

Date: 8.JAN.2014 14:17:42

(Plot 4.7.6 A1: Channel 4183: 836.60 MHz @ WCDMA Band V)



Ref 29 dBm * Att 20 dB * RBW 1 MHz Marker 1 [T1]
* VBW 3 MHz -34.95 dBm
SWT 5 ms 1.716346154 GHz

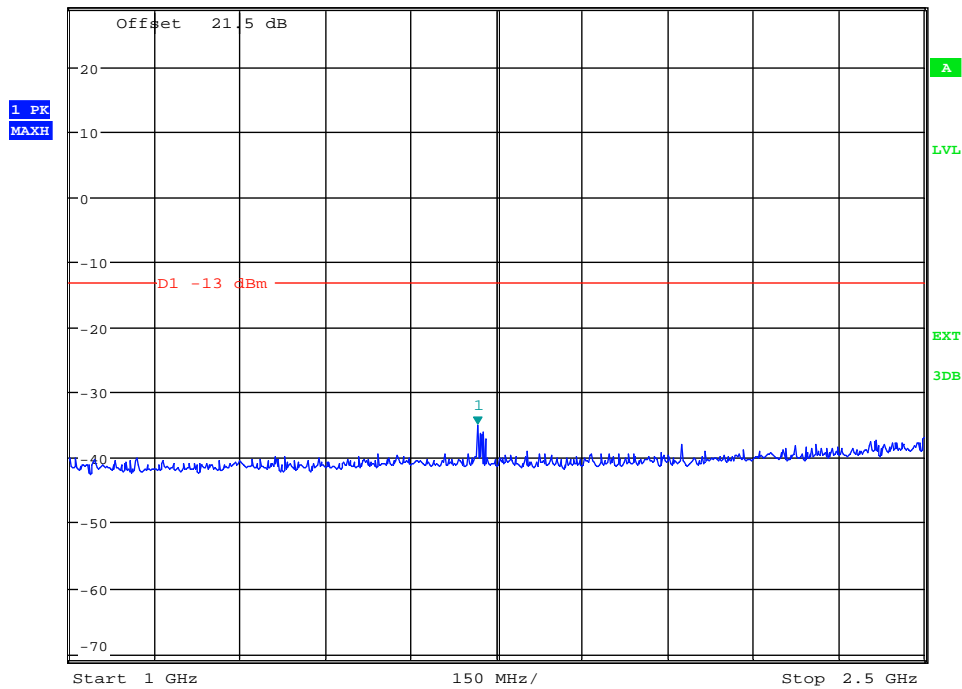

Date: 8.JAN.2014 14:18:10

(Plot 4.7.6 A2: Channel 4183: 836.60 MHz @ WCDMA Band V)



*RBW 1 MHz Marker 1 [T1]
*VBW 3 MHz -36.95 dBm
SWT 35 ms 3.592948718 GHz

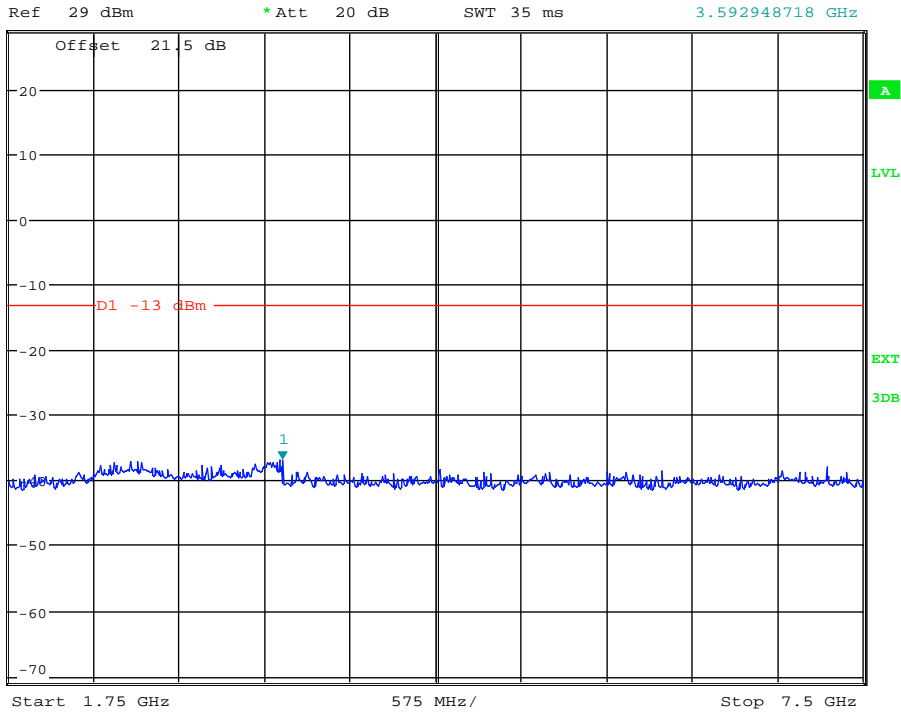

Date: 8.JAN.2014 14:18:32

(Plot 4.7.6 A3: Channel 4183: 836.60 MHz @ WCDMA Band V)



*RBW 1 MHz Marker 1 [T1]
*VBW 3 MHz -37.99 dBm
SWT 20 ms 8.088942308 GHz

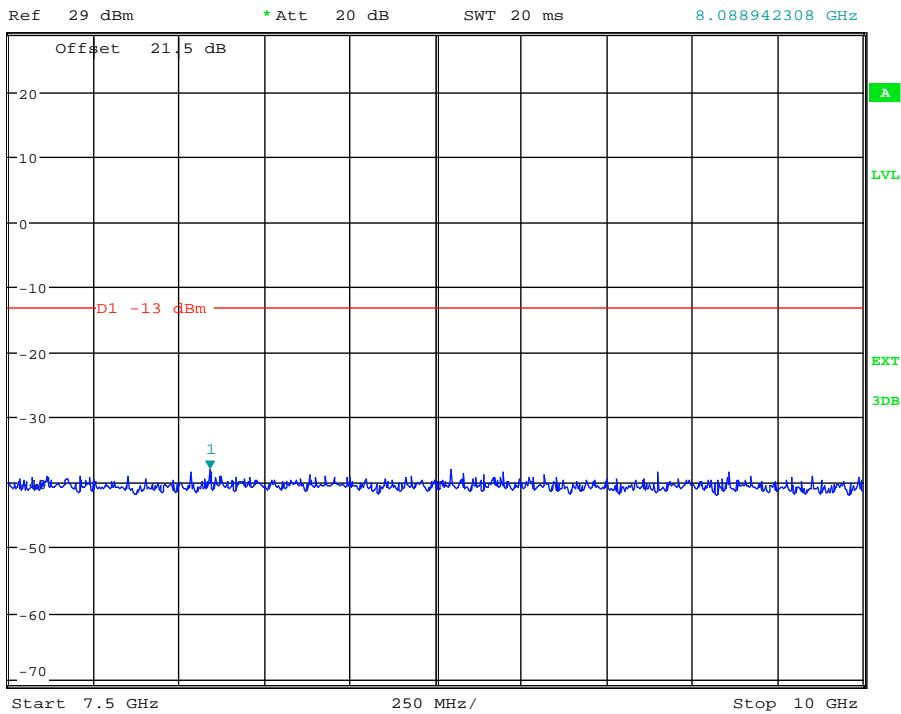

Date: 8.JAN.2014 14:18:56

(Plot 4.7.6 A4: Channel 4183: 836.60 MHz @ WCDMA Band V)



*RBW 1 MHz Marker 1 [T1]
*VBW 3 MHz 20.46 dBm
SWT 2.5 ms 846.105769231 MHz

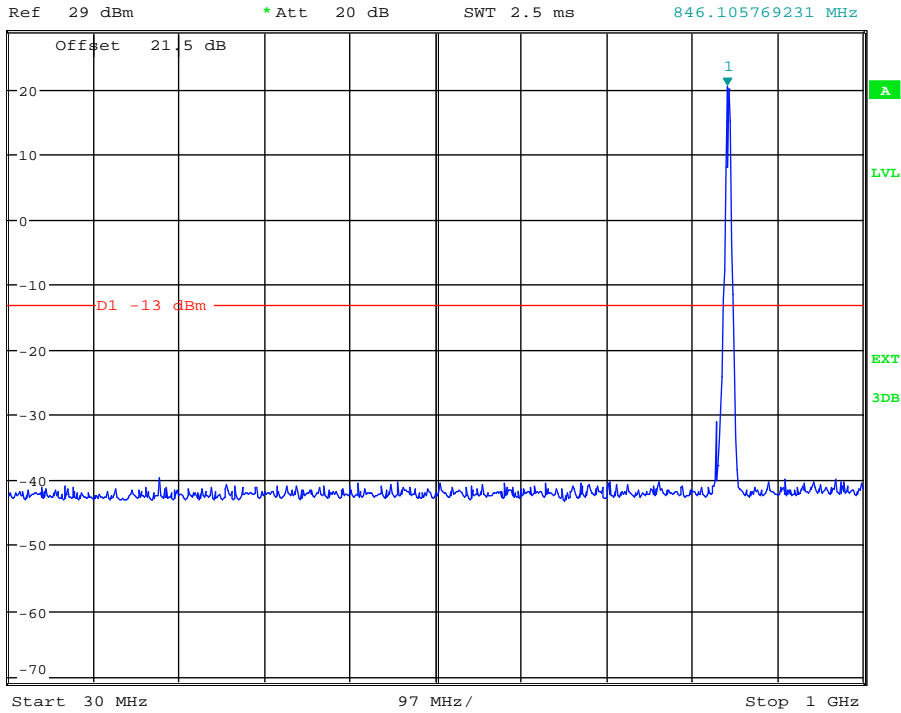

Date: 8.JAN.2014 14:19:26

(Plot 4.7.7 A1: Channel 4233: 846.60 MHz @ WCDMA Band V)



*RBW 1 MHz Marker 1 [T1]
*VBW 3 MHz -37.45 dBm
SWT 5 ms 2.480769231 GHz

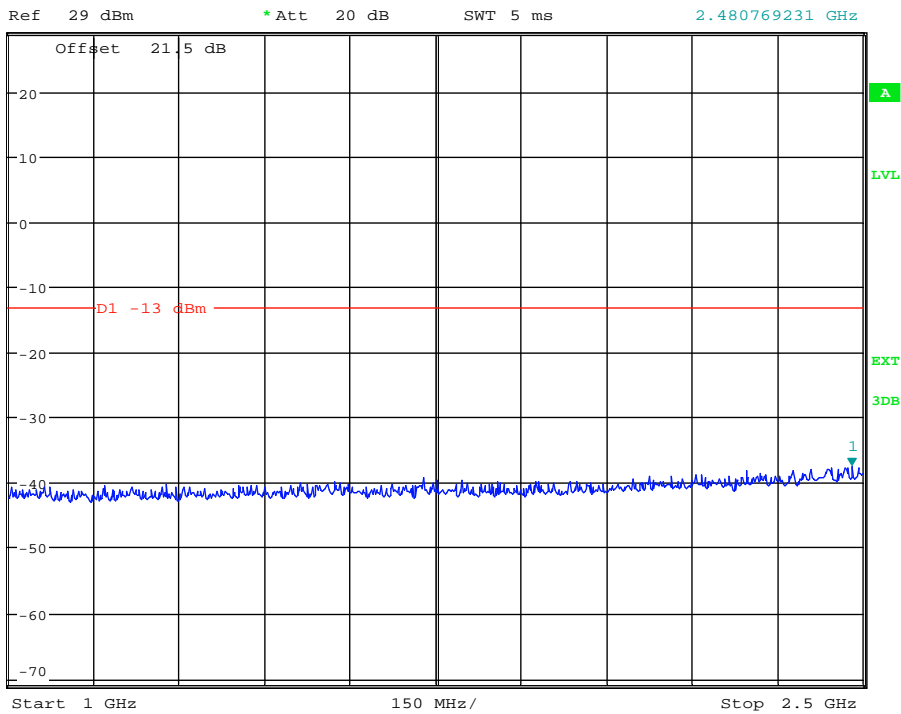

Date: 8.JAN.2014 14:19:44

(Plot 4.7.7 A2: Channel 4233: 846.60 MHz @ WCDMA Band V)



*RBW 1 MHz Marker 1 [T1]
*VBW 3 MHz -36.09 dBm
SWT 30 ms 3.261217949 GHz

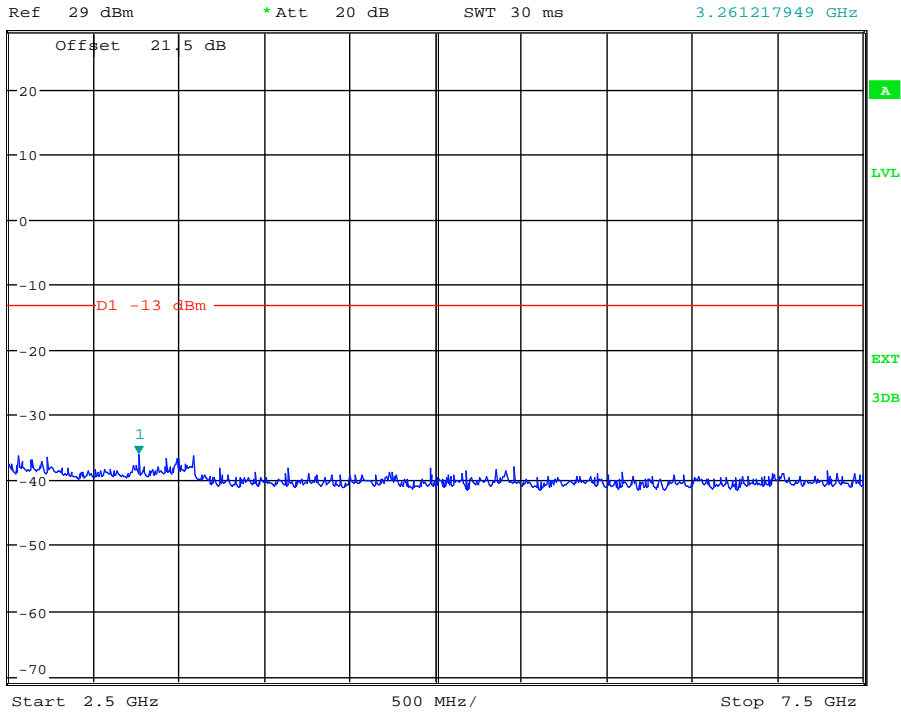

Date: 8.JAN.2014 14:20:01

(Plot 4.7.7 A3: Channel 4233: 846.60 MHz @ WCDMA Band V)



*RBW 1 MHz Marker 1 [T1]
*VBW 3 MHz -38.11 dBm
SWT 20 ms 8.120993590 GHz

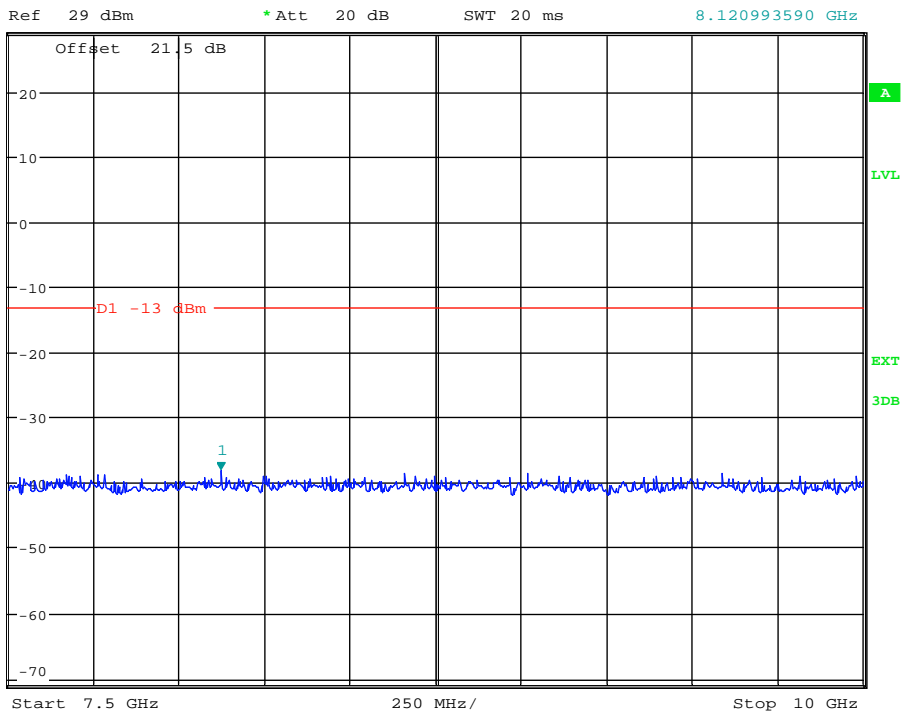

Date: 8.JAN.2014 14:20:21

(Plot 4.7.7 A4: Channel 4233: 846.60 MHz @ WCDMA Band V)

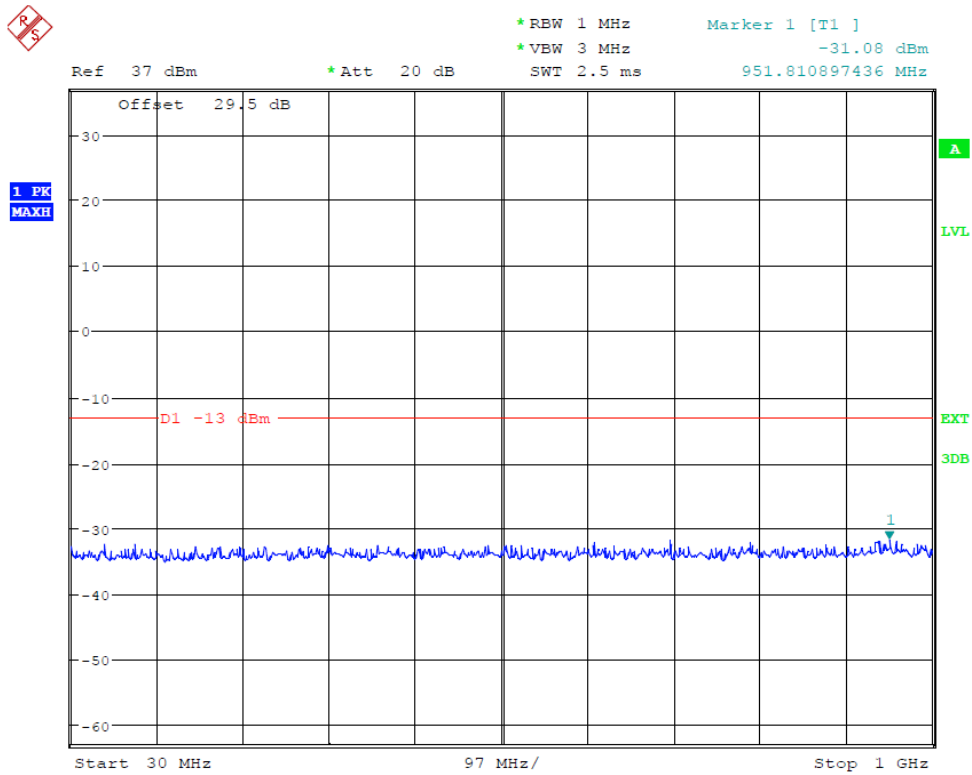

Date: 8.JAN.2014 19:47:28

(Plot 4.7.8 A1: Idle @ WCDMA Band V)

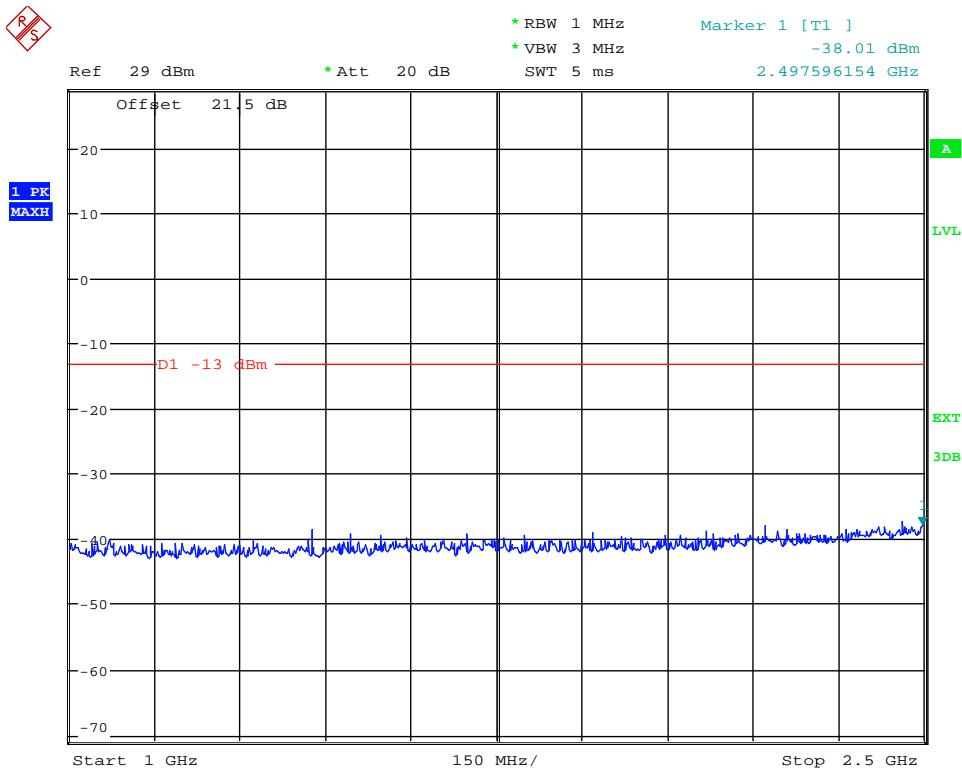

Date: 8.JAN.2014 14:21:32

(Plot 4.7.8 A2: Idle @ WCDMA Band V)



*RBW 1 MHz Marker 1 [T1]
*VBW 3 MHz -36.93 dBm
SWT 30 ms 3.589743590 GHz

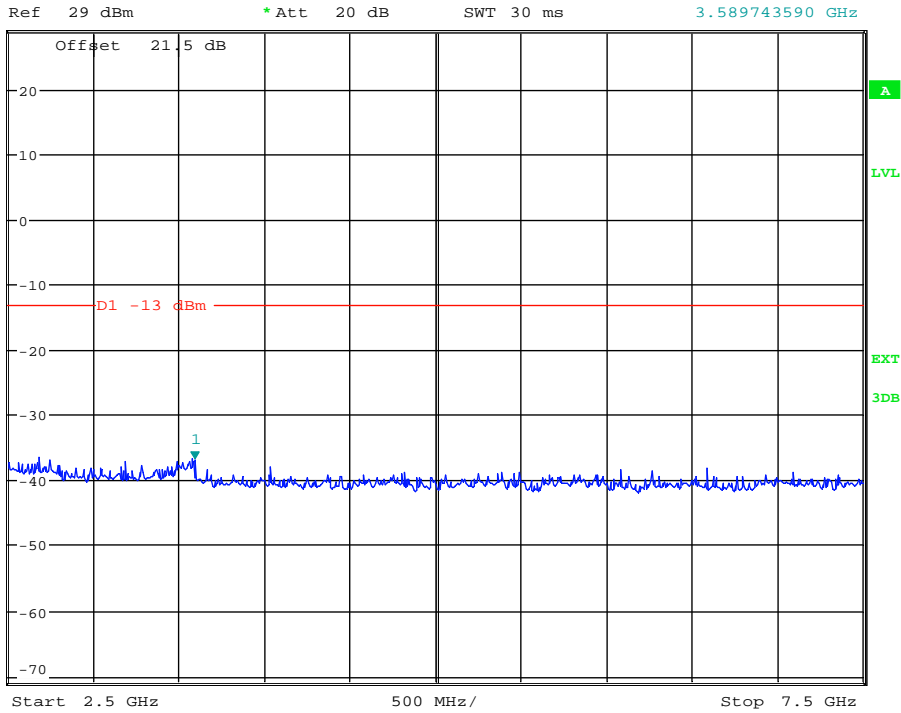

Date: 8.JAN.2014 14:21:49

(Plot 4.7.8 A3: Idle @ WCDMA Band V)



*RBW 1 MHz Marker 1 [T1]
*VBW 3 MHz -37.13 dBm
SWT 20 ms 8.125000000 GHz

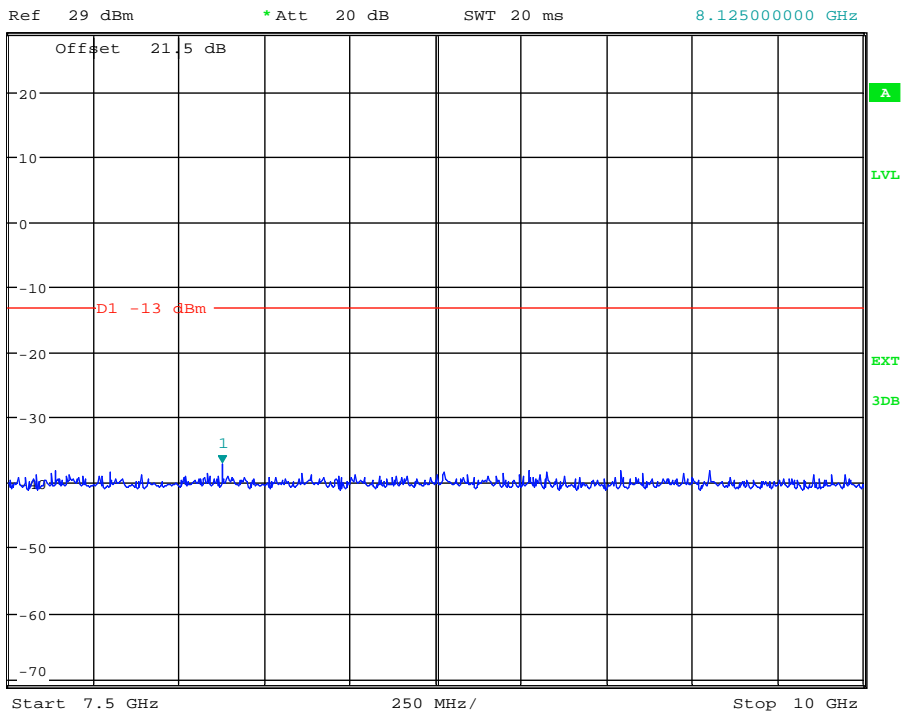

Date: 8.JAN.2014 14:20:55

(Plot 4.7.8 A4: Idle @ WCDMA Band V)

4.8. Frequency Stability Test

TEST APPLICABLE

1. According to FCC Part 2 Section 2.1055 (a)(1), the frequency stability shall be measured with variation of ambient temperature from -30°C to +50°C centigrade.
2. According to FCC Part 2 Section 2.1055 (a) (2), for battery powered equipment, the frequency stability shall be measured with reducing primary supply voltage to the battery operating end point, which is specified by the manufacture.
3. Vary primary supply voltage from 85 to 115 percent of the nominal value for other than hand carried voltage equipment and the end voltage point was 3.45V.

TEST PROCEDURE

In order to measure the carrier frequency under the condition of AFC lock, it is necessary to make measurements with the EUT in a "call mode". This is accomplished with the use of R&S CMU200 DIGITAL RADIO COMMUNICATION TESTER.

1. Measure the carrier frequency at room temperature;
2. Subject the EUT to overnight soak at -30°C;
3. With the EUT, powered via nominal voltage, connected to the CMU200 and in a simulated call on middle channel of PCS 94000 and WCDMA II, measure the carrier frequency. These measurements should be made within 2 minutes of Powering up the EUT, to prevent significant self-warming;
4. Repeat the above measurements at 10°C increments from -30°C to +50°C. Allow at least 0.5 hours at each temperature, unpowered, before making measurements;
5. Remeasure carrier frequency at room temperature with nominal voltage. Vary supply voltage from minimum voltage to maximum voltage, in 0.1Volt increments remeasuring carrier frequency at each voltage. Pause at nominal voltage for 0.5 hours unpowered, to allow any self-heating to stabilize, before continuing;
6. Subject the EUT to overnight soak at +50°C;
7. With the EUT, powered via nominal voltage, connected to the CMU200 and in a simulated call on the centre channel, measure the carrier frequency. These measurements should be made within 2 minutes of Powering up the EUT, to prevent significant self-warming;
8. Repeat the above measurements at 10°C increments from +50°C to -30°C. Allow at least 0.5 hours at each temperature, unpowered, before making measurements;
9. At all temperature levels hold the temperature to +/- 0.5°C during the measurement procedure;

TEST CONFIGURATION

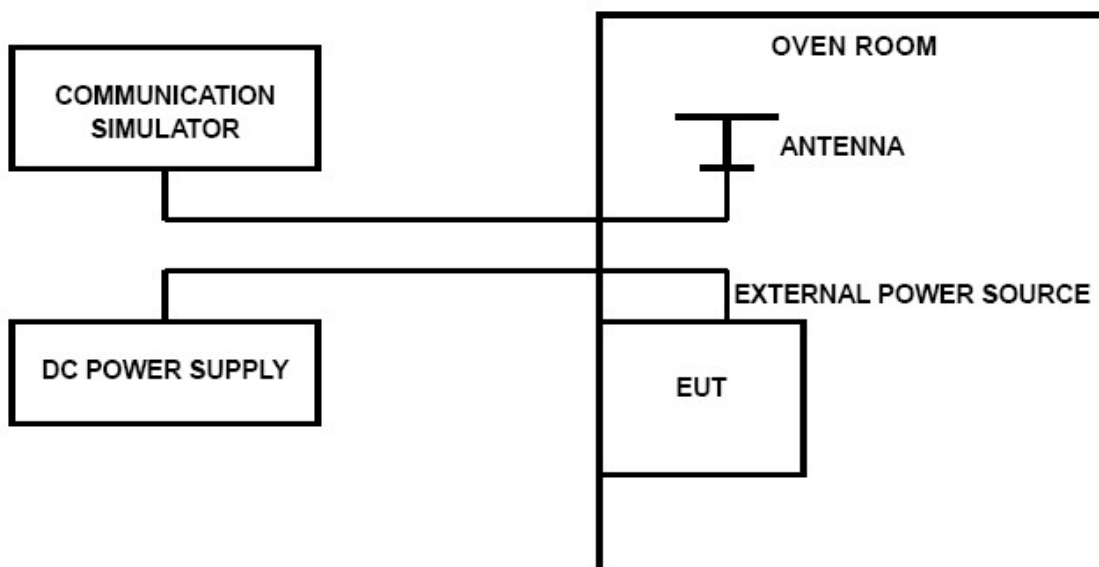

TEST LIMITS

For Hand carried battery powered equipment

According to the JTC standard the frequency stability of the carrier shall be accurate to within 0.1 ppm of the received frequency from the base station. This accuracy is sufficient to meet Sec. 24.235, Frequency Stability. The frequency stability shall be sufficient to ensure that the fundamental emission stays within the authorized

frequency block. As this transceiver is considered "Hand carried, battery powered equipment" Section 2.1055(d)(2) applies. This requires that the lower voltage for frequency stability testing be specified by the manufacturer. This transceiver is specified to operate with an input voltage of between 3.40VDC and 4.20VDC, with a nominal voltage of 3.70DC. Operation above or below these voltage limits is prohibited by transceiver software in order to prevent improper operation as well as to protect components from overstress. These voltages represent a tolerance of -10 % and +12.5 %. For the purposes of measuring frequency stability these voltage limits are to be used.

For equipment powered by primary supply voltage

According to the JTC standard the frequency stability of the carrier shall be accurate to within 0.1 ppm of the received frequency from the base station. This accuracy is sufficient to meet Sec. 24.235, Frequency Stability. The frequency stability shall be sufficient to ensure that the fundamental emission stays within the authorized frequency block. For this EUT section 2.1055(d)(1) applies. This requires varying primary supply voltage from 85 to 115 percent of the nominal value for other than hand carried battery equipment.

TEST RESULTS

WCDMA Band V					
DC Power	Temperature (°C)	Frequency error(Hz)	Frequency error(ppm)	Limit (ppm)	Verdict
3.40	25	37	0.044	0.10	PASS
3.70	25	-29	0.035	0.10	PASS
4.20	25	-22	0.026	0.10	PASS
3.70	-30	-21	0.025	0.10	PASS
3.70	-20	23	0.027	0.10	PASS
3.70	-10	-18	0.022	0.10	PASS
3.70	0	-24	0.029	0.10	PASS
3.70	10	-27	0.032	0.10	PASS
3.70	20	-26	0.031	0.10	PASS
3.70	30	24	0.029	0.10	PASS
3.70	40	-20	0.024	0.10	PASS
3.70	50	-19	0.023	0.10	PASS

WCDMA Band II					
DC Power	Temperature (°C)	Frequency error(Hz)	Frequency error(ppm)	Limit (ppm)	Verdict
3.40	20	-52	0.028	0.10	PASS
3.70	20	-50	0.027	0.10	PASS
4.20	20	47	0.025	0.10	PASS
3.70	-30	-37	0.020	0.10	PASS
3.70	-20	-43	0.023	0.10	PASS
3.70	-10	42	0.022	0.10	PASS
3.70	0	-48	0.026	0.10	PASS
3.70	10	-39	0.021	0.10	PASS
3.70	20	54	0.029	0.10	PASS
3.70	30	-47	0.025	0.10	PASS
3.70	40	-39	0.021	0.10	PASS
3.70	50	42	0.022	0.10	PASS

5. Test Setup Photos of the EUT

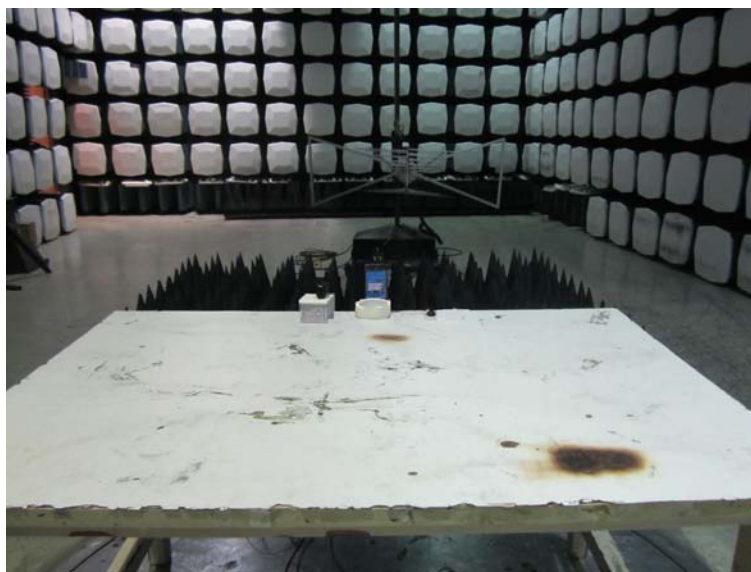



6. External and Internal Photos of the EUT

External photos of the EUT









Internal photos of the EUT

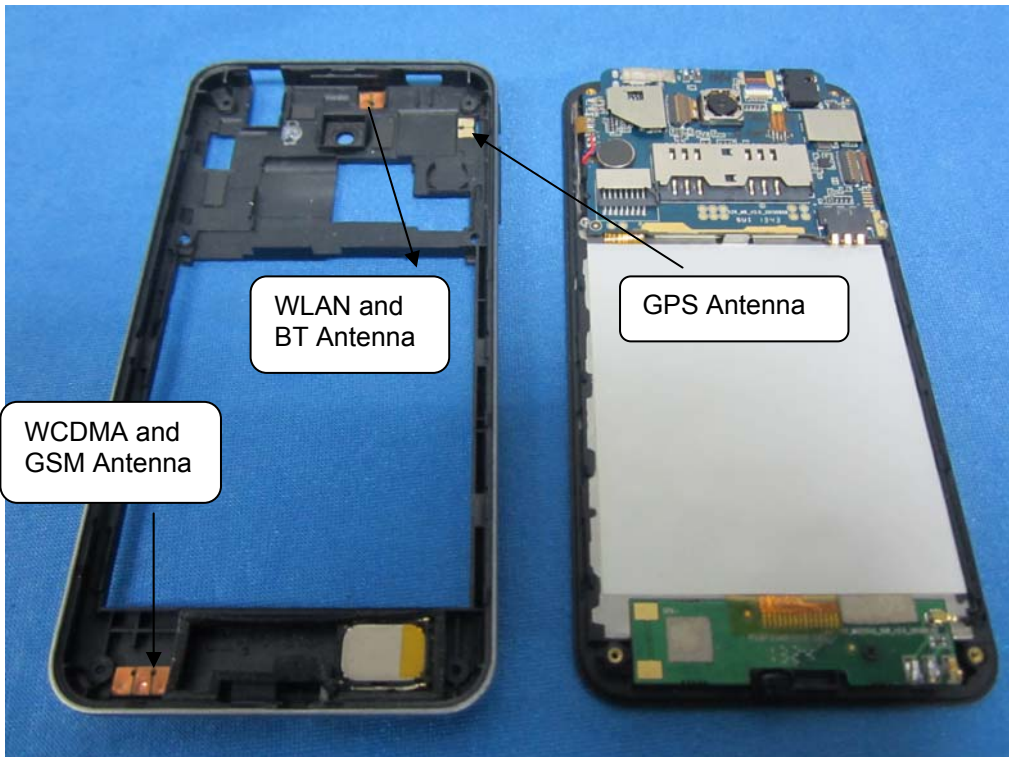



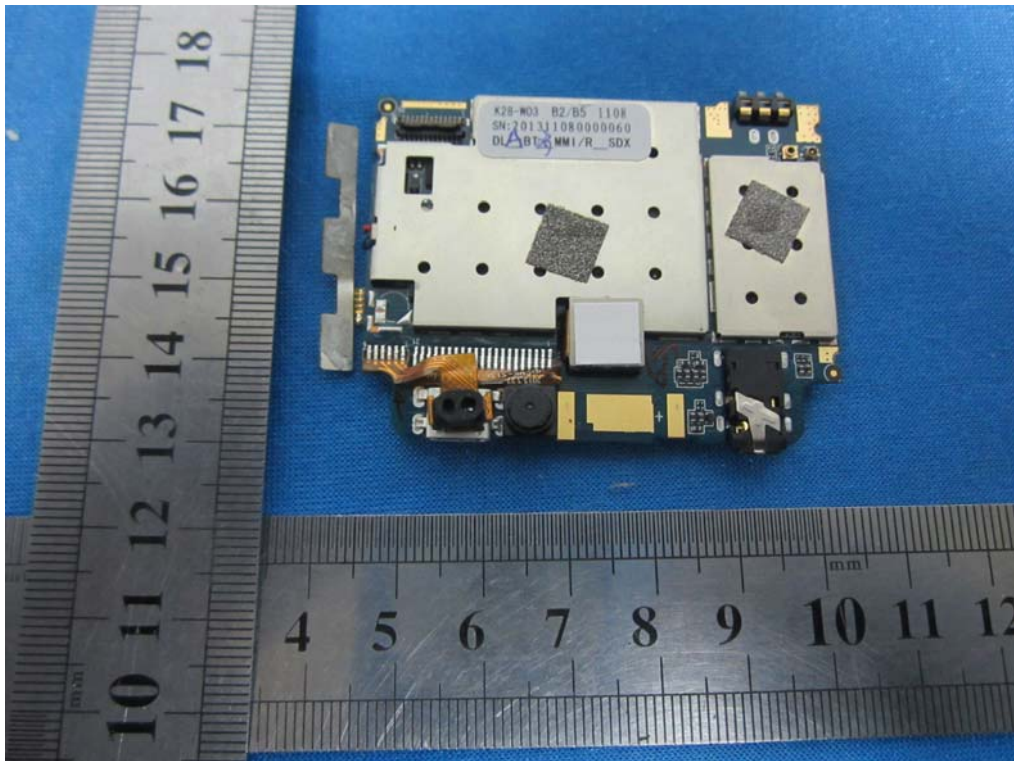
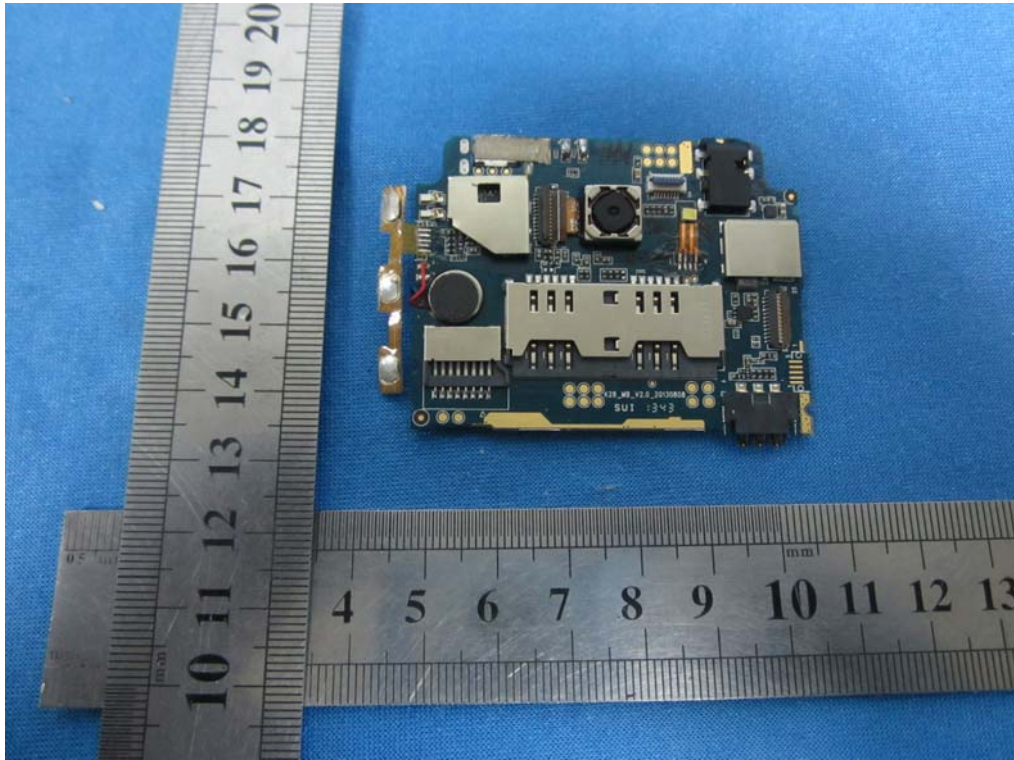

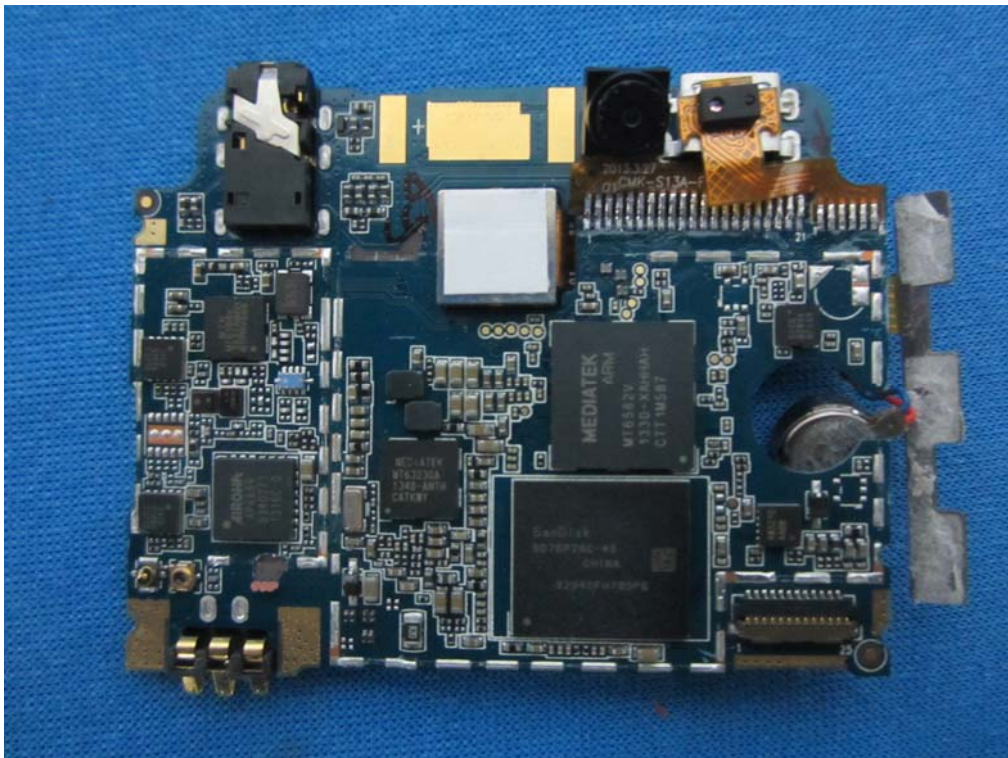
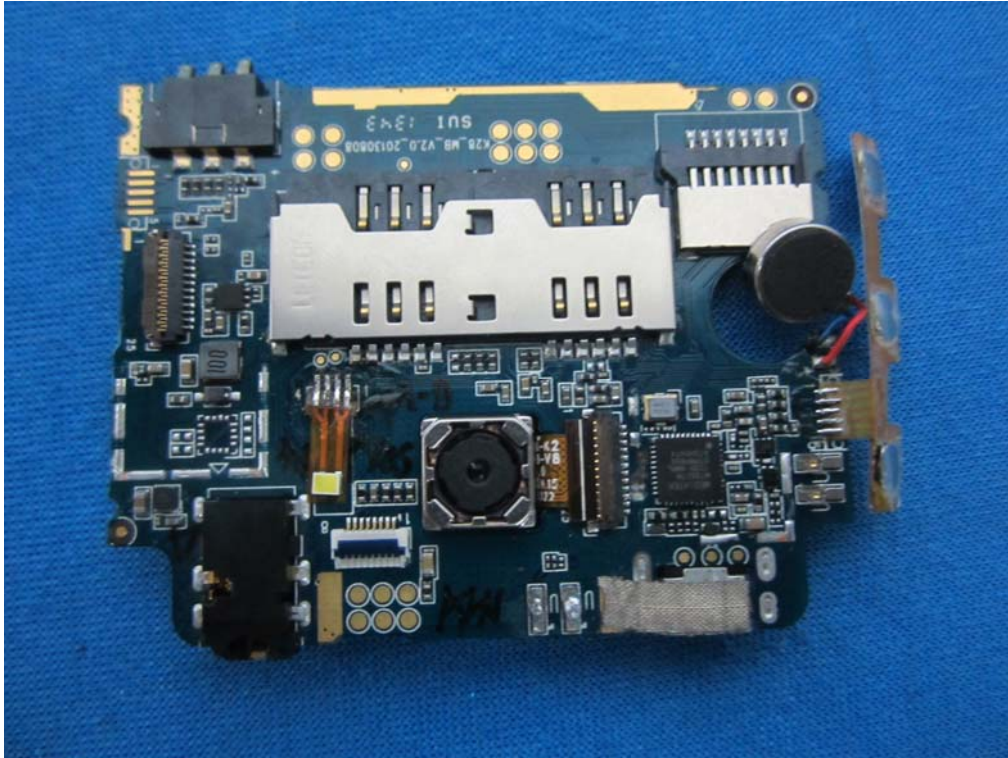

.....End of Report.....