

SAR EVALUATION REPORT

For

ITALCOM GROUP

1728 Coral Way, Coral Gables, Miami, Florida, United States

FCC ID: YPVITALCOMZENX2

| | |
|--|--------------------------------------|
| Report Type: Original Report | Product Type: Mobile Phone |
| Test Engineer: Sandy Wang | <i>Sandy Wang</i> |
| Report Number: RSZ120604003-20 | |
| Report Date: 2012-07-03 | |
| Reviewed By: Alvin Huang RF Leader | <i>Alvin Huang</i> |
| Test Laboratory: Bay Area Compliance Laboratories Corp. (Shenzhen) 6/F, the 3rd Phase of WanLi Industrial Building, ShiHua Road, FuTian Free Trade Zone Shenzhen, Guangdong, China Tel: +86-755-33320018 Fax: +86-755-33320008 www.baclcorp.com.cn | |

Note: This test report is prepared for the customer shown above and for the device described herein. It may not be duplicated or used in part without prior written consent from Bay Area Compliance Laboratories Corp. This report **must not** be used by the customer to claim product certification, approval, or endorsement by NVLAP or any agency of the Federal Government.

* This report contain data that are not covered by the NVLAP accreditation and are marked with an asterisk "★" (Rev.2)

| Attestation of Test Results | | |
|---|--|------------------------|
| EUT Information | Company Name | ITALCOM GROUP |
| | EUT Description | Mobile Phone |
| | FCC ID | YPVITALCOMZENX2 |
| | Model Number | zenx2 |
| | Test Date | 2012.07.29--2012.06.30 |
| Frequency | Max. SAR Level(s) Measured | Limit(W/Kg) |
| Cellular Band | 0.232 W/kg 1g Head Tissue 0.364 W/kg 1g Body Tissue | 1.6 |
| PCS Band | 0.160 W/kg 1g Head Tissue 0.195 W/kg 1g Body Tissue | |
| Applicable Standards | ANSI / IEEE C95.1 : 2005 IEEE Standard for Safety Levels with Respect to Human Exposure to Radio Frequency Electromagnetic Fields,3 kHz to 300 GHz. | |
| | ANSI / IEEE C95.3 : 2002 IEEE Recommended Practice for Measurements and Computations of Radio Frequency Electromagnetic Fields With Respect to Human Exposure to SuchFields,100 kHz—300 GHz. | |
| | OET BULLETIN 65 SUPPLEMENT C Evaluating Compliance with FCC Guidelines for Human Exposure To Radiofrequency Electromagnetic Fields | |
| | IEEE1528:2003 IEEE Recommended Practice for Determining the Peak Spatial-Average Specific Absorption Rate (SAR) in the Human Head from Wireless Communications Devices: Measurement Techniques | |
| <p>Note: This wireless device has been shown to be capable of compliance for localized specific absorption rate (SAR) for General Population/Uncontrolled Exposure limits specified in ANSI/IEEE Standards and has been tested in accordance with the measurement procedures specified in FCC OET 65 Supplement C and IEEE 1528-2003.</p> <p>The results and statements contained in this report pertain only to the device(s) evaluated.</p> | | |

TABLE OF CONTENTS

| | |
|--|-----------|
| DOCUMENT REVISION HISTORY | 4 |
| EUT DESCRIPTION | 5 |
| TECHNICAL SPECIFICATION | 5 |
| REFERENCE, STANDARDS, AND GUIDELINES | 6 |
| SAR LIMITS | 7 |
| FACILITIES AND ACCREDITATION | 8 |
| DESCRIPTION OF TEST SYSTEM | 9 |
| EQUIPMENT LIST AND CALIBRATION | 16 |
| EQUIPMENTS LIST & CALIBRATION INFORMATION | 16 |
| SAR MEASUREMENT SYSTEM VERIFICATION | 17 |
| LIQUID VERIFICATION | 17 |
| SYSTEM ACCURACY VERIFICATION | 20 |
| SAR SYSTEM VALIDATION DATA | 21 |
| EUT TEST STRATEGY AND METHODOLOGY | 29 |
| TEST POSITIONS FOR DEVICE OPERATING NEXT TO A PERSON’S EAR | 29 |
| CHEEK/TOUCH POSITION | 30 |
| EAR/TILT POSITION | 30 |
| TEST POSITIONS FOR BODY-WORN AND OTHER CONFIGURATIONS | 31 |
| SAR EVALUATION PROCEDURE | 32 |
| CONDUCTED OUTPUT POWER MEASUREMENT | 33 |
| PROVISION APPLICABLE | 33 |
| TEST PROCEDURE | 33 |
| TEST RESULTS: | 33 |
| SAR MEASUREMENT RESULTS | 35 |
| EUT SCAN RESULTS | 38 |
| APPENDIX A – MEASUREMENT UNCERTAINTY | 54 |
| APPENDIX B – PROBE CALIBRATION CERTIFICATES | 55 |
| APPENDIX C – DIPOLE CALIBRATION CERTIFICATES | 65 |
| APPENDIX D – EUT TEST POSITION PHOTOS | 83 |
| LIQUID DEPTH \geq 15CM | 83 |
| BODY-WORN-HEADSET SETUP PHOTO | 83 |
| LEFT HEAD TOUCH SETUP PHOTO | 84 |
| LEFT HEAD TILT SETUP PHOTO | 84 |
| RIGHT HEAD TOUCH SETUP PHOTO | 85 |
| RIGHT HEAD TILT SETUP PHOTO | 85 |
| APPENDIX E – EUT PHOTOS | 86 |
| EUT – FRONT SIDE VIEW | 86 |
| EUT – BACK SIDE VIEW | 86 |
| EUT – UNCOVERED VIEW | 87 |
| EUT-HEADSET VIEW | 87 |
| APPENDIX G – INFORMATIVE REFERENCES | 88 |

DOCUMENT REVISION HISTORY

| Revision Number | Report Number | Description of Revision | Date of Revision |
|------------------------|----------------------|--------------------------------|-------------------------|
| 0 | RSZ120604003-20 | Original Report | 2012-07-03 |

EUT DESCRIPTION

This report has been prepared on behalf of ITALCOM GROUP and their product, FCC ID: YPVITALCOMZENX2, Model: zenx2 or the EUT (Equipment Under Test) as referred to in the rest of this report. The EUT is a Mobile phone.

Technical Specification

| | |
|-------------------------------|---|
| Product Type | Portable |
| Exposure Category: | Population / Uncontrolled |
| Antenna Type(s): | Internal Antenna |
| Body-Worn Accessories: | Headset |
| Face-Head Accessories: | None |
| Multi-slot Class: | Class 10 |
| Operation Mode : | GSM Voice and GPRS Data |
| Frequency Band: | Cellular Band: 824-849 MHz(TX); 869-894 MHz(RX) PCS Band: 1850-1910 MHz(TX); 1930-1990 MHz(RX) |
| Conducted RF Power: | Cellular Band : 32.20dBm PCS Band : 29.35dBm |
| Dimensions (L*W*H): | 100mm (L)× 45.0mm (W)× 15mm (H) |
| Weight: | 60g |
| Power Source: | 3.7VDC |
| Normal Operation: | Head and Body-worn |

REFERENCE, STANDARDS, AND GUIDELINES

FCC:

The Report and Order requires routine SAR evaluation prior to equipment authorization of portable transmitter devices, including portable telephones. For consumer products, the applicable limit is 1.6 mW/g as recommended by the ANSI/IEEE standard C95.1-1992 [6] for an uncontrolled environment (Paragraph 65). According to the Supplement C of OET Bulletin 65 "Evaluating Compliance with FCC Guide-lines for Human Exposure to Radio frequency Electromagnetic Fields", released on Jun 29, 2001 by the FCC, the device should be evaluated at maximum output power (radiated from the antenna) under "worst-case" conditions for normal or intended use, incorporating normal antenna operating positions, device peak performance frequencies and positions for maximum RF energy coupling.

This report describes the methodology and results of experiments performed on wireless data terminal. The objective was to determine if there is RF radiation and if radiation is found, what is the extent of radiation with respect to safety limits. SAR (Specific Absorption Rate) is the measure of RF exposure determined by the amount of RF energy absorbed by human body (or its parts) – to determine how the RF energy couples to the body or head which is a primary health concern for body worn devices. The limit below which the exposure to RF is considered safe by regulatory bodies in North America is 1.6 mW/g average over 1 gram of tissue mass.

CE:

The order requires routine SAR evaluation prior to equipment authorization of portable transmitter devices, including portable telephones. For consumer products, the applicable limit is 2 mW/g as recommended by EN62209-1 for an uncontrolled environment. According to the Standard, the device should be evaluated at maximum output power (radiated from the antenna) under "worst-case" conditions for normal or intended use, incorporating normal antenna operating positions, device peak performance frequencies and positions for maximum RF energy coupling.

This report describes the methodology and results of experiments performed on wireless data terminal. The objective was to determine if there is RF radiation and if radiation is found, what is the extent of radiation with respect to safety limits. SAR (Specific Absorption Rate) is the measure of RF exposure determined by the amount of RF energy absorbed by human body (or its parts) – to determine how the RF energy couples to the body or head which is a primary health concern for body worn devices. The limit below which the exposure to RF is considered safe by regulatory bodies in Europe is 2 mW/g average over 10 gram of tissue mass.

The test configurations were laid out on a specially designed test fixture to ensure the reproducibility of measurements. Each configuration was scanned for SAR. Analysis of each scan was carried out to characterize the above effects in the device.

SAR Limits

FCC Limit (1g Tissue)

| EXPOSURE LIMITS | SAR (W/kg) | |
|--|--|--|
| | (General Population / Uncontrolled Exposure Environment) | (Occupational / Controlled Exposure Environment) |
| Spatial Average (averaged over the whole body) | 0.08 | 0.4 |
| Spatial Peak (averaged over any 1 g of tissue) | 1.60 | 8.0 |
| Spatial Peak (hands/wrists/feet/ankles averaged over 10 g) | 4.0 | 20.0 |

CE Limit (10g Tissue)

| EXPOSURE LIMITS | SAR (W/kg) | |
|--|--|--|
| | (General Population / Uncontrolled Exposure Environment) | (Occupational / Controlled Exposure Environment) |
| Spatial Average (averaged over the whole body) | 0.08 | 0.4 |
| Spatial Peak (averaged over any 10 g of tissue) | 2.0 | 10 |
| Spatial Peak (hands/wrists/feet/ankles averaged over 10 g) | 4.0 | 20.0 |

Population/Uncontrolled Environments are defined as locations where there is the exposure of individual who have no knowledge or control of their exposure.

Occupational/Controlled Environments are defined as locations where there is exposure that may be incurred by people who are aware of the potential for exposure (i.e. as a result of employment or occupation).

General Population/Uncontrolled environments Spatial Peak limit 1.6W/kg (FCC) & 2 W/kg (CE) applied to the EUT.

FACILITIES AND ACCREDITATION

The test site used by Bay Area Compliance Laboratories Corp. (Shenzhen) to collect data is located at 6/F, the 3rd Phase of WanLi Industrial Building, Shi Hua Road, Fu Tian Free Trade Zone, Shenzhen, Guangdong, P.R. of China

Additionally, Bay Area Compliance Laboratories Corp. (Shenzhen) is a National Institute of Standards and Technology (NIST) accredited laboratory, under the National Voluntary Laboratory Accredited Program (Lab Code 200707-0).



The current scope of accreditations can be found at <http://ts.nist.gov/Standards/scopes/2007070.htm>

DESCRIPTION OF TEST SYSTEM

These measurements were performed with ALSAS 10 Universal Integrated SAR Measurement system from APREL Laboratories.

ALSAS-10U System Description

ALSAS-10-U is fully compliant with the technical and scientific requirements of IEEE 1528, IEC 62209, CENELEC, ARIB, ACA, and the Federal Communications Commission. The system comprises of a six axes articulated robot which utilizes a dedicated controller. ALSAS-10U uses the latest methodologies. And FDTD modeling to provide a platform which is repeatable with minimum uncertainty.

Applications

Predefined measurement procedures compliant with the guidelines of CENELEC, IEEE, IEC, FCC, etc are utilized during the assessment for the device. Automatic detection for all SAR maxima are embedded within the core architecture for the system, ensuring that peak locations used for centering the zoom scan are within a 1mm resolution and a 0.05mm repeatable position. System operation range currently available up-to 6 GHz in simulated tissue.

Area Scans

Area scans are defined prior to the measurement process being executed with a user defined variable spacing between each measurement point (integral) allowing low uncertainty measurements to be conducted. Scans defined for FCC applications utilize a 10mm² step integral, with 1mm interpolation used to locate the peak SAR area used for zoom scan assessments.

Where the system identifies multiple SAR peaks (which are within 25% of peak value) the system will provide the user with the option of assessing each peak location individually for zoom scan averaging.

Zoom Scan (Cube Scan Averaging)

The averaging zoom scan volume utilized in the ALSAS-10U software is in the shape of a cube and the side dimension of a 1 g or 10 g mass is dependent on the density of the liquid representing the simulated tissue. A density of 1000 kg/m³ is used to represent the head and body tissue density and not the phantom liquid density, in order to be consistent with the definition of the liquid dielectric properties, i.e. the side length of the 1 g cube is 10mm, with the side length of the 10 g cube 21,5mm.

When the cube intersects with the surface of the phantom, it is oriented so that 3 vertices touch the surface of the shell or the center of a face is tangent to the surface. The face of the cube closest to the surface is modified in order to conform to the tangent surface.

The zoom scan integer steps can be user defined so as to reduce uncertainty, but normal practice for typical test applications (including FCC) utilize a physical step of 5x5x8 (8mmx8mmx5mm) providing a volume of 32mm³ in the X & Y axis, and 35mm in the Z axis.



ALSAS-10U Interpolation and Extrapolation Uncertainty

The overall uncertainty for the methodology and algorithms the used during the SAR calculation was evaluated using the data from IEEE 1528 based on the example f3 algorithm:

$$f_3(x, y, z) = A \frac{a^2}{\frac{a^2}{4} + x'^2 + y'^2} \cdot \left(e^{-\frac{2z}{a}} + \frac{a^2}{2(a + 2z)^2} \right)$$

Isotropic E-Field Probe

The isotropic E-Field probe has been fully calibrated and assessed for isotropicity, and boundary effect within a controlled environment. Depending on the frequency for which the probe is calibrated the method utilized for calibration will change.

The E-Field probe utilizes a triangular sensor arrangement as detailed in the diagram below:

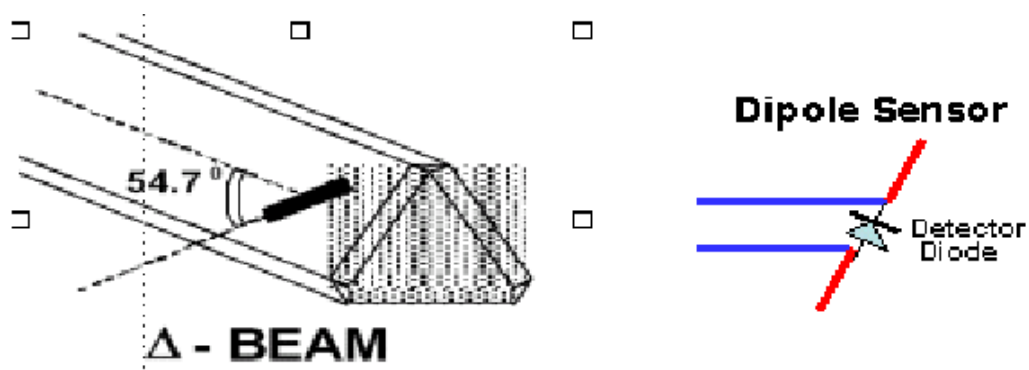

SAR is assessed with a calibrated probe which moves at a default height of 5mm from the center of the diode, which is mounted to the sensor, to the phantom surface (in the Z Axis). The 5mm offset height has been selected so as to minimize any resultant boundary effect due to the probe being in close proximity to the phantom surface.

The following algorithm is an example of the function used by the system for linearization of the output from the probe when measuring complex modulation schemes.

$$V_i = U_i + U_i^2 \cdot \frac{cf}{dcp_i}$$

Isotropic E-Field Probe Specification

| | |
|--------------------------------------|---|
| Calibration Method | Frequency Dependent Below 1 GHz Calibration in air performed in a TEM Cell Above 1 GHz Calibration in air performed in waveguide |
| Sensitivity | 0.70 $\mu\text{V}/(\text{V}/\text{m})^2$ to 0.85 $\mu\text{V}/(\text{V}/\text{m})^2$ |
| Dynamic Range | 0.0005 W/kg to 100 W/kg |
| Isotropic Response | Better than 0.1 dB |
| Diode Compression Point (DCP) | Calibration for Specific Frequency |
| Probe Tip Diameter | < 2.9 mm |
| Sensor Offset | 1.56 (+/- 0.02 mm) |
| Probe Length | 289 mm |
| Video Bandwidth | @ 500 Hz: 1 dB @ 1.02 kHz: 3 dB |
| Boundary Effect | Less than 2.1% for distance greater than 0.58 mm |
| Spatial Resolution | The spatial resolution uncertainty is less than 1.5% for 4.9mm diameter probe. The spatial resolution uncertainty is less than 1.0% for 2.5mm diameter probe |

Boundary Detection Unit and Probe Mounting Device

ALSAS-10U incorporates a boundary detection unit with a sensitivity of 0.05mm for detecting all types of surfaces. The robust design allows for detection during probe tilt (probe normalize) exercises, and utilizes a second stage emergency stop. The signal electronics are fed directly into the robot controller for high accuracy surface detection in lateral and axial detection modes (X, Y, & Z).

The probe is mounted directly onto the Boundary Detection unit for accurate tooling and displacement calculations controlled by the robot kinematics. The probe is connect to an isolated probe interconnect where the output stage of the probe is fed directly into the amplifier stage of the Daq-Paq.

Daq-Paq (Analog to Digital Electronics)

ALSAS-10U incorporates a fully calibrated Daq-Paq (analog to digital conversion system) which has a 4 channel input stage, sent via a 2 stage auto-set amplifier module. The input signal is amplified accordingly so as to offer a dynamic range from 5 μV to 800mV. Integration of the fields measured is carried out at board level utilizing a Co-Processor which then sends the measured fields down into the main computational module in digitized form via an RS232 communications port. Probe linearity and duty cycle compensation is carried out within the main Daq-Paq module.

| | |
|---------------------------------|---|
| ADC | 12 Bit |
| Amplifier Range | 20 mV to 200 mV and 150 mV to 800 mV |
| Field Integration | Local Co-Processor utilizing proprietary integration algorithms |
| Number of Input Channels | 4 in total 3 dedicated and 1 spare |
| Communication | Packet data via RS232 |

Axis Articulated Robot

ALSAS-10U utilizes a six axis articulated robot, which is controlled using a Pentium based real-time movement controller. The movement kinematics engine utilizes proprietary (Thermo CRS) interpolation and extrapolation algorithms, which allow full freedom of movement for each of the six joints within the working envelope. Utilization of joint 6 allows for full probe rotation with a tolerance better than 0.05mm around the central axis.



| | |
|--------------------------------------|-----------------------------------|
| Robot/Controller Manufacturer | Thermo CRS |
| Number of Axis | Six independently controlled axis |
| Positioning Repeatability | 0.05 mm |
| Controller Type | Single phase Pentium based C500C |
| Robot Reach | 710 mm |
| Communication | RS232 and LAN compatible |

ALSAS Universal Workstation

ALSAS Universal workstation allows for repeatability and fast adaptability. It allows users to do calibration, testing and measurements using different types of phantoms with one set up, which significantly speeds up the measurement process.

Universal Device Positioner

The universal device positioner allows complete freedom of movement of the EUT. Developed to hold a EUT in a free-space scenario any additional loading attributable to the material used in the construction of the positioner has been eliminated. Repeatability has been enhanced through the linear scales which form the design used to indicate positioning for any given test scenario in all major axes. A 15° tilt indicator is included for the of aid cheek to tilt movements for head SAR analysis. Overall uncertainty for measurements have been reduced due to the design of the Universal device positioner, which allows positioning of a device in as near to a free-space scenario as possible, and by providing the means for complete repeatability.



Phantom Types

The ALSAS-10U allows the integration of multiple phantom types. SAM Phantoms fully compliant with IEEE 1528, Universal Phantom, and Universal Flat.

APREL SAM Phantoms

The SAM phantoms developed using the IEEE SAM CAD file. They are fully compliant with the requirements for both IEEE 1528 and FCC Supplement C. Both the left and right SAM phantoms are interchangeable, transparent and include the IEEE 1528 grid with visible NF and MB lines.

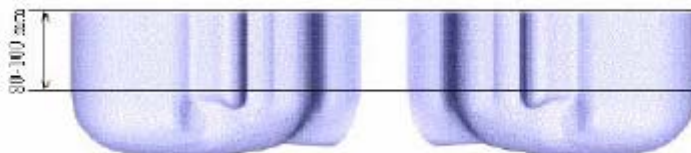

APREL Laboratories Universal Phantom

The Universal Phantom is used on the ALSAS-10U as a system validation phantom. The Universal Phantom has been fully validated both experimentally from 800MHz to 6GHz and numerically using XFDTD numerical software.

The shell thickness is 2mm overall, with a 4mm spacer located at the NF/MB intersection providing an overall thickness of 6mm in line with the requirements of IEEE-1528.

The design allows for fast and accurate measurements, of handsets, by allowing the conservative SAR to be evaluated at on frequency for both left and right head experiments in one measurement.



Tissue Dielectric Parameters for Head and Body Phantoms

The head tissue dielectric parameters recommended by the IEEE SCC-34/SC-2 in P1528 have been incorporated in the following table. These head parameters are derived from planar layer models simulating the highest expected SAR for the dielectric properties and tissue thickness variations in a human head. Other head and body tissue parameters that have not been specified in P1528 are derived from the tissue dielectric parameters computed from the 4-Cole-Cole equations described in Reference [12] and extrapolated according to the head parameters specified in P1528.

| Ingredients (% by weight) | Frequency (MHz) | | | | | | | | | |
|------------------------------|-----------------|-------|-------|------|-------|-------|-------|------|------|------|
| | 450 | | 835 | | 915 | | 1900 | | 2450 | |
| Tissue Type | Head | Body | Head | Body | Head | Body | Head | Body | Head | Body |
| Water | 38.56 | 51.16 | 41.45 | 52.4 | 41.05 | 56.0 | 54.9 | 40.4 | 62.7 | 73.2 |
| Salt (Nacl) | 3.95 | 1.49 | 1.45 | 1.4 | 1.35 | 0.76 | 0.18 | 0.5 | 0.5 | 0.04 |
| Sugar | 56.32 | 46.78 | 56.0 | 45.0 | 56.5 | 41.76 | 0.0 | 58.0 | 0.0 | 0.0 |
| HEC | 0.98 | 0.52 | 1.0 | 1.0 | 1.0 | 1.21 | 0.0 | 1.0 | 0.0 | 0.0 |
| Bactericide | 0.19 | 0.05 | 0.1 | 0.1 | 0.1 | 0.27 | 0.0 | 0.1 | 0.0 | 0.0 |
| Triton x-100 | 0.0 | 0.0 | 0.0 | 0.0 | 0.0 | 0.0 | 0.0 | 0.0 | 36.8 | 0.0 |
| DGBE | 0.0 | 0.0 | 0.0 | 0.0 | 0.0 | 0.0 | 44.92 | 0.0 | 0.0 | 26.7 |
| Dielectric Constant | 43.42 | 58.0 | 42.54 | 56.1 | 42.0 | 56.8 | 39.9 | 54.0 | 39.8 | 52.5 |
| Conductivity (s/m) | 0.85 | 0.83 | 0.91 | 0.95 | 1.0 | 1.07 | 1.42 | 1.45 | 1.88 | 1.78 |

Recommended Tissue Dielectric Parameters for Head and Body

| Frequency (MHz) | Head Tissue | | Body Tissue | |
|--------------------|--------------|----------------|--------------|----------------|
| | ϵ_r | σ (S/m) | ϵ_r | σ (S/m) |
| 150 | 52.3 | 0.76 | 61.9 | 0.80 |
| 300 | 45.3 | 0.87 | 58.2 | 0.92 |
| 450 | 43.5 | 0.87 | 56.7 | 0.94 |
| 835 | 41.5 | 0.90 | 55.2 | 0.97 |
| 900 | 41.5 | 0.97 | 55.0 | 1.05 |
| 915 | 41.5 | 0.98 | 55.0 | 1.06 |
| 1450 | 40.5 | 1.20 | 54.0 | 1.30 |
| 1610 | 40.3 | 1.29 | 53.8 | 1.40 |
| 1800-2000 | 40.0 | 1.40 | 53.3 | 1.52 |
| 2450 | 39.2 | 1.80 | 52.7 | 1.95 |
| 3000 | 38.5 | 2.40 | 52.0 | 2.73 |
| 5800 | 35.3 | 5.27 | 48.2 | 6.00 |

EQUIPMENT LIST AND CALIBRATION

Equipments List & Calibration Information

| Equipment | Model | Calibration Date | S/N |
|--|----------------|------------------|--------------|
| CRS F3 robot | ALS-F3 | N/A | RAF0805352 |
| CRS F3 Software | ALS-F3-SW | N/A | N/A |
| CRS C500C controller | ALS-C500 | N/A | RCF0805379 |
| Probe mounting device & Boundary Detection Sensor System | ALS-PMDPS-3 | N/A | 120-00270 |
| Universal Work Station | ALS-UWS | N/A | 100-00157 |
| Data Acquisition Package | ALS-DAQ-PAQ-3 | 2012-05-13 | 110-00212 |
| Miniature E-Field Probe | ALS-E-020 | 2011-07-14 | 500-00283 |
| Dipole, 835MHz | ALS-D-835-S-2 | 2011-08-25 | 180-00558 |
| Dipole, 1900MHz | ALS-D-1900-S-2 | 2011-08-25 | 210-00710 |
| Dipole Spacer | ALS-DS-U | N/A | 250-00907 |
| Device holder/Positioner | ALS-H-E-SET-2 | N/A | 170-00510 |
| Left ear SAM phantom | ALS-P-SAM-L | N/A | 130-00311 |
| Right ear SAM phantom | ALS-P-SAM-R | N/A | 140-00359 |
| UniPhantom | ALS-P-UP-1 | N/A | 150-00413 |
| Simulated Tissue 835 MHz Head | ALS-TS-835-H | Each Time | 270-01002 |
| Simulated Tissue 835 MHz Body | ALS-TS-835-B | Each Time | 270-02101 |
| Simulated Tissue 1900 MHz Head | ALS-TS-1900-H | Each Time | 295-01103 |
| Simulated Tissue 1900 MHz Body | ALS-TS-1900-B | Each Time | 295-02102 |
| Power Amplifier | 5S1G4 | N/A | 71377 |
| Synthesized Sweeper | HP 8341B | 2012-05-17 | 2624A00116 |
| UNIVERSAL RADIO COMMUNICATION TESTER | CMU 200 | 2011.12.16 | 1100.0008.02 |
| EMI Test Receiver | ESCI | 2011-11-17 | 101122 |

SAR MEASUREMENT SYSTEM VERIFICATION

Liquid Verification

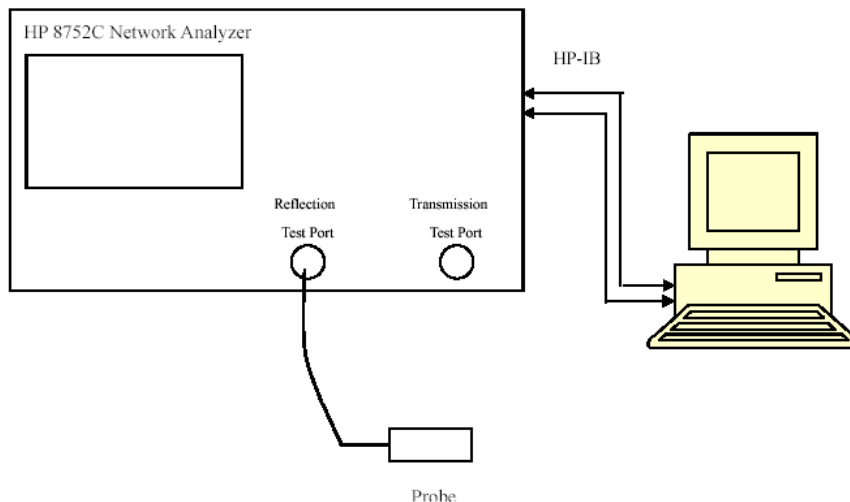

Liquid Verification Setup Block Diagram

Liquid Verification Results

| Frequency Band | Liquid Type | Liquid Parameter | | Target Value | | Delta (%) | | Tolerance (%) |
|----------------|-------------|------------------|----------------|--------------|----------------|-----------|-------|---------------|
| | | ϵ_r | σ (S/m) | ϵ_r | σ (S/m) | | | |
| 835 | Head | 42.32 | 0.92 | 41.50 | 0.90 | 1.976 | 2.221 | ±5 |
| 835 | Body | 56.15 | 0.98 | 55.20 | 0.97 | 1.721 | 1.031 | ±5 |
| 1900 | Head | 41.52 | 1.42 | 40.00 | 1.40 | 3.800 | 1.428 | ±5 |
| 1900 | Body | 54.16 | 1.54 | 55.30 | 1.53 | -2.061 | 0.654 | ±5 |

*Liquid Verification was performed on 2012.06.29

Please refer to the following tables.

| 850 MHz Head | | | | 1900 MHz Head | | |
|-----------------|-----------|----------|--|-----------------|-----------|-----------|
| Frequency (MHz) | e' | e'' | | Frequency (MHz) | e' | e'' |
| 824.0 | 41.152586 | 19.59966 | | 1850.0 | 40.591255 | 13.492921 |
| 824.5 | 41.161621 | 19.61012 | | 1851.2 | 40.471574 | 13.499256 |
| 825.0 | 41.173698 | 19.62058 | | 1852.4 | 40.484023 | 13.505591 |
| 825.5 | 41.182584 | 19.63104 | | 1853.6 | 40.496472 | 13.511926 |
| 826.0 | 41.195458 | 19.64151 | | 1854.8 | 40.408921 | 13.518261 |
| 826.5 | 41.205874 | 19.65196 | | 1856.0 | 41.402882 | 13.524596 |
| 827.0 | 41.215796 | 19.66242 | | 1857.2 | 41.484475 | 13.530931 |
| 827.5 | 41.219698 | 19.67288 | | 1858.4 | 41.472758 | 13.537266 |
| 828.0 | 41.221245 | 19.68334 | | 1859.6 | 41.468622 | 13.543601 |
| 828.5 | 41.228689 | 19.69380 | | 1860.8 | 41.453560 | 13.549936 |
| 829.0 | 41.232593 | 19.70426 | | 1862.0 | 41.442110 | 13.556271 |
| 829.5 | 41.236475 | 19.71472 | | 1863.2 | 41.430661 | 13.562606 |
| 830.0 | 41.245663 | 19.72518 | | 1864.4 | 41.419211 | 13.562941 |
| 830.5 | 41.248453 | 19.73564 | | 1865.6 | 41.407761 | 13.563276 |
| 831.0 | 42.251654 | 19.74601 | | 1866.8 | 41.496312 | 13.563611 |
| 831.5 | 42.258958 | 19.75656 | | 1868.0 | 41.484862 | 13.563946 |
| 832.0 | 42.264689 | 19.76702 | | 1869.2 | 41.473412 | 13.564281 |
| 832.5 | 42.266844 | 19.77748 | | 1870.4 | 41.461962 | 13.564616 |
| 833.0 | 42.278455 | 19.78794 | | 1871.6 | 41.526459 | 13.564951 |
| 833.5 | 42.285247 | 19.79814 | | 1872.8 | 41.526159 | 13.569286 |
| 834.0 | 42.298565 | 19.80886 | | 1874.0 | 41.525859 | 13.573621 |
| 834.5 | 42.318526 | 19.81232 | | 1875.2 | 41.525559 | 13.581956 |
| 835.0 | 42.320586 | 19.81643 | | 1876.4 | 41.525259 | 13.582291 |
| 835.5 | 42.331795 | 19.82004 | | 1877.6 | 41.524959 | 13.582626 |
| 836.0 | 42.342564 | 19.83103 | | 1878.8 | 41.524659 | 13.582961 |
| 836.5 | 42.355344 | 19.83056 | | 1880.0 | 41.524359 | 13.584876 |
| 837.0 | 42.362545 | 19.83082 | | 1881.2 | 41.524059 | 13.583631 |
| 837.5 | 42.376845 | 19.83108 | | 1882.4 | 41.523759 | 13.583966 |
| 838.0 | 42.382654 | 19.83134 | | 1883.6 | 41.523459 | 13.584301 |
| 838.5 | 42.392574 | 19.83126 | | 1884.8 | 41.523159 | 13.584636 |
| 839.0 | 42.406248 | 19.83186 | | 1886.0 | 41.522859 | 13.584971 |
| 839.5 | 42.412147 | 19.83212 | | 1887.2 | 41.522559 | 13.585306 |
| 840.0 | 42.425895 | 19.83238 | | 1888.4 | 41.522259 | 13.585641 |
| 840.5 | 42.439545 | 19.83264 | | 1889.6 | 41.521959 | 13.585976 |
| 841.0 | 42.448745 | 19.83219 | | 1890.8 | 41.521659 | 13.586311 |
| 841.5 | 42.455456 | 19.83316 | | 1892.0 | 41.521359 | 13.586646 |
| 842.0 | 42.464556 | 19.83342 | | 1893.2 | 41.521059 | 13.586981 |
| 842.5 | 42.478654 | 19.83368 | | 1894.4 | 41.520759 | 13.587316 |
| 843.0 | 42.485245 | 19.83394 | | 1895.6 | 41.520459 | 13.587651 |
| 843.5 | 42.491547 | 19.83042 | | 1896.8 | 41.520159 | 13.587986 |
| 844.0 | 42.250596 | 19.83446 | | 1898.0 | 41.519859 | 13.588321 |
| 844.5 | 42.251597 | 19.83472 | | 1899.2 | 41.519559 | 13.588656 |
| 845.0 | 42.252987 | 19.83498 | | 1900.4 | 41.512589 | 13.588991 |
| 845.5 | 42.532587 | 19.83524 | | 1901.6 | 41.518959 | 13.589326 |
| 846.0 | 42.545221 | 19.83055 | | 1902.8 | 41.518659 | 13.589661 |
| 846.5 | 42.552051 | 19.83576 | | 1904.0 | 41.518359 | 13.589996 |
| 847.0 | 42.561423 | 19.83602 | | 1905.2 | 41.518059 | 13.590331 |
| 847.5 | 42.572587 | 19.83628 | | 1906.4 | 41.517759 | 13.590666 |
| 848.0 | 42.585587 | 19.83654 | | 1907.6 | 41.517459 | 13.591001 |
| 848.5 | 42.595896 | 19.83618 | | 1908.8 | 41.517159 | 13.591336 |
| 849.0 | 42.605253 | 19.83706 | | 1910.0 | 41.516859 | 13.591671 |

| 850 MHz Body | | | | 1900 MHz Body | | |
|-----------------|----------|----------|--|-----------------|----------|----------|
| Frequency (MHz) | e' | e'' | | Frequency (MHz) | e' | e'' |
| 824.0 | 55.60437 | 21.24266 | | 1850.0 | 54.03112 | 14.58439 |
| 824.5 | 55.57807 | 21.25128 | | 1851.2 | 54.01707 | 14.58697 |
| 825.0 | 55.56659 | 21.20544 | | 1852.4 | 54.04197 | 14.58955 |
| 825.5 | 55.50297 | 21.28247 | | 1853.6 | 53.99153 | 14.59213 |
| 826.0 | 55.48754 | 21.21452 | | 1854.8 | 54.00806 | 14.59471 |
| 826.5 | 55.57523 | 21.25887 | | 1856.0 | 53.99306 | 14.62729 |
| 827.0 | 55.59814 | 21.24918 | | 1857.2 | 54.00362 | 14.65987 |
| 827.5 | 55.61124 | 21.02431 | | 1858.4 | 53.99807 | 14.69245 |
| 828.0 | 55.55726 | 21.20644 | | 1859.6 | 54.00107 | 14.69383 |
| 828.5 | 55.55208 | 21.16517 | | 1860.8 | 54.03446 | 14.69521 |
| 829.0 | 55.57131 | 21.17337 | | 1862.0 | 54.02202 | 14.69659 |
| 829.5 | 55.58568 | 21.17512 | | 1863.2 | 54.02398 | 14.69797 |
| 830.0 | 55.63165 | 21.17273 | | 1864.4 | 53.99899 | 14.69935 |
| 830.5 | 55.59607 | 21.17163 | | 1865.6 | 54.04703 | 14.70073 |
| 831.0 | 55.61705 | 21.16898 | | 1866.8 | 54.01614 | 14.70211 |
| 831.5 | 55.67282 | 21.16644 | | 1868.0 | 53.99849 | 14.70349 |
| 832.0 | 55.73489 | 21.15457 | | 1869.2 | 54.06849 | 14.70487 |
| 832.5 | 55.79975 | 21.14562 | | 1870.4 | 54.04022 | 14.70625 |
| 833.0 | 55.83959 | 21.13548 | | 1871.6 | 54.06593 | 14.70763 |
| 833.5 | 55.85882 | 21.13241 | | 1872.8 | 54.07087 | 14.70901 |
| 834.0 | 55.90665 | 21.12235 | | 1874.0 | 54.06933 | 14.71039 |
| 834.5 | 56.11058 | 21.11397 | | 1875.2 | 54.09132 | 14.71777 |
| 835.0 | 56.15125 | 21.10861 | | 1876.4 | 54.09546 | 14.72515 |
| 835.5 | 56.16398 | 21.04911 | | 1877.6 | 54.09316 | 14.73253 |
| 836.0 | 56.17329 | 21.06543 | | 1878.8 | 54.13316 | 14.73991 |
| 836.5 | 56.18894 | 21.11144 | | 1880.0 | 54.15756 | 14.73289 |
| 837.0 | 56.19307 | 21.04984 | | 1881.2 | 54.12773 | 14.74797 |
| 837.5 | 56.26022 | 21.06465 | | 1882.4 | 54.12007 | 14.74865 |
| 838.0 | 56.23806 | 21.06631 | | 1883.6 | 54.13789 | 14.74933 |
| 838.5 | 56.29866 | 21.08002 | | 1884.8 | 54.17845 | 14.75001 |
| 839.0 | 56.25274 | 21.09076 | | 1886.0 | 54.16535 | 14.75069 |
| 839.5 | 56.31369 | 21.06604 | | 1887.2 | 54.17973 | 14.75137 |
| 840.0 | 56.27894 | 21.03431 | | 1888.4 | 54.15066 | 14.75205 |
| 840.5 | 56.28607 | 21.01306 | | 1889.6 | 54.15372 | 14.75273 |
| 841.0 | 56.26117 | 21.00572 | | 1890.8 | 54.13899 | 14.75341 |
| 841.5 | 56.30839 | 21.00257 | | 1892.0 | 54.17199 | 14.75409 |
| 842.0 | 56.26251 | 21.04072 | | 1893.2 | 54.17556 | 14.75477 |
| 842.5 | 56.31185 | 21.01486 | | 1894.4 | 54.14389 | 14.75545 |
| 843.0 | 56.28754 | 20.99570 | | 1895.6 | 54.13338 | 14.75613 |
| 843.5 | 56.26553 | 21.02458 | | 1896.8 | 54.11349 | 14.75681 |
| 844.0 | 56.24313 | 21.01013 | | 1898.0 | 54.11263 | 14.75749 |
| 844.5 | 56.23907 | 21.04292 | | 1899.2 | 54.14549 | 14.75817 |
| 845.0 | 56.22467 | 20.99287 | | 1900.4 | 54.23158 | 14.75885 |
| 845.5 | 56.24377 | 20.97326 | | 1901.6 | 54.13418 | 14.75953 |
| 846.0 | 56.27236 | 20.99964 | | 1902.8 | 54.13082 | 14.76021 |
| 846.5 | 56.24371 | 21.00303 | | 1904.0 | 54.12609 | 14.76089 |
| 847.0 | 56.27059 | 20.94793 | | 1905.2 | 54.11204 | 14.76157 |
| 847.5 | 56.25941 | 20.96173 | | 1906.4 | 54.08752 | 14.76225 |
| 848.0 | 56.27915 | 20.95834 | | 1907.6 | 54.11131 | 14.76293 |
| 848.5 | 56.26742 | 20.96843 | | 1908.8 | 54.07826 | 14.76361 |
| 849.0 | 56.28885 | 20.95087 | | 1910.0 | 54.09162 | 14.76429 |

System Accuracy Verification

Prior to the assessment, the system validation kit was used to test whether the system was operating within its specifications of $\pm 10\%$. The validation results are tabulated below. And also the corresponding SAR plot is attached as well in the SAR plots files.

System Verification Setup Block Diagram

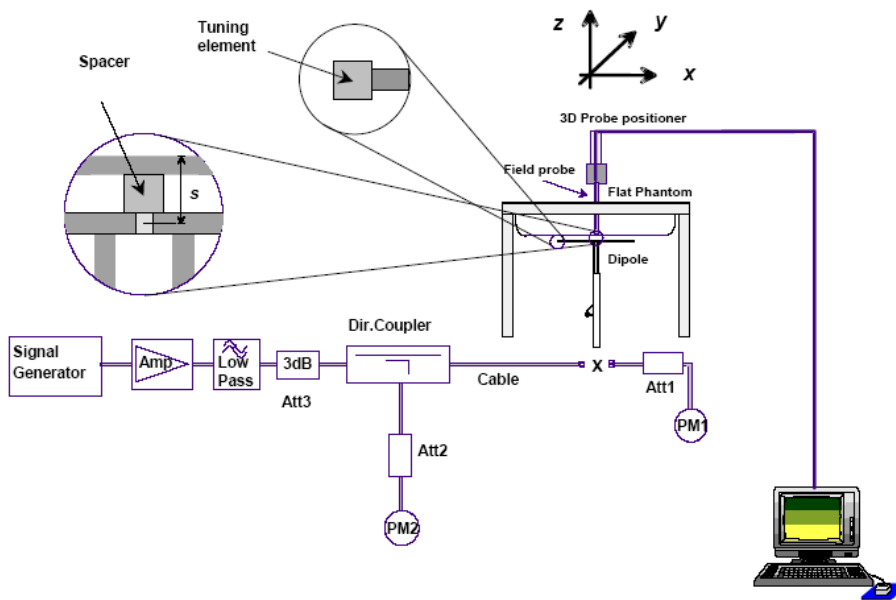

System Accuracy Check Results

| Date | Frequency (MHz) | Liquid Type | Measured SAR (W/Kg) | Target Value (W/Kg) | Delta (%) | Tolerance (%) |
|------------|-----------------|-------------|---------------------|---------------------|-----------|---------------|
| 2012-06-29 | 835 | Head | 1g 9.645 | 9.590 | 0.574 | ± 10 |
| | | Body | 1g 9.562 | 9.262 | -3.139 | ± 10 |
| | 1900 | Head | 1g 40.364 | 39.648 | 1.806 | ± 10 |
| | | Body | 1g 38.842 | 39.769 | -2.331 | ± 10 |

*All SAR values are normalized to 1 Watt forward power.

SAR SYSTEM VALIDATION DATA**Test Laboratory: Bay Area Compliance Lab Corp. (Shenzhen)****System Performance Check 835MHz Head Liquid****Dipole 835 MHz; Type: ALS-D-835-S-2; S/N: 180-00558**

Product Data

Device Name : Dipole 835 MHz
Serial No. : 180-00558
Type : Dipole
Model : ALS-D-835-S-2
Frequency : 835.00 MHz
Max. Transmit Pwr : 1 W
Drift Time : 3 min(s)
Power Drift-Start : 9.021 W/kg
Power Drift-Finish : 9.285 W/kg
Power Drift (%) : 2.925

Phantom Data

Name : APREL-Uni
Type : Uni-Phantom
Size (mm) : 280 x 280 x 200
Serial No. : System Default
Location : Center
Description : Default
Phantom Data

Tissue Data

Type : HEAD
Serial No. : 270-01002
Frequency : 835.00 MHz
Last Calib. Date : 29-Jun-2012
Temperature : 20.00 °C
Ambient Temp. : 21.00 °C
Humidity : 56.00 RH%
Epsilon : 42.32 F/m
Sigma : 0.92 S/m
Density : 1000.00 kg/cu. m

Probe Data

Name : E-Field
Model : E-020
Type : E-Field Triangle
Serial No. : 500-00283
Last Calib. Date : 14-Jul-2011
Frequency : 835.00 MHz
Duty Cycle Factor : 1
Conversion Factor : 6.6
Probe Sensitivity : 1.20 1.20 1.20 $\mu\text{V}/(\text{V}/\text{m})^2$
Compression Point : 95.00 mV
Offset : 1.56 mm

Measurement Data

Crest Factor : 1
Scan Type : Complete
Tissue Temp. : 21.00 °C
Ambient Temp. : 21.00 °C
Area Scan : 8x10x1 : Measurement x=10mm, y=10mm, z=4mm
Zoom Scan : 7x7x7 : Measurement x=5mm, y=5mm, z=5mm

1 gram SAR value : 9.645 W/kg
 10 gram SAR value : 6.124 W/kg
 Area Scan Peak SAR : 9.682 W/kg
 Zoom Scan Peak SAR : 15.265 W/kg

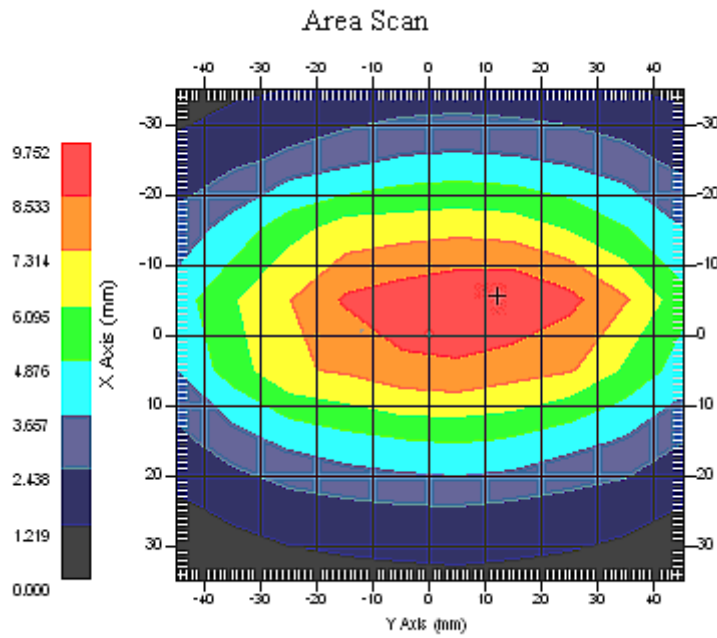

835 MHz System Validation with Head Tissue

Test Laboratory: Bay Area Compliance Lab Corp. (Shenzhen)**System Performance Check 835MHz Body Liquid****Dipole 835 MHz; Type: ALS-D-835-S-2; S/N: 180-00558**

Product Data

Device Name : Dipole 835 MHz
Serial No. : 180-00558
Type : Dipole
Model : ALS-D-835-S-2
Frequency : 835.00 MHz
Max. Transmit Pwr : 1 W
Drift Time : 3 min(s)
Power Drift-Start : 9.341 W/kg
Power Drift-Finish : 9.547 W/kg
Power Drift (%) : 2.205

Phantom Data

Name : APREL-Uni
Type : Uni-Phantom
Size (mm) : 280 x 280 x 200
Serial No. : System Default
Location : Center
Description : Default
Phantom Data

Tissue Data

Type : Body
Serial No. : 270-02101
Frequency : 835.00 MHz
Last Calib. Date : 29-Jun-2012
Temperature : 20.00 °C
Ambient Temp. : 21.00 °C
Humidity : 56.00 RH%
Epsilon : 56.15 F/m
Sigma : 0.98 S/m
Density : 1000.00 kg/cu. m

Probe Data

Name : E-Field
Model : E-020
Type : E-Field Triangle
Serial No. : 500-00283
Last Calib. Date : 14-Jul-2011
Frequency : 835.00 MHz
Duty Cycle Factor : 1
Conversion Factor : 6.6
Probe Sensitivity : 1.20 1.20 1.20 $\mu\text{V}/(\text{V}/\text{m})^2$
Compression Point : 95.00 mV
Offset : 1.56 mm

Measurement Data

Crest Factor : 1
Scan Type : Complete
Tissue Temp. : 21.00 °C
Ambient Temp. : 21.00 °C
Area Scan : 8x10x1 : Measurement x=10mm, y=10mm, z=4mm
Zoom Scan : 7x7x7 : Measurement x=5mm, y=5mm, z=5mm

1 gram SAR value : 9.562 W/kg
10 gram SAR value : 6.120 W/kg
Area Scan Peak SAR : 9.485 W/kg
Zoom Scan Peak SAR : 15.012 W/kg

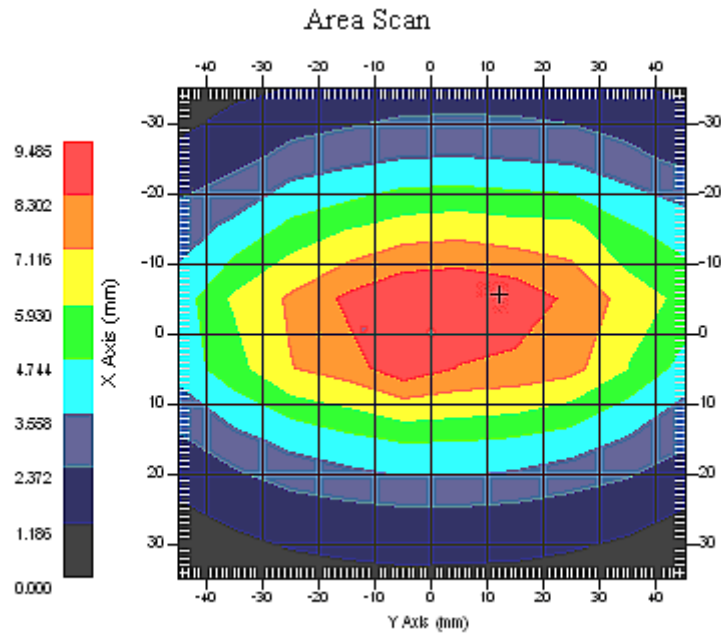

835 MHz System Validation with Body Tissue

Test Laboratory: Bay Area Compliance Lab Corp. (Shenzhen)**System Performance Check 1900 Head****Dipole 1900 MHz; Type: ALS-D-1900-S-2; S/N: 210-00710**

Product Data

Device Name : Dipole 1900MHz
Serial No. : 210-00710
Type : Dipole
Model : ALS-D-1900-S-2
Frequency : 1900.00 MHz
Max. Transmit Pwr : 1 W
Drift Time : 3 min(s)
Power Drift-Start : 40.489 W/kg
Power Drift-Finish : 41.006 W/kg
Power Drift (%) : 1.276

Phantom Data

Name : APREL-Uni
Type : Uni-Phantom
Size (mm) : 280 x 280 x 200
Serial No. : System Default
Location : Center
Description : Default

Tissue Data

Type : HEAD
Serial No. : 295-01103
Frequency : 1900.00 MHz
Last Calib. Date : 29-Jun-2012
Temperature : 20.00 °C
Ambient Temp. : 21.00 °C
Humidity : 56.00 RH%
Epsilon : 41.51 F/m
Sigma : 1.42 S/m
Density : 1000.00 kg/cu. M

Probe Data

Name : E-Field
Model : E-020
Type : E-Field Triangle
Serial No. : 500-00283
Last Calib. Date : 14-Jul-2011
Frequency : 1900.00 MHz
Duty Cycle Factor : 1
Conversion Factor : 5.20
Probe Sensitivity : 1.20 1.20 1.20 $\mu\text{V}/(\text{V}/\text{m})^2$
Compression Point : 95.00 mV
Offset : 1.56 mm

Measurement Data

Crest Factor : 1
Scan Type : Complete
Tissue Temp. : 20.00 °C
Ambient Temp. : 20.00 °C
Area Scan : 7x9x1 : Measurement x=10mm, y=10mm, z=4mm
Zoom Scan : 7x7x7 : Measurement x=5mm, y=5mm, z=5mm

1 gram SAR value : 40.364 W/kg
10 gram SAR value : 20.512 W/kg
Area Scan Peak SAR : 41.256 W/kg
Zoom Scan Peak SAR : 72.841 W/kg

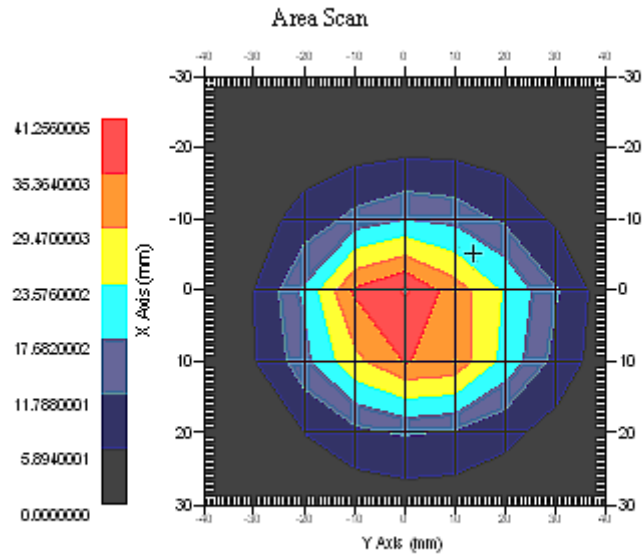

1900 MHz System Validation with Head Tissue

Test Laboratory: Bay Area Compliance Lab Corp. (Shenzhen)**System Performance Check 1900 Body****Dipole 1900 MHz; Type: ALS-D-1900-S-2; S/N: 210-00710**

Product Data

Device Name : Dipole 1900MHz
Serial No. : 210-00710
Type : Dipole
Model : ALS-D-1900-S-2
Frequency : 1900.00 MHz
Max. Transmit Pwr : 1 W
Drift Time : 3 min(s)
Power Drift-Start : 39.755 W/kg
Power Drift-Finish : 40.087 W/kg
Power Drift (%) : 0.835

Phantom Data

Name : APREL-Uni
Type : Uni-Phantom
Size (mm) : 280 x 280 x 200
Serial No. : System Default
Location : Center
Description : Default

Tissue Data

Type : Body
Serial No. : 295-02102
Frequency : 1900.00 MHz
Last Calib. Date : 29-Jun-2012
Temperature : 20.00 °C
Ambient Temp. : 21.00 °C
Humidity : 56.00 RH%
Epsilon : 54.23 F/m
Sigma : 1.54 S/m
Density : 1000.00 kg/cu. m

Probe Data

Name : E-Field
Model : E-020
Type : E-Field Triangle
Serial No. : 500-00283
Last Calib. Date : 14-Jul-2011
Frequency : 1900.00 MHz
Duty Cycle Factor : 1
Conversion Factor : 5.0
Probe Sensitivity : 1.20 1.20 1.20 $\mu\text{V}/(\text{V}/\text{m})^2$
Compression Point : 95.00 mV
Offset : 1.56 mm

Measurement Data

Crest Factor : 1
Scan Type : Complete
Tissue Temp. : 20.00 °C
Ambient Temp. : 21.00 °C
Area Scan : 7x9x1 : Measurement x=10mm, y=10mm, z=4mm
Zoom Scan : 7x7x7 : Measurement x=5mm, y=5mm, z=5mm

1 gram SAR value : 38.842 W/kg
10 gram SAR value : 19.564 W/kg
Area Scan Peak SAR : 40.402 W/kg
Zoom Scan Peak SAR : 70.155 W/kg

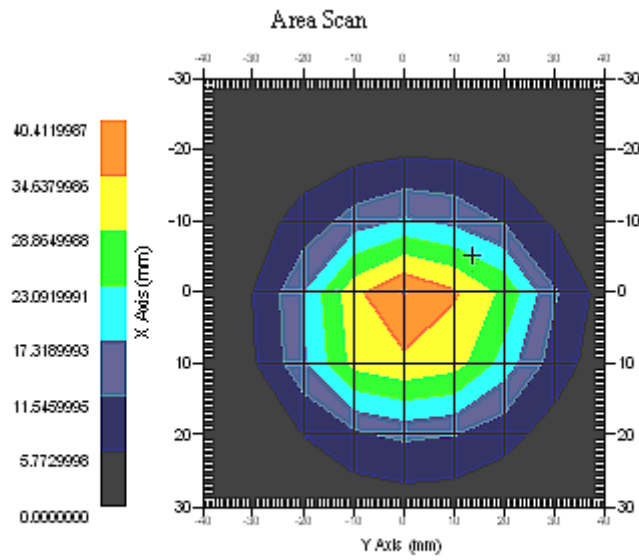

1900 MHz System Validation with Body Tissue

EUT TEST STRATEGY AND METHODOLOGY

Test Positions for Device Operating Next to a Person’s Ear

This category includes most wireless handsets with fixed, retractable or internal antennas located toward the top half of the device, with or without a foldout, sliding or similar keypad cover. The handset should have its earpiece located within the upper ¼ of the device, either along the centerline or off-centered, as perceived by its users. This type of handset should be positioned in a normal operating position with the “test device reference point” located along the “vertical centerline” on the front of the device aligned to the “ear reference point”. The “test device reference point” should be located at the same level as the center of the earpiece region. The “vertical centerline” should bisect the front surface of the handset at its top and bottom edges. A “ear reference point” is located on the outer surface of the head phantom on each ear spacer. It is located 1.5 cm above the center of the ear canal entrance in the “phantom reference plane” defined by the three lines joining the center of each “ear reference point” (left and right) and the tip of the mouth.

A handset should be initially positioned with the earpiece region pressed against the ear spacer of a head phantom. For the SCC-34/SC-2 head phantom, the device should be positioned parallel to the “N-F” line defined along the base of the ear spacer that contains the “ear reference point”. For interim head phantoms, the device should be positioned parallel to the cheek for maximum RF energy coupling. The “test device reference point” is aligned to the “ear reference point” on the head phantom and the “vertical centerline” is aligned to the “phantom reference plane”. This is called the “initial ear position”. While maintaining these three alignments, the body of the handset is gradually adjusted to each of the following positions for evaluating SAR:

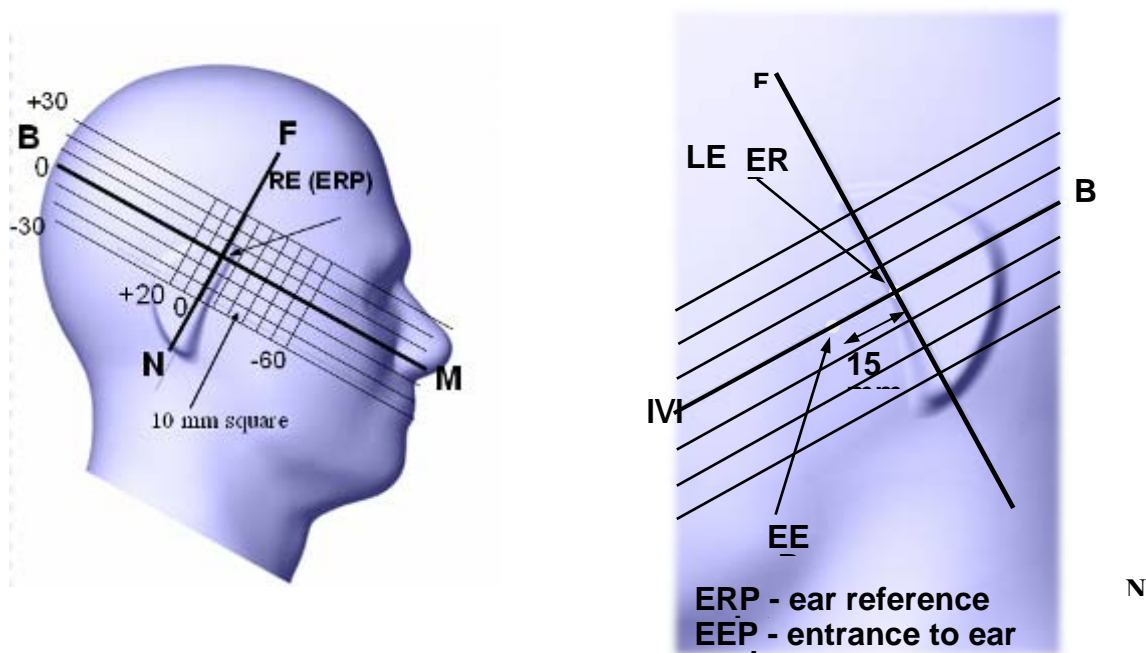

Cheek/Touch Position

The device is brought toward the mouth of the head phantom by pivoting against the “ear reference point” or along the “N-F” line for the SCC-34/SC-2 head phantom.

This test position is established:

- When any point on the display, keypad or mouthpiece portions of the handset is in contact with the phantom.
- (or) When any portion of a foldout, sliding or similar keypad cover opened to its intended self-adjusting normal use position is in contact with the cheek or mouth of the phantom.

For existing head phantoms – when the handset loses contact with the phantom at the pivoting point, rotation should continue until the device touches the cheek of the phantom or breaks its last contact from the ear spacer.

Cheek /Touch Position

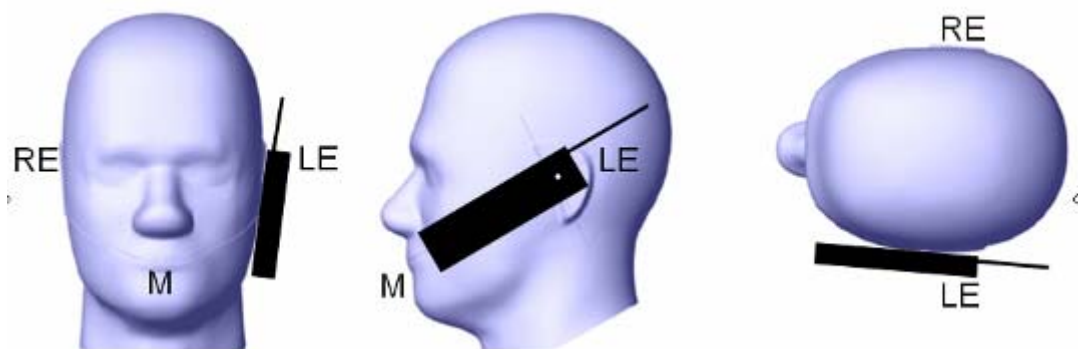

Ear/Tilt Position

With the handset aligned in the “Cheek/Touch Position”:

1) If the earpiece of the handset is not in full contact with the phantom’s ear spacer (in the “Cheek/Touch position”) and the peak SAR location for the “Cheek/Touch” position is located at the ear spacer region or corresponds to the earpiece region of the handset, the device should be returned to the “initial ear position” by rotating it away from the mouth until the earpiece is in full contact with the ear spacer.

2) (otherwise) The handset should be moved (translated) away from the cheek perpendicular to the line passes through both “ear reference points” (note: one of these ear reference points may not physically exist on a split head model) for approximate 2-3 cm. While it is in this position, the device handset is tilted away from the mouth with respect to the “test device reference point” until the inside angle between the vertical centerline on the front surface of the phone and the horizontal line passing through the ear reference point is by 15 80°. After the tilt, it is then moved (translated) back toward the head perpendicular to the line passes through both “ear reference points” until the device touches the phantom or the ear spacer. If the antenna touches the head first, the positioning process should be repeated with a tilt angle less than 15° so that the device and its antenna would touch the phantom simultaneously. This test position may require a device holder or positioner to achieve the translation and tilting with acceptable positioning repeatability.

If a device is also designed to transmit with its keypad cover closed for operating in the head position, such positions should also be considered in the SAR evaluation. The device should be tested on the left and right side of the head phantom in the “Cheek/Touch” and “Ear/Tilt” positions. When applicable, each configuration should be tested with the antenna in its fully extended and fully retracted positions. These test configurations should be tested at the high, middle and low frequency channels of each operating mode; for example, AMPS, CDMA, and TDMA. If the SAR measured at the middle channel for each test configuration (left, right, Cheek/Touch, Tile/Ear, extended and retracted) is at least 2.0 dB lower than the SAR limit, testing at the high and low channels is optional for such test configuration(s). If the transmission band of the test device is less than 10 MHz, testing at the high and low frequency channels is optional.

Ear /Tilt 15° Position

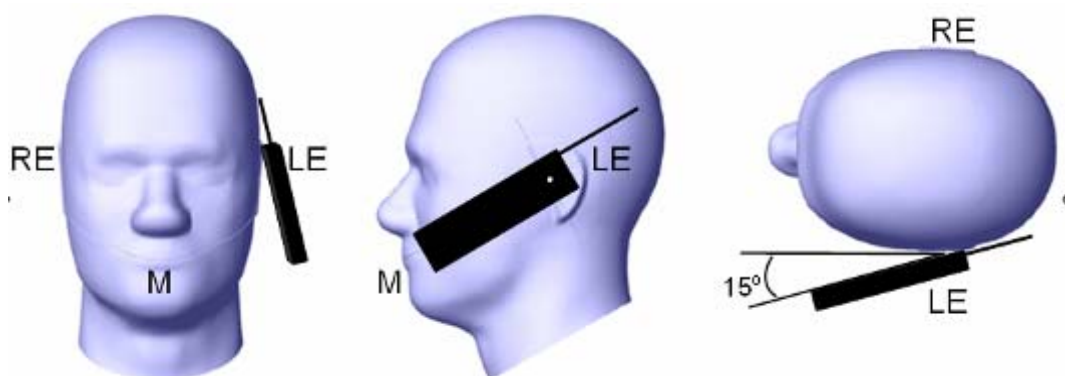

Test positions for body-worn and other configurations

Body-worn operating configurations should be tested with the belt-clips and holsters attached to the device and positioned against a flat phantom in normal use configurations. Devices with a headset output should be tested with a headset connected to the device. When multiple accessories that do not contain metallic components are supplied with the device, the device may be tested with only the accessory that dictates the closest spacing to the body. When multiple accessories that contain metallic components are supplied with the device, the device must be tested with each accessory that contains a unique metallic component. If multiple accessories share an identical metallic component (e.g., the same metallic belt-clip used with different holsters with no other metallic components), only the accessory that dictates the closest spacing to the body must be tested.

Body-worn accessories may not always be supplied or available as options for some devices that are intended to be authorized for body-worn use. A separation distance of 1.5 cm between the back of the device and a flat phantom is recommended for testing body-worn SAR compliance under such circumstances. Other separation distances may be used, but they should not exceed 2.5 cm. In these cases, the device may use body-worn accessories that provide a separation distance greater than that tested for the device provided however that the accessory contains no metallic components.

SAR Evaluation Procedure

The evaluation was performed with the following procedure:

Step 1: Measurement of the SAR value at a fixed location above the ear point or central position was used as a reference value for assessing the power drop. The SAR at this point is measured at the start of the test and then again at the end of the testing.

Step 2: The SAR distribution at the exposed side of the head was measured at a distance of 4 mm from the inner surface of the shell. The area covered the entire dimension of the head or EUT and the horizontal grid spacing was 10 mm x 10 mm. Based on these data, the area of the maximum absorption was determined by spline interpolation. The first Area Scan covers the entire dimension of the EUT to ensure that the hotspot was correctly identified.

Step 3: Around this point, a volume of 35 mm x 35 mm x 35 mm was assessed by measuring 7x 7 x 7 points. On the basis of this data set, the spatial peak SAR value was evaluated under the following procedure:

- 1) The data at the surface were extrapolated, since the center of the dipoles is 1.2 mm away from the tip of the probe and the distance between the surface and the lowest measuring point is 1.3 mm. The extrapolation was based on a least square algorithm. A polynomial of the fourth order was calculated through the points in z-axes. This polynomial was then used to evaluate the points between the surface and the probe tip.
- 2) The maximum interpolated value was searched with a straightforward algorithm. Around this maximum the SAR values averaged over the spatial volumes (1 g or 10 g) were computed by the 3D-Spline interpolation algorithm. The 3D-Spline is composed of three one dimensional splines with the "Not a knot"-condition (in x, y and z-directions). The volume was integrated with the trapezoidal-algorithm. One thousand points (10 x 10 x 10) were interpolated to calculate the averages.

All neighboring volumes were evaluated until no neighboring volume with a higher average value was found.

Step 4: Re-measurement of the SAR value at the same location as in Step 1. If the value changed by more than 5%, the evaluation was repeated.

CONDUCTED OUTPUT POWER MEASUREMENT

Provision Applicable

The measured peak output power should be greater and within 5% than EMI measurement.

Test Procedure

The RF output of the transmitter was connected to the input of the EMI Test Receiver through sufficient attenuation.

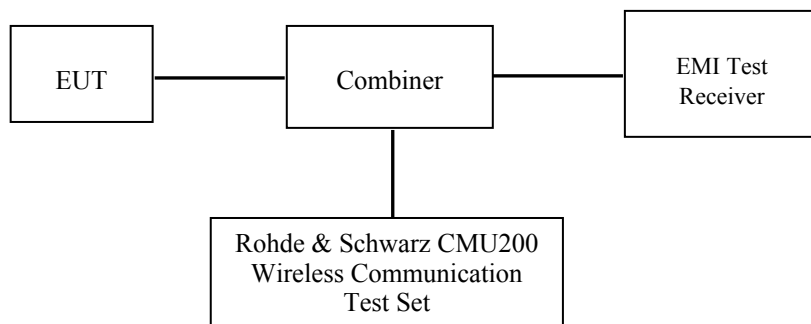

Test Results:

GSM

| Band | Frequency (MHz) | Conducted Output Power | |
|----------|-----------------|------------------------|---------|
| | | GSM (dBm) | GSM (W) |
| Cellular | 824.2 | 32.15 | 1.641 |
| | 836.6 | 32.20 | 1.660 |
| | 848.8 | 32.19 | 1.656 |
| PCS | 1850.2 | 29.17 | 0.826 |
| | 1880.0 | 29.30 | 0.851 |
| | 1909.8 | 29.35 | 0.861 |

GPRS

| Band | Channel No. | Frequency (MHz) | RF Output Power (dBm) | | | |
|----------|-------------|-----------------|-----------------------|--------|-------------|-------------|
| | | | 1 slot | 2 slot | 3 slots | 4 slots |
| Cellular | 128 | 824.2 | 32.03 | 31.86 | Not support | Not support |
| | 190 | 836.6 | 32.11 | 31.87 | Not support | Not support |
| | 251 | 848.8 | 32.11 | 31.91 | Not support | Not support |
| PCS | 512 | 1850.2 | 29.18 | 29.09 | Not support | Not support |
| | 661 | 1880.0 | 29.33 | 29.23 | Not support | Not support |
| | 810 | 1909.8 | 29.38 | 29.29 | Not support | Not support |

For SAR, the time based average power is relevant, the difference in between depends on the duty cycle of the TDMA signal.

| Number of Time slot | 1 | 2 | 3 | 4 |
|--|-------|-------|----------|-------|
| Duty Cycle | 1:8 | 1:4 | 1:2.66 | 1:2 |
| Time based Ave. power compared to slotted Ave. power | -9 dB | -6 dB | -4.25 dB | -3 dB |
| Crest Factor | 8 | 4 | 2.66 | 2 |

The time based average power

| Band | Channel No. | Frequency (MHz) | Time based average Power (dBm) | | | |
|----------|-------------|-----------------|--------------------------------|--------|-------------|-------------|
| | | | 1 slot | 2 slot | 3 slots | 4 slots |
| Cellular | 128 | 824.2 | 23.03 | 25.86 | Not support | Not support |
| | 190 | 836.6 | 23.11 | 25.87 | Not support | Not support |
| | 251 | 848.8 | 23.11 | 25.91 | Not support | Not support |
| PCS | 512 | 1850.2 | 20.18 | 23.09 | Not support | Not support |
| | 661 | 1880.0 | 29.33 | 23.23 | Not support | Not support |
| | 810 | 1909.8 | 20.38 | 23.29 | Not support | Not support |

Note:

1. Rohde & Schwarz Radio Communication Tester (CMU200) was used for the measurement of GSM peak and average output power for active timeslots.
2. For GSM voice, 1 timeslot has been activated with power level 5 (850 MHz band) and 0 (1900 MHz band).
3. For GPRS, 1 and 2 timeslots has been activated separately with power level 5(850 MHz band) and 0(1900 MHz band).

SAR MEASUREMENT RESULTS

This page summarizes the results of the performed dosimetric evaluation.

Environmental Conditions

| | |
|---------------------------|-----------|
| Temperature: | 21 °C |
| Relative Humidity: | 56% |
| ATM Pressure: | 1002 mbar |

** Testing was performed by Sandy Wang on 2012.06.29-2012.06.30*

Cellular Band:

| EUT Position | Frequency (MHz) | | Test Mode | Antenna Type | Liquid Type | Power Drift (%) | FCC 1g SAR (W/Kg) | |
|---------------------------|-----------------|-------|-----------|--------------|-------------|-----------------|-------------------|-------|
| | Channel | MHz | | | | | Measurement | Limit |
| Cellular <SIM1> | | | | | | | | |
| Left Head Cheek | 190(Middle) | 836.6 | GSM | Integral | Head | 3.727 | 0.232 | 1.6 |
| Left Head Tilt | 190(Middle) | 836.6 | GSM | Integral | Head | 1.827 | 0.187 | 1.6 |
| Right Head Cheek | 190(Middle) | 836.6 | GSM | Integral | Head | 3.509 | 0.227 | 1.6 |
| Right Head Tilt | 190(Middle) | 836.6 | GSM | Integral | Head | 2.578 | 0.176 | 1.6 |
| Body-Worn-Headset (1.5cm) | 190(Middle) | 836.6 | GSM | Integral | Body | 3.333 | 0.176 | 1.6 |
| Body-Worn Back (1.5cm) | 190(Middle) | 836.6 | GSM | Integral | Body | 2.271 | 0.175 | 1.6 |
| Cellular <SIM2> | | | | | | | | |
| Left Head Cheek | 190(Middle) | 836.6 | GSM | Integral | Head | 2.734 | 0.219 | 1.6 |
| Left Head Tilt | 190(Middle) | 836.6 | GSM | Integral | Head | 3.968 | 0.167 | 1.6 |

Note:

1. When the 1-g SAR is $\leq 0.8W/kg$, testing for other channels are optional.

PCS Band:

| EUT Position | Frequency (MHz) | | Test Mode | Antenna Type | Liquid Type | Power Drift (%) | FCC 1g SAR (W/Kg) | |
|---------------------------|-----------------|--------|-----------|--------------|-------------|-----------------|-------------------|-------|
| | Channel | MHz | | | | | Measurement | Limit |
| PCS <SIM1> | | | | | | | | |
| Left Head Cheek | 810(High) | 1909.8 | GSM | Integral | Head | 3.389 | 0.160 | 1.6 |
| Left Head Tilt | 810(High) | 1909.8 | GSM | Integral | Head | 0.972 | 0.135 | 1.6 |
| Right Head Cheek | 810(High) | 1909.8 | GSM | Integral | Head | 3.173 | 0.157 | 1.6 |
| Right Head Tilt | 810(High) | 1909.8 | GSM | Integral | Head | 2.754 | 0.129 | 1.6 |
| Body-Worn-Headset (1.5cm) | 810(High) | 1909.8 | GSM | Integral | Body | 3.061 | 0.109 | 1.6 |
| Body-Worn Back (1.5cm) | 810(High) | 1909.8 | GPRS | Integral | Body | 2.198 | 0.195 | 1.6 |
| PCS <SIM2> | | | | | | | | |
| Left Head Cheek | 810(High) | 1909.8 | GSM | Integral | Head | 3.008 | 0.152 | 1.6 |
| Left Head Tilt | 810(High) | 1909.8 | GSM | Integral | Head | 2.042 | 0.127 | 1.6 |

Note:

1. The EUT is a Class B mobile phone which can be attached to both GPRS and GSM services, using one service at a time.
2. The Multi-slot Classes of EUT is Class 10 which has maximum 4 Downlink slots and 2 Uplink slots, the maximum active slots is 5, when perform the multiple slots scan, 3 DL+2UL is the worse case.
3. The EUT transmit and receive through the same GSM antenna while testing SAR.
4. When the 1-g SAR is $\leq 0.8W/kg$, testing for other channels are optional.

EUT SCAN RESULTS

Test Laboratory: Bay Area Compliance Lab Corp. (Shenzhen)

Left Head Cheek (836.6 MHz Middle Channel)

Measurement Data

Test mode : GSM
Crest Factor : 8
Scan Type : Complete
Area Scan : 11x8x1: Measurement x=10mm, y=10mm, z=4mm
Zoom Scan : 7x7x7: Measurement x=5mm, y=5mm, z=5mm
Power Drift-Start : 0.155 W/kg
Power Drift-Finish : 0.161 W/kg
Power Drift (%) : 3.727

Tissue Data

Type : HEAD
Frequency : 835.00 MHz
Epsilon : 42.32 F/m
Sigma : 0.92 S/m
Density : 1000.00 kg/cu. m

Probe Data

Serial No. : 500-00283
Frequency : 835.00 MHz
Duty Cycle Factor : 8
Conversion Factor : 6.6
Probe Sensitivity : 1.20 1.20 1.20 $\mu\text{V}/(\text{V}/\text{m})^2$
Compression Point : 95.00 mV
Offset : 1.56 mm

1 gram SAR value : 0.232 W/kg
10 gram SAR value : 0.148 W/kg
Area Scan Peak SAR : 0.243 W/kg
Zoom Scan Peak SAR : 0.340 W/kg

Plot 1#

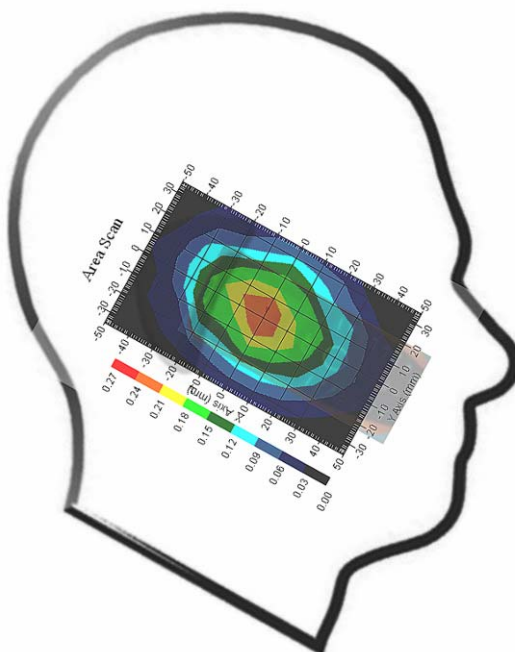

Test Laboratory: Bay Area Compliance Lab Corp. (Shenzhen)

Left Head Tilt (836.6 MHz Middle Channel)

Measurement Data

Test mode : GSM
 Crest Factor : 8
 Scan Type : Complete
 Area Scan : 11x8x1 : Measurement x=10mm, y=10mm, z=4mm
 Zoom Scan : 7x7x7 : Measurement x=5mm, y=5mm, z=5mm
 Power Drift-Start : 0.165 W/kg
 Power Drift-Finish : 0.168 W/kg
 Power Drift (%) : 1.817

Tissue Data

Type : HEAD
 Frequency : 835.00 MHz
 Epsilon : 42.32 F/m
 Sigma : 0.92 S/m
 Density : 1000.00 kg/cu. m

Probe Data

Serial No. : 500-00283
 Frequency : 835.00 MHz
 Duty Cycle Factor : 8
 Conversion Factor : 6.6
 Probe Sensitivity : 1.20 1.20 1.20 $\mu\text{V}/(\text{V}/\text{m})^2$
 Compression Point : 95.00 mV
 Offset : 1.56 mm

1 gram SAR value : 0.187 W/kg
 10 gram SAR value : 0.117 W/kg
 Area Scan Peak SAR : 0.202 W/kg
 Zoom Scan Peak SAR : 0.293 W/kg

Plot 2#

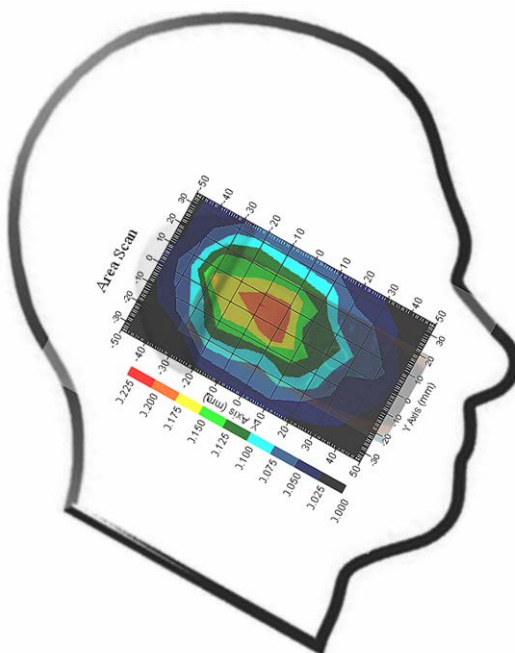

Test Laboratory: Bay Area Compliance Lab Corp. (Shenzhen)

Right Head Cheek (836.6 MHz Middle Channel)

Measurement Data

Test mode : GSM
 Crest Factor : 8
 Scan Type : Complete
 Area Scan : 11x8x1 : Measurement x=10mm, y=10mm, z=4mm
 Zoom Scan : 7x7x7 : Measurement x=5mm, y=5mm, z=5mm
 Power Drift-Start : 0.165 W/kg
 Power Drift-Finish : 0.171 W/kg
 Power Drift (%) : 3.509

Tissue Data

Type : HEAD
 Frequency : 835.00 MHz
 Epsilon : 42.32 F/m
 Sigma : 0.92 S/m
 Density : 1000.00 kg/cu. m

Probe Data

Serial No. : 500-00283
 Frequency : 835.00 MHz
 Duty Cycle Factor : 8
 Conversion Factor : 6.6
 Probe Sensitivity : 1.20 1.20 1.20 $\mu\text{V}/(\text{V}/\text{m})^2$
 Compression Point : 95.00 mV
 Offset : 1.56 mm

1 gram SAR value : 0.227 W/kg
 10 gram SAR value : 0.132 W/kg
 Area Scan Peak SAR : 0.254 W/kg
 Zoom Scan Peak SAR : 0.380 W/kg

Plot 3#

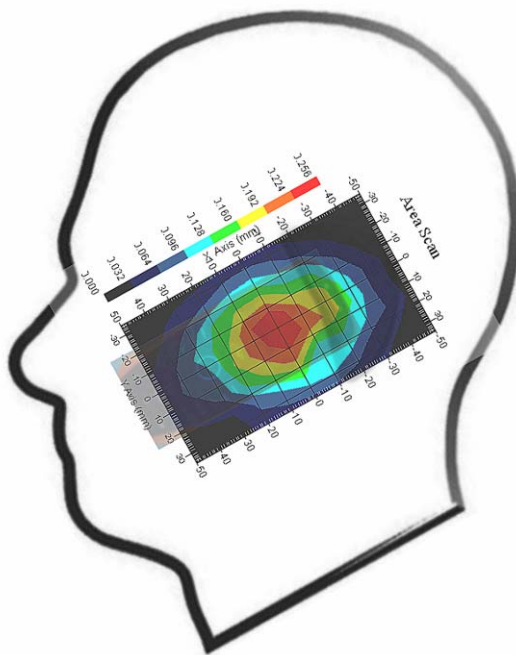

Test Laboratory: Bay Area Compliance Lab Corp. (Shenzhen)

Right Head Tilt (836.6 MHz Middle Channel)

Measurement Data

Test mode : GSM
Crest Factor : 8
Scan Type : Complete
Area Scan : 11x8x1 : Measurement x=10mm, y=10mm, z=4mm
Zoom Scan : 7x7x7 : Measurement x=5mm, y=5mm, z=5mm
Power Drift-Start : 0.155 W/kg
Power Drift-Finish : 0.159 W/kg
Power Drift (%) : 2.578

Tissue Data

Type : HEAD
Frequency : 835.00 MHz
Epsilon : 42.32 F/m
Sigma : 0.92 S/m
Density : 1000.00 kg/cu. m

Probe Data

Serial No. : 500-00283
Frequency : 835.00 MHz
Duty Cycle Factor : 8
Conversion Factor : 6.6
Probe Sensitivity : 1.20 1.20 1.20 $\mu\text{V}/(\text{V}/\text{m})^2$
Compression Point : 95.00 mV
Offset : 1.56 mm

1 gram SAR value : 0.176 W/kg
10 gram SAR value : 0.112 W/kg
Area Scan Peak SAR : 0.207 W/kg
Zoom Scan Peak SAR : 0.310 W/kg

Plot 4#

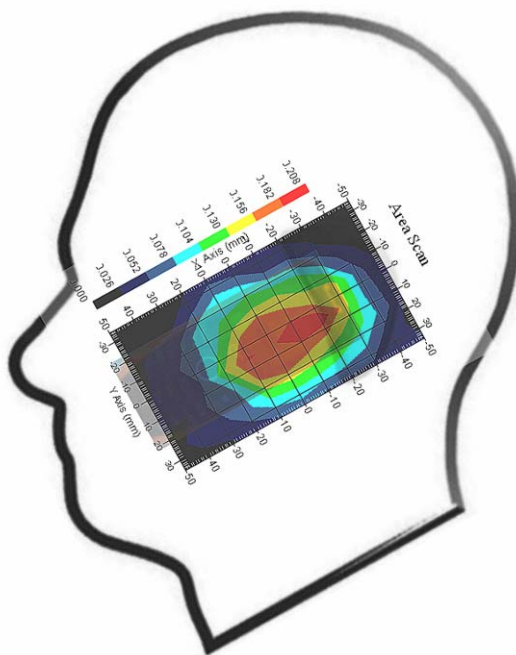

Test Laboratory: Bay Area Compliance Lab Corp. (Shenzhen)

Left Head Cheek-SIM2 (836.6 MHz Middle Channel)

Measurement Data

Test mode : GSM
 Crest Factor : 8
 Scan Type : Complete
 Area Scan : 11x8x1: Measurement x=10mm, y=10mm, z=4mm
 Zoom Scan : 7x7x7: Measurement x=5mm, y=5mm, z=5mm
 Power Drift-Start : 0.146 W/kg
 Power Drift-Finish : 0.150 W/kg
 Power Drift (%) : 2.734

Tissue Data

Type : HEAD
 Frequency : 835.00 MHz
 Epsilon : 42.32 F/m
 Sigma : 0.92 S/m
 Density : 1000.00 kg/cu. m

Probe Data

Serial No. : 500-00283
 Frequency : 835.00 MHz
 Duty Cycle Factor : 8
 Conversion Factor : 6.6
 Probe Sensitivity : 1.20 1.20 1.20 $\mu\text{V}/(\text{V}/\text{m})^2$
 Compression Point : 95.00 mV
 Offset : 1.56 mm

1 gram SAR value : 0.219 W/kg
 10 gram SAR value : 0.138 W/kg
 Area Scan Peak SAR : 0.230 W/kg
 Zoom Scan Peak SAR : 0.410 W/kg

Plot 5#

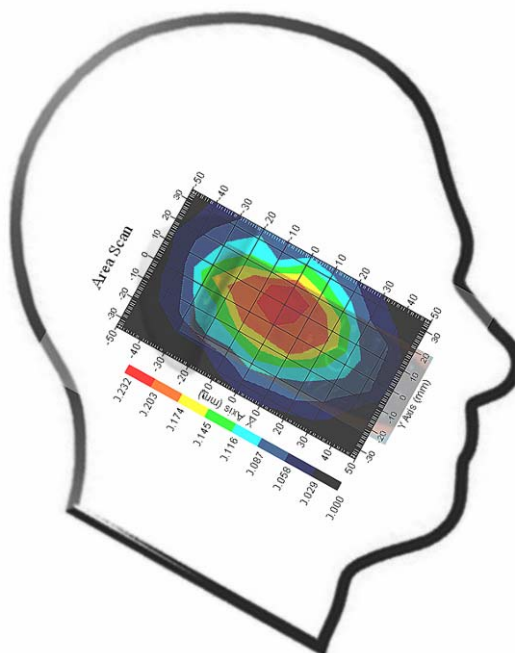

Test Laboratory: Bay Area Compliance Lab Corp. (Shenzhen)

Left Head Tilt-SIM2 (836.6 MHz Middle Channel)

Measurement Data

Test mode : GSM
 Crest Factor : 8
 Scan Type : Complete
 Area Scan : 11x8x1: Measurement x=10mm, y=10mm, z=4mm
 Zoom Scan : 7x7x7: Measurement x=5mm, y=5mm, z=5mm
 Power Drift-Start : 0.121 W/kg
 Power Drift-Finish : 0.126 W/kg
 Power Drift (%) : 3.968

Tissue Data

Type : HEAD
 Frequency : 835.00 MHz
 Epsilon : 42.32 F/m
 Sigma : 0.92 S/m
 Density : 1000.00 kg/cu. m

Probe Data

Serial No. : 500-00283
 Frequency : 835.00 MHz
 Duty Cycle Factor : 8
 Conversion Factor : 6.6
 Probe Sensitivity : 1.20 1.20 1.20 $\mu\text{V}/(\text{V/m})^2$
 Compression Point : 95.00 mV
 Offset : 1.56 mm

1 gram SAR value : 0.167 W/kg
 10 gram SAR value : 0.130 W/kg
 Area Scan Peak SAR : 0.221 W/kg
 Zoom Scan Peak SAR : 0.270 W/kg

Plot 6#

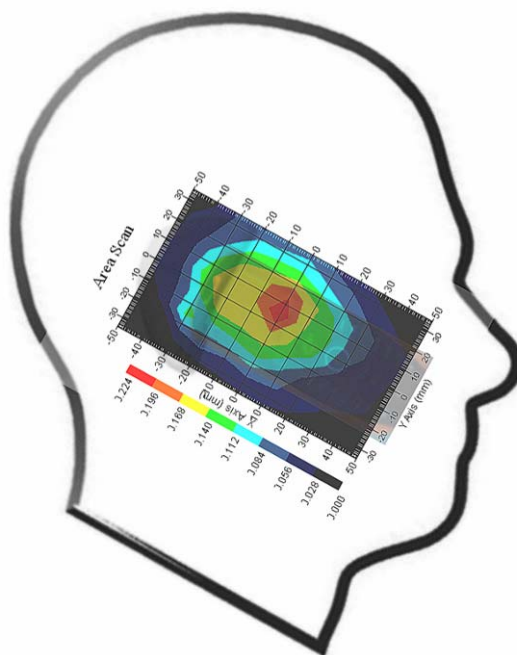

Test Laboratory: Bay Area Compliance Lab Corp. (Shenzhen)

Body-worn-Headset (836.6 MHz Middle Channel)

Measurement Data

Test mode : GSM
 Crest Factor : 8
 Scan Type : Complete
 Area Scan : 8x11x1 : Measurement x=10mm, y=10mm, z=4mm
 Zoom Scan : 7x7x7 : Measurement x=5mm, y=5mm, z=5mm
 Power Drift-Start : 0.145 W/kg
 Power Drift-Finish : 0.150W/kg
 Power Drift (%) : 3.333

Tissue Data

Type : Body
 Frequency : 835.00 MHz
 Epsilon : 56.15 F/m
 Sigma : 0.98 S/m
 Density : 1000.00 kg/cu. m

Probe Data

Serial No. : 500-00283
 Frequency : 835.00 MHz
 Duty Cycle Factor : 8
 Conversion Factor : 6.6
 Probe Sensitivity : 1.20 1.20 1.20 $\mu\text{V}/(\text{V}/\text{m})^2$
 Compression Point : 95.00 mV
 Offset : 1.56 mm

1 gram SAR value : 0.175 W/kg
 10 gram SAR value : 0.114 W/kg
 Area Scan Peak SAR : 0.176 W/kg
 Zoom Scan Peak SAR : 0.344 W/kg

Plot 7#

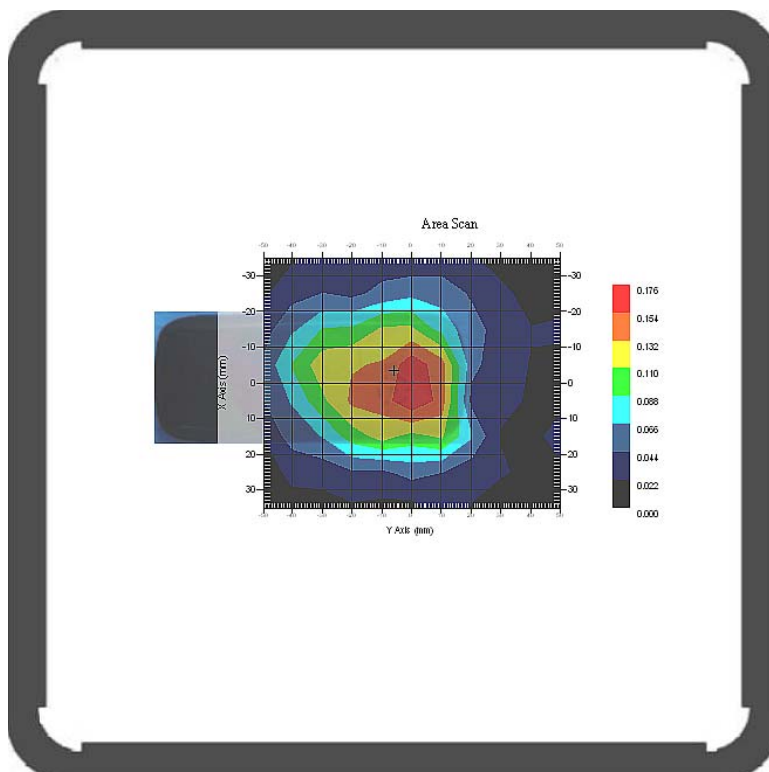

Test Laboratory: Bay Area Compliance Lab Corp. (Shenzhen)

Body-worn Back (836.6 MHz High Channel)

Measurement Data

Test mode : GPRS
 Crest Factor : 4
 Scan Type : Complete
 Area Scan : 8x11x1 : Measurement x=10mm, y=10mm, z=4mm
 Zoom Scan : 7x7x7 : Measurement x=5mm, y=5mm, z=5mm
 Power Drift-Start : 0.396 W/kg
 Power Drift-Finish : 0.405 W/kg
 Power Drift (%) : 2.271

Tissue Data

Type : Body
 Frequency : 835.00 MHz
 Epsilon : 56.15 F/m
 Sigma : 0.98 S/m
 Density : 1000.00 kg/cu. m

Probe Data

Serial No. : 500-00283
 Frequency : 835.00 MHz
 Duty Cycle Factor : 4
 Conversion Factor : 6.6
 Probe Sensitivity : 1.20 1.20 1.20 $\mu\text{V}/(\text{V}/\text{m})^2$
 Compression Point : 95.00 mV
 Offset : 1.56 mm

1 gram SAR value : 0.364 W/kg
 10 gram SAR value : 0.192 W/kg
 Area Scan Peak SAR : 0.439 W/kg
 Zoom Scan Peak SAR : 0.580 W/kg

Plot 8#

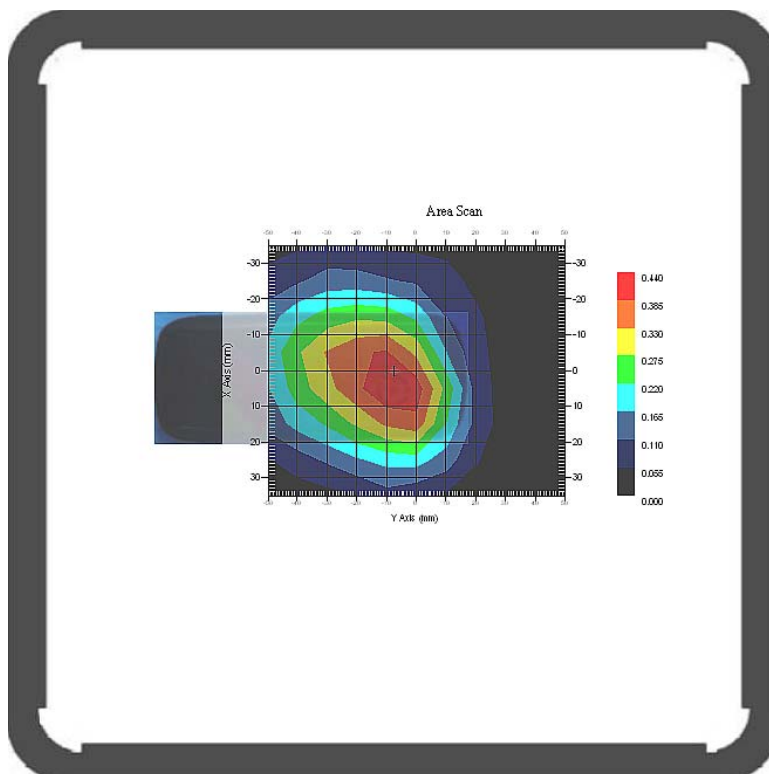

Test Laboratory: Bay Area Compliance Lab Corp. (Shenzhen)

Left Head Cheek (1909.8 MHz High Channel)

Measurement Data

Test mode : GSM
 Crest Factor : 8
 Scan Type : Complete
 Area Scan : 11x8x1 : Measurement x=10mm, y=10mm, z=4mm
 Zoom Scan : 7x7x7 : Measurement x=5mm, y=5mm, z=5mm
 Power Drift-Start : 0.118 W/kg
 Power Drift-Finish : 0.122 W/kg
 Power Drift (%) : 3.389

Tissue Data

Type : HEAD
 Frequency : 1900.00 MHz
 Epsilon : 41.52 F/m
 Sigma : 1.42 S/m
 Density : 1000.00 kg/cu. m

Probe Data

Serial No. : 500-00283
 Frequency : 1900.00 MHz
 Duty Cycle Factor : 8
 Conversion Factor : 5.2
 Probe Sensitivity : 1.20 1.20 1.20 $\mu\text{V}/(\text{V}/\text{m})^2$
 Compression Point : 95.00 mV
 Offset : 1.56 mm

1 gram SAR value : 0.160 W/kg
 10 gram SAR value : 0.079 W/kg
 Area Scan Peak SAR : 0.196 W/kg
 Zoom Scan Peak SAR : 0.390 W/kg

Plot 9#

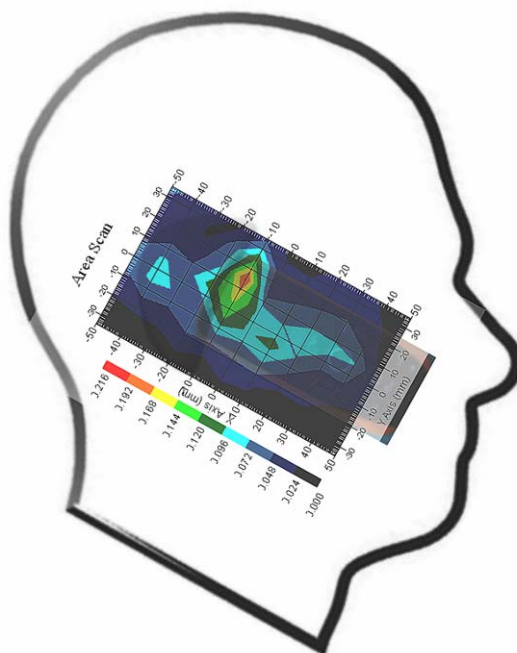

Test Laboratory: Bay Area Compliance Lab Corp. (Shenzhen)

Left Head Tilt (1909.8 MHz High Channel)

Measurement Data

Test mode : GSM
 Crest Factor : 8
 Scan Type : Complete
 Area Scan : 11x8x1 : Measurement x=10mm, y=10mm, z=4mm
 Zoom Scan : 7x7x7 : Measurement x=5mm, y=5mm, z=5mm
 Power Drift-Start : 0.103 W/kg
 Power Drift-Finish : 0.104 W/kg
 Power Drift (%) : 0.972

Tissue Data

Type : HEAD
 Frequency : 1900.00 MHz
 Epsilon : 41.52 F/m
 Sigma : 1.42 S/m
 Density : 1000.00 kg/cu. m

Probe Data

Serial No. : 500-00283
 Frequency : 1900.00 MHz
 Duty Cycle Factor : 8
 Conversion Factor : 5.2
 Probe Sensitivity : 1.20 1.20 1.20 $\mu\text{V}/(\text{V}/\text{m})^2$
 Compression Point : 95.00 mV
 Offset : 1.56 mm

1 gram SAR value : 0.135 W/kg
 10 gram SAR value : 0.064 W/kg
 Area Scan Peak SAR : 0.195 W/kg
 Zoom Scan Peak SAR : 0.310 W/kg

Plot 10#

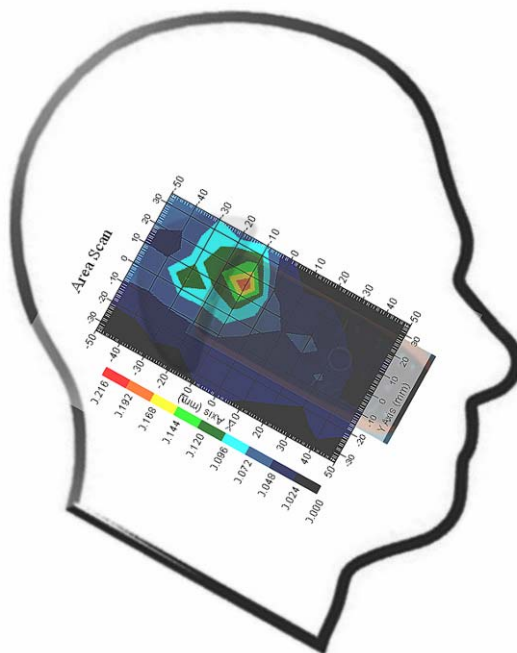

Test Laboratory: Bay Area Compliance Lab Corp. (Shenzhen)

Right Head Cheek (1909.8 MHz High Channel)

Measurement Data

Test mode : GSM
 Crest Factor : 8
 Scan Type : Complete
 Area Scan : 11x8x1 : Measurement x=10mm, y=10mm, z=4mm
 Zoom Scan : 7x7x7 : Measurement x=5mm, y=5mm, z=5mm
 Power Drift-Start : 0.126 W/kg
 Power Drift-Finish : 0.130 W/kg
 Power Drift (%) : 3.173

Tissue Data

Type : HEAD
 Frequency : 1900.00 MHz
 Epsilon : 41.52 F/m
 Sigma : 1.42 S/m
 Density : 1000.00 kg/cu. m

Probe Data

Serial No. : 500-00283
 Frequency : 1900.00 MHz
 Duty Cycle Factor : 8
 Conversion Factor : 5.2
 Probe Sensitivity : 1.20 1.20 1.20 $\mu\text{V}/(\text{V/m})^2$
 Compression Point : 95.00 mV
 Offset : 1.56 mm

1 gram SAR value : 0.157 W/kg
 10 gram SAR value : 0.083 W/kg
 Area Scan Peak SAR : 0.210 W/kg
 Zoom Scan Peak SAR : 0.330 W/kg

Plot 11#

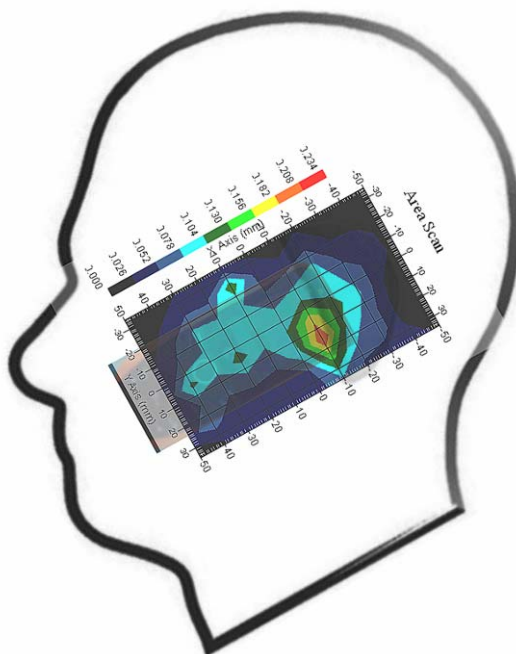

Test Laboratory: Bay Area Compliance Lab Corp. (Shenzhen)

Right Head Tilt (1909.8 MHz High Channel)

Measurement Data

Test mode : GSM
 Crest Factor : 8
 Scan Type : Complete
 Area Scan : 11x8x1 : Measurement x=10mm, y=10mm, z=4mm
 Zoom Scan : 7x7x7 : Measurement x=5mm, y=5mm, z=5mm
 Power Drift-Start : 0.109 W/kg
 Power Drift-Finish : 0.112 W/kg
 Power Drift (%) : 2.754

Tissue Data

Type : HEAD
 Frequency : 1900.00 MHz
 Epsilon : 41.52 F/m
 Sigma : 1.42 S/m
 Density : 1000.00 kg/cu. m

Probe Data

Serial No. : 500-00283
 Frequency : 1900.00 MHz
 Duty Cycle Factor : 8
 Conversion Factor : 5.2
 Probe Sensitivity : 1.20 1.20 1.20 $\mu\text{V}/(\text{V}/\text{m})^2$
 Compression Point : 95.00 mV
 Offset : 1.56 mm

1 gram SAR value : 0.129 W/kg
 10 gram SAR value : 0.057 W/kg
 Area Scan Peak SAR : 0.151 W/kg
 Zoom Scan Peak SAR : 0.283 W/kg

Plot 12#

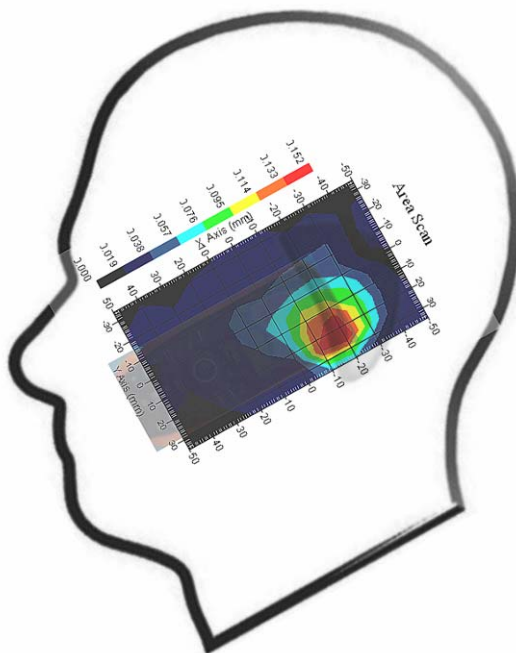

Test Laboratory: Bay Area Compliance Lab Corp. (Shenzhen)

Left Head Cheek-SIM2 (1909.8 MHz High Channel)

Measurement Data

Test mode : GSM
 Crest Factor : 8
 Scan Type : Complete
 Area Scan : 11x8x1 : Measurement x=10mm, y=10mm, z=4mm
 Zoom Scan : 7x7x7 : Measurement x=5mm, y=5mm, z=5mm
 Power Drift-Start : 0.129 W/kg
 Power Drift-Finish : 0.133 W/kg
 Power Drift (%) : 3.008

Tissue Data

Type : HEAD
 Frequency : 1900.00 MHz
 Epsilon : 41.52 F/m
 Sigma : 1.42 S/m
 Density : 1000.00 kg/cu. m

Probe Data

Serial No. : 500-00283
 Frequency : 1900.00 MHz
 Duty Cycle Factor : 8
 Conversion Factor : 5.2
 Probe Sensitivity : 1.20 1.20 1.20 $\mu\text{V}/(\text{V}/\text{m})^2$
 Compression Point : 95.00 mV
 Offset : 1.56 mm

1 gram SAR value : 0.152 W/kg
 10 gram SAR value : 0.083 W/kg
 Area Scan Peak SAR : 0.211 W/kg
 Zoom Scan Peak SAR : 0.362 W/kg

Plot 13#

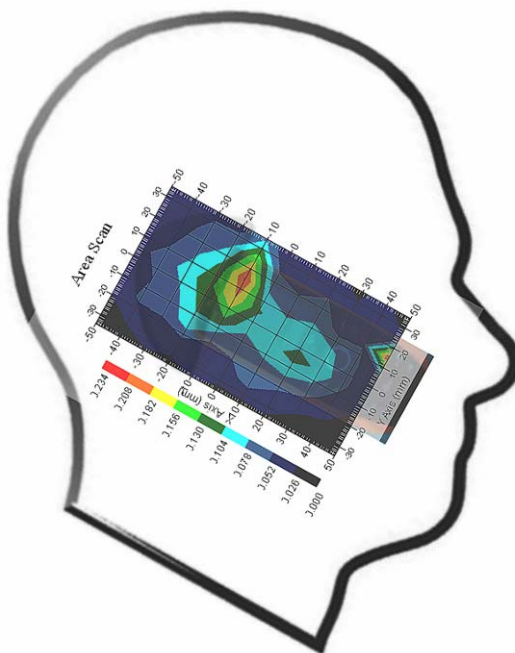

Test Laboratory: Bay Area Compliance Lab Corp. (Shenzhen)

Left Head Tilt-SIM2 (1909.8 MHz High Channel)

Measurement Data

Test mode : GSM
 Crest Factor : 8
 Scan Type : Complete
 Area Scan : 11x8x1 : Measurement x=10mm, y=10mm, z=4mm
 Zoom Scan : 7x7x7 : Measurement x=5mm, y=5mm, z=5mm
 Power Drift-Start : 0.098 W/kg
 Power Drift-Finish : 0.100 W/kg
 Power Drift (%) : 2.042

Tissue Data

Type : HEAD
 Frequency : 1900.00 MHz
 Epsilon : 41.52 F/m
 Sigma : 1.42 S/m
 Density : 1000.00 kg/cu. m

Probe Data

Serial No. : 500-00283
 Frequency : 1900.00 MHz
 Duty Cycle Factor : 8
 Conversion Factor : 5.2
 Probe Sensitivity : 1.20 1.20 1.20 $\mu\text{V}/(\text{V}/\text{m})^2$
 Compression Point : 95.00 mV
 Offset : 1.56 mm

1 gram SAR value : 0.127 W/kg
 10 gram SAR value : 0.053 W/kg
 Area Scan Peak SAR : 0.138 W/kg
 Zoom Scan Peak SAR : 0.259 W/kg

Plot 14#

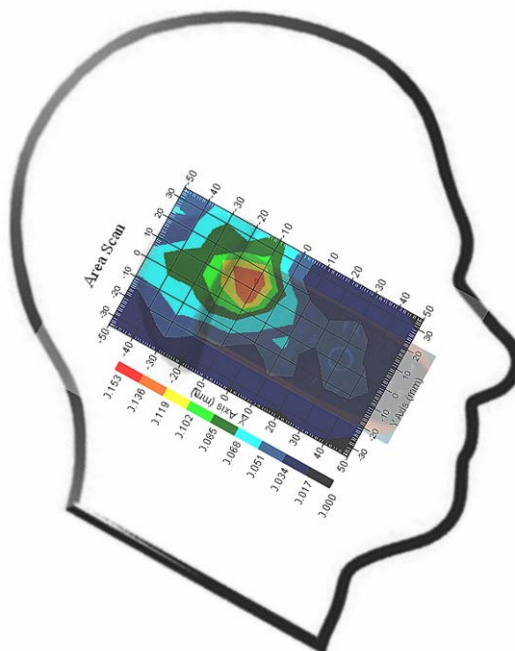

Test Laboratory: Bay Area Compliance Lab Corp. (Shenzhen)

Body- worn-Headset (1909.8 MHz High Channel)

Measurement Data

Test mode : GSM
 Crest Factor : 8
 Scan Type : Complete
 Area Scan : 8x11x1 : Measurement x=10mm, y=10mm, z=4mm
 Zoom Scan : 7x7x7 : Measurement x=5mm, y=5mm, z=5mm
 Power Drift-Start : 0.095 W/kg
 Power Drift-Finish : 0.098 W/kg
 Power Drift (%) : 3.061

Tissue Data

Type : Body
 Frequency : 1900.00 MHz
 Epsilon : 54.16 F/m
 Sigma : 1.54 S/m
 Density : 1000.00 kg/cu. m

Probe Data

Serial No. : 500-00283
 Frequency : 1900.00 MHz
 Duty Cycle Factor : 8
 Conversion Factor : 5.0
 Probe Sensitivity : 1.20 1.20 1.20 $\mu\text{V}/(\text{V}/\text{m})^2$
 Compression Point : 95.00 mV
 Offset : 1.56 mm

1 gram SAR value : 0.107 W/kg
 10 gram SAR value : 0.058 W/kg
 Area Scan Peak SAR : 0.125 W/kg
 Zoom Scan Peak SAR : 0.217 W/kg

Plot 15#

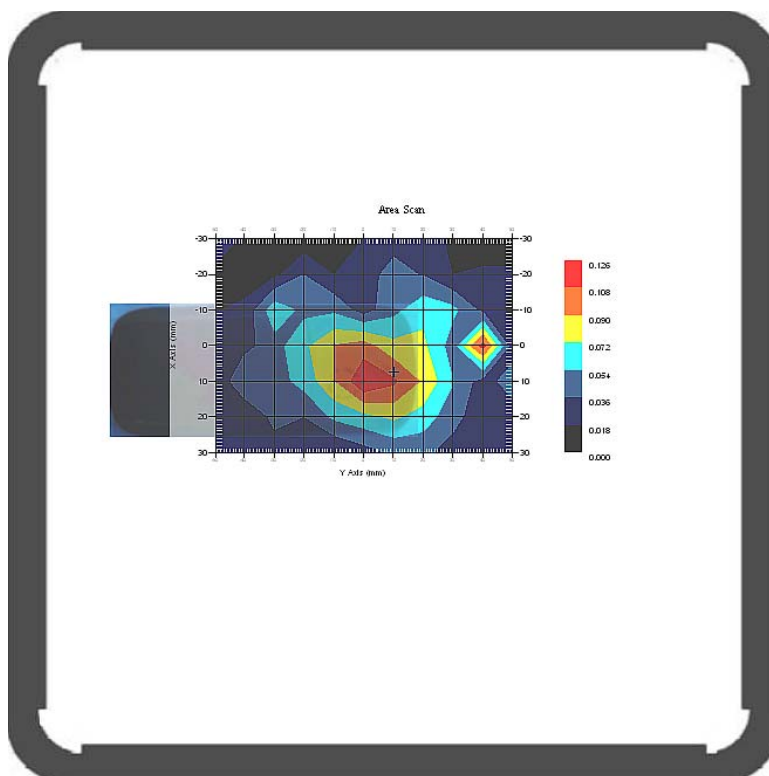

Test Laboratory: Bay Area Compliance Lab Corp. (Shenzhen)

Body- worn Back (1909.8 MHz High Channel)

Measurement Data

Test mode : GPRS
 Crest Factor : 4
 Scan Type : Complete
 Area Scan : 8x11x1 : Measurement x=10mm, y=10mm, z=4mm
 Zoom Scan : 7x7x7 : Measurement x=5mm, y=5mm, z=5mm
 Power Drift-Start : 0.178 W/kg
 Power Drift-Finish : 0.182 W/kg
 Power Drift (%) : 2.198

Tissue Data

Type : Body
 Frequency : 1900.00 MHz
 Epsilon : 54.16 F/m
 Sigma : 1.54 S/m
 Density : 1000.00 kg/cu. m

Probe Data

Serial No. : 500-00283
 Frequency : 1900.00 MHz
 Duty Cycle Factor : 4
 Conversion Factor : 5.0
 Probe Sensitivity : 1.20 1.20 1.20 $\mu\text{V}/(\text{V}/\text{m})^2$
 Compression Point : 95.00 mV
 Offset : 1.56 mm

1 gram SAR value : 0.195 W/kg
 10 gram SAR value : 0.118 W/kg
 Area Scan Peak SAR : 0.204 W/kg
 Zoom Scan Peak SAR : 0.271 W/kg

Plot 16#

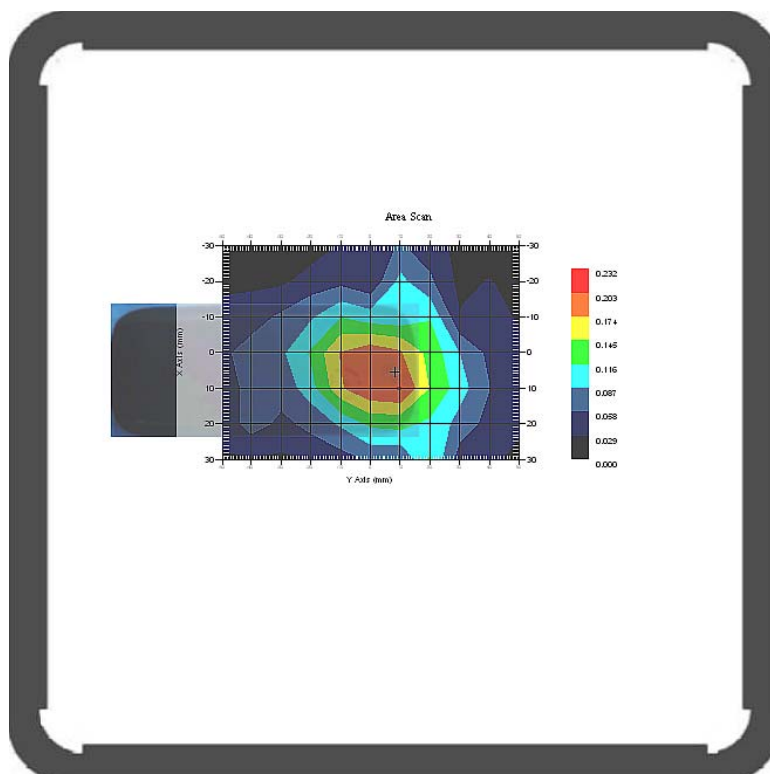

APPENDIX A – MEASUREMENT UNCERTAINTY

The uncertainty budget has been determined for the measurement system and is given in the following Table.

Measurement Uncertainty for 300MHz to 3GHz

| Source of Uncertainty | Tolerance Value | Probability Distribution | Divisor | c _i ¹ (1-g) | c _i ¹ (10-g) | Standard Uncertainty (1-g) % | Standard Uncertainty (10-g) % |
|--|-----------------|--------------------------|------------|--------------------------------------|---------------------------------------|---------------------------------|----------------------------------|
| Measurement System | | | | | | | |
| Probe Calibration | 3.5 | normal | 1 | 1 | 1 | 3.5 | 3.5 |
| Axial Isotropy | 3.7 | rectangular | $\sqrt{3}$ | (1-cp) ^{1/2} | $(\frac{1-cp}{2})^{1/2}$ | 1.5 | 1.5 |
| Hemispherical Isotropy | 10.9 | rectangular | $\sqrt{3}$ | \sqrt{cp} | \sqrt{cp} | 4.4 | 4.4 |
| Boundary Effect | 1.0 | rectangular | $\sqrt{3}$ | 1 | 1 | 0.6 | 0.6 |
| Linearity | 4.7 | rectangular | $\sqrt{3}$ | 1 | 1 | 2.7 | 2.7 |
| Detection Limit | 1.0 | rectangular | $\sqrt{3}$ | 1 | 1 | 0.6 | 0.6 |
| Readout Electronics | 1.0 | normal | 1 | 1 | 1 | 1.0 | 1.0 |
| Response Time | 0.8 | rectangular | $\sqrt{3}$ | 1 | 1 | 0.5 | 0.5 |
| Integration Time | 1.7 | rectangular | $\sqrt{3}$ | 1 | 1 | 1.0 | 1.0 |
| RF Ambient Condition -Noise | 0.95 | rectangular | $\sqrt{3}$ | 1 | 1 | 0.55 | 0.55 |
| RF Ambient Condition - Reflections | 3.0 | rectangular | $\sqrt{3}$ | 1 | 1 | 1.7 | 1.7 |
| Probe Positioner Mech. Restrictions | 0.4 | rectangular | $\sqrt{3}$ | 1 | 1 | 0.2 | 0.2 |
| Restriction | | | | | | | |
| Probe Positioning with respect to Phantom Shell | 2.9 | rectangular | $\sqrt{3}$ | 1 | 1 | 1.7 | 1.7 |
| Extrapolation and Integration | 3.7 | rectangular | $\sqrt{3}$ | 1 | 1 | 2.1 | 2.1 |
| Test Sample Positioning | 2.6 | normal | 1 | 1 | 1 | 2.6 | 2.6 |
| Device Holder Uncertainty | 2.0 | normal | 1 | 1 | 1 | 2.0 | 2.0 |
| Drift of Output Power | 0.4 | rectangular | $\sqrt{3}$ | 1 | 1 | 0.2 | 0.2 |
| Phantom and Setup | | | | | | | |
| Phantom Uncertainty(shape & thickness tolerance) | 3.4 | rectangular | $\sqrt{3}$ | 1 | 1 | 2.0 | 2.0 |
| Liquid Conductivity(target) | 5.0 | rectangular | $\sqrt{3}$ | 0.7 | 0.5 | 2.0 | 1.4 |
| Liquid Conductivity(meas.) | 2.6 | normal | 1 | 0.7 | 0.5 | 1.8 | 1.3 |
| Liquid Permittivity(target) | 5.0 | rectangular | $\sqrt{3}$ | 0.6 | 0.5 | 1.7 | 1.4 |
| Liquid Permittivity(meas.) | 2.7 | normal | 1 | 0.6 | 0.5 | 1.6 | 1.4 |
| Combined Uncertainty | | RSS | | | | 9.1 | 8.8 |
| Combined Uncertainty (coverage factor=2) | | Normal(k=2) | | | | 18.2 | 17.6 |

APPENDIX B – PROBE CALIBRATION CERTIFICATES

NCL CALIBRATION LABORATORIES

Calibration File No.: 1251-1258

Client.: BACL Lab

CERTIFICATE OF CALIBRATION

It is certified that the equipment identified below has been calibrated in the **NCL CALIBRATION LABORATORIES** by qualified personnel following recognized procedures and using transfer standards traceable to NRC/NIST.

Equipment: Miniature Isotropic RF Probe

Record of Calibration

Head and Body

Manufacturer: APREL Laboratories

Model No.: E-020

Serial No.: 500-00283

Calibration Procedure: D01-032-E020-V2, D22-012-Tissue, D28-002-Dipole
Project No: BACL-5607

Calibrated: 14th July 2011

Released on: 14th July 2011

Approved By: Stuart Nicol

This Calibration Certificate is Incomplete Unless Accompanied with the Calibration Results Summary

Released By: _____

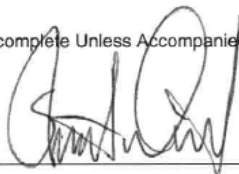

NCL CALIBRATION LABORATORIES

303 Terry Fox Drive, Suite 102
Kanata, Ontario
CANADA K2K 3J1

Division of APREL
TEL: (613) 435-8300
FAX: (613) 435-8306

NCL Calibration Laboratories

Division of APREL Inc.

Introduction

This Calibration Report reproduces the results of the calibration performed in line with the references listed below. Calibration is performed using accepted methodologies as per the references listed below. Probes are calibrated for air, and tissue and the values reported are the results from the physical quantification of the probe through metrological practices.

Calibration Method

Probes are calibrated using the following methods.

<1000MHz

TEM Cell for sensitivity in air

Standard phantom using temperature transfer method for sensitivity in tissue

>1000MHz

Waveguide* method to determine sensitivity in air and tissue

*Waveguide is numerically (simulation) assessed to determine the field distribution and power

The boundary effect for the probe is assessed using a standard flat phantom where the probe output is compared against a numerically simulated series of data points

References

- IEEE Standard 1528 (2003) including Amendment 1
IEEE Recommended Practice for Determining the Peak Spatial-Average Specific Absorption Rate (SAR) in the Human Head from Wireless Communications Devices: Measurement Techniques
- EN 62209-1 (2006)
Human Exposure to RF Fields from hand-held and body-mounted wireless communication devices - Human models, instrumentation, and procedures-Part 1: Procedure to measure the Specific Absorption Rate (SAR) for hand-held mobile wireless devices
- IEC 62209-2 Ed. 1.0 (2010-03)
Human exposure to RF fields from hand-held and body-mounted wireless devices - Human models, instrumentation, and procedures - Part 2: specific absorption rate (SAR) for wireless communication devices (30 MHz - 6 GHz)
- TP-D01-032-E020-V2 E-Field probe calibration procedure
- D22-012-Tissue dielectric tissue calibration procedure
- D28-002-Dipole procedure for validation of SAR system using a dipole
- IEEE 1309 Draft Standard for Calibration of Electromagnetic Field Sensors and Probes, Excluding Antennas, from 9kHz to 40GHz

Page 2 of 10

This page has been reviewed for content and attested to on Page 2 of this document.

NCL Calibration Laboratories

Division of APREL Inc.

Conditions

Probe 500-00283 was a new probe taken from stock.

Ambient Temperature of the Laboratory: 22 °C +/- 1.5°C
Temperature of the Tissue: 21 °C +/- 1.5°C
Relative Humidity: < 60%

Primary Measurement Standards

| Instrument | Serial Number | Cal due date |
|----------------------------------|---------------|----------------|
| Power meter Anritsu MA2408A | 90025437 | Nov.4, 2011 |
| Power Sensor Anritsu MA2481D | 103555 | Nov 4, 2011 |
| Attenuator HP 8495A (70dB) | 1944A10711 | Sept. 14, 2011 |
| Network Analyzer Anritsu MT8801C | MB11855 | Feb. 8, 2012 |

Secondary Measurement Standards

Signal Generator Agilent E4438C -506 MY55182336 June 7, 2012

Attestation

The below named signatories have conducted the calibration and review of the data which is presented in this calibration report.

We the undersigned attest that to the best of our knowledge the calibration of this probe has been accurately conducted and that all information contained within this report has been reviewed for accuracy.

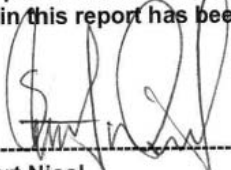

Stuart Nicol

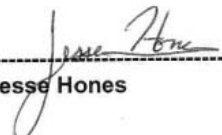

Jesse Hones

NCL Calibration Laboratories

Division of APREL Inc.

Probe Summary

| | |
|-----------------------|------------------------|
| Probe Type: | E-Field Probe E020 |
| Serial Number: | 500-00283 |
| Frequency: | As presented on page 5 |
| Sensor Offset: | 1.56 |
| Sensor Length: | 2.5 |
| Tip Enclosure: | Composite* |
| Tip Diameter: | < 2.9 mm |
| Tip Length: | 55 mm |
| Total Length: | 289 mm |

*Resistive to recommended tissue recipes per IEEE-1528

Sensitivity in Air

| | |
|---------------------------------|---|
| Channel X: | $1.2 \mu\text{V}/(\text{V}/\text{m})^2$ |
| Channel Y: | $1.2 \mu\text{V}/(\text{V}/\text{m})^2$ |
| Channel Z: | $1.2 \mu\text{V}/(\text{V}/\text{m})^2$ |
| Diode Compression Point: | 95 mV |

Page 4 of 10

This page has been reviewed for content and attested to on Page 2 of this document.

NCL Calibration Laboratories

Division of APREL Inc.

Calibration for Tissue (Head H, Body B)

| Frequency | Tissue Type | Measured Epsilon | Measured Sigma | Calibration Uncertainty | Tolerance Uncertainty for 5%* | Conversion Factor |
|---------------|-------------|------------------|----------------|-------------------------|-------------------------------|-------------------|
| 450 H | Head | X | X | X | X | X |
| 450 B | Body | X | X | X | X | X |
| 750 H | Head | X | X | X | X | X |
| 750 B | Body | X | X | X | X | X |
| 835 H | Head | 42.35 | 0.938 | 3.5 | 3.4 | 6.6 |
| 835 B | Body | 56.65 | 1.018 | 3.5 | 3.4 | 6.6 |
| 900 H | Head | 41.35 | 0.98 | 3.5 | 3.4 | 6 |
| 900 B | Body | 56.08 | 1.05 | 3.5 | 3.4 | 6 |
| 1450 H | Head | X | X | X | X | X |
| 1450 B | Body | X | X | X | X | X |
| 1500 H | Head | X | X | X | X | X |
| 1500 B | Body | X | X | X | X | X |
| 1640 H | Head | X | X | X | X | X |
| 1640 B | Body | X | X | X | X | X |
| 1750 H | Head | 38.72 | 1.35 | 3.5 | 3.4 | 5.1 |
| 1750 B | Body | 51.62 | 1.48 | 3.5 | 3.4 | 4.8 |
| 1800 H | Head | X | X | X | X | X |
| 1800 B | Body | X | X | X | X | X |
| 1900 H | Head | 38.72 | 1.35 | 3.5 | 2.7 | 5.2 |
| 1900 B | Body | 51.62 | 1.48 | 3.5 | 2.7 | 5 |
| 2000 H | Head | X | X | X | X | X |
| 2000 B | Body | X | X | X | X | X |
| 2100 H | Head | X | X | X | X | X |
| 2100 B | Body | X | X | X | X | X |
| 2300 H | Head | X | X | X | X | X |
| 2300 B | Body | X | X | X | X | X |
| 2450 H | Head | 38.06 | 1.87 | 3.5 | 3.5 | 4.9 |
| 2450 B | Body | 50.22 | 2.03 | 3.5 | 3.5 | 4.3 |
| 2600 H | Head | X | X | X | X | X |
| 2600 B | Body | X | X | X | X | X |
| 3000 H | Head | X | X | X | X | X |
| 3000 B | Body | X | X | X | X | X |
| 3600 H | Head | X | X | X | X | X |
| 3600 B | Body | X | X | X | X | X |
| 5200 H | Head | X | X | X | X | X |
| 5200 B | Body | X | X | X | X | X |
| 5600 H | Head | X | X | X | X | X |
| 5600 B | Body | X | X | X | X | X |
| 5800 H | Head | X | X | X | X | X |
| 5800 B | Body | X | X | X | X | X |

NCL Calibration Laboratories

Division of APREL Inc.

Boundary Effect:

Uncertainty resulting from the boundary effect is less than 2.1% for the distance between the tip of the probe and the tissue boundary, when less than 0.58mm.

Spatial Resolution:

The spatial resolution uncertainty is less than 1.5% for 4.9mm diameter probe.
The spatial resolution uncertainty is less than 1.0% for 2.5mm diameter probe.

DAQ-PAQ Contribution

To minimize the uncertainty calculation all tissue sensitivity values were calculated using a load impedance of 5 MΩ.

Boundary Effect:

For a distance of 0.58mm the worst case evaluated uncertainty (increase in the probe sensitivity) is less than 2.1%.

NOTES:

*The maximum deviation from the centre frequency when comparing the lower to upper range is listed.

Page 6 of 10

This page has been reviewed for content and attested to on Page 2 of this document.

NCL Calibration Laboratories
Division of APREL Inc.

Receiving Pattern Air

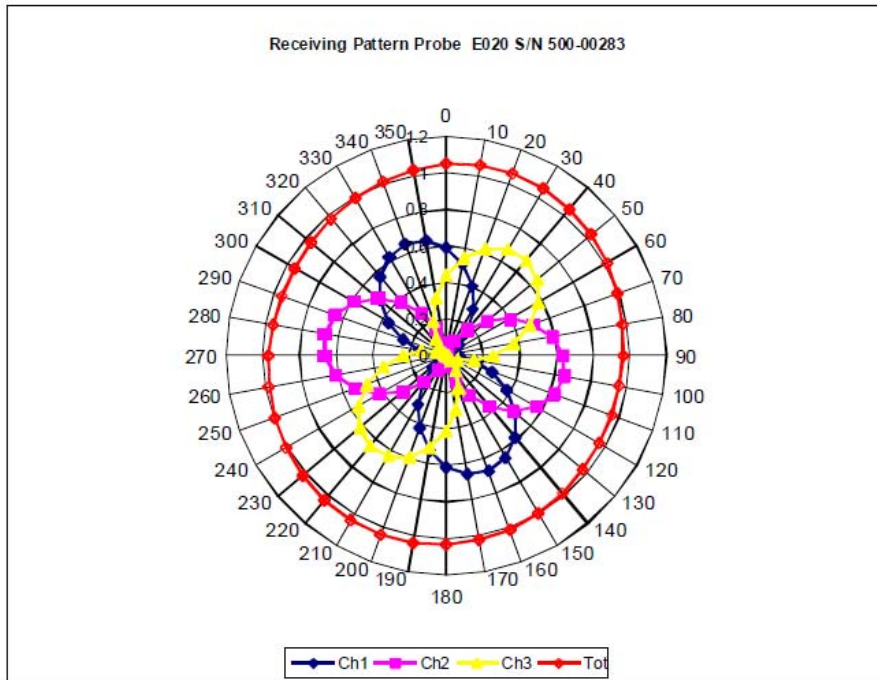

Page 7 of 10
This page has been reviewed for content and attested to on Page 2 of this document.

NCL Calibration Laboratories

Division of APREL Inc.

Isotropy Error Air

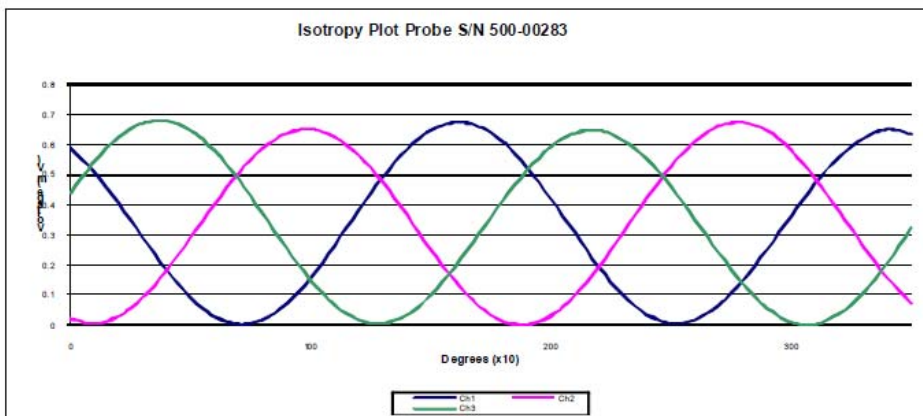
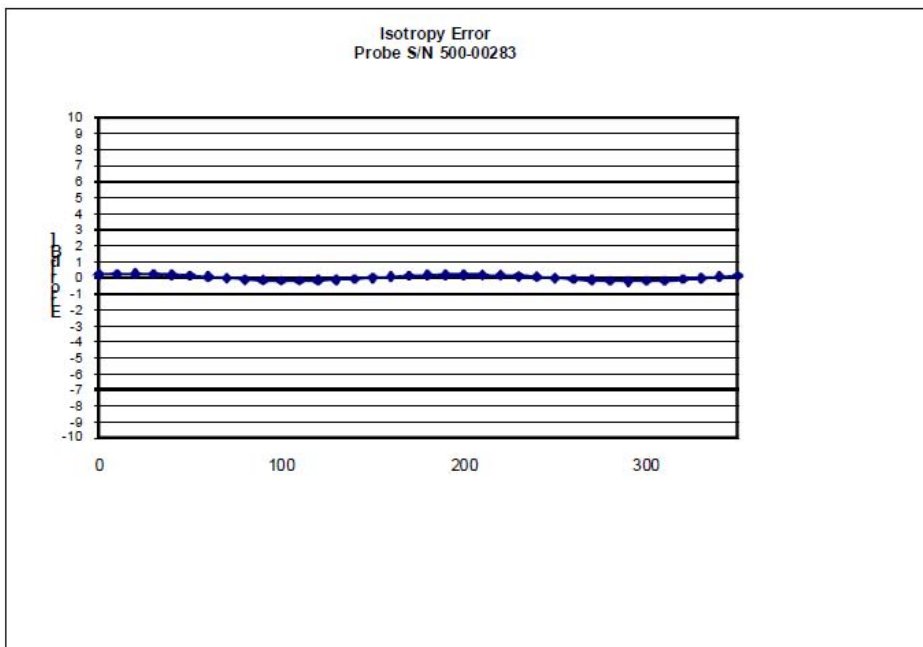

Isotropicity Tissue:

0.10 dB

NCL Calibration Laboratories

Division of APREL Inc.

Dynamic Range

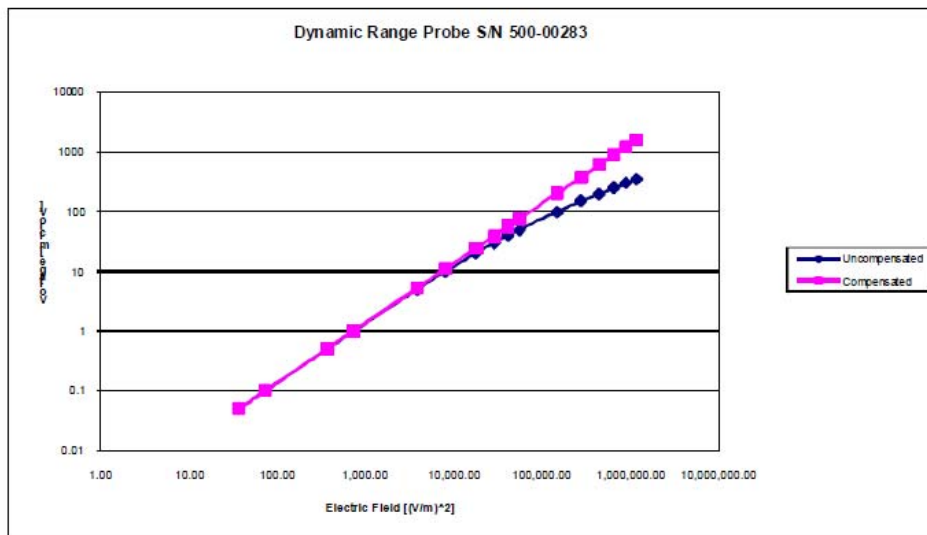

NCL Calibration Laboratories

Division of APREL Inc.

Video Bandwidth

Probe Frequency Characteristics

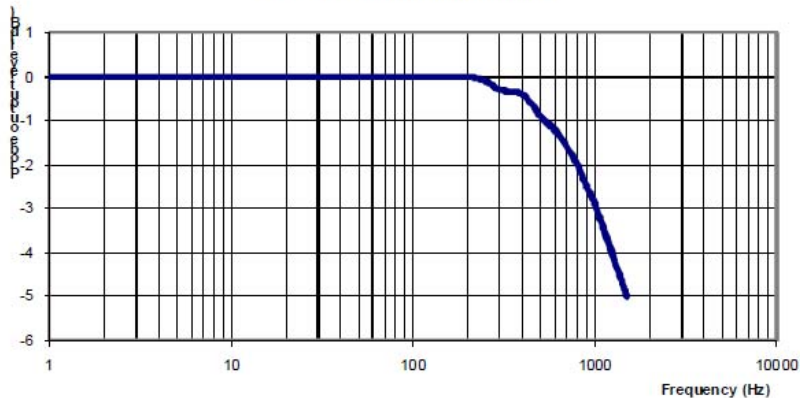

Video Bandwidth at 500 Hz 1 dB
Video Bandwidth at 1.02 KHz: 3 dB

Test Equipment

The test equipment used during Probe Calibration, manufacturer, model number and, current calibration status are listed and located on the main APREL server R:\NCL\Calibration Equipment\Instrument List May 2011.

Page 10 of 10
This page has been reviewed for content and attested to on Page 2 of this document.

APPENDIX C – DIPOLE CALIBRATION CERTIFICATES

NCL CALIBRATION LABORATORIES

Calibration File No: DC-1327
Project Number: BAC-dipole-cal-5618

CERTIFICATE OF CALIBRATION

It is certified that the equipment identified below has been calibrated in the
NCL CALIBRATION LABORATORIES by qualified personnel following recognized
procedures and using transfer standards traceable to NRC/NIST.

Validation Dipole(Head and Body)

Manufacturer: APREL Laboratories

Part number: ALS-D-835-S-2

Frequency: 835 MHz

Serial No: 180-00558

Customer: Bay Area Compliance Laboratory

Calibrated: 25th August 2011

Released on: 25th August 2011

This Calibration Certificate is Incomplete Unless Accompanied with the Calibration Results Summary

Released By: _____

NCL CALIBRATION LABORATORIES

Suite 102, 303 Terry Fox Dr.
Kanata, ONTARIO
CANADA K2K 3J1

Division of APREL Lab.
TEL: (613) 435-8300
FAX: (613)435-8306

NCL Calibration Laboratories

Division of APREL Laboratories.

Conditions

Dipole 180-00558 was received in good condition and a re-calibration.

Ambient Temperature of the Laboratory: 22 °C +/- 0.5°C

Temperature of the Tissue: 21 °C +/- 0.5°C

We the undersigned attest that to the best of our knowledge the calibration of this device has been accurately conducted and that all information contained within this report has been reviewed for accuracy.

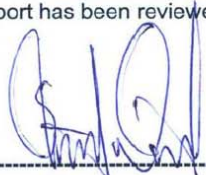

Stuart Nicol



C. Teodorian

| Primary Measurement Standards Instrument | Serial Number | Cal due date |
|--|-----------------|--------------|
| Power meter Anritsu MA2408A | 245025437 | Nov.4, 2011 |
| Power Sensor Anritsu MA2481D | 103555 | Nov 4, 2011 |
| Attenuator HP 8495A (70dB) 1 | 944A10711 | Aug.8, 2012 |
| Network Analyzer Agilent E5071C | 1334746J | Feb. 8, 2012 |
| Secondary Measurement Standards | | |
| Signal Generator Agilent E4438C | -506 MY55182336 | June 7, 2012 |

This page has been reviewed for content and attested to by signature within this document.

NCL Calibration Laboratories

Division of APREL Laboratories.

Calibration Results Summary

The following results relate the Calibrated Dipole and should be used as a quick reference for the user.

Mechanical Dimensions

Length: 162.2 mm
Height: 89.4 mm

Electrical Specification

| Tissue | Frequency | SWR: | Return Loss | Impedance |
|--------|-----------|----------|-------------|-----------|
| Head | 835 MHz | 1.0417 U | -35.395dB | 49.020 Ω |
| Body | 835 MHz | 1.1177 U | -25.424dB | 55.435 Ω |

System Validation Results

| Tissue | Frequency | 1 Gram | 10 Gram | Peak |
|--------|-----------|--------|---------|--------|
| Head | 835 MHz | 9.590 | 6.003 | 15.013 |
| Body | 835 MHz | 9.684 | 6.263 | 14.23 |

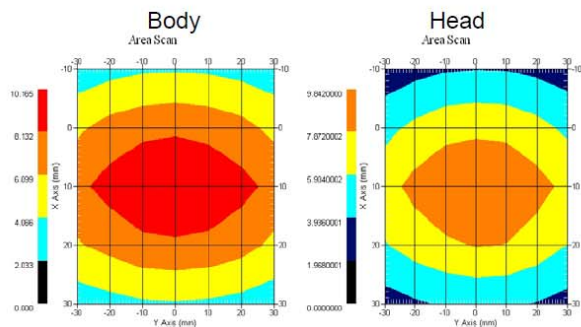

This page has been reviewed for content and attested to by signature within this document.

NCL Calibration Laboratories

Division of APREL Laboratories.

Introduction

This Calibration Report has been produced in line with the SSI Dipole Calibration Procedure SSI-TP-018-ALSAS. The results contained within this report are for Validation Dipole 180-00558. The calibration routine consisted of a three-step process. Step 1 was a mechanical verification of the dipole to ensure that it meets the mechanical specifications. Step 2 was an Electrical Calibration for the Validation Dipole, where the SWR, Impedance, and the Return loss were assessed. Step 3 involved a System Validation using the ALSAS-10U, along with APREL E-020 130 MHz to 26 GHz E-Field Probe Serial Number 212.

References

SSI-TP-018-ALSAS Dipole Calibration Procedure
SSI-TP-016 Tissue Calibration Procedure
IEEE 1528 "Recommended Practice for Determining the Peak Spatial-Average Specific Absorption Rate (SAR) in the Human Body Due to Wireless Communications Devices: Experimental Techniques"

Conditions

Dipole 180-00558 was new taken from stock.

Ambient Temperature of the Laboratory: 22 °C +/- 0.5°C
Temperature of the Tissue: 20 °C +/- 0.5°C

Dipole Calibration uncertainty

The calibration uncertainty for the dipole is made up of various parameters presented below.

| | |
|--------------------------|---------------------------|
| Mechanical | 1% |
| Positioning Error | 1.22% |
| Electrical | 1.7% |
| Tissue | 2.2% |
| Dipole Validation | 2.2% |
| TOTAL | 8.32% (16.64% K=2) |

This page has been reviewed for content and attested to by signature within this document.

4

NCL Calibration Laboratories

Division of APREL Laboratories.

Dipole Calibration Results

Mechanical Verification

| APREL Length | APREL Height | Measured Length | Measured Height |
|--------------|--------------|-----------------|-----------------|
| 161.0 mm | 89.8 mm | 162.2 mm | 89.4 mm |

| Tissue Type | Return Loss: | SWR: | Impedance: |
|-------------|--------------|----------|------------|
| Head | -35.395 dB | 1.0417 U | 49.020Ω |
| Body | -25.454 dB | 1.1177 U | 55.435Ω |

Tissue Validation

| | Dielectric constant, ϵ_r | Conductivity, σ [S/m] |
|--------------------|-----------------------------------|------------------------------|
| Head Tissue 835MHz | 41.78 | 0.92 |
| Body Tissue 835MHz | 56.37 | 0.95 |

This page has been reviewed for content and attested to by signature within this document.

NCL Calibration Laboratories

Division of APREL Laboratories.

The Following Graphs are the results as displayed on the Vector Network Analyzer.

S11 Parameter Return Loss

Head Tissue

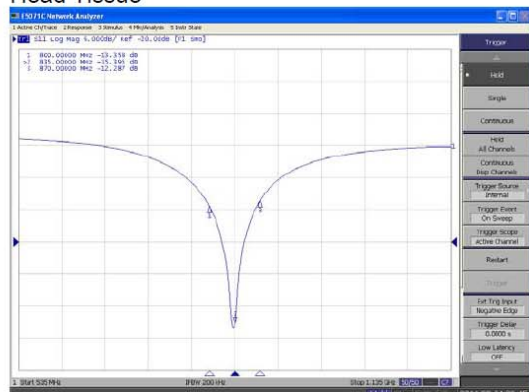

Body Tissue

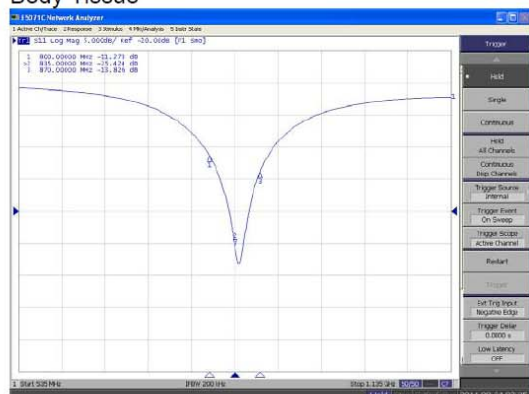

This page has been reviewed for content and attested to by signature within this document.

NCL Calibration Laboratories

Division of APREL Laboratories.

**SWR
Head**

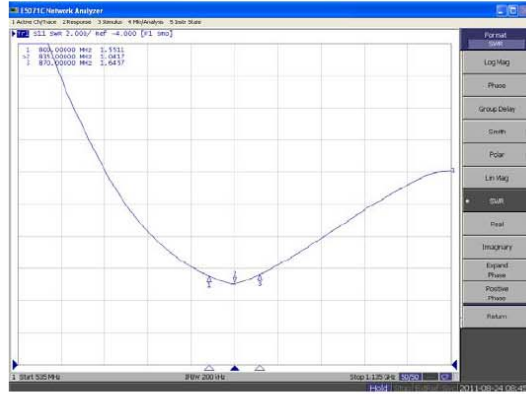

Body

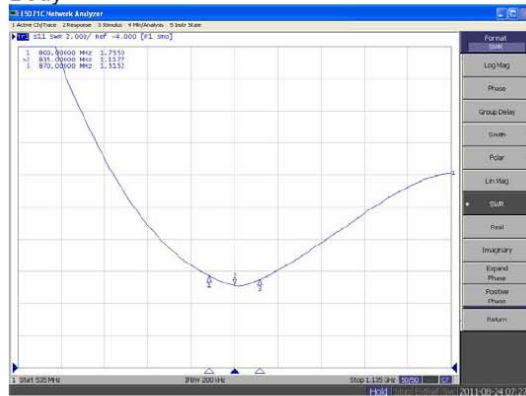

This page has been reviewed for content and attested to by signature within this document.

7

NCL Calibration Laboratories

Division of APREL Laboratories.

Smith Chart Dipole Impedance

Head

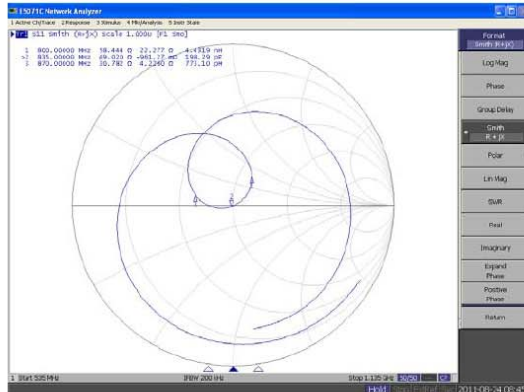

Body

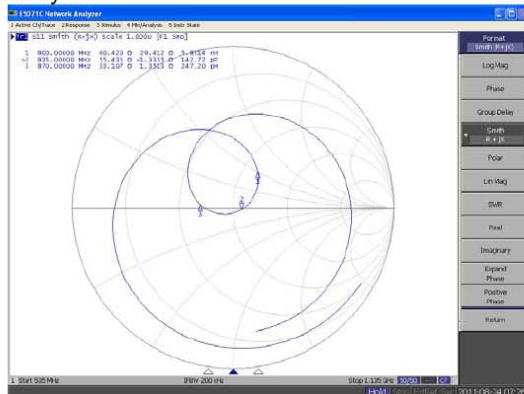

This page has been reviewed for content and attested to by signature within this document.

NCL Calibration Laboratories

Division of APREL Laboratories.

Test Equipment

The test equipment used during Probe Calibration, manufacturer, model number and, current calibration status are listed and located on the main APREL server R:\NCL\Calibration Equipment\Instrument List 2011.

This page has been reviewed for content and attested to by signature within this document.

9

NCL CALIBRATION LABORATORIES

Calibration File No: DC-1331
Project Number: BAC-dipole –cal-5615

CERTIFICATE OF CALIBRATION

It is certified that the equipment identified below has been calibrated in the
NCL CALIBRATION LABORATORIES by qualified personnel following recognized
procedures and using transfer standards traceable to NRC/NIST.

Validation Dipole (Head & Body)

Manufacturer: APREL Laboratories
Part number: ALS-D-1900-S-2
Frequency: 1900 MHz
Serial No: 210-00710

Customer: Bay Area Compliance Laboratory

Calibrated: 25th August, 2011
Released on: 25th August, 2011

This Calibration Certificate is Incomplete Unless Accompanied with the Calibration Results Summary

Released By: _____

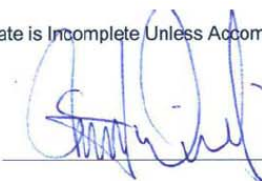

NCL CALIBRATION LABORATORIES

Suite 102, 303 Terry Fox Dr.
Kanata, ONTARIO
CANADA K2K 3J1

Division of APREL Lab.
TEL: (613) 435-8300
FAX: (613)435-8306

NCL Calibration Laboratories

Division of APREL Laboratories.

Conditions

Dipole 210-00710 was received in good condition and was a re-calibration.

Ambient Temperature of the Laboratory: 22 °C +/- 0.5°C

Temperature of the Tissue: 21 °C +/- 0.5°C

We the undersigned attest that to the best of our knowledge the calibration of this device has been accurately conducted and that all information contained within this report has been reviewed for accuracy.

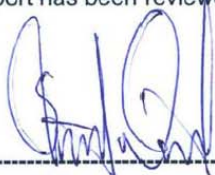

Stuart Nicol



C. Teodorian

Primary Measurement Standards

| Instrument | Serial Number | Cal due date |
|---------------------------------|----------------------|---------------------|
| Power meter Anritsu MA2408A | 245025437 | Nov.4, 2011 |
| Power Sensor Anritsu MA2481D | 103555 | Nov 4, 2011 |
| Attenuator HP 8495A (70dB) 1 | 944A10711 | Aug.8, 2012 |
| Network Analyzer Agilent E5071C | 1334746J | Feb. 8, 2012 |

Secondary Measurement Standards

| | | |
|---------------------------------|-----------------|--------------|
| Signal Generator Agilent E4438C | -506 MY55182336 | June 7, 2012 |
|---------------------------------|-----------------|--------------|

This page has been reviewed for content and attested to by signature within this document.

NCL Calibration Laboratories

Division of APREL Laboratories.

Calibration Results Summary

The following results relate the Calibrated Dipole and should be used as a quick reference for the user.

Mechanical Dimensions

Length: 67.1 mm
Height: 38.9 mm

Electrical Specification

| Tissue | Frequency | SWR: | Return Loss | Impedance |
|--------|-----------|----------|-------------|-----------|
| Head | 1900MHz | 1.0417 U | -35.395dB | 49.020 Ω |
| Body | 1900MHz | 1.1177 U | -25.424dB | 55.435 Ω |

System Validation Results

| Tissue | Frequency | 1 Gram | 10 Gram | Peak |
|--------|-----------|--------|---------|--------|
| Head | 1900 MHz | 39.648 | 20.311 | 73.365 |
| Body | 1900 MHz | 39.769 | 20.176 | 75.866 |

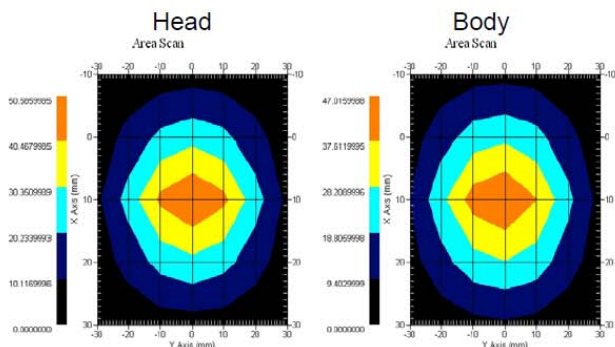

This page has been reviewed for content and attested to by signature within this document.

NCL Calibration Laboratories

Division of APREL Laboratories.

Introduction

This Calibration Report has been produced in line with the SSI Dipole Calibration Procedure SSI-TP-018-ALSAS. The results contained within this report are for Validation Dipole 210-00710. The calibration routine consisted of a three-step process. Step 1 was a mechanical verification of the dipole to ensure that it meets the mechanical specifications. Step 2 was an Electrical Calibration for the Validation Dipole, where the SWR, Impedance, and the Return loss were assessed. Step 3 involved a System Validation using the ALSAS-10U, along with APREL E-020 130 MHz to 26 GHz E-Field Probe Serial Number 212.

References

SSI-TP-018-ALSAS Dipole Calibration Procedure
SSI-TP-016 Tissue Calibration Procedure
IEEE 1528 "Recommended Practice for Determining the Peak Spatial-Average Specific Absorption Rate (SAR) in the Human Body Due to Wireless Communications Devices: Experimental Techniques"

Conditions

Dipole 210-00710 was new taken from stock.

Ambient Temperature of the Laboratory: 22 °C +/- 0.5°C
Temperature of the Tissue: 20 °C +/- 0.5°C

Dipole Calibration uncertainty

The calibration uncertainty for the dipole is made up of various parameters presented below.

| | |
|--------------------------|---------------------------|
| Mechanical | 1% |
| Positioning Error | 1.22% |
| Electrical | 1.7% |
| Tissue | 2.2% |
| Dipole Validation | 2.2% |
| TOTAL | 8.32% (16.64% K=2) |

This page has been reviewed for content and attested to by signature within this document.

4

NCL Calibration Laboratories

Division of APREL Laboratories.

Dipole Calibration Results

Mechanical Verification

| APREL Length | APREL Height | Measured Length | Measured Height |
|--------------|--------------|-----------------|-----------------|
| 68.0 mm | 39.5 mm | 67.1mm | 38.9 mm |

Electrical Validation

| Tissue Type | Return Loss: | SWR: | Impedance: |
|-------------|--------------|----------|------------|
| Head | -29.360 dB | 1.0732 U | 47.869 Ω |
| Body | -22.799 dB | 1.1566 U | 48.022 Ω |

Tissue Validation

| | Dielectric constant, ϵ_r | Conductivity, σ [S/m] |
|---------------------|-----------------------------------|------------------------------|
| Head Tissue 1900MHz | 38.4 | 1.43 |
| Body Tissue 1900MHz | 51.87 | 1.59 |

This page has been reviewed for content and attested to by signature within this document.

NCL Calibration Laboratories

Division of APREL Laboratories.

The Following Graphs are the results as displayed on the Vector Network Analyzer.

S11 Parameter Return Loss

Head

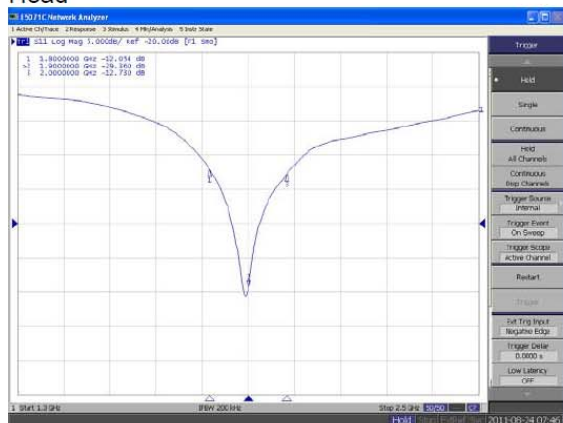

Body

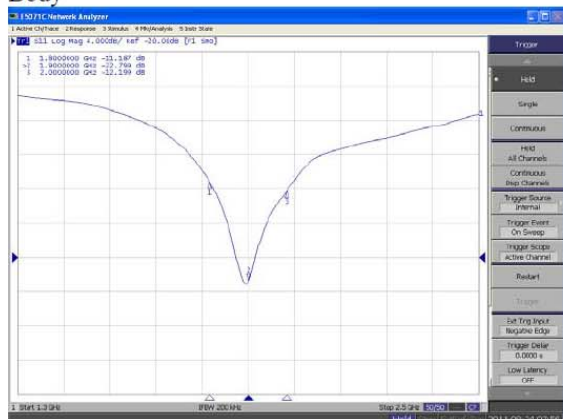

This page has been reviewed for content and attested to by signature within this document.

NCL Calibration Laboratories

Division of APREL Laboratories.

SWR

Head



Body

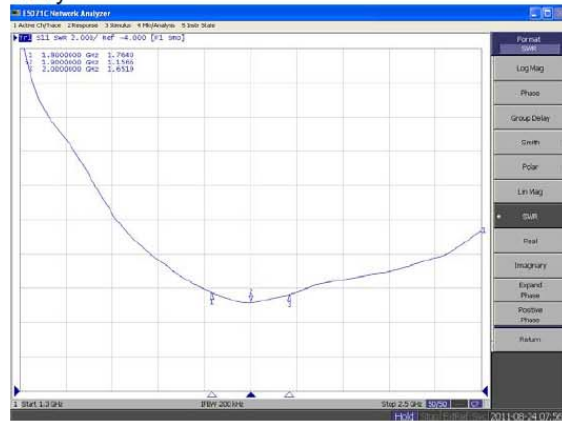

This page has been reviewed for content and attested to by signature within this document.

NCL Calibration Laboratories

Division of APREL Laboratories.

Smith Chart Dipole Impedance

Head

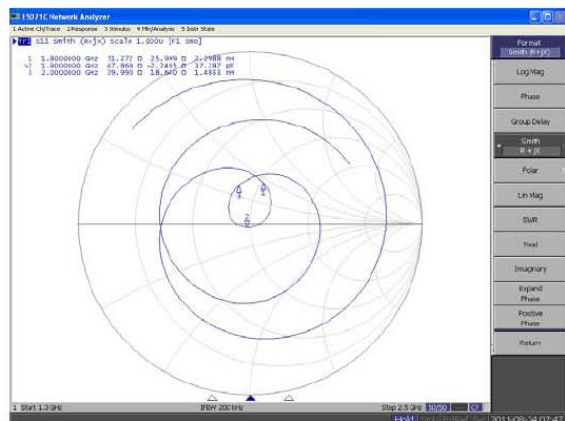

Body

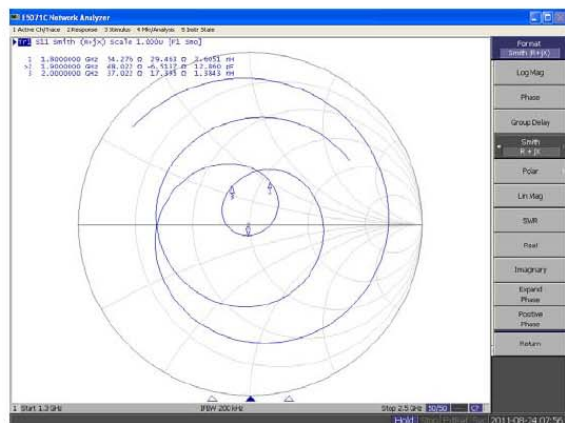

This page has been reviewed for content and attested to by signature within this document.

NCL Calibration Laboratories

Division of APREL Laboratories.

Test Equipment

The test equipment used during Probe Calibration, manufacturer, model number and, current calibration status are listed and located on the main APREL server R:\NCL\Calibration Equipment\Instrument List 2011

This page has been reviewed for content and attested to by signature within this document.

9

APPENDIX D – EUT TEST POSITION PHOTOS

Liquid depth $\geq 15\text{cm}$

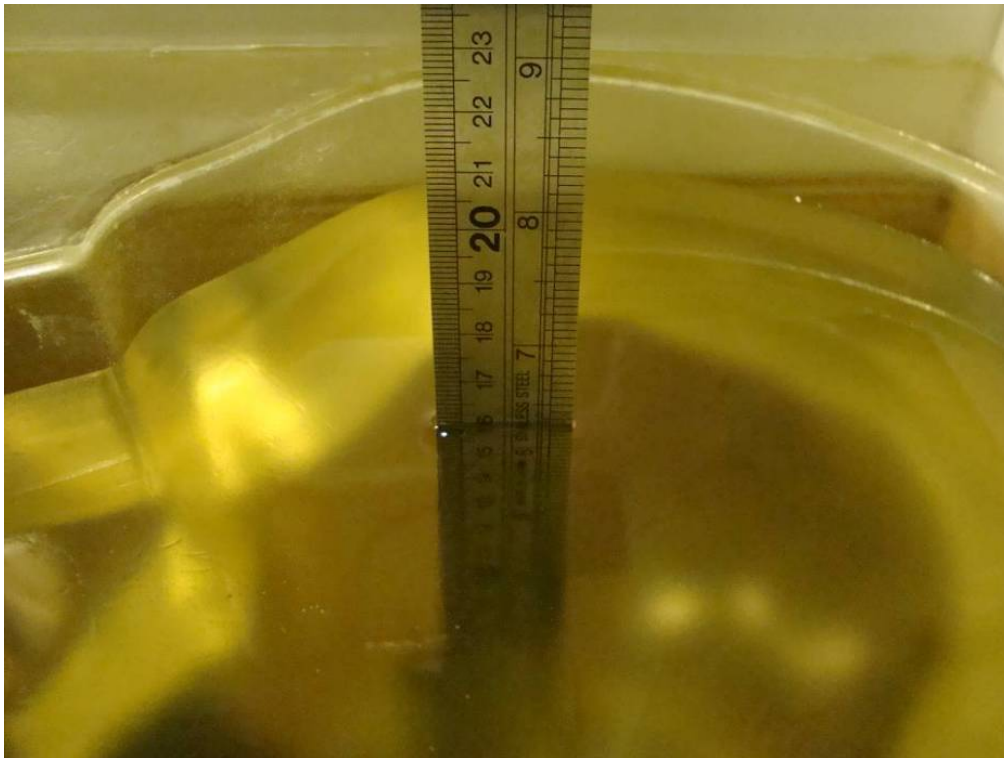

Body-worn-Headset Setup Photo

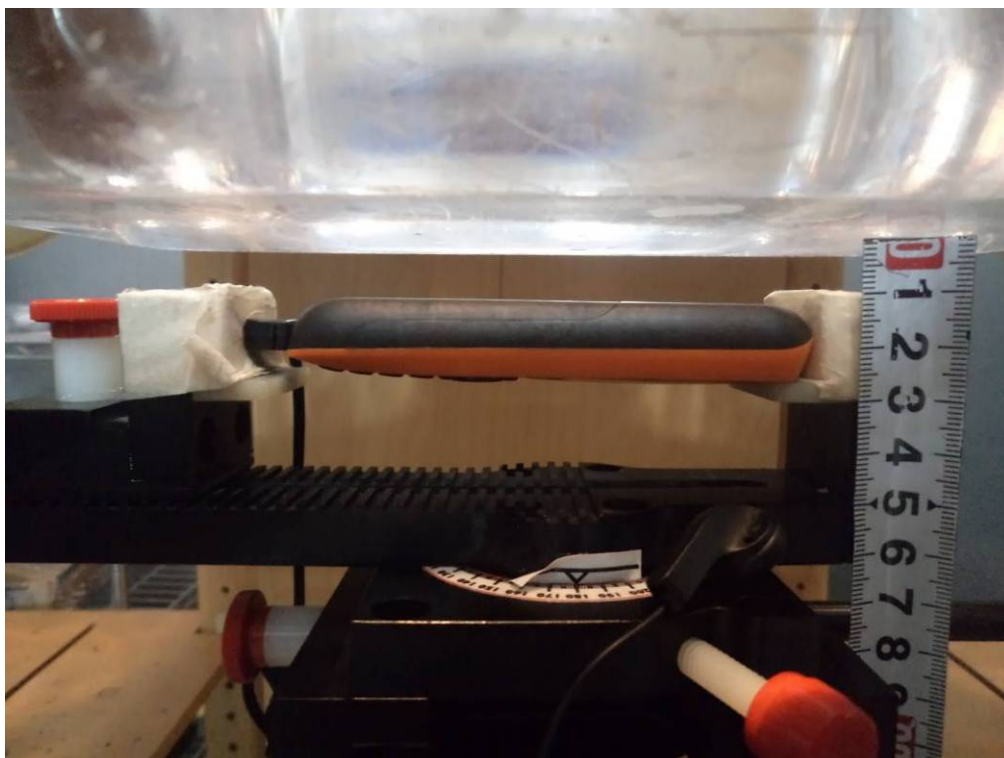

Left Head Touch Setup Photo

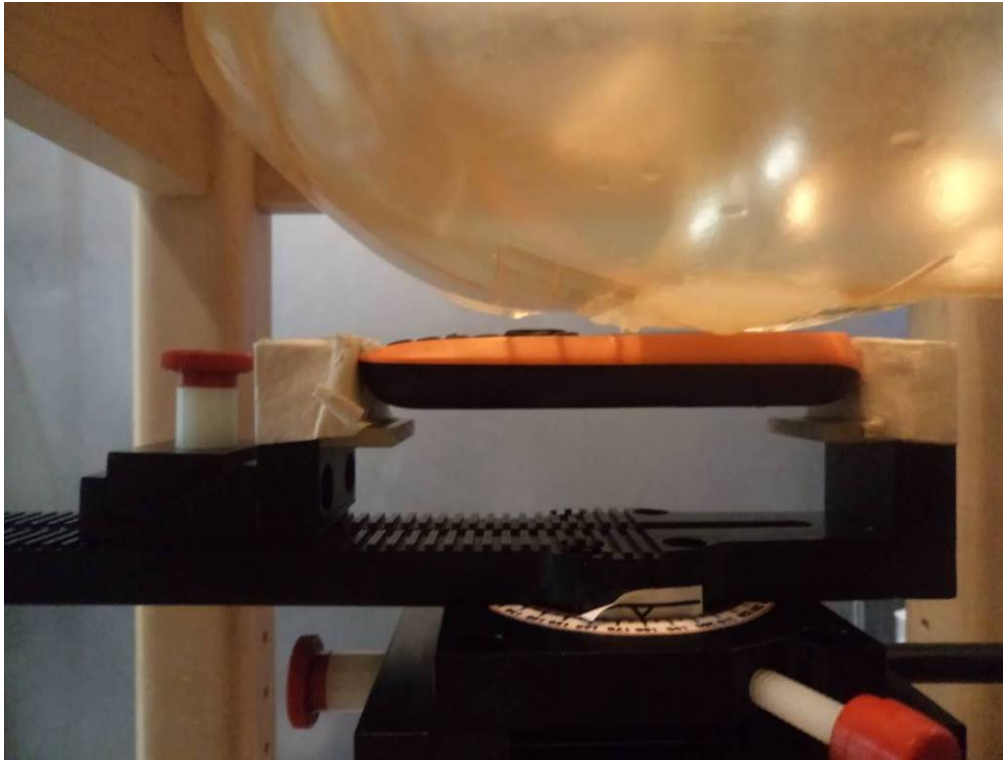

Left Head Tilt Setup Photo



Right Head Touch Setup Photo

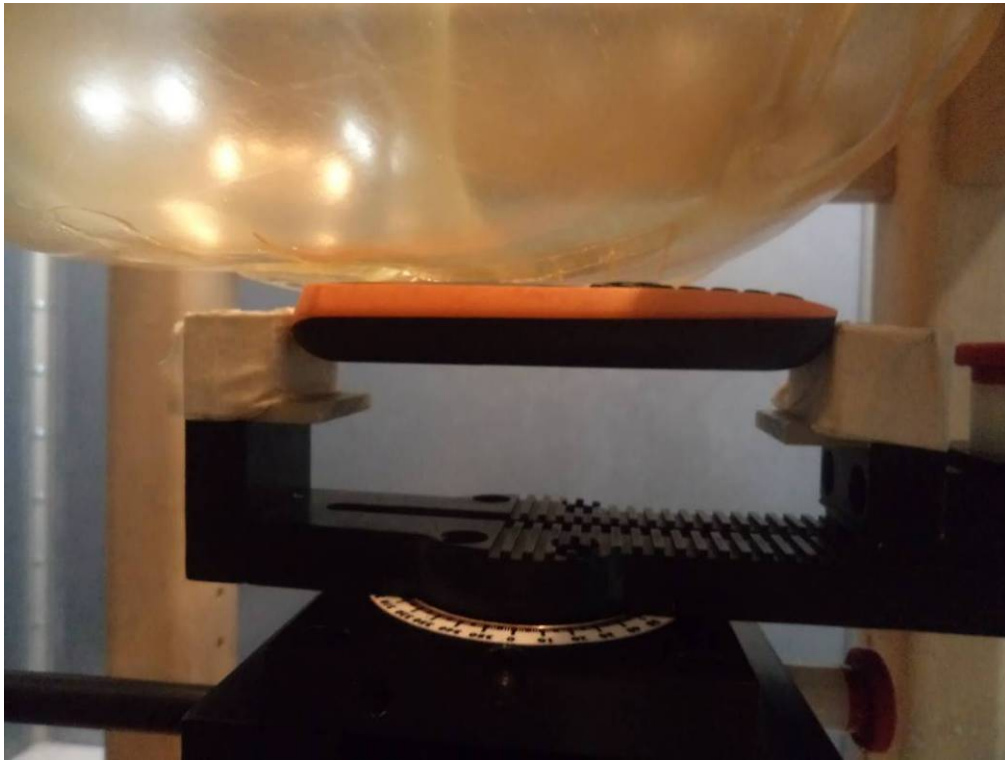

Right Head Tilt Setup Photo



APPENDIX E – EUT PHOTOS

EUT – Front Side View



EUT – Back Side View



EUT – Uncovered View

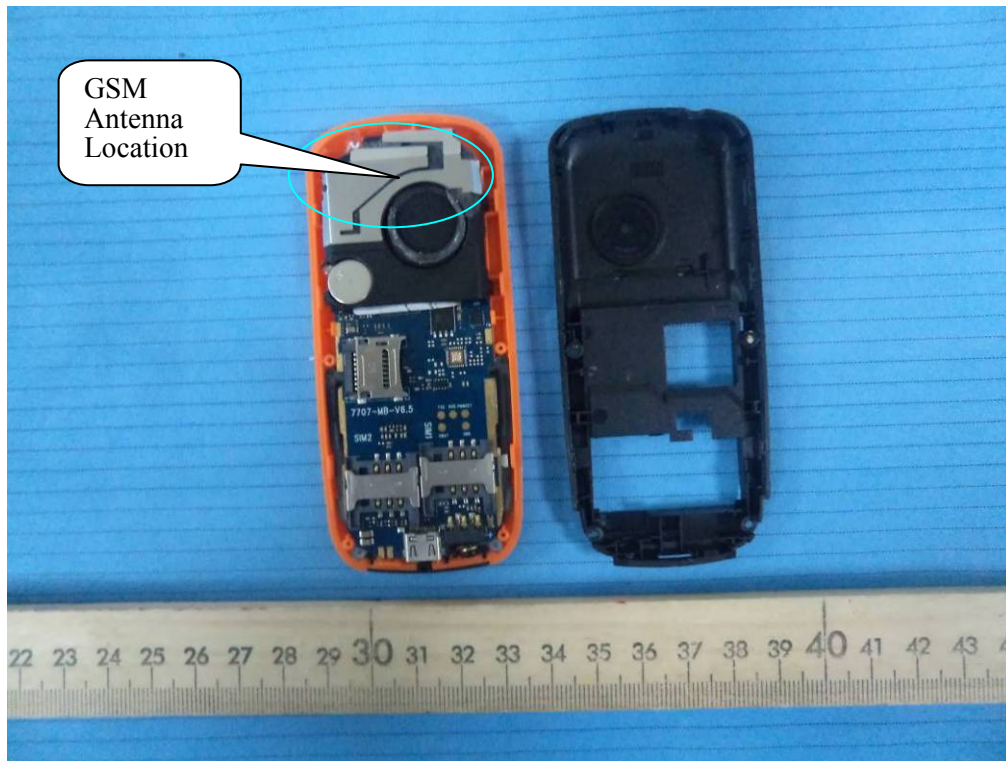

EUT-Headset view



APPENDIX G – INFORMATIVE REFERENCES

- [1] Federal Communications Commission, \Report and order: Guidelines for evaluating the environmental effects of radiofrequency radiation", Tech. Rep. FCC 96-326, FCC, Washington, D.C. 20554, 1996.
- [2] David L. Means Kwok Chan, Robert F. Cleveland, \Evaluating compliance with FCC guidelines for human exposure to radiofrequency electromagnetic fields", Tech. Rep., Federal Communication Commission, Office of Engineering & Technology, Washington, DC, 1997.
- [3] Thomas Schmid, Oliver Egger, and Niels Kuster, \Automated E-field scanning system for dosimetric assessments", IEEE Transactions on Microwave Theory and Techniques, vol. 44, pp. 105-113, Jan. 1996.
- [4] Niels Kuster, Ralph Kastle, and Thomas Schmid, \Dosimetric evaluation of mobile communications equipment with known precision", IEEE Transactions on Communications, vol. E80-B, no. 5, pp. 645-652, May 1997.
- [5] CENELEC, \Considerations for evaluating of human exposure to electromagnetic fields (EMFs) from mobile telecommunication equipment (MTE) in the frequency range 30MHz - 6GHz", Tech. Rep., CENELEC, European Committee for Electrotechnical Standardization, Brussels, 1997.
- [6] ANSI, ANSI/IEEE C95.1-1992: IEEE Standard for Safety Levels with Respect to Human Exposure to Radio Frequency Electromagnetic Fields, 3 kHz to 300 GHz, The Institute of Electrical and Electronics Engineers, Inc., New York, NY 10017, 1992.
- [7] Katja Pokovic, Thomas Schmid, and Niels Kuster, \Robust setup for precise calibration of E-field probes in tissue simulating liquids at mobile communications frequencies", in ICECOM '97, Dubrovnik, October 15-17, 1997, pp. 120-24.
- [8] Katja Pokovic, Thomas Schmid, and Niels Kuster, \E-field probe with improved isotropy in brain simulating liquids", in Proceedings of the ELMAR, Zadar, Croatia, 23-25 June, 1996, pp. 172-175.
- [9] Volker Hombach, Klaus Meier, Michael Burkhardt, Eberhard Kuhn, and Niels Kuster, \The dependence of EM energy absorption upon human head modeling at 900 MHz", IEEE Transactions on Microwave Theory and Techniques, vol. 44, no. 10, pp. 1865-1873, Oct. 1996.
- [10] Klaus Meier, Ralf Kastle, Volker Hombach, Roger Tay, and Niels Kuster, \The dependence of EM energy absorption upon human head modeling at 1800 MHz", IEEE Transactions on Microwave Theory and Techniques, Oct. 1997, in press.
- [11] W. Gander, Computermathematik, Birkhaeuser, Basel, 1992.
- [12] W. H. Press, S. A. Teukolsky, W. T. Vetterling, and B. P. Flannery, Numerical Recipes in C, The Art of Scientific Computing, Second Edition, Cambridge University Press, 1992. Dosimetric Evaluation of Sample device, month 1998 9
- [13] NIS81 NAMAS, \The treatment of uncertainty in EMC measurement", Tech. Rep., NAMAS Executive, National Physical Laboratory, Teddington, Middlesex, England, 1994.
- [14] Barry N. Taylor and Christ E. Kuyatt, \Guidelines for evaluating and expressing the uncertainty of NIST measurement results", Tech. Rep., National Institute of Standards and Technology, 1994. Dosimetric Evaluation of Sample device, month 1998 10.
- [15] FCC OET KDB648474 Do1 SAR Evaluation Considerations for Handsets with Multiple transmitters and Antennas.

***** END OF REPORT *****