



RADIO TEST REPORT

Report No: STS1606015F01

Issued for

ITALCOM GROUP

1728Coral Way,Coral Gables,Miami,Florida,United States
33145

Product Name:	GSM PHONE
Brand Name:	NYX
Model Name:	XYN307
Series Model:	N/A
FCC ID:	YPVITALCOMXYN307
Test Standard:	FCC Part 22H and 24E

Any reproduction of this document must be done in full. No single part of this document may be reproduced without permission from STS, All Test Data Presented in this report is only applicable to presented Test sample.





TEST RESULT CERTIFICATION

Applicant's name: ITALCOM GROUP

Address: 1728Coral Way,Coral Gables,Miami,Florida,United States 33145

Manufacture's Name: SCOPE Scientific Development co.LTD

Address: room 303,Ling Nan building,NO.3081,Qiaoxiang Road,Futian District,Shenzhen city,Guangdong Province,China

Product name: GSM PHONE

Brand name: NYX

Model and/or type reference ..: XYN307

Standards: FCC Part 22H and 24E

Test procedure ANSI/TIA 603-D (2010)

This device described above has been tested by STS and the test results show that the equipment under test (EUT) is in compliance with the FCC requirements. And it is applicable only to the tested sample identified in the report.

This report shall not be reproduced except in full, without the written approval of STS, this document may be altered or revised by STS, personal only, and shall be noted in the revision of the document.

Date of Test

Date of performance of tests 02 June. 2016 ~13 June. 2016

Date of Issue 14 June. 2016

Test Result..... **Pass**

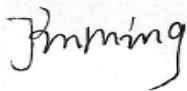
Testing Engineer : 

(Jin Ming)

Technical Manager : 

(Vita Li)

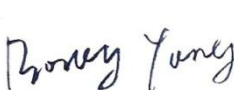
Authorized Signatory : 

(Bovey Yang)





TABLE OF CONTENTS	Page
SUMMARY OF TEST RESULTS	5
1 INTRODUCTION	6
1.1 TEST FACTORY	6
1.2 MEASUREMENT UNCERTAINTY	6
2 PRODUCT INFORMATION	7
3 TEST CONFIGURATION OF EQUIPMENT UNDER TEST	8
4 MEASUREMENT INSTRUMENTS	9
5 TEST ITEMS	10
5.1 CONDUCTED OUTPUT POWER	10
5.2 PEAK TO AVERAGE RATIO	11
5.3 TRANSMITTER RADIATED POWER (EIRP/ERP)	12
5.4 OCCUPIED BANDWIDTH	13
5.5 FREQUENCY STABILITY	14
5.6 SPURIOUS EMISSIONS AT ANTENNA TERMINALS	15
5.7 BAND EDGE	16
5.8 FIELD STRENGTH OF SPURIOUS RADIATION MEASUREMENT	17
APPENDIX A TEST RESULT	19
A1 CONDUCTED OUTPUT POWER	19
A2 PEAK-TO-AVERAGE RADIO	19
A3 TRANSMITTER RADIATED POWER (EIRP/ERP)	20
A4 OCCUPIED BANDWIDTH(99% OCCUPIED BANDWIDTH/26DB BANDWIDTH)	22
A5 FREQUENCY STABILITY	27
A6 SPURIOUS EMISSIONS AT ANTENNA TERMINALS	29
A7 BAND EDGE	35
A8 FIELD STRENGTH OF SPURIOUS RADIATION MEASUREMENT	39
APPENDIX B PHOTOS OF TEST SETUP	43

**Revision History**

Rev.	Issue Date	Report NO.	Effect Page	Contents
00	14 June. 2016	STS1606015F01	ALL	Initial Issue





SUMMARY OF TEST RESULTS

Test procedures according to the technical standards:

The radiated emission testing was performed according to the procedures of ANSI/TIA-603-D: 2010, KDB 971168 D01 v02r02 and KDB 648474 D03 v01r04

FCC Rules	Test Description	Test Limit	Test Result	Reference
2.1049	Conducted Output Power	Reporting Only	PASS	
2.0146 24.232	Peak-to-Average Ratio	< 13 dB	PASS	
2.1046 22.913 24.232	Effective Radiated Power/Equivalent Isotropic Radiated Power	< 7 Watts max. ERP (Part 22) < 2 Watts max. EIRP (Part 24)	PASS	
2.1049 22.917 24.238	Occupied Bandwidth	Reporting Only	PASS	
2.1055 22.355 24.235	Frequency Stability	< 2.5 ppm (Part 22) Emission must remain in band (Part 24)	PASS	
2.1051 22.917 24.238	Spurious Emission at Antenna Terminals	< $43 + 10 \log_{10}(P[\text{Watts}])$	PASS	
2.1053 22.917 24.238	Field Strength of Spurious Radiation	< $43 + 10 \log_{10}(P[\text{Watts}])$	PASS	
2.1051 22.917 24.238	Band Edge	< $43 + 10 \log_{10}(P[\text{Watts}])$	PASS	



1 INTRODUCTION

1.1 TEST FACTORY

Shenzhen STS Test Services Co., Ltd.

Add. : 1/F., Building B, Zhuoke Science Park, No.190,Chongqing Road,
Fuyong Street, Bao'an District, Shenzhen, Guangdong,China

CNAS Registration No.: L7649;

FCC Registration No.: 842334; IC Registration No.: 12108A-1

1.2 MEASUREMENT UNCERTAINTY

The measurement uncertainties shown below were calculated in accordance with the requirements of ANSI C63.4-2014. All measurement uncertainty values are shown with a coverage factor of $k = 2$ to indicate a 95% level of confidence. The measurement data shown herein meets or exceeds the CISPR measurement uncertainty values specified in CISPR 16-4-2 and, thus, can be compared directly to specified limits to determine compliance.

No.	Item	Uncertainty
1	RF power,conducted	$\pm 0.70\text{dB}$
2	Spurious emissions,conducted	$\pm 1.19\text{dB}$
5	All emissions,radiated(<1G) 30MHz-200MHz	$\pm 2.83\text{dB}$
6	All emissions,radiated(<1G) 200MHz-1000MHz	$\pm 2.94\text{dB}$
7	All emissions,radiated(>1G)	$\pm 3.03\text{dB}$
8	Temperature	$\pm 0.5^{\circ}\text{C}$
9	Humidity	$\pm 2\%$



2 PRODUCT INFORMATION

Product Designation:	GSM PHONE
Hardware version number:	xyn307_v1.1
Software version number:	XYN307_AMXCLR_V001R
FCC ID:	YPVITALCOMXYN307
Tx Frequency:	GSM: 850: 824.2 MHz ~ 848.8 MHz 1900: 1850.2 MHz ~ 1909.8MHz
Rx Frequency:	GSM/GPRS: 850: 869.2 MHz ~ 893.8 MHz 1900: 1930.2 MHz ~ 1989.8 MHz
Max RF Output Power:	GSM850:29.74dBm,PCS1900:28.98dBm GPRS50:29.62dBm,GPRS1900:28.89dBm
Type of Emission:	GSM(850):318KGXW: GSM(1900):319XW GPRS(850):322XW: GPRS(1900):321XW
SIM Card:	Support single card
Antenna:	GSM:PIFA Antenna BT:Dipole Antenna
Antenna gain:	GSM 850:1.6dBi ,PCS 1900:1.3dBi
Power Supply:	DC 3.7V by battery
Battery parameter:	Capacitance: 600mAh, Rated Voltage: 3.7V
GPRS Class:	Multi-Class12
Extreme Vol. Limits:	DC3.5 V to 4.2 V (Nominal DC3.7V)
Extreme Temp. Tolerance:	-20°C to +45°C
** Note: The High Voltage 4.2 V and Low Voltage 3.5V was declared by manufacturer, The EUT couldn't be operate normally with higher or lower voltage.	



3 TEST CONFIGURATION OF EQUIPMENT UNDER TEST

Antenna port conducted and radiated test items were performed according to KDB 971168 D01 Power Meas. License Digital Systems v02r02 with maximum output power.

Radiated measurements were performed with rotating EUT in different three orthogonal test planes to find the maximum emission.

Radiated emissions were investigated as following frequency range:

1. 30 MHz to 10th harmonic for GSM850
2. 30 MHz to 10th harmonic for GSM1900 All modes and data rates and positions were investigated.

Test modes are chosen to be reported as the worst case configuration below:

BAND	TEST MODES	
	RADIATED TCS	CONDUCTED TCS
GSM 850	GSM LINK GPRS CLASS 12 LINK	GSM LINK GPRS CLASS 12 LINK
GSM 1900	GSM LINK GPRS CLASS 12 LINK	GSM LINK GPRS CLASS 12 LINK



4 MEASUREMENT INSTRUMENTS

Kind of Equipment	Manufacturer	Type No.	Serial No.	Last Calibration	Calibrated Until
Spectrum Analyzer	Agilent	E4407B	MY50140340	2015.10.25	2016.10.24
Signal Analyzer	Agilent	N9020A	MY49100060	2015.11.18	2016.11.17
Test Receiver	R&S	ESCI	101427	2015.10.25	2016.10.24
Communication Tester	Agilent	8960	MY48360751	2015.11.20	2016.11.19
Communication Tester	R&S	CMU200	112012	2015.10.25	2016.10.24
Test Receiver	R&S	ESCI	102086	2015.10.25	2016.10.24
Bilog Antenna	TESEQ	CBL6111D	34678	2015.11.25	2016.11.24
Horn Antenna	Schwarzbeck	BBHA 9120D	9120D-1343	2016.03.06	2017.03.05
Horn Antenna	Schwarzbeck	BBHA 9170	9170-0741	2016.03.06	2017.03.05
MXA SIGNAL Analyzer	Agilent	N9020A	MY49100060	2015.10.25	2016.10.24
Bilog Antenna	Sunol Sciences	JB3	A110714	2015.09.03	2016.09.02
Horn-Antenna	Schwarzbeck	BBHA9120D	9120D-1266	2016.03.06	2017.03.05
Horn Antenna	Schwarzbeck	BBHA 9170	9170-0741	2016.03.06	2017.03.05
Double Ridge Horn Antenna	COM-POWER CORPORATION	AH-840	AHA-840	2016.03.06	2017.03.05
Low frequency cable	N/A	R01	N/A	N/A	N/A
High frequency cable	SCHWARZBECK	AK9515H	SN-96286/96287	N/A	N/A
Vector signal generator	Agilent	E8257D-521	MY45141029	2015.10.16	2016.10.14
Power amplifier	DESAY	ZHL-42W	9638	2015.10.24	2016.10.23

Equipment with a calibration date of "N/A" shown in this list was not used to make direct calibrated measurements.

5 TEST ITEMS

5.1 CONDUCTED OUTPUT POWER

Test overview

A system simulator was used to establish communication with the EUT. Its parameters were set to enforce EUT transmitting at the maximum power. The measured power in the radio frequency on the transmitter output terminals shall be reported.

Test procedures

1. The transmitter output port was connected to the system simulator.
2. Set eut at maximum power through the system simulator.
3. Select lowest, middle, and highest channels for each band and different modulation.
4. Measure and record the power level from the system simulator.

Test setup

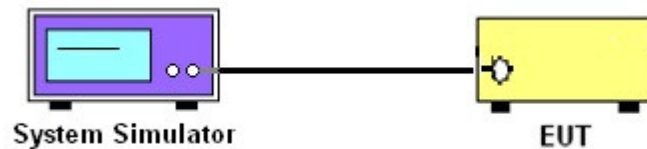

5.2 PEAK TO AVERAGE RATIO

TEST OVERVIEW

According to §24.232(d), power measurements for transmissions by stations authorized under this section may be made either in accordance with a commission-approved average power technique or in compliance with paragraph (e) of this section. In both instances, equipment employed must be authorized in accordance with the provisions of §24.51. In measuring transmissions in this band using an average power technique, the peak-to-average ratio (PAR) of the transmission may not exceed 13 db.

TEST PROCEDURES

1. The testing follows fcckdb 971168 v02r02 section
2. The eut was connected to the and peak and av system simulator& spectrum analysis reads
3. Select lowest, middle, and highest channels for each band and different modulation.
4. Set the test probe and measure average power of the spectrum analysis

TEST SETUP

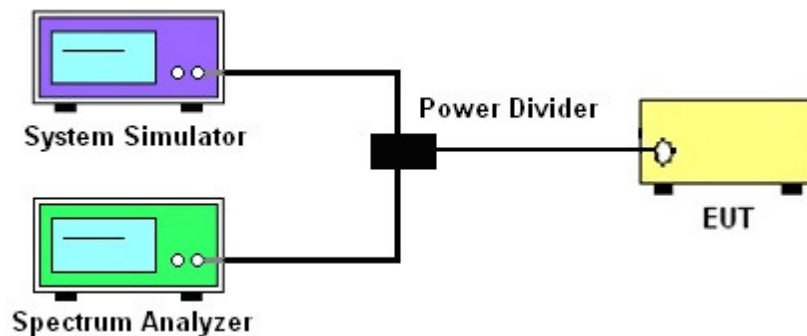



5.3 TRANSMITTER RADIATED POWER (EIRP/ERP)

TEST OVERVIEW

Effective Radiated Power (ERP) and Equivalent Isotropic Radiated Power (EIRP) measurements are performed using the substitution method described in ANSI/TIA-603-D-2010 with the EUT transmitting into an integral antenna. Measurements on signals operating below 1GHz are performed using vertically polarized tuned dipole antennas. Measurements on signals operating above 1GHz are performed using vertically polarized broadband horn antennas. All measurements are performed as RMS average measurements while the EUT is operating at maximum power, and at the appropriate frequencies.

TEST PROCEDURE

1. The testing follows FCC KDB 971168 D01, Section 5.2.2 (for GSM/GPRS) and ANSI / TIA-603-D-2010 Section 2.2.17.
2. The transmitter was placed on a wooden turntable, and it was transmitting into a non-radiating load which was also placed on the turntable.
3. The measurement antenna was placed at a distance of 3 meters from the EUT. During the tests, the antenna height and polarization as well as EUT azimuth were varied in order to identify the maximum level of emissions from the EUT. The test was performed by placing the EUT on 3-orthogonal axis.
4. The frequency range up to tenth harmonic of the fundamental frequency was investigated.
5. Remove the EUT and replace it with substitution antenna. A signal generator was connected to the substitution antenna by a nonradiating cable. The absolute levels of the spurious emissions were measured by the substitution.
6. Effective Isotropic Radiated Power (EIRP) was measured by substitution method according to TIA/EIA-603-D. The EUT was replaced by the substitution antenna at same location, and then a known power from S.G. was applied into the dipole antenna through a Tx cable, and then recorded the maximum Analyzer reading through raised and lowered the test antenna. The correction factor (in dB) = S.G. - Tx Cable loss + Substitution antenna gain - Analyzer reading. Then the EUT's EIRP/ERP was calculated with the correction factor,
$$\text{ERP/EIRP} = \text{P.SG} + \text{GT} - \text{LC}$$

ERP/EIRP = effective or equivalent radiated power, respectively (expressed in the same units as P_{Me} as, typically dBW or dBm);
P.SG = measured transmitter output power or PSD, in dBm or dBW;
GT = gain of the transmitting antenna, in dBd (ERP) or dBi (EIRP);
LC = signal attenuation in the connecting cable between the transmitter and antenna, in dB.

5.4 OCCUPIED BANDWIDTH

TEST OVERVIEW

The occupied bandwidth, that is the frequency bandwidth such that, below its lower and above its upper frequency limits, the mean powers radiated are each equal to 0.5 percent of the total mean power radiated by a given emission shall be measured.

The 26 dB emission bandwidth is defined as the frequency range between two points, one above and one below the carrier frequency, at which the spectral density of the emission is attenuated 26 dB below the maximum in-band spectral density of the modulated signal. Spectral density (power per unit bandwidth) is to be measured with a detector of resolution bandwidth equal to approximately 1.0% of the emission bandwidth.

All modes of operation were investigated and the worst case configuration results are reported in this section.

TEST PROCEDURE

1. The signal analyzer's automatic bandwidth measurement capability was used to perform the 99% occupied bandwidth and the 26dB bandwidth. The bandwidth measurement was not influenced by any intermediate power nulls in the fundamental emission.
2. $RBW = 1 - 5\%$ of the expected OBW
3. $VBW \geq 3 \times RBW$
4. Detector = Peak
5. Trace mode = max hold
6. Sweep = auto couple
7. The trace was allowed to stabilize
8. If necessary, steps 2 – 7 were repeated after changing the RBW such that it would be within 1 – 5% of the 99% occupied bandwidth observed in Step 7

TEST SETUP

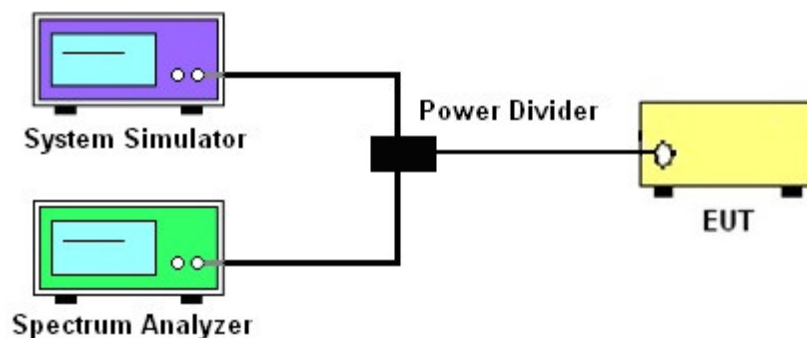

5.5 FREQUENCY STABILITY

Test Overview

Frequency stability testing is performed in accordance with the guidelines of ANSI/TIA-603-D-2010. The frequency stability of the transmitter is measured by:

- a.) Temperature: The temperature is varied from -30°C to +50°C in 10°C increments using an environmental chamber.
- b.) Primary Supply Voltage: The primary supply voltage is varied from 85% to 115% of the nominal value for non hand-carried battery and AC powered equipment. For hand-carried, battery-powered equipment, primary supply voltage is reduced to the battery operating end point which shall be specified by the manufacturer.

For Part 22, the frequency stability of the transmitter shall be maintained within $\pm 0.00025\%$ (± 2.5 ppm) of the center frequency. For Part 24 the frequency stability shall be sufficient to ensure that the fundamental emission stays within the authorized frequency block.

Test Procedure

Temperature Variation

1. The testing follows fcckdb 971168 D01 section 9.0
2. The EUT was set up in the thermal chamber and connected with the system simulator.
3. With power OFF, the temperature was decreased to -30°C and the EUT was stabilized before testing. Power was applied and the maximum change in frequency was recorded within one minute.
4. With power OFF, the temperature was raised in 10°C steps up to 50°C. The EUT was stabilized at each step for at least half an hour. Power was applied and the maximum frequency change was recorded within one minute.

Voltage Variation

1. The testing follows FCC KDB 971168 D01 Section 9.0.
2. The EUT was placed in a temperature chamber at $25\pm 5^\circ\text{C}$ and connected with the system simulator.
3. The power supply voltage to the EUT was varied from 85% to 115% of the nominal value measured at the input to the EUT.
4. The variation in frequency was measured for the worst case.

TEST SETUP

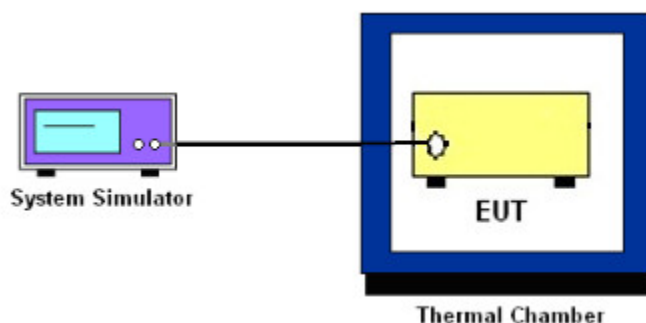

5.6 SPURIOUS EMISSIONS AT ANTENNA TERMINALS

Test Overview

The power of any emission outside of the authorized operating frequency ranges must be lower than the transmitter power (P) by a factor of at least $43 + 10 \log (P)$ dB.

It is measured by means of a calibrated spectrum analyzer and scanned from 30 MHz up to a frequency including its 10th harmonic.

Test procedure

1. The testing follows FCC KDB 971168 D01 v02r02 Section 6.0.
2. The EUT was connected to the spectrum analyzer and system simulator via a power divider.
3. The RF output of EUT was connected to the spectrum analyzer by an RF cable and attenuator. The path loss was compensated to the results for each measurement.
4. The middle channel for the highest RF power within the transmitting frequency was measured.
5. The conducted spurious emission for the whole frequency range was taken.
6. The RF fundamental frequency should be excluded against the limit line in the operating frequency band.
7. The limit line is derived from $43 + 10\log(P)$ dB below the transmitter power P(Watts)
 $= P(W) - [43 + 10\log(P)]$ (dB)
 $= [30 + 10\log(P)]$ (dBm) - $[43 + 10\log(P)]$ (dB)
 $= -13\text{dBm}$.

Test Setup

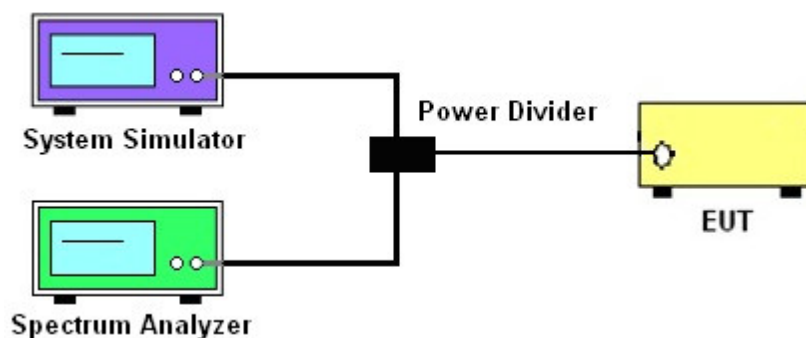

5.7 BAND EDGE

OVERVIEW

All out of band emissions are measured with a spectrum analyzer connected to the antenna terminal of the EUT while the EUT is operating at maximum power, and at the appropriate frequencies. All data rates were investigated to determine the worst case configuration. All modes of operation were investigated and the worst case configuration results are reported in this section.

The minimum permissible attenuation level of any spurious emission is $43 + \log_{10}(P[\text{Watts}])$, where P is the transmitter power in Watts.

TEST PROCEDURE

1. Start and stop frequency were set such that the band edge would be placed in the center of the Plot.
2. The EUT was connected to the spectrum analyzer and system simulator via a power divider.
3. The RF output of EUT was connected to the spectrum analyzer by an RF cable and attenuator. The path loss was compensated to the results for each measurement.
4. The band edges of low and high channels for the highest RF powers were measured.
5. The RF fundamental frequency should be excluded against the limit line in the operating frequency band.
6. The limit line is derived from $43 + 10\log(P)$ dB below the transmitter power P(Watts)
 $= P(\text{W}) - [43 + 10\log(P)] (\text{dB})$
 $= [30 + 10\log(P)] (\text{dBm}) - [43 + 10\log(P)] (\text{dB})$
 $= -13\text{dBm}.$

TEST SETUP

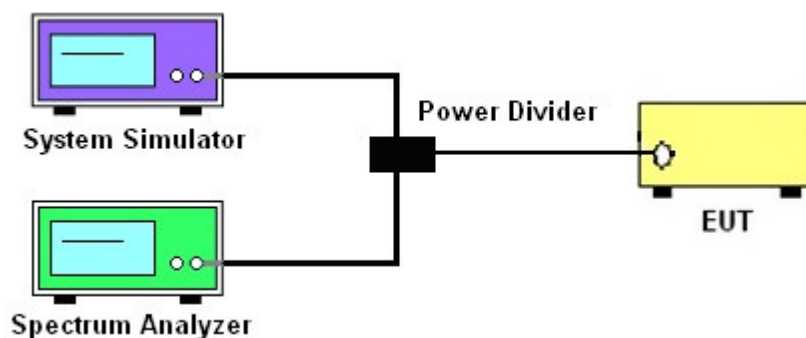



5.8 FIELD STRENGTH OF SPURIOUS RADIATION MEASUREMENT

Test overview

Radiated spurious emissions measurements are performed using the substitution method described in ANSI/TIA-603-D-2010 with the EUT transmitting into an integral antenna. Measurements on signals operating below 1GHz are performed using horizontally and vertically polarized tuned dipole antennas. Measurements on signals operating above 1GHz are performed using vertically and horizontally polarized horn antennas. All measurements are performed as peak measurements while the EUT is operating at maximum power and at the appropriate frequencies.

It is measured by means of a calibrated spectrum analyzer and scanned from 30 MHz up to a frequency including its 10th harmonic.

Test procedure

1. The testing follows FCC KDB 971168 D01 Section 5.8 and ANSI/TIA-603-D-2010 – Section 2.2.12
2. RBW = 100kHz for emissions below 1GHz and 1MHz for emissions above 1GHz
3. VBW \geq 3 x RBW
4. Span = 1.5 times the OBW
5. No. of sweep points > 2 x span/RBW
6. Detector = Peak
7. Trace mode = max hold
8. The trace was allowed to stabilize

TEST SETUP

For radiated test from 30MHz to 1GHz

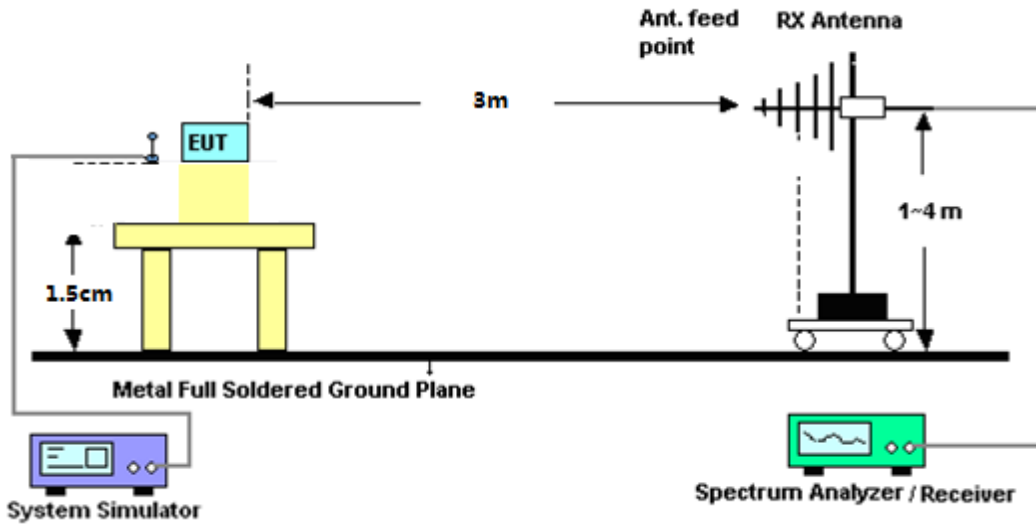

For radiated test from above 1GHz

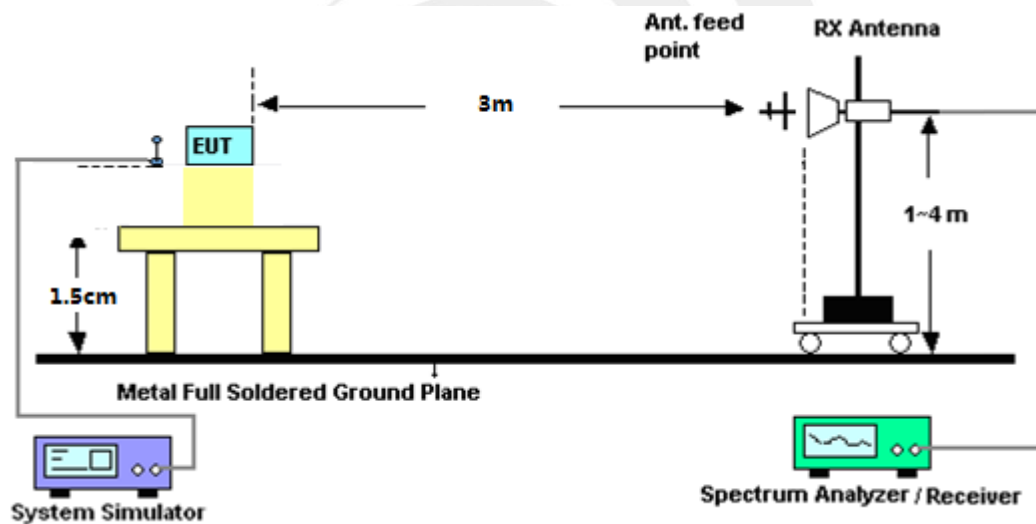



APPENDIX A TestResult
A1 CONDUCTED OUTPUT POWER

GSM 850:

Mode	Frequency (MHz)	AVG Power
GSM850	824.2	29.52
	836.6	29.36
	848.8	29.74
GPRS850 (1-Slot)	824.2	29.48
	836.6	29.21
	848.8	29.62

PCS 1900:

Mode	Frequency (MHz)	AVG Power
GSM1900	1850.2	28.97
	1880.0	28.96
	1909.8	28.98
GPRS1900 (1-Slot)	1850.2	28.88
	1880	28.89
	1909.8	28.86

A2 PEAK-TO-AVERAGE RADIO

PCS 1900:

Mode	Frequency (MHz)	PEAK Power	AVG Power	PAR
PCS1900	1850.2	29.65	28.97	0.68
	1880.0	29.87	28.96	0.91
	1909.8	29.47	28.98	0.49
GPRS1900	1850.2	29.41	28.88	0.53
	1880	29.45	28.89	0.56
	1909.8	29.32	28.86	0.46



A3 TRANSMITTER RADIATED POWER (EIRP/ERP)

Radiated Power (ERP) for GSM 850 MHZ							
Mode	Frequency	Result					Conclusion
		Substituted level (dBm)	Cable loss	Gain (dBd)	Max.Pk E.R.P(dBm)	Polarization Of Max. ERP	
GSM850	824.2	25.52	0.44	0	27.23	Horizontal	Pass
	824.2	27.81	0.44	0	29.52	Vertical	Pass
	836.6	25.71	0.45	0	27.41	Horizontal	Pass
	836.6	27.66	0.45	0	29.36	Vertical	Pass
	848.8	25.63	0.46	0	27.32	Horizontal	Pass
	848.8	28.05	0.46	0	29.74	Vertical	Pass
GPRS850	824.2	25.54	0.44	0	27.25	Horizontal	Pass
	824.2	27.77	0.44	0	29.48	Vertical	Pass
	836.6	25.72	0.45	0	27.42	Horizontal	Pass
	836.6	27.51	0.45	0	29.21	Vertical	Pass
	848.8	25.54	0.46	0	27.23	Horizontal	Pass
	848.8	27.93	0.46	0	29.62	Vertical	Pass

(1) Dipole Antenna Gain:0dBd=2.15dBi
 (2) Substituted level =S G.Level+ Amplifier gain



Radiated Power (EIRP) for PCS 1900 MHZ							
Mode	Frequency	Result					Conclusion
		Substituted level (dBm)	Cable loss	Gain (dBi)	Max. Pk E.I.R.P.(dBm)	Polarization Of Max.EIRP.	
PCS1900	1850.2	18.88	2.41	10.06	26.53	Horizontal	Pass
	1850.2	21.32	2.41	10.06	28.97	Vertical	Pass
	1880.0	18.86	2.42	10.06	26.50	Horizontal	Pass
	1880.0	21.32	2.42	10.06	28.96	Vertical	Pass
	1909.8	18.57	2.43	10.06	26.20	Horizontal	Pass
	1909.8	21.35	2.43	10.06	28.98	Vertical	Pass
GPRS1900	1850.2	18.50	2.41	10.06	26.15	Horizontal	Pass
	1850.2	21.23	2.41	10.06	28.88	Vertical	Pass
	1880.0	18.53	2.42	10.06	26.17	Horizontal	Pass
	1880.0	21.25	2.42	10.06	28.89	Vertical	Pass
	1909.8	18.79	2.43	10.06	26.42	Horizontal	Pass
	1909.8	21.23	2.43	10.06	28.86	Vertical	Pass



A4 OCCUPIED BANDWIDTH(99% OCCUPIED BANDWIDTH/26DB BANDWIDTH)

Bandwidth for GSM 850 band			
Mode	Frequency(MHz)	Occupied Bandwidth (99%)(kHz)	Emission Bandwidth (-26dBc)(kHz)
Low Channel	824.2	244.95	318.4
Middle Channel	836.6	244.12	314.4
High Channel	848.8	242.86	318.4

Bandwidth for GPRS 850 band			
Mode	Frequency(MHz)	Occupied Bandwidth (99%)(kHz)	Emission Bandwidth (-26dBc)(kHz)
Low Channel	824.2	243.99	318.1
Middle Channel	836.6	245.39	321.5
High Channel	848.8	242.34	313.0

Occupied Bandwidth for GSM1900 band			
Mode	Frequency(MHz)	Occupied Bandwidth (99%)(kHz)	Emission Bandwidth (-26dBc)(kHz)
Low Channel	1850.2	245.49	314.4
Middle Channel	1880.0	247.71	314.8
High Channel	1909.8	246.62	318.6

Occupied Bandwidth for GPRS1900 band			
Mode	Frequency(MHz)	Occupied Bandwidth (99%)(kHz)	Emission Bandwidth (-26dBc)(kHz)
Low Channel	1850.2	240.16	309.4
Middle Channel	1880.0	246.67	320.7
High Channel	1909.8	243.39	320.0



GSM 850 CH 128

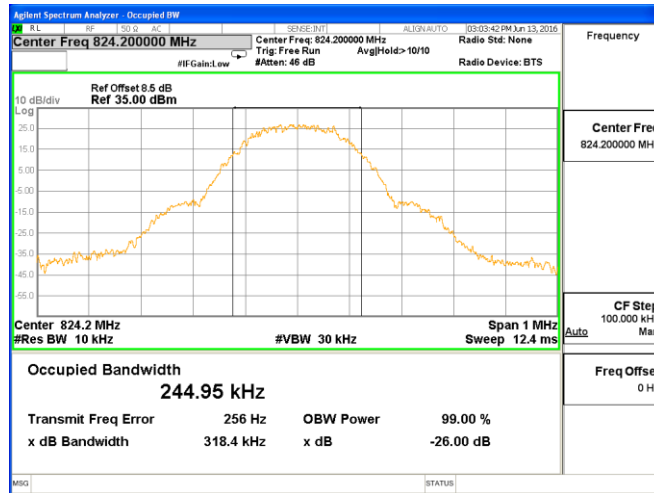

GSM 850 CH 190

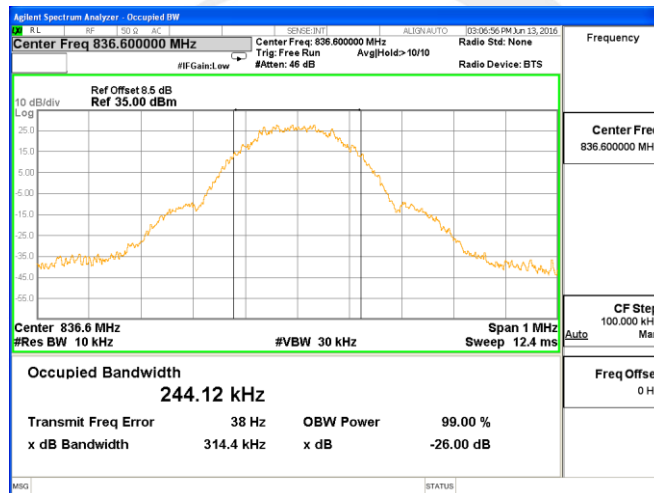

GSM 850 CH 251

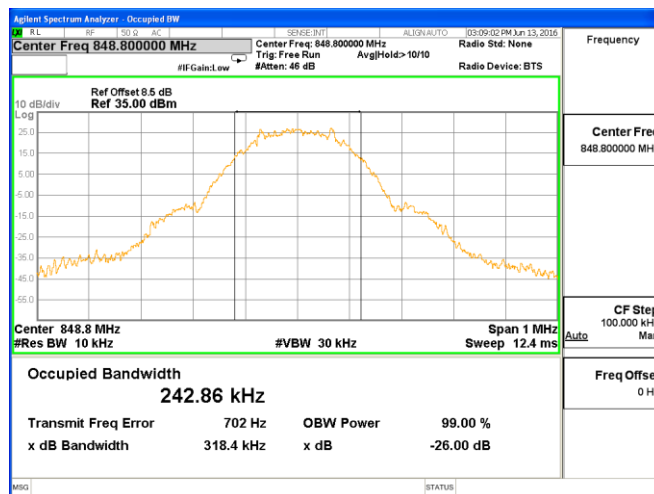



GPRS 850 CH 128

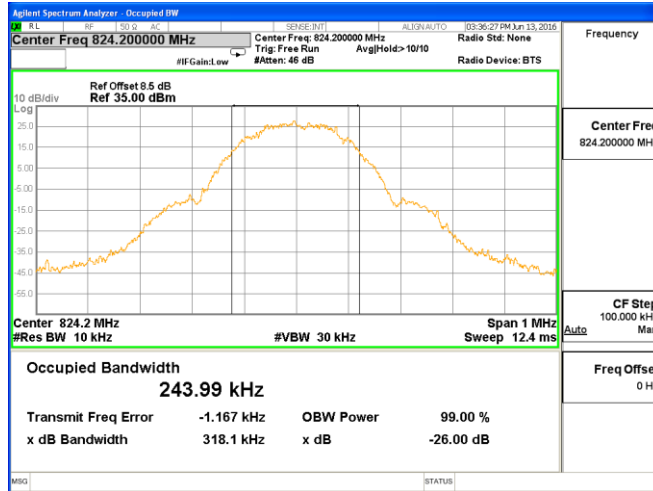

GPRS 850 CH 190

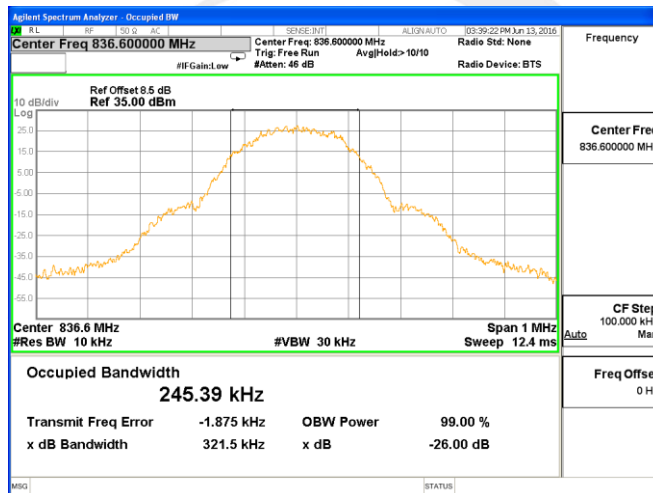

GPRS 850 CH 251

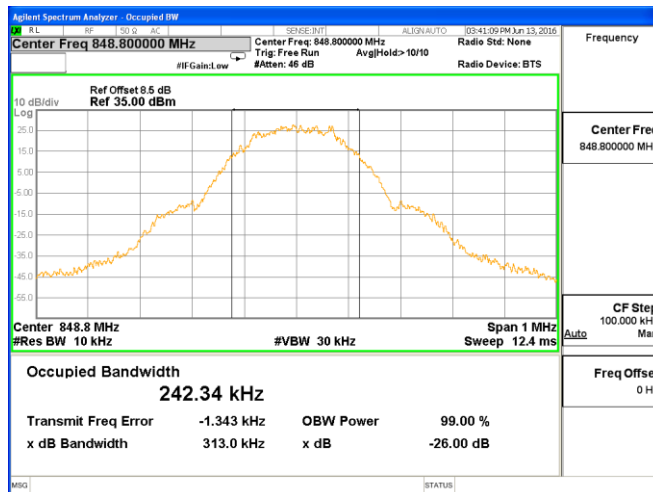



PCS 1900 CH 512

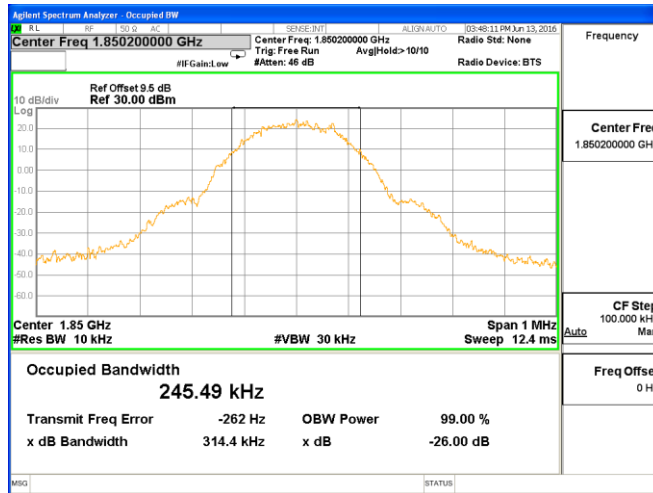

PCS 1900 CH 661

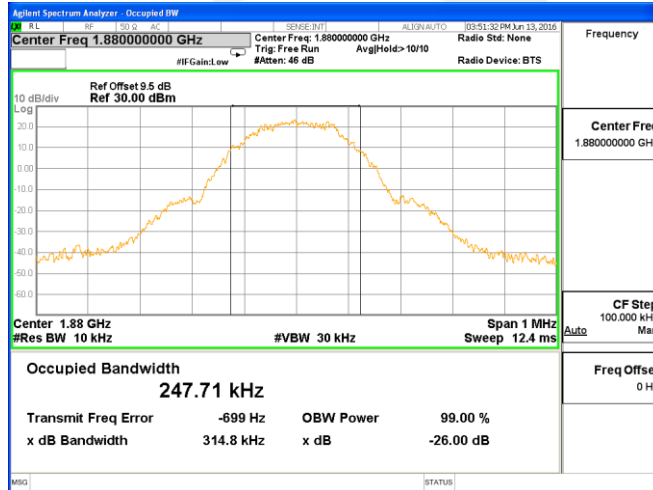

PCS 1900 CH 810

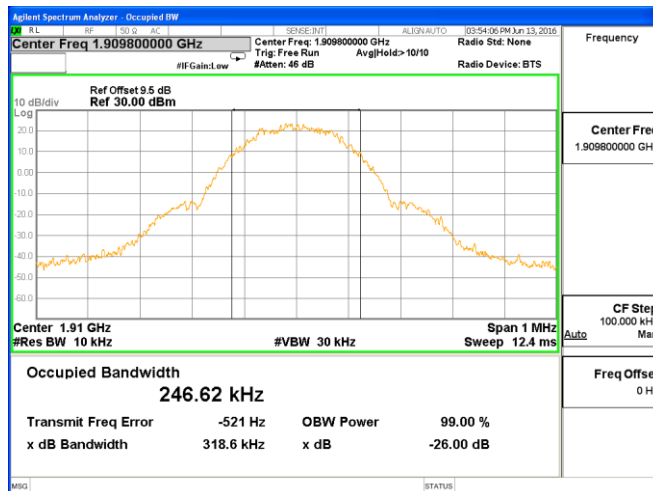



GPRS 1900 CH 512

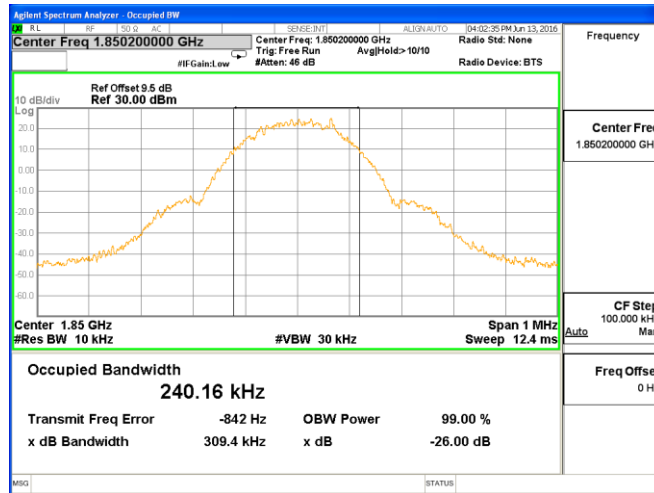

GPRS 1900 CH 661

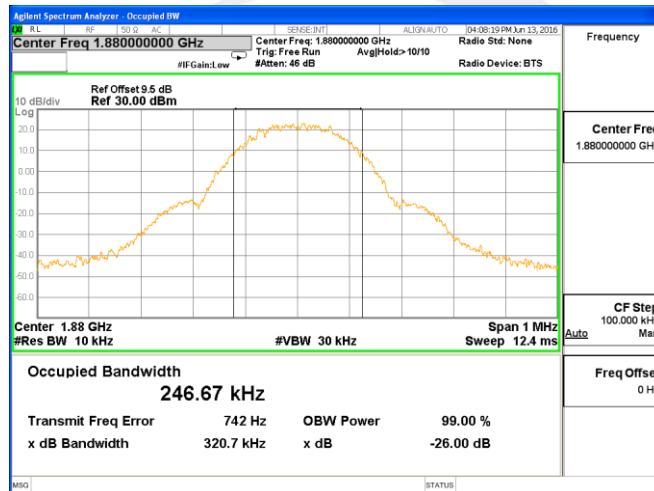

GPRS 1900 CH 810

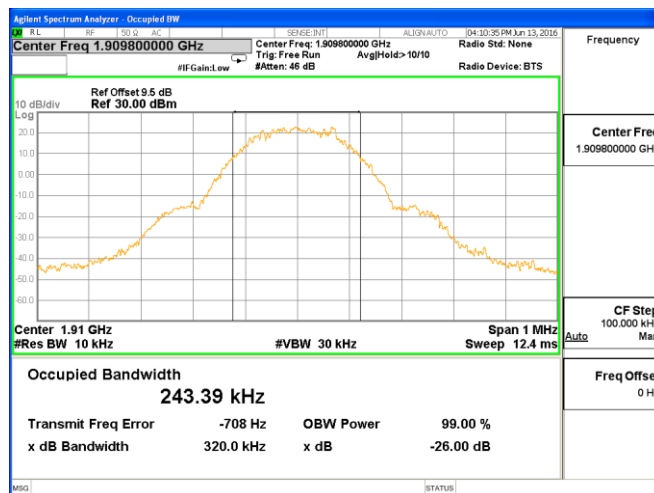



A5 FREQUENCY STABILITY

Normal Voltage = 3.7V. ;Battery End Point (BEP) = 3.5 V.;Maximum Voltage =4.2 V

GSM 850 Middle Channel					
Temperature (°C)	Voltage (Volt)	Freq. Dev. (Hz)	Freq. Dev. (ppm)	Limit	Result
50	Normal Voltage	13.515	0.016	2.5ppm	PASS
40		26.540	0.032		
30		23.622	0.028		
20		27.941	0.033		
10		18.270	0.022		
0		13.485	0.016		
-10		17.421	0.021		
-20		15.934	0.019		
-30		16.252	0.019		
25		Maximum Voltage	19.904		
25	BEP	11.595	0.014		

GPRS 850 Middle Channel					
Temperature (°C)	Voltage (Volt)	Freq. Dev. (Hz)	Freq. Dev. (ppm)	Limit	Result
50	Normal Voltage	13.583	0.016	2.5ppm	PASS
40		26.465	0.032		
30		23.694	0.028		
20		27.877	0.033		
10		18.182	0.022		
0		13.537	0.016		
-10		17.379	0.021		
-20		15.901	0.019		
-30		16.259	0.019		
25		Maximum Voltage	19.901		
25	BEP	11.649	0.014		



GSM 1900 Middle Channel					
Temperature (°C)	Voltage (Volt)	Freq. Dev. (Hz)	Freq. Dev. (ppm)	Limit	Result
50	Normal Voltage	19.081	0.010	Within Authorized Band	PASS
40		11.148	0.006		
30		10.231	0.005		
20		22.234	0.012		
10		14.057	0.007		
0		10.079	0.005		
-10		15.486	0.008		
-20		20.644	0.011		
-30		24.167	0.013		
25		Maximum Voltage	12.450		
25	BEP	12.480	0.007		

GPRS1900 Middle Channel					
Temperature (°C)	Voltage (Volt)	Freq. Dev. (Hz)	Freq. Dev. (ppm)	Limit	Result
50	Normal Voltage	19.105	0.010	Within Authorized Band	PASS
40		11.203	0.006		
30		10.309	0.005		
20		22.256	0.012		
10		14.060	0.007		
0		10.036	0.005		
-10		15.471	0.008		
-20		20.645	0.011		
-30		24.163	0.013		
25		Maximum Voltage	12.451		
25	BEP	12.519	0.007		



A6 SPURIOUS EMISSIONS AT ANTENNA TERMINALS
 GSM 850 BAND
 Lowest Channel

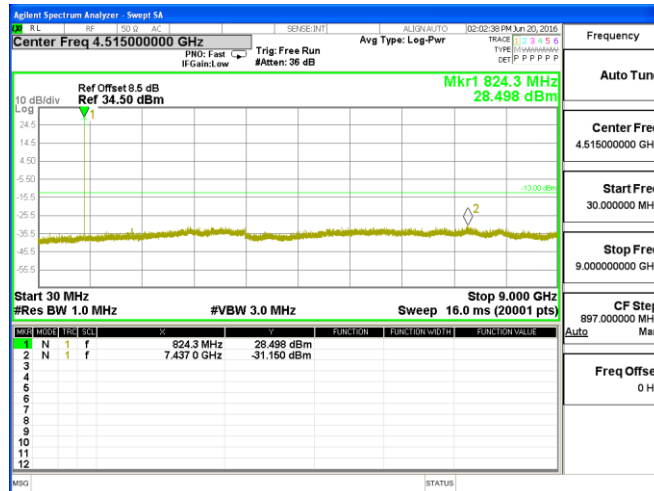

Middle Channel

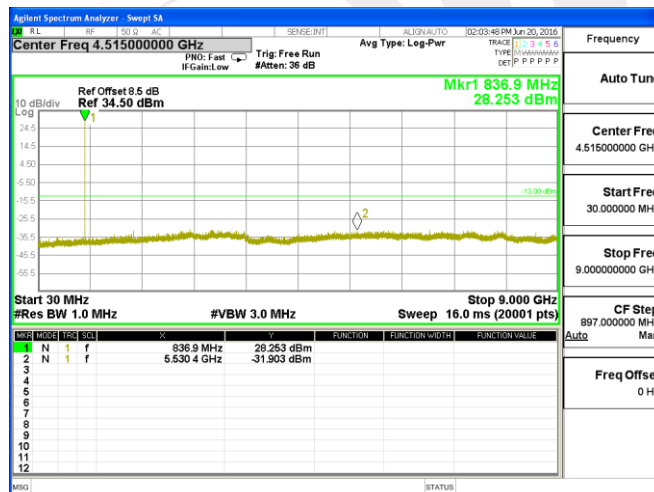

Highest Channel

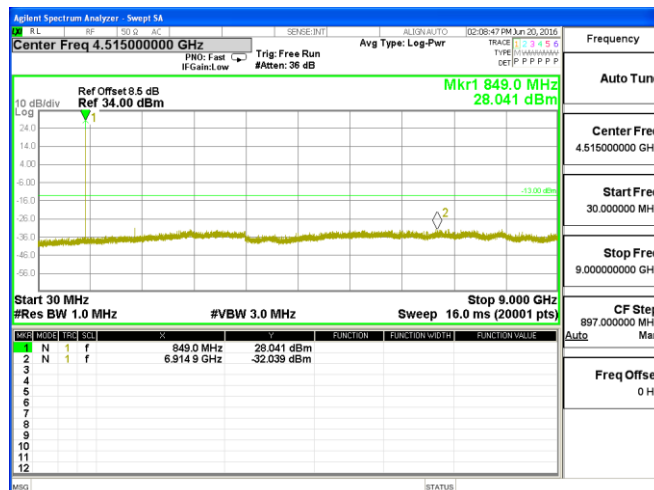



GPRS 850 BAND Lowest Channel

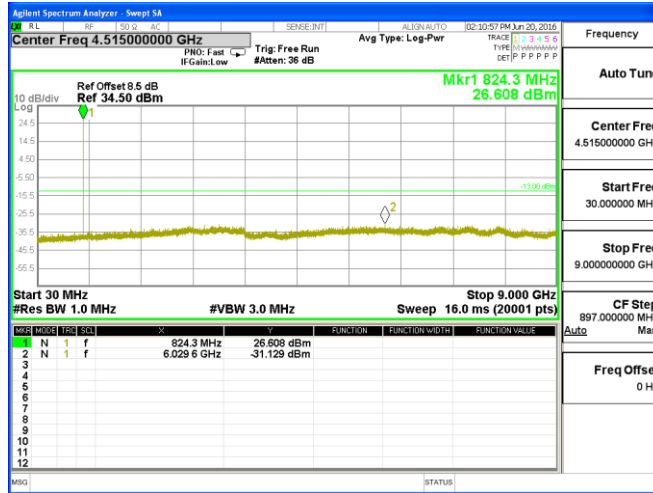

Middle Channel

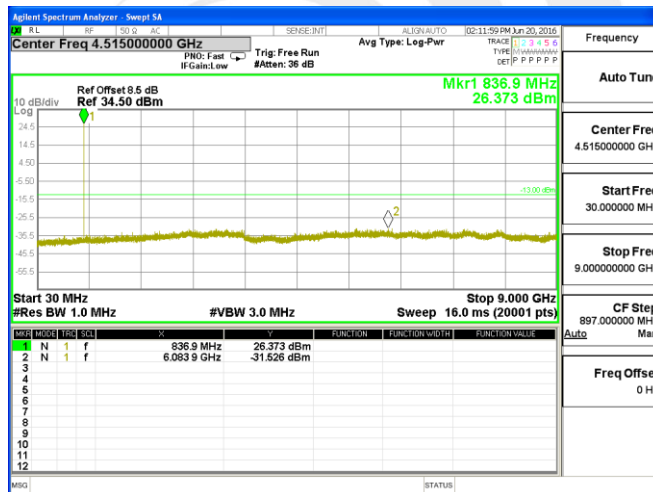

Highest Channel

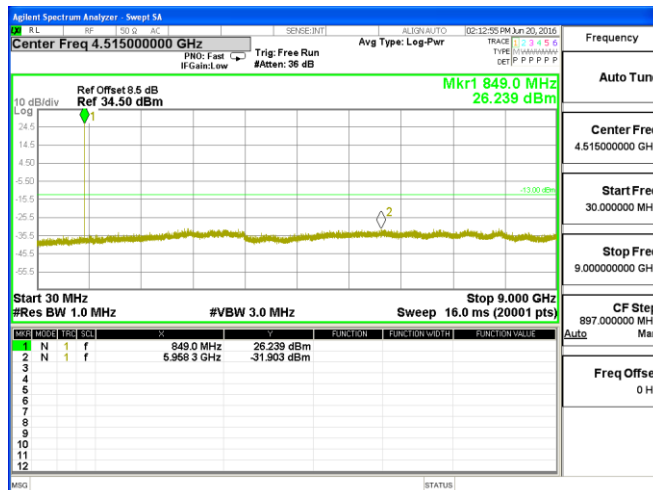



GSM1900 BAND(30M-12G)

Lowest Channel

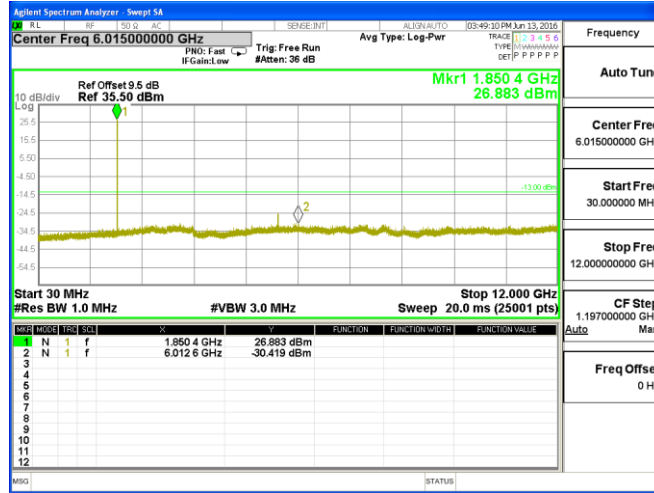

Middle Channel

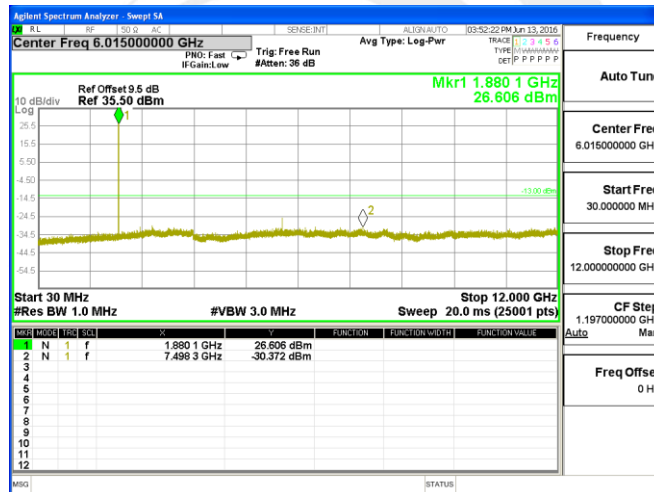

Highest Channel

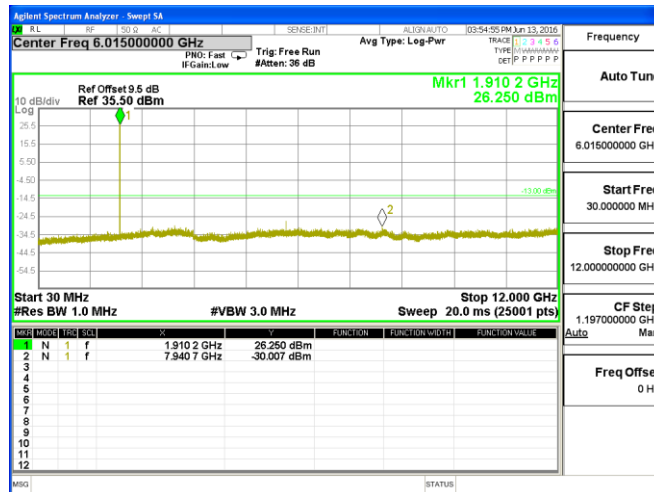



GSM1900 BAND(12G-20G)

Lowest Channel

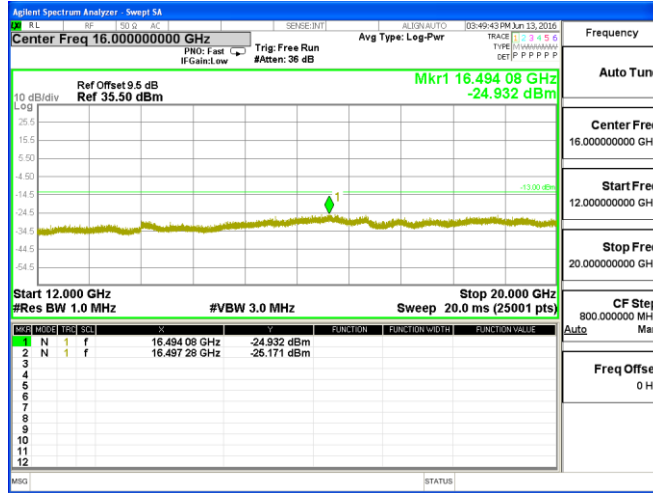

Middle Channel

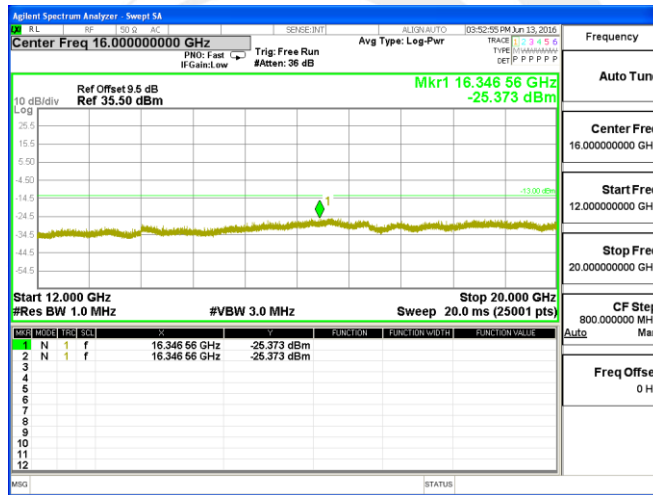

Highest Channel

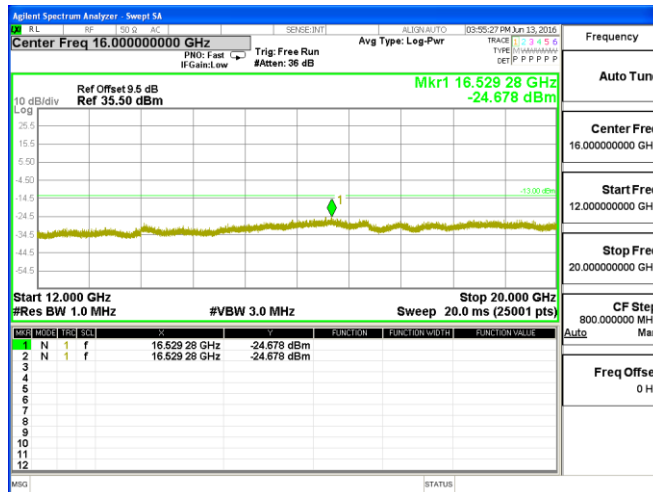



GPRS1900 BAND(30M-12G)

Lowest Channel

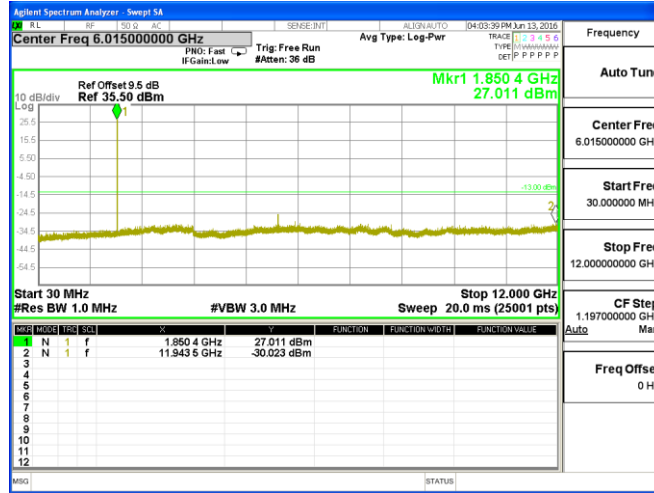

Middle Channel

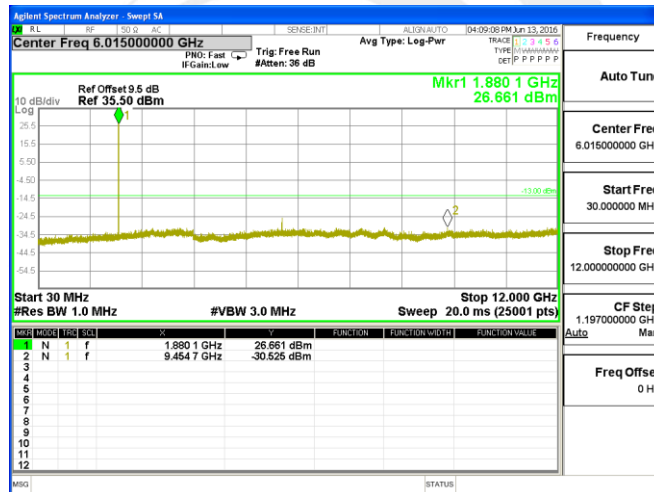

Highest Channel

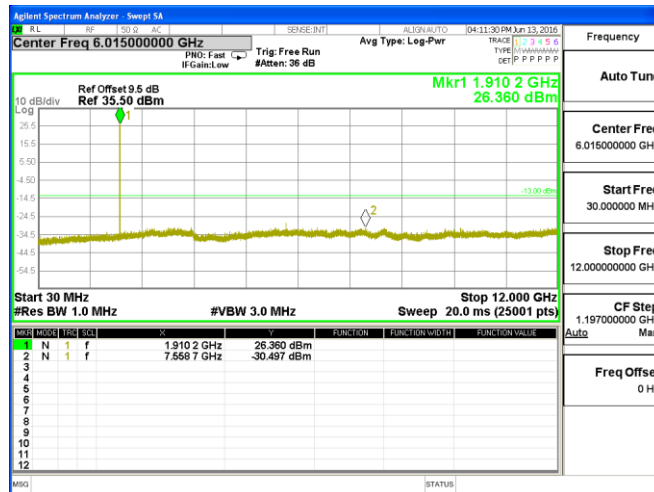



GPRS1900 BAND(12G-20G)

Lowest Channel

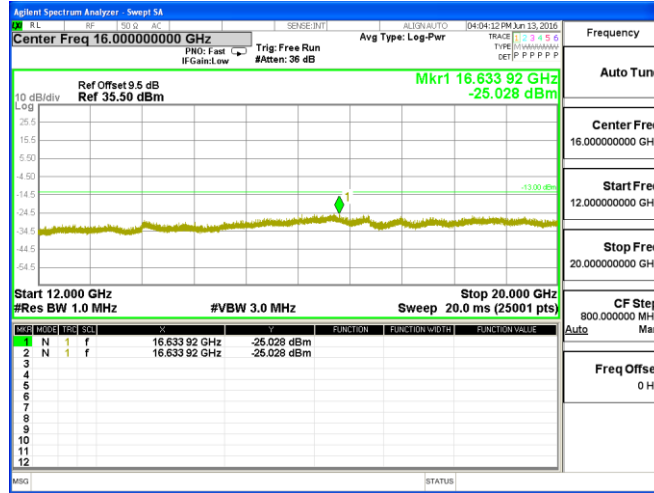

Middle Channel

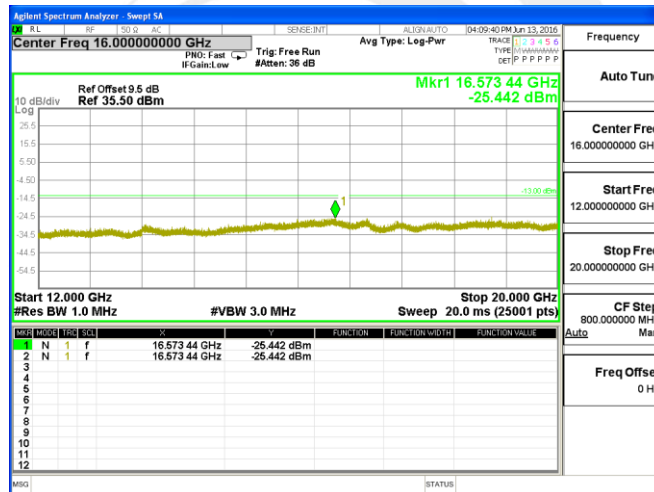

Highest Channel

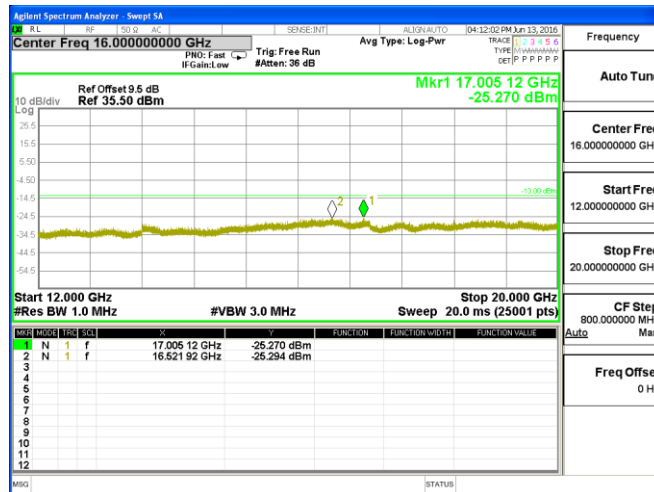



GSM 850

Lowest Band Edge

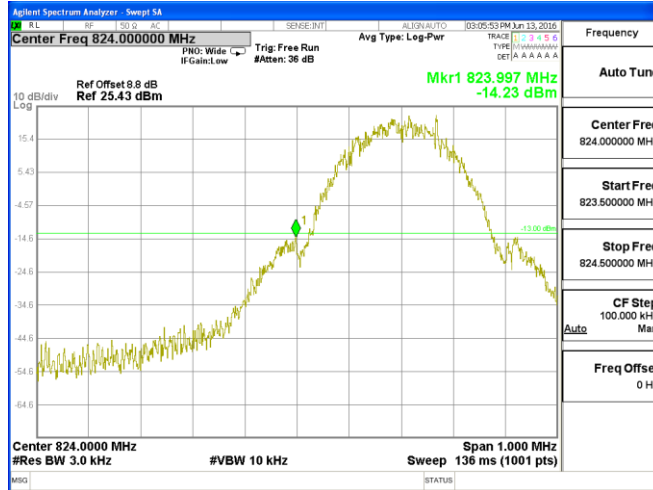

Note: Offset=Cable loss(8.5)+10log(3.2/3)=8.5+0.3=8.8 dB

Highest Band Edge

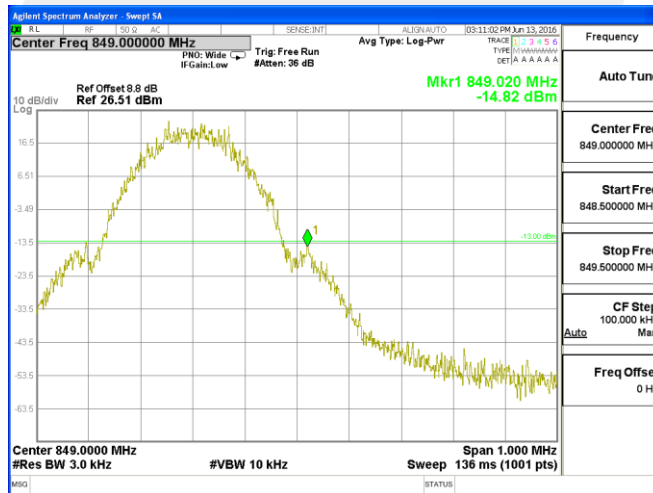

Note: Offset=Cable loss(8.5)+10log(3.2/3)=8.5+0.3=8.8 dB



GPRS 850

Lowest Band Edge

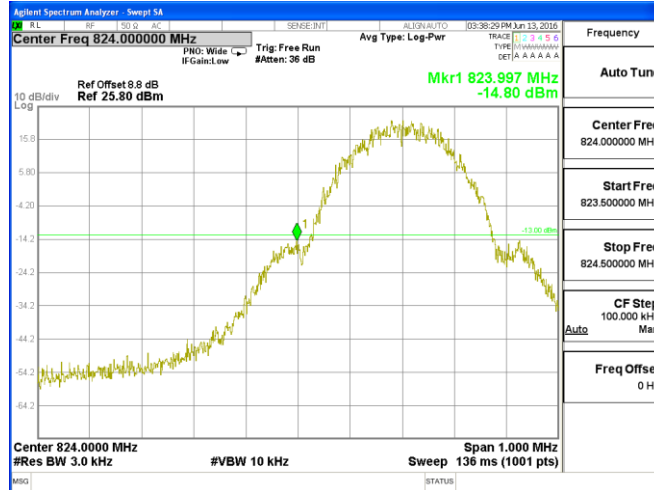

Note: Offset=Cable loss(8.5)+10log(3.2/3)=8.5+0.3=8.8 dB

Highest Band Edge

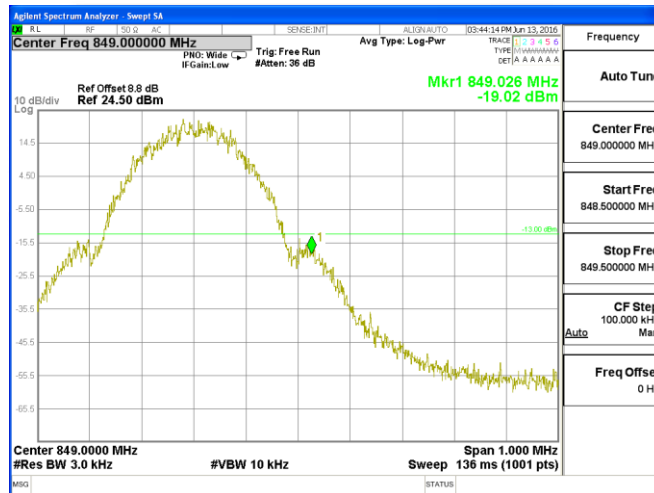

Note: Offset=Cable loss(8.5)+10log(3.2/3)=8.5+0.3=8.8 dB



GSM 1900

Lowest Band Edge

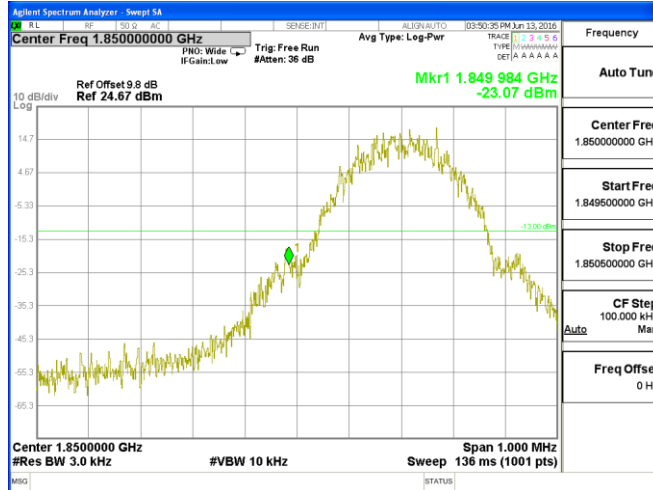

Note: Offset=Cable loss(9.5)+10log(3.2/3)=9.5+0.3=9.8 dB

Highest Band Edge

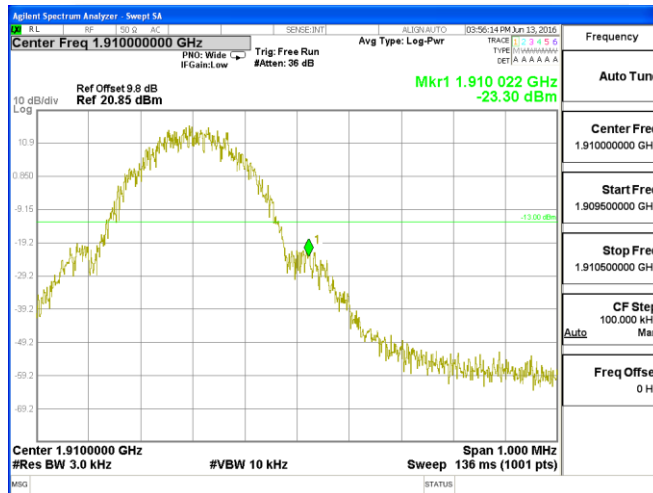

Note: Offset=Cable loss(9.5)+10log(3.2/3)=9.5+0.3=9.8 dB



GPRS 1900

Lowest Band Edge

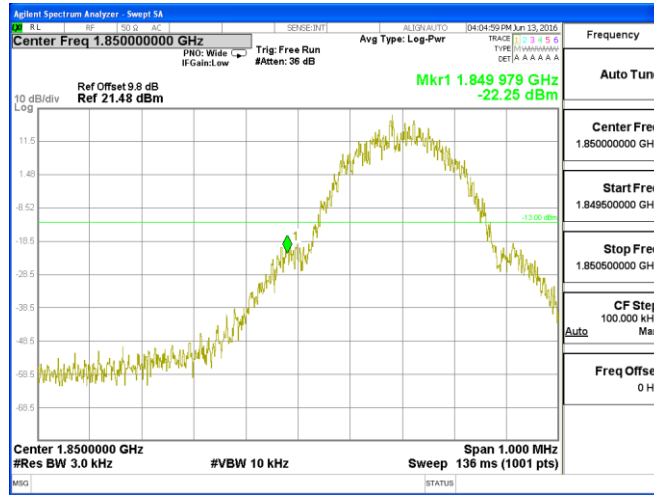

Note: Offset=Cable loss(9.5)+10log(3.2/3)=9.5+0.3=9.8 dB

Highest Band Edge

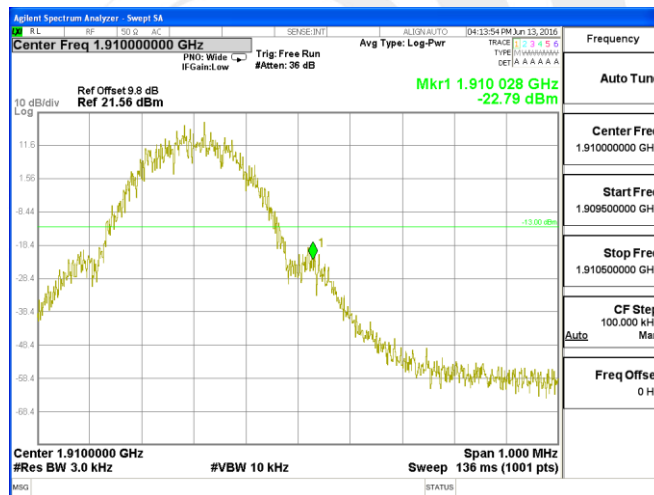

Note: Offset=Cable loss(9.5)+10log(3.2/3)=9.5+0.3=9.8 dB



A8 FIELD STRENGTH OF SPURIOUS RADIATION MEASUREMENT
GSM 850: (30-9000)MHz

The Worst Test Results Channel 128/824.2 MHz						
Frequency(MHz)	Power(dBm)	A _{Rpl}	P _{Mea} (dBm)	Limit (dBm)	Margin(dBm)	Polarity
1648.521	-35.46	-4.65	-40.11	-13	-27.11	Horizontal
2472.69	-37	-2.21	-39.21	-13	-26.21	Horizontal
3296.878	-31.07	0.21	-30.86	-13	-17.86	Horizontal
1648.572	-38.54	-4.65	-43.19	-13	-30.19	Vertical
2472.719	-41.8	-2.21	-44.01	-13	-31.01	Vertical
3296.913	-42.72	0.21	-42.51	-13	-29.51	Vertical
The Worst Test Results Channel 190/836.6 MHz						
Frequency(MHz)	Power(dBm)	A _{Rpl}	P _{Mea} (dBm)	Limit (dBm)	Margin(dBm)	Polarity
1673.277	-36.46	-4.65	-41.11	-13	-28.11	Horizontal
2509.944	-42.98	-2.21	-45.19	-13	-32.19	Horizontal
3346.424	-38.16	0.21	-37.95	-13	-24.95	Horizontal
1673.312	-37.49	-4.65	-42.14	-13	-29.14	Vertical
2510.016	-31.82	-2.21	-34.03	-13	-21.03	Vertical
3346.518	-36.71	0.21	-36.5	-13	-23.5	Vertical
The Worst Test Results Channel 251/848.8 MHz						
Frequency(MHz)	Power(dBm)	A _{Rpl}	P _{Mea} (dBm)	Limit (dBm)	Margin(dBm)	Polarity
1697.658	-35.49	-4.65	-40.14	-13	-27.14	Horizontal
2546.516	-44.01	-2.21	-46.22	-13	-33.22	Horizontal
3395.335	-42.11	0.21	-41.9	-13	-28.9	Horizontal
1697.723	-35.46	-4.65	-40.11	-13	-27.11	Vertical
2546.601	-41.79	-2.21	-44	-13	-31	Vertical
3395.335	-37.73	0.21	-37.52	-13	-24.52	Vertical

- Note:** (1)Below 30MHz no Spurious found is the worst condition.
(2)Above 3.5GHz amplitude of spurious emissions which are attenuated by more than 20dB below the permissible value has.



GPRS 850: (30-9000)MHz

The Worst Test Results Channel 128/824.2 MHz						
Frequency(MHz)	Power(dBm)	A _{Rpl}	P _{Mea} (dBm)	Limit (dBm)	Margin(dBm)	Polarity
1648.551	-37.49	-4.65	-42.14	-13	-29.14	Horizontal
2472.76	-38.05	-2.21	-40.26	-13	-27.26	Horizontal
3296.869	-32.1	0.21	-31.89	-13	-18.89	Horizontal
1648.56	-39.48	-4.65	-44.13	-13	-31.13	Vertical
2472.806	-42.74	-2.21	-44.95	-13	-31.95	Vertical
3296.936	-43.78	0.21	-43.57	-13	-30.57	Vertical
The Worst Test Results Channel 190/836.6 MHz						
Frequency(MHz)	Power(dBm)	A _{Rpl}	P _{Mea} (dBm)	Limit (dBm)	Margin(dBm)	Polarity
1673.332	-37.46	-4.65	-42.11	-13	-29.11	Horizontal
2509.845	-44.96	-2.21	-47.17	-13	-34.17	Horizontal
3346.506	-40.13	0.21	-39.92	-13	-26.92	Horizontal
1673.346	-39.49	-4.65	-44.14	-13	-31.14	Vertical
2509.929	-32.83	-2.21	-35.04	-13	-22.04	Vertical
3346.587	-38.7	0.21	-38.49	-13	-25.49	Vertical
The Worst Test Results Channel 251/848.8 MHz						
Frequency(MHz)	Power(dBm)	A _{Rpl}	P _{Mea} (dBm)	Limit (dBm)	Margin(dBm)	Polarity
1697.699	-37.47	-4.65	-42.12	-13	-29.12	Horizontal
2546.49	-44.98	-2.21	-47.19	-13	-34.19	Horizontal
3395.274	-43.16	0.21	-42.95	-13	-29.95	Horizontal
1697.715	-36.49	-4.65	-41.14	-13	-28.14	Vertical
2546.511	-42.8	-2.21	-45.01	-13	-32.01	Vertical
3395.362	-38.68	0.21	-38.47	-13	-25.47	Vertical

Note: (1)Below 30MHz no Spurious found is the worst condition.

(2)Above 3.5GHz amplitude of spurious emissions which are attenuated by more than 20dB below the permissible value has.



PCS 1900: (30-20000)MHz

The Worst Test Results for Channel 512/1850.2MHz						
Frequency(MHz)	Power(dBm)	A _{Rpl}	P _{Mea} (dBm)	Limit (dBm)	Margin(dBm)	Polarity
3700.465	-33.43	0.33	-33.1	-13	-20.1	Horizontal
5550.739	-36.01	4.01	-32	-13	-19	Horizontal
7400.985	-42.15	10.7	-31.45	-13	-18.45	Horizontal
3700.507	-34.51	0.33	-34.18	-13	-21.18	Vertical
5550.745	-35.82	4.01	-31.81	-13	-18.81	Vertical
7401.019	-41.68	10.7	-30.98	-13	-17.98	Vertical
The Worst Test Results for Channel 661/1880.0MHz						
Frequency(MHz)	Power(dBm)	A _{Rpl}	P _{Mea} (dBm)	Limit (dBm)	Margin(dBm)	Polarity
3760.245	-36.49	0.33	-36.16	-13	-23.16	Horizontal
5640.254	-36.97	4.01	-32.96	-13	-19.96	Horizontal
7520.266	-32.09	10.7	-21.39	-13	-8.39	Horizontal
3760.328	-38.54	0.33	-38.21	-13	-25.21	Vertical
5640.285	-41.78	4.01	-37.77	-13	-24.77	Vertical
7520.346	-42.74	10.7	-32.04	-13	-19.04	Vertical
The Worst Test Results for Channel 810/1909.8MHz						
Frequency(MHz)	Power(dBm)	A _{Rpl}	P _{Mea} (dBm)	Limit (dBm)	Margin(dBm)	Polarity
3819.665	-36.44	0.33	-36.11	-13	-23.11	Horizontal
5729.447	-36.97	4.01	-32.96	-13	-19.96	Horizontal
7639.277	-32.14	10.7	-21.44	-13	-8.44	Horizontal
3819.675	-38.51	0.33	-38.18	-13	-25.18	Vertical
5729.491	-41.79	4.01	-37.78	-13	-24.78	Vertical
7639.375	-42.75	10.7	-32.05	-13	-19.05	Vertical

Note: (1)Below 30MHz no Spurious found is the worst condition.

(2)Above 8GHz amplitude of spurious emissions which are attenuated by more than 20dB below the permissible value has.



GPRS 1900: (30-20000)MHz

The Worst Test Results for Channel 512/1850.2MHz						
Frequency(MHz)	Power(dBm)	A _{Rpl}	P _{Mea} (dBm)	Limit (dBm)	Margin(dBm)	Polarity
3700.482	-35.48	0.33	-35.15	-13	-22.15	Horizontal
5550.74	-38.01	4.01	-34	-13	-21	Horizontal
7400.912	-44.06	10.7	-33.36	-13	-20.36	Horizontal
3700.486	-36.49	0.33	-36.16	-13	-23.16	Vertical
5550.747	-37.75	4.01	-33.74	-13	-20.74	Vertical
7400.994	-42.73	10.7	-32.03	-13	-19.03	Vertical
The Worst Test Results for Channel 661/1880.0MHz						
Frequency(MHz)	Power(dBm)	A _{Rpl}	P _{Mea} (dBm)	Limit (dBm)	Margin(dBm)	Polarity
3760.182	-37.51	0.33	-37.18	-13	-24.18	Horizontal
5640.3	-37.98	4.01	-33.97	-13	-20.97	Horizontal
7520.241	-33.08	10.7	-22.38	-13	-9.38	Horizontal
3760.267	-39.55	0.33	-39.22	-13	-26.22	Vertical
5640.315	-42.81	4.01	-38.8	-13	-25.8	Vertical
7520.322	-43.67	10.7	-32.97	-13	-19.97	Vertical
The Worst Test Results for Channel 810/1909.8MHz						
Frequency(MHz)	Power(dBm)	A _{Rpl}	P _{Mea} (dBm)	Limit (dBm)	Margin(dBm)	Polarity
3819.655	-37.52	0.33	-37.19	-13	-24.19	Horizontal
5729.5	-37.95	4.01	-33.94	-13	-20.94	Horizontal
7639.313	-33.2	10.7	-22.5	-13	-9.5	Horizontal
3819.664	-39.49	0.33	-39.16	-13	-26.16	Vertical
5729.511	-42.77	4.01	-38.76	-13	-25.76	Vertical
7639.328	-43.73	10.7	-33.03	-13	-20.03	Vertical

Note: (1)Below 30MHz no Spurious found is the worst condition.

(2)Above 8GHz amplitude of spurious emissions which are attenuated by more than 20dB below the permissible value has.



APPENDIX B PHOTOS OF TEST SETUP

RADIATED SPURIOUS EMISSION



※※※※※END OF THE REPORT※※※※※