

User manual

Thank you very much for your choice of this product designed by our company!

Contents

For your safety	2
About Your Phone	3
Preparing Your Phone	5
Call functions	8
Text entry	8
Menu operation	9
Menu functions	9
1. Phonebook.....	9
2. Call center.....	10
3. Extra.....	11
4. Alarm	12
5. Organizer	12
6. Games	12
7. Media	12
8. Message.....	14
9. Calendar	16
10. Settings.....	16
11. Services.....	17
12. User profiles.....	17
13. Social Network	18
14. Camera	18
15. Gallery	18
16. Bluetooth	18
Maintain and Care.....	19
Technical Specifications	19

For your safety

Read these simple guidelines. Breaking the rules may be dangerous or illegal. Further detailed information is given in this manual.

ROAD SAFETY

Always keep your hands free to operate the vehicle while driving. Park the vehicle before using your phone.

SWITCH OFF IN AIRCRAFT

Using of wireless telephones in aircraft may disrupt the operation of the aircraft. It is dangerous and illegal. Insure switching off the phone before going aboard.

SWITCH OFF IN HOSPITALS

Follow any restrictions or rules. Switch off the phone near medical equipment.

SWITCH OFF WHEN REFUELING

Switch off the phone at a refueling point or any fuel or chemicals places.

SWITCH OFF NEAR BLASTING POINT

Don't use the phone where blasting is in progress. Observe restrictions, and follow any regulations or rules.

INTERFERENCE

All wireless phones may be susceptible to interference, which could affect the performance.

USE NORMALLY

Use in the normal position explained in the product documentation. Don't touch the antenna unnecessarily.

ENHANCEMENTS AND BATTERIES

Use only the approved enhancements and batteries. Do not connect incompatible products.

EMERGENCY CALLS

Ensure the phone is switched on and in service. Enter the emergency number, and then press the talk key. It will give your location. Do not end the call until the permission.





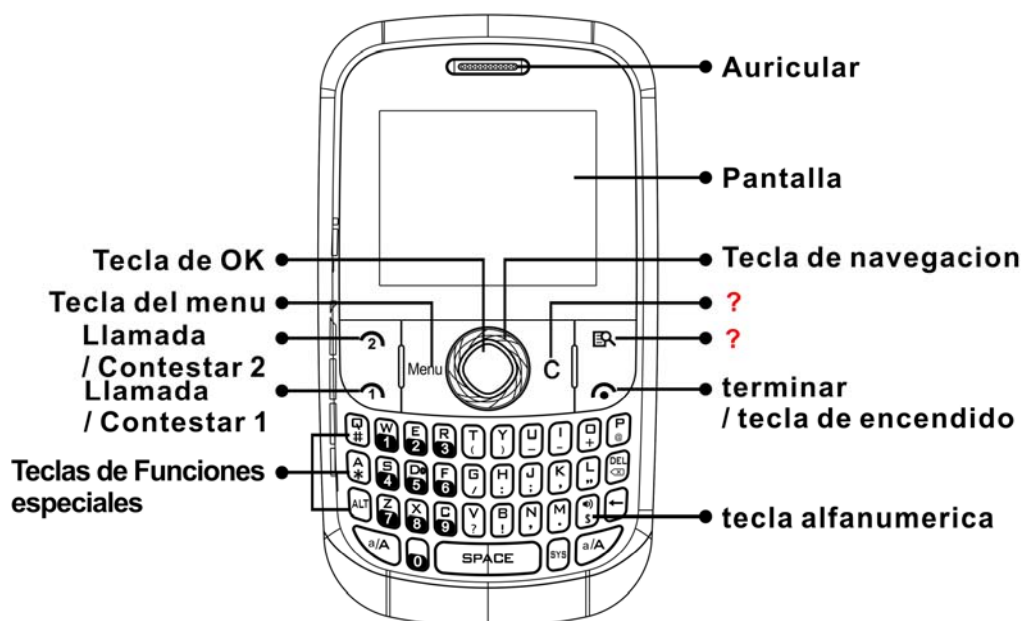

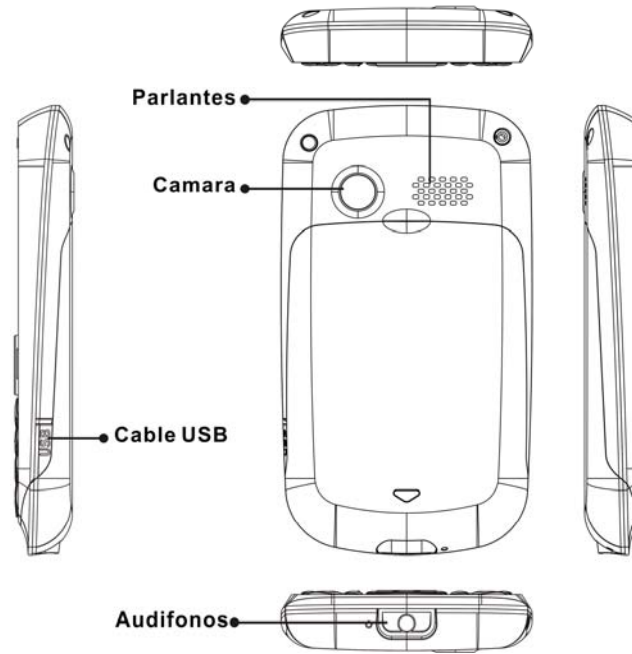



About Your Phone

1. Glimpse of Your Phone



















2. Knowing the Keys

Key	Description
	SIM2 send key Use SIM2 make call / Answer incoming call
	Shortcuts To Home Page WAP
	SIM1 send Key Use SIM1 make call / Answer incoming call
	End/ Power Key Long press to power phone ON/OFF; press to end; reject call; or to exit a menu. Click button in standby can be opened and closed a key power-saving features
	OK Key Press this key to open the extended menu.
	Navigator Keys Press up/down/left/right direction in menu to scroll, browse or in edit page to move cursor.
	Back key
	Phone book
	Alt key Long press ALT key to switch the standby power-saving mode
	* key Long press the * key to switch the standby mode and the general pattern of quiet

	<p># key Long press the # key in standby solution Lock keyboard</p>
---	--

3. Understanding Display Icons

Icon	Explanation
	<p>Signal Strength of SIM1/SIM2 Shows the received signal strength. Fuller bar means stronger signal.</p>
	<p>Lock the keypad</p>
	<p>New sim1 SMS</p>
	<p>New MMS</p>
	<p>GPRS</p>
	<p>Divert all data calls</p>
	<p>Missed calls</p>
	<p>Headset is on</p>
	<p>Battery Status Shows the charge level of phone battery. Fuller bar indicate more power left. When charging, the bar will scroll until the battery is fully charged.</p>
	<p>Stopwatch is on</p>
	<p>Alarm Appears when an alarm is set and activated.</p>
	<p>Incoming Call Alert Mode Ring</p>
	<p>Incoming Call Alert Mode Vibrate</p>
	<p>Incoming Call Alert Mode Vibrate then Ring</p>
	<p>Incoming Call Alert Mode Vibrate and Ring</p>

Preparing Your Phone

1. Installing SIM Card

- Please keep your SIM card away from reach of children.
- Scratches and bends can easily damage the SIM card. Please be extra careful when installing, removing, handling or storing your SIM card.
- Before installing or removing the SIM card, make sure the phone is switched OFF, and then remove the back cover and battery.

1. Slide the back covers upward the bottom of the phone until it can be removed.
2. Remove the battery (see Removing Battery).
3. Place SIM cad into the SIM holder.

4. Fit the battery with the metallic contacts at the right bottom corner.
5. Replace the back cover by fitting it to the back of the phone.

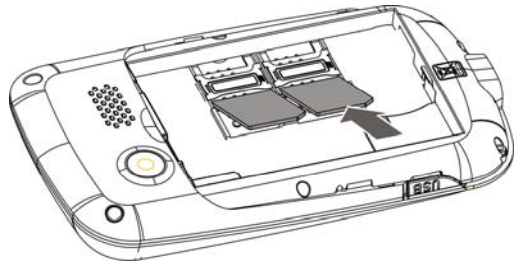

2. Install Battery

- (1) Connect the battery's metal touch points separately with the battery compartment metal touch points, and enter the battery base to the slot.
- (2) Slide the back cover toward the top of the phone to lock the cover into its place.

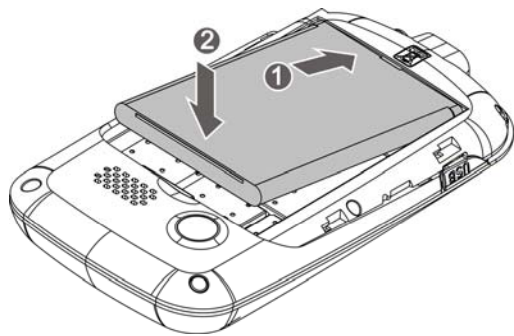

3. Remove Battery

Remove the back cover then push toward the bottom of the phone and lift the battery at the top side center to remove.

- Settings and data stored in the phone or SIM card may be lost after the battery is removed.

4.. Charge Battery

Connect the charger to power supply, and then insert the charger pin into the I/O jack.

Note:

1. When charging, DO NOT remove or take out the battery to avoid the battery circuit to burn out.
2. While charging, it is normal that the phone and charger will become hot.
3. If the battery is completely empty, it may take a period of time before the charging icon appears on the display.

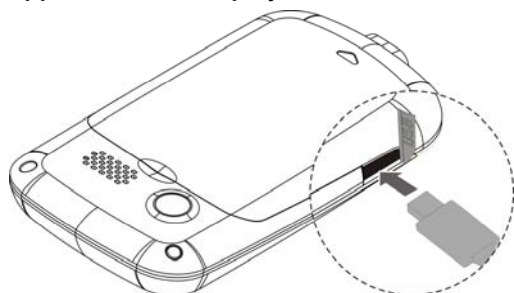

5.. USB Management

When USB cable plugged in, the USB charger function will startup. If there is a memory card inside the phone, the popup dialog box will ask you reboot the phone to used as a USB Flash Disk or not.

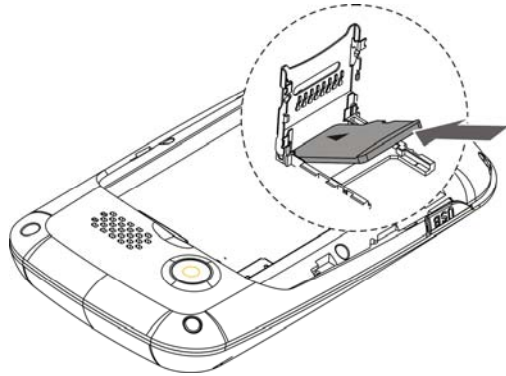

6. Power on and off

Press and hold Power key to turn on/off the phone.
And if you have set PIN or phone code, input it correctly.

7. Security Code

PIN Code

The PIN (Personal Identification Number) code protects your SIM cards against unauthorized use. It is normally supplied with the SIM card package. Be careful while entering PIN code,

3 wrong tries in entering PIN code will block the SIM from use, requiring input of PUK code to unblock. Please contact your operator for further details.

PIN2 Code

The PIN2 code is required when activating certain special features (such as call costs and fixed dialing). It is normally supplied with the SIM card package. Be careful while entering PIN2 code, 3 wrong tries in entering PIN2 code will block the SIM from use, requiring input of PUK2 code to unblock. Please contact your operator for further details.

PUK Code

The PUK (Personal Unblocking Key) code is required to unblock a blocked PIN code. It is normally supplied with the SIM package; otherwise contact your service provider for the code. Keep your PUK code in a safe place, do not throw it away. Contact your service provider if it is lost.

If your SIM is blocked, your phone will ask you to enter PUK code to unblock. You have 10 tries to enter the right PUK code, after which your SIM might be permanently blocked.

Phone Password

The Phone Code is a 4 to 8 digit security code that protects unauthorized use of your phone.

The factory default code is "0000". Once activated, the phone will ask you to enter Phone code every time it is turned on. For your protection, change the default phone code as soon as possible.

Do not forget your phone password.

Call functions

1. Making a Call

Make a domestic call

Enter the phone number including the area code. Press the SIM1/SIM2 send key to make a call.

viz.: area code—telephone exchange numbers—P—extension numbers, then press SIM1/SIM2 send key.

Make an international call

Enter the country code, the area code and the phone number, press SIM1/SIM2 send key to dial.

Make a call from Phone book

Enter Phone book, select the phone number, and then press SIM1/SIM2 send key to make a call with SIM1 or SIM2 respectively.

Redial a call by recent call lists

In standby mode, press the right selection key to find the recent call lists, scroll to the number or name, then press SIM1/SIM2 send key to dial.

2. Answer a call

An incoming call window will be displayed as the phone receives a call. The number will appear on the window if you have opened this function. If this number is not saved in the phone book, the call's district number will show it on the window.

Press SIM1/SIM2 send key to answer it.

If an incoming call arrived during your operation in sub window, a new window will be popped to inform you and your any operation will be broken. If you missed a call, a missed call log will appear after you return to the start screen.

3. Call options

During a call, the options content is changeable according to your call status. The functions of Call Waiting, Call Hold need the support of net work.

Here are some parts of the options, like "pitch", "New Call", "Phone Book", "Message center", "Sound Recorder", "Background sound", "Mure", "DTMF", "Hold single call" and "End single call"

Text entry

You may be requested to input text message many times when you using this phone. For

example, when you write a message or add a new phone book record, you can select different input methods, such as ABC, abc.....

You can input characters, letters, digitals or special characters including punctuations.

Switch input methods

In a text entry state, you can press the sym key to switch from one method to another method.

Input method

Switch to uppercase or lowercase mode.

Press a key once to insert the first letter on the key, twice for the second letter, etc.

If you pause briefly, the last letter in the display is accepted and your phone awaits the next entry.

Input special character

press alt key to display the character list in edit screen

Menu operation

The phone provides a serious of menu. And you can select it according to your need. The functions exist in these menus and submenus. Access the menus by scrolling.

Menu functions

1. Phonebook

When you enter phonebook you can found quick search, Search Contact, Add New Contact, Copy All, Delete, Caller groups, Extra Numbers, Phonebook settings, Caller Picture, Caller Ring Tone. Select a number, then you can, call, send SMS, send MMS, view, edit, delete, copy, move and send VCard.

Note:

1. One ring tone can only be select as caller ring tone after the file in the file manager send to the ring list.
2. Copy items from phone to SIM card, it can only copy the name and number of a record. Only the record in phonebook can be set as the member in the group, caller picture, caller ring tone and caller video.

2. Call center

2.1 Call Log

Select call history from main menu, you can view the information about SIM1 & SIM2 call log, including missed calls, dialed calls, received calls, delete call log, call timer, call cost, SMS counter and GPRS counter.

2.2 General call settings

Divert your incoming calls to voicemail or other numbers for SIM1/SIM2.

There are five diverting ways, each of which can be set to switch on; switch off and search. When the phone is switched on, key in the number to divert according to the indications on the screen.

2.2.1 SIM1 (SIM2) call settings:

- **Caller ID**

There are these options; "set by network", "hide id", and "send id".

- **Call waiting**

If it is supported by your service provider, call waiting will notifies you of an incoming call even if you are in a call. You can then accept, reject, or ignore the incoming call.

To make this function available, please contact local network provider.

- **Call forward**

Call diverting is a network services, it tells your network to divert incoming calls to another number to avoid missing a call.

The following is available: divert all voice calls, divert if unreachable, divert if no answer, divert if busy, divert all data calls, and cancel all divert.

- **Call barring**

If it is supported by your service provider, this function will enable you to restrict the incoming or outgoing calls.

- **Line switching**

Enter this menu user can switch to line1 or line2.

2.2.2 Black list

Add the numbers what you do not want communicate to avoid harassing.

2.2.3 Auto redial

It can dial the same phone number automatically after a failing dial with this function.

2.2.4 Speed dial

Speed dial is a shortcut to dial frequently called numbers. Set the numbers to speed dials before use it.

2.2.5 IP dial

You can set the prefix IP number with this function.

2.2.6 Background sound

Select when make call:turn on or off this function

Playback settings:set background sound playing time

Effect list:display sound file list

2.2.7 More

- **Call time display:** Set it to "on" or "off" state
- **Call time reminder:** There will be a hint sound when the setting time passed during

a call.

3. Extra

3.1 Calculator

The phone can be used as a calculator to finish some simple arithmetic work. touch number key to enter the number. “ • ”key to enter radix point.

3.2 Unit converter

Input the rate, then you can do the currency converter.

3.3 Currency converter

Input the rate, then you can do the currency converter.

3.4 Stopwatch

There are two types of stopwatches: typical stopwatch and multiplex stopwatch.

3.5 Ebook reader

3.6 Bluetooth

Bluetooth is a global standard for wireless connectivity. Bluetooth is based on a lowcost, short-range radio. Bluetooth technology facilitates the replacement of the cables normally used to connect one device to another, with one universal short-range radio link. Two Bluetooth devices can talk to each other when they come within a range of 10 meters to each other. Due to their dependence on a radio link, as opposed to alternate technology such as an infrared connection, Bluetooth devices do not require a line-of-sight connection in order to communicate. Bluetooth can interfere, come in for wall or other electron device and so on. Making Bluetooth device, battery capability will waste quickly.

For insuring, phone and bluetooth can connect, please refer with equipment manufacturer before buy.

In some place, bluetooth can limit, before making, please refer the local charge department or service operator.

- ☆ Power: to press the “OK” to activate or deactivate
- ☆ Inquiry Audio Device: to press the left soft key to inquiry audio device. If device find, press the left soft key “Bond”, then input password, finish coupling.
- ☆ My Device :to press the left soft key “OK” to display my device which device have connected. Then press the left soft key “Option” to handle as follows
 - Connect :to select one device to connect it.
 - Rename:to amend the device show name.
 - Delete:to delete this note.
 - Delete All:to delete all notes.
 - Service List :to display the service list of this device.
- ☆ Active Device: to display active device, press the left soft key “Disc.” to cut link.
- ☆ Setting: to display function setting as follows.

Visibility :to press the left soft key to activate.

Change Device Name:to amend the device name.

Authentication: to set the device link whether need authentication.

Audio Path: to select Leave in phone or Forward to BT Headset.

☆ About: to show service list about this phone.

3.7 Answer machine

4. Alarm

Set the alarm time and it will remind you by alert tone or vibration when the alarm time expires.

You can set 5 alarms in the phone at most.

5. Organizer

You can use various functions provided in this phone

5.1 Tasks

To do list may remind somebody to do some special things which are specified by user.

When there are some task lists, touch left soft key or center key, you may enter a new screen with following:

- **View:** View the selected task list.
- **Add:** Add a new task list.
- **Edit:** Edit the selected task list.
- **Delete:** Delete the selected task list.
- **Delete all:** Delete all task lists.

5.2 World clock

Under this menu, you can look up current time and time zones of different cities in the world after selecting the time zone.

5.3 Shortcuts

6. Games

Provide you with general game, the game comes with the specific operation, please see the help instructions.

7. Media

7.1 Image viewer

Access this menu; you can view the pictures in the list. If you select one picture, there are several operations including "view", "browse style", "forward", "rename", "delete", "delete all files", "sort by" and "storage".

You can forward the picture to wallpaper, screen saver, power on display, power off display,

phonebook and Bluetooth. Whether the operation can be successful or not is related to some factors such as the size of the screen.

7.2 Video recorder

Access this menu, you can record short video with phone camera.

7.3 Video player

Access the menu, you can enter film list and touch "option" to choose a movie clip to play, forward, rename, delete, delete all files, and sort by.

While playing, press scroll up or down key to adjust play speed, scroll right or left key to adjust the rate of progress.

7.4 Audio player

Select audio player in the main menu item or keyboard shortcut to enter the audio player interface. touch the scroll up key to play or pause and scroll down key to stop Mp3, touch the scroll left/right key to switch to the previous/next song, touch "List" to enter the list of song, then press "option" to do the work such as Play, Detail, Add to Rings, Refresh List and Settings.

The concrete operations in Settings are "Play List", "List auto gen", "Repeat", "Shuffle", "Background play", "Lyrics Display".

Note: If "List auto gen" is opened, the play list will be created automatically from phone or memory card according to the storage. If closed, the user should create or delete the file in play list manually.

7.5 Sound recorder

The sound recorder supports two formats: WAV and AMR.

When there's no recording file in the current Storage Device, you can touch left soft key or OK key to entry the options as following:

- **Record:** Start the recorder.
- **Settings:** Set the Storage Device of recording file, phone memory or T-flash card. Set recording format, AMR or WAV. Set the recording sound quality, low or high.

When recording files exist in the current Storage Device, you can press left soft key or OK key to enter the following options:

- **Record:** Start the recorder.
- **Play:** Play the selected recording file.
- **Append:** Append the recording data to the end of the selected file. (Only AMR format files support this operation.)
- **Rename:** Rename the selected file name.
- **Delete:** Delete the selected recording file.
- **Delete all files:** Delete all the recording files.
- **Use as:** Set to user profiles.
- **Send:** Send as MMS or Bluetooth.

7.6 FM radio

In the FM radio screen, you can touch the scroll left/right key to switch broadcast channels;

touch the scroll down key to stop / play; touch the scroll up key to open auto search;

- **Channel list**

At most 20 channels could be saved in the list.

- **Manual Input**

Directly input the FM frequency of the channel.

- **Preset Auto search**

To search all channels and save them in the channel list automatically.

- **Settings**

To set the 'back ground playing' and 'loud speaker' state.

Notes: The quality of FM is influenced by the range of broadcasting station.

8. Message

8.1 NYX Connect Mail

8.1.1 Push mail service

User can setup push mail service to their own email account. It is strongly recommend user to insert memory card before using push mail service.

8.2.1 Add Account

User can add their email account(s) with push mail service

8.2 NYX Messenger

User can use the NYX PIN messenger to communicate with other NYX messenger friends; and also user can connect to their Facebook chat service to chat with Facebook friends.

8.3 Text message

8.3.1 Write message

Access this menu to edit and send message, press "option" to do as following: Use Template, Insert object, Insert Number, Insert name, Insert bookmark, Input method, after finished edit, user can choose send or save message.

8.3.2 Inbox

Access this menu to view the received messages.

When has the new message, the phone will ring, the unread message icon also to be able to appear on top of the screen. Press ok key in view message screen to do the following functions: reply, delete, edit, forward, copy etc.

8.3.3 Outbox

Access this menu to view the saved messages.

Press ok key in viewing message screen to send, edit, delete, copy to phone/SIM, move to phone/SIM, delete all, copy all, move all and use number,use URL.

8.3.4 Drafts

Store the Text message without sending for reading and sending later.

Access this menu, select one Text message from the list and user can view, send, edit, delete, delete all, copy all, move all and use number, use URL.

8.3.5 Templates

User can use or add their own sms templates.

8.3.6 SMS settings

Access this menu to do the following functions: Profile Settings, Common settings, Memory Status, Preferred Storage.

8.4 MMS

This function needs the supporting of network operators. Before using, be sure your SIM provides this function or not. You can consult the network operators.

8.4.1 Write message

Access submenus of "write MMS", there are several items: To, Cc, Bcc, subject and edit content. When you edit, you can Done, Input method, Add picture, Add audio, Add video, Add attachment, Add slide before, Add slide after, Add bookmark text, preview and Slide timing. After finished edit, user can choose "send only", "save", "save and send etc".

8.4.2 Inbox

It stores the received MMS in inbox.

When has the new MMS, the phone will ring, the unread MMS icon also to be able to appear on top of the screen.

After download the MMS to the phone, you can do the following functions: view, delete, reply, save etc.

8.4.3 Outbox

The failed sent MMS will be stored in outbox.

Access this menu, user can choose "view", "resent", "forward", "delete", "delete all", "move to draft", "use detail" or "read properties" to operate the MMS.

8.4.4 Drafts

Store the MMS without sending for reading and sending later.

Access this menu, select one MMS from the list and user can view, send, edit, delete, delete all, save as template, properties and use detail etc.

8.4.5 Templates

User can view and use the template.

8.4.6 MMS settings

Access this menu, user can compose settings, send settings, retrieve settings, filter setting, server settings and memory status.

Note: The storage space left for MMS in the phone is limited. So if the space is insufficient, please delete some unnecessary MMS.

8.5 Voice mail server

This is a Network Service, and should be supported by the service provider.

8.6 Broadcast message

Broadcast public information sent by the network providers. Use Cell Broadcast service, you can receive information on various subjects from network provider. For more available information, please contact your local network providers.

9. Calendar

Access this menu, the calendar will be shown on the screen, and use the navigation keys to change the date, and the calendar shown on the screen will be changed accordingly.

10. Settings

10.1 Phone setup

- **Time and date**
Set the home city, time and date, time and date's format.
- **Schedule power on/off**
You can set 4 power on/off schedule, and the phone will power on or power off according to the settings.
- **Language**
Select the operating language.
- **Preferred input methods**
You can set the default input methods in text editor.
- **Display characteristics**
Set Wallpaper, Screen Savers, show date and time, idle shortcuts.
- **Key Vib Setting**
- **Greeting text**
- **Dedicated Key**
Access the menu you can modify the shortcut of the direction keys in standby mode.
- **Flight mode**
Activate / deactivate flight mode
- **LCD backlight**
You can set the backlight duration and brightness.

10.2 Network setup

This feature is available to operate network settings when you are roaming or travel outside. Access the menu; you can select the network manually or automatically.

10.3 Security setup

You can set the security settings to protect the phone or SIM card from unauthorized use. The default security code is 0000.

10.3.1 Security setup

- **SIM Lock**

Set the phone to ask for your PIN code each time you start your phone (if this function is supported by your SIM card).

Note: After three consecutive incorrect PIN code entries, the code will be blocked, and you need the PUK code to unblock it.

The PIN code and PUK code are usually supplied by the SIM card. If you don't get them,

please contact with the supplier. The default PIN code is 0000 usually.

10.3.2 Phone Lock

Phone lock can be used to lock the device to avoiding unauthorized use.

Set the phone to ask for your security code each time you start your phone.

10.3.3 Auto Keypad Lock

You can set the auto lock time in the submenu of this function, then the key will automatically be locked if there is no more action of the phone.

10.3.4 Fixed dial

If your SIM support fixed dial, it can limit you to call fixed number. When the function is on, it can only call the phone number or phone number start by the fixed dial number.

Note: it needs you to input PIN2 code to open or close this function. You can get the PIN2 code from service supplier. If the fixed dial is on, the phonebook only show the number of fixed dial.

10.3.5 Barred dial

10.3.6 Change Password

You can change phone lock password here.

10.5 Restore factory settings

You can reset some of the Phone settings to their original values by input phone lock password.

11. Services

11.1 Wap

Your phone support WAP function. After the necessary settings, you can use this function normally.

Note: To open this function, you should apply GPRS service to your SIM card.

In WAP user can visiting homepage, display the exist bookmarks, record the website you have visited recently, store the information sent from the service provider and setting WAP.

11.2 Data account

It contains "GSM Data" and "GPRS" data account.

In order to use WAP function normally, please right setting: Account Name, DNS, user name and password.

11.3 Connection management

Show the current active connection

12. User profiles

User profiles define how your phone reacts when you receive a call or a message, how your keypad sounds when you press a key, and more. Each of the available profiles can be left at their default setting or customized to suit your needs. Select and customize the most suitable profile for your situation. The available modes are General, Meeting, Outdoor, Indoor, Headset, stint porfile. In standby mode, you can press and hold chr key to switch to silent mode.

13. Social Network

After boarding the network to enter a user name and password can be operated

14. Camera

Select camera item in main menu to enter preview screen. Then press scroll right or left key to adjust the exposure parameter and scroll up or down key to adjust lens. Click the small icon on the screen to set the effect settings, white balance, scene mode, image's quality, image size. And press center key to take photo

15. Gallery

It provides you the functions such as browsing media files, checking storage space and formatting function.

When browsing the media files, you can operate the selected files such as view, rename coping, deleting etc.

16. Bluetooth

For insuring, phone and bluetooth can connect, please refer with equipment manufacturer before buy.

In some place, bluetooth can limit, before making, please refer the local charge department or service operator.

- ☆ Power: to press the "OK" to activate or deactivate

- ☆ Inquiry Audio Device: to press the left soft key to inquiry audio device. If device find, press the left soft key "Bond", then input password, finish coupling.

- ☆ My Device: to press the left soft key "OK" to display my device which device have connected. Then press the left soft key "Option" to handle as follows

 - Connect: to select one device to connect it.

 - Rename: to amend the device show name.

 - Delete: to delete this note.

 - Delete All: to delete all notes.

 - Service List: to display the service list of this device.

- ☆ Active Device: to display active device, press the left soft key "Disc." to cut link.

- ☆ Setting: to display function setting as follows.

 - Visibility: to press the left soft key to activate.

 - Change Device Name: to amend the device name.

 - Authentication: to set the device link whether need authentication.

 - Audio Path: to select Leave in phone or Forward to BT Headset.

☆ About: to show service list about this phone.

Maintain and Care

Caring for Battery

This phone uses a rechargeable battery as power source, when the charge is weak, recharge immediately to protect the batter life. It is best to drain the battery charge first.

When not using the charger, unplug it from the power source and the phone. Over charging will shorten the battery life. Not leave the charger connected to the unit or battery for more than a week.

Temperature affects battery charge capacity. Your battery may need to be warm up or cool down before charging. If the battery temperature is lower than 0 °C and higher than + 45 °C., it will not recharge.

Use the battery as it is originally intended. Do not short circuit the battery by connecting the positive and negative terminals with a conductor.

Do not use a damaged battery

The battery will not perform properly and its life will be shortened if exposed to extreme temperatures.

Do not place the battery in fire; follow local awls and ordinances in disposing used battery.

Maintenance

Do not leave your phone within the reach of small children (certain removable parts may be accidentally ingested).

Do not use your phone in damp areas (bathroom, swimming pool...). Protect it from liquids and other moisture.

Do not expose your phone to extreme temperatures lower than - 10 °C and higher than + 55 °C.

Technical Specifications

NOTE: Actual operating conditions depend on the local network environment, SIM, and user behavior.

Warning: Any consequence caused by misuse, abuse, or not following any and all of the above-written suggestions and instructions shall not hold the producer in any way responsible to any degree.

Announcement: The manufacturer reserves the right to change or upgrade specifications or software versions without prior or separate notice. Trade marks mentioned or used in this material belong to their respective owners.

FCC caution:

This device complies with part 15 of the FCC Rules. Operation is subject to the following two conditions:

- (1) This device may not cause harmful interference, and
- (2) this device must accept any interference received, including interference that may cause undesired operation.

Any changes or modifications not expressly approved by the party responsible for compliance could void the user's authority to operate the equipment.

Note: This equipment has been tested and found to comply with the limits for a Class B digital device, pursuant to part 15 of the FCC Rules. These limits are designed to provide reasonable protection against harmful interference in a residential installation. This equipment generates uses and can radiate radio frequency energy and, if not installed and used in accordance with the instructions, may cause harmful interference to radio communications. However, there is no guarantee that interference will not occur in a particular installation. If this equipment does cause harmful interference to radio or television reception, which can be determined by turning the equipment off and on, the user is encouraged to try to correct the interference by one or more of the following measures:

- Reorient or relocate the receiving antenna.

- Increase the separation between the equipment and receiver.

- Connect the equipment into an outlet on a circuit different from that to which the receiver is connected.

- Consult the dealer or an experienced radio/TV technician for help.

This wireless phone meets the government's requirements for exposure to radio waves.

The guidelines are based on standards that were developed by independent scientific organizations through periodic and thorough evaluation of scientific studies. The standards include a substantial safety margin designed to assure the safety of all persons regardless of age or health.

The exposure standard for wireless mobile phones employs a unit of measurement known as the Specific Absorption Rate, or SAR, The SAR limit set by the FCC is 1.6W/Kg