

# SAR EVALUATION REPORT

For

## ITALCOM GROUP

1728 Coral Way, Coral Gables, Miami, Florida, United States

**FCC ID: YPVITALCOMTWISTX2**

<b>Report Type:</b> Original Report	<b>Product Type:</b> Mobile Phone
<b>Test Engineer:</b> <u>Sandy Wang</u>	<i>Sandy Wang</i>
<b>Report Number:</b> <u>RSZ111129002-20</u>	
<b>Report Date:</b> <u>2012-01-04</u>	
<b>Reviewed By:</b>	<i>Merry Zhao</i>
<b>Test Laboratory:</b> Merry Zhao EMC Engineer Bay Area Compliance Laboratories Corp. (Shenzhen) 6/F, the 3rd Phase of WanLi Industrial Building, ShiHua Road, FuTian Free Trade Zone Shenzhen, Guangdong, China Tel: +86-755-33320018 Fax: +86-755-33320008 <a href="http://www.baclcorp.com.cn">www.baclcorp.com.cn</a>	

**Note:** This test report is prepared for the customer shown above and for the device described herein. It may not be duplicated or used in part without prior written consent from Bay Area Compliance Laboratories Corp. This report **must not** be used by the customer to claim product certification, approval, or endorsement by NVLAP or any agency of the Federal Government.

\* This report contain data that are not covered by the NVLAP accreditation and are marked with an asterisk “★” (Rev.2)

Attestation of Test Results		
<b>EUT Information</b>	<b>Company Name</b>	ITALCOM GROUP
	<b>EUT Description</b>	Mobile Phone
	<b>FCC ID</b>	YPVITALCOMTWISTX2
	<b>Model Number</b>	TWISTx2
	<b>Test Date</b>	2011.12.29--2011.12.31
<b>Frequency</b>	<b>Max. SAR Level(s) Measured</b>	<b>Limit(W/Kg)</b>
<b>Cellular Band</b>	0.275 W/kg 1g Head Tissue 1.231 W/kg 1g Body Tissue	<b>1.6</b>
<b>PCS Band</b>	0.801 W/kg 1g Head Tissue 1.355 W/kg 1g Body Tissue	
<b>Applicable Standards</b>	<b>ANSI / IEEE C95.1 : 2005</b> IEEE Standard for Safety Levels with Respect to Human Exposure to Radio Frequency Electromagnetic Fields,3 kHz to 300 GHz.	
	<b>ANSI / IEEE C95.3 : 2002</b> IEEE Recommended Practice for Measurements and Computations of Radio Frequency Electromagnetic Fields With Respect to Human Exposure to Such Fields,100 kHz—300 GHz.	
	<b>OET BULLETIN 65 SUPPLEMENT C</b> Evaluating Compliance with FCC Guidelines for Human Exposure To Radiofrequency Electromagnetic Fields	
	<b>IEEE1528:2003</b> IEEE Recommended Practice for Determining the Peak Spatial-Average Specific Absorption Rate (SAR) in the Human Head from Wireless Communications Devices: Measurement Techniques	
<p><b>Note:</b> This wireless device has been shown to be capable of compliance for localized specific absorption rate (SAR) for General Population/Uncontrolled Exposure limits specified in ANSI/IEEE Standards and has been tested in accordance with the measurement procedures specified in FCC OET 65 Supplement C and IEEE 1528-2003.</p> <p><b>The results and statements contained in this report pertain only to the device(s) evaluated.</b></p>		

## TABLE OF CONTENTS

**DOCUMENT REVISION HISTORY .....4**

**EUT DESCRIPTION.....5**  
 TECHNICAL SPECIFICATION.....5

**REFERENCE, STANDARDS, AND GUIDELINES .....6**  
 SAR LIMITS.....7

**FACILITIES AND ACCREDITATION.....8**

**DESCRIPTION OF TEST SYSTEM.....9**

**EQUIPMENT LIST AND CALIBRATION.....16**  
 EQUIPMENTS LIST & CALIBRATION INFORMATION .....16

**SAR MEASUREMENT SYSTEM VERIFICATION .....17**  
 LIQUID VERIFICATION .....17  
 SYSTEM ACCURACY VERIFICATION.....20  
 SAR SYSTEM VALIDATION DATA.....21

**EUT TEST STRATEGY AND METHODOLOGY.....29**  
 TEST POSITIONS FOR DEVICE OPERATING NEXT TO A PERSON’S EAR .....29  
 CHEEK/TOUCH POSITION .....30  
 EAR/TILT POSITION .....30  
 TEST POSITIONS FOR BODY-WORN AND OTHER CONFIGURATIONS .....31  
 SAR EVALUATION PROCEDURE.....32

**CONDUCTED OUTPUT POWER MEASUREMENT .....33**  
 PROVISION APPLICABLE.....33  
 TEST PROCEDURE.....33  
 TEST RESULTS:.....33

**SAR SIMULTANEOUS TRANSMISSION EVALUATION.....35**

**SAR MEASUREMENT RESULTS.....36**  
 SAR TEST DATA .....36  
 EUT SCAN RESULTS .....38

**APPENDIX A – MEASUREMENT UNCERTAINTY .....70**

**APPENDIX B – PROBE CALIBRATION CERTIFICATES.....71**

**APPENDIX C – DIPOLE CALIBRATION CERTIFICATES.....81**

**APPENDIX D – EUT TEST POSITION PHOTOS.....99**  
 LIQUID DEPTH  $\geq$  15CM .....99  
 BODY-WORN HEADSET-KEYBOARD BACK SETUP PHOTO.....99  
 BODY-WORN HEADSET-KEYBOARD FRONT SETUP PHOTO .....100  
 LEFT HEAD CHEEK-KEYBOARD BACK SETUP PHOTO .....100  
 LEFT HEAD TILT-KEYBOARD BACK SETUP PHOTO .....101  
 LEFT HEAD CHEEK-KEYBOARD FRONT SETUP PHOTO.....101  
 LEFT HEAD TILT-KEYBOARD FRONT SETUP PHOTO .....102  
 RIGHT HEAD CHEEK-KEYBOARD BACK SETUP PHOTO .....102  
 RIGHT HEAD TILT-KEYBOARD BACK SETUP PHOTO.....103  
 RIGHT HEAD CHEEK-KEYBOARD FRONT SETUP PHOTO .....103  
 RIGHT HEAD TILT-KEYBOARD FRONT SETUP PHOTO .....104

**APPENDIX E – EUT PHOTOS.....105**  
 EUT–FRONT SIDE VIEW (KEYBOARD BACK).....105  
 EUT–BACK SIDE VIEW (KEYBOARD FRONT).....105  
 EUT–FRONT SIDE VIEW (KEYBOARD FRONT) .....106  
 EUT–BACK SIDE VIEW (KEYBOARD BACK) .....106  
 EUT – UNCOVERED VIEW.....107  
 EUT-HEADSET VIEW.....107

**APPENDIX F – INFORMATIVE REFERENCES .....108**

## DOCUMENT REVISION HISTORY

---

Revision Number	Report Number	Description of Revision	Date of Revision
0	RSZ111129002-20	Original Report	2012-01-04

## EUT DESCRIPTION

This report has been prepared on behalf of ITALCOM GROUP and their product, FCC ID: YPVITALCOMTWISTX2, Model: TWISTx2 or the EUT (Equipment Under Test) as referred to in the rest of this report. The EUT is a Mobile phone.

### Technical Specification

<b>Product Type</b>	Portable
<b>Exposure Category:</b>	Population / Uncontrolled
<b>Antenna Type(s):</b>	Internal Antenna
<b>Body-Worn Accessories:</b>	Headset
<b>Face-Head Accessories:</b>	None
<b>Multi-slot Class:</b>	Class 12
<b>Operation Mode :</b>	GSM Voice , GPRS Data and Bluetooth
<b>Frequency Band:</b>	Cellular Band : 824-849 MHz(TX) ; 869-894 MHz(RX) PCS Band : 1850-1910 MHz(TX) ; 1930-1990 MHz(RX) Bluetooth: 2400MHz-2483.5MHz
<b>Conducted RF Power:</b>	Cellular Band : 31.70dBm PCS Band : 28.68dBm Bluetooth :2.58dBm
<b>Dimensions (L*W*H):</b>	116mm (L)× 62mm (W)× 14mm (H)
<b>Weight:</b>	98g
<b>Power Source:</b>	3.7VDC/ 1000mAh Rechargeable Battery
<b>Normal Operation:</b>	Head and Body-worn

---

## REFERENCE, STANDARDS, AND GUIDELINES

---

### **FCC:**

The Report and Order requires routine SAR evaluation prior to equipment authorization of portable transmitter devices, including portable telephones. For consumer products, the applicable limit is 1.6 mW/g as recommended by the ANSI/IEEE standard C95.1-1992 [6] for an uncontrolled environment (Paragraph 65). According to the Supplement C of OET Bulletin 65 "Evaluating Compliance with FCC Guide-lines for Human Exposure to Radio frequency Electromagnetic Fields", released on Jun 29, 2001 by the FCC, the device should be evaluated at maximum output power (radiated from the antenna) under "worst-case" conditions for normal or intended use, incorporating normal antenna operating positions, device peak performance frequencies and positions for maximum RF energy coupling.

This report describes the methodology and results of experiments performed on wireless data terminal. The objective was to determine if there is RF radiation and if radiation is found, what is the extent of radiation with respect to safety limits. SAR (Specific Absorption Rate) is the measure of RF exposure determined by the amount of RF energy absorbed by human body (or its parts) – to determine how the RF energy couples to the body or head which is a primary health concern for body worn devices. The limit below which the exposure to RF is considered safe by regulatory bodies in North America is 1.6 mW/g average over 1 gram of tissue mass.

### **CE:**

The order requires routine SAR evaluation prior to equipment authorization of portable transmitter devices, including portable telephones. For consumer products, the applicable limit is 2 mW/g as recommended by EN62209-1 for an uncontrolled environment. According to the Standard, the device should be evaluated at maximum output power (radiated from the antenna) under "worst-case" conditions for normal or intended use, incorporating normal antenna operating positions, device peak performance frequencies and positions for maximum RF energy coupling.

This report describes the methodology and results of experiments performed on wireless data terminal. The objective was to determine if there is RF radiation and if radiation is found, what is the extent of radiation with respect to safety limits. SAR (Specific Absorption Rate) is the measure of RF exposure determined by the amount of RF energy absorbed by human body (or its parts) – to determine how the RF energy couples to the body or head which is a primary health concern for body worn devices. The limit below which the exposure to RF is considered safe by regulatory bodies in Europe is 2 mW/g average over 10 gram of tissue mass.

The test configurations were laid out on a specially designed test fixture to ensure the reproducibility of measurements. Each configuration was scanned for SAR. Analysis of each scan was carried out to characterize the above effects in the device.

**SAR Limits**

FCC Limit (1g Tissue)

EXPOSURE LIMITS	SAR (W/kg)	
	(General Population / Uncontrolled Exposure Environment)	(Occupational / Controlled Exposure Environment)
Spatial Average (averaged over the whole body)	0.08	0.4
Spatial Peak (averaged over any 1 g of tissue)	1.60	8.0
Spatial Peak (hands/wrists/feet/ankles averaged over 10 g)	4.0	20.0

CE Limit (10g Tissue)

EXPOSURE LIMITS	SAR (W/kg)	
	(General Population / Uncontrolled Exposure Environment)	(Occupational / Controlled Exposure Environment)
Spatial Average (averaged over the whole body)	0.08	0.4
Spatial Peak (averaged over any 10 g of tissue)	2.0	10
Spatial Peak (hands/wrists/feet/ankles averaged over 10 g)	4.0	20.0

Population/Uncontrolled Environments are defined as locations where there is the exposure of individual who have no knowledge or control of their exposure.

Occupational/Controlled Environments are defined as locations where there is exposure that may be incurred by people who are aware of the potential for exposure (i.e. as a result of employment or occupation).

General Population/Uncontrolled environments Spatial Peak limit 1.6W/kg (FCC) & 2 W/kg (CE) applied to the EUT.

---

## FACILITIES AND ACCREDITATION

---

The test site used by Bay Area Compliance Laboratories Corp. (Shenzhen) to collect data is located at 6/F, the 3rd Phase of WanLi Industrial Building, Shi Hua Road, Fu Tian Free Trade Zone, Shenzhen, Guangdong, P.R. of China

Additionally, Bay Area Compliance Laboratories Corp. (Shenzhen) is a National Institute of Standards and Technology (NIST) accredited laboratory, under the National Voluntary Laboratory Accredited Program (Lab Code 200707-0).



The current scope of accreditations can be found at <http://ts.nist.gov/Standards/scopes/2007070.htm>



## DESCRIPTION OF TEST SYSTEM

These measurements were performed with ALSAS 10 Universal Integrated SAR Measurement system from APREL Laboratories.

### ALSAS-10U System Description

ALSAS-10-U is fully compliant with the technical and scientific requirements of IEEE 1528, IEC 62209, CENELEC, ARIB, ACA, and the Federal Communications Commission. The system comprises of a six axes articulated robot which utilizes a dedicated controller.

ALSAS-10U uses the latest methodologies. And FDTD modeling to provide a platform which is repeatable with minimum uncertainty.

### Applications

Predefined measurement procedures compliant with the guidelines of CENELEC, IEEE, IEC, FCC, etc are utilized during the assessment for the device. Automatic detection for all SAR maxima are embedded within the core architecture for the system, ensuring that peak locations used for centering the zoom scan are within a 1mm resolution and a 0.05mm repeatable position. System operation range currently available up-to 6 GHz in simulated tissue.

### Area Scans

Area scans are defined prior to the measurement process being executed with a user defined variable spacing between each measurement point (integral) allowing low uncertainty measurements to be conducted. Scans defined for FCC applications utilize a 10mm<sup>2</sup> step integral, with 1mm interpolation used to locate the peak SAR area used for zoom scan assessments.

Where the system identifies multiple SAR peaks (which are within 25% of peak value) the system will provide the user with the option of assessing each peak location individually for zoom scan averaging.

### Zoom Scan (Cube Scan Averaging)

The averaging zoom scan volume utilized in the ALSAS-10U software is in the shape of a cube and the side dimension of a 1 g or 10 g mass is dependent on the density of the liquid representing the simulated tissue. A density of 1000 kg/m<sup>3</sup> is used to represent the head and body tissue density and not the phantom liquid density, in order to be consistent with the definition of the liquid dielectric properties, i.e. the side length of the 1 g cube is 10mm, with the side length of the 10 g cube 21,5mm.

When the cube intersects with the surface of the phantom, it is oriented so that 3 vertices touch the surface of the shell or the center of a face is tangent to the surface. The face of the cube closest to the surface is modified in order to conform to the tangent surface.

The zoom scan integer steps can be user defined so as to reduce uncertainty, but normal practice for typical test applications (including FCC) utilize a physical step of 5x5x8 (8mmx8mmx5mm) providing a volume of 32mm in the X & Y axis, and 35mm in the Z axis.



**ALSAS-10U Interpolation and Extrapolation Uncertainty**

The overall uncertainty for the methodology and algorithms the used during the SAR calculation was evaluated using the data from IEEE 1528 based on the example f3 algorithm:

$$f_3(x, y, z) = A \frac{a^2}{\frac{a^2}{4} + x'^2 + y'^2} \cdot \left( e^{-\frac{2z}{a}} + \frac{a^2}{2(a + 2z)^2} \right)$$

**Isotropic E-Field Probe**

The isotropic E-Field probe has been fully calibrated and assessed for isotropicity, and boundary effect within a controlled environment. Depending on the frequency for which the probe is calibrated the method utilized for calibration will change.

The E-Field probe utilizes a triangular sensor arrangement as detailed in the diagram below:

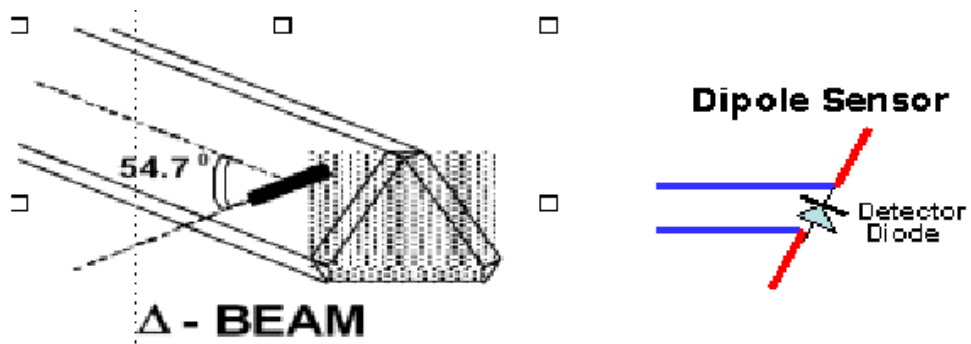

SAR is assessed with a calibrated probe which moves at a default height of 5mm from the center of the diode, which is mounted to the sensor, to the phantom surface (in the Z Axis). The 5mm offset height has been selected so as to minimize any resultant boundary effect due to the probe being in close proximity to the phantom surface.

The following algorithm is an example of the function used by the system for linearization of the output from the probe when measuring complex modulation schemes.

$$V_i = U_i + U_i^2 \cdot \frac{cf}{dcp_i}$$

**Isotropic E-Field Probe Specification**

<b>Calibration Method</b>	Frequency Dependent Below 1 GHz Calibration in air performed in a TEM Cell Above 1 GHz Calibration in air performed in waveguide
<b>Sensitivity</b>	0.70 $\mu\text{V}/(\text{V}/\text{m})^2$ to 0.85 $\mu\text{V}/(\text{V}/\text{m})^2$
<b>Dynamic Range</b>	0.0005 W/kg to 100 W/kg
<b>Isotropic Response</b>	Better than 0.1 dB
<b>Diode Compression Point (DCP)</b>	Calibration for Specific Frequency
<b>Probe Tip Diameter</b>	< 2.9 mm
<b>Sensor Offset</b>	1.56 (+/- 0.02 mm)
<b>Probe Length</b>	289 mm
<b>Video Bandwidth</b>	@ 500 Hz: 1 dB @ 1.02 kHz: 3 dB
<b>Boundary Effect</b>	Less than 2.1% for distance greater than 0.58 mm
<b>Spatial Resolution</b>	The spatial resolution uncertainty is less than 1.5% for 4.9mm diameter probe. The spatial resolution uncertainty is less than 1.0% for 2.5mm diameter probe

**Boundary Detection Unit and Probe Mounting Device**

ALSAS-10U incorporates a boundary detection unit with a sensitivity of 0.05mm for detecting all types of surfaces. The robust design allows for detection during probe tilt (probe normalize) exercises, and utilizes a second stage emergency stop. The signal electronics are fed directly into the robot controller for high accuracy surface detection in lateral and axial detection modes (X, Y, & Z).

The probe is mounted directly onto the Boundary Detection unit for accurate tooling and displacement calculations controlled by the robot kinematics. The probe is connect to an isolated probe interconnect where the output stage of the probe is fed directly into the amplifier stage of the Daq-Paq.

**Daq-Paq (Analog to Digital Electronics)**

ALSAS-10U incorporates a fully calibrated Daq-Paq (analog to digital conversion system) which has a 4 channel input stage, sent via a 2 stage auto-set amplifier module. The input signal is amplified accordingly so as to offer a dynamic range from 5 $\mu\text{V}$  to 800mV. Integration of the fields measured is carried out at board level utilizing a Co-Processor which then sends the measured fields down into the main computational module in digitized form via an RS232 communications port. Probe linearity and duty cycle compensation is carried out within the main Daq-Paq module.

<b>ADC</b>	12 Bit
<b>Amplifier Range</b>	20 mV to 200 mV and 150 mV to 800 mV
<b>Field Integration</b>	Local Co-Processor utilizing proprietary integration algorithms
<b>Number of Input Channels</b>	4 in total 3 dedicated and 1 spare
<b>Communication</b>	Packet data via RS232

**Axis Articulated Robot**

ALSAS-10U utilizes a six axis articulated robot, which is controlled using a Pentium based real-time movement controller. The movement kinematics engine utilizes proprietary (Thermo CRS) interpolation and extrapolation algorithms, which allow full freedom of movement for each of the six joints within the working envelope. Utilization of joint 6 allows for full probe rotation with a tolerance better than 0.05mm around the central axis.



<b>Robot/Controller Manufacturer</b>	Thermo CRS
<b>Number of Axis</b>	Six independently controlled axis
<b>Positioning Repeatability</b>	0.05 mm
<b>Controller Type</b>	Single phase Pentium based C500C
<b>Robot Reach</b>	710 mm
<b>Communication</b>	RS232 and LAN compatible

**ALSAS Universal Workstation**

ALSAS Universal workstation allows for repeatability and fast adaptability. It allows users to do calibration, testing and measurements using different types of phantoms with one set up, which significantly speeds up the measurement process.

**Universal Device Positioner**

The universal device positioner allows complete freedom of movement of the EUT. Developed to hold a EUT in a free-space scenario any additional loading attributable to the material used in the construction of the positioner has been eliminated. Repeatability has been enhanced through the linear scales which form the design used to indicate positioning for any given test scenario in all major axes. A 15° tilt indicator is included for the of aid cheek to tilt movements for head SAR analysis. Overall uncertainty for measurements have been reduced due to the design of the Universal device positioner, which allows positioning of a device in as near to a free-space scenario as possible, and by providing the means for complete repeatability.



**Phantom Types**

The ALSAS-10U allows the integration of multiple phantom types. SAM Phantoms fully compliant with IEEE 1528, Universal Phantom, and Universal Flat.

**APREL SAM Phantoms**

The SAM phantoms developed using the IEEE SAM CAD file. They are fully compliant with the requirements for both IEEE 1528 and FCC Supplement C. Both the left and right SAM phantoms are interchangeable, transparent and include the IEEE 1528 grid with visible NF and MB lines.

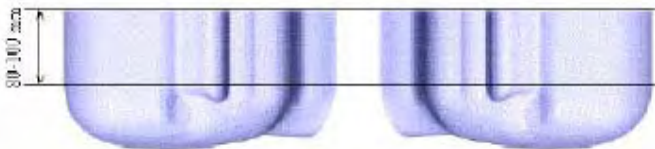

### **APREL Laboratories Universal Phantom**

The Universal Phantom is used on the ALSAS-10U as a system validation phantom. The Universal Phantom has been fully validated both experimentally from 800MHz to 6GHz and numerically using XFDTD numerical software.

The shell thickness is 2mm overall, with a 4mm spacer located at the NF/MB intersection providing an overall thickness of 6mm in line with the requirements of IEEE-1528.

The design allows for fast and accurate measurements, of handsets, by allowing the conservative SAR to be evaluated at on frequency for both left and right head experiments in one measurement.



### Tissue Dielectric Parameters for Head and Body Phantoms

The head tissue dielectric parameters recommended by the IEEE SCC-34/SC-2 in P1528 have been incorporated in the following table. These head parameters are derived from planar layer models simulating the highest expected SAR for the dielectric properties and tissue thickness variations in a human head. Other head and body tissue parameters that have not been specified in P1528 are derived from the tissue dielectric parameters computed from the 4-Cole-Cole equations described in Reference [12] and extrapolated according to the head parameters specified in P1528.

Ingredients (% by weight)	Frequency (MHz)									
	450		835		915		1900		2450	
Tissue Type	Head	Body	Head	Body	Head	Body	Head	Body	Head	Body
Water	38.56	51.16	41.45	52.4	41.05	56.0	54.9	40.4	62.7	73.2
Salt (Nacl)	3.95	1.49	1.45	1.4	1.35	0.76	0.18	0.5	0.5	0.04
Sugar	56.32	46.78	56.0	45.0	56.5	41.76	0.0	58.0	0.0	0.0
HEC	0.98	0.52	1.0	1.0	1.0	1.21	0.0	1.0	0.0	0.0
Bactericide	0.19	0.05	0.1	0.1	0.1	0.27	0.0	0.1	0.0	0.0
Triton x-100	0.0	0.0	0.0	0.0	0.0	0.0	0.0	0.0	36.8	0.0
DGBE	0.0	0.0	0.0	0.0	0.0	0.0	44.92	0.0	0.0	26.7
Dielectric Constant	43.42	58.0	42.54	56.1	42.0	56.8	39.9	54.0	39.8	52.5
Conductivity (s/m)	0.85	0.83	0.91	0.95	1.0	1.07	1.42	1.45	1.88	1.78

### Recommended Tissue Dielectric Parameters for Head and Body

Frequency (MHz)	Head Tissue		Body Tissue	
	$\epsilon_r$	$\sigma$ (S/m)	$\epsilon_r$	$\sigma$ (S/m)
150	52.3	0.76	61.9	0.80
300	45.3	0.87	58.2	0.92
450	43.5	0.87	56.7	0.94
835	41.5	0.90	55.2	0.97
900	41.5	0.97	55.0	1.05
915	41.5	0.98	55.0	1.06
1450	40.5	1.20	54.0	1.30
1610	40.3	1.29	53.8	1.40
1800-2000	40.0	1.40	53.3	1.52
2450	39.2	1.80	52.7	1.95
3000	38.5	2.40	52.0	2.73
5800	35.3	5.27	48.2	6.00

## EQUIPMENT LIST AND CALIBRATION

### Equipments List & Calibration Information

Equipment	Model	Calibration Date	S/N
CRS F3 robot	ALS-F3	N/A	RAF0805352
CRS F3 Software	ALS-F3-SW	N/A	N/A
CRS C500C controller	ALS-C500	N/A	RCF0805379
Probe mounting device & Boundary Detection Sensor System	ALS-PMDPS-3	N/A	120-00270
Universal Work Station	ALS-UWS	N/A	100-00157
Data Acquisition Package	ALS-DAQ-PAQ-3	2011-05-13	110-00212
Miniature E-Field Probe	ALS-E-020	2011-07-14	500-00283
Dipole, 835MHz	ALS-D-835-S-2	2011-08-25	210-00558
Dipole,1900MHz	ALS-D-1900-S-2	2011-08-25	210-00710
Dipole Spacer	ALS-DS-U	N/A	250-00907
R&S, universal Radio Communication Tester	CMU200	2011-06-28	1100.0008.02
Device holder/Positioner	ALS-H-E-SET-2	N/A	170-00510
Left ear SAM phantom	ALS-P-SAM-L	N/A	130-00311
Right ear SAM phantom	ALS-P-SAM-R	N/A	140-00359
UniPhantom	ALS-P-UP-1	N/A	150-00413
Simulated Tissue 835 MHz Head	ALS-T-835-1-H	Each Time	270-01002
Simulated Tissue 835 MHz Body	ALS-T-835-1-B	Each Time	270-02101
Simulated Tissue 1900 MHz Head	ALS-T-1900-1-H	Each Time	295-01103
Simulated Tissue 1900 MHz Body	ALS-T-1900-1-B	Each Time	295-02102
Power Amplifier	5S1G4	N/A	71377
Synthesized Sweeper	HP 8341B	2011-04-11	2624A00116
Spectrum Analyzer	FSEM30	2011-07-05	849720/019



# SAR MEASUREMENT SYSTEM VERIFICATION

## Liquid Verification

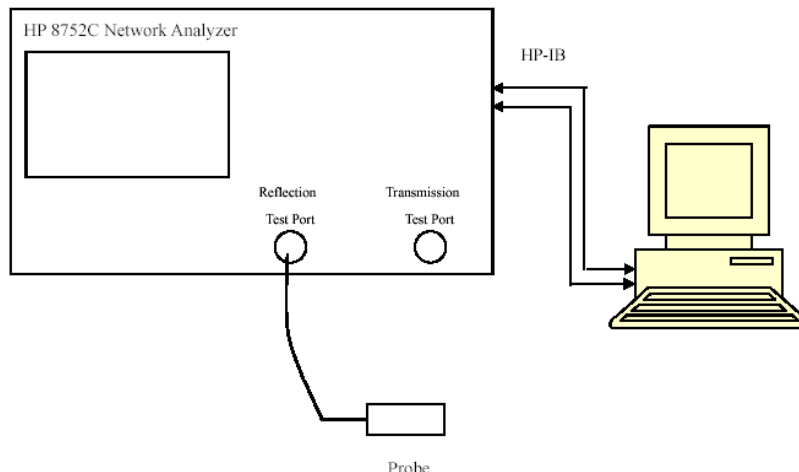

Liquid Verification Setup Block Diagram

## Liquid Verification Results

Frequency (MHz)	Liquid Type	Liquid Parameter		Result
		$\epsilon_r$	$\sigma$ (S/m)	
835	Head	42.62	0.90	In Tolerance
835	Body	55.44	0.99	In Tolerance
1900	Head	40.12	1.41	In Tolerance
1900	Body	54.01	1.49	In Tolerance

\*Liquid Verification was performed on 2011-12-29

Please refer to the following tables.

850 MHz Head				1900 MHz Head		
Frequency (MHz)	e'	e''		Frequency (MHz)	e'	e''
824.0	42.652279	20.113259		1850.0	40.349201	13.809692
824.5	42.664336	20.090626		1851.2	40.327305	13.771466
825.0	42.623371	20.088402		1852.4	40.349367	13.758672
825.5	42.555718	20.067071		1853.6	40.301530	13.733701
826.0	42.483277	20.047175		1854.8	40.300427	13.763388
826.5	42.550369	20.030418		1856.0	40.302882	13.744238
827.0	42.584953	20.049485		1857.2	40.284475	13.741306
827.5	42.631454	20.054430		1858.4	40.272758	13.734172
828.0	42.588018	20.042442		1859.6	40.268622	13.744035
828.5	42.558678	20.079576		1860.8	40.237630	13.696296
829.0	42.605127	20.084417		1862.0	40.270332	13.720239
829.5	42.613726	20.142478		1863.2	40.259302	13.743782
830.0	42.633460	20.091218		1864.4	40.268944	13.701549
830.5	42.591650	20.047093		1865.6	40.215270	13.662084
831.0	42.573785	20.123154		1866.8	40.200967	13.675249
831.5	42.646601	20.109628		1868.0	40.227359	13.659711
832.0	42.589524	20.048917		1869.2	40.227059	13.695077
832.5	42.578617	20.038363		1870.4	40.221858	13.693250
833.0	42.563607	20.050113		1871.6	40.228571	13.680814
833.5	42.579311	20.095143		1872.8	40.222508	13.716683
834.0	42.621161	20.048306		1874.0	40.221079	13.740314
834.5	42.589613	20.075322		1875.2	40.235680	13.701209
835.0	42.618490	20.111100		1876.4	40.238981	13.712588
835.5	42.612384	20.062399		1877.6	40.179875	13.757281
836.0	42.562117	20.042326		1878.8	40.222039	13.747045
836.5	42.597238	20.081411		1880.0	40.120534	13.774007
837.0	42.566399	20.055770		1881.2	40.181428	13.778068
837.5	42.577995	20.085877		1882.4	40.207990	13.786984
838.0	42.596853	20.051058		1883.6	40.187760	13.785476
838.5	42.569732	20.055801		1884.8	40.225924	13.827161
839.0	42.581355	20.085793		1886.0	40.191285	13.856446
839.5	42.567120	20.045027		1887.2	40.223269	13.849467
840.0	42.553733	20.024935		1888.4	40.198108	13.810968
840.5	42.565751	20.002661		1889.6	40.168618	13.843146
841.0	42.560474	20.063522		1890.8	40.130908	13.818825
841.5	42.583456	20.043209		1892.0	40.187855	13.826772
842.0	42.568725	20.018392		1893.2	40.165399	13.836048
842.5	42.587457	19.983784		1894.4	40.145704	13.815746
843.0	42.567704	20.012397		1895.6	40.136074	13.835291
843.5	42.512079	19.989350		1896.8	40.122006	13.823776
844.0	42.525240	20.023773		1898.0	40.130702	13.828541
844.5	42.498624	20.028482		1899.2	40.103922	13.806731
845.0	42.460861	19.995131		1900.4	40.117002	13.808678
845.5	42.491382	19.983028		1901.6	40.141260	13.828109
846.0	42.429753	20.008455		1902.8	40.141568	13.819772
846.5	42.486968	19.947207		1904.0	40.103326	13.799233
847.0	42.459528	19.983173		1905.2	40.137225	13.843143
847.5	42.434246	19.956691		1906.4	40.129768	13.827495
848.0	42.439134	19.962464		1907.6	40.155773	13.830303
848.5	42.430740	19.992719		1908.8	40.137016	13.849611
849.0	42.451724	19.983399		1910.0	40.161155	13.878174

850 MHz Body				1900 MHz Body		
Frequency (MHz)	e'	e''		Frequency (MHz)	e'	e''
824.0	55.457892	21.407274		1850.0	53.884644	14.367602
824.5	55.431598	21.415891		1851.2	53.871222	14.389579
825.0	55.420111	21.419013		1852.4	53.895499	14.370219
825.5	55.356494	21.447084		1853.6	53.845060	14.313437
826.0	55.341064	21.379125		1854.8	53.862121	14.356578
826.5	55.428758	21.423475		1856.0	53.847124	14.372549
827.0	55.451663	21.413793		1857.2	53.857144	14.324893
827.5	55.464768	21.407714		1858.4	53.852229	14.376689
828.0	55.410787	21.371048		1859.6	53.854593	14.362056
828.5	55.405601	21.329776		1860.8	53.887981	14.356834
829.0	55.424840	21.267981		1862.0	53.875548	14.325756
829.5	55.439204	21.294726		1863.2	53.877509	14.360087
830.0	55.485172	21.287339		1864.4	53.852516	14.344059
830.5	55.409599	21.281243		1865.6	53.900560	14.359038
831.0	55.370580	21.283588		1866.8	53.869669	14.344736
831.5	55.426346	21.361049		1868.0	53.852020	14.340770
832.0	55.388419	21.219182		1869.2	53.922014	14.388044
832.5	55.353273	21.231233		1870.4	53.893741	14.401323
833.0	55.393117	21.237091		1871.6	53.919455	14.391542
833.5	55.472347	21.288706		1872.8	53.932223	14.408591
834.0	55.420024	21.196956		1874.0	53.922856	14.438287
834.5	55.464108	21.228579		1875.2	53.944845	14.424363
835.0	55.435773	21.243583		1876.4	53.948986	14.268114
835.5	55.467506	21.213723		1877.6	53.946681	14.272626
836.0	55.406811	21.230039		1878.8	53.986687	14.294618
836.5	55.412464	21.276045		1880.0	54.011086	14.270951
837.0	55.426595	21.214449		1881.2	53.981260	14.326996
837.5	55.513741	21.229257		1882.4	53.974225	14.305777
838.0	55.491584	21.230918		1883.6	53.991411	14.314895
838.5	55.452183	21.244632		1884.8	54.031980	14.324999
839.0	55.406264	21.255374		1886.0	54.018873	14.358259
839.5	55.467219	21.230652		1887.2	54.033252	14.339837
840.0	55.432469	21.198916		1888.4	54.010126	14.333564
840.5	55.440221	21.178210		1889.6	54.007243	14.357330
841.0	55.414693	21.170332		1890.8	53.992520	14.313383
841.5	55.461915	21.167181		1892.0	54.025517	14.276339
842.0	55.416032	21.205332		1893.2	54.029082	14.329428
842.5	55.465373	21.179474		1894.4	53.997418	14.293601
843.0	55.441061	21.160312		1895.6	53.986910	14.241753
843.5	55.419052	21.189189		1896.8	53.967017	14.255051
844.0	55.396652	21.174744		1898.0	53.966152	14.280724
844.5	55.392593	21.207529		1899.2	53.999014	14.237634
845.0	55.378192	21.157476		1900.4	53.971826	14.242884
845.5	55.397292	21.137872		1901.6	53.987701	14.237995
846.0	55.325885	21.164247		1902.8	53.984347	14.228559
846.5	55.397233	21.167642		1904.0	53.979614	14.257878
847.0	55.424117	21.112539		1905.2	53.965568	14.190861
847.5	55.412934	21.126343		1906.4	53.941043	14.178681
848.0	55.362673	21.122953		1907.6	53.964838	14.150133
848.5	55.360941	21.133043		1908.8	53.931781	14.060991
849.0	55.402371	21.115478		1910.0	53.945150	14.073367

### System Accuracy Verification

Prior to the assessment, the system validation kit was used to test whether the system was operating within its specifications of  $\pm 10\%$ . The validation results are tabulated below. And also the corresponding SAR plot is attached as well in the SAR plots files.

### System Verification Setup Block Diagram

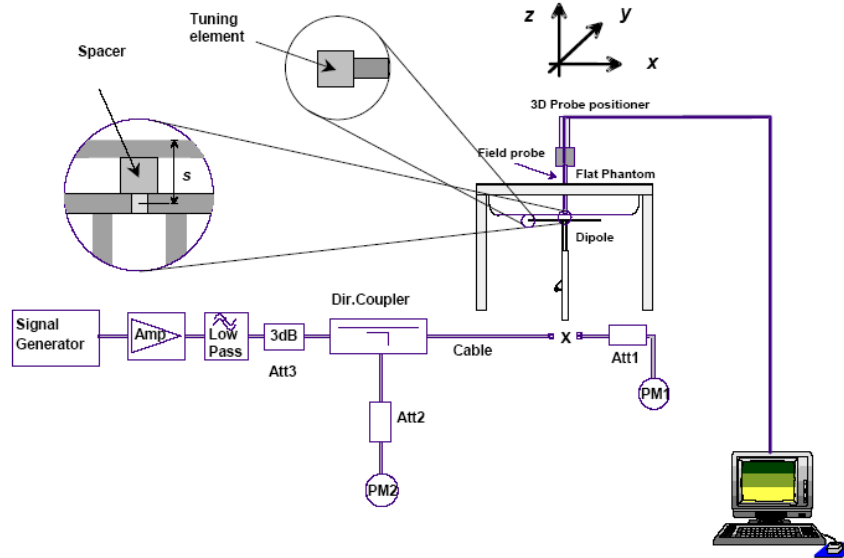

### System Accuracy Check Results

Date	Frequency (MHz)	Liquid Type	Measured SAR (W/Kg)	Target Value (W/Kg)	Delta (%)	Tolerance (%)
2011-12-29	835	Head	1g 9.645	9.590	0.574	$\pm 10$
		Body	1g 9.562	9.684	-1.260	$\pm 10$
	1900	Head	1g 40.364	39.648	1.806	$\pm 10$
		Body	1g 38.842	39.769	-2.331	$\pm 10$

\*All SAR values are normalized to 1 Watt forward power.

**SAR SYSTEM VALIDATION DATA****Test Laboratory: Bay Area Compliance Lab Corp. (Shenzhen)****System Performance Check 835MHz Head Liquid****Dipole 835 MHz; Type: ALS-D-835-S-2; S/N: 180-00558**

## Product Data

Device Name : Dipole 835 MHz  
Serial No. : 180-00558  
Type : Dipole  
Model : ALS-D-835-S-2  
Frequency : 835.00 MHz  
Max. Transmit Pwr : 1 W  
Drift Time : 3 min(s)  
Power Drift-Start : 10.021 W/kg  
Power Drift-Finish : 9.885 W/kg  
Power Drift (%) : -1.501

## Phantom Data

Name : APREL-Uni  
Type : Uni-Phantom  
Size (mm) : 280 x 280 x 200  
Serial No. : System Default  
Location : Center  
Description : Default  
Phantom Data

## Tissue Data

Type : HEAD  
Serial No. : 270-01002  
Frequency : 835.00 MHz  
Last Calib. Date : 29-Dec-2011  
Temperature : 20.00 °C  
Ambient Temp. : 21.00 °C  
Humidity : 56.00 RH%  
Epsilon : 42.62 F/m  
Sigma : 0.90 S/m  
Density : 1000.00 kg/cu. m

## Probe Data

Name : E-Field  
Model : E-020  
Type : E-Field Triangle  
Serial No. : 500-00283  
Last Calib. Date : 14-Jul-2011  
Frequency : 835.00 MHz  
Duty Cycle Factor : 1  
Conversion Factor : 6.6  
Probe Sensitivity : 1.20 1.20 1.20  $\mu\text{V}/(\text{V}/\text{m})^2$   
Compression Point : 95.00 mV  
Offset : 1.56 mm

## Measurement Data

Crest Factor : 1  
Scan Type : Complete  
Tissue Temp. : 21.00 °C  
Ambient Temp. : 21.00 °C  
Area Scan : 7x9x1 : Measurement x=10mm, y=10mm, z=4mm  
Zoom Scan : 7x7x7 : Measurement x=5mm, y=5mm, z=5mm

1 gram SAR value : 9.645 W/kg  
10 gram SAR value : 6.124 W/kg  
Area Scan Peak SAR : 9.752 W/kg  
Zoom Scan Peak SAR : 15.265 W/kg

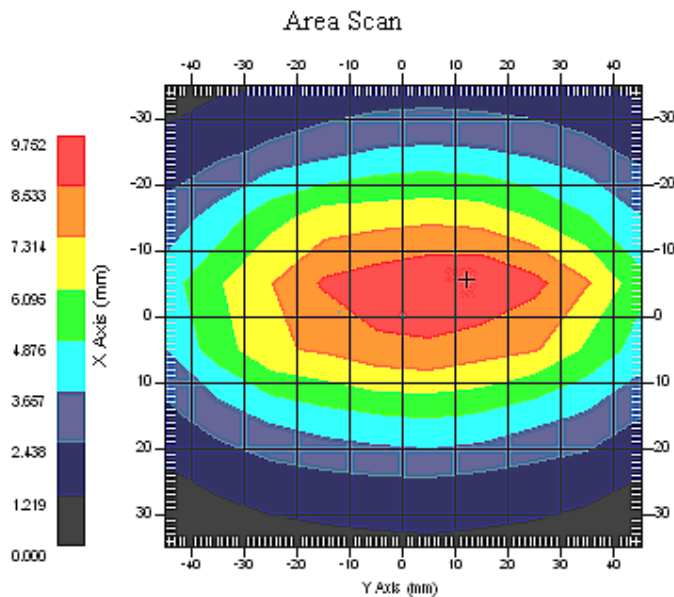

**835 MHz System Validation with Head Tissue**

**Test Laboratory: Bay Area Compliance Lab Corp. (Shenzhen)****System Performance Check 835MHz Body Liquid****Dipole 835 MHz; Type: ALS-D-835-S-2; S/N: 180-00558**

## Product Data

Device Name : Dipole 835 MHz  
Serial No. : 180-00558  
Type : Dipole  
Model : ALS-D-835-S-2  
Frequency : 835.00 MHz  
Max. Transmit Pwr : 1 W  
Drift Time : 3 min(s)  
Power Drift-Start : 10.341 W/kg  
Power Drift-Finish : 9.927 W/kg  
Power Drift (%) : -3.579

## Phantom Data

Name : APREL-Uni  
Type : Uni-Phantom  
Size (mm) : 280 x 280 x 200  
Serial No. : System Default  
Location : Center  
Description : Default  
Phantom Data

## Tissue Data

Type : Body  
Serial No. : 270-02101  
Frequency : 835.00 MHz  
Last Calib. Date : 29-Dec-2011  
Temperature : 20.00 °C  
Ambient Temp. : 21.00 °C  
Humidity : 56.00 RH%  
Epsilon : 55.44 F/m  
Sigma : 0.99 S/m  
Density : 1000.00 kg/cu. m

## Probe Data

Name : E-Field  
Model : E-020  
Type : E-Field Triangle  
Serial No. : 500-00283  
Last Calib. Date : 14-Jul-2011  
Frequency : 835.00 MHz  
Duty Cycle Factor : 1  
Conversion Factor : 6.6  
Probe Sensitivity : 1.20 1.20 1.20  $\mu\text{V}/(\text{V}/\text{m})^2$   
Compression Point : 95.00 mV  
Offset : 1.56 mm

## Measurement Data

Crest Factor : 1  
Scan Type : Complete  
Tissue Temp. : 21.00 °C  
Ambient Temp. : 21.00 °C  
Area Scan : 7x9x1 : Measurement x=10mm, y=10mm, z=4mm  
Zoom Scan : 7x7x7 : Measurement x=5mm, y=5mm, z=5mm

1 gram SAR value : 9.562 W/kg  
10 gram SAR value : 6.120 W/kg  
Area Scan Peak SAR : 9.485 W/kg  
Zoom Scan Peak SAR : 15.012 W/kg

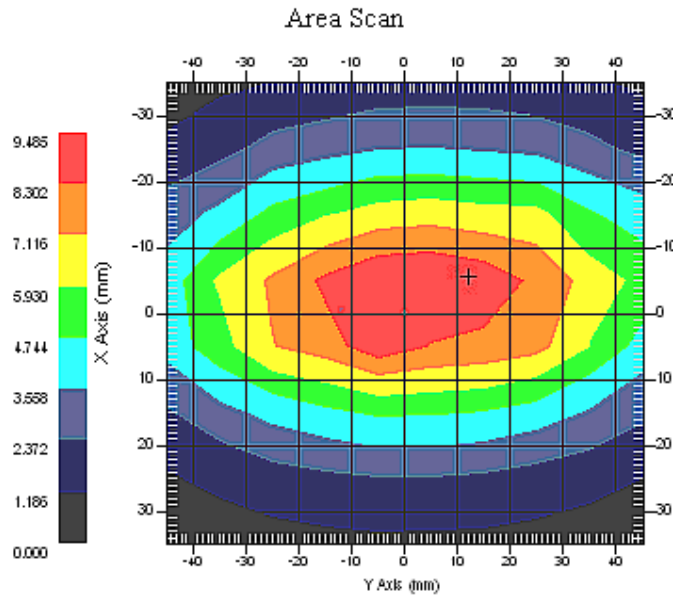

**835 MHz System Validation with Body Tissue**



**Test Laboratory: Bay Area Compliance Lab Corp. (Shenzhen)****System Performance Check 1900 Head****Dipole 1900 MHz; Type: ALS-D-1900-S-2; S/N: 210-00710**

## Product Data

Device Name : Dipole 1900MHz  
Serial No. : 210-00710  
Type : Dipole  
Model : ALS-D-1900-S-2  
Frequency : 1900.00 MHz  
Max. Transmit Pwr : 1 W  
Drift Time : 3 min(s)  
Power Drift-Start : 40.489 W/kg  
Power Drift-Finish : 41.316 W/kg  
Power Drift (%) : 1.920

## Phantom Data

Name : APREL-Uni  
Type : Uni-Phantom  
Size (mm) : 280 x 280 x 200  
Serial No. : System Default  
Location : Center  
Description : Default

## Tissue Data

Type : HEAD  
Serial No. : 295-01103  
Frequency : 1900.00 MHz  
Last Calib. Date : 29-Dec-2011  
Temperature : 20.00 °C  
Ambient Temp. : 21.00 °C  
Humidity : 56.00 RH%  
Epsilon : 40.12 F/m  
Sigma : 1.41 S/m  
Density : 1000.00 kg/cu. M

## Probe Data

Name : E-Field  
Model : E-020  
Type : E-Field Triangle  
Serial No. : 500-00283  
Last Calib. Date : 14-Jul-2011  
Frequency : 1900.00 MHz  
Duty Cycle Factor : 1  
Conversion Factor : 5.20  
Probe Sensitivity : 1.20 1.20 1.20  $\mu\text{V}/(\text{V}/\text{m})^2$   
Compression Point : 95.00 mV  
Offset : 1.56 mm

## Measurement Data

Crest Factor : 1  
Scan Type : Complete  
Tissue Temp. : 20.00 °C  
Ambient Temp. : 20.00 °C  
Area Scan : 7x9x1 : Measurement x=10mm, y=10mm, z=4mm  
Zoom Scan : 7x7x7 : Measurement x=5mm, y=5mm, z=5mm

1 gram SAR value : 40.364 W/kg  
10 gram SAR value : 20.512 W/kg  
Area Scan Peak SAR : 41.256 W/kg  
Zoom Scan Peak SAR : 72.841 W/kg

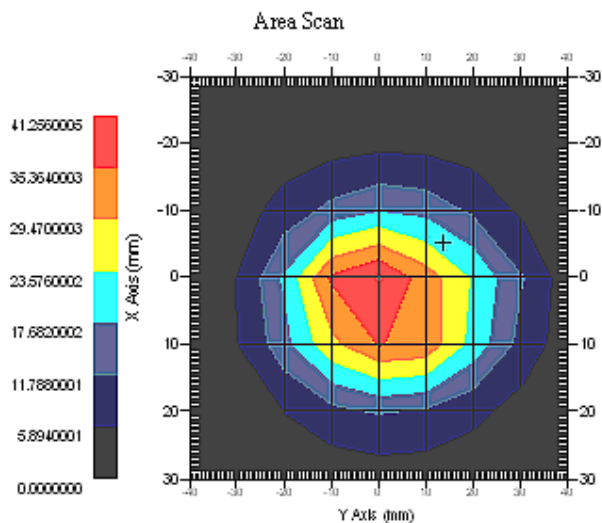

**1900 MHz System Validation with Head Tissue**

**Test Laboratory: Bay Area Compliance Lab Corp. (Shenzhen)****System Performance Check 1900 Body****Dipole 1900 MHz; Type: ALS-D-1900-S-2; S/N: 210-00710**

## Product Data

Device Name : Dipole 1900MHz  
Serial No. : 210-00710  
Type : Dipole  
Model : ALS-D-1900-S-2  
Frequency : 1900.00 MHz  
Max. Transmit Pwr : 1 W  
Drift Time : 3 min(s)  
Power Drift-Start : 40.755 W/kg  
Power Drift-Finish : 41.887 W/kg  
Power Drift (%) : 0.592

## Phantom Data

Name : APREL-Uni  
Type : Uni-Phantom  
Size (mm) : 280 x 280 x 200  
Serial No. : System Default  
Location : Center  
Description : Default

## Tissue Data

Type : Body  
Serial No. : 295-02102  
Frequency : 1900.00 MHz  
Last Calib. Date : 29-Dec -2011  
Temperature : 20.00 °C  
Ambient Temp. : 21.00 °C  
Humidity : 56.00 RH%  
Epsilon : 54.01 F/m  
Sigma : 1.49 S/m  
Density : 1000.00 kg/cu. m

## Probe Data

Name : E-Field  
Model : E-020  
Type : E-Field Triangle  
Serial No. : 500-00283  
Last Calib. Date : 14-Jul-2011  
Frequency : 1900.00 MHz  
Duty Cycle Factor : 1  
Conversion Factor : 5.0  
Probe Sensitivity : 1.20 1.20 1.20  $\mu\text{V}/(\text{V}/\text{m})^2$   
Compression Point : 95.00 mV  
Offset : 1.56 mm

## Measurement Data

Crest Factor : 1  
Scan Type : Complete  
Tissue Temp. : 20.00 °C  
Ambient Temp. : 21.00 °C  
Area Scan : 7x9x1 : Measurement x=10mm, y=10mm, z=4mm  
Zoom Scan : 7x7x7 : Measurement x=5mm, y=5mm, z=5mm

1 gram SAR value : 38.842 W/kg  
10 gram SAR value : 19.564 W/kg  
Area Scan Peak SAR : 40.412 W/kg  
Zoom Scan Peak SAR : 70.155 W/kg

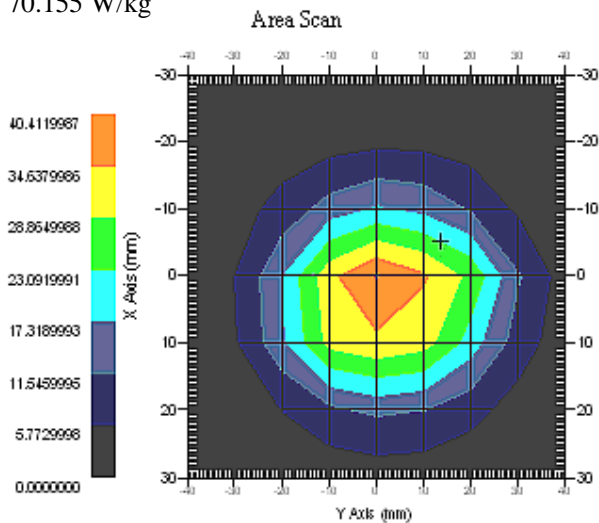

**1900 MHz System Validation with Body Tissue**

## EUT TEST STRATEGY AND METHODOLOGY

### Test Positions for Device Operating Next to a Person’s Ear

This category includes most wireless handsets with fixed, retractable or internal antennas located toward the top half of the device, with or without a foldout, sliding or similar keypad cover. The handset should have its earpiece located within the upper ¼ of the device, either along the centerline or off-centered, as perceived by its users. This type of handset should be positioned in a normal operating position with the “test device reference point” located along the “vertical centerline” on the front of the device aligned to the “ear reference point”. The “test device reference point” should be located at the same level as the center of the earpiece region. The “vertical centerline” should bisect the front surface of the handset at its top and bottom edges. A “ear reference point” is located on the outer surface of the head phantom on each ear spacer. It is located 1.5 cm above the center of the ear canal entrance in the “phantom reference plane” defined by the three lines joining the center of each “ear reference point” (left and right) and the tip of the mouth.

A handset should be initially positioned with the earpiece region pressed against the ear spacer of a head phantom. For the SCC-34/SC-2 head phantom, the device should be positioned parallel to the “N-F” line defined along the base of the ear spacer that contains the “ear reference point”. For interim head phantoms, the device should be positioned parallel to the cheek for maximum RF energy coupling. The “test device reference point” is aligned to the “ear reference point” on the head phantom and the “vertical centerline” is aligned to the “phantom reference plane”. This is called the “initial ear position”. While maintaining these three alignments, the body of the handset is gradually adjusted to each of the following positions for evaluating SAR:

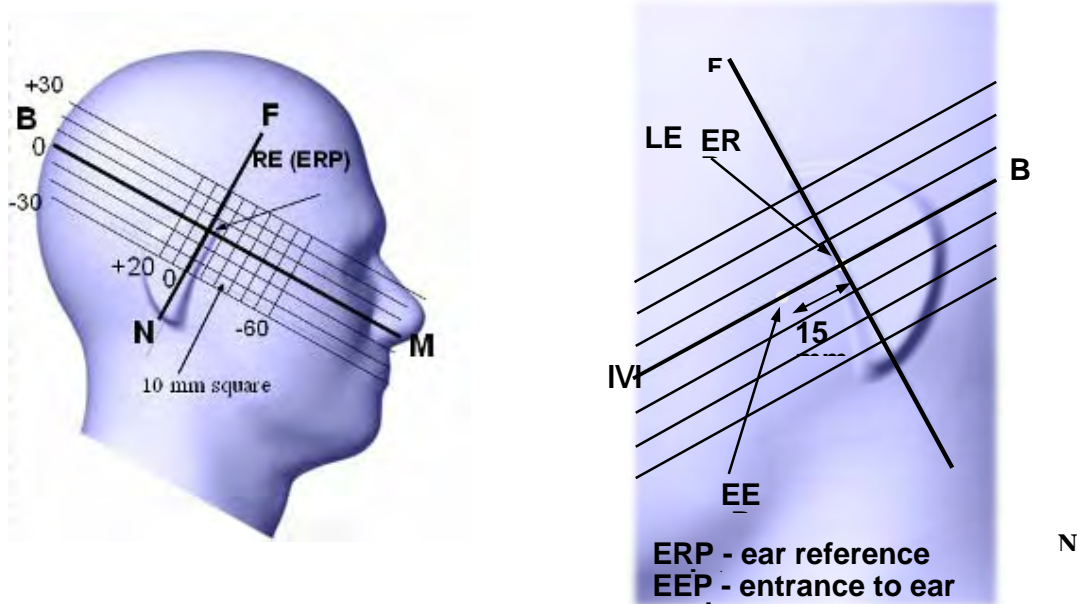

## Cheek/Touch Position

The device is brought toward the mouth of the head phantom by pivoting against the “ear reference point” or along the “N-F” line for the SCC-34/SC-2 head phantom.

This test position is established:

- When any point on the display, keypad or mouthpiece portions of the handset is in contact with the phantom.
- (or) When any portion of a foldout, sliding or similar keypad cover opened to its intended self-adjusting normal use position is in contact with the cheek or mouth of the phantom.

For existing head phantoms – when the handset loses contact with the phantom at the pivoting point, rotation should continue until the device touches the cheek of the phantom or breaks its last contact from the ear spacer.

### Cheek /Touch Position

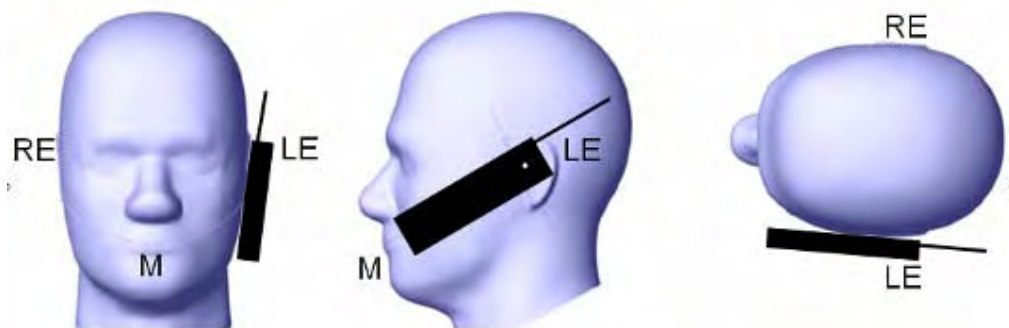

## Ear/Tilt Position

With the handset aligned in the “Cheek/Touch Position”:

1) If the earpiece of the handset is not in full contact with the phantom’s ear spacer (in the “Cheek/Touch position”) and the peak SAR location for the “Cheek/Touch” position is located at the ear spacer region or corresponds to the earpiece region of the handset, the device should be returned to the “initial ear position” by rotating it away from the mouth until the earpiece is in full contact with the ear spacer.

2) (otherwise) The handset should be moved (translated) away from the cheek perpendicular to the line passes through both “ear reference points” (note: one of these ear reference points may not physically exist on a split head model) for approximate 2-3 cm. While it is in this position, the device handset is tilted away from the mouth with respect to the “test device reference point” until the inside angle between the vertical centerline on the front surface of the phone and the horizontal line passing through the ear reference point is by 15 80°. After the tilt, it is then moved (translated) back toward the head perpendicular to the line passes through both “ear reference points” until the device touches the phantom or the ear spacer. If the antenna touches the head first, the positioning process should be repeated with a tilt angle less than 15° so that the device and its antenna would touch the phantom simultaneously. This test position may require a device holder or positioner to achieve the translation and tilting with acceptable positioning repeatability.

If a device is also designed to transmit with its keypad cover closed for operating in the head position, such positions should also be considered in the SAR evaluation. The device should be tested on the left and right side of the head phantom in the “Cheek/Touch” and “Ear/Tilt” positions. When applicable, each configuration should be tested with the antenna in its fully extended and fully retracted positions. These test configurations should be tested at the high, middle and low frequency channels of each operating mode; for example, AMPS, CDMA, and TDMA. If the SAR measured at the middle channel for each test configuration (left, right, Cheek/Touch, Tile/Ear, extended and retracted) is at least 2.0 dB lower than the SAR limit, testing at the high and low channels is optional for such test configuration(s). If the transmission band of the test device is less than 10 MHz, testing at the high and low frequency channels is optional.

### **Ear /Tilt 15° Position**

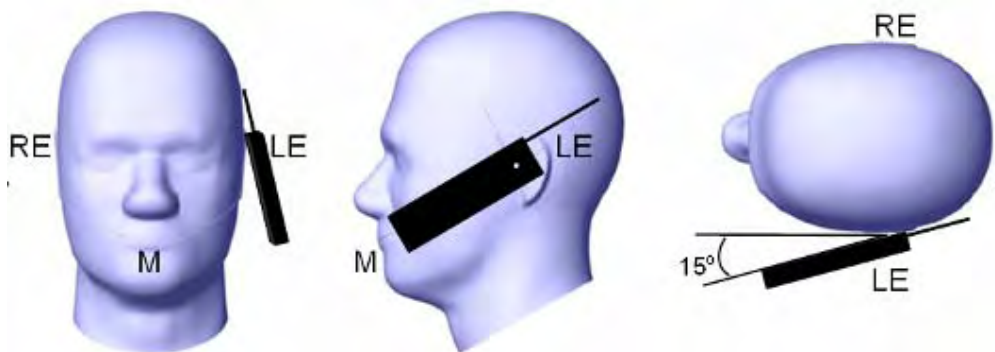

### **Test positions for body-worn and other configurations**

Body-worn operating configurations should be tested with the belt-clips and holsters attached to the device and positioned against a flat phantom in normal use configurations. Devices with a headset output should be tested with a headset connected to the device. When multiple accessories that do not contain metallic components are supplied with the device, the device may be tested with only the accessory that dictates the closest spacing to the body. When multiple accessories that contain metallic components are supplied with the device, the device must be tested with each accessory that contains a unique metallic component. If multiple accessories share an identical metallic component (e.g., the same metallic belt-clip used with different holsters with no other metallic components), only the accessory that dictates the closest spacing to the body must be tested.

Body-worn accessories may not always be supplied or available as options for some devices that are intended to be authorized for body-worn use. A separation distance of 1.5 cm between the back of the device and a flat phantom is recommended for testing body-worn SAR compliance under such circumstances. Other separation distances may be used, but they should not exceed 2.5 cm. In these cases, the device may use body-worn accessories that provide a separation distance greater than that tested for the device provided however that the accessory contains no metallic components.

## SAR Evaluation Procedure

The evaluation was performed with the following procedure:

Step 1: Measurement of the SAR value at a fixed location above the ear point or central position was used as a reference value for assessing the power drop. The SAR at this point is measured at the start of the test and then again at the end of the testing.

Step 2: The SAR distribution at the exposed side of the head was measured at a distance of 4 mm from the inner surface of the shell. The area covered the entire dimension of the head or EUT and the horizontal grid spacing was 10 mm x 10 mm. Based on these data, the area of the maximum absorption was determined by spline interpolation. The first Area Scan covers the entire dimension of the EUT to ensure that the hotspot was correctly identified.

Step 3: Around this point, a volume of 35 mm x 35 mm x 35 mm was assessed by measuring 7x 7 x 7 points. On the basis of this data set, the spatial peak SAR value was evaluated under the following procedure:

- 1) The data at the surface were extrapolated, since the center of the dipoles is 1.2 mm away from the tip of the probe and the distance between the surface and the lowest measuring point is 1.3 mm. The extrapolation was based on a least square algorithm. A polynomial of the fourth order was calculated through the points in z-axes. This polynomial was then used to evaluate the points between the surface and the probe tip.
- 2) The maximum interpolated value was searched with a straightforward algorithm. Around this maximum the SAR values averaged over the spatial volumes (1 g or 10 g) were computed by the 3D-Spline interpolation algorithm. The 3D-Spline is composed of three one dimensional splines with the "Not a knot"-condition (in x, y and z-directions). The volume was integrated with the trapezoidal-algorithm. One thousand points (10 x 10 x 10) were interpolated to calculate the averages.

All neighboring volumes were evaluated until no neighboring volume with a higher average value was found.

Step 4: Re-measurement of the SAR value at the same location as in Step 1. If the value changed by more than 5%, the evaluation was repeated.



## CONDUCTED OUTPUT POWER MEASUREMENT

### Provision Applicable

The measured peak output power should be greater and within 5% than EMI measurement.

### Test Procedure

The RF output of the transmitter was connected to the input of the spectrum analyzer through sufficient attenuation.

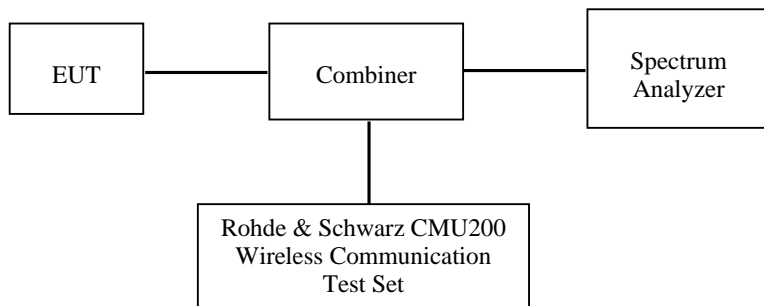

### Test Results:

#### GSM

Band	Channel No.	Frequency (MHz)	Conducted Output Power		
			GSM (dBm)	GSM (W)	FCC Limit (dBm)
Cellular	128	824.2	31.67	1.469	38.4
	190	836.6	31.67	1.469	38.4
	251	848.8	31.70	1.479	38.4
PCS	512	1850.2	28.63	0.729	33
	661	1880.0	28.68	0.738	33
	810	1909.8	28.49	0.706	33

#### Note:

The output power is measured with CS1 with power level 5 (850 MHz band) and 0 (1900 MHz band).

**GPRS**

Mode	Channel No.	Frequency (MHz)	RF Output Power (dBm)			
			1 slot	2 slot	3 slots	4 slots
Cellular	128	824.2	31.63	31.15	29.73	28.74
	190	836.6	31.64	31.17	29.75	28.69
	251	848.8	31.67	31.18	29.75	28.72
PCS	512	1850.2	28.60	28.28	26.99	25.83
	661	1880.0	28.68	28.32	27.03	25.93
	810	1909.8	28.47	28.13	26.84	25.69

For SAR, the time based average power is relevant, the difference in between depends on the duty cycle of the TDMA signal.

Number of Time slot	1	2	3	4
Duty Cycle	1:8	2:8	3:8	4:8
Time based Ave. power compared to slotted Ave. power	-9 dB	-6 dB	-4.25 dB	-3 dB
Crest Factor	8	4	2.66	2

**The time based average power**

Mode	Channel No	Frequency (MHz)	Time based average Power (dBm)			
			1 slot	2 slot	3 slots	4 slots
Cellular	128	824.2	22.63	25.15	25.48	25.74
	190	836.6	22.64	25.17	25.50	25.69
	251	848.8	22.67	25.18	25.50	25.72
PCS	512	1850.2	19.60	22.28	22.74	22.83
	661	1880.0	19.68	22.32	22.78	22.93
	810	1909.8	19.47	22.13	22.59	22.69

**Note:**

The maximum RF output power is in 4 slots GPRS mode, and the body SAR testing is under this mode and the maximum power level.

## SAR SIMULTANEOUS TRANSMISSION EVALUATION

### KDB648474 SIMULTANEOUS TRANSMISSION CONSIDERATION

Stand-alone and simultaneous SAR evaluation for a cell phone with multiple transmitters is base on the antennas distance of each radio.

**BT and GSM Antenna Location:**

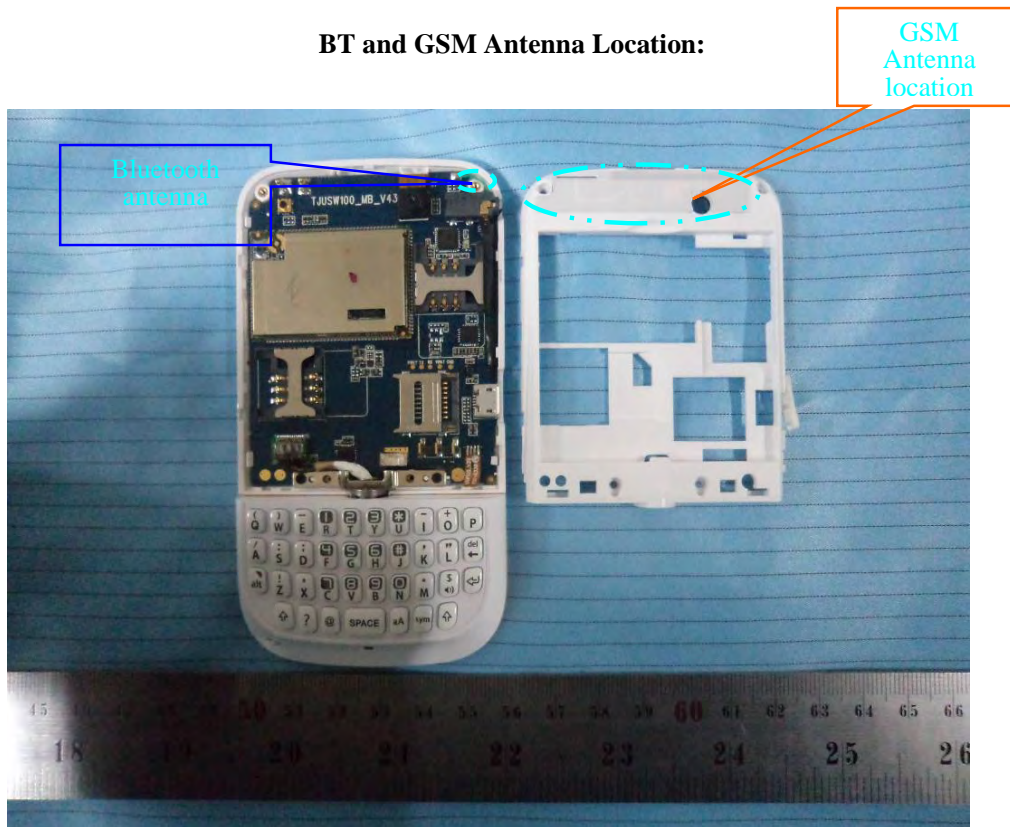

### CONCLUSION:

Individual transmitter	Stand-alone SAR	Simultaneous SAR
Bluetooth	Not required	Not required
GSM	Required	Simultaneous SAR of Bluetooth and GSM is not required

**Note:**

- 1) GSM can transmit simultaneously with Bluetooth.
- 2) The distance between BT and GSM antenna is 3mm. The max output power of Bluetooth antenna is  $[2.58\text{dBm} + (-2\text{dBi}) = 0.58\text{dBm}]$   $1.143\text{mW} < P_{\text{Ref}} (12\text{mW})$ . According to KDB648474, stand-alone SAR is not required for BT antenna and simultaneous SAR evaluation is not required for Bluetooth and GSM antennas.

## SAR MEASUREMENT RESULTS

This page summarizes the results of the performed dosimetric evaluation.

### SAR Test Data

#### Environmental Conditions

<b>Temperature:</b>	21° C
<b>Relative Humidity:</b>	50%
<b>ATM Pressure:</b>	1002 mbar

\* Testing was performed by Sandy Wang on 2011-12-29---2011-12-31.

#### Cellular Band:

EUT Position			Frequency (MHz)		Test Mode	Antenna Type	Liquid Type	FCC 1g SAR (W/Kg)	
			Channel	MHz				Measurement	Limit
Left Head	Keyboard Back	Cheek	251(High)	848.8	GSM	Integral	Head	0.275	1.6
		Tilt	251(High)	848.8	GSM	Integral	Head	0.158	1.6
	Keyboard Front	Cheek	251(High)	848.8	GSM	Integral	Head	0.260	1.6
		Tilt	251(High)	848.8	GSM	Integral	Head	0.150	1.6
Right Head	Keyboard Back	Cheek	251(High)	848.8	GSM	Integral	Head	0.260	1.6
		Tilt	251(High)	848.8	GSM	Integral	Head	0.169	1.6
	Keyboard Front	Cheek	251(High)	848.8	GSM	Integral	Head	0.257	1.6
		Tilt	251(High)	848.8	GSM	Integral	Head	0.162	1.6
Body-Worn Headset	Keyboard Back		251(High)	848.8	GSM	Integral	Body	0.518	1.6
	Keyboard Front		251(High)	848.8	GSM	Integral	Body	0.543	1.6
Body-Worn Back	Keyboard Back		128(Low)	824.2	GPRS	Integral	Body	1.072	1.6
			190(Middle)	836.6	GPRS	Integral	Body	1.021	1.6
			251(High)	848.8	GPRS	Integral	Body	1.038	1.6
	Keyboard Front		128(Low)	824.2	GPRS	Integral	Body	1.002	1.6
			190(Middle)	836.6	GPRS	Integral	Body	1.231	1.6
			251(High)	848.8	GPRS	Integral	Body	1.134	1.6

**PCS Band:**

EUT Position			Frequency (MHz)		Test Mode	Antenna Type	Liquid Type	FCC 1g SAR (W/Kg)	
			Channel	MHz				Measurement	Limit
Left Head	Keyboard Back	Cheek	661(Middle)	1880.0	GSM	Integral	Head	0.801	1.6
		Tilt	661(Middle)	1880.0	GSM	Integral	Head	0.402	1.6
	Keyboard Front	Cheek	661(Middle)	1880.0	GSM	Integral	Head	0.790	1.6
		Tilt	661(Middle)	1880.0	GSM	Integral	Head	0.428	1.6
Right Head	Keyboard Back	Cheek	661(Middle)	1880.0	GSM	Integral	Head	0.736	1.6
		Tilt	661(Middle)	1880.0	GSM	Integral	Head	0.417	1.6
	Keyboard Front	Cheek	661(Middle)	1880.0	GSM	Integral	Head	0.738	1.6
		Tilt	661(Middle)	1880.0	GSM	Integral	Head	0.471	1.6
Body-Worn Headset	Keyboard Back		661(Middle)	1880.0	GSM	Integral	Body	0.569	1.6
	Keyboard Front		661(Middle)	1880.0	GSM	Integral	Body	0.619	1.6
Body-Worn Back	Keyboard Back		512(Low)	1850.2	GPRS	Integral	Body	1.242	1.6
			661(Middle)	1880.0	GPRS	Integral	Body	1.354	1.6
			810(High)	1909.8	GPRS	Integral	Body	1.355	1.6
	Keyboard Front		512(Low)	1850.2	GPRS	Integral	Body	1.134	1.6
			661(Middle)	1880.0	GPRS	Integral	Body	1.200	1.6
			810(High)	1909.8	GPRS	Integral	Body	1.281	1.6

**Note:**

1. The EUT is a Class B mobile phone which can be attached to both GPRS and GSM services, using one service at a time.
2. The Multi-slot Classes of EUT is Class 12 which has maximum 4 Downlink slots and 4 Uplink slots, the maximum active slots is 5, when perform the multiple slots scan, 1 DL+4UL is the worse case.
3. The EUT transmit and receive through the same GSM antenna while testing SAR.

**EUT SCAN RESULTS**

**Test Laboratory: Bay Area Compliance Lab Corp. (Shenzhen)**

**Left Head Cheek-Keyboard Back (835 MHz High Channel)**

Measurement Data

Test mode : GSM  
 Crest Factor : 8  
 Scan Type : Complete  
 Area Scan : 13x9x1: Measurement x=10mm, y=10mm, z=4mm  
 Zoom Scan : 7x7x7: Measurement x=5mm, y=5mm, z=5mm  
 Power Drift-Start : 0.176 W/kg  
 Power Drift-Finish : 0.178 W/kg  
 Power Drift (%) : 1.350

Tissue Data

Type : HEAD  
 Frequency : 835.00 MHz  
 Epsilon : 42.62 F/m  
 Sigma : 0.90 S/m  
 Density : 1000.00 kg/cu. m

Probe Data

Serial No. : 500-00283  
 Frequency : 835.00 MHz  
 Duty Cycle Factor : 8  
 Conversion Factor : 6.6  
 Probe Sensitivity : 1.20 1.20 1.20  $\mu\text{V}/(\text{V/m})^2$   
 Compression Point : 95.00 mV  
 Offset : 1.56 mm

1 gram SAR value : 0.275 W/kg  
 10 gram SAR value : 0.171 W/kg  
 Area Scan Peak SAR : 0.275 W/kg  
 Zoom Scan Peak SAR : 0.480 W/kg

**Plot 1#**

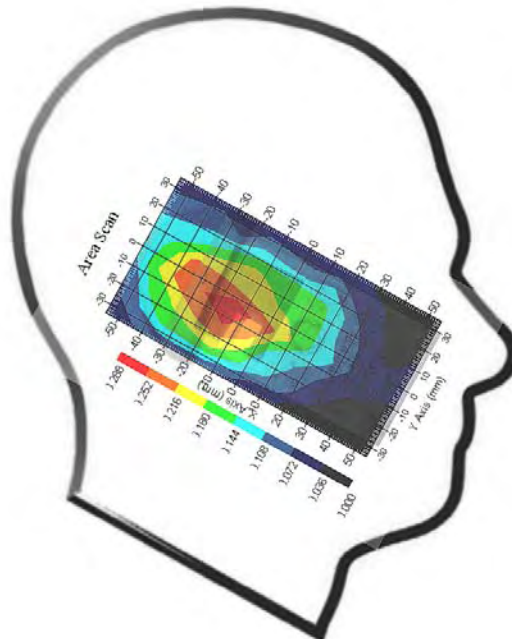

**Test Laboratory: Bay Area Compliance Lab Corp. (Shenzhen)**

**Left Head Tilt-Keyboard Back (835 MHz High Channel)**

Measurement Data

Test mode : GSM  
 Crest Factor : 8  
 Scan Type : Complete  
 Area Scan : 13x9x1 : Measurement x=10mm, y=10mm, z=4mm  
 Zoom Scan : 7x7x7 : Measurement x=5mm, y=5mm, z=5mm  
 Power Drift-Start : 0.137 W/kg  
 Power Drift-Finish : 0.131 W/kg  
 Power Drift (%) : -3.976

Tissue Data

Type : HEAD  
 Frequency : 835.00 MHz  
 Epsilon : 42.62 F/m  
 Sigma : 0.90 S/m  
 Density : 1000.00 kg/cu. m

Probe Data

Serial No. : 500-00283  
 Frequency : 835.00 MHz  
 Duty Cycle Factor : 8  
 Conversion Factor : 6.6  
 Probe Sensitivity : 1.20 1.20 1.20  $\mu\text{V}/(\text{V}/\text{m})^2$   
 Compression Point : 95.00 mV  
 Offset : 1.56 mm

1 gram SAR value : 0.158 W/kg  
 10 gram SAR value : 0.115 W/kg  
 Area Scan Peak SAR : 0.176 W/kg  
 Zoom Scan Peak SAR : 0.270 W/kg

**Plot 2#**

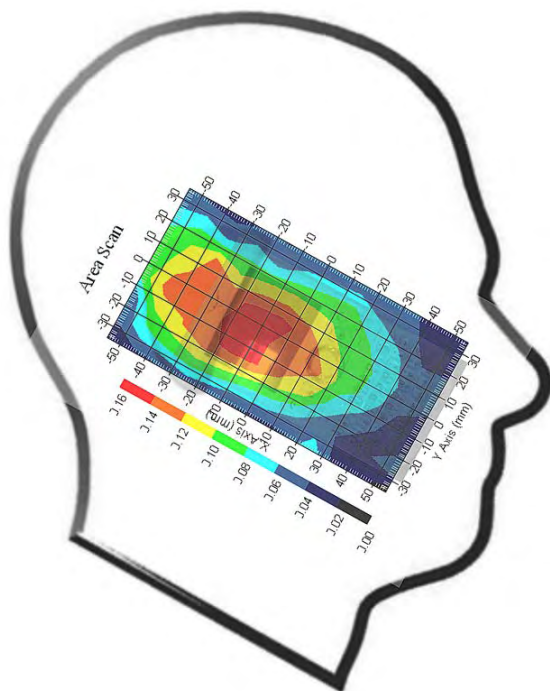

**Test Laboratory: Bay Area Compliance Lab Corp. (Shenzhen)**

**Left Head Cheek-Keyboard Front (835 MHz High Channel)**

Measurement Data

Test mode : GSM  
 Crest Factor : 8  
 Scan Type : Complete  
 Area Scan : 13x9x1: Measurement x=10mm, y=10mm, z=4mm  
 Zoom Scan : 7x7x7: Measurement x=5mm, y=5mm, z=5mm  
 Power Drift-Start : 0.095 W/kg  
 Power Drift-Finish : 0.094 W/kg  
 Power Drift (%) : -1.083

Tissue Data

Type : HEAD  
 Frequency : 835.00 MHz  
 Epsilon : 42.62 F/m  
 Sigma : 0.90 S/m  
 Density : 1000.00 kg/cu. m

Probe Data

Serial No. : 500-00283  
 Frequency : 835.00 MHz  
 Duty Cycle Factor : 8  
 Conversion Factor : 6.6  
 Probe Sensitivity : 1.20 1.20 1.20  $\mu\text{V}/(\text{V}/\text{m})^2$   
 Compression Point : 95.00 mV  
 Offset : 1.56 mm

1 gram SAR value : 0.260 W/kg  
 10 gram SAR value : 0.173 W/kg  
 Area Scan Peak SAR : 0.261 W/kg  
 Zoom Scan Peak SAR : 0.510 W/kg

**Plot 3#**

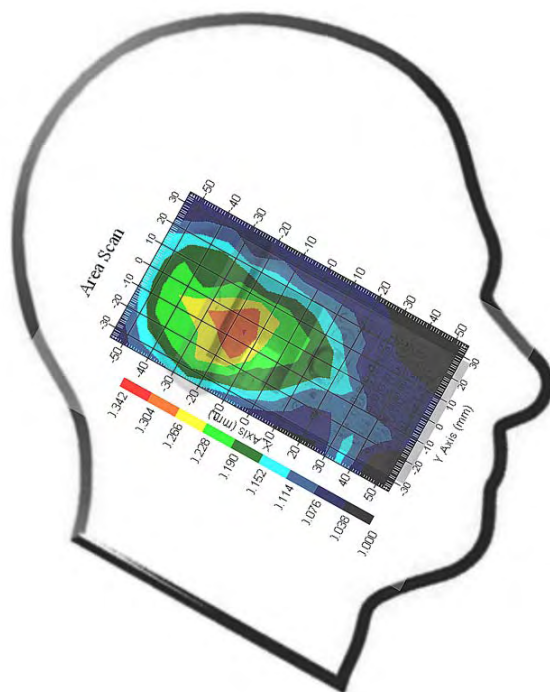



**Test Laboratory: Bay Area Compliance Lab Corp. (Shenzhen)**

**Left Head Tilt –Keyboard Front (835 MHz High Channel)**

Measurement Data

Test mode : GSM  
Crest Factor : 8  
Scan Type : Complete  
Area Scan : 13x9x1 : Measurement x=10mm, y=10mm, z=4mm  
Zoom Scan : 7x7x7 : Measurement x=5mm, y=5mm, z=5mm  
Power Drift-Start : 0.090 W/kg  
Power Drift-Finish : 0.089 W/kg  
Power Drift (%) : -1.105

Tissue Data

Type : HEAD  
Frequency : 835.00 MHz  
Epsilon : 42.62 F/m  
Sigma : 0.90 S/m  
Density : 1000.00 kg/cu. m

Probe Data

Serial No. : 500-00283  
Frequency : 835.00 MHz  
Duty Cycle Factor : 8  
Conversion Factor : 6.6  
Probe Sensitivity : 1.20 1.20 1.20  $\mu\text{V}/(\text{V}/\text{m})^2$   
Compression Point : 95.00 mV  
Offset : 1.56 mm

1 gram SAR value : 0.150 W/kg  
10 gram SAR value : 0.108 W/kg  
Area Scan Peak SAR : 0.161 W/kg  
Zoom Scan Peak SAR : 0.240 W/kg

**Plot 4#**

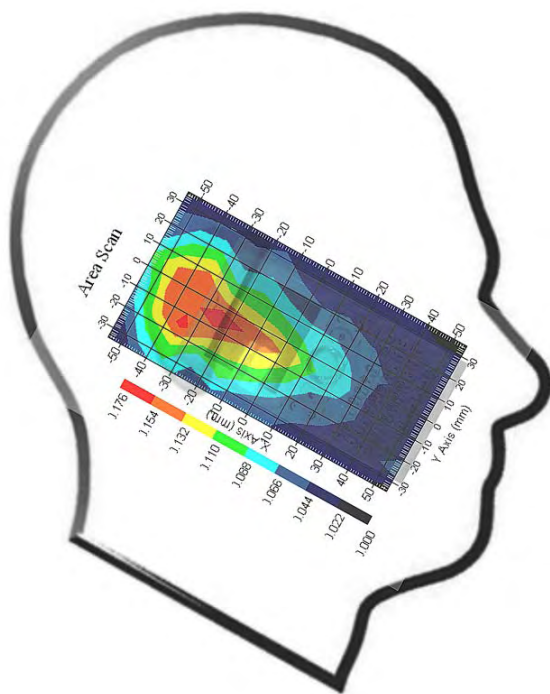

**Test Laboratory: Bay Area Compliance Lab Corp. (Shenzhen)**

**Right Head Cheek-Keyboard Back (835 MHz High Channel)**

Measurement Data

Test mode : GSM  
 Crest Factor : 8  
 Scan Type : Complete  
 Area Scan : 13x9x1 : Measurement x=10mm, y=10mm, z=4mm  
 Zoom Scan : 7x7x7 : Measurement x=5mm, y=5mm, z=5mm  
 Power Drift-Start : 0.186 W/kg  
 Power Drift-Finish : 0.185 W/kg  
 Power Drift (%) : -1.257

Tissue Data

Type : HEAD  
 Frequency : 835.00 MHz  
 Epsilon : 42.62 F/m  
 Sigma : 0.90 S/m  
 Density : 1000.00 kg/cu. m

Probe Data

Serial No. : 500-00283  
 Frequency : 835.00 MHz  
 Duty Cycle Factor : 8  
 Conversion Factor : 6.6  
 Probe Sensitivity : 1.20 1.20 1.20  $\mu\text{V}/(\text{V}/\text{m})^2$   
 Compression Point : 95.00 mV  
 Offset : 1.56 mm

1 gram SAR value : 0.260 W/kg  
 10 gram SAR value : 0.152 W/kg  
 Area Scan Peak SAR : 0.277 W/kg  
 Zoom Scan Peak SAR : 0.460 W/kg

**Plot 5#**

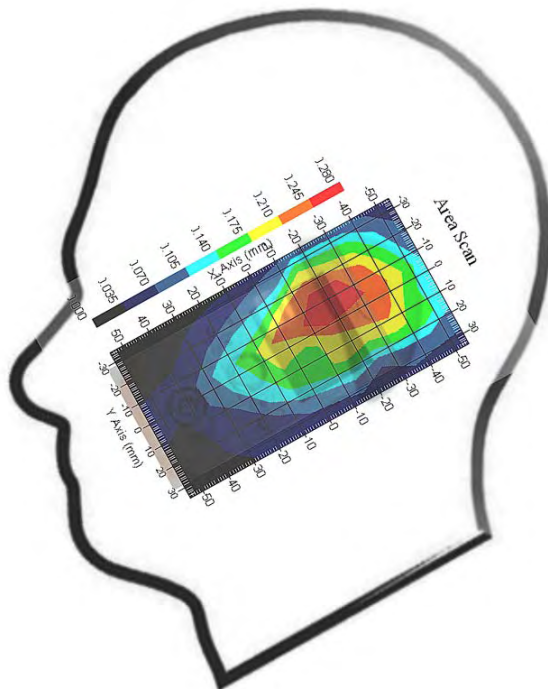

**Test Laboratory: Bay Area Compliance Lab Corp. (Shenzhen)**

**Right Head Tilt-Keyboard Back (835 MHz High Channel)**

Measurement Data

Test mode : GSM  
 Crest Factor : 8  
 Scan Type : Complete  
 Area Scan : 13x9x1 : Measurement x=10mm, y=10mm, z=4mm  
 Zoom Scan : 7x7x7 : Measurement x=5mm, y=5mm, z=5mm  
 Power Drift-Start : 0.151 W/kg  
 Power Drift-Finish : 0.154 W/kg  
 Power Drift (%) : 2.021

Tissue Data

Type : HEAD  
 Frequency : 835.00 MHz  
 Epsilon : 42.62 F/m  
 Sigma : 0.90 S/m  
 Density : 1000.00 kg/cu. m

Probe Data

Serial No. : 500-00283  
 Frequency : 835.00 MHz  
 Duty Cycle Factor : 8  
 Conversion Factor : 6.6  
 Probe Sensitivity : 1.20 1.20 1.20  $\mu\text{V}/(\text{V}/\text{m})^2$   
 Compression Point : 95.00 mV  
 Offset : 1.56 mm

1 gram SAR value : 0.169 W/kg  
 10 gram SAR value : 0.109 W/kg  
 Area Scan Peak SAR : 0.155 W/kg  
 Zoom Scan Peak SAR : 0.330 W/kg

**Plot 6#**

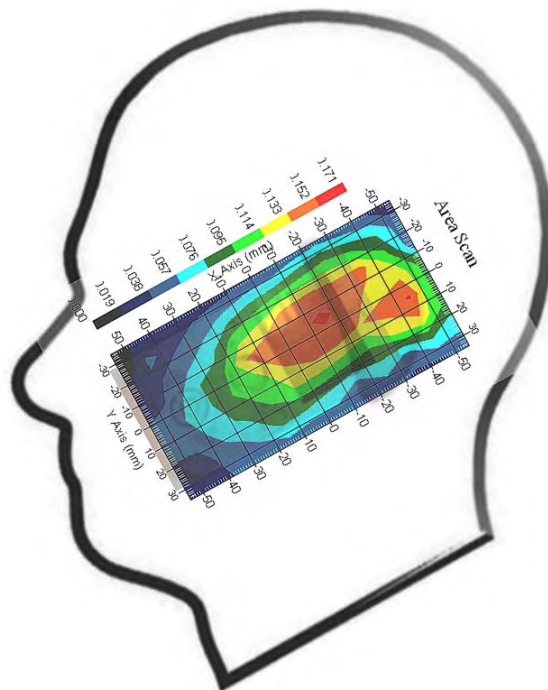

**Test Laboratory: Bay Area Compliance Lab Corp. (Shenzhen)**

**Right Head Cheek-Keyboard Front (835 MHz High Channel)**

Measurement Data

Test mode : GSM  
 Crest Factor : 8  
 Scan Type : Complete  
 Area Scan : 13x9x1 : Measurement x=10mm, y=10mm, z=4mm  
 Zoom Scan : 7x7x7 : Measurement x=5mm, y=5mm, z=5mm  
 Power Drift-Start : 0.172 W/kg  
 Power Drift-Finish : 0.175 W/kg  
 Power Drift (%) : 1.848

Tissue Data

Type : HEAD  
 Frequency : 835.00 MHz  
 Epsilon : 42.62 F/m  
 Sigma : 0.90 S/m  
 Density : 1000.00 kg/cu. m

Probe Data

Serial No. : 500-00283  
 Frequency : 835.00 MHz  
 Duty Cycle Factor : 8  
 Conversion Factor : 6.6  
 Probe Sensitivity : 1.20 1.20 1.20  $\mu\text{V}/(\text{V}/\text{m})^2$   
 Compression Point : 95.00 mV  
 Offset : 1.56 mm

1 gram SAR value : 0.257 W/kg  
 10 gram SAR value : 0.172 W/kg  
 Area Scan Peak SAR : 0.290 W/kg  
 Zoom Scan Peak SAR : 0.410 W/kg

**Plot 7#**

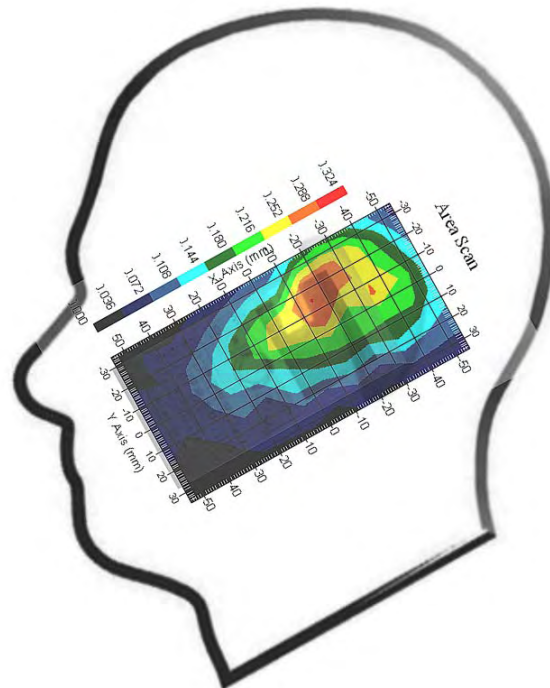

**Test Laboratory: Bay Area Compliance Lab Corp. (Shenzhen)**

**Right Head Tilt-Keyboard Front (835 MHz High Channel)**

Measurement Data

Test mode : GSM  
 Crest Factor : 8  
 Scan Type : Complete  
 Area Scan : 13x9x1 : Measurement x=10mm, y=10mm, z=4mm  
 Zoom Scan : 7x7x7 : Measurement x=5mm, y=5mm, z=5mm  
 Power Drift-Start : 0.163 W/kg  
 Power Drift-Finish : 0.160 W/kg  
 Power Drift (%) : -1.912

Tissue Data

Type : HEAD  
 Frequency : 835.00 MHz  
 Epsilon : 42.62 F/m  
 Sigma : 0.90 S/m  
 Density : 1000.00 kg/cu. m

Probe Data

Serial No. : 500-00283  
 Frequency : 835.00 MHz  
 Duty Cycle Factor : 8  
 Conversion Factor : 6.6  
 Probe Sensitivity : 1.20 1.20 1.20  $\mu\text{V}/(\text{V}/\text{m})^2$   
 Compression Point : 95.00 mV  
 Offset : 1.56 mm

1 gram SAR value : 0.162 W/kg  
 10 gram SAR value : 0.114 W/kg  
 Area Scan Peak SAR : 0.166 W/kg  
 Zoom Scan Peak SAR : 0.260 W/kg

**Plot 8#**

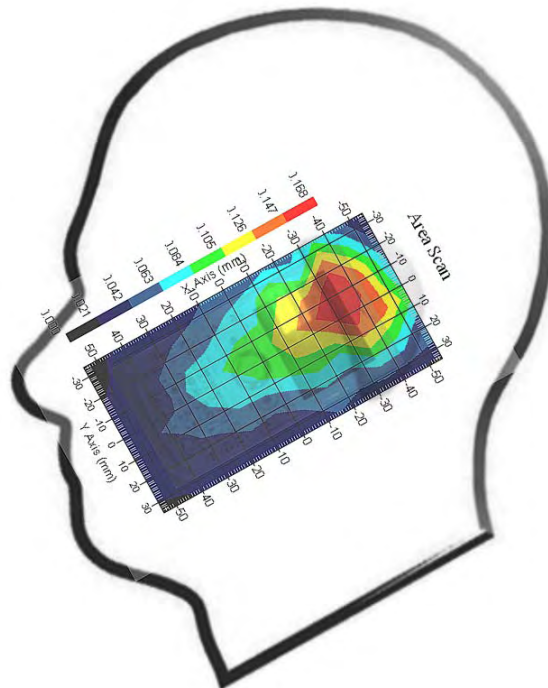

**Test Laboratory: Bay Area Compliance Lab Corp. (Shenzhen)**

**Body-worn Headset-Keyboard Back (835 MHz Low Channel)**

Measurement Data

Test mode : GSM  
 Crest Factor : 8  
 Scan Type : Complete  
 Area Scan : 13x9x1 : Measurement x=10mm, y=10mm, z=4mm  
 Zoom Scan : 7x7x7 : Measurement x=5mm, y=5mm, z=5mm  
 Power Drift-Start : 0.396 W/kg  
 Power Drift-Finish : 0.415 W/kg  
 Power Drift (%) : 4.595

Tissue Data

Type : Body  
 Frequency : 835.00 MHz  
 Epsilon : 55.44 F/m  
 Sigma : 0.99 S/m  
 Density : 1000.00 kg/cu. m

Probe Data

Serial No. : 500-00283  
 Frequency : 835.00 MHz  
 Duty Cycle Factor : 8  
 Conversion Factor : 6.6  
 Probe Sensitivity : 1.20 1.20 1.20  $\mu\text{V}/(\text{V}/\text{m})^2$   
 Compression Point : 95.00 mV  
 Offset : 1.56 mm

1 gram SAR value : 0.518 W/kg  
 10 gram SAR value : 0.241 W/kg  
 Area Scan Peak SAR : 0.544 W/kg  
 Zoom Scan Peak SAR : 0.950 W/kg

**Plot 09#**

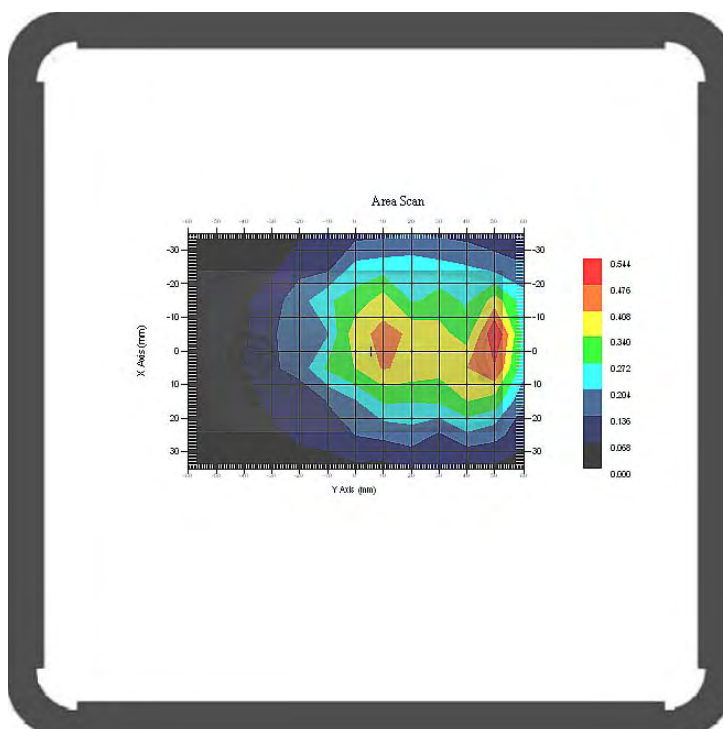

**Test Laboratory: Bay Area Compliance Lab Corp. (Shenzhen)**

**Body-worn Headset-Keyboard Front (835 MHz Low Channel)**

Measurement Data

Test mode : GSM  
 Crest Factor : 8  
 Scan Type : Complete  
 Area Scan : 13x9x1 : Measurement x=10mm, y=10mm, z=4mm  
 Zoom Scan : 7x7x7 : Measurement x=5mm, y=5mm, z=5mm  
 Power Drift-Start : 0.437 W/kg  
 Power Drift-Finish : 0.429 W/kg  
 Power Drift (%) : -2.282

Tissue Data

Type : Body  
 Frequency : 835.00 MHz  
 Epsilon : 55.44 F/m  
 Sigma : 0.99 S/m  
 Density : 1000.00 kg/cu. m

Probe Data

Serial No. : 500-00283  
 Frequency : 835.00 MHz  
 Duty Cycle Factor : 8  
 Conversion Factor : 6.6  
 Probe Sensitivity : 1.20 1.20 1.20  $\mu\text{V}/(\text{V}/\text{m})^2$   
 Compression Point : 95.00 mV  
 Offset : 1.56 mm

1 gram SAR value : 0.543 W/kg  
 10 gram SAR value : 0.377 W/kg  
 Area Scan Peak SAR : 0.582 W/kg  
 Zoom Scan Peak SAR : 0.970 W/kg

**Plot 10#**

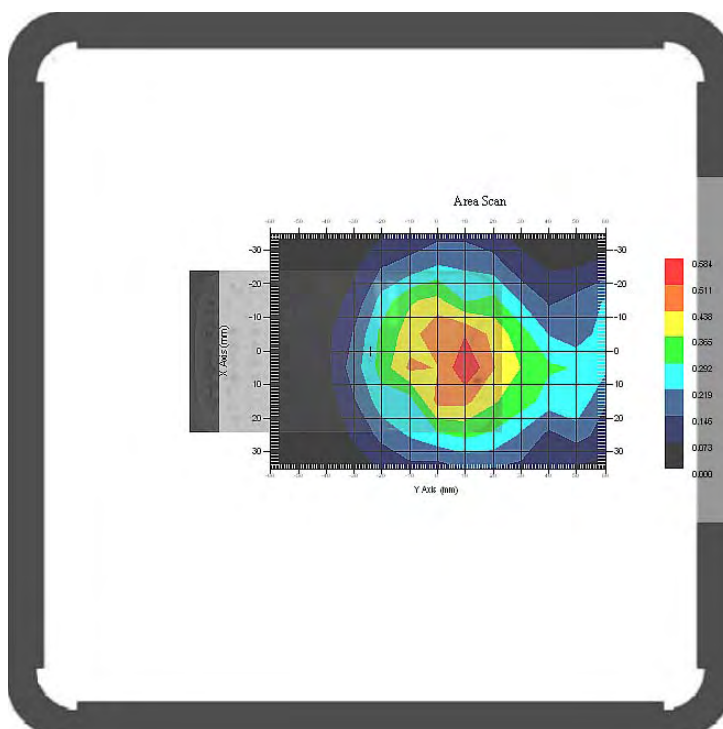



**Test Laboratory: Bay Area Compliance Lab Corp. (Shenzhen)**

**Body-worn Keyboard Back (835 MHz Low Channel)**

Measurement Data

Test mode : GPRS  
 Crest Factor : 2  
 Scan Type : Complete  
 Area Scan : 13x9x1 : Measurement x=10mm, y=10mm, z=4mm  
 Zoom Scan : 7x7x7 : Measurement x=5mm, y=5mm, z=5mm  
 Power Drift-Start : 1.093 W/kg  
 Power Drift-Finish : 0.993 W/kg  
 Power Drift (%) : -4.026

Tissue Data

Type : Body  
 Frequency : 835.00 MHz  
 Epsilon : 55.44 F/m  
 Sigma : 0.99 S/m  
 Density : 1000.00 kg/cu. m

Probe Data

Serial No. : 500-00283  
 Frequency : 835.00 MHz  
 Duty Cycle Factor : 2  
 Conversion Factor : 6.6  
 Probe Sensitivity : 1.20 1.20 1.20  $\mu\text{V}/(\text{V}/\text{m})^2$   
 Compression Point : 95.00 mV  
 Offset : 1.56 mm

1 gram SAR value : 1.072 W/kg  
 10 gram SAR value : 0.628 W/kg  
 Area Scan Peak SAR : 1.279 W/kg  
 Zoom Scan Peak SAR : 1.436 W/kg

**Plot 11#**

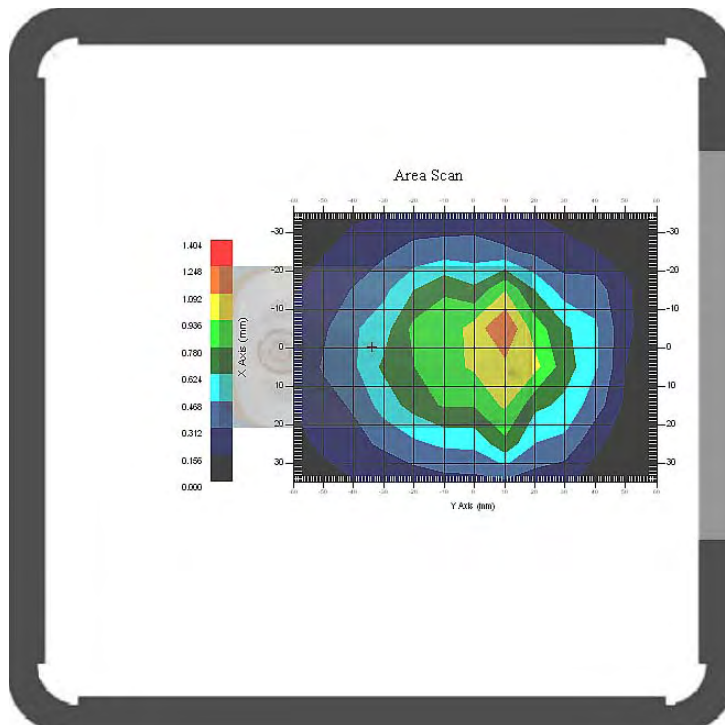



**Test Laboratory: Bay Area Compliance Lab Corp. (Shenzhen)**

**Body-worn Keyboard Back (835 MHz Middle Channel)**

Measurement Data

Test mode : GPRS  
 Crest Factor : 2  
 Scan Type : Complete  
 Area Scan : 13x9x1 : Measurement x=10mm, y=10mm, z=4mm  
 Zoom Scan : 7x7x7 : Measurement x=5mm, y=5mm, z=5mm  
 Power Drift-Start : 0.937 W/kg  
 Power Drift-Finish : 0.924 W/kg  
 Power Drift (%) : -1.475

Tissue Data

Type : Body  
 Frequency : 835.00 MHz  
 Epsilon : 55.44 F/m  
 Sigma : 0.99 S/m  
 Density : 1000.00 kg/cu. m

Probe Data

Serial No. : 500-00283  
 Frequency : 835.00 MHz  
 Duty Cycle Factor : 2  
 Conversion Factor : 6.6  
 Probe Sensitivity : 1.20 1.20 1.20  $\mu\text{V}/(\text{V}/\text{m})^2$   
 Compression Point : 95.00 mV  
 Offset : 1.56 mm

1 gram SAR value : 1.021 W/kg  
 10 gram SAR value : 0.579 W/kg  
 Area Scan Peak SAR : 1.215 W/kg  
 Zoom Scan Peak SAR : 1.421 W/kg

**Plot 12#**

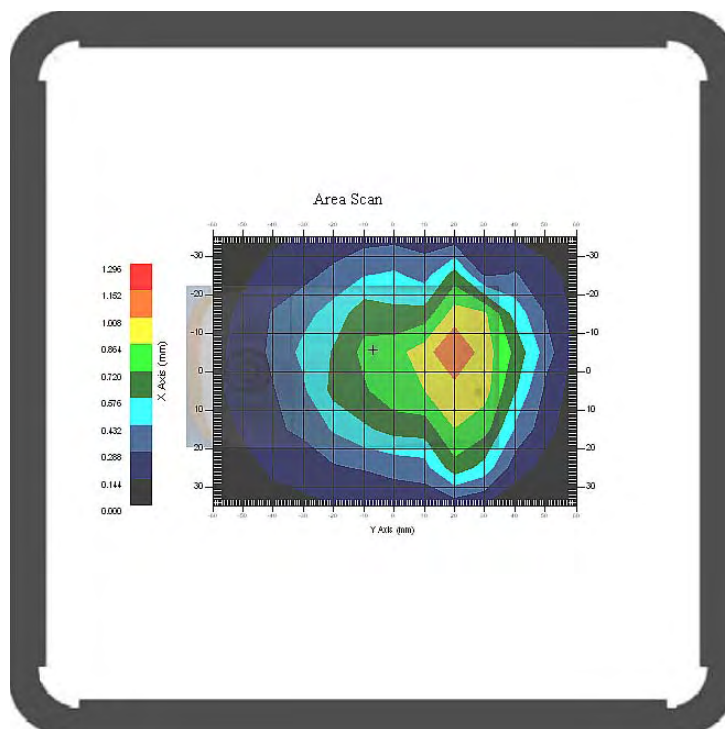

**Test Laboratory: Bay Area Compliance Lab Corp. (Shenzhen)**

**Body-worn Keyboard Back (835 MHz High Channel)**

Measurement Data

Test mode : GPRS  
 Crest Factor : 2  
 Scan Type : Complete  
 Area Scan : 13x9x1 : Measurement x=10mm, y=10mm, z=4mm  
 Zoom Scan : 7x7x7 : Measurement x=5mm, y=5mm, z=5mm  
 Power Drift-Start : 1.082 W/kg  
 Power Drift-Finish : 1.095 W/kg  
 Power Drift (%) : 1.201

Tissue Data

Type : Body  
 Frequency : 835.00 MHz  
 Epsilon : 55.44 F/m  
 Sigma : 0.99 S/m  
 Density : 1000.00 kg/cu. m

Probe Data

Serial No. : 500-00283  
 Frequency : 835.00 MHz  
 Duty Cycle Factor : 2  
 Conversion Factor : 6.6  
 Probe Sensitivity : 1.20 1.20 1.20  $\mu\text{V}/(\text{V}/\text{m})^2$   
 Compression Point : 95.00 mV  
 Offset : 1.56 mm

1 gram SAR value : 1.038 W/kg  
 10 gram SAR value : 0.682 W/kg  
 Area Scan Peak SAR : 1.026 W/kg  
 Zoom Scan Peak SAR : 1.471 W/kg

**Plot 13#**

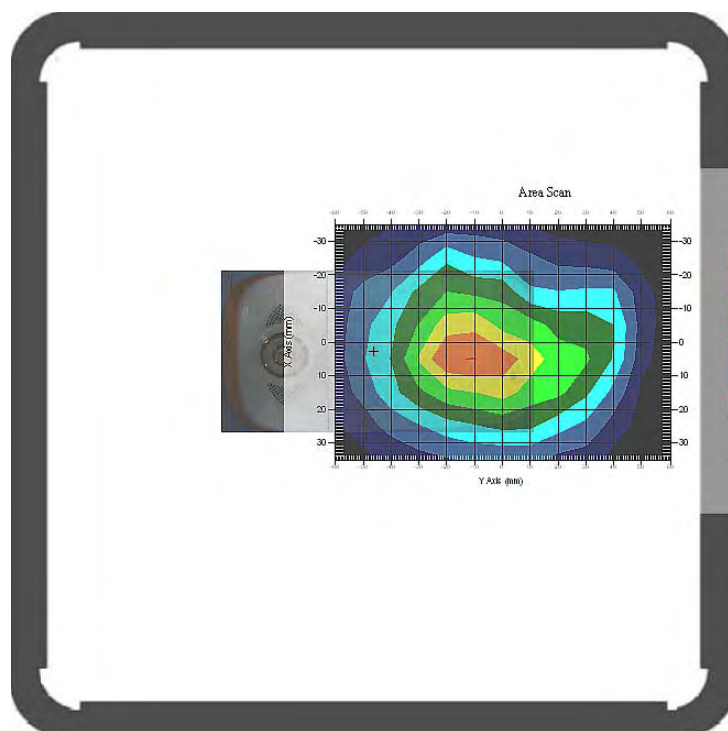

**Test Laboratory: Bay Area Compliance Lab Corp. (Shenzhen)**

**Body-worn Keyboard Front (835 MHz Low Channel)**

Measurement Data

Test mode : GPRS  
 Crest Factor : 2  
 Scan Type : Complete  
 Area Scan : 13x9x1 : Measurement x=10mm, y=10mm, z=4mm  
 Zoom Scan : 7x7x7 : Measurement x=5mm, y=5mm, z=5mm  
 Power Drift-Start : 0.954 W/kg  
 Power Drift-Finish : 0.944 W/kg  
 Power Drift (%) : -1.188

Tissue Data

Type : Body  
 Frequency : 835.00 MHz  
 Epsilon : 55.44 F/m  
 Sigma : 0.99 S/m  
 Density : 1000.00 kg/cu. m

Probe Data

Serial No. : 500-00283  
 Frequency : 835.00 MHz  
 Duty Cycle Factor : 2  
 Conversion Factor : 6.6  
 Probe Sensitivity : 1.20 1.20 1.20  $\mu\text{V}/(\text{V}/\text{m})^2$   
 Compression Point : 95.00 mV  
 Offset : 1.56 mm

1 gram SAR value : 1.002 W/kg  
 10 gram SAR value : 0.630 W/kg  
 Area Scan Peak SAR : 0.992 W/kg  
 Zoom Scan Peak SAR : 1.521 W/kg

**Plot 14#**

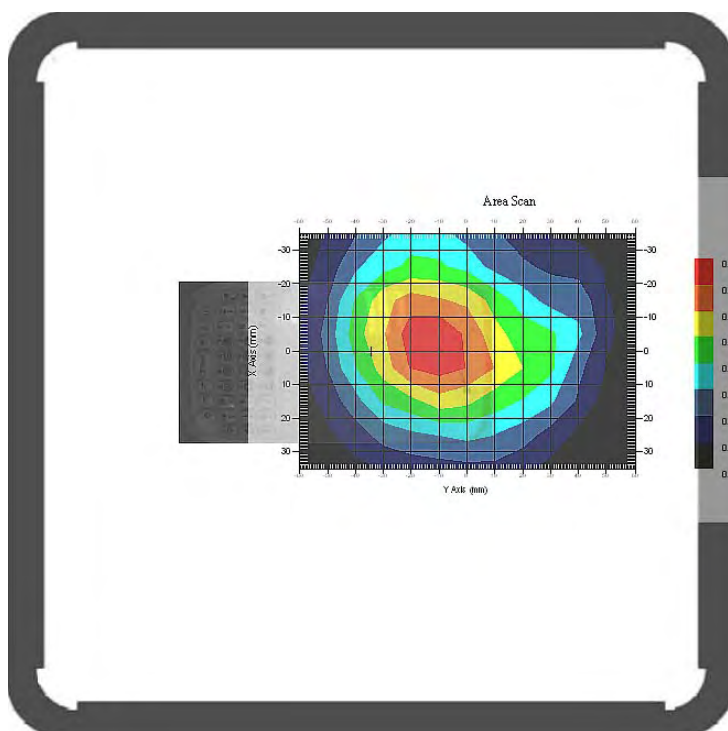

**Test Laboratory: Bay Area Compliance Lab Corp. (Shenzhen)**

**Body-worn Keyboard Front (835 MHz Middle Channel)**

Measurement Data

Test mode : GPRS  
 Crest Factor : 2  
 Scan Type : Complete  
 Area Scan : 13x9x1 : Measurement x=10mm, y=10mm, z=4mm  
 Zoom Scan : 7x7x7 : Measurement x=5mm, y=5mm, z=5mm  
 Power Drift-Start : 1.320 W/kg  
 Power Drift-Finish : 1.280 W/kg  
 Power Drift (%) : -3.025

Tissue Data

Type : Body  
 Frequency : 835.00 MHz  
 Epsilon : 55.44 F/m  
 Sigma : 0.99 S/m  
 Density : 1000.00 kg/cu. m

Probe Data

Serial No. : 500-00283  
 Frequency : 835.00 MHz  
 Duty Cycle Factor : 2  
 Conversion Factor : 6.6  
 Probe Sensitivity : 1.20 1.20 1.20  $\mu\text{V}/(\text{V}/\text{m})^2$   
 Compression Point : 95.00 mV  
 Offset : 1.56 mm

1 gram SAR value : 1.231 W/kg  
 10 gram SAR value : 0.804 W/kg  
 Area Scan Peak SAR : 1.196 W/kg  
 Zoom Scan Peak SAR : 1.821 W/kg

**Plot 15#**

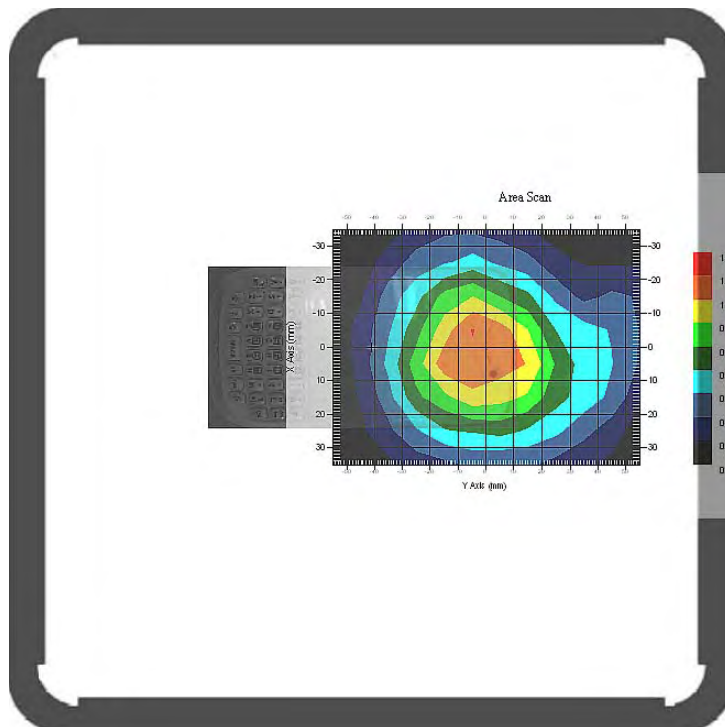

**Test Laboratory: Bay Area Compliance Lab Corp. (Shenzhen)**

**Body-worn Keyboard Front (835 MHz High Channel)**

Measurement Data

Test mode : GPRS  
 Crest Factor : 2  
 Scan Type : Complete  
 Area Scan : 13x9x1 : Measurement x=10mm, y=10mm, z=4mm  
 Zoom Scan : 7x7x7 : Measurement x=5mm, y=5mm, z=5mm  
 Power Drift-Start : 1.032 W/kg  
 Power Drift-Finish : 1.075 W/kg  
 Power Drift (%) : 4.183

Tissue Data

Type : Body  
 Frequency : 835.00 MHz  
 Epsilon : 55.44 F/m  
 Sigma : 0.99 S/m  
 Density : 1000.00 kg/cu. m

Probe Data

Serial No. : 500-00283  
 Frequency : 835.00 MHz  
 Duty Cycle Factor : 2  
 Conversion Factor : 6.6  
 Probe Sensitivity : 1.20 1.20 1.20  $\mu\text{V}/(\text{V}/\text{m})^2$   
 Compression Point : 95.00 mV  
 Offset : 1.56 mm

1 gram SAR value : 1.134 W/kg  
 10 gram SAR value : 0.747 W/kg  
 Area Scan Peak SAR : 1.318 W/kg  
 Zoom Scan Peak SAR : 1.731 W/kg

**Plot 16#**

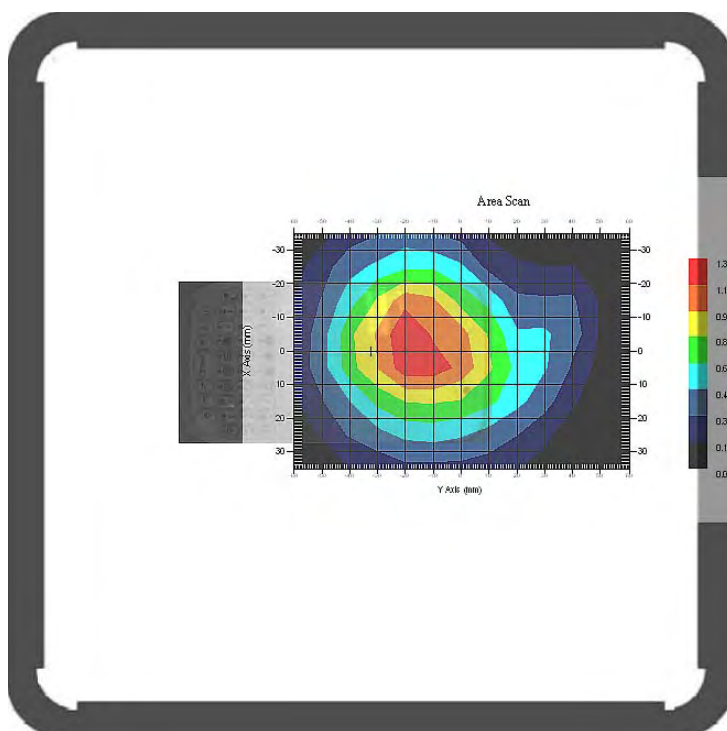

**Test Laboratory: Bay Area Compliance Lab Corp. (Shenzhen)**

**Left Head Cheek-Keyboard Back (1900 MHz Middle Channel)**

Measurement Data

Test mode : GSM  
 Crest Factor : 8  
 Scan Type : Complete  
 Area Scan : 13x9x1 : Measurement x=10mm, y=10mm, z=4mm  
 Zoom Scan : 7x7x7 : Measurement x=5mm, y=5mm, z=5mm  
 Power Drift-Start : 0.034 W/kg  
 Power Drift-Finish : 0.033 W/kg  
 Power Drift (%) : -3.206

Tissue Data

Type : HEAD  
 Frequency : 1900.00 MHz  
 Epsilon : 40.12 F/m  
 Sigma : 1.41S/m  
 Density : 1000.00 kg/cu. m

Probe Data

Serial No. : 500-00283  
 Frequency : 1900.00 MHz  
 Duty Cycle Factor : 8  
 Conversion Factor : 5.2  
 Probe Sensitivity : 1.20 1.20 1.20  $\mu\text{V}/(\text{V}/\text{m})^2$   
 Compression Point : 95.00 mV  
 Offset : 1.56 mm

1 gram SAR value : 0.801 W/kg  
 10 gram SAR value : 0.380 W/kg  
 Area Scan Peak SAR : 0.819 W/kg  
 Zoom Scan Peak SAR : 1.630 W/kg

**Plot 17#**

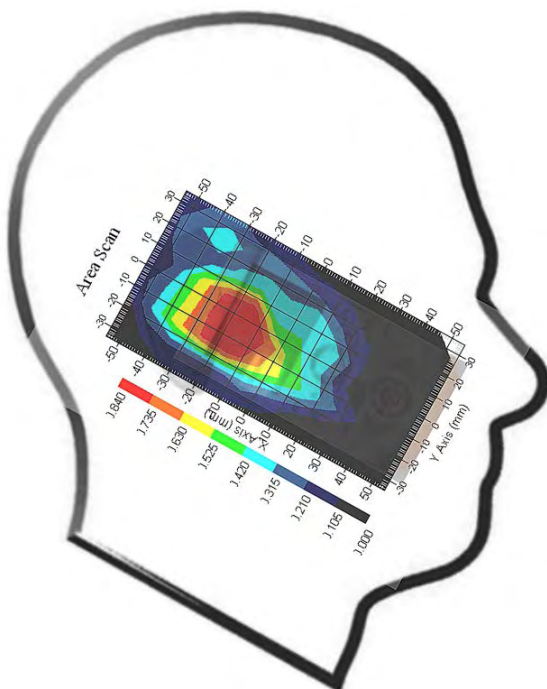

**Test Laboratory: Bay Area Compliance Lab Corp. (Shenzhen)**

**Left Head Tilt-Keyboard Back (1900 MHz Middle Channel)**

Measurement Data

Test mode : GSM  
 Crest Factor : 8  
 Scan Type : Complete  
 Area Scan : 13x9x1 : Measurement x=10mm, y=10mm, z=4mm  
 Zoom Scan : 7x7x7 : Measurement x=5mm, y=5mm, z=5mm  
 Power Drift-Start : 0.059 W/kg  
 Power Drift-Finish : 0.058 W/kg  
 Power Drift (%) : -1.967

Tissue Data

Type : HEAD  
 Frequency : 1900.00 MHz  
 Epsilon : 40.12 F/m  
 Sigma : 1.41 S/m  
 Density : 1000.00 kg/cu. m

Probe Data

Serial No. : 500-00283  
 Frequency : 1900.00 MHz  
 Duty Cycle Factor : 8  
 Conversion Factor : 5.2  
 Probe Sensitivity : 1.20 1.20 1.20  $\mu\text{V}/(\text{V}/\text{m})^2$   
 Compression Point : 95.00 mV  
 Offset : 1.56 mm

1 gram SAR value : 0.402 W/kg  
 10 gram SAR value : 0.219 W/kg  
 Area Scan Peak SAR : 0.427 W/kg  
 Zoom Scan Peak SAR : 0.730 W/kg

**Plot 18#**

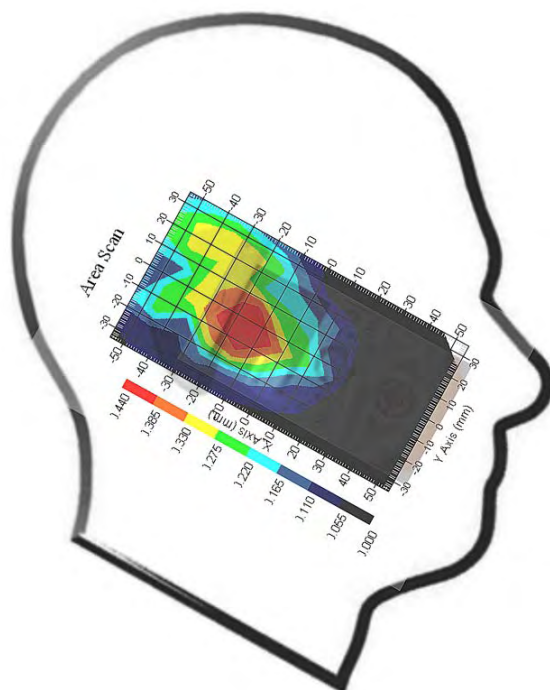

**Test Laboratory: Bay Area Compliance Lab Corp. (Shenzhen)**

**Left Head Cheek-Keyboard Front (1900 MHz Middle Channel)**

Measurement Data

Test mode : GSM  
 Crest Factor : 8  
 Scan Type : Complete  
 Area Scan : 13x9x1 : Measurement x=10mm, y=10mm, z=4mm  
 Zoom Scan : 7x7x7 : Measurement x=5mm, y=5mm, z=5mm  
 Power Drift-Start : 0.077 W/kg  
 Power Drift-Finish : 0.079 W/kg  
 Power Drift (%) : 3.082

Tissue Data

Type : HEAD  
 Frequency : 1900.00 MHz  
 Epsilon : 40.12 F/m  
 Sigma : 1.41 S/m  
 Density : 1000.00 kg/cu. m

Probe Data

Serial No. : 500-00283  
 Frequency : 1900.00 MHz  
 Duty Cycle Factor : 8  
 Conversion Factor : 5.2  
 Probe Sensitivity : 1.20 1.20 1.20  $\mu\text{V}/(\text{V}/\text{m})^2$   
 Compression Point : 95.00 mV  
 Offset : 1.56 mm

1 gram SAR value : 0.790 W/kg  
 10 gram SAR value : 0.376 W/kg  
 Area Scan Peak SAR : 0.829 W/kg  
 Zoom Scan Peak SAR : 1.550 W/kg

**Plot 19#**

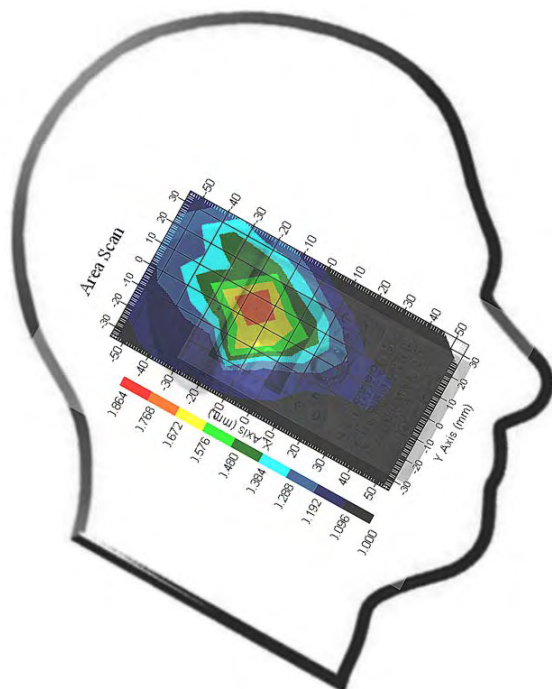



**Test Laboratory: Bay Area Compliance Lab Corp. (Shenzhen)**

**Left Head Tilt-Keyboard Front (1900 MHz Middle Channel)**

Measurement Data

Test mode : GSM  
Crest Factor : 8  
Scan Type : Complete  
Area Scan : 13x9x1 : Measurement x=10mm, y=10mm, z=4mm  
Zoom Scan : 7x7x7 : Measurement x=5mm, y=5mm, z=5mm  
Power Drift-Start : 0.082 W/kg  
Power Drift-Finish : 0.083 W/kg  
Power Drift (%) : 1.320

Tissue Data

Type : HEAD  
Frequency : 1900.00 MHz  
Epsilon : 40.12 F/m  
Sigma : 1.41 S/m  
Density : 1000.00 kg/cu. m

Probe Data

Serial No. : 500-00283  
Frequency : 1900.00 MHz  
Duty Cycle Factor : 8  
Conversion Factor : 5.2  
Probe Sensitivity : 1.20 1.20 1.20  $\mu\text{V}/(\text{V}/\text{m})^2$   
Compression Point : 95.00 mV  
Offset : 1.56 mm

1 gram SAR value : 0.428 W/kg  
10 gram SAR value : 0.220 W/kg  
Area Scan Peak SAR : 0.483 W/kg  
Zoom Scan Peak SAR : 0.820 W/kg

**Plot 20#**

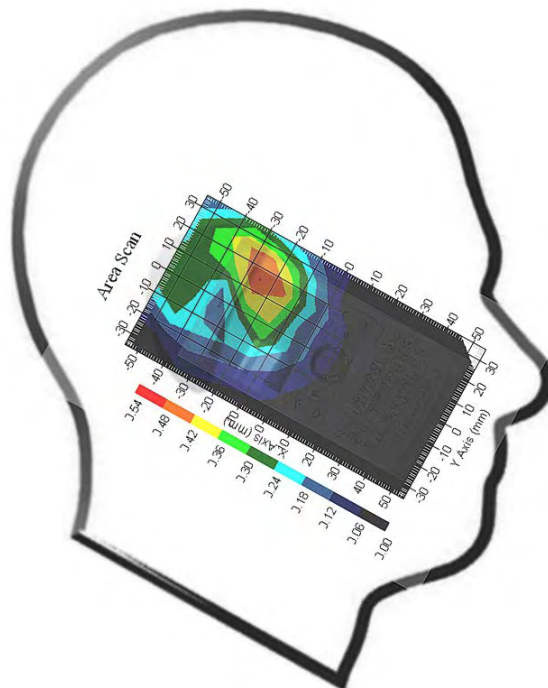

**Test Laboratory: Bay Area Compliance Lab Corp. (Shenzhen)**

**Right Head Cheek-Keyboard Back (1900 MHz Middle Channel)**

Measurement Data

Test mode : GSM  
 Crest Factor : 8  
 Scan Type : Complete  
 Area Scan : 13x9x1 : Measurement x=10mm, y=10mm, z=4mm  
 Zoom Scan : 7x7x7 : Measurement x=5mm, y=5mm, z=5mm  
 Power Drift-Start : 0.130 W/kg  
 Power Drift-Finish : 0.133 W/kg  
 Power Drift (%) : 2.347

Tissue Data

Type : HEAD  
 Frequency : 1900.00 MHz  
 Epsilon : 40.12 F/m  
 Sigma : 1.41 S/m  
 Density : 1000.00 kg/cu. m

Probe Data

Serial No. : 500-00283  
 Frequency : 1900.00 MHz  
 Duty Cycle Factor : 8  
 Conversion Factor : 5.2  
 Probe Sensitivity : 1.20 1.20 1.20  $\mu\text{V}/(\text{V}/\text{m})^2$   
 Compression Point : 95.00 mV  
 Offset : 1.56 mm

1 gram SAR value : 0.736 W/kg  
 10 gram SAR value : 0.375 W/kg  
 Area Scan Peak SAR : 0.842 W/kg  
 Zoom Scan Peak SAR : 1.231 W/kg

**Plot 21#**

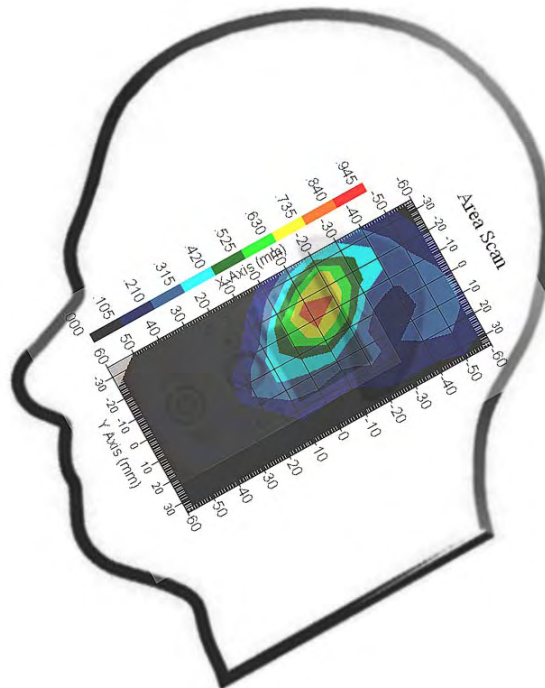

**Test Laboratory: Bay Area Compliance Lab Corp. (Shenzhen)**

**Right Head Tilt-Keyboard Back (1900 MHz Middle Channel)**

Measurement Data

Test mode : GSM  
 Crest Factor : 8  
 Scan Type : Complete  
 Area Scan : 13x9x1 : Measurement x=10mm, y=10mm, z=4mm  
 Zoom Scan : 7x7x7 : Measurement x=5mm, y=5mm, z=5mm  
 Power Drift-Start : 0.187 W/kg  
 Power Drift-Finish : 0.189 W/kg  
 Power Drift (%) : 1.264

Tissue Data

Type : HEAD  
 Frequency : 1900.00 MHz  
 Epsilon : 40.12 F/m  
 Sigma : 1.41 S/m  
 Density : 1000.00 kg/cu. m

Probe Data

Serial No. : 500-00283  
 Frequency : 1900.00 MHz  
 Duty Cycle Factor : 8  
 Conversion Factor : 5.2  
 Probe Sensitivity : 1.20 1.20 1.20  $\mu\text{V}/(\text{V}/\text{m})^2$   
 Compression Point : 95.00 mV  
 Offset : 1.56 mm

1 gram SAR value : 0.417 W/kg  
 10 gram SAR value : 0.210 W/kg  
 Area Scan Peak SAR : 0.458 W/kg  
 Zoom Scan Peak SAR : 0.740 W/kg

**Plot 22#**

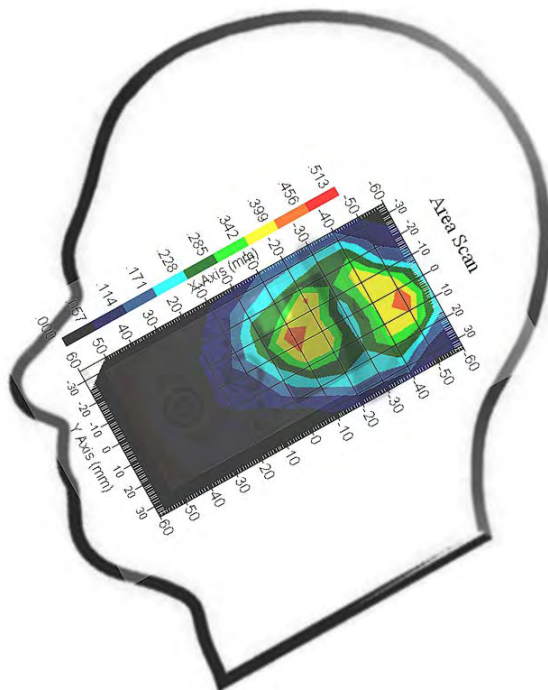

**Test Laboratory: Bay Area Compliance Lab Corp. (Shenzhen)**

**Right Head Cheek-Keyboard Front (1900 MHz Middle Channel)**

Measurement Data

Test mode : GSM  
 Crest Factor : 8  
 Scan Type : Complete  
 Area Scan : 13x9x1 : Measurement x=10mm, y=10mm, z=4mm  
 Zoom Scan : 7x7x7 : Measurement x=5mm, y=5mm, z=5mm  
 Power Drift-Start : 0.208 W/kg  
 Power Drift-Finish : 0.206 W/kg  
 Power Drift (%) : -1.064

Tissue Data

Type : HEAD  
 Frequency : 1900.00 MHz  
 Epsilon : 40.12 F/m  
 Sigma : 1.41 S/m  
 Density : 1000.00 kg/cu. m

Probe Data

Serial No. : 500-00283  
 Frequency : 1900.00 MHz  
 Duty Cycle Factor : 8  
 Conversion Factor : 5.2  
 Probe Sensitivity : 1.20 1.20 1.20  $\mu\text{V}/(\text{V}/\text{m})^2$   
 Compression Point : 95.00 mV  
 Offset : 1.56 mm

1 gram SAR value : 0.738 W/kg  
 10 gram SAR value : 0.405 W/kg  
 Area Scan Peak SAR : 0.837 W/kg  
 Zoom Scan Peak SAR : 1.311 W/kg

**Plot 23#**

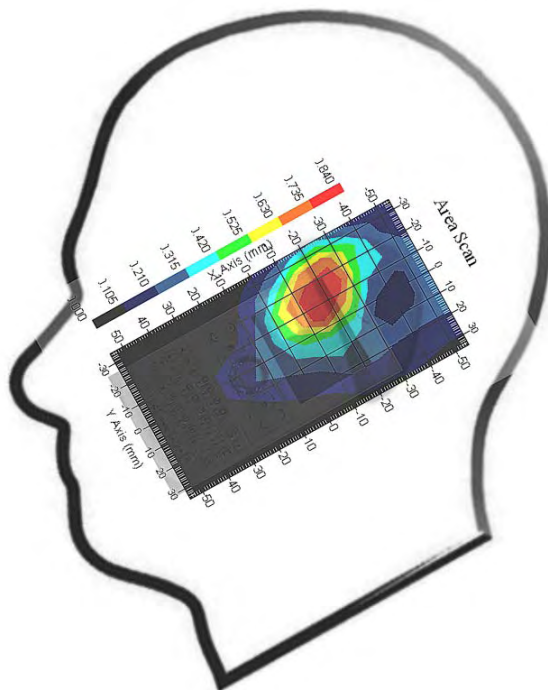

**Test Laboratory: Bay Area Compliance Lab Corp. (Shenzhen)**

**Right Head Tilt-Keyboard Front (1900 MHz Middle Channel)**

Measurement Data

Test mode : GSM  
 Crest Factor : 8  
 Scan Type : Complete  
 Area Scan : 13x9x1 : Measurement x=10mm, y=10mm, z=4mm  
 Zoom Scan : 7x7x7 : Measurement x=5mm, y=5mm, z=5mm  
 Power Drift-Start : 0.286 W/kg  
 Power Drift-Finish : 0.277 W/kg  
 Power Drift (%) : -3.168

Tissue Data

Type : HEAD  
 Frequency : 1900.00 MHz  
 Epsilon : 40.12 F/m  
 Sigma : 1.41 S/m  
 Density : 1000.00 kg/cu. m

Probe Data

Serial No. : 500-00283  
 Frequency : 1900.00 MHz  
 Duty Cycle Factor : 8  
 Conversion Factor : 5.2  
 Probe Sensitivity : 1.20 1.20 1.20  $\mu\text{V}/(\text{V}/\text{m})^2$   
 Compression Point : 95.00 mV  
 Offset : 1.56 mm

1 gram SAR value : 0.471 W/kg  
 10 gram SAR value : 0.245 W/kg  
 Area Scan Peak SAR : 0.500 W/kg  
 Zoom Scan Peak SAR : 1.231 W/kg

**Plot 24#**

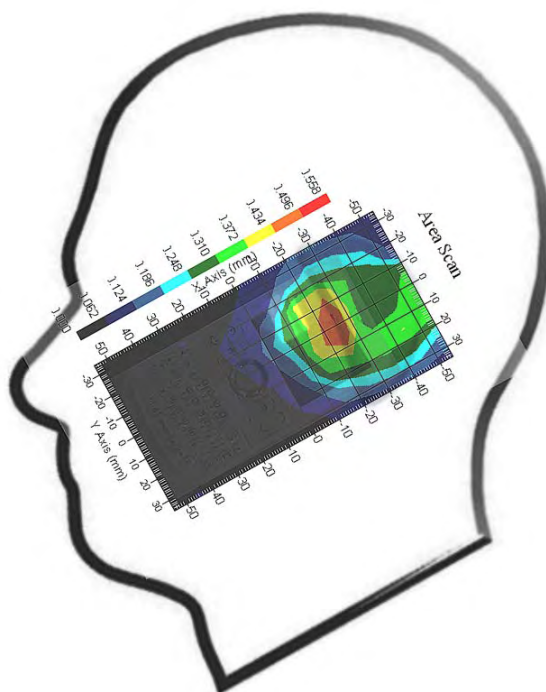

**Test Laboratory: Bay Area Compliance Lab Corp. (Shenzhen)**

**Body-worn Headset-Keyboard Back (1900 MHz Middle Channel)**

Measurement Data

Test mode : GSM  
 Crest Factor : 8  
 Scan Type : Complete  
 Area Scan : 13x9x1 : Measurement x=10mm, y=10mm, z=4mm  
 Zoom Scan : 7x7x7 : Measurement x=5mm, y=5mm, z=5mm  
 Power Drift-Start : 0.299 W/kg  
 Power Drift-Finish : 0.301 W/kg  
 Power Drift (%) : 2.476

Tissue Data

Type : Body  
 Frequency : 1900.00 MHz  
 Epsilon : 54.01 F/m  
 Sigma : 1.49 S/m  
 Density : 1000.00 kg/cu. m

Probe Data

Serial No. : 500-00283  
 Frequency : 1900.00 MHz  
 Duty Cycle Factor : 8  
 Conversion Factor : 5.0  
 Probe Sensitivity : 1.20 1.20 1.20  $\mu\text{V}/(\text{V}/\text{m})^2$   
 Compression Point : 95.00 mV  
 Offset : 1.56 mm

1 gram SAR value : 0.569 W/kg  
 10 gram SAR value : 0.292 W/kg  
 Area Scan Peak SAR : 0.598 W/kg  
 Zoom Scan Peak SAR : 0.950 W/kg

**Plot 25#**

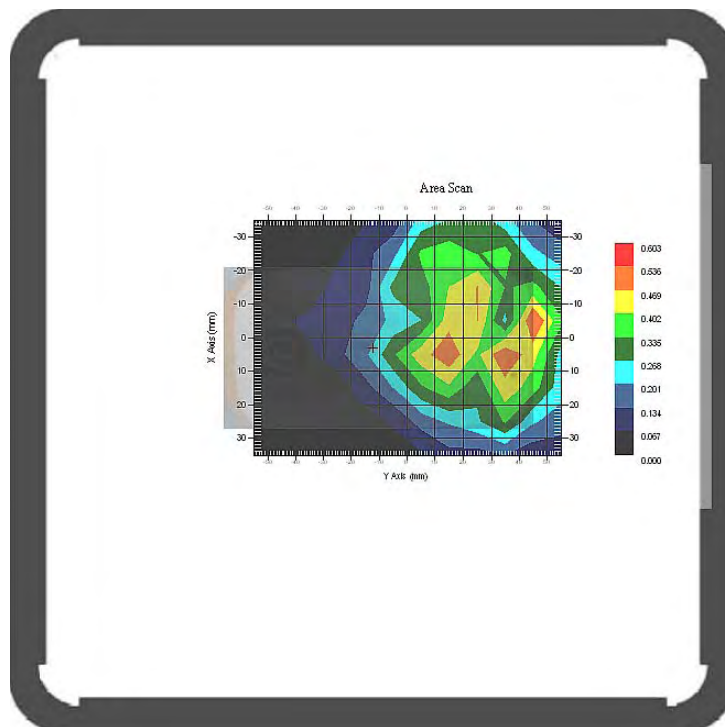

**Test Laboratory: Bay Area Compliance Lab Corp. (Shenzhen)**

**Body-worn Headset-Keyboard Front (1900 MHz Middle Channel)**

Measurement Data

Test mode : GSM  
 Crest Factor : 8  
 Scan Type : Complete  
 Area Scan : 13x9x1 : Measurement x=10mm, y=10mm, z=4mm  
 Zoom Scan : 7x7x7 : Measurement x=5mm, y=5mm, z=5mm  
 Power Drift-Start : 0.258 W/kg  
 Power Drift-Finish : 0.256 W/kg  
 Power Drift (%) : -0.839

Tissue Data

Type : Body  
 Frequency : 1900.00 MHz  
 Epsilon : 54.01 F/m  
 Sigma : 1.49 S/m  
 Density : 1000.00 kg/cu. m

Probe Data

Serial No. : 500-00283  
 Frequency : 1900.00 MHz  
 Duty Cycle Factor : 8  
 Conversion Factor : 5.0  
 Probe Sensitivity : 1.20 1.20 1.20  $\mu\text{V}/(\text{V}/\text{m})^2$   
 Compression Point : 95.00 mV  
 Offset : 1.56 mm

1 gram SAR value : 0.619 W/kg  
 10 gram SAR value : 0.232 W/kg  
 Area Scan Peak SAR : 0.701 W/kg  
 Zoom Scan Peak SAR : 1.241 W/kg

**Plot 26#**

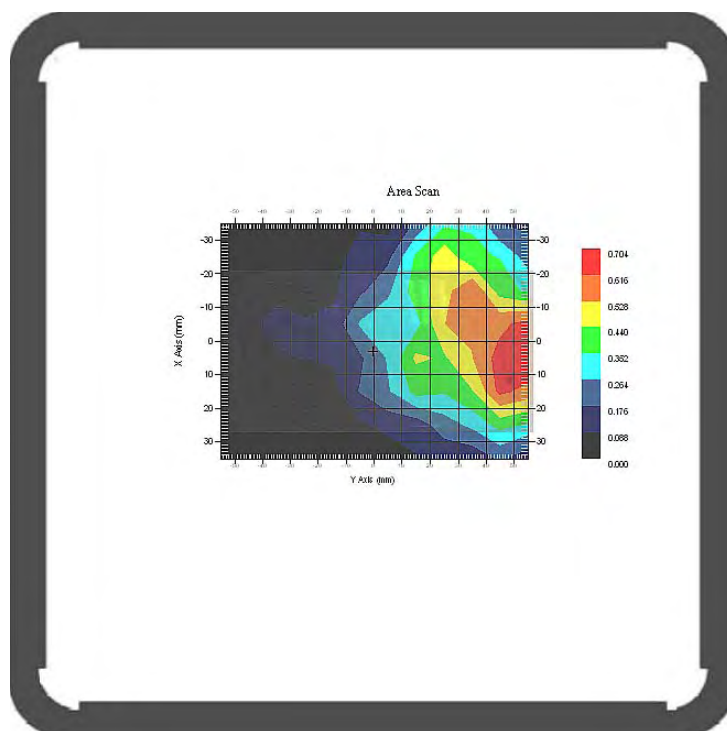

**Test Laboratory: Bay Area Compliance Lab Corp. (Shenzhen)**

**Body-worn Keyboard Back (1900 MHz Low Channel)**

Measurement Data

Test mode : GPRS  
 Crest Factor : 2  
 Scan Type : Complete  
 Area Scan : 13x9x1 : Measurement x=10mm, y=10mm, z=4mm  
 Zoom Scan : 7x7x7 : Measurement x=5mm, y=5mm, z=5mm  
 Power Drift-Start : 0.697 W/kg  
 Power Drift-Finish : 0.685 W/kg  
 Power Drift (%) : -4.584

Tissue Data

Type : Body  
 Frequency : 1900.00 MHz  
 Epsilon : 54.01 F/m  
 Sigma : 1.49 S/m  
 Density : 1000.00 kg/cu. m

Probe Data

Serial No. : 500-00283  
 Frequency : 1900.00 MHz  
 Duty Cycle Factor : 2  
 Conversion Factor : 5.0  
 Probe Sensitivity : 1.20 1.20 1.20  $\mu\text{V}/(\text{V}/\text{m})^2$   
 Compression Point : 95.00 mV  
 Offset : 1.56 mm

1 gram SAR value : 1.242 W/kg  
 10 gram SAR value : 0.704 W/kg  
 Area Scan Peak SAR : 1.385 W/kg  
 Zoom Scan Peak SAR : 2.161 W/kg

**Plot 27#**

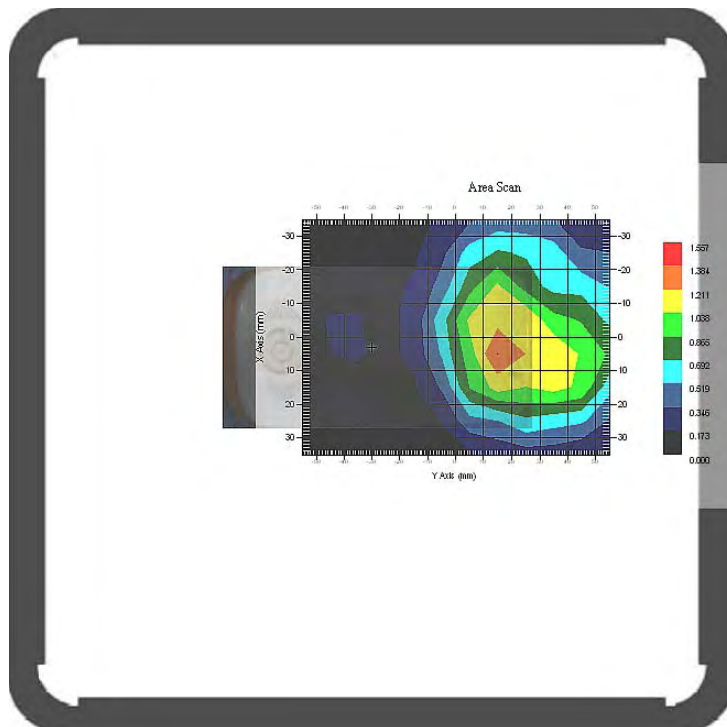



**Test Laboratory: Bay Area Compliance Lab Corp. (Shenzhen)**

**Body-worn Keyboard Back (1900 MHz Middle Channel)**

Measurement Data

Test mode : GPRS  
 Crest Factor : 2  
 Scan Type : Complete  
 Area Scan : 13x9x1 : Measurement x=10mm, y=10mm, z=4mm  
 Zoom Scan : 7x7x7 : Measurement x=5mm, y=5mm, z=5mm  
 Power Drift-Start : 0.653 W/kg  
 Power Drift-Finish : 0.662 W/kg  
 Power Drift (%) : 3.765

Tissue Data

Type : Body  
 Frequency : 1900.00 MHz  
 Epsilon : 54.01 F/m  
 Sigma : 1.49 S/m  
 Density : 1000.00 kg/cu. m

Probe Data

Serial No. : 500-00283  
 Frequency : 1900.00 MHz  
 Duty Cycle Factor : 2  
 Conversion Factor : 5.0  
 Probe Sensitivity : 1.20 1.20 1.20  $\mu\text{V}/(\text{V}/\text{m})^2$   
 Compression Point : 95.00 mV  
 Offset : 1.56 mm

1 gram SAR value : 1.354 W/kg  
 10 gram SAR value : 0.747 W/kg  
 Area Scan Peak SAR : 1.309 W/kg  
 Zoom Scan Peak SAR : 2.432 W/kg

**Plot 28#**

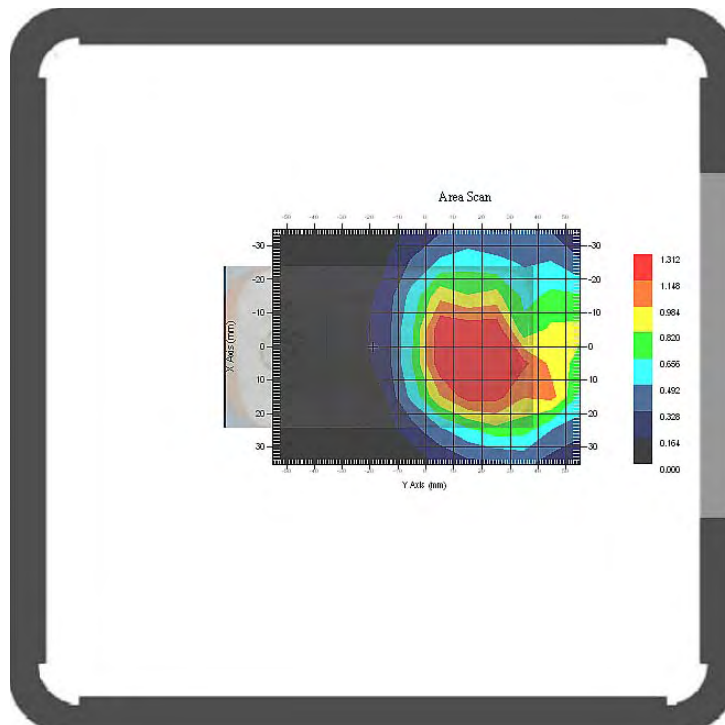

**Test Laboratory: Bay Area Compliance Lab Corp. (Shenzhen)**

**Body-worn Keyboard Back (1900 MHz High Channel)**

Measurement Data

Test mode : GPRS  
 Crest Factor : 2  
 Scan Type : Complete  
 Area Scan : 13x9x1 : Measurement x=10mm, y=10mm, z=4mm  
 Zoom Scan : 7x7x7 : Measurement x=5mm, y=5mm, z=5mm  
 Power Drift-Start : 0.719 W/kg  
 Power Drift-Finish : 0.715 W/kg  
 Power Drift (%) : -1.967

Tissue Data

Type : Body  
 Frequency : 1900.00 MHz  
 Epsilon : 54.01 F/m  
 Sigma : 1.49 S/m  
 Density : 1000.00 kg/cu. m

Probe Data

Serial No. : 500-00283  
 Frequency : 1900.00 MHz  
 Duty Cycle Factor : 2  
 Conversion Factor : 5.0  
 Probe Sensitivity : 1.20 1.20 1.20  $\mu\text{V}/(\text{V}/\text{m})^2$   
 Compression Point : 95.00 mV  
 Offset : 1.56 mm

1 gram SAR value : 1.355 W/kg  
 10 gram SAR value : 0.771 W/kg  
 Area Scan Peak SAR : 1.495 W/kg  
 Zoom Scan Peak SAR : 2.342 W/kg

**Plot 29#**

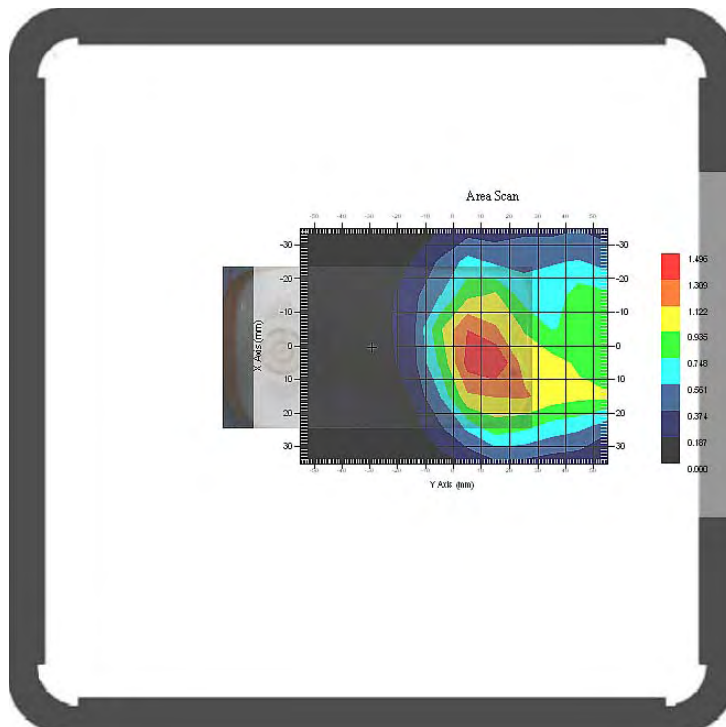

**Test Laboratory: Bay Area Compliance Lab Corp. (Shenzhen)**

**Body-worn Keyboard Front (1900 MHz Low Channel)**

Measurement Data

Test mode : GPRS  
 Crest Factor : 2  
 Scan Type : Complete  
 Area Scan : 13x9x1 : Measurement x=10mm, y=10mm, z=4mm  
 Zoom Scan : 7x7x7 : Measurement x=5mm, y=5mm, z=5mm  
 Power Drift-Start : 0.753 W/kg  
 Power Drift-Finish : 0.752 W/kg  
 Power Drift (%) : -0.811

Tissue Data

Type : Body  
 Frequency : 1900.00 MHz  
 Epsilon : 54.01 F/m  
 Sigma : 1.49 S/m  
 Density : 1000.00 kg/cu. m

Probe Data

Serial No. : 500-00283  
 Frequency : 1900.00 MHz  
 Duty Cycle Factor : 2  
 Conversion Factor : 5.0  
 Probe Sensitivity : 1.20 1.20 1.20  $\mu\text{V}/(\text{V}/\text{m})^2$   
 Compression Point : 95.00 mV  
 Offset : 1.56 mm

1 gram SAR value : 1.134 W/kg  
 10 gram SAR value : 0.623 W/kg  
 Area Scan Peak SAR : 1.190 W/kg  
 Zoom Scan Peak SAR : 1.921 W/kg

**Plot 30#**

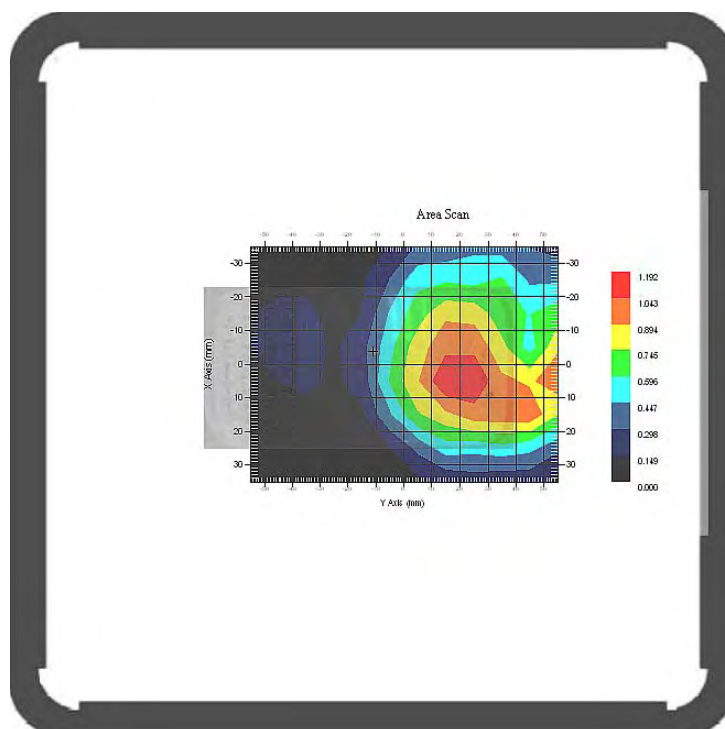

**Test Laboratory: Bay Area Compliance Lab Corp. (Shenzhen)**

**Body-worn Keyboard Front (1900 MHz Middle Channel)**

Measurement Data

Test mode : GPRS  
 Crest Factor : 2  
 Scan Type : Complete  
 Area Scan : 13x9x1 : Measurement x=10mm, y=10mm, z=4mm  
 Zoom Scan : 7x7x7 : Measurement x=5mm, y=5mm, z=5mm  
 Power Drift-Start : 0.874 W/kg  
 Power Drift-Finish : 0.885 W/kg  
 Power Drift (%) : 3.711

Tissue Data

Type : Body  
 Frequency : 1900.00 MHz  
 Epsilon : 54.01 F/m  
 Sigma : 1.49 S/m  
 Density : 1000.00 kg/cu. m

Probe Data

Serial No. : 500-00283  
 Frequency : 1900.00 MHz  
 Duty Cycle Factor : 2  
 Conversion Factor : 5.0  
 Probe Sensitivity : 1.20 1.20 1.20  $\mu\text{V}/(\text{V}/\text{m})^2$   
 Compression Point : 95.00 mV  
 Offset : 1.56 mm

1 gram SAR value : 1.200 W/kg  
 10 gram SAR value : 0.659 W/kg  
 Area Scan Peak SAR : 1.334 W/kg  
 Zoom Scan Peak SAR : 2.191 W/kg

**Plot 31#**

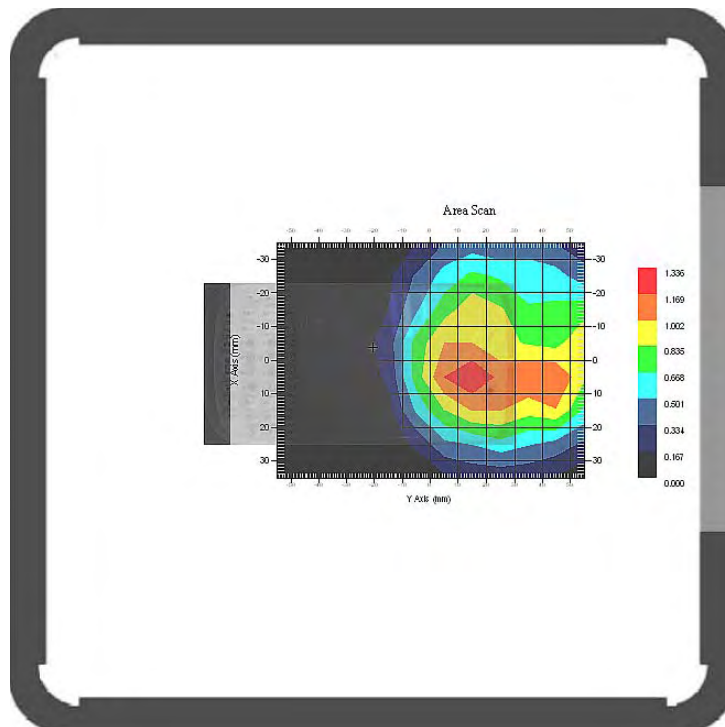

**Test Laboratory: Bay Area Compliance Lab Corp. (Shenzhen)**

**Body-worn Keyboard Front (1900 MHz High Channel)**

Measurement Data

Test mode : GPRS  
 Crest Factor : 2  
 Scan Type : Complete  
 Area Scan : 13x9x1 : Measurement x=10mm, y=10mm, z=4mm  
 Zoom Scan : 7x7x7 : Measurement x=5mm, y=5mm, z=5mm  
 Power Drift-Start : 0.334 W/kg  
 Power Drift-Finish : 0.339 W/kg  
 Power Drift (%) : 1.305

Tissue Data

Type : Body  
 Frequency : 1900.00 MHz  
 Epsilon : 54.01 F/m  
 Sigma : 1.49 S/m  
 Density : 1000.00 kg/cu. m

Probe Data

Serial No. : 500-00283  
 Frequency : 1900.00 MHz  
 Duty Cycle Factor : 2  
 Conversion Factor : 5.0  
 Probe Sensitivity : 1.20 1.20 1.20  $\mu\text{V}/(\text{V}/\text{m})^2$   
 Compression Point : 95.00 mV  
 Offset : 1.56 mm

1 gram SAR value : 1.281 W/kg  
 10 gram SAR value : 0.710 W/kg  
 Area Scan Peak SAR : 1.359 W/kg  
 Zoom Scan Peak SAR : 2.272 W/kg

**Plot 32#**

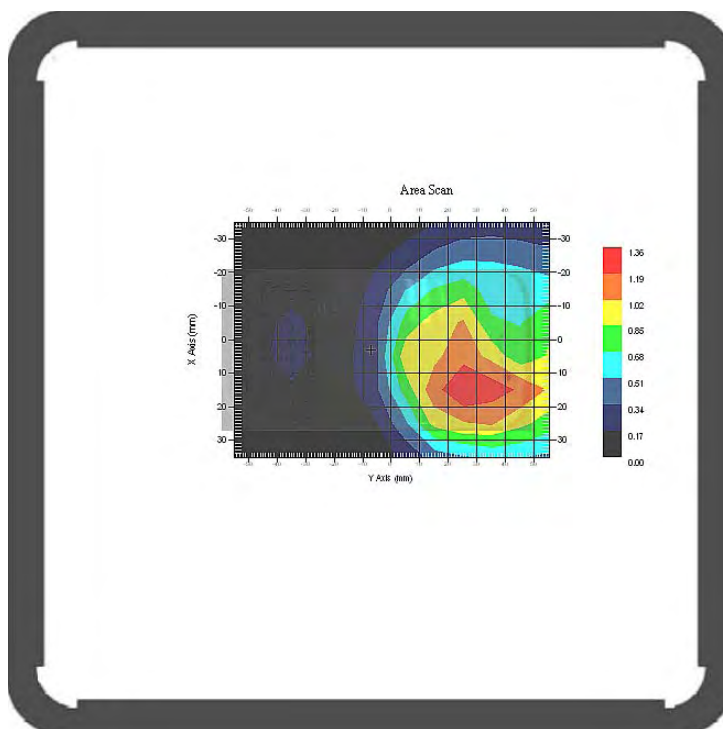

**APPENDIX A – MEASUREMENT UNCERTAINTY**

The uncertainty budget has been determined for the measurement system and is given in the following Table.

**Measurement Uncertainty for 300MHz to 3GHz**

Source of Uncertainty	Tolerance Value	Probability Distribution	Divisor	$c_i^1$ (1-g)	$c_i^1$ (10-g)	Standard Uncertainty (1-g) %	Standard Uncertainty (10-g) %
<b>Measurement System</b>							
Probe Calibration	3.5	normal	1	1	1	3.5	3.5
Axial Isotropy	3.7	rectangular	$\sqrt{3}$	$(1-cp)^{1/2}$	$(\frac{1-cp}{2})^{1/2}$	1.5	1.5
Hemispherical Isotropy	10.9	rectangular	$\sqrt{3}$	$\sqrt{cp}$	$\sqrt{cp}$	4.4	4.4
Boundary Effect	1.0	rectangular	$\sqrt{3}$	1	1	0.6	0.6
Linearity	4.7	rectangular	$\sqrt{3}$	1	1	2.7	2.7
Detection Limit	1.0	rectangular	$\sqrt{3}$	1	1	0.6	0.6
Readout Electronics	1.0	normal	1	1	1	1.0	1.0
Response Time	0.8	rectangular	$\sqrt{3}$	1	1	0.5	0.5
Integration Time	1.7	rectangular	$\sqrt{3}$	1	1	1.0	1.0
RF Ambient Condition -Noise	3.0	rectangular	$\sqrt{3}$	1	1	1.7	1.7
RF Ambient Condition - Reflections	3.0	rectangular	$\sqrt{3}$	1	1	1.7	1.7
Probe Positioner Mech. Restrictions	0.4	rectangular	$\sqrt{3}$	1	1	0.2	0.2
<b>Restriction</b>							
Probe Positioning with respect to Phantom Shell	2.9	rectangular	$\sqrt{3}$	1	1	1.7	1.7
Extrapolation and Integration	3.7	rectangular	$\sqrt{3}$	1	1	2.1	2.1
Test Sample Positioning	4.0	normal	1	1	1	4.0	4.0
Device Holder Uncertainty	2.0	normal	1	1	1	2.0	2.0
Drift of Output Power	0.4	rectangular	$\sqrt{3}$	1	1	0.2	0.2
<b>Phantom and Setup</b>							
Phantom Uncertainty(shape & thickness tolerance)	3.4	rectangular	$\sqrt{3}$	1	1	2.0	2.0
Liquid Conductivity(target)	5.0	rectangular	$\sqrt{3}$	0.7	0.5	2.0	1.4
Liquid Conductivity(meas.)	2.6	normal	1	0.7	0.5	1.8	1.3
Liquid Permittivity(target)	5.0	rectangular	$\sqrt{3}$	0.6	0.5	1.7	1.4
Liquid Permittivity(meas.)	2.7	normal	1	0.6	0.5	1.6	1.4
Combined Uncertainty		RSS				9.7	9.4
Combined Uncertainty (coverage factor=2)		Normal(k=2)				19.4	18.8

**APPENDIX B – PROBE CALIBRATION CERTIFICATES**

**NCL CALIBRATION LABORATORIES**

Calibration File No.: 1251-1258

Client.: BA CL Lab

**CERTIFICATE OF CALIBRATION**

It is certified that the equipment identified below has been calibrated in the **NCL CALIBRATION LABORATORIES** by qualified personnel following recognized procedures and using transfer standards traceable to NRC/NIST.

Equipment: Miniature Isotropic RF Probe

Record of Calibration

Head and Body

Manufacturer: APREL Laboratories

Model No.: E-020

Serial No.: 500-00283

Calibration Procedure: D01-032-E020-V2, D22-012-Tissue, D28-002-Dipole  
Project No: BA CL-5607

Calibrated: 14<sup>th</sup> July 2011

Released on: 14<sup>th</sup> July 2011

Approved By: Stuart Nicol

This Calibration Certificate is Incomplete Unless Accompanied with the Calibration Results Summary

Released By: \_\_\_\_\_

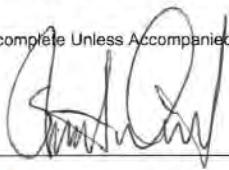

**NCL CALIBRATION LABORATORIES**

303 Terry Fox Drive, Suite 102  
Kanata, Ontario  
CANADA K2K 3J1

Division of APREL  
TEL: (613) 435-8300  
FAX: (613) 435-8306



**NCL Calibration Laboratories**

Division of APREL Inc.

**Introduction**

This Calibration Report reproduces the results of the calibration performed in line with the references listed below. Calibration is performed using accepted methodologies as per the references listed below. Probes are calibrated for air, and tissue and the values reported are the results from the physical quantification of the probe through meteorological practices.

**Calibration Method**

Probes are calibrated using the following methods.

<1000MHz

TEM Cell for sensitivity in air

Standard phantom using temperature transfer method for sensitivity in tissue

>1000MHz

Waveguide\* method to determine sensitivity in air and tissue

\*Waveguide is numerically (simulation) assessed to determine the field distribution and power

The boundary effect for the probe is assessed using a standard flat phantom where the probe output is compared against a numerically simulated series of data points

**References**

- o IEEE Standard 1528 (2003) including Amendment 1  
IEEE Recommended Practice for Determining the Peak Spatial-Average Specific Absorption Rate (SAR) in the Human Head from Wireless Communications Devices: Measurement Techniques
- o EN 62209-1 (2006)  
Human Exposure to RF Fields from hand-held and body-mounted wireless communication devices - Human models, instrumentation, and procedures-Part 1: Procedure to measure the Specific Absorption Rate (SAR) for hand-held mobile wireless devices
- o IEC 62209-2 Ed. 1.0 (2010-03)  
Human exposure to RF fields from hand-held and body-mounted wireless devices - Human models, instrumentation, and procedures - Part 2: specific absorption rate (SAR) for wireless communication devices (30 MHz - 6 GHz)
- o TP-D01-032-E020-V2 E-Field probe calibration procedure
- o D22-012-Tissue dielectric tissue calibration procedure
- o D28-002-Dipole procedure for validation of SAR system using a dipole
- o IEEE 1309 Draft Standard for Calibration of Electromagnetic Field Sensors and Probes, Excluding Antennas, from 9kHz to 40GHz

---

Page 2 of 10

This page has been reviewed for content and attested to on Page 2 of this document.



**NCL Calibration Laboratories**

Division of APREL Inc.

**Conditions**

Probe 500-00283 was a new probe taken from stock.

**Ambient Temperature of the Laboratory:** 22 °C +/- 1.5°C

**Temperature of the Tissue:** 21 °C +/- 1.5°C

**Relative Humidity:** < 60%

**Primary Measurement Standards**

Instrument	Serial Number	Cal due date
Power meter Anritsu MA2408A	90025437	Nov.4, 2011
Power Sensor Anritsu MA2481D	103555	Nov 4, 2011
Attenuator HP 8495A (70dB)	1944A10711	Sept. 14, 2011
Network Analyzer Anritsu MT8801C	MB11855	Feb. 8, 2012

**Secondary Measurement Standards**

Signal Generator Agilent E4438C -506	MY55182336	June 7, 2012
--------------------------------------	------------	--------------

**Attestation**

The below named signatories have conducted the calibration and review of the data which is presented in this calibration report.

**We the undersigned attest that to the best of our knowledge the calibration of this probe has been accurately conducted and that all information contained within this report has been reviewed for accuracy.**

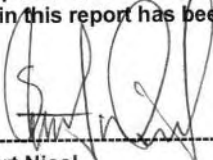

-----  
Stuart Nicol

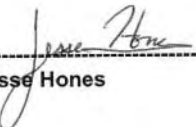

-----  
Jesse Hones

Page 3 of 10  
This page has been reviewed for content and attested to on Page 2 of this document.

**NCL Calibration Laboratories**

Division of APREL Inc.

**Probe Summary**

<b>Probe Type:</b>	E-Field Probe E020
<b>Serial Number:</b>	500-00283
<b>Frequency:</b>	As presented on page 5
<b>Sensor Offset:</b>	1.56
<b>Sensor Length:</b>	2.5
<b>Tip Enclosure:</b>	Composite*
<b>Tip Diameter:</b>	< 2.9 mm
<b>Tip Length:</b>	55 mm
<b>Total Length:</b>	289 mm

\*Resistive to recommended tissue recipes per IEEE-1528

**Sensitivity in Air**

<b>Channel X:</b>	1.2 $\mu\text{V}/(\text{V}/\text{m})^2$
<b>Channel Y:</b>	1.2 $\mu\text{V}/(\text{V}/\text{m})^2$
<b>Channel Z:</b>	1.2 $\mu\text{V}/(\text{V}/\text{m})^2$

**Diode Compression Point:** 95 mV

---

Page 4 of 10

This page has been reviewed for content and attested to on Page 2 of this document.

**NCL Calibration Laboratories**

Division of APREL Inc.

Calibration for Tissue (Head H, Body B)

Frequency	Tissue Type	Measured Epsilon	Measured Sigma	Calibration Uncertainty	Tolerance Uncertainty for 5%*	Conversion Factor
450 H	Head	X	X	X	X	X
450 B	Body	X	X	X	X	X
750 H	Head	X	X	X	X	X
750 B	Body	X	X	X	X	X
835 H	Head	42.35	0.938	3.5	3.4	6.6
835 B	Body	56.65	1.018	3.5	3.4	6.6
900 H	Head	41.35	0.98	3.5	3.4	6
900 B	Body	56.08	1.05	3.5	3.4	6
1450 H	Head	X	X	X	X	X
1450 B	Body	X	X	X	X	X
1500 H	Head	X	X	X	X	X
1500 B	Body	X	X	X	X	X
1640 H	Head	X	X	X	X	X
1640 B	Body	X	X	X	X	X
1750 H	Head	38.72	1.35	3.5	3.4	5.1
1750 B	Body	51.62	1.48	3.5	3.4	4.8
1800 H	Head	X	X	X	X	X
1800 B	Body	X	X	X	X	X
1900 H	Head	38.72	1.35	3.5	2.7	5.2
1900 B	Body	51.62	1.48	3.5	2.7	5
2000 H	Head	X	X	X	X	X
2000 B	Body	X	X	X	X	X
2100 H	Head	X	X	X	X	X
2100 B	Body	X	X	X	X	X
2300 H	Head	X	X	X	X	X
2300 B	Body	X	X	X	X	X
2450 H	Head	38.06	1.87	3.5	3.5	4.9
2450 B	Body	50.22	2.03	3.5	3.5	4.3
2600 H	Head	X	X	X	X	X
2600 B	Body	X	X	X	X	X
3000 H	Head	X	X	X	X	X
3000 B	Body	X	X	X	X	X
3600 H	Head	X	X	X	X	X
3600 B	Body	X	X	X	X	X
5200 H	Head	X	X	X	X	X
5200 B	Body	X	X	X	X	X
5600 H	Head	X	X	X	X	X
5600 B	Body	X	X	X	X	X
5800 H	Head	X	X	X	X	X
5800 B	Body	X	X	X	X	X

**NCL Calibration Laboratories**

Division of APREL Inc.

**Boundary Effect:**

Uncertainty resulting from the boundary effect is less than 2.1% for the distance between the tip of the probe and the tissue boundary, when less than 0.58mm.

**Spatial Resolution:**

The spatial resolution uncertainty is less than 1.5% for 4.9mm diameter probe.  
The spatial resolution uncertainty is less than 1.0% for 2.5mm diameter probe.

**DAQ-PAQ Contribution**

To minimize the uncertainty calculation all tissue sensitivity values were calculated using a load impedance of 5 MΩ.

**Boundary Effect:**

For a distance of 0.58mm the worst case evaluated uncertainty (increase in the probe sensitivity) is less than 2.1%.

**NOTES:**

\*The maximum deviation from the centre frequency when comparing the lower to upper range is listed.

---

Page 6 of 10

This page has been reviewed for content and attested to on Page 2 of this document.

**NCL Calibration Laboratories**

Division of APREL Inc.

**Receiving Pattern Air**

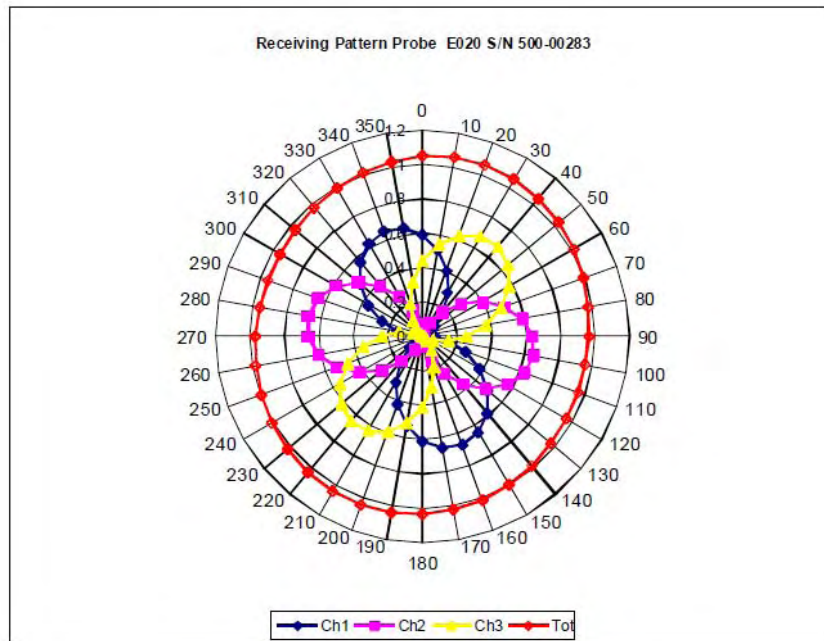

**NCL Calibration Laboratories**

Division of APREL Inc.

**Isotropy Error Air**

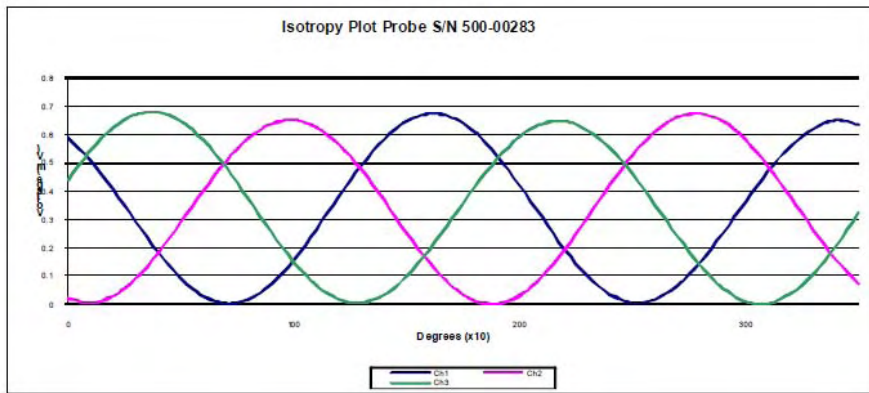
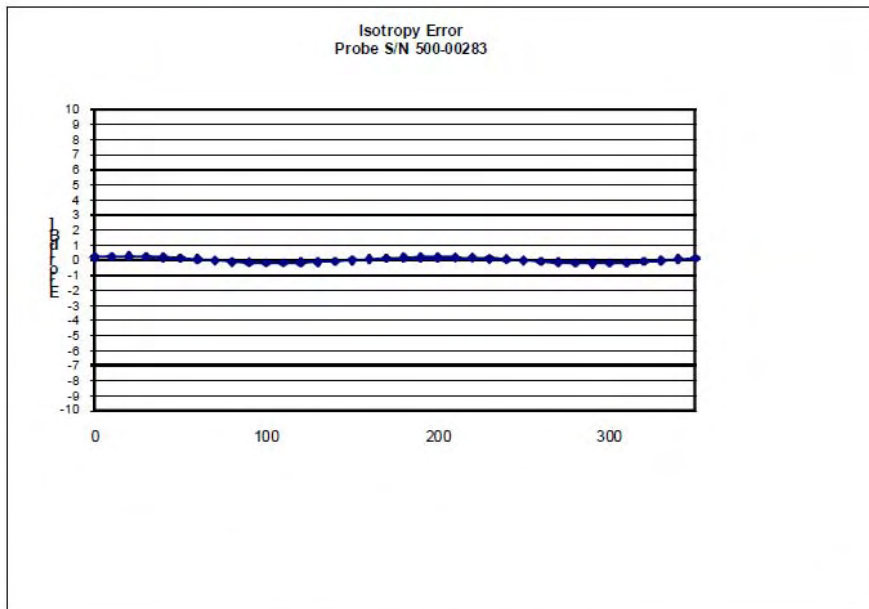

**Isotropicity Tissue:** 0.10 dB

Page 8 of 10  
This page has been reviewed for content and attested to on Page 2 of this document.



**NCL Calibration Laboratories**

Division of APREL Inc.

**Dynamic Range**

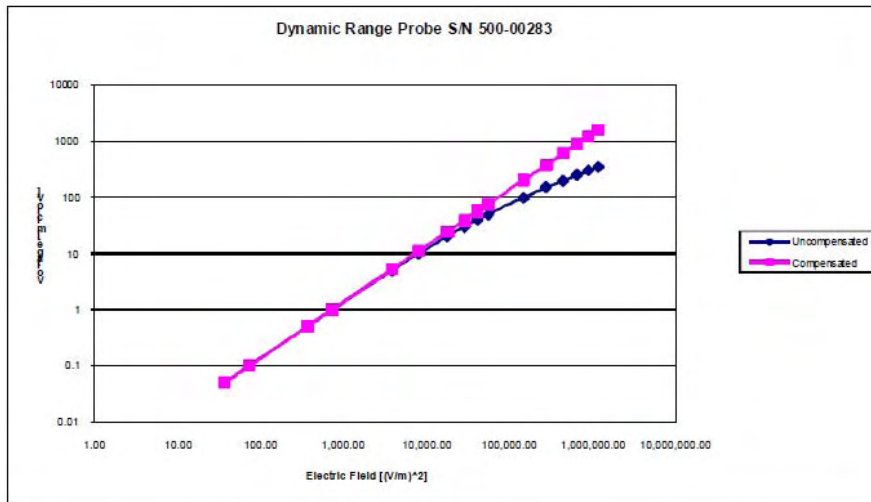

**NCL Calibration Laboratories**

Division of APREL Inc.

**Video Bandwidth**

Probe Frequency Characteristics

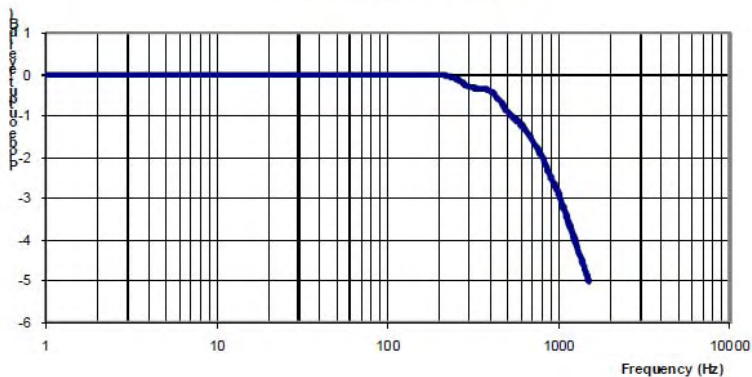

Video Bandwidth at 500 Hz                    1 dB  
Video Bandwidth at 1.02 KHz:            3 dB

**Test Equipment**

The test equipment used during Probe Calibration, manufacturer, model number and, current calibration status are listed and located on the main APREL server R:\NCL\Calibration Equipment\Instrument List May 2011.

---

Page 10 of 10  
This page has been reviewed for content and attested to on Page 2 of this document.



**APPENDIX C – DIPOLE CALIBRATION CERTIFICATES**

**NCL CALIBRATION LABORATORIES**

Calibration File No: DC-1327  
Project Number: BAC-dipole-cal-5618

**CERTIFICATE OF CALIBRATION**

It is certified that the equipment identified below has been calibrated in the **NCL CALIBRATION LABORATORIES** by qualified personnel following recognized procedures and using transfer standards traceable to NRC/NIST.

Validation Dipole(Head and Body)

Manufacturer: APREL Laboratories  
Part number: ALS-D-835-S-2  
Frequency: 835 MHz  
Serial No: 180-00558

Customer: Bay Area Compliance Laboratory

Calibrated: 25<sup>th</sup> August 2011  
Released on: 25<sup>th</sup> August 2011

This Calibration Certificate is Incomplete Unless Accompanied with the Calibration Results Summary

Released By: \_\_\_\_\_

**NCL CALIBRATION LABORATORIES**

Suite 102, 303 Terry Fox Dr.  
Kanata, ONTARIO  
CANADA K2K 3J1

Division of APREL Lab.  
TEL: (613) 435-8300  
FAX: (613)435-8306

**NCL Calibration Laboratories**

Division of APREL Laboratories.

**Conditions**

Dipole 180-00558 was received in good condition and a re-calibration.

**Ambient Temperature of the Laboratory:** 22 °C +/- 0.5°C

**Temperature of the Tissue:** 21 °C +/- 0.5°C

We the undersigned attest that to the best of our knowledge the calibration of this device has been accurately conducted and that all information contained within this report has been reviewed for accuracy.

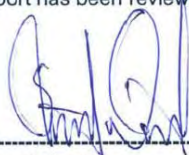

-----  
Stuart Nicol



-----  
C. Teodorian

<b>Primary Measurement Standards</b>	<b>Serial Number</b>	<b>Cal due date</b>
<b>Instrument</b>		
Power meter Anritsu MA2408A	245025437	Nov.4, 2011
Power Sensor Anritsu MA2481D	103555	Nov 4, 2011
Attenuator HP 8495A (70dB) 1	944A10711	Aug.8, 2012
Network Analyzer Agilent E5071C	1334746J	Feb. 8, 2012
<b>Secondary Measurement Standards</b>		
Signal Generator Agilent E4438C	-506 MY55182336	June 7, 2012

This page has been reviewed for content and attested to by signature within this document.

**NCL Calibration Laboratories**

Division of APREL Laboratories.

**Calibration Results Summary**

The following results relate the Calibrated Dipole and should be used as a quick reference for the user.

**Mechanical Dimensions**

**Length:** 162.2 mm  
**Height:** 89.4 mm

**Electrical Specification**

Tissue	Frequency	SWR:	Return Loss	Impedance
Head	835 MHz	1.0417 U	-35.395dB	49.020 Ω
Body	835 MHz	1.1177 U	-25.424dB	55.435 Ω

**System Validation Results**

Tissue	Frequency	1 Gram	10 Gram	Peak
Head	835 MHz	9.590	6.003	15.013
Body	835 MHz	9.684	6.263	14.23

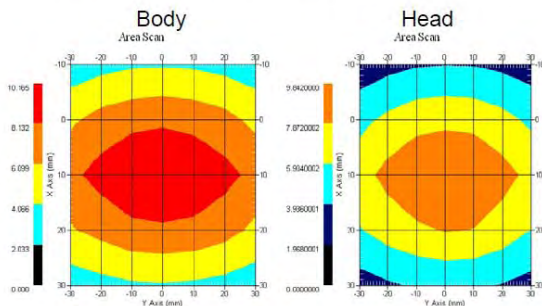

This page has been reviewed for content and attested to by signature within this document.

**NCL Calibration Laboratories**

Division of APREL Laboratories.

**Introduction**

This Calibration Report has been produced in line with the SSI Dipole Calibration Procedure SSI-TP-018-ALSAS. The results contained within this report are for Validation Dipole 180-00558. The calibration routine consisted of a three-step process. Step 1 was a mechanical verification of the dipole to ensure that it meets the mechanical specifications. Step 2 was an Electrical Calibration for the Validation Dipole, where the SWR, Impedance, and the Return loss were assessed. Step 3 involved a System Validation using the ALSAS-10U, along with APREL E-020 130 MHz to 26 GHz E-Field Probe Serial Number 212.

**References**

SSI-TP-018-ALSAS Dipole Calibration Procedure  
 SSI-TP-016 Tissue Calibration Procedure  
 IEEE 1528 "Recommended Practice for Determining the Peak Spatial-Average Specific Absorption Rate (SAR) in the Human Body Due to Wireless Communications Devices: Experimental Techniques"

**Conditions**

Dipole 180-00558 was new taken from stock.

**Ambient Temperature of the Laboratory:** 22 °C +/- 0.5°C  
**Temperature of the Tissue:** 20 °C +/- 0.5°C

**Dipole Calibration uncertainty**

The calibration uncertainty for the dipole is made up of various parameters presented below.

<b>Mechanical</b>	1%
<b>Positioning Error</b>	1.22%
<b>Electrical</b>	1.7%
<b>Tissue</b>	2.2%
<b>Dipole Validation</b>	2.2%
<b>TOTAL</b>	<b>8.32% (16.64% K=2)</b>

This page has been reviewed for content and attested to by signature within this document.

**NCL Calibration Laboratories**

Division of APREL Laboratories.

**Dipole Calibration Results**

**Mechanical Verification**

APREL Length	APREL Height	Measured Length	Measured Height
161.0 mm	89.8 mm	162.2 mm	89.4 mm

Tissue Type	Return Loss:	SWR:	Impedance:
Head	-35.395 dB	1.0417 U	49.020Ω
Body	-25.454 dB	1.1177 U	55.435Ω

**Tissue Validation**

	Dielectric constant, $\epsilon_r$	Conductivity, $\sigma$ [S/m]
Head Tissue 835MHz	41.78	0.92
Body Tissue 835MHz	56.37	0.95

This page has been reviewed for content and attested to by signature within this document.

**NCL Calibration Laboratories**

Division of APREL Laboratories.

The Following Graphs are the results as displayed on the Vector Network Analyzer.

**S11 Parameter Return Loss**

**Head Tissue**

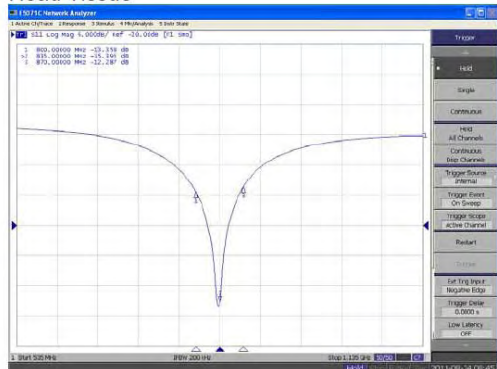

**Body Tissue**

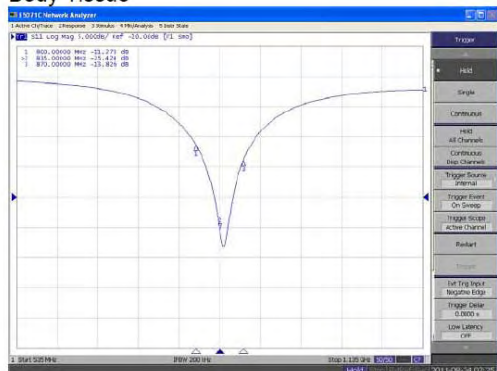

This page has been reviewed for content and attested to by signature within this document.



**NCL Calibration Laboratories**

Division of APREL Laboratories.

**SWR  
Head**

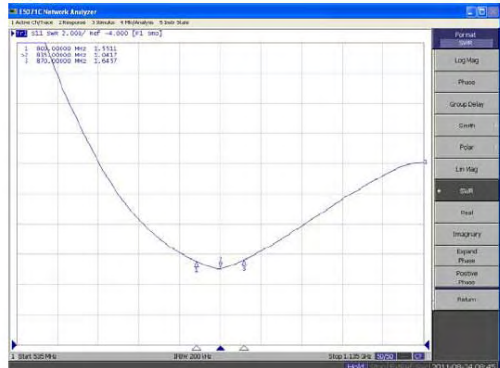

**Body**

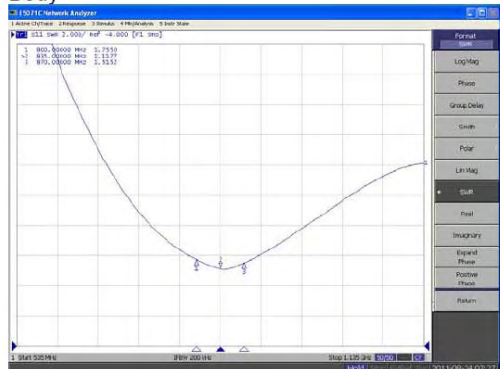

This page has been reviewed for content and attested to by signature within this document.

**NCL Calibration Laboratories**

Division of APREL Laboratories.

**Smith Chart Dipole Impedance**

**Head**

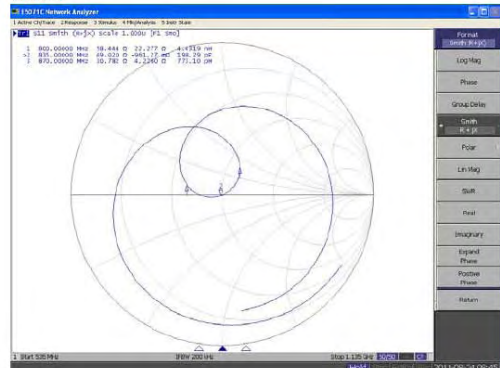

**Body**

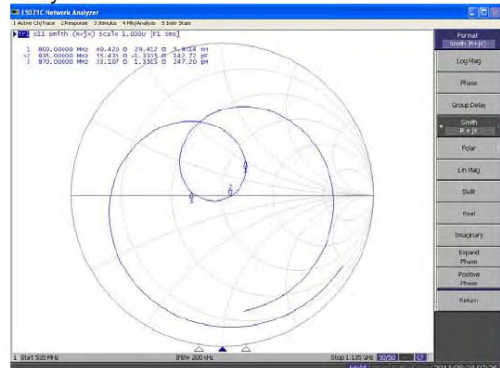

This page has been reviewed for content and attested to by signature within this document.



**NCL Calibration Laboratories**

Division of APREL Laboratories.

**Test Equipment**

The test equipment used during Probe Calibration, manufacturer, model number and, current calibration status are listed and located on the main APREL server R:\NCL\Calibration Equipment\Instrument List 2011.

This page has been reviewed for content and attested to by signature within this document.

9

**NCL CALIBRATION LABORATORIES**

Calibration File No: DC-1331  
Project Number: BAC-dipole –cal-5615

**CERTIFICATE OF CALIBRATION**

It is certified that the equipment identified below has been calibrated in the  
**NCL CALIBRATION LABORATORIES** by qualified personnel following recognized  
procedures and using transfer standards traceable to NRC/NIST.

Validation Dipole (Head & Body)

Manufacturer: APREL Laboratories  
Part number: ALS-D-1900-S-2  
Frequency: 1900 MHz  
Serial No: 210-00710

Customer: Bay Area Compliance Laboratory

Calibrated: 25<sup>th</sup> August, 2011  
Released on: 25<sup>th</sup> August, 2011

This Calibration Certificate is Incomplete Unless Accompanied with the Calibration Results Summary

Released By: \_\_\_\_\_

**NCL CALIBRATION LABORATORIES**

Suite 102, 303 Terry Fox Dr.  
Kanata, ONTARIO  
CANADA K2K 3J1

Division of APREL Lab.  
TEL: (613) 435-8300  
FAX: (613)435-8306

**NCL Calibration Laboratories**

Division of APREL Laboratories.

**Conditions**

Dipole 210-00710 was received in good condition and was a re-calibration.

**Ambient Temperature of the Laboratory:** 22 °C +/- 0.5°C

**Temperature of the Tissue:** 21 °C +/- 0.5°C

We the undersigned attest that to the best of our knowledge the calibration of this device has been accurately conducted and that all information contained within this report has been reviewed for accuracy.

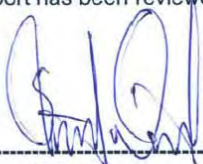

-----  
**Stuart Nicol**



-----  
**C. Teodorian**

**Primary Measurement Standards**

<b>Instrument</b>	<b>Serial Number</b>	<b>Cal due date</b>
Power meter Anritsu MA2408A	245025437	Nov.4, 2011
Power Sensor Anritsu MA2481D	103555	Nov 4, 2011
Attenuator HP 8495A (70dB) 1	944A10711	Aug.8, 2012
Network Analyzer Agilent E5071C	1334746J	Feb. 8, 2012
<b>Secondary Measurement Standards</b>		
Signal Generator Agilent E4438C	-506 MY55182336	June 7, 2012

This page has been reviewed for content and attested to by signature within this document.

**NCL Calibration Laboratories**

Division of APREL Laboratories.

**Calibration Results Summary**

The following results relate the Calibrated Dipole and should be used as a quick reference for the user.

**Mechanical Dimensions**

**Length:** 67.1 mm  
**Height:** 38.9 mm

**Electrical Specification**

Tissue	Frequency	SWR:	Return Loss	Impedance
Head	1900MHz	1.0417 U	-35.395dB	49.020 Ω
Body	1900MHz	1.1177 U	-25.424dB	55.435 Ω

**System Validation Results**

Tissue	Frequency	1 Gram	10 Gram	Peak
Head	1900 MHz	39.648	20.311	73.365
Body	1900 MHz	39.769	20.176	75.866

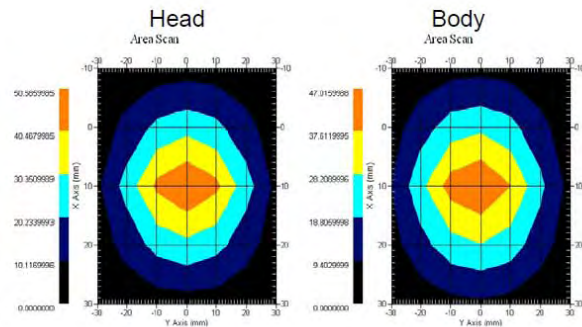

This page has been reviewed for content and attested to by signature within this document.

**NCL Calibration Laboratories**

Division of APREL Laboratories.

**Introduction**

This Calibration Report has been produced in line with the SSI Dipole Calibration Procedure SSI-TP-018-ALSAS. The results contained within this report are for Validation Dipole 210-00710. The calibration routine consisted of a three-step process. Step 1 was a mechanical verification of the dipole to ensure that it meets the mechanical specifications. Step 2 was an Electrical Calibration for the Validation Dipole, where the SWR, Impedance, and the Return loss were assessed. Step 3 involved a System Validation using the ALSAS-10U, along with APREL E-020 130 MHz to 26 GHz E-Field Probe Serial Number 212.

**References**

SSI-TP-018-ALSAS Dipole Calibration Procedure  
 SSI-TP-016 Tissue Calibration Procedure  
 IEEE 1528 "Recommended Practice for Determining the Peak Spatial-Average Specific Absorption Rate (SAR) in the Human Body Due to Wireless Communications Devices: Experimental Techniques"

**Conditions**

Dipole 210-00710 was new taken from stock.

**Ambient Temperature of the Laboratory:** 22 °C +/- 0.5°C  
**Temperature of the Tissue:** 20 °C +/- 0.5°C

**Dipole Calibration uncertainty**

The calibration uncertainty for the dipole is made up of various parameters presented below.

<b>Mechanical</b>	1%
<b>Positioning Error</b>	1.22%
<b>Electrical</b>	1.7%
<b>Tissue</b>	2.2%
<b>Dipole Validation</b>	2.2%
<b>TOTAL</b>	<b>8.32% (16.64% K=2)</b>

This page has been reviewed for content and attested to by signature within this document.

**NCL Calibration Laboratories**

Division of APREL Laboratories.

**Dipole Calibration Results**

**Mechanical Verification**

APREL Length	APREL Height	Measured Length	Measured Height
68.0 mm	39.5 mm	67.1mm	38.9 mm

**Electrical Validation**

Tissue Type	Return Loss:	SWR:	Impedance:
Head	-29.360 dB	1.0732 U	47.869 Ω
Body	-22.799 dB	1.1566 U	48.022 Ω

**Tissue Validation**

	Dielectric constant, $\epsilon_r$	Conductivity, $\sigma$ [S/m]
Head Tissue 1900MHz	38.4	1.43
Body Tissue 1900MHz	51.87	1.59

This page has been reviewed for content and attested to by signature within this document.



**NCL Calibration Laboratories**

Division of APREL Laboratories.

The Following Graphs are the results as displayed on the Vector Network Analyzer.

**S11 Parameter Return Loss**

Head

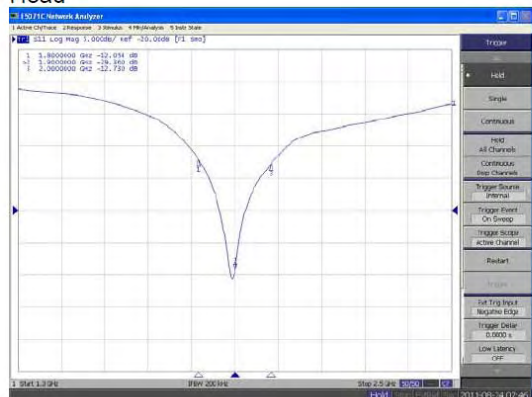

Body

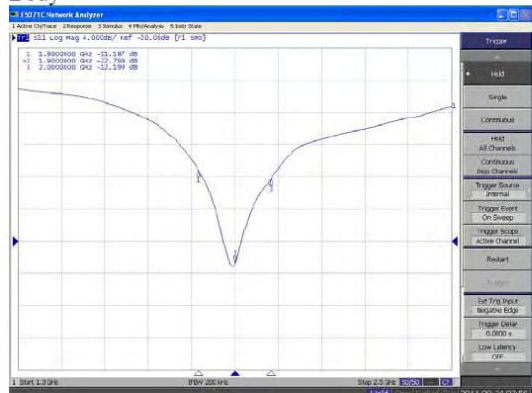

This page has been reviewed for content and attested to by signature within this document.

**NCL Calibration Laboratories**

Division of APREL Laboratories.

**SWR**

**Head**

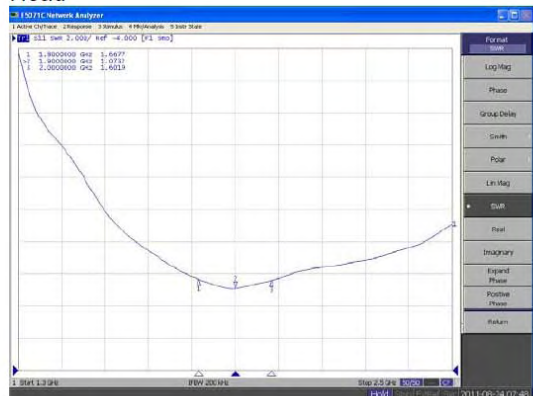

**Body**



This page has been reviewed for content and attested to by signature within this document.



**NCL Calibration Laboratories**

Division of APREL Laboratories.

**Smith Chart Dipole Impedance**

Head

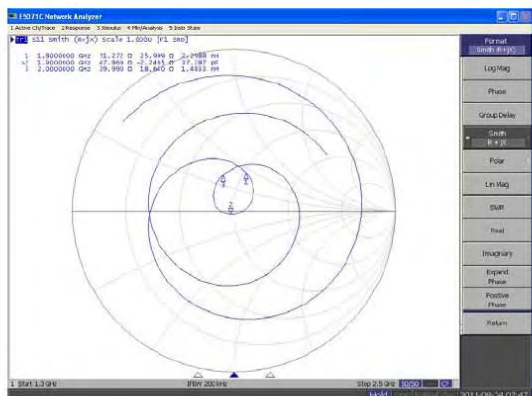

Body

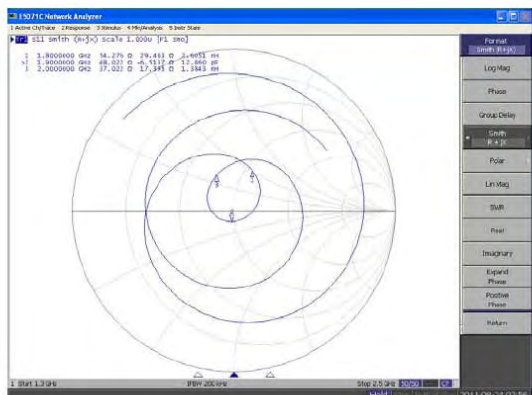

This page has been reviewed for content and attested to by signature within this document.

**NCL Calibration Laboratories**

Division of APREL Laboratories.

**Test Equipment**

The test equipment used during Probe Calibration, manufacturer, model number and, current calibration status are listed and located on the main APREL server R:\NCL\Calibration Equipment\Instrument List 2011

This page has been reviewed for content and attested to by signature within this document.

9

**APPENDIX D – EUT TEST POSITION PHOTOS**

**Liquid depth  $\geq 15\text{cm}$**

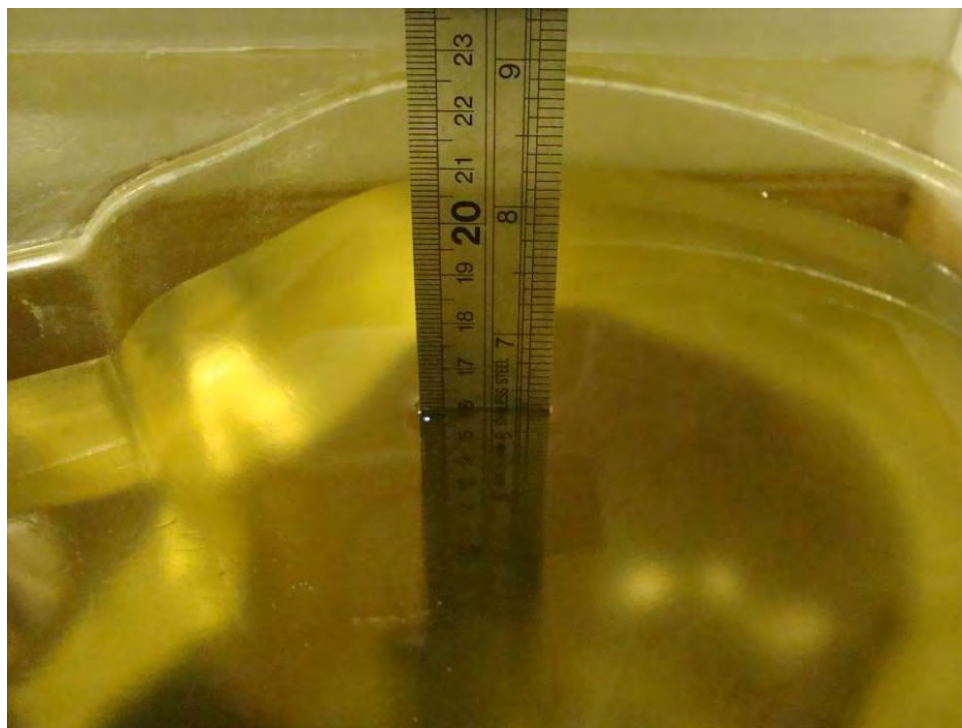

**Body-worn Headset-Keyboard Back Setup Photo**

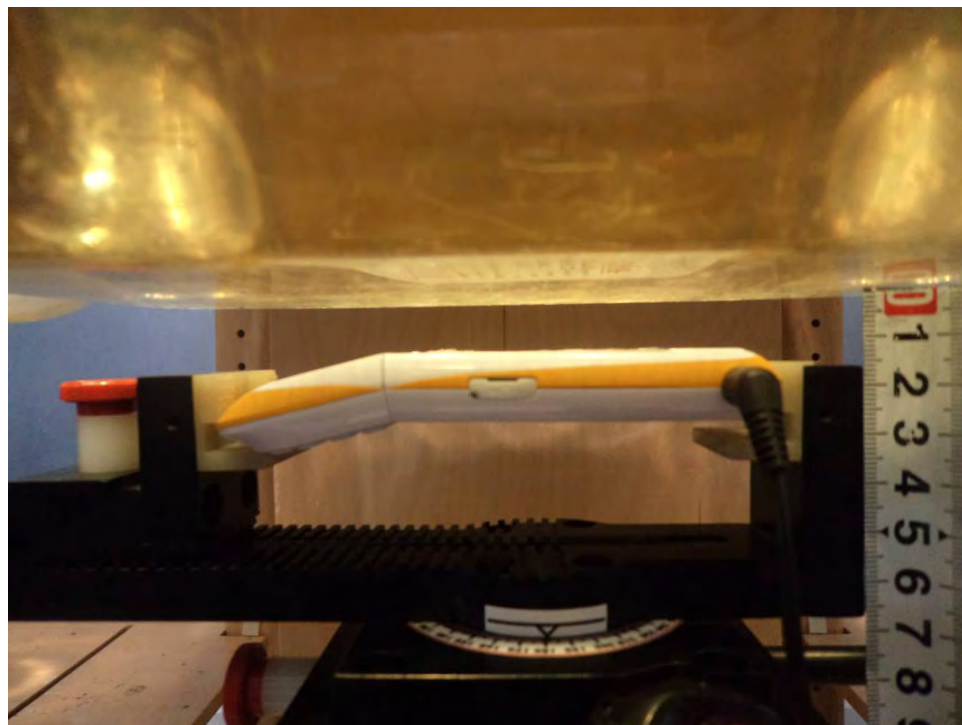

**Body-worn Headset-Keyboard Front Setup Photo**

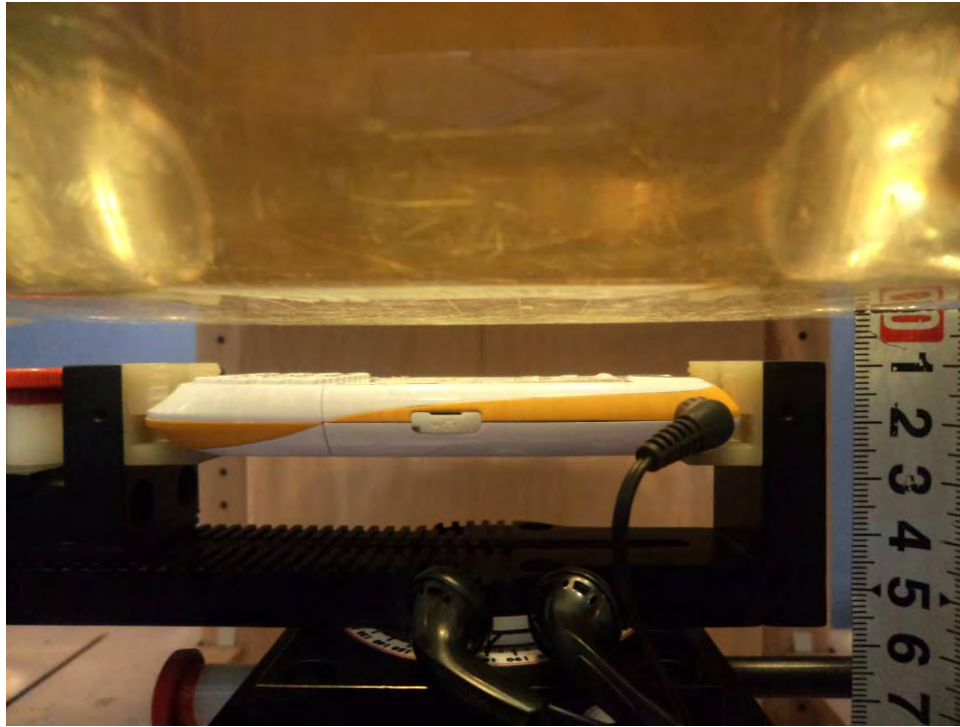

**Left Head Cheek-Keyboard Back Setup Photo**





**Left Head Tilt-Keyboard Back Setup Photo**



**Left Head Cheek-Keyboard Front Setup Photo**



**Left Head Tilt-Keyboard Front Setup Photo**



**Right Head Cheek-Keyboard Back Setup Photo**



**Right Head Tilt-Keyboard Back Setup Photo**



**Right Head Cheek-Keyboard Front Setup Photo**

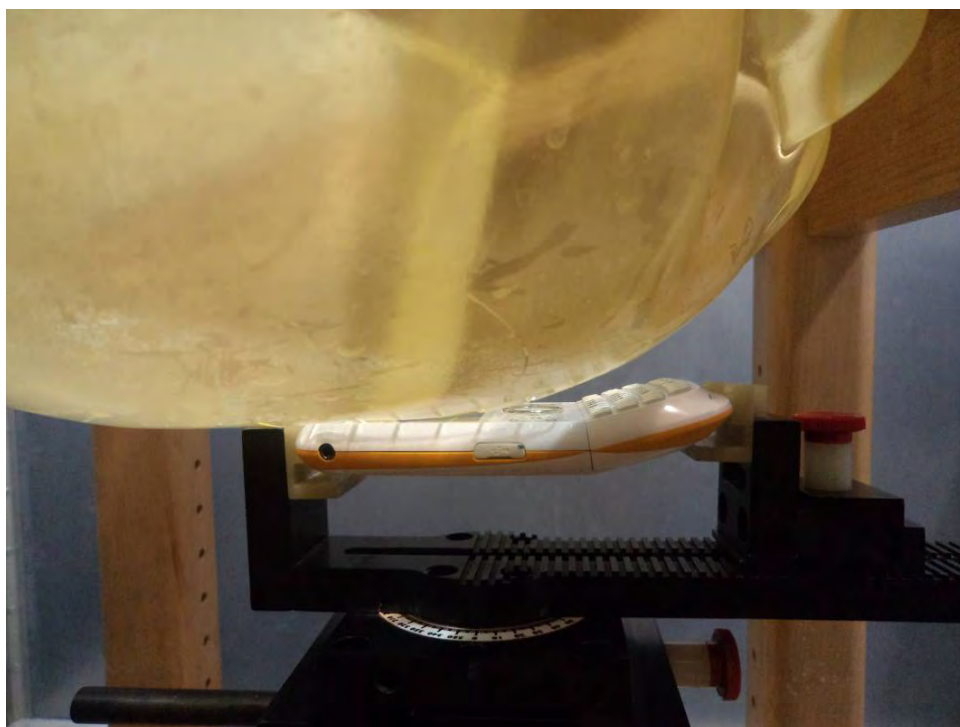



**Right Head Tilt-Keyboard Front Setup Photo**





### APPENDIX E – EUT PHOTOS

**EUT–Front Side View (Keyboard Back)**



**EUT–Back Side View (Keyboard Front)**



**EUT-Front Side View (Keyboard Front)**



**EUT-Back Side View (Keyboard Back)**

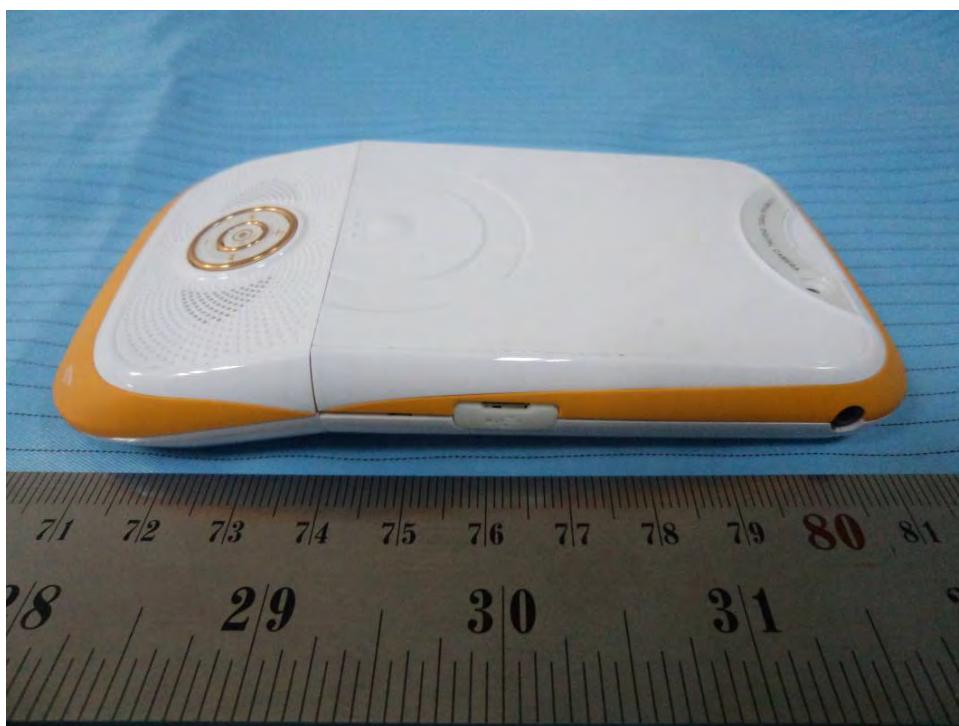



**EUT – Uncovered View**



**EUT-Headset view**



---

**APPENDIX F – INFORMATIVE REFERENCES**

---

- [1] Federal Communications Commission, \Report and order: Guidelines for evaluating the environmental effects of radiofrequency radiation", Tech. Rep. FCC 96-326, FCC, Washington, D.C. 20554, 1996.
- [2] David L. Means Kwok Chan, Robert F. Cleveland, \Evaluating compliance with FCC guidelines for human exposure to radiofrequency electromagnetic fields", Tech. Rep., Federal Communication Commission, Office of Engineering & Technology, Washington, DC, 1997.
- [3] Thomas Schmid, Oliver Egger, and Niels Kuster, \Automated E-field scanning system for dosimetricPage 108 of 108 assessments", IEEE Transactions on Microwave Theory and Techniques, vol. 44, pp. 105{113, Jan. 1996.
- [4] Niels Kuster, Ralph Kastle, and Thomas Schmid, \Dosimetric evaluation of mobile communications equipment with known precision", IEICE Transactions on Communications, vol. E80-B, no. 5, pp. 645{652, May 1997.
- [5] CENELEC, \Considerations for evaluating of human exposure to electromagnetic fields (EMFs) from mobile telecommunication equipment (MTE) in the frequency range 30MHz - 6GHz", Tech. Rep., CENELEC, European Committee for Electrotechnical Standardization, Brussels, 1997.
- [6] ANSI, ANSI/IEEE C95.1-1992: IEEE Standard for Safety Levels with Respect to Human Exposure to Radio Frequency Electromagnetic Fields, 3 kHz to 300 GHz, The Institute of Electrical and Electronics Engineers, Inc., New York, NY 10017, 1992.
- [7] Katja Pokovic, Thomas Schmid, and Niels Kuster, \Robust setup for precise calibration of E-field probes in tissue simulating liquids at mobile communications frequencies", in ICECOM \_ 97, Dubrovnik, October 15{17, 1997, pp. 120-24.
- [8] Katja Pokovic, Thomas Schmid, and Niels Kuster, \E-field probe with improved isotropy in brain simulating liquids", in Proceedings of the ELMAR, Zadar, Croatia, 23{25 June, 1996, pp. 172-175.
- [9] Volker Hombach, Klaus Meier, Michael Burkhardt, Eberhard K. uhn, and Niels Kuster, \The dependence of EM energy absorption upon human head modeling at 900 MHz", IEEE Transactions on Microwave Theory and Techniques, vol. 44, no. 10, pp. 1865-1873, Oct. 1996.
- [10] Klaus Meier, Ralf Kastle, Volker Hombach, Roger Tay, and Niels Kuster, \The dependence of EM energy absorption upon human head modeling at 1800 MHz", IEEE Transactions on Microwave Theory and Techniques, Oct. 1997, in press.
- [11] W. Gander, Computermathematik, Birkhaeuser, Basel, 1992.
- [12] W. H. Press, S. A. Teukolsky, W. T. Vetterling, and B. P. Flannery, Numerical Recipes in C, The Art of Scientific Computing, Second Edition, Cambridge University Press, 1992. Dosimetric Evaluation of Sample device, month 1998 9
- [13] NIS81 NAMAS, \The treatment of uncertainty in EMC measurement", Tech. Rep., NAMAS Executive, National Physical Laboratory, Teddington, Middlesex, England, 1994.
- [14] Barry N. Taylor and Christ E. Kuyatt, \Guidelines for evaluating and expressing the uncertainty of NIST measurement results", Tech. Rep., National Institute of Standards and Technology, 1994. Dosimetric Evaluation of Sample device, month 1998 10.
- [15] FCC OET KDB648474 Do1 SAR Evaluation Considerations for Handsets with Multiple transmitters and Antennas.

\*\*\*\*\* END OF REPORT \*\*\*\*\*