

- 171 USB_DMT
- 171 USB_DP1
- 121 UPK01
- 121 UPK03
- 13,71 PWR_KEY
- 12,3,4,5,6,71 GND
- 13,4,5,6,71 VBAT
- 13,71 KCOL0

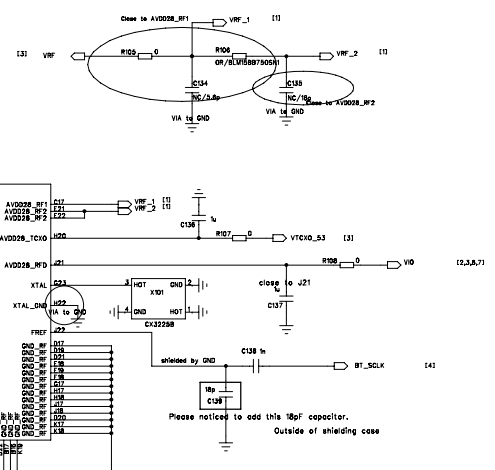

DRAWN: TangJianBo	DATED: 20110321	COMPANY:
CHECKED:	DATED:	TITLE: MT6252
QUALITY CONTROL:	DATED:	TJ CODES: REV: V10
RELEASED:	DATED:	SIZE: A1 SHEET: 1 of 7

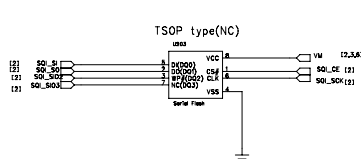
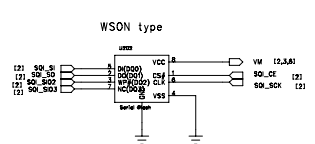
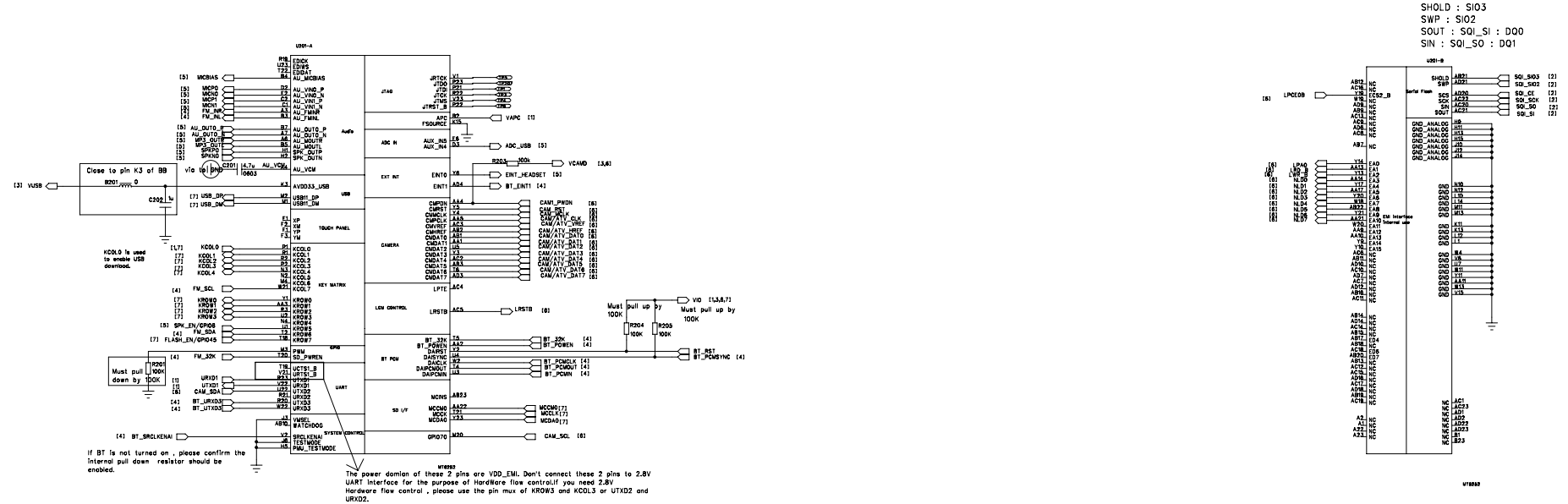

SHOLD : SI03
SWP : SI02
SOUT : SQI_S1 : D00
SIN : SQI_S0 : D01

DRAWN: TangJinBo	DATED: 20110321	COMPANY:	
CHECKED:	DATED:	TITLE: MT6252	
QUALITY CONTROL:	DATED:	TJ CODE:	REV: V10
RELEASED:	DATED:	SIZE: A1	SHEET: 2 of 7

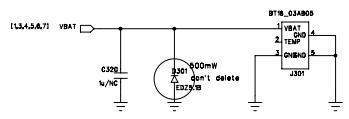
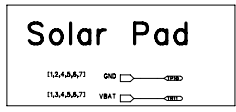
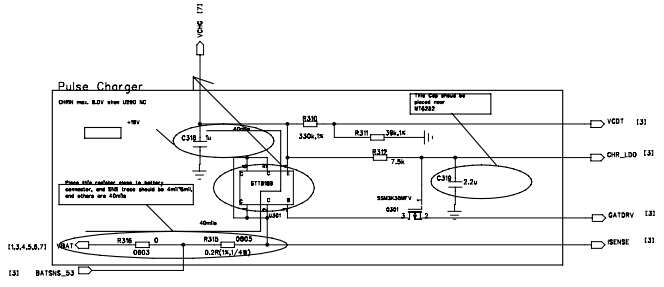
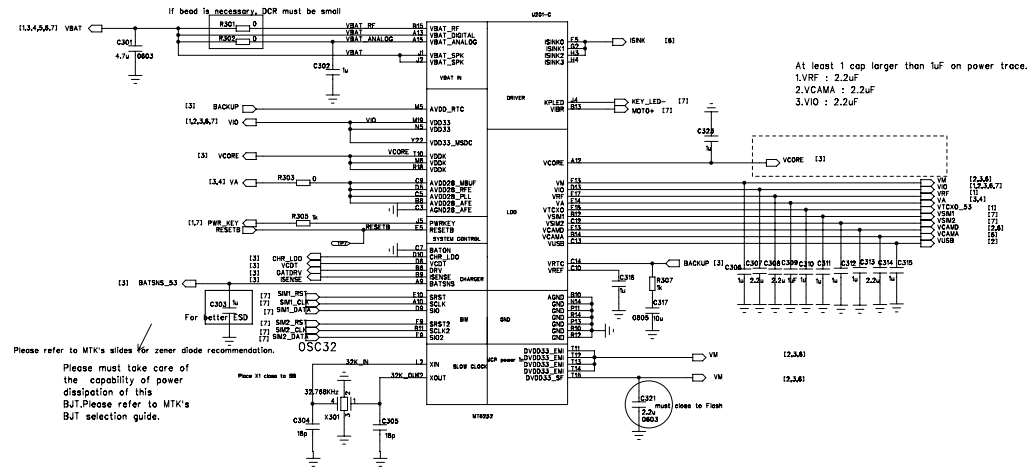

DRAWN: TongJianBo	DATE: 20110321	COMPANY:
CHECKED:	DATE:	TITLE: MT6252
QUALITY CONTROL:	DATE:	TJ CODE: REV: V10
RELEASED:	DATE:	SIZE: A1 SHEET: 3 of 7

BT/FM

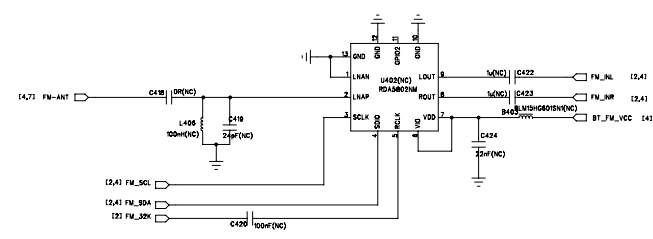
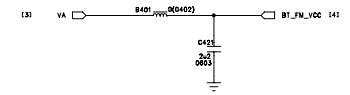
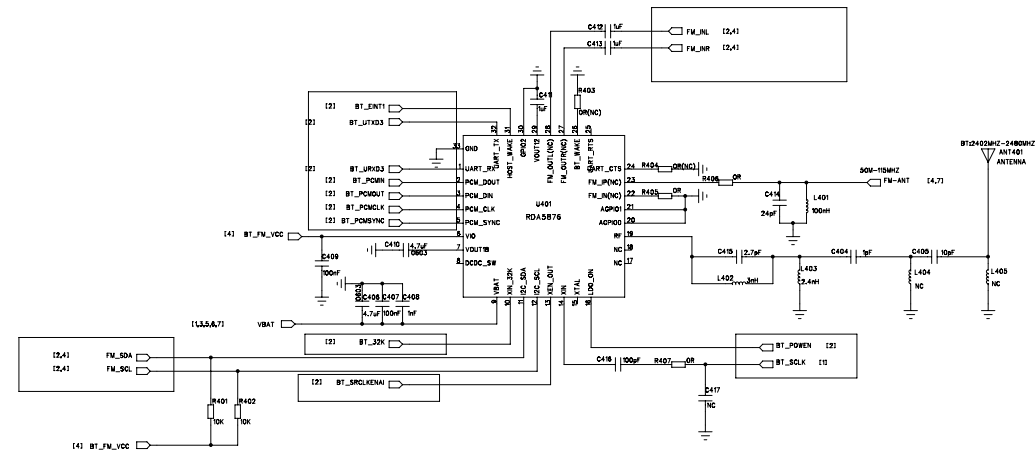

DRAWN: TongJianBo	DATED: 20110321	COMPANY:	
CHECKED:	DATED:	TITLE: MT6252	
QUALITY CONTROL:	DATED:	TJ CODE:	REV: V10
RELEASED:	DATED:	SIZE: A1	SHEET: 4 of 7

HEADSET AUDIO

HEADSET MIC

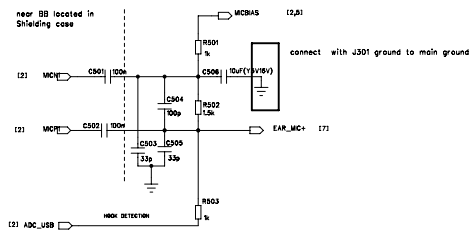

HANDSET MICROPHONE

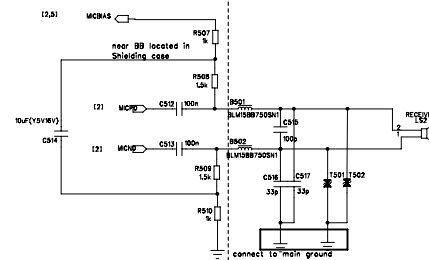

HEADSET RECEIVER

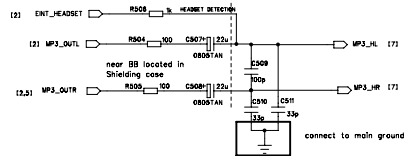

Normal Receiver

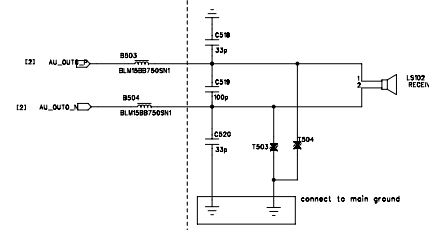

Audio Amplifier & Speaker

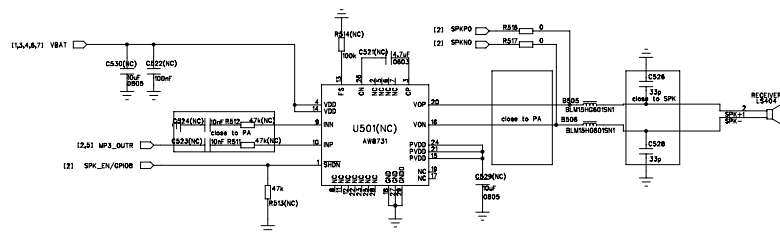

DRAWN: TongJianBo	DATE: 20110321	COMPANY:	
CHECKED:	DATE:	TITLE: MT6252	
QUALITY CONTROL:	DATE:	TJ CODE:	REV: V10
RELEASED:	DATE:	SIZE: A1	SHEET: 5 of 7

CAM

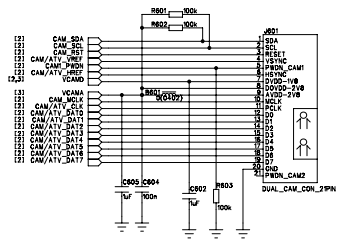

LCM

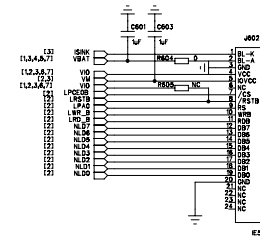

DRAWN: TongJianBo	DATED: 20110321	COMPANY:	
CHECKED:	DATED:	TITLE: MT6252	
QUALITY CONTROL:	DATED:	TJ CODE:	REV: V10
RELEASED:	DATED:	SIZE: A1	SHEET: 6 of 7

TF Card

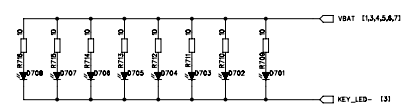
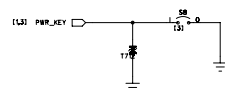
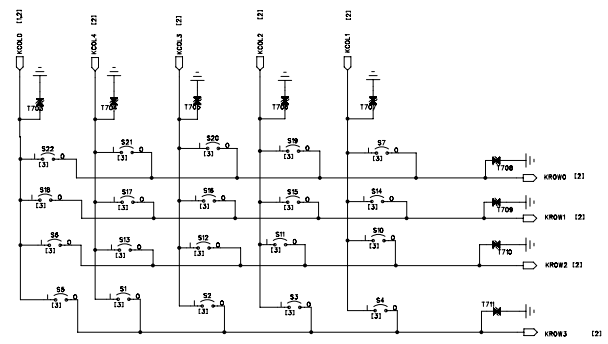
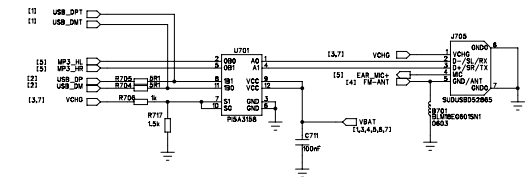
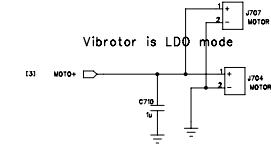
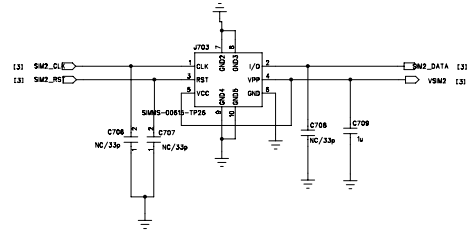
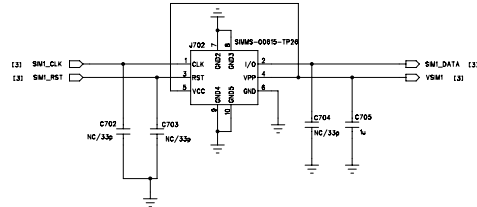
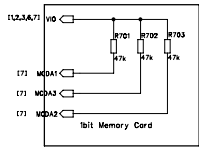
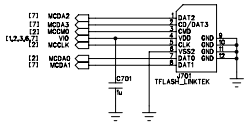

LED Light

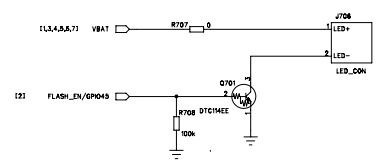

DRAWN: TanjungBo	DATED: 20110321	COMPANY:	
CHECKED:	DATED:	TITLE:	MT6252
QUALITY CONTROL:	DATED:	TJ CODE:	REV V10
RELEASED:	DATED:	SIZE:	A1
			SHEET: 7 of 7