



FCC PART 15 SUBPART C TEST REPORT

FCC PART 15.247

Report Reference No......: **TRE1312003105 R/C: 34886**

FCC ID.....: **YPVITALCOMSKYHD**

Compiled by

(position+printed name+signature)..: File administrators Eric Wang

Eric Wang

Supervised by

(position+printed name+signature)..: Test Engineer Yuchao Wang

yuchao.wang

Approved by

(position+printed name+signature)..: Manager Wenliang Li

Wenliang Li

Date of issue.....: Dec 18, 2013

Testing Laboratory Name: **Shenzhen Huatongwei International Inspection Co., Ltd**

Address: Keji Nan No.12 Road, Hi-tech Park, Shenzhen, China

Applicant's name.....: **ITALCOM GROUP**

Address: 1728 Coral Way, Coral Gables, Miami, Florida, United States

Test specification

Standard: **FCC Part 15.247: Operation within the bands 902-928 MHz, 2400-2483.5 MHz and 5725-5850 MHz**

TRF Originator.....: Shenzhen Huatongwei International Inspection CO., Ltd

Master TRF.....: Dated 2006-06

Shenzhen Huatongwei International Inspection Co., Ltd. All rights reserved.

This publication may be reproduced in whole or in part for non-commercial purposes as long as the Shenzhen Huatongwei International Inspection Co., Ltd is acknowledged as copyright owner and source of the material. Shenzhen Huatongwei International Inspection Co., Ltd takes no responsibility for and will not assume liability for damages resulting from the reader's interpretation of the reproduced material due to its placement and context.

Test item description

Trade Mark: NYX

Model/Type reference.....: SKY HD

Listed Models: /

Manufacturer

Modulation Type.....: GFSK

Operation Frequency.....: From 2402MHz to 2480MHz

Rating: DC 3.70V

Hardware version: 8061-MB-V0.3

Software version: SKY_AMXNYX_V001R

Android version: 4.2.1

Result.....: **PASS**

T E S T R E P O R T

Test Report No. :	TRE1312003105	Dec 18, 2013
		Date of issue

Equipment under Test : mobile Phone

Model /Type : SKY HD

Listed Models : /

Applicant : **ITALCOM GROUP**

Address : 1728 Coral Way, Coral Gables, Miami, Florida, United States

Manufacturer : **ITALCOM GROUP**

Address : 1728 Coral Way, Coral Gables, Miami, Florida, United States

Test Result	PASS
--------------------	-------------

The test report merely corresponds to the test sample.

It is not permitted to copy extracts of these test result without the written permission of the test laboratory.

Contents

1.	<u>TEST STANDARDS</u>	4
2.	<u>SUMMARY</u>	5
2.1.	General Remarks	5
2.2.	Product Description	5
2.3.	Equipment Under Test	5
2.4.	Description of the test mode	5
2.5.	Short description of the Equipment under Test (EUT)	6
2.6.	EUT operation mode	6
2.7.	EUT configuration	6
2.8.	Internal Identification of AE used during the test	6
2.9.	Related Submittal(s) / Grant (s)	7
2.10.	Modifications	7
2.11.	NOTE	7
3.	<u>TEST ENVIRONMENT</u>	8
3.1.	Address of the test laboratory	8
3.2.	Test Facility	8
3.3.	Environmental conditions	9
3.4.	Test Description	9
3.5.	Statement of the measurement uncertainty	9
3.6.	Equipments Used during the Test	10
4.	<u>TEST CONDITIONS AND RESULTS</u>	11
4.1.	AC Power Conducted Emission	11
4.2.	Radiated Emission	13
4.3.	Maximum Peak Output Power	17
4.4.	Power Spectral Density	20
4.5.	Band Edge Compliance of RF Emission	23
4.6.	Spurious RF Conducted Emission	28
4.7.	6dB Bandwidth	35
4.8.	Antenna Requirement	38
5.	<u>TEST SETUP PHOTOS OF THE EUT</u>	39
6.	<u>EXTERNAL AND INTERNAL PHOTOS OF THE EUT</u>	41

1. TEST STANDARDS

The tests were performed according to following standards:

[FCC Rules Part 15.247](#): Frequency Hopping, Direct Spread Spectrum and Hybrid Systems that are in operation within the bands of 902-928 MHz, 2400-2483.5 MHz, and 5725-5850 MHz.

[ANSI C63.10](#): American National Standard for Testing Unlicensed Wireless Devices

[KDB558074 D01 V03](#): Guidance for Performing Compliance Measurements on Digital Transmission Systems (DTS) Operating Under §15.247

2. SUMMARY

2.1. General Remarks

Date of receipt of test sample	:	Dec 05, 2013
Testing commenced on	:	Dec06, 2013
Testing concluded on	:	Dec 18, 2013

2.2. Product Description

The **ITALCOM GROUP**'s Model: SKY HD or the "EUT" as referred to in this report; more general information as follows, for more details, refer to the user's manual of the EUT.

Name of EUT	mobile phone
Model Number	SKY HD
FCC ID	YPVITALCOMSKYHD
Modulation Type	QPSK for WCDMA,GMSK for GSM/GPRS/EGPRS
Antenna Type	Internal
Hardware version	8061-MB-V0.3
Software version	SKY_AMXNYX_V001R
Android version	4.2.1
GSM/EDGE/GPRS	Supported GSM/GPRS/EDGE
WCDMA Operation Frequency Band	FDD Band II, FDD Band V
HSDPA Release Version	Release 8
HSUPA Release Version	Release 6
WCDMA Release Version	R99
Extreme temp. Tolerance	-30°C to +60°C
Extreme vol. Limits	3.40VDC to 4.20VDC (nominal: 3.70VDC)
GSM/GPRS Operation Frequency Band	GSM850/PCS1900
GSM Release Version	R99
GPRS operation mode	Class B
GPRS Multislot Class	12
EGPRS Multislot Class	12

2.3. Equipment Under Test

Power supply system utilised

Power supply voltage	:	<input type="radio"/> 120V / 60 Hz	<input type="radio"/> 115V / 60Hz
		<input type="radio"/> 12 V DC	<input type="radio"/> 24 V DC
		<input checked="" type="radio"/> Other (specified in blank below)	

DC 3.70V

2.4. Description of the test mode

Bluetooth 4.0 support 40 channels in USA.

Channel	Frequency(MHz)	Channel	Frequency(MHz)
00	2402	20	2442
01	2404	21	2444
02	2406	22	2446
03	2408	23	2448
04	2410	24	2450
05	2412	25	2452
06	2414	26	2454
07	2416	27	2456

08	2418	28	2458
09	2420	29	2460
10	2422	30	2462
11	2424	31	2464
12	2426	32	2466
13	2428	33	2468
14	2430	34	2470
15	2432	35	2472
16	2434	36	2474
17	2436	37	2476
18	2438	38	2478
19	2440	39	2480

2.5. Short description of the Equipment under Test (EUT)

2.4GHz (mobile Phone (M/N:SKY HD))

For more details, refer to the user's manual of the EUT.

2.6. EUT operation mode

The EUT has been tested under typical operating condition. The Applicant provides command to control the EUT for staying in continuous transmitting and receiving mode for testing.

2.7. EUT configuration

The following peripheral devices and interface cables were connected during the measurement:

● - supplied by the manufacturer

○ - supplied by the lab

<input type="radio"/>	Power Cable	Length (m) :	/
		Shield :	/
		Detachable :	/
<input type="radio"/>	Multimeter	Manufacturer :	/
		Model No. :	/

2.8. Internal Identification of AE used during the test

AE ID*	Description
AE1	Battery
AE2	Charger and USB cable

AE1

Model: NYX3000A98X69
 Manufacturer: ITALCOM GROUP
 Capacitance: 3000mAh
 Nominal Voltage: 3.70V

AE2:

Model: SKY HD
 Manufacturer: ITALCOM GROUP
 Input: 100-240V ~ 50/60Hz 0.15A
 Output: OUTPUT: 5.0V DC 1.0A
 Power Cable Length: 90cm
 Shielded Unshielded

*AE ID: is used to identify the test sample in the lab internally.

2.9. Related Submittal(s) / Grant (s)

This submittal(s) (test report) is intended for **FCC ID: YPVITALCOMSKYHD** filing to comply with Section 15.247 of the FCC Part 15, Subpart C Rules.

2.10. Modifications

No modifications were implemented to meet testing criteria.

2.11. NOTE

1. The EUT is a mobile Phone WCDMA/HSUPA/HSDPA/GPRS/GSM,WLAN and Bluetooth function,The functions of the EUT listed as below:

	Test Standards	Reference Report
GSM/GPRS/EGPRS	FCC Part 22/FCC Part 24	TRE1312003101
WCDMA/HSUPA/HSDPA	FCC Part 22/FCC Part 24	TRE1312003102
WLAN	FCC Part 15 C 15.247	TRE1312003103
Bluetooth v2.1	FCC Part 15 C 15.247	TRE1312003104
Bluetooth 4.0	FCC Part 15 C 15.247	TRE1312003105
USB Port	FCC Part 15 B	TRE1312003106
SAR	FCC Part 2 §2.1093	TRE1312003107

3 . TEST ENVIRONMENT

3.1. Address of the test laboratory

Shenzhen Huatongwei International Inspection Co., Ltd
Keji Nan No.12 Road, Hi-tech Park, Shenzhen, China
Phone: 86-755-26715686 Fax: 86-755-26748089

The sites are constructed in conformance with the requirements of ANSI C63.7, ANSI C63.4 (2009) and CISPR Publication 22.

3.2. Test Facility

The test facility is recognized, certified, or accredited by the following organizations:

CNAS-Lab Code: L1225

Shenzhen Huatongwei International Inspection Co., Ltd. has been assessed and proved to be in compliance with CNAS-CL01 Accreditation Criteria for Testing and Calibration Laboratories (identical to ISO/IEC 17025: 2005 General Requirements) for the Competence of Testing and Calibration Laboratories, Date of Registration: Mar. 29, 2012. Valid time is until Feb. 28, 2015.

A2LA-Lab Cert. No. 2243.01

Shenzhen Huatongwei International Inspection Co., Ltd. EMC Laboratory has been accredited by A2LA for technical competence in the field of electrical testing, and proved to be in compliance with ISO/IEC 17025: 2005 General Requirements for the Competence of Testing and Calibration Laboratories and any additional program requirements in the identified field of testing. Valid time is until Sept. 30, 2015.

FCC-Registration No.: 662850

Shenzhen Huatongwei International Inspection Co., Ltd. EMC Laboratory has been registered and fully described in a report filed with the FCC (Federal Communications Commission). The acceptance letter from the FCC is maintained in our files. Registration 662850, Renewal date Jun. 01, 2012, valid time is until Jun. 01, 2015.

IC-Registration No.: 5377A

The 3m Alternate Test Site of Shenzhen Huatongwei International Inspection Co., Ltd. has been registered by Certification and Engineering Bureau of Industry Canada for the performance of radiated measurements with Registration No. 5377A on Jan. 25, 2011, valid time is until Jan. 24, 2014.

ACA

Shenzhen Huatongwei International Inspection Co., Ltd. EMC Laboratory can also perform testing for the Australian C-Tick mark as a result of our A2LA accreditation.

VCCI

The 3m Semi-anechoic chamber (12.2m×7.95m×6.7m) and Shielded Room (8m×4m×3m) of Shenzhen Huatongwei International Inspection Co., Ltd. has been registered in accordance with the Regulations for Voluntary Control Measures with Registration No.: G-292. Date of Registration: Dec. 24, 2010. Valid time is until Dec. 23, 2013.

Main Ports Conducted Interference Measurement of Shenzhen Huatongwei International Inspection Co., Ltd. has been registered in accordance with the Regulations for Voluntary Control Measures with Registration No.: C-2726. Date of Registration: Dec. 20, 2012. Valid time is until Dec. 19, 2015.

Telecommunication Ports Conducted Interference Measurement of Shenzhen Huatongwei International Inspection Co., Ltd. has been registered in accordance with the Regulations for Voluntary Control Measures with Registration No.: T-1837. Date of Registration: May 07, 2013. Valid time is until May 06, 2016.

DNV

Shenzhen Huatongwei International Inspection Co., Ltd. has been found to comply with the requirements of DNV towards subcontractor of EMC and safety testing services in conjunction with the EMC and Low voltage Directives and in the voluntary field. The acceptance is based on a formal quality Audit and follow-ups according to relevant parts of ISO/IEC Guide 17025 (2005), in accordance with the requirements of the DNV Laboratory Quality Manual towards subcontractors. Valid time is until Aug. 24, 2016.

3.3. Environmental conditions

During the measurement the environmental conditions were within the listed ranges:

Temperature:	<u>15-35 ° C</u>
Humidity:	<u>30-60 %</u>
Atmospheric pressure:	<u>950-1050mbar</u>

3.4. Test Description

FCC PART 15 15.247		
FCC Part 15.207	AC Power Conducted Emission	PASS
FCC Part 15.247(a)(2)	6dB Bandwidth	PASS
FCC Part 15.247(d)	Spurious RF Conducted Emission	PASS
FCC Part 15.247(b)	Maximum Peak Output Power	PASS
FCC Part 15.247(e)	Power Spectral Density	PASS
FCC Part 15.109/ 15.205/ 15.209	Radiated Emissions	PASS
FCC Part 15.247(d)	Band Edge	PASS
FCC Part 15.203/15.247 (b)	Antenna Requirement	PASS

3.5. Statement of the measurement uncertainty

The data and results referenced in this document are true and accurate. The reader is cautioned that there may be errors within the calibration limits of the equipment and facilities. The measurement uncertainty was calculated for all measurements listed in this test report acc. to CISPR 16 - 4 „Specification for radio disturbance and immunity measuring apparatus and methods – Part 4: Uncertainty in EMC Measurements“ and is documented in the Shenzhen Huatongwei International Inspection Co., Ltd quality system acc. to DIN EN ISO/IEC 17025. Furthermore, component and process variability of devices similar to that tested may result in additional deviation. The manufacturer has the sole responsibility of continued compliance of the device.

Hereafter the best measurement capability for Shenzhen Huatongwei laboratory is reported:

Test Items	Measurement Uncertainty	Notes
Frequency stability	25 Hz	(1)
Transmitter power conducted	0.57 dB	(1)
Transmitter power Radiated	2.20 dB	(1)
Conducted spurious emission 9KHz-12.75 GHz	1.60 dB	(1)
Radiated spurious emission 9KHz-12.75 GHz	2.20 dB	(1)
Conducted Emission 9KHz-30MHz	3.39 dB	(1)
Radiated Emission 30~1000MHz	4.24 dB	(1)
Radiated Emissio 1~18GHz	5.16 dB	(1)
Radiated Emissio 18-40GHz	5.54 dB	(1)
Occupied Bandwidth	-----	(1)
Emission Mask	-----	(1)
Modulation Characteristic	-----	(1)
Transmitter Frequency Behavior	-----	(1)

- (1) This uncertainty represents an expanded uncertainty expressed at approximately the 95% confidence level using a coverage factor of k=1.96.

3.6. Equipments Used during the Test

AC Power Conducted Emission					
Item	Test Equipment	Manufacturer	Model No.	Serial No.	Cal.Due
1	Artificial Mains	Rohde&Schwarz	ESH2-Z5	100028	2014/10/25
2	EMI Test Receiver	Rohde&Schwarz	ESCI	100106	2014/10/25
3	Pulse Limiter	Rohde&Schwarz	ESHSZ2	100044	2014/10/25
4	EMI Test Software	Rohde&Schwarz	ES-K1 V1.71	N/A	N/A

Radiated Emission					
Item	Test Equipment	Manufacturer	Model No.	Serial No.	Cal.Due
1	Ultra-Broadband Antenna	ShwarzBeck	VULB9163	538	2014/10/25
2	EMI TEST RECEIVER	Rohde&Schwarz	ESI 26	100009	2014/10/25
3	EMI TEST Software	Audix	E3	N/A	2014/10/25
4	TURNTABLE	ETS	2088	2149	N/A
5	ANTENNA MAST	ETS	2075	2346	N/A
6	EMI TEST Software	Rohde&Schwarz	ESK1	N/A	N/A
7	HORN ANTENNA	ShwarzBeck	9120D	1011	2014/10/25
8	Amplifer	Sonoma	310N	E009-13	2014/10/25
9	JS amplifer	Rohde&Schwarz	JS4-00101800-28-5A	F201504	2014/10/25
10	High pass filter	Compliance Direction systems	BSU-6	34202	2014/10/25
11	HORN ANTENNA	ShwarzBeck	9120D	1012	2014/10/25
12	Amplifer	Compliance Direction systems	PAP1-4060	120	2014/10/25
13	Loop Antenna	Rohde&Schwarz	HFH2-Z2	100020	2014/10/25
14	TURNTABLE	MATURO	TT2.0	----	N/A
15	ANTENNA MAST	MATURO	TAM-4.0-P	----	N/A
16	Horn Antenna	SCHWARZBECK	BBHA9170	25841	2014/10/25
17	HORN ANTENNA	Rohde&Schwarz	HF906	100039	2014/10/25
18	ULTRA-BROADBAND ANTENNA	Rohde&Schwarz	HL562	100015	2014/10/25

Maximum Peak Output Power / Power Spectral Density / 6dB Bandwidth / Band Edge Compliance of RF Emission / Spurious RF Conducted Emission					
Item	Test Equipment	Manufacturer	Model No.	Serial No.	Cal.Due
1	Spectrum Analyzer	Rohde&Schwarz	FSP	1164.4391.40	2014/10/25

The Cal.Interval was one year

4. TEST CONDITIONS AND RESULTS

4.1. AC Power Conducted Emission

TEST CONFIGURATION

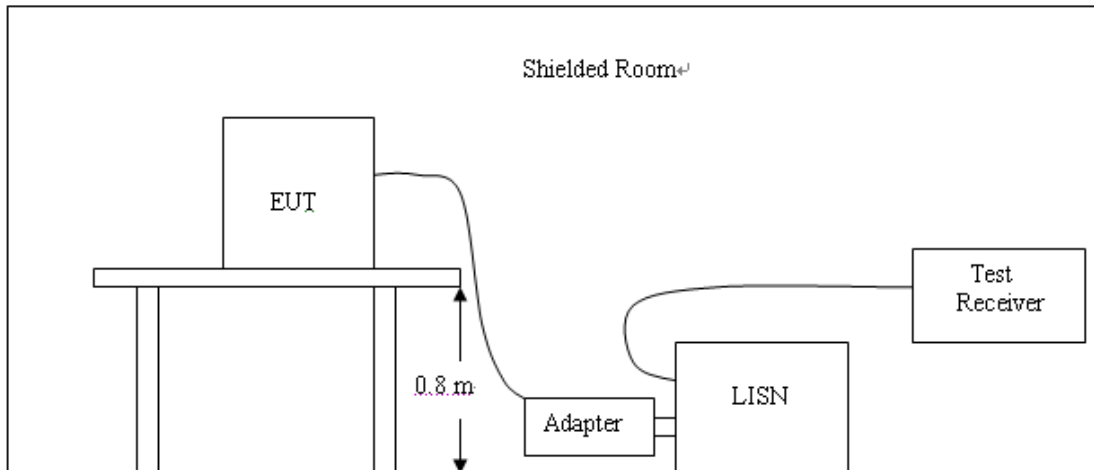

TEST PROCEDURE

1. The equipment was set up as per the test configuration to simulate typical actual usage per the user's manual. The EUT is a tabletop system, a wooden table with a height of 0.8 meters is used and is placed on the ground plane as per ANSI C63.10-2009.
2. Support equipment, if needed, was placed as per ANSI C63.10-2009
3. All I/O cables were positioned to simulate typical actual usage as per ANSI C63.10-2009
4. The EUT received DC5V power from the adapter, the adapter received AC120V/60Hz power through a Line Impedance Stabilization Network (LISN) which supplied power source and was grounded to the ground plane.
5. All support equipments received AC power from a second LISN, if any.
6. The EUT test program was started. Emissions were measured on each current carrying line of the EUT using a spectrum Analyzer / Receiver connected to the LISN powering the EUT. The LISN has two monitoring points: Line 1 (Hot Side) and Line 2 (Neutral Side). Two scans were taken: one with Line 1 connected to Analyzer / Receiver and Line 2 connected to a 50 ohm load; the second scan had Line 1 connected to a 50 ohm load and Line 2 connected to the Analyzer / Receiver.
7. Analyzer / Receiver scanned from 150 KHz to 30MHz for emissions in each of the test modes.
8. During the above scans, the emissions were maximized by cable manipulation.

AC Power Conducted Emission Limit

For intentional device, according to § 15.207(a) AC Power Conducted Emission Limits is as following :

Frequency (MHz)	Maximum RF Line Voltage (dB μ V)			
	CLASS A		CLASS B	
	Q.P.	Ave.	Q.P.	Ave.
0.15 - 0.50	79	66	66-56*	56-46*
0.50 - 5.00	73	60	56	46
5.00 - 30.0	73	60	60	50

* Decreasing linearly with the logarithm of the frequency

TEST RESULTS

SCAN TABLE: "Voltage (9K-30M) FIN"
 Short Description: 150K-30M Voltage

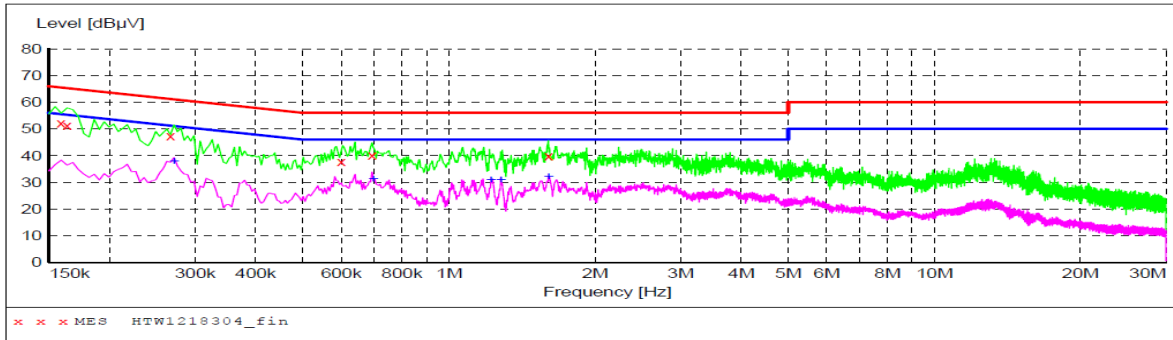

MEASUREMENT RESULT: "HTW1218304_fin"

12/18/2013 11:28AM

Frequency MHz	Level dBµV	Transd dB	Limit dBµV	Margin dB	Detector	Line	PE
0.159000	52.10	10.3	66	13.4	QP	L1	GND
0.163500	51.30	10.3	65	14.0	QP	L1	GND
0.267000	47.50	10.6	61	13.7	QP	L1	GND
0.600000	37.90	10.3	56	18.1	QP	L1	GND
0.694500	40.20	10.3	56	15.8	QP	L1	GND
1.603500	39.80	10.3	56	16.2	QP	L1	GND

MEASUREMENT RESULT: "HTW1218304_fin2"

12/18/2013 11:28AM

Frequency MHz	Level dBµV	Transd dB	Limit dBµV	Margin dB	Detector	Line	PE
0.271500	37.80	10.6	51	13.3	AV	L1	GND
0.699000	31.00	10.3	46	15.0	AV	L1	GND
1.221000	30.90	10.3	46	15.1	AV	L1	GND
1.279500	30.70	10.3	46	15.3	AV	L1	GND
1.603500	32.10	10.3	46	13.9	AV	L1	GND

SCAN TABLE: "Voltage (9K-30M) FIN"
 Short Description: 150K-30M Voltage

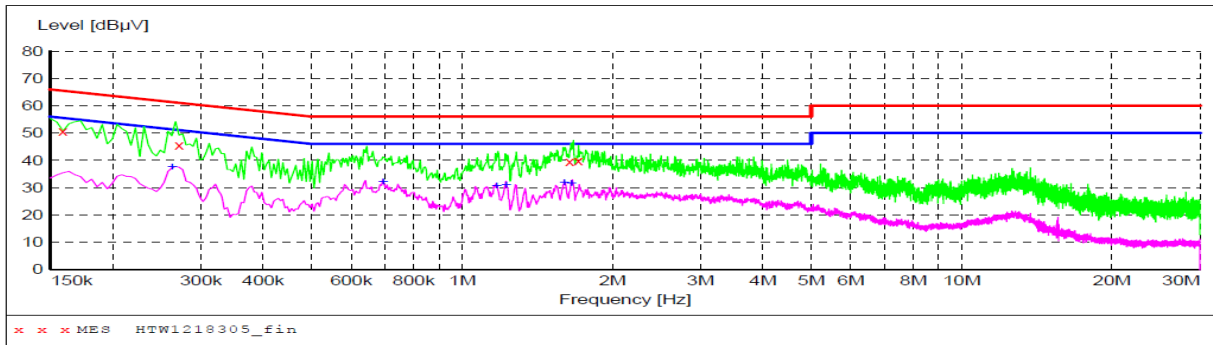

MEASUREMENT RESULT: "HTW1218305_fin"

12/18/2013 11:30AM

Frequency MHz	Level dBµV	Transd dB	Limit dBµV	Margin dB	Detector	Line	PE
0.159000	50.70	10.3	66	14.8	QP	N	GND
0.271500	45.60	10.6	61	15.5	QP	N	GND
1.644000	39.50	10.3	56	16.5	QP	N	GND
1.711500	40.00	10.3	56	16.0	QP	N	GND

MEASUREMENT RESULT: "HTW1218305_fin2"

12/18/2013 11:30AM

Frequency MHz	Level dBµV	Transd dB	Limit dBµV	Margin dB	Detector	Line	PE
0.262500	37.40	10.6	51	14.0	AV	N	GND
0.694500	32.10	10.3	46	13.9	AV	N	GND
1.171500	30.40	10.3	46	15.6	AV	N	GND
1.225500	30.90	10.3	46	15.1	AV	N	GND
1.599000	31.80	10.3	46	14.2	AV	N	GND
1.653000	31.40	10.3	46	14.6	AV	N	GND

4.2. Radiated Emission

TEST CONFIGURATION

Frequency range 9KHz – 30MHz

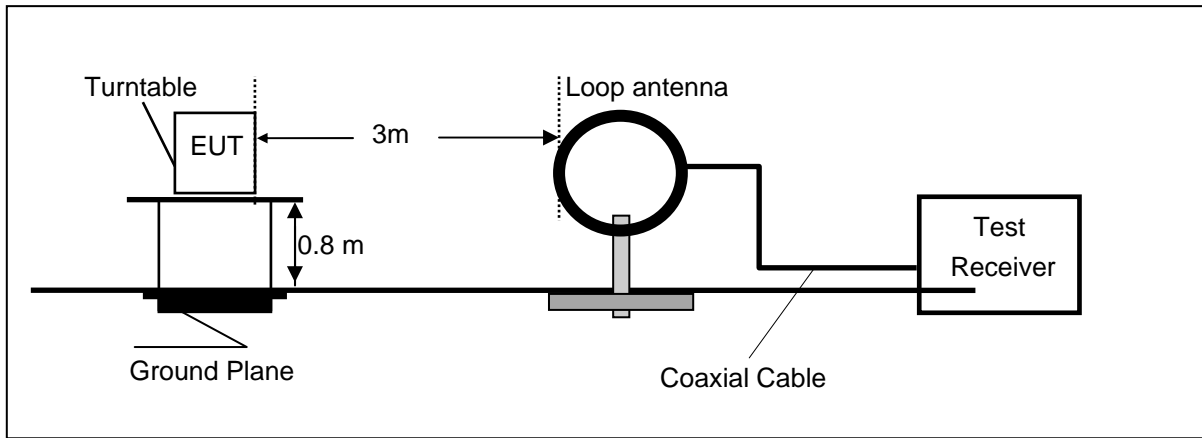

Frequency range 30MHz – 1000MHz

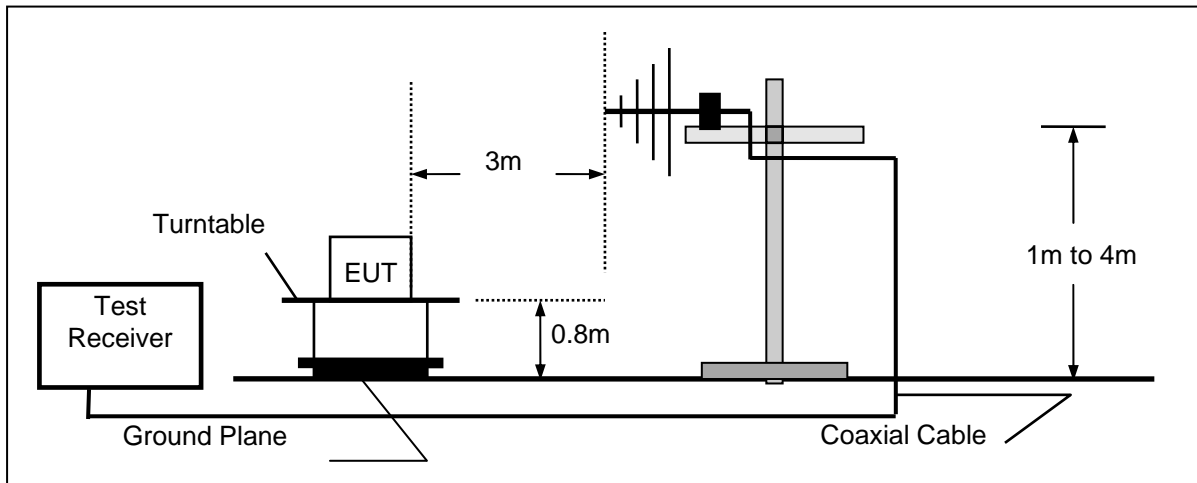

Frequency range above 1GHz-25GHz

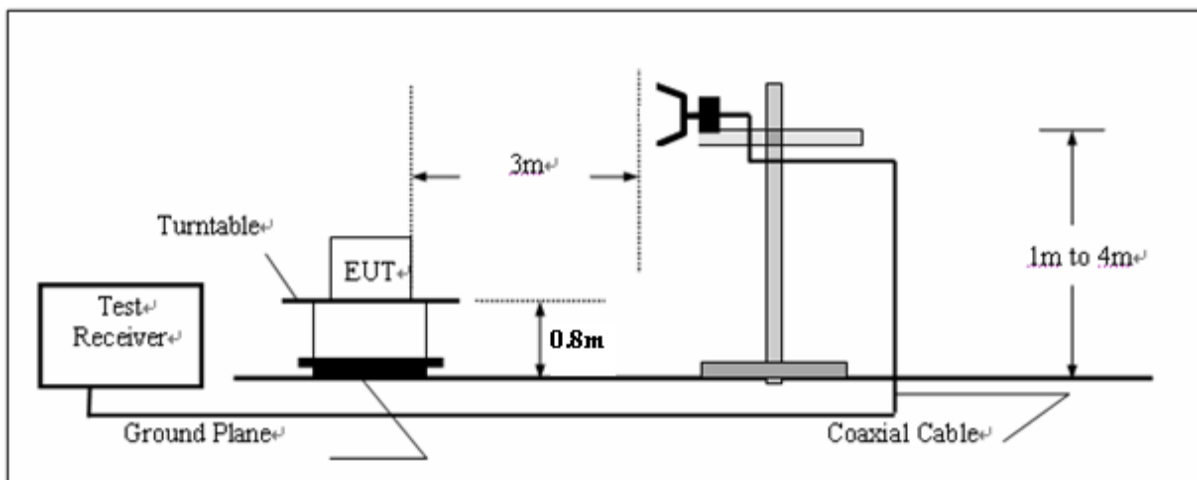

TEST PROCEDURE

1. The EUT was placed on a turn table which is 0.8m above ground plane.
2. Maximum procedure was performed by raising the receiving antenna from 1m to 4m and rotating the turn table from 0°C to 360°C to acquire the highest emissions from EUT

3. And also, each emission was to be maximized by changing the polarization of receiving antenna both horizontal and vertical.
4. Repeat above procedures until all frequency measurements have been completed.
5. The EUT minimum operation frequency was 32.768KHz and maximum operation frequency was 2462MHz.so radiated emission test frequency band from 9KHz to 25GHz.

Field Strength Calculation

The field strength is calculated by adding the Antenna Factor and Cable Factor and subtracting the Amplifier Gain and Duty Cycle Correction Factor(if any) from the measured reading. The basic equation with a sample calculation is as follows:

$$FS = RA + AF + CL - AG$$

Where FS = Field Strength	CL = Cable Attenuation Factor (Cable Loss)
RA = Reading Amplitude	AG = Amplifier Gain
AF = Antenna Factor	

RADIATION LIMIT

For intentional device, according to § 15.209(a), the general requirement of field strength of radiated emission from intentional radiators at a distance of 3 meters shall not exceed the following table. According to § 15.247(d), in any 100kHz bandwidth outside the frequency band in which the EUT is operating, the radio frequency power that is produced by the intentional radiator shall be at least 20dB below that in the 100kHz bandwidth within the band that contains the highest level of desired power.

The frequency spectrum above 1 GHz for Transmitter was investigated. All emission not reported are much lower than the prescribed limits. Set the RBW=1MHz,VBW=3MHz for Peak Detector while the RBW=1MHz,VBW=10Hz for Average Detector,Readings are both peak and average values.

Frequency (MHz)	Distance (Meters)	Radiated (dBµV/m)	Radiated (µV/m)
0.009-0.49	300	20log(2400/F(KHz))+80	2400/F(KHz)
0.49-1.705	30	20log(24000/F(KHz))+40	24000/F(KHz)
1.705-30	30	20log(30)+40	30
30-88	3	40.0	100
88-216	3	43.5	150
216-960	3	46.0	200
Above 960	3	54.0	500

TEST RESULTS

Remark:

1. The radiated measurement are performed the each channel (low/mid/high), the datum recorded below (the middle channel) is the worst case for all test channels.
2. ULTRA-BROADBAND ANTENNA for the radiation emission test below 1G.
3. HORN ANTENNA for the radiation emission test above 1G.
4. We tested both battery powered and powered by adapter charging mode at three orientations,recored woest case at powered by adapter charging mode.

For 9KHz to 30MHz

Frequency (MHz)	Corrected Reading (dBµV/m)@3m	FCC Limit (dBµV/m) @3m	Margin (dB)	Detector	Result
12.00	40.65	69.54	28.89	QP	PASS
24.00	40.39	69.54	29.15	QP	PASS

For 30MHz to 1000MHz

SWEEP TABLE: "test (30M-1G)"
 Short Description: Field Strength

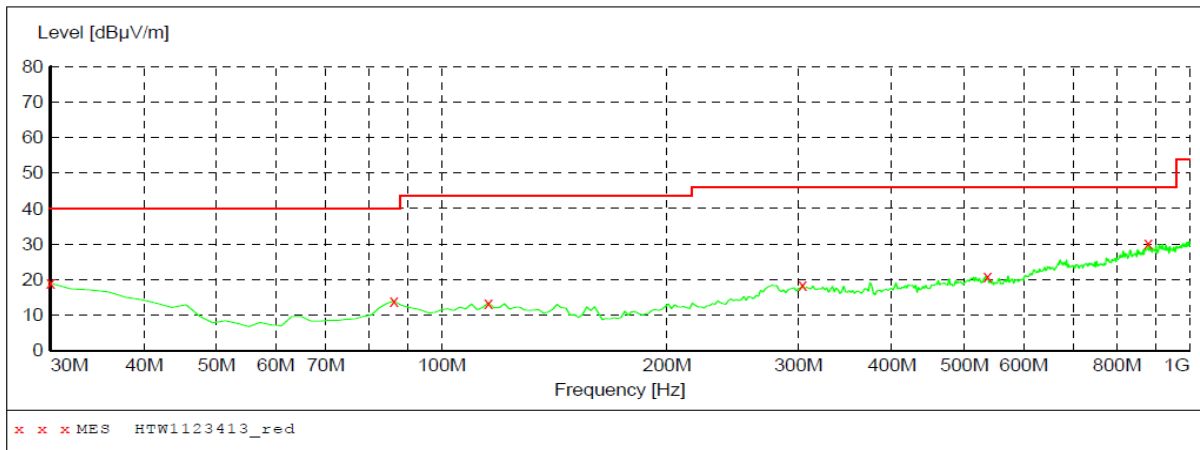

MEASUREMENT RESULT: "HTW1123413_red"

12/09/2013 11:49AM

Frequency MHz	Level dBµV/m	Transd dB	Limit dBµV/m	Margin dB	Det.	Height cm	Azimuth deg	Polarization
30.000000	19.00	-10.0	40.0	21.0	Pk	100.0	177.00	HORIZONTAL
86.372745	14.00	-19.4	40.0	26.0	Pk	100.0	359.00	HORIZONTAL
115.531062	13.50	-18.1	43.5	30.0	Pk	100.0	331.00	HORIZONTAL
304.088176	18.60	-15.1	46.0	27.4	Pk	200.0	306.00	HORIZONTAL
537.354709	20.90	-11.4	46.0	25.1	Pk	100.0	0.00	HORIZONTAL
881.422846	30.10	-4.4	46.0	15.9	Pk	100.0	65.00	HORIZONTAL

SWEEP TABLE: "test (30M-1G)"
 Short Description: Field Strength

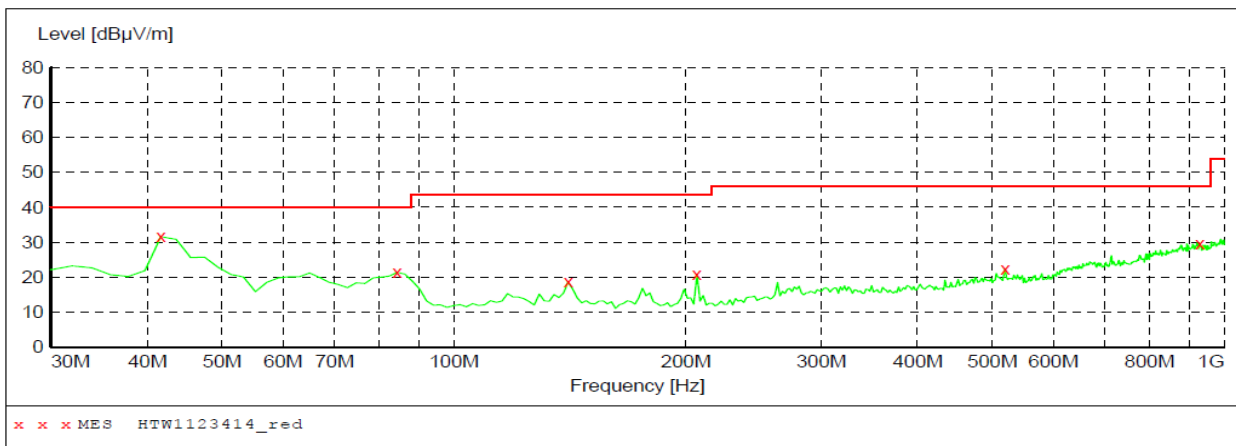

MEASUREMENT RESULT: "HTW1123414_red"

12/09/2013 11:51AM

Frequency MHz	Level dBµV/m	Transd dB	Limit dBµV/m	Margin dB	Det.	Height cm	Azimuth deg	Polarization
41.663327	31.60	-16.2	40.0	8.4	Pk	100.0	154.00	VERTICAL
84.428858	21.40	-19.7	40.0	18.6	Pk	100.0	40.00	VERTICAL
140.801603	18.70	-20.1	43.5	24.8	Pk	200.0	66.00	VERTICAL
206.893788	20.80	-19.4	43.5	22.7	Pk	100.0	349.00	VERTICAL
519.859719	22.40	-11.0	46.0	23.6	Pk	200.0	0.00	VERTICAL
930.020040	29.70	-4.5	46.0	16.3	Pk	100.0	195.00	VERTICAL

For 1GHz to 25GHz

ANTENNA POLARITY & TEST DISTANCE: HORIZONTAL AT 3 M (Ch00-2402MHz)												
No.	Frequency (MHz)	Emission Level (dBuV/m)		Limit (dBuV/m)	Margin (dB)	Antenna Height (m)	Table Angle (Degree)	Raw Value (dBuV)	Antenna Factor (dB/m)	Cable Factor (dB)	Pre-amplifier	Correction Factor (dB/m)
1	4804.00	65.28	PK	74.00	8.72	1.00 H	107	63.20	31.58	7.00	36.5	2.08
2	4804.00	46.72	AV	54.00	7.28	1.00 H	107	44.64	31.58	7.00	36.5	2.08
3	7206.00	50.97	PK	74.00	23.03	1.00 H	142	40.31	37.06	8.90	35.3	10.66

ANTENNA POLARITY & TEST DISTANCE: VERTICAL AT 3 M (Ch00-2402MHz)												
No.	Frequency (MHz)	Emission Level (dBuV/m)		Limit (dBuV/m)	Margin (dB)	Antenna Height (m)	Table Angle (Degree)	Raw Value (dBuV)	Antenna Factor (dB/m)	Cable Factor (dB)	Pre-amplifier	Correction Factor (dB/m)
1	4804.00	66.49	PK	74.00	7.51	1.00 V	314	64.41	31.58	7.00	36.5	2.08
2	4804.00	48.40	AV	54.00	5.6	1.00 V	314	46.32	31.58	7.00	36.5	2.08
3	7206.00	51.61	PK	74.00	22.39	1.00 V	89	40.95	37.06	8.90	35.3	10.66

ANTENNA POLARITY & TEST DISTANCE: HORIZONTAL AT 3 M (Ch19-2440MHz)												
No.	Frequency (MHz)	Emission Level (dBuV/m)		Limit (dBuV/m)	Margin (dB)	Antenna Height (m)	Table Angle (Degree)	Raw Value (dBuV)	Antenna Factor (dB/m)	Cable Factor (dB)	Pre-amplifier	Correction Factor (dB/m)
1	4882.00	63.39	PK	74.00	10.61	1.00 H	253	61.25	31.04	7.60	36.5	2.14
2	4882.00	47.14	AV	54.00	6.86	1.00 H	253	45.00	31.04	7.60	36.5	2.14
3	7323.00	52.77	PK	74.00	21.23	1.00 H	117	41.63	37.84	8.60	35.3	11.14

ANTENNA POLARITY & TEST DISTANCE: VERTICAL AT 3 M (Ch19-2440MHz)												
No.	Frequency (MHz)	Emission Level (dBuV/m)		Limit (dBuV/m)	Margin (dB)	Antenna Height (m)	Table Angle (Degree)	Raw Value (dBuV)	Antenna Factor (dB/m)	Cable Factor (dB)	Pre-amplifier	Correction Factor (dB/m)
1	4882.00	61.30	PK	74.00	12.7	1.00 V	169	59.16	31.04	7.60	36.5	2.14
2	4882.00	47.09	AV	54.00	6.91	1.00 V	169	44.95	31.04	7.60	36.5	2.14
3	7323.00	53.40	PK	74.00	20.6	1.00 V	36	42.26	37.84	8.60	35.3	11.14

ANTENNA POLARITY & TEST DISTANCE: HORIZONTAL AT 3 M (Ch39-2480MHz)												
No.	Frequency (MHz)	Emission Level (dBuV/m)		Limit (dBuV/m)	Margin (dB)	Antenna Height (m)	Table Angle (Degree)	Raw Value (dBuV)	Antenna Factor (dB/m)	Cable Factor (dB)	Pre-amplifier	Correction Factor (dB/m)
1	4960.00	63.24	PK	74.00	10.76	1.00 H	314	60.81	31.76	7.00	36.2	2.43
2	4960.00	44.49	AV	54.00	9.51	1.00 H	314	42.06	31.76	7.00	36.2	2.43
3	7340.00	52.98	PK	74.00	21.02	1.00 H	46	41.38	38.53	8.50	35.3	11.60

ANTENNA POLARITY & TEST DISTANCE: VERTICAL AT 3 M (Ch39-2480MHz)												
No.	Frequency (MHz)	Emission Level (dBuV/m)		Limit (dBuV/m)	Margin (dB)	Antenna Height (m)	Table Angle (Degree)	Raw Value (dBuV)	Antenna Factor (dB/m)	Cable Factor (dB)	Pre-amplifier	Correction Factor (dB/m)
1	4960.00	62.81	PK	74.00	11.19	1.00 V	257	60.38	31.63	7.00	-36.2	2.43
2	4960.00	45.36	AV	54.00	8.64	1.00 V	257	42.93	31.63	7.00	-36.2	2.43
3	7340.00	54.21	PK	74.00	19.79	1.00 V	168	42.61	38.40	8.50	-35.3	11.60

- REMARKS:**
1. Emission level (dBuV/m) = Raw Value (dBuV) + Correction Factor (dB/m)
 2. Correction Factor (dB/m) = Antenna Factor (dB/m) + Cable Factor (dB) - Pre-amplifier
 3. The other emission levels were very low against the limit.
 4. Margin value = Limit value - Emission level.
 5. The average measurement was not performed when the peak measured data under the limit of average detection

4.3. Maximum Peak Output Power

TEST CONFIGURATION

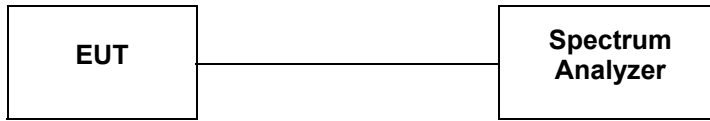

TEST PROCEDURE

The EUT was directly connected to the spectrum analyzer and antenna output port as show in the block diagram as TEST CONFIGURATION shows.

Accoding to KDB558074 D01 V03 Integrated band power method for this procedure may be used when the maximum available RBW of the measurement instrument is less than the DTS bandwidth.

1. Set the RBW =1 MHz.
2. Set the VBW =3 MHz.
3. Set the span =3 MHz.
4. Detector = peak.
5. Sweep time = auto couple.
6. Trace mode = max hold.
7. Allow trace to fully stabilize.
8. Use peak marker function to determine the peak amplitude level.

LIMIT

The Maximum Peak Output Power Measurement is 30dBm.

TEST RESULTS

A. Test Verdict

Channel	Frequency (MHz)	Measured Output Peak Power (dBm)	Refer to Plot	Limits (dBm)	Verdict
00	2402	-3.25	Plot 4.3.1 A	30	PASS
19	2440	-4.24	Plot 4.3.1 B	30	PASS
39	2480	-4.11	Plot 4.3.1 C	30	PASS

Note: 1.The test results including the cable lose.

B. Test Plots



*RBW 1 MHz Marker 1 [T1]
*VBW 3 MHz -3.25 dBm
SWT 5 ms 2.402159000 GHz

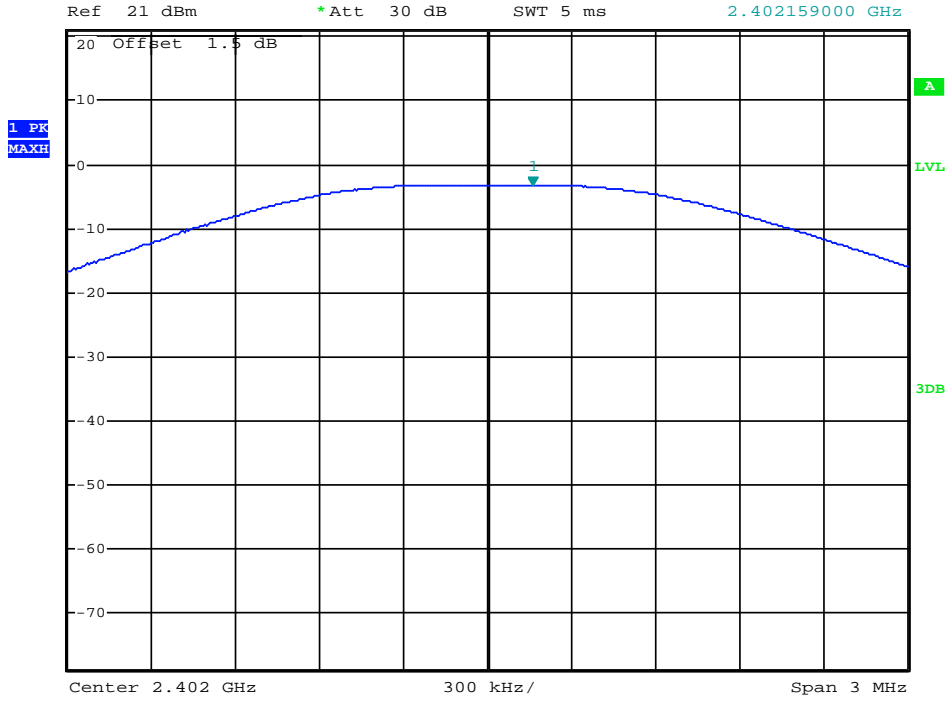

Date: 15.DEC.2013 14:07:49

(Plot 4.3.1 A: Channel 00: 2402MHz @ GFSK)



*RBW 1 MHz Marker 1 [T1]
*VBW 3 MHz -4.24 dBm
SWT 5 ms 2.440102000 GHz

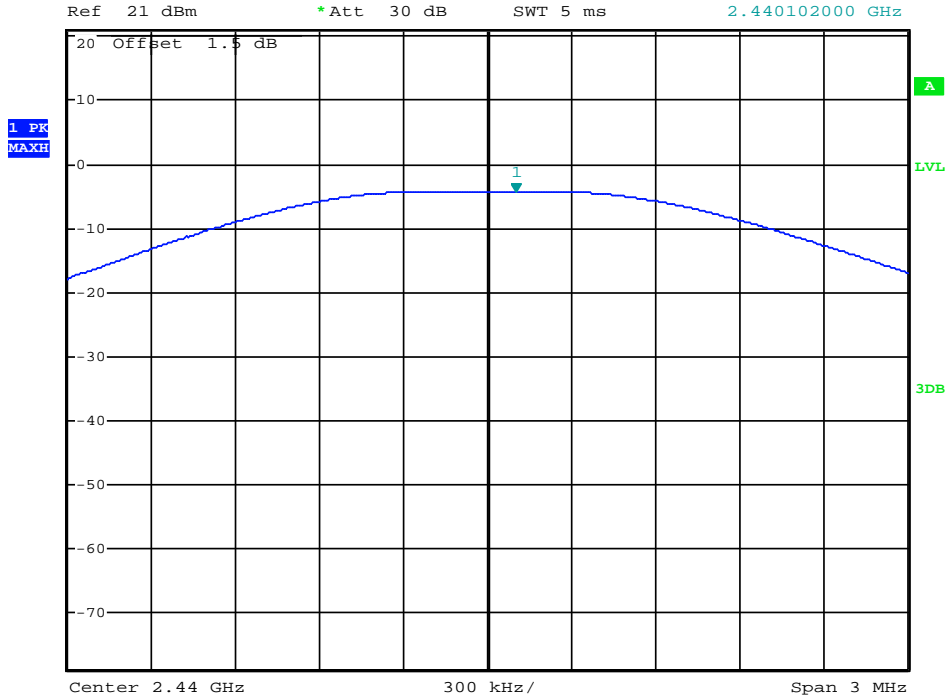

Date: 15.DEC.2013 14:08:25

(Plot 4.3.1 B: Channel 19: 2440 MHz @ GFSK)



*RBW 1 MHz Marker 1 [T1]
*VBW 3 MHz -4.11 dBm
SWT 5 ms 2.480237000 GHz

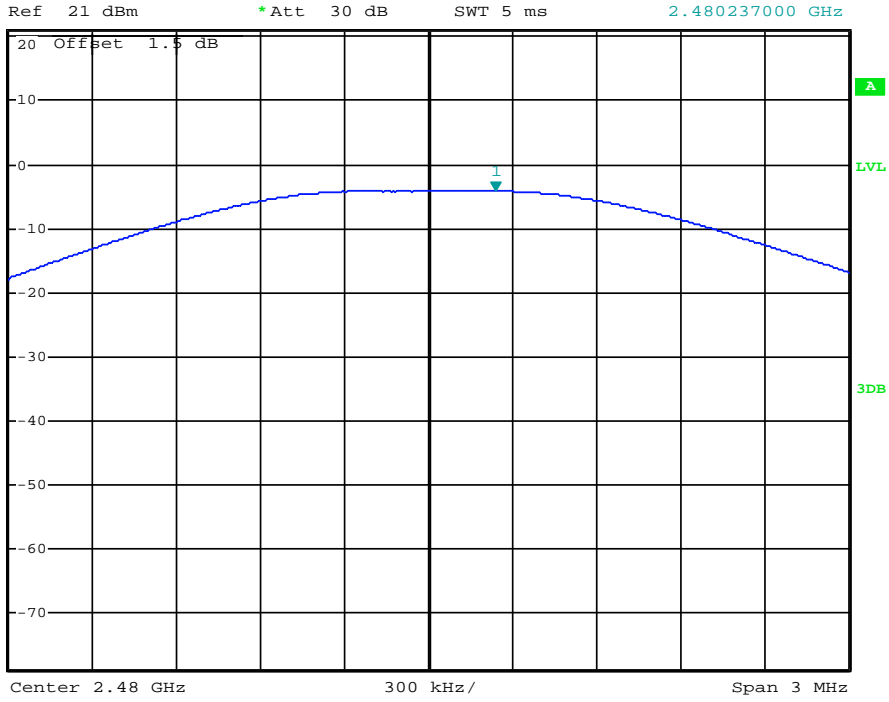

Date: 15.DEC.2013 14:09:07

(Plot 4.3.1 C: Channel 39: 2480 MHz @ GFSK)

4.4. Power Spectral Density

TEST CONFIGURATION

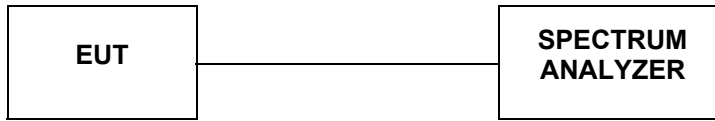

TEST PROCEDURE

According to KDB 558074 D01 V03 Method PKPSD (peak PSD) This procedure shall be used if maximum peak conducted output power was used to demonstrate compliance, and is optional if the maximum conducted (average) output power was used to demonstrate compliance.

1. Set analyzer center frequency to DTS channel center frequency.
2. Set the span to 1.5 times the DTS bandwidth.
3. Set the RBW to: $3 \text{ kHz} \leq \text{RBW} \leq 100 \text{ kHz}$.
4. Set the VBW $\geq 3 \text{ RBW}$.
5. Detector = peak.
6. Sweep time = auto couple.
7. Trace mode = max hold.
8. Allow trace to fully stabilize.
9. Use the peak marker function to determine the maximum amplitude level within the RBW.
10. If measured value exceeds limit, reduce RBW (no less than 3 kHz) and repeat.

LIMIT

For digitally modulated systems, the power spectral density conducted from the intentional radiator to the antenna shall not be greater than 8 dBm in any 3 kHz band during any time interval of continuous transmission.

TEST RESULTS

A. Test Verdict

Channel	Frequency (MHz)	Report PSD (dBm/3kHz)	Refer to Plot	Limits (dBm/3KHz)	Verdict
00	2402	-20.42	Plot 4.4.1 A	8	PASS
19	2440	-19.21	Plot 4.4.1 B	8	PASS
39	2480	-19.23	Plot 4.4.1 C	8	PASS

Note 1. The test results including the cable lose.

B. Test Plots



*RBW 3 kHz Marker 1 [T1]
*VBW 10 kHz -20.42 dBm
SWT 115 ms 2.479978328 GHz

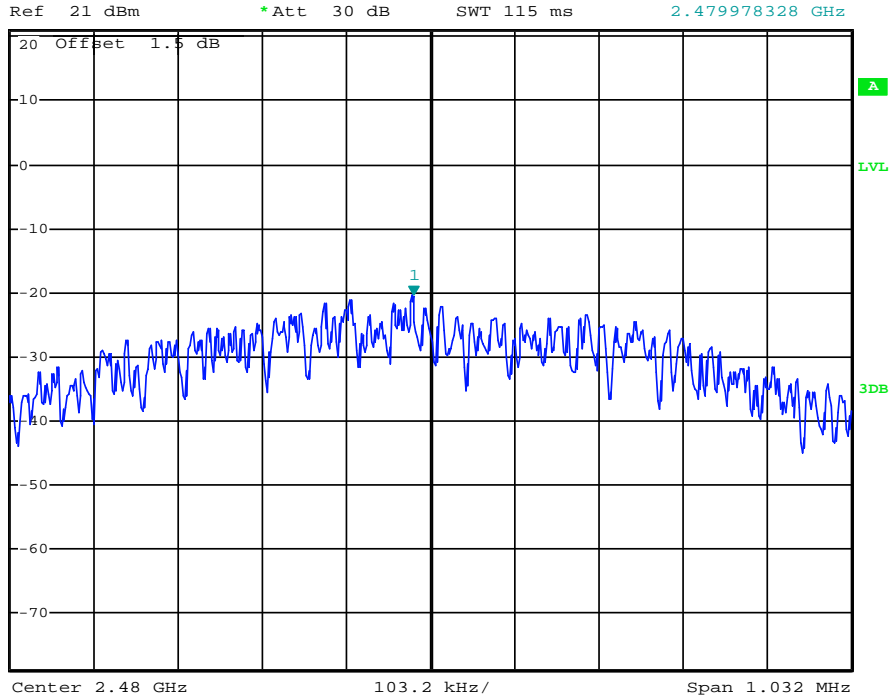

Date: 15.DEC.2013 14:06:26

(Plot 4.4.1 A: Channel 00: 2402 MHz @ GFSK)



*RBW 3 kHz Marker 1 [T1]
*VBW 10 kHz -19.21 dBm
SWT 115 ms 2.439977296 GHz

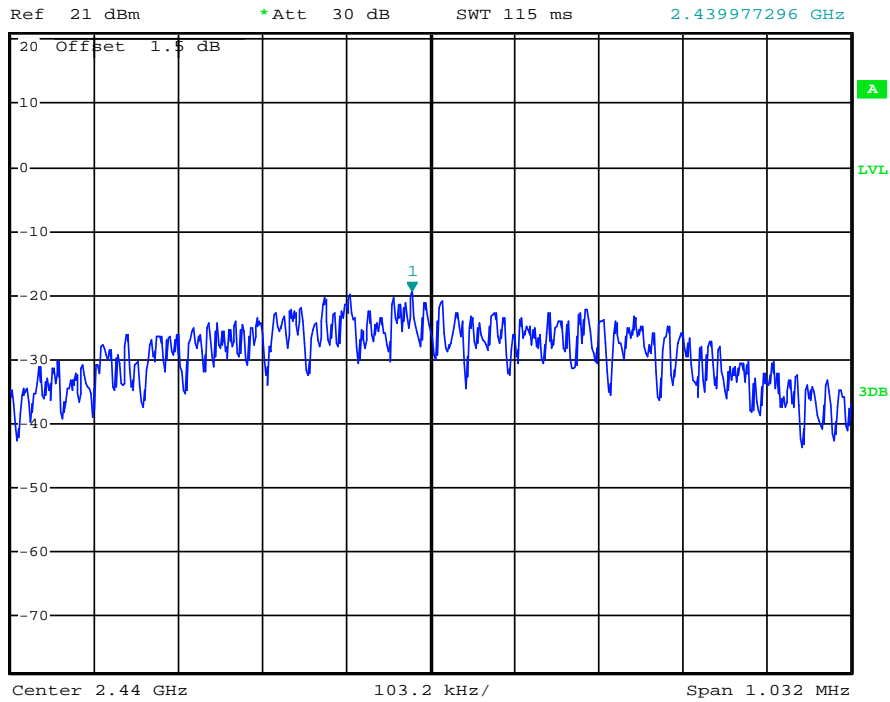

Date: 15.DEC.2013 14:06:48

(Plot 4.4.1 B: Channel 19: 2440 MHz @ GFSK)



*RBW 3 kHz Marker 1 [T1]
*VBW 10 kHz -19.23 dBm
SWT 115 ms 2.401979360 GHz

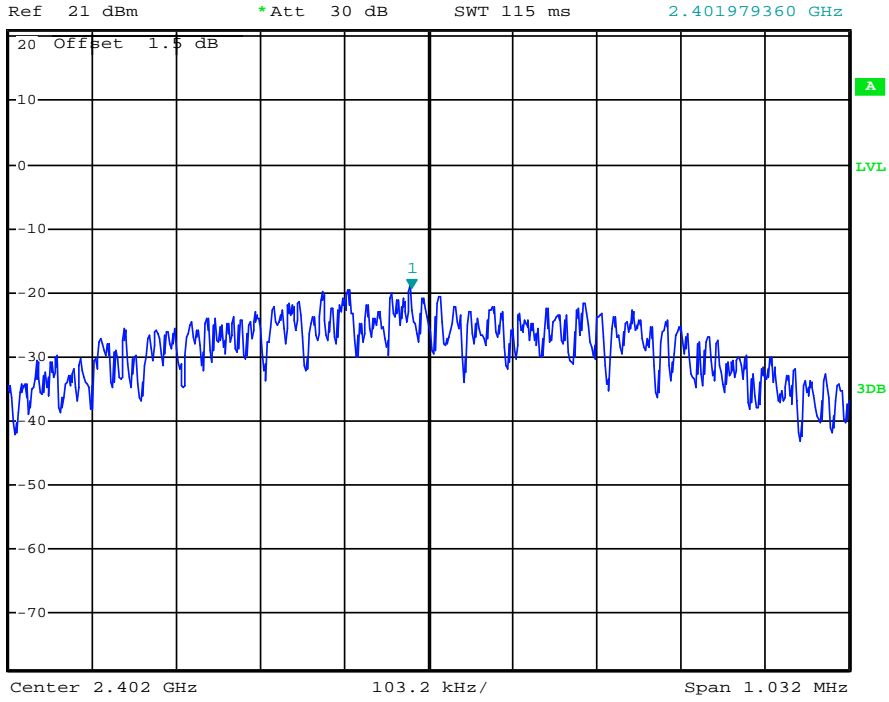

Date: 15.DEC.2013 14:07:06

(Plot 4.4.1 C: Channel 39: 2480 MHz @ GFSK)

4.5. Band Edge Compliance of RF Emission

Applicable Standard

In any 100 kHz bandwidth outside the frequency band in which the spread spectrum or digitally modulated intentional radiator is operating, the radio frequency power that is produced by the intentional radiator shall be at least 20 dB below that in the 100 kHz bandwidth within the band that contains the highest level of the desired power, based on either an RF conducted or a radiated measurement, provided the transmitter demonstrates compliance with the peak conducted power limits. If the transmitter complies with the conducted power limits based on the use of RMS averaging over a time interval, as permitted under paragraph (b)(3) of this section, the attenuation required under this paragraph shall be 30 dB instead of 20 dB. Attenuation below the general limits specified in §15.209(a) is not required. In addition, radiated emissions which fall in the restricted bands, as defined in §15.205(a), must also comply with the radiated emission limits specified in §15.209(a) (see §15.205(c)).

TEST PROCEDURE

1. Check the calibration of the measuring instrument using either an internal calibrator or a known signal from an external generator.
2. Remove the antenna from the EUT and then connect to a low loss RF cable from the antenna port to a EMI test receiver, then turn on the EUT and make it operate in transmitting mode. Then set it to Low Channel and High Channel within its operating range, and make sure the instrument is operated in its linear range.
3. Set both RBW and VBW of spectrum analyzer to 100 kHz with a convenient frequency span including 100kHz bandwidth from band edge, for Radiated emissions restricted band RBW=1MHz, VBW=3MHz.
4. Measure the highest amplitude appearing on spectral display and set it as a reference level. Plot the graph with marking the highest point and edge frequency.
5. Repeat above procedures until all measured frequencies were complete.

TEST RESULTS

4.5.1 For Radiated Bandedge Measurement

4.5.1.1 Test Result

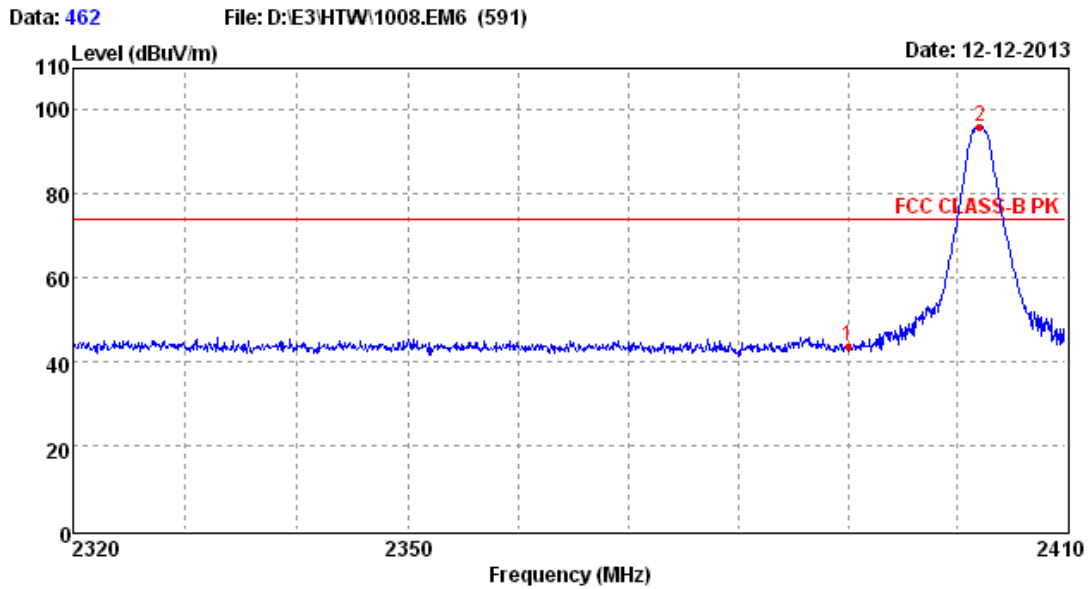

Mark	Frequency (MHz)	Level (dBuV/m)	Cable Loss (dB)	Antenna Factor (dB/m)	Preamp Factor (dB)	Reading Level (dBuV/m)	Limit (dBuV/m)	Margin (dB)	Antenna Polarization	Detector
1	2390.00	43.95	3.32	27.49	36.12	49.23	74.00	30.05	Hor	Peak
2	2402.13	96.03	3.32	27.49	36.12	101.34	74.00	-22.03	Hor	Peak

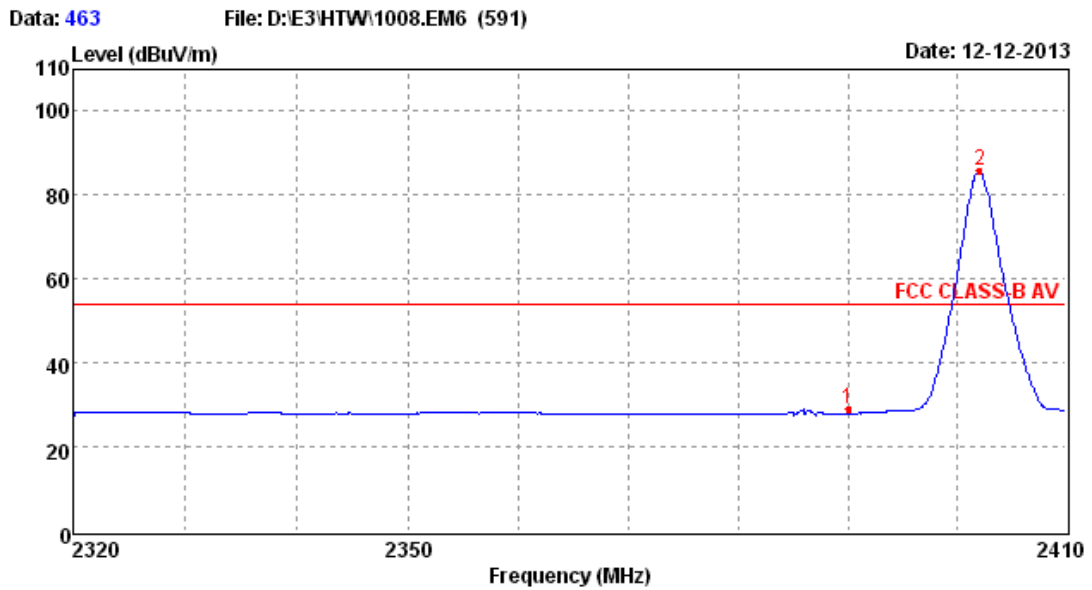

Mark	Frequency (MHz)	Level (dBuV/m)	Cable Loss (dB)	Antenna Factor (dB/m)	Preamp Factor (dB)	Reading Level (dBuV/m)	Limit (dBuV/m)	Margin (dB)	Antenna Polarization	Detector
1	2390.00	28.92	3.32	27.49	36.12	34.20	54.00	25.08	Hor	Average
2	2402.13	85.96	3.32	27.49	36.12	91.27	54.00	-31.96	Hor	Average

Data: 464 File: D:\E3\HTW\1008.EM6 (591)

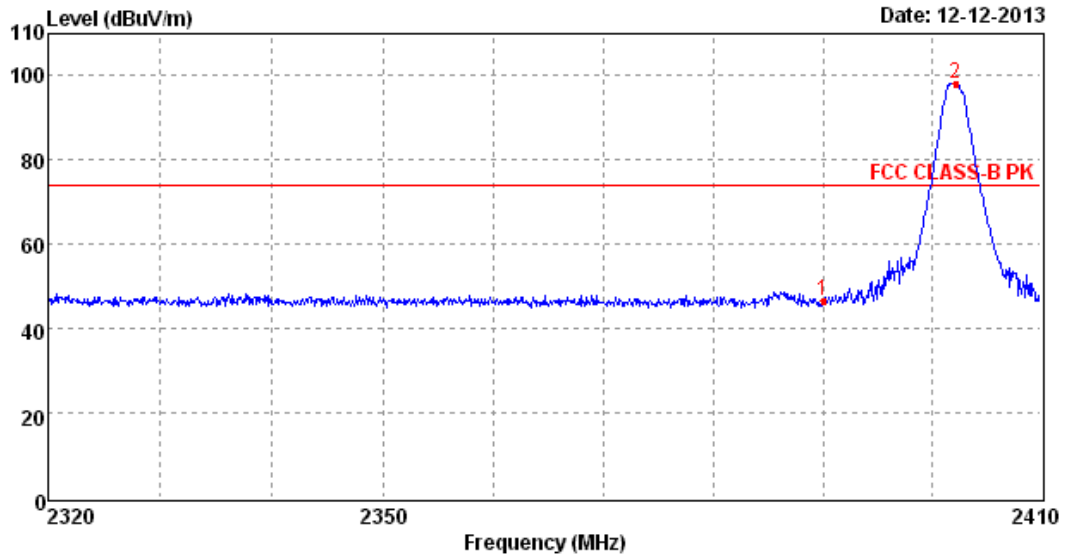

Mark	Frequency (MHz)	Level (dBuV/m)	Cable Loss (dB)	Antenna Factor (dB/m)	Preamp Factor (dB)	Reading Level (dBuV/m)	Limit (dBuV/m)	Margin (dB)	Antenna Polarization	Detector
1	2390.00	46.58	3.32	27.49	36.12	51.86	74.00	27.42	Ver	Peak
2	2402.22	98.34	3.32	27.49	36.12	103.65	74.00	-24.34	Ver	Peak

Data: 465 File: D:\E3\HTW\1008.EM6 (591)

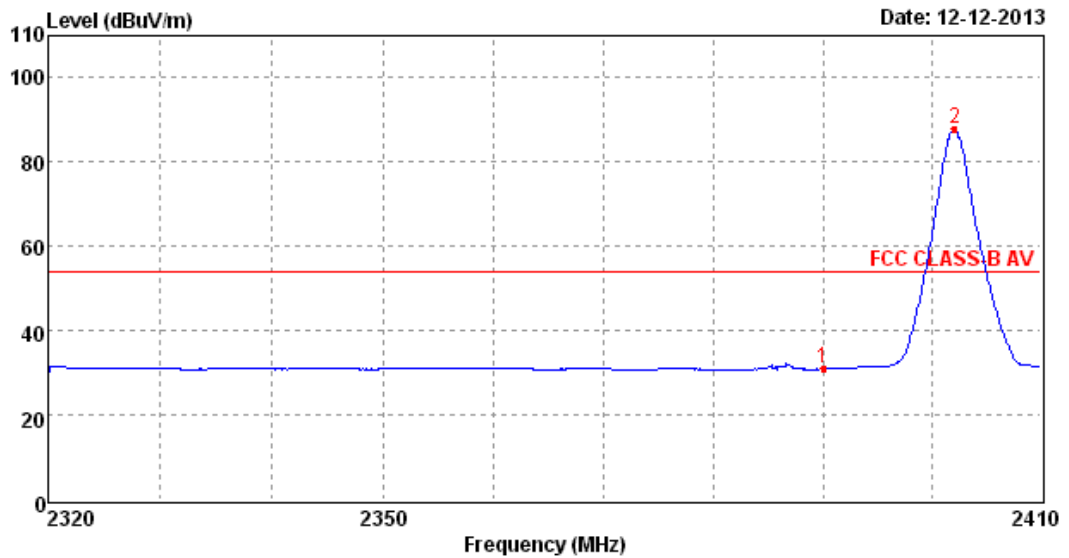

Mark	Frequency (MHz)	Level (dBuV/m)	Cable Loss (dB)	Antenna Factor (dB/m)	Preamp Factor (dB)	Reading Level (dBuV/m)	Limit (dBuV/m)	Margin (dB)	Antenna Polarization	Detector
1	2390.00	30.90	3.32	27.49	36.12	36.18	54.00	23.10	Ver	Average
2	2402.13	88.00	3.32	27.49	36.12	92.31	54.00	-34.00	Ver	Average

Data: 472 File: D:\E3\HTW\1008.EM6 (591)

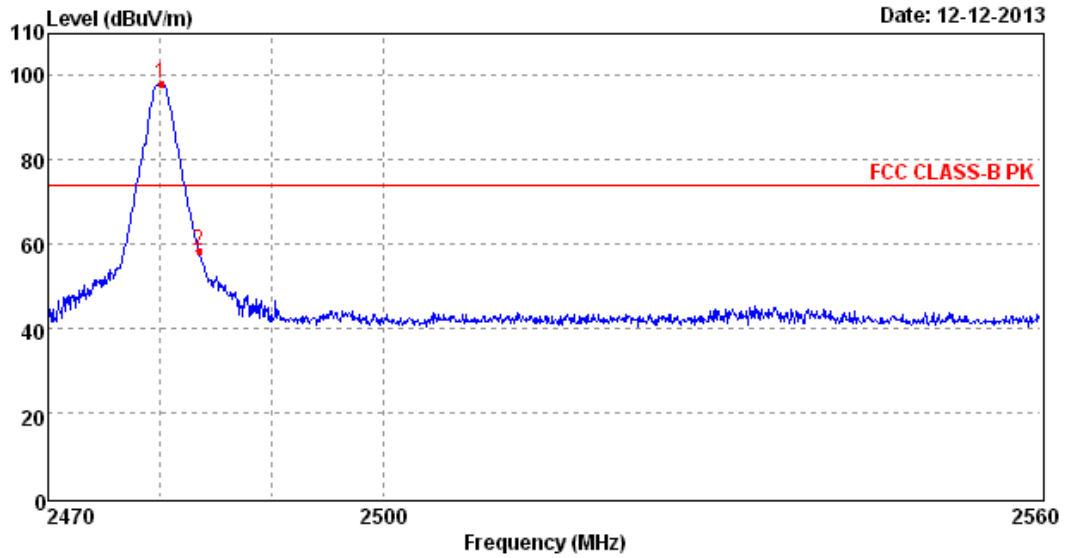

Mark	Frequency (MHz)	Level (dBuV/m)	Cable Loss (dB)	Antenna Factor (dB/m)	Preamp Factor (dB)	Reading Level (dBuV/m)	Limit (dBuV/m)	Margin (dB)	Antenna Polarization	Detector
1	2480.10	97.96	3.88	27.45	36.55	103.18	74.00	-23.96	Hor	Peak
2	2483.50	58.66	3.88	27.45	36.55	63.88	74.00	15.34	Hor	Peak

Data: 473 File: D:\E3\HTW\1008.EM6 (591)

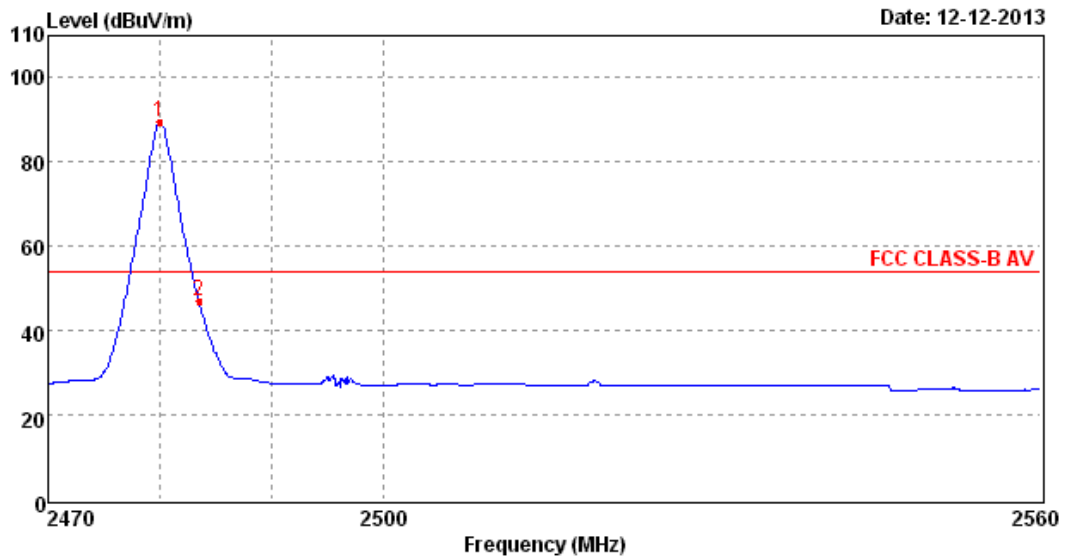

Mark	Frequency (MHz)	Level (dBuV/m)	Cable Loss (dB)	Antenna Factor (dB/m)	Preamp Factor (dB)	Reading Level (dBuV/m)	Limit (dBuV/m)	Margin (dB)	Antenna Polarization	Detector
1	2479.92	89.35	3.88	27.45	36.55	94.57	54.00	-35.35	Hor	Average
2	2483.50	47.17	3.88	27.45	36.55	52.39	54.00	6.83	Hor	Average

Data: 470 File: D:\E3\HTW\1008.EM6 (591)

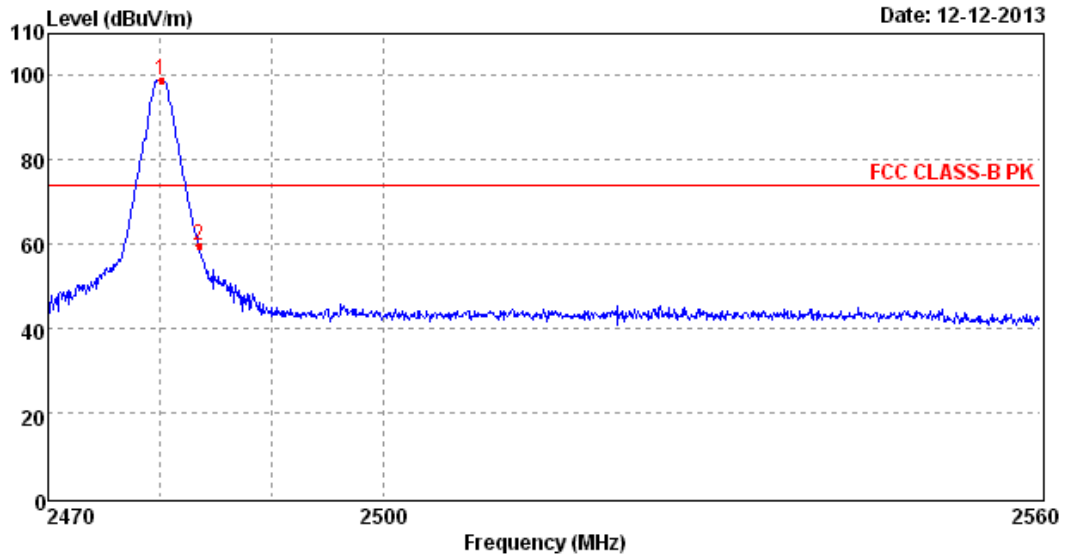

Mark	Frequency (MHz)	Level (dBuV/m)	Cable Loss (dB)	Antenna Factor (dB/m)	Preamp Factor (dB)	Reading Level (dBuV/m)	Limit (dBuV/m)	Margin (dB)	Antenna Polarization	Detector
1	2480.10	98.92	3.88	27.45	36.55	104.14	74.00	-24.92	Ver	Peak
2	2483.50	59.50	3.88	27.45	36.55	64.72	74.00	14.50	Ver	Peak

Data: 471 File: D:\E3\HTW\1008.EM6 (591)

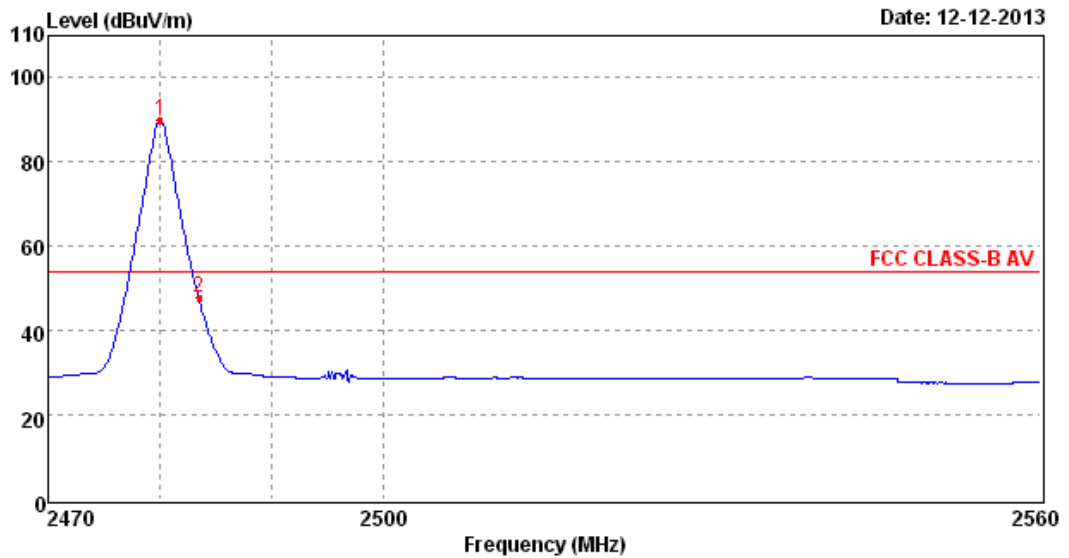

Mark	Frequency (MHz)	Level (dBuV/m)	Cable Loss (dB)	Antenna Factor (dB/m)	Preamp Factor (dB)	Reading Level (dBuV/m)	Limit (dBuV/m)	Margin (dB)	Antenna Polarization	Detector
1	2480.01	89.86	3.88	27.45	36.55	95.08	54.00	-35.86	Ver	Average
2	2483.50	47.75	3.88	27.45	36.55	52.97	54.00	6.25	Ver	Average

4.6. Spurious RF Conducted Emission

TEST CONFIGURATION

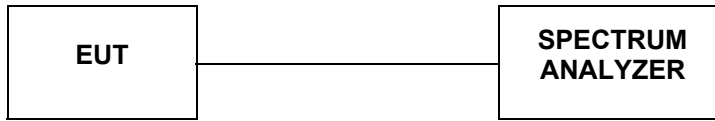

TEST PROCEDURE

The Spurious RF conducted emissions compliance of RF radiated emission should be measured by following the guidance in ANSI C63.10-2009 with respect to maximizing the emission by rotating the EUT, measuring the emission while the EUT is situated in three orthogonal planes (if appropriate), adjusting the measurement antenna height and polarization etc. Set RBW=100kHz and VBM= 300KHz to measure the peak field strength, and measure frequency range from 30MHz to 26.5GHz.

LIMIT

1. Below -20dB of the highest emission level in operating band.
2. Fall in the restricted bands listed in section 15.205. The maximum permitted average field strength is listed in section 15.209.

TEST RESULTS

Remark: The measurement frequency range is from 30MHz to the 10th harmonic of the fundamental frequency. The lowest, middle and highest channels are tested to verify the spurious emissions and bandedge measurement data.

A. Test Verdict

Channel	Frequency (MHz)	Refer to Plot	Limit (dBc)	Verdict
00	2402	Plot 4.6.1 A1	-20	PASS
		Plot 4.6.1 A2	-20	PASS
		Plot 4.6.1 A3	-20	PASS
19	2440	Plot 4.6.1 B1	-20	PASS
		Plot 4.6.1 B2	-20	PASS
		Plot 4.6.1 B3	-20	PASS
39	2480	Plot 4.6.1 C1	-20	PASS
		Plot 4.6.1 C2	-20	PASS
		Plot 4.6.1 C3	-20	PASS

Frequency (MHz)	Delta Peak to Band emission (dBc)	Detector	Limit (dBc)	Refer to Plot	Verdict
2400.00	-44.81	Peak	-20	Plot 4.6.1 D	PASS
2483.50	-45.11	Peak	-20	Plot 4.6.1 E	PASS

Note: 1.The test results including the cable lose.

B. Test Plots

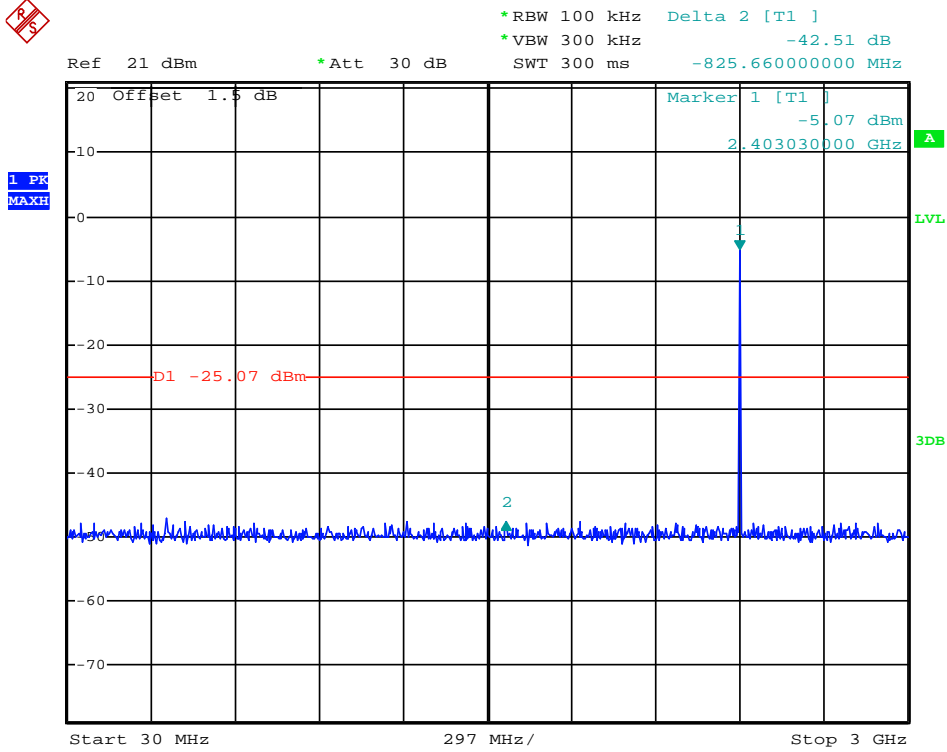

Date: 15.DEC.2013 14:20:51

(Plot 4.6.1 A1: Channel 00: 2402MHz @ GFSK)

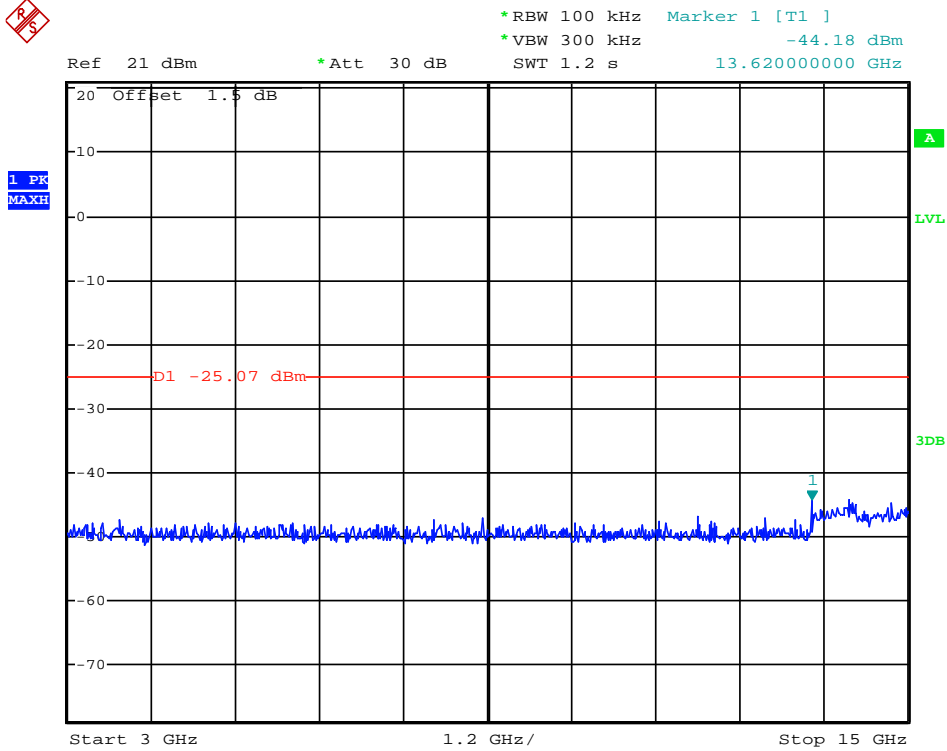

Date: 15.DEC.2013 14:21:11

(Plot 4.6.1 A2: Channel 00: 2402MHz @ GFSK)

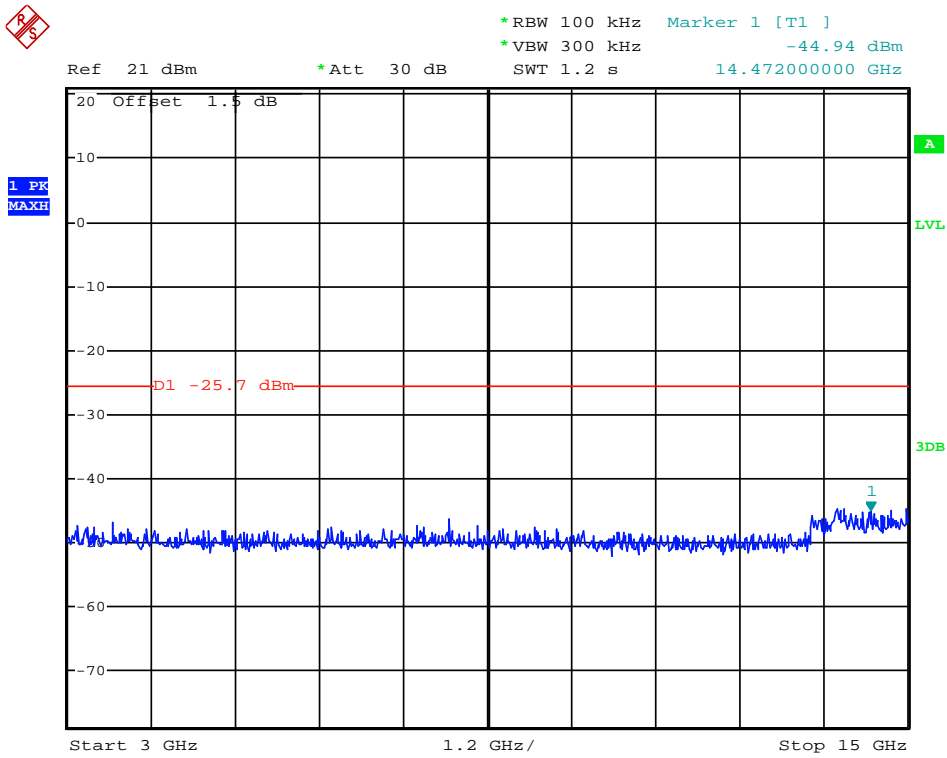

Date: 15.DEC.2013 14:22:26

(Plot 4.6.1 B2: Channel 19: 2440MHz @ GFSK)

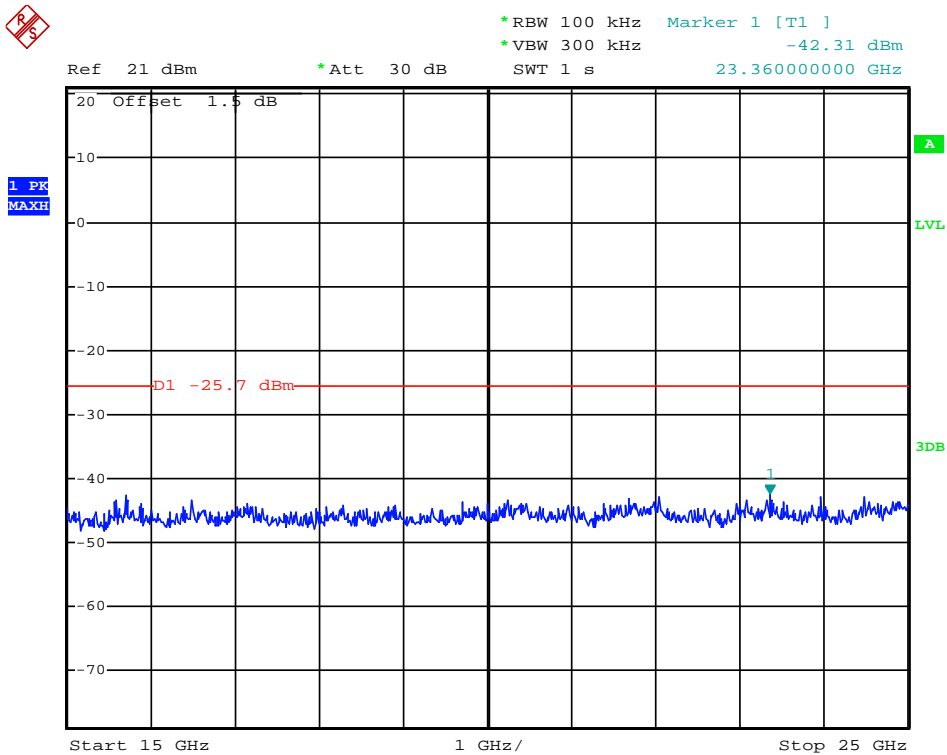

Date: 15.DEC.2013 14:22:42

(Plot 4.6.1 B3: Channel 19: 2440MHz @ GFSK)

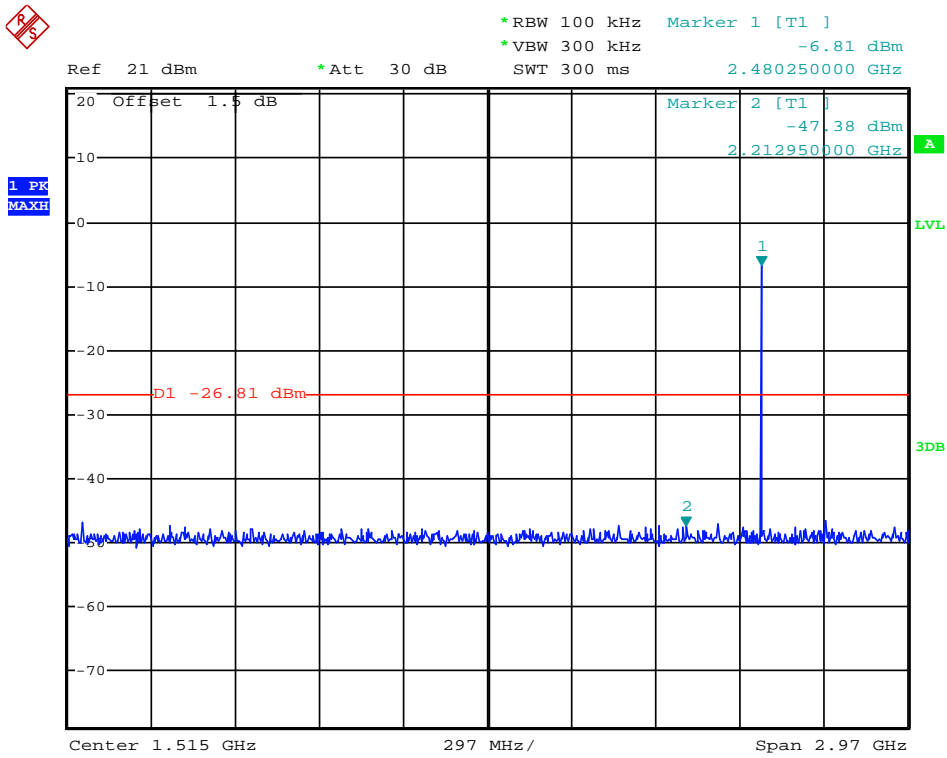

Date: 15.DEC.2013 14:24:16

(Plot 4.6.1 C1: Channel 39: 2480MHz @ GFSK)

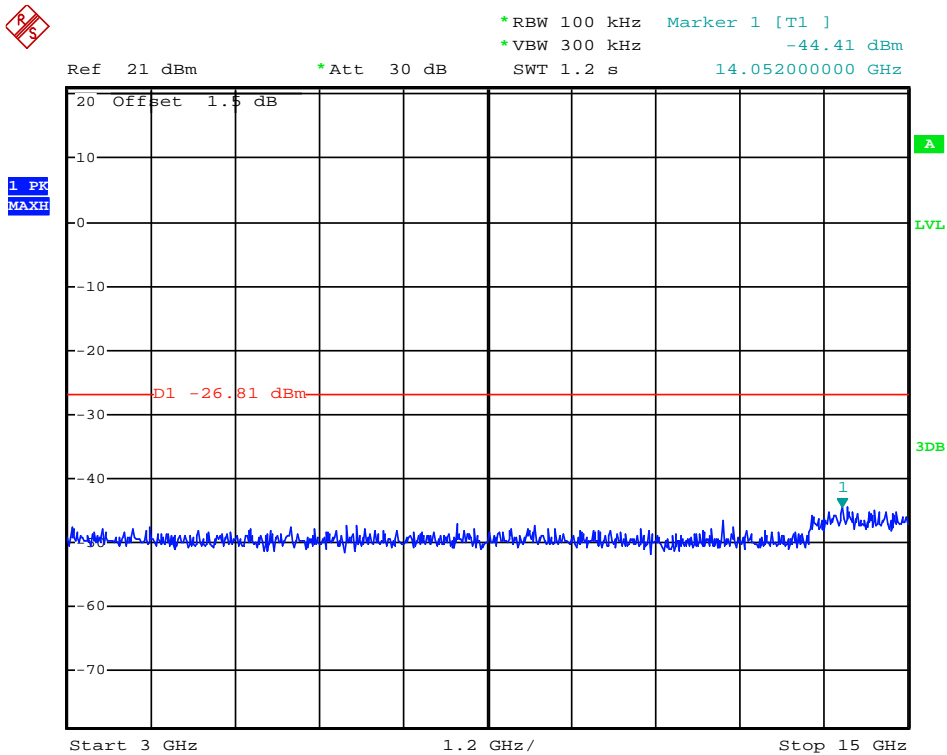

Date: 15.DEC.2013 14:24:38

(Plot 4.6.1 C2: Channel 39: 2480MHz @ GFSK)

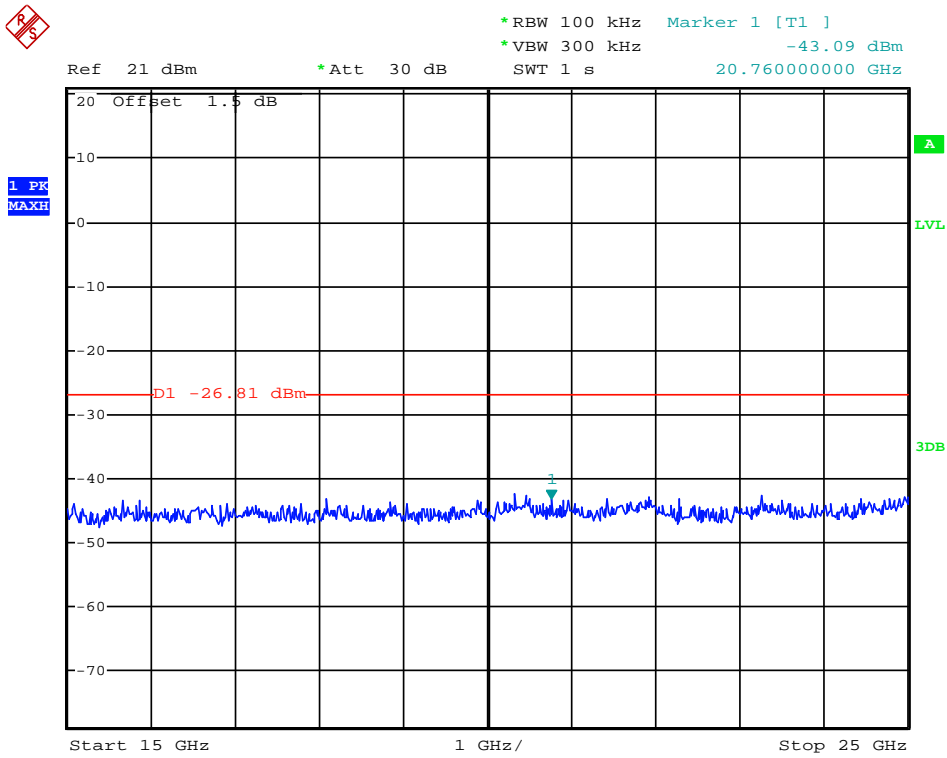

Date: 15.DEC.2013 14:25:00

(Plot 4.6.1 C3: Channel 39: 2480MHz @ GFSK)

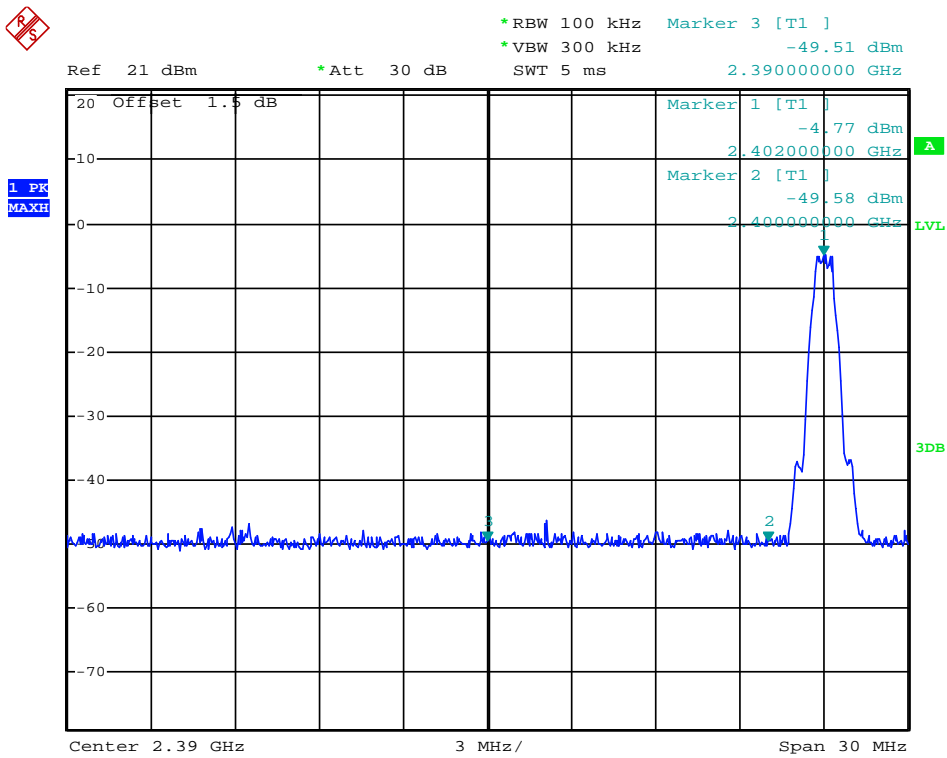

Date: 15.DEC.2013 14:17:55

(Plot 4.6.1 D: Channel 00: 2402MHz @ GFSK)

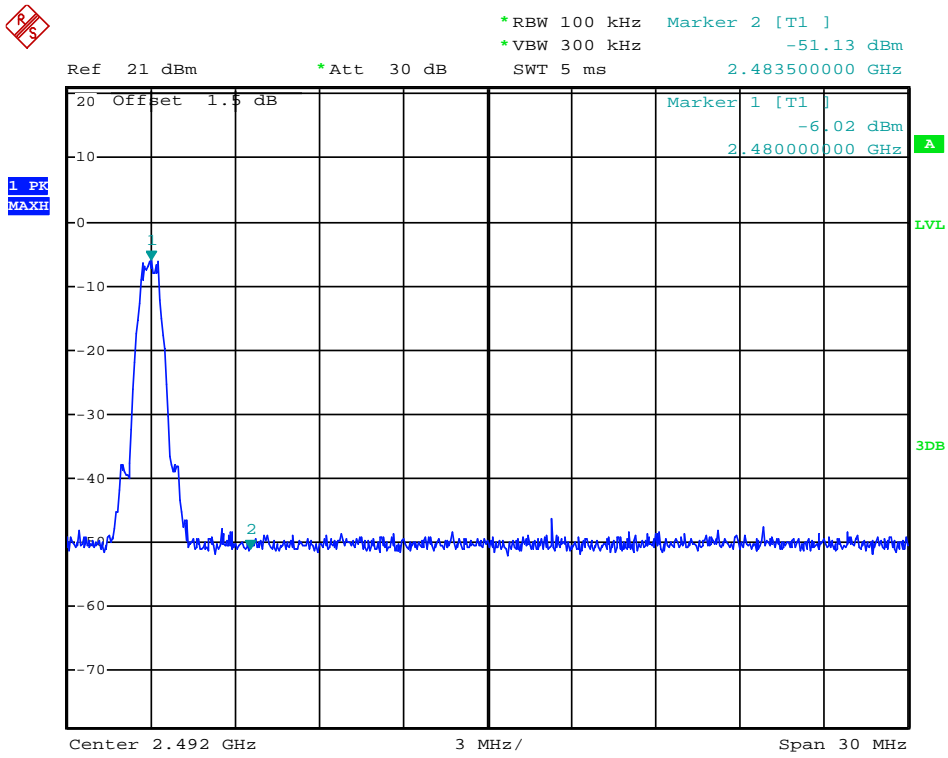

Date: 15.DEC.2013 14:19:16

(Plot 4.6.1 E: Channel 39: 2480MHz @ GFSK)

4.7. 6dB Bandwidth

TEST CONFIGURATION

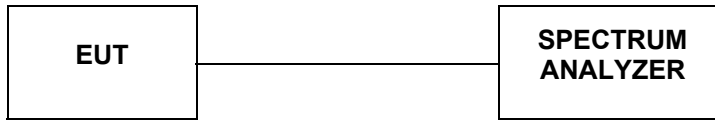

TEST PROCEDURE

The transmitter output was connected to the spectrum analyzer through an attenuator. The bandwidth of the fundamental frequency was measured by spectrum analyzer with 100 KHz RBW and 300KHz VBW. The 6dB bandwidth is defined as the total spectrum the power of which is higher than peak power minus 6dB. According to KDB558074 D01 V03 for one of the following procedures may be used to determine the modulated DTS device signal bandwidth.

1. Set RBW = 100 kHz.
2. Set the video bandwidth (VBW) ≥ 3 RBW.
3. Detector = Peak.
4. Trace mode = max hold.
5. Sweep = auto couple.
6. Allow the trace to stabilize.
7. Measure the maximum width of the emission that is constrained by the frequencies associated with the two outermost amplitude points (upper and lower frequencies) that are attenuated by 6 dB relative to the maximum level measured in the fundamental emission.

LIMIT

For digital modulation systems, the minimum 6 dB bandwidth shall be at least 500 kHz.

TEST RESULTS

A. Test Verdict

Channel	Frequency (MHz)	6 dB Bandwidth (MHz)	Refer to Plot	Limits (kHz)	Verdict
00	2402	0.688	Plot 4.7.1 A	≥ 500	PASS
19	2440	0.682	Plot 4.7.1 B	≥ 500	PASS
39	2480	0.686	Plot 4.7.1 C	≥ 500	PASS

Note: 1.The test results including the cable lose.

B. Test Plots

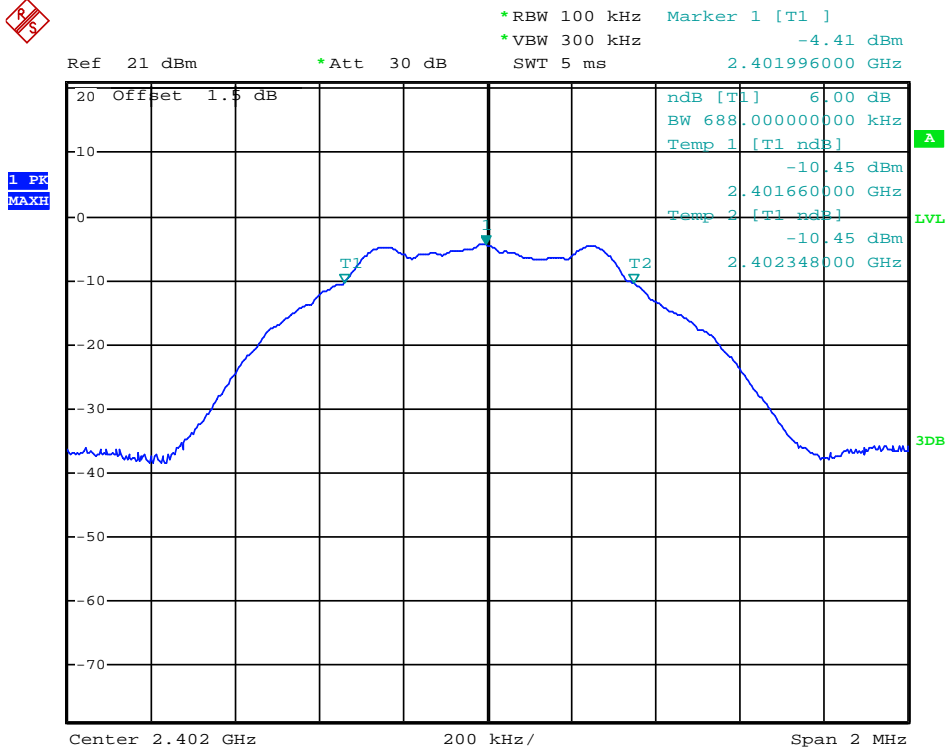

Date: 15.DEC.2013 14:04:01

(Plot 4.7.1 A: Channel 00: 2402MHz @ GFSK)

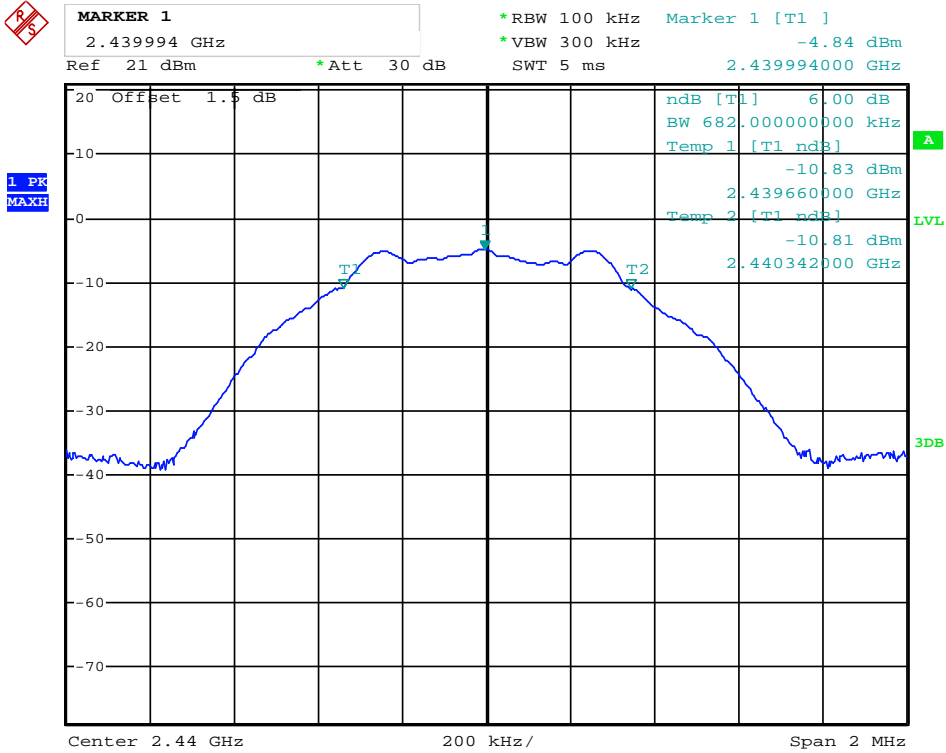

Date: 15.DEC.2013 14:04:39

(Plot 4.7.1 B: Channel 19: 2440MHz @ GFSK)



MARKER 1
2.479992 GHz
Ref 21 dBm *Att 30 dB

*RBW 100 kHz Marker 1 [T1]
*VBW 300 kHz -6.12 dBm
SWT 5 ms 2.479992000 GHz

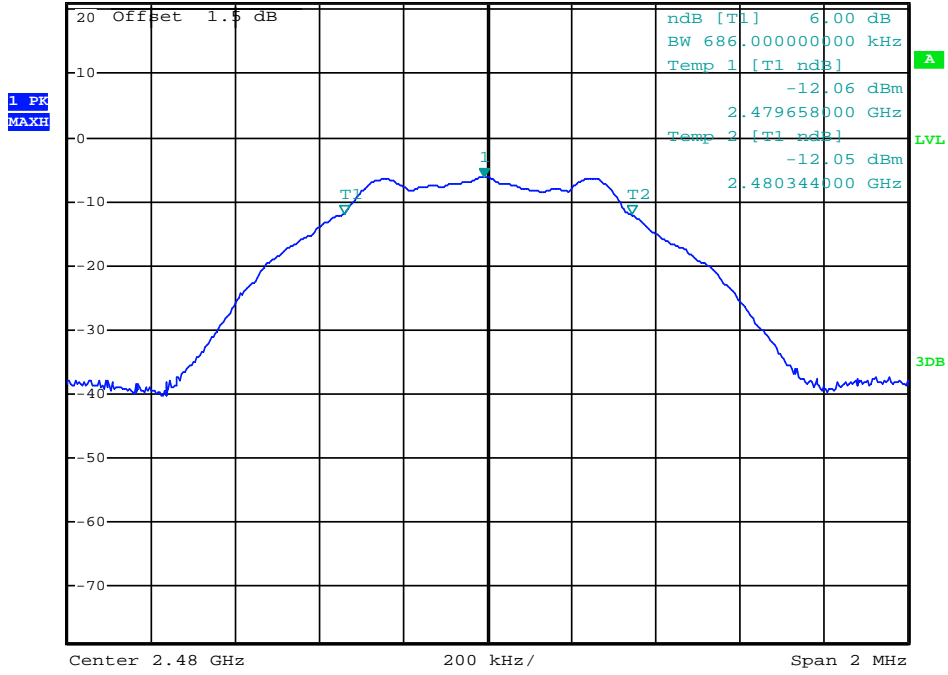

Date: 15.DEC.2013 14:05:21

(Plot 4.7.1 C: Channel 39: 2480MHz @ GFSK)

4.8. Antenna Requirement

Standard Applicable

For intentional device, according to FCC 47 CFR Section 15.203, an intentional radiator shall be designed to ensure that no antenna other than that furnished by the responsible party shall be used with the device.

And according to FCC 47 CFR Section 15.247 (c), if transmitting antennas of directional gain greater than 6dBi are used, the power shall be reduced by the amount in dB that the directional gain of the antenna exceeds 6dBi.

Refer to statement below for compliance

The manufacturer may design the unit so that the user can replace a broken antenna, but the use of a standard antenna jack or electrical connector is prohibited. Further, this requirement does not apply to intentional radiators that must be professionally installed.

Antenna Connected Construction

The WLAN and Bluetooth sharing same antenna and the maximum antenna gain of Bluetooth used was 0.40 dBi.



5. Test Setup Photos of the EUT

Radiated Emission (30MHz-1GHz)

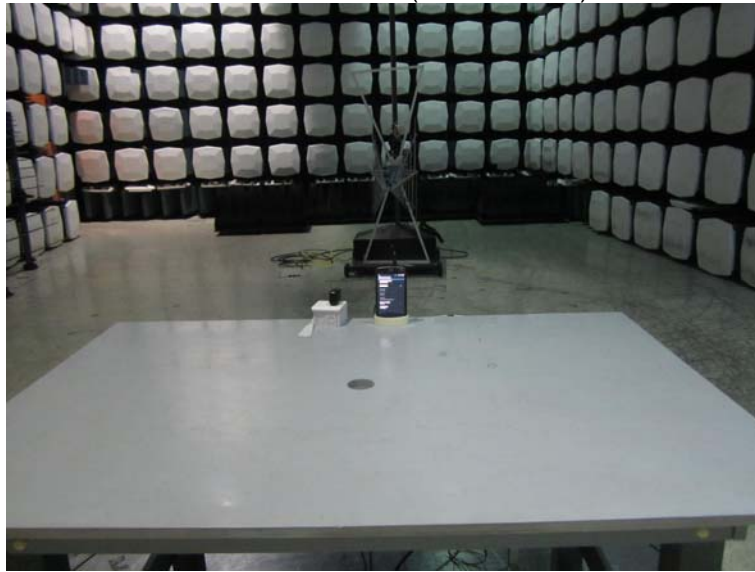

Radiated Emission (above 1GHz)



Radiated Emission (Below 30MHz)



Conducted Emission (AC Mains)



6. External and Internal Photos of the EUT

External photos of the EUT







Internal photos of the EUT

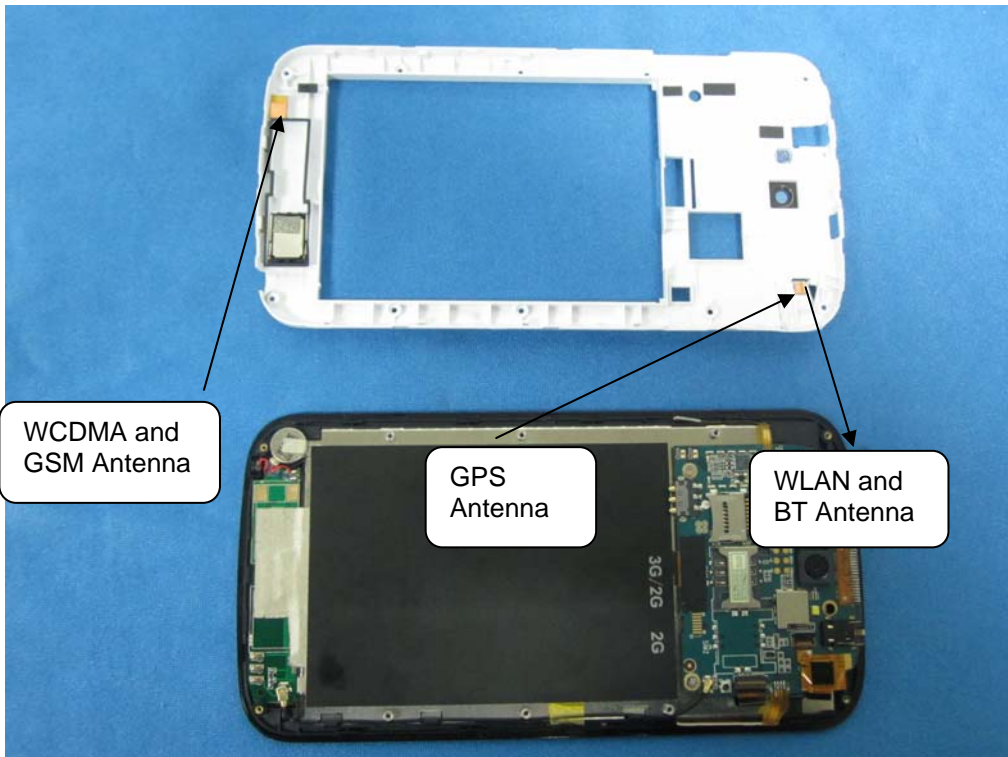

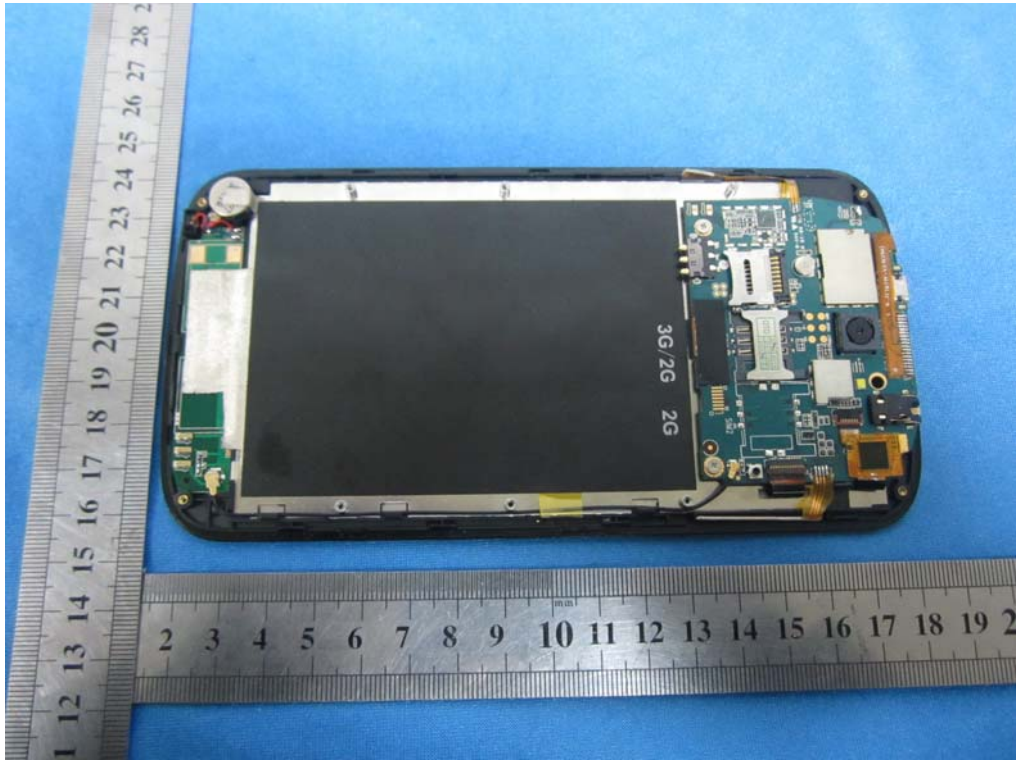

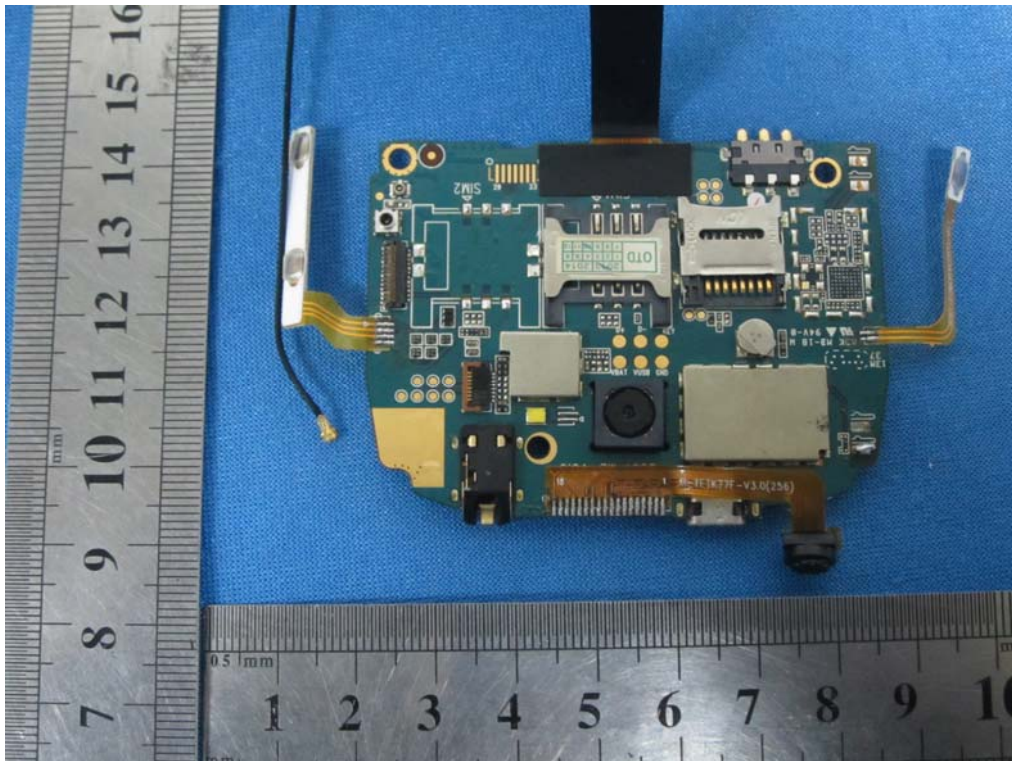

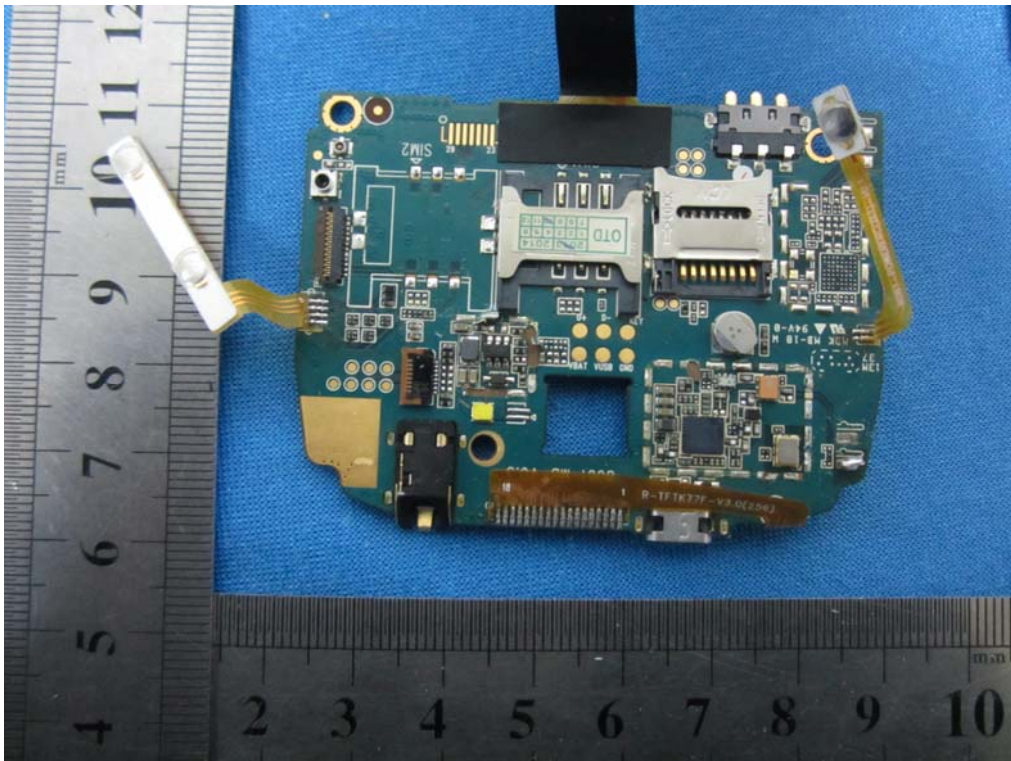
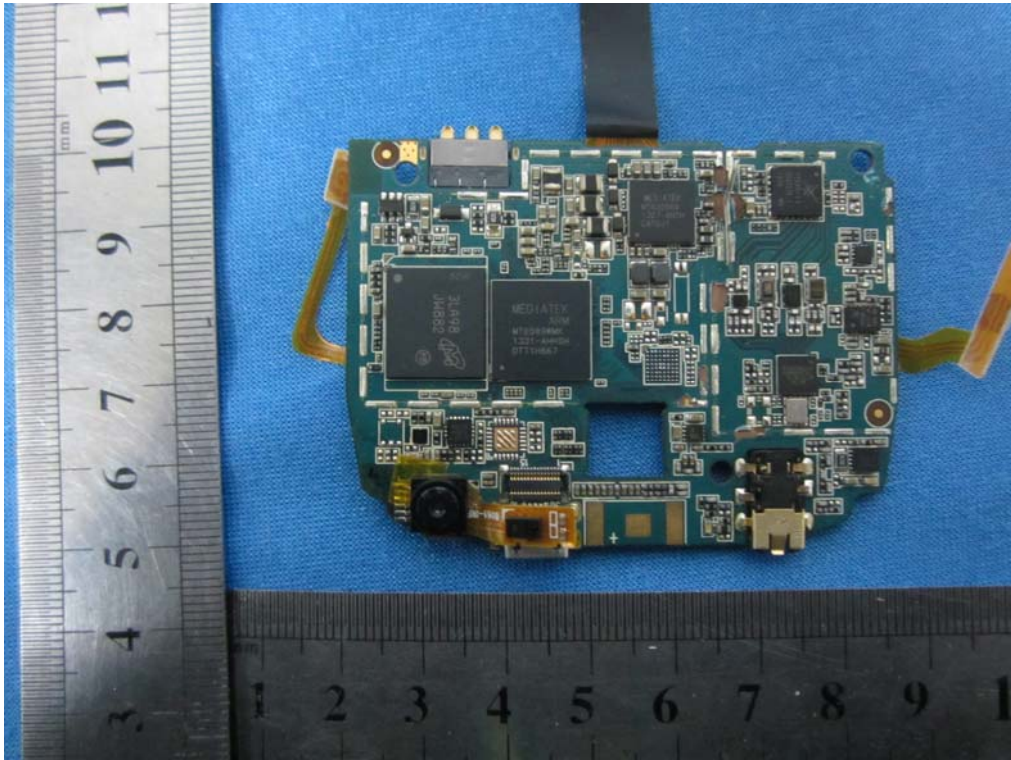

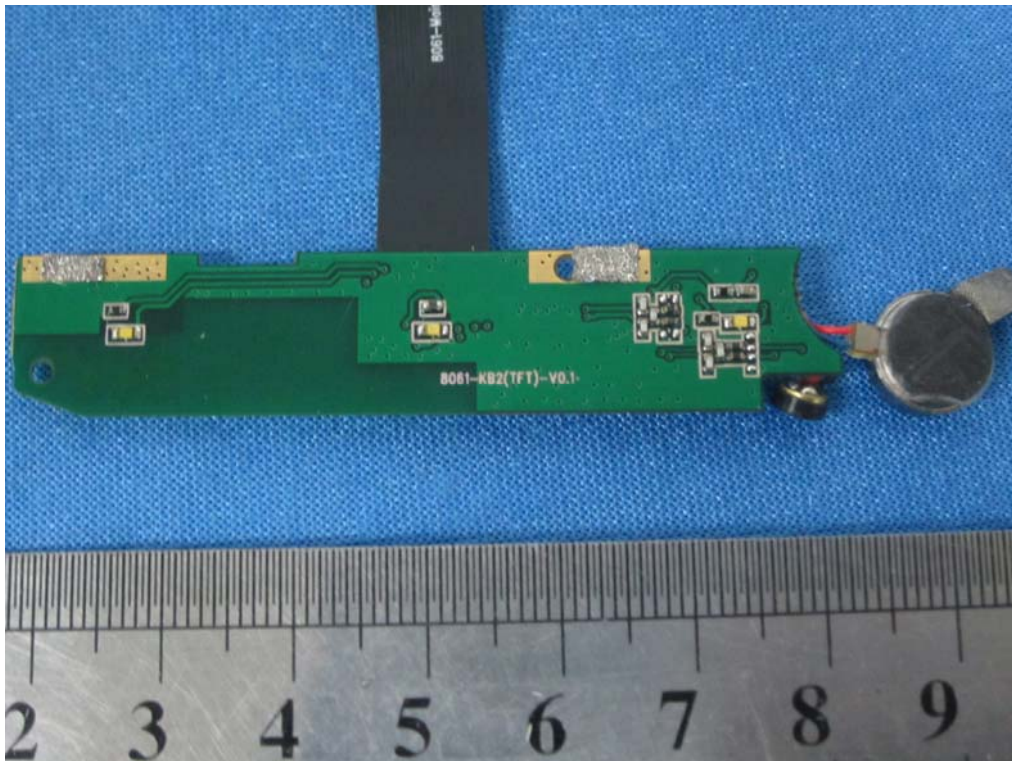
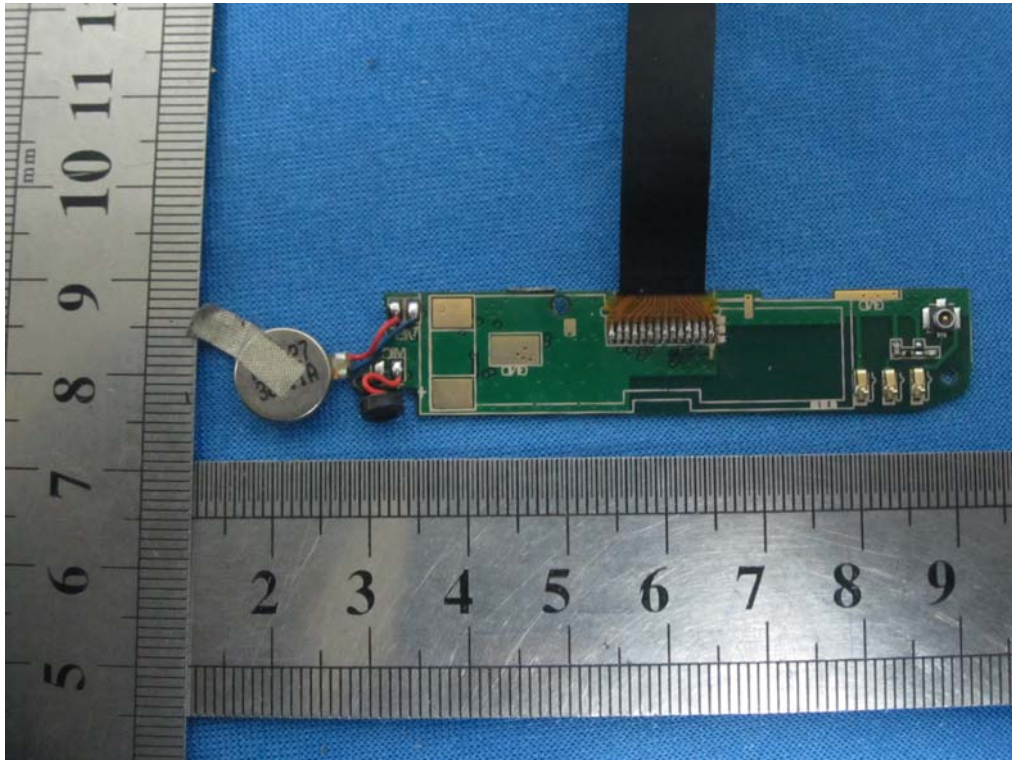

.....End of Report.....