



## FCC PART 15 SUBPART C TEST REPORT

### FCC PART 15.247

**Report Reference No.**.....: **TRE1312003103 R/C: 34886**

**FCC ID**.....: **YPVITALCOMSKYHD**

Compiled by

( position+printed name+signature)..: File administrators Eric Wang

*Eric Wang*

Supervised by

( position+printed name+signature)..: Test Engineer Yuchao Wang

*yuchao.wang*

Approved by

( position+printed name+signature)..: Manager Wenliang Li

*Wenliang Li*

Date of issue.....: Dec 18, 2013

**Testing Laboratory Name** .....: **Shenzhen Huatongwei International Inspection Co., Ltd**

Address .....: Keji Nan No.12 Road, Hi-tech Park, Shenzhen, China

**Applicant's name**.....: **ITALCOM GROUP**

Address .....: 1728 Coral Way, Coral Gables, Miami, Florida, United States

**Test specification** .....

Standard.....: **FCC Part 15.247: Operation within the bands 902-928 MHz, 2400-2483.5 MHz and 5725-5850 MHz**

TRF Originator.....: Shenzhen Huatongwei International Inspection CO., Ltd

Master TRF.....: Dated 2006-06

**Shenzhen Huatongwei International Inspection Co., Ltd. All rights reserved.**

This publication may be reproduced in whole or in part for non-commercial purposes as long as the Shenzhen Huatongwei International Inspection Co., Ltd is acknowledged as copyright owner and source of the material. Shenzhen Huatongwei International Inspection Co., Ltd takes no responsibility for and will not assume liability for damages resulting from the reader's interpretation of the reproduced material due to its placement and context.

**Test item description** .....

Trade Mark.....: NYX

Model/Type reference.....: SKY HD

Listed Models.....: /

**Manufacturer** .....

Modulation Type.....: DSSS(CCK,DQPSK,DBPSK),OFDM64QAM,16QAM,QPSK, BPSK)

Operation Frequency.....: From 2412MHz to 2462MHz

Rating.....: DC 3.70V

Hardware version.....: 8061-MB-V0.3

Software version.....: SKY\_AMXNYX\_V001R

Android version.....: 4.2.1

Result.....: **PASS**

**T E S T   R E P O R T**

<b>Test Report No. :</b>	<b>TRE1312003103</b>	Dec 18, 2013
		Date of issue

Equipment under Test : mobile Phone

Model /Type : SKY HD

Listed Models : /

**Applicant** : **ITALCOM GROUP**

Address : 1728 Coral Way,Coral Gables,Miami,Florida,United States

**Manufacturer** : **ITALCOM GROUP**

Address : 1728 Coral Way,Coral Gables,Miami,Florida,United States

<b>Test Result</b>	<b>PASS</b>
--------------------	-------------

The test report merely corresponds to the test sample.

It is not permitted to copy extracts of these test result without the written permission of the test laboratory.

## Contents

<b>1.</b>	<b><u>TEST STANDARDS</u></b> .....	<b>4</b>
<b>2.</b>	<b><u>SUMMARY</u></b> .....	<b>5</b>
2.1.	General Remarks	5
2.2.	Product Description	5
2.3.	Equipment Under Test	5
2.4.	Description of the test mode	5
2.5.	Short description of the Equipment under Test (EUT)	6
2.6.	EUT operation mode	6
2.7.	EUT configuration	6
2.8.	Internal Identification of AE used during the test	6
2.9.	Related Submittal(s) / Grant (s)	6
2.10.	Modifications	6
2.11.	NOTE	7
<b>3.</b>	<b><u>TEST ENVIRONMENT</u></b> .....	<b>8</b>
3.1.	Address of the test laboratory	8
3.2.	Test Facility	8
3.3.	Environmental conditions	9
3.4.	Test Description	9
3.5.	Statement of the measurement uncertainty	9
3.6.	Equipments Used during the Test	10
<b>4.</b>	<b><u>TEST CONDITIONS AND RESULTS</u></b> .....	<b>11</b>
4.1.	AC Power Conducted Emission	11
4.2.	Radiated Emission	13
4.3.	Maximum Peak Output Power	21
4.4.	Power Spectral Density	30
4.5.	Band Edge Compliance of RF Emission	39
4.6.	Spurious RF Conducted Emission	50
4.7.	6dB Bandwidth	75
4.8.	Antenna Requirement	84
<b>5.</b>	<b><u>TEST SETUP PHOTOS OF THE EUT</u></b> .....	<b>85</b>
<b>6.</b>	<b><u>EXTERNAL AND INTERNAL PHOTOS OF THE EUT</u></b> .....	<b>87</b>

## 1. TEST STANDARDS

The tests were performed according to following standards:

[FCC Rules Part 15.247](#): Frequency Hopping, Direct Spread Spectrum and Hybrid Systems that are in operation within the bands of 902-928 MHz, 2400-2483.5 MHz, and 5725-5850 MHz.

[ANSI C63.10](#): American National Standard for Testing Unlicensed Wireless Devices

[KDB558074 D01 V03](#): Guidance for Performing Compliance Measurements on Digital Transmission Systems (DTS) Operating Under §15.247

## 2. SUMMARY

### 2.1. General Remarks

Date of receipt of test sample	:	Dec 05, 2013
Testing commenced on	:	Dec 06, 2013
Testing concluded on	:	Dec 18, 2013

### 2.2. Product Description

The **ITALCOM GROUP**'s Model: SKY HD or the "EUT" as referred to in this report; more general information as follows, for more details, refer to the user's manual of the EUT.

Name of EUT	mobile phone
Model Number	SKY HD
FCC ID	YPVITALCOMSKYHD
Modulation Type	QPSK for WCDMA,GMSK for GSM/GPRS/EGPRS
Antenna Type	Internal
Hardware version	8061-MB-V0.3
Software version	SKY_AMXNYX_V001R
Android version	4.2.1
GSM/EDGE/GPRS	Supported GSM/GPRS/EDGE
WCDMA Operation Frequency Band	FDD Band II, FDD Band V
HSDPA Release Version	Release 8
HSUPA Release Version	Release 6
WCDMA Release Version	R99
Extreme temp. Tolerance	-30°C to +60°C
Extreme vol. Limits	3.40VDC to 4.20VDC (nominal: 3.70VDC)
GSM/GPRS Operation Frequency Band	GSM850/PCS1900
GSM Release Version	R99
GPRS operation mode	Class B
GPRS Multislot Class	12
EGPRS Multislot Class	12

### 2.3. Equipment Under Test

#### Power supply system utilised

Power supply voltage	:	<input type="radio"/> 120V / 60 Hz	<input type="radio"/> 115V / 60Hz
		<input type="radio"/> 12 V DC	<input type="radio"/> 24 V DC
		<input checked="" type="radio"/> Other (specified in blank below)	

DC 3.70V

### 2.4. Description of the test mode

IEEE 802.11b/g/n: The product support Third channels but only use Eleventh channels in USA.

Channel	Frequency(MHz)	Channel	Frequency(MHz)
1	2412	8	2447
2	2417	9	2452
3	2422	10	2457
4	2427	11	2462
5	2432		
6	2437		
7	2442		

## 2.5. Short description of the Equipment under Test (EUT)

2.4GHz (mobile Phone (M/N:SKY HD))

For more details, refer to the user's manual of the EUT.

## 2.6. EUT operation mode

The EUT has been tested under typical operating condition. The Applicant provides command to control the EUT for staying in continuous transmitting and receiving mode for testing.

## 2.7. EUT configuration

The following peripheral devices and interface cables were connected during the measurement:

- supplied by the manufacturer
- supplied by the lab

<input type="radio"/>	Power Cable	Length (m) :	/
		Shield :	/
		Detachable :	/
<input type="radio"/>	Multimeter	Manufacturer :	/
		Model No. :	/

## 2.8. Internal Identification of AE used during the test

AE ID*	Description
AE1	Battery
AE2	Charger and USB cable

AE1

Model: NYX3000A98X69  
 Manufacturer: ITALCOM GROUP  
 Capacitance: 3000mAh  
 Nominal Voltage: 3.70V

AE2:

Model: SKY HD  
 Manufacturer: ITALCOM GROUP  
 Input: 100-240V~50/60Hz 0.15A  
 Output: OUTPUT: 5.0V DC 1.0A  
 Power Cable Length: 90cm  
 Shielded       Unshielded

\*AE ID: is used to identify the test sample in the lab internally.

## 2.9. Related Submittal(s) / Grant (s)

This submittal(s) (test report) is intended for **FCC ID: YPVITALCOMSKYHD** filing to comply with Section 15.247 of the FCC Part 15, Subpart C Rules.

## 2.10. Modifications

No modifications were implemented to meet testing criteria.

**2.11. NOTE**

1. The EUT is a mobile Phone WCDMA/HSUPA/HSDPA/GPRS/GSM,WLAN and Bluetooth function,The functions of the EUT listed as below:

	Test Standards	Reference Report
GSM/GPRS/EGPRS	FCC Part 22/FCC Part 24	TRE1312003101
WCDMA/HSUPA/HSDPA	FCC Part 22/FCC Part 24	TRE1312003102
WLAN	FCC Part 15 C 15.247	TRE1312003103
Bluetooth v2.1+EDR	FCC Part 15 C 15.247	TRE1312003104
Bluetooth 4.0	FCC Part 15 C 15.247	TRE1312003105
USB Port	FCC Part 15 B	TRE1312003106
SAR	FCC Part 2 §2.1093	TRE1312003107

2. The frequency bands used in this EUT are listed as follows:

Frequency Band(MHz)	2400-2483.5	5150-5350	5470-5725	5725-5850
802.11b	√	—	—	—
802.11g	√	—	—	—
802.11n(20MHz)	√	—	—	—
802.11n(40MHz)	√	—	—	—

3. The EUT incorporates a SISO function,Physically,the EUT provides one completed transmitter and one completed receiver.

Modulation Mode	TX Function
802.11b	1TX
802.11g	1TX
802.11n (20MHz)	1TX
802.11n (40MHz)	1TX

### **3. TEST ENVIRONMENT**

#### **3.1. Address of the test laboratory**

Shenzhen Huatongwei International Inspection Co., Ltd  
Keji Nan No.12 Road, Hi-tech Park, Shenzhen, China  
Phone: 86-755-26715686 Fax: 86-755-26748089

The sites are constructed in conformance with the requirements of ANSI C63.7, ANSI C63.4 (2009) and CISPR Publication 22.

#### **3.2. Test Facility**

The test facility is recognized, certified, or accredited by the following organizations:

##### **CNAS-Lab Code: L1225**

Shenzhen Huatongwei International Inspection Co., Ltd. has been assessed and proved to be in compliance with CNAS-CL01 Accreditation Criteria for Testing and Calibration Laboratories (identical to ISO/IEC 17025: 2005 General Requirements) for the Competence of Testing and Calibration Laboratories, Date of Registration: Mar. 29, 2012. Valid time is until Feb. 28, 2015.

##### **A2LA-Lab Cert. No. 2243.01**

Shenzhen Huatongwei International Inspection Co., Ltd. EMC Laboratory has been accredited by A2LA for technical competence in the field of electrical testing, and proved to be in compliance with ISO/IEC 17025: 2005 General Requirements for the Competence of Testing and Calibration Laboratories and any additional program requirements in the identified field of testing. Valid time is until Sept. 30, 2015.

##### **FCC-Registration No.: 662850**

Shenzhen Huatongwei International Inspection Co., Ltd. EMC Laboratory has been registered and fully described in a report filed with the FCC (Federal Communications Commission). The acceptance letter from the FCC is maintained in our files. Registration 662850, Renewal date Jun. 01, 2012, valid time is until Jun. 01, 2015.

##### **IC-Registration No.: 5377A**

The 3m Alternate Test Site of Shenzhen Huatongwei International Inspection Co., Ltd. has been registered by Certification and Engineering Bureau of Industry Canada for the performance of radiated measurements with Registration No. 5377A on Jan. 25, 2011, valid time is until Jan. 24, 2014.

##### **ACA**

Shenzhen Huatongwei International Inspection Co., Ltd. EMC Laboratory can also perform testing for the Australian C-Tick mark as a result of our A2LA accreditation.

##### **VCCI**

The 3m Semi-anechoic chamber (12.2m×7.95m×6.7m) and Shielded Room (8m×4m×3m) of Shenzhen Huatongwei International Inspection Co., Ltd. has been registered in accordance with the Regulations for Voluntary Control Measures with Registration No.: G-292. Date of Registration: Dec. 24, 2010. Valid time is until Dec. 23, 2013.

Main Ports Conducted Interference Measurement of Shenzhen Huatongwei International Inspection Co., Ltd. has been registered in accordance with the Regulations for Voluntary Control Measures with Registration No.: C-2726. Date of Registration: Dec. 20, 2012. Valid time is until Dec. 19, 2015.

Telecommunication Ports Conducted Interference Measurement of Shenzhen Huatongwei International Inspection Co., Ltd. has been registered in accordance with the Regulations for Voluntary Control Measures with Registration No.: T-1837. Date of Registration: May 07, 2013. Valid time is until May 06, 2016.

##### **DNV**

Shenzhen Huatongwei International Inspection Co., Ltd. has been found to comply with the requirements of DNV towards subcontractor of EMC and safety testing services in conjunction with the EMC and Low voltage Directives and in the voluntary field. The acceptance is based on a formal quality Audit and follow-ups according to relevant parts of ISO/IEC Guide 17025 (2005), in accordance with the requirements of the DNV Laboratory Quality Manual towards subcontractors. Valid time is until Aug. 24, 2016.



### 3.3. Environmental conditions

During the measurement the environmental conditions were within the listed ranges:

Temperature:	<u>15-35 ° C</u>
Humidity:	<u>30-60 %</u>
Atmospheric pressure:	<u>950-1050mbar</u>

### 3.4. Test Description

FCC PART 15 15.247		
FCC Part 15.207	AC Power Conducted Emission	PASS
FCC Part 15.247(a)(2)	6dB Bandwidth	PASS
FCC Part 15.247(d)	Spurious RF Conducted Emission	PASS
FCC Part 15.247(b)	Maximum Peak Output Power	PASS
FCC Part 15.247(e)	Power Spectral Density	PASS
FCC Part 15.109/ 15.205/ 15.209	Radiated Emissions	PASS
FCC Part 15.247(d)	Band Edge	PASS
FCC Part 15.203/15.247 (b)	Antenna Requirement	PASS

Remark: The measurement uncertainty is not included in the test result.

Preliminary tests were performed in different data rate to find the worst radiated emission. The data rate shown in the table below is the worst-case rate with respect to the specific test item. Investigation has been done on all the possible configurations for searching the worst cases. The following table is a list of the test modes shown in this test report.

Test Items	Mode	Data Rate	Channel
Maximum Peak Conducted Output Power	11b/DSSS	1 Mbps	1/6/11
Power Spectral Density	11g/OFDM	6 Mbps	1/6/11
6dB Bandwidth	11g/OFDM	6 Mbps	1/6/11
Spurious RF conducted emission	11n(20MHz)/OFDM	6.5Mbps	1/6/11
Radiated Emission 9KHz~1GHz& Radiated Emission 1GHz~10th Harmonic	11n(40MHz)/OFDM	13.5 Mbps	3/6/9
Band Edge	11b/DSSS	1 Mbps	1/11
	11g/OFDM	6 Mbps	1/11
	11n(20MHz)/OFDM	6.5Mbps	1/11
	11n(40MHz)/OFDM	13.5 Mbps	3/9

### 3.5. Statement of the measurement uncertainty

The data and results referenced in this document are true and accurate. The reader is cautioned that there may be errors within the calibration limits of the equipment and facilities. The measurement uncertainty was calculated for all measurements listed in this test report acc. to CISPR 16 - 4 „Specification for radio disturbance and immunity measuring apparatus and methods – Part 4: Uncertainty in EMC Measurements“ and is documented in the Shenzhen Huatongwei International Inspection Co., Ltd quality system acc. to DIN EN ISO/IEC 17025. Furthermore, component and process variability of devices similar to that tested may result in additional deviation. The manufacturer has the sole responsibility of continued compliance of the device.

Hereafter the best measurement capability for Shenzhen Huatongwei laboratory is reported:

Test Items	Measurement Uncertainty	Notes
Frequency stability	25 Hz	(1)
Transmitter power conducted	0.57 dB	(1)
Transmitter power Radiated	2.20 dB	(1)
Conducted spurious emission 9KHz-12.75 GHz	1.60 dB	(1)
Radiated spurious emission 9KHz-12.75 GHz	2.20 dB	(1)
Conducted Emission 9KHz-30MHz	3.39 dB	(1)
Radiated Emission 30~1000MHz	4.24 dB	(1)

Radiated Emissio 1~18GHz	5.16 dB	(1)
Radiated Emissio 18-40GHz	5.54 dB	(1)
Occupied Bandwidth	-----	(1)
Emission Mask	-----	(1)
Modulation Characteristic	-----	(1)
Transmitter Frequency Behavior	-----	(1)

(1) This uncertainty represents an expanded uncertainty expressed at approximately the 95% confidence level using a coverage factor of k=1.96.

### 3.6. Equipments Used during the Test

AC Power Conducted Emission					
Item	Test Equipment	Manufacturer	Model No.	Serial No.	Cal.Due
1	Artificial Mains	Rohde&Schwarz	ESH2-Z5	100028	2014/10/25
2	EMI Test Receiver	Rohde&Schwarz	ESCI	100106	2014/10/25
3	Pulse Limiter	Rohde&Schwarz	ESHSZ2	100044	2014/10/25
4	EMI Test Software	Rohde&Schwarz	ES-K1 V1.71	N/A	N/A

Radiated Emission					
Item	Test Equipment	Manufacturer	Model No.	Serial No.	Cal.Due
1	Ultra-Broadband Antenna	ShwarzBeck	VULB9163	538	2014/10/25
2	EMI TEST RECEIVER	Rohde&Schwarz	ESI 26	100009	2014/10/25
3	EMI TEST Software	Audix	E3	N/A	2014/10/25
4	TURNTABLE	ETS	2088	2149	N/A
5	ANTENNA MAST	ETS	2075	2346	N/A
6	EMI TEST Software	Rohde&Schwarz	ESK1	N/A	N/A
7	HORN ANTENNA	ShwarzBeck	9120D	1011	2014/10/25
8	Amplifer	Sonoma	310N	E009-13	2014/10/25
9	JS amplifer	Rohde&Schwarz	JS4-00101800-28-5A	F201504	2014/10/25
10	High pass filter	Compliance Direction systems	BSU-6	34202	2014/10/25
11	HORN ANTENNA	ShwarzBeck	9120D	1012	2014/10/25
12	Amplifer	Compliance Direction systems	PAP1-4060	120	2014/10/25
13	Loop Antenna	Rohde&Schwarz	HFH2-Z2	100020	2014/10/25
14	TURNTABLE	MATURO	TT2.0	----	N/A
15	ANTENNA MAST	MATURO	TAM-4.0-P	----	N/A
16	Horn Antenna	SCHWARZBECK	BBHA9170	25841	2014/10/25
17	HORN ANTENNA	Rohde&Schwarz	HF906	100039	2014/10/25
18	ULTRA-BROADBAND ANTENNA	Rohde&Schwarz	HL562	100015	2014/10/25

Maximum Peak Output Power / Power Spectral Density / 6dB Bandwidth / Band Edge Compliance of RF Emission / Spurious RF Conducted Emission					
Item	Test Equipment	Manufacturer	Model No.	Serial No.	Cal.Due
1	Spectrum Analyzer	Rohde&Schwarz	FSP	1164.4391.40	2014/10/25

The Cal.Interval was one year

## 4. TEST CONDITIONS AND RESULTS

### 4.1. AC Power Conducted Emission

#### TEST CONFIGURATION

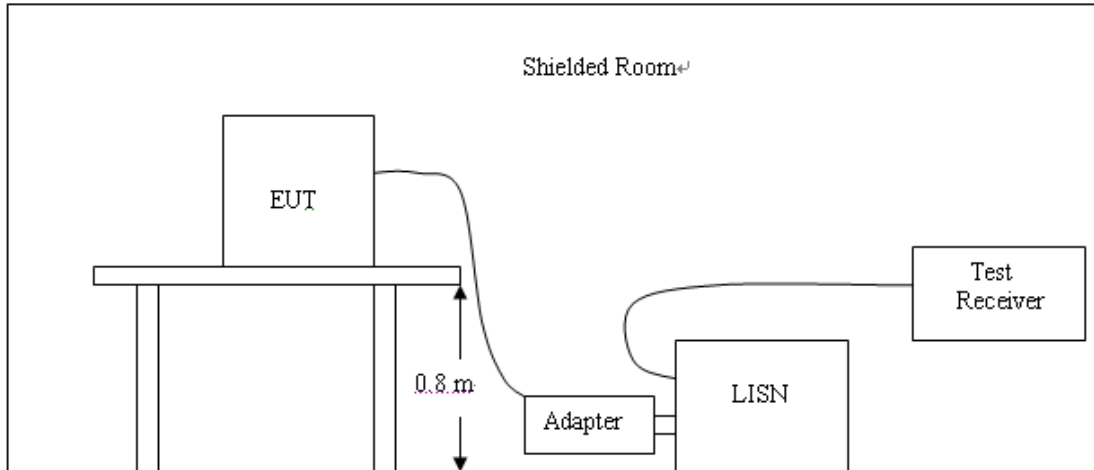

#### TEST PROCEDURE

1. The equipment was set up as per the test configuration to simulate typical actual usage per the user's manual. The EUT is a tabletop system, a wooden table with a height of 0.8 meters is used and is placed on the ground plane as per ANSI C63.10-2009.
2. Support equipment, if needed, was placed as per ANSI C63.10-2009
3. All I/O cables were positioned to simulate typical actual usage as per ANSI C63.10-2009
4. The EUT received DC5V power from the adapter, the adapter received AC120V/60Hz power through a Line Impedance Stabilization Network (LISN) which supplied power source and was grounded to the ground plane.
5. All support equipments received AC power from a second LISN, if any.
6. The EUT test program was started. Emissions were measured on each current carrying line of the EUT using a spectrum Analyzer / Receiver connected to the LISN powering the EUT. The LISN has two monitoring points: Line 1 (Hot Side) and Line 2 (Neutral Side). Two scans were taken: one with Line 1 connected to Analyzer / Receiver and Line 2 connected to a 50 ohm load; the second scan had Line 1 connected to a 50 ohm load and Line 2 connected to the Analyzer / Receiver.
7. Analyzer / Receiver scanned from 150 KHz to 30MHz for emissions in each of the test modes.
8. During the above scans, the emissions were maximized by cable manipulation.

#### AC Power Conducted Emission Limit

For intentional device, according to § 15.207(a) AC Power Conducted Emission Limits is as following :

Frequency (MHz)	Maximum RF Line Voltage (dBµV)			
	CLASS A		CLASS B	
	Q.P.	Ave.	Q.P.	Ave.
0.15 - 0.50	79	66	66-56*	56-46*
0.50 - 5.00	73	60	56	46
5.00 - 30.0	73	60	60	50

\* Decreasing linearly with the logarithm of the frequency

#### TEST RESULTS

The AC Power Conducted Emission measurement are performed the each test mode (b/g/n) and channel (low/mid/high), the datum recorded below (802.11b mode,the middle channel) is the worst case for all the test modes and channels.

**SCAN TABLE: "Voltage (9K-30M) FIN"**  
 Short Description: 150K-30M Voltage

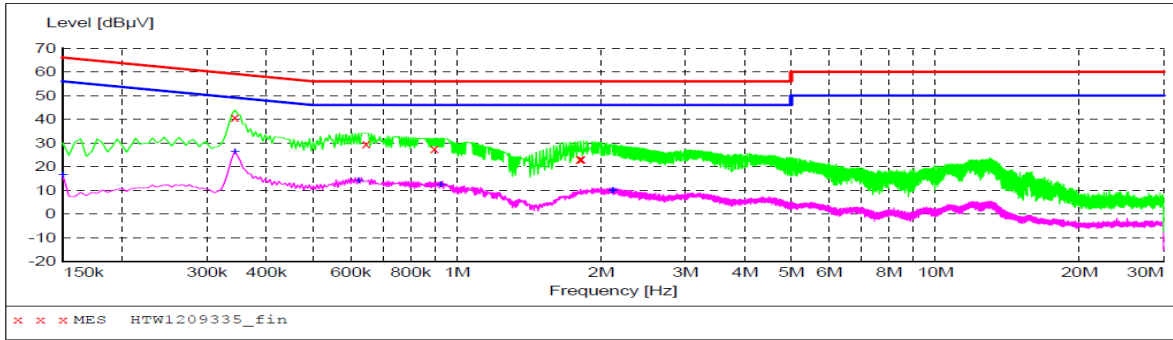

**MEASUREMENT RESULT: "HTW1209335\_fin"**

12/9/2013 5:54PM

Frequency MHz	Level dBµV	Transd dB	Limit dBµV	Margin dB	Detector	Line	PE
0.343500	40.70	10.6	59	18.4	QP	L1	GND
0.645000	29.60	10.3	56	26.4	QP	L1	GND
0.897000	27.40	10.2	56	28.6	QP	L1	GND
1.806000	23.00	10.3	56	33.0	QP	L1	GND
1.815000	23.30	10.3	56	32.7	QP	L1	GND
1.819500	23.20	10.3	56	32.8	QP	L1	GND

**MEASUREMENT RESULT: "HTW1209335\_fin2"**

12/9/2013 5:54PM

Frequency MHz	Level dBµV	Transd dB	Limit dBµV	Margin dB	Detector	Line	PE
0.150000	16.30	10.3	56	39.7	AV	L1	GND
0.343500	26.20	10.6	49	22.9	AV	L1	GND
0.622500	14.10	10.3	46	31.9	AV	L1	GND
0.924000	12.40	10.2	46	33.6	AV	L1	GND
2.112000	9.70	10.3	46	36.3	AV	L1	GND
2.116500	9.80	10.3	46	36.2	AV	L1	GND

**SCAN TABLE: "Voltage (9K-30M) FIN"**  
 Short Description: 150K-30M Voltage

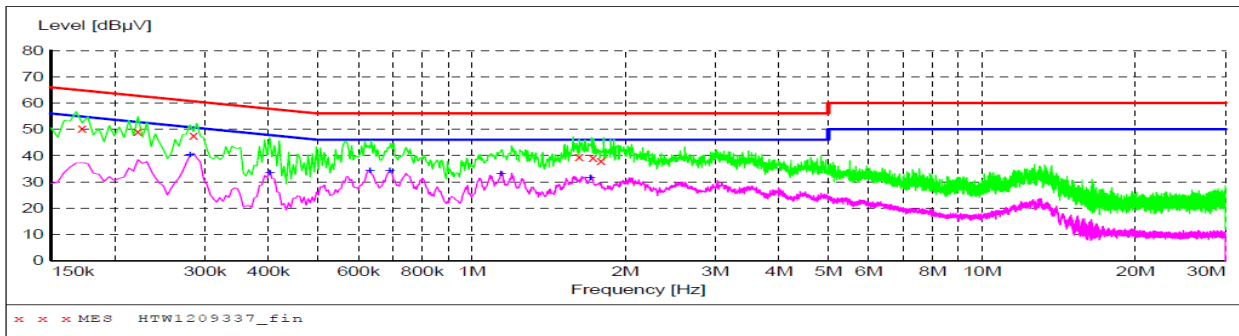

**MEASUREMENT RESULT: "HTW1209337\_fin"**

12/9/2013 6:03PM

Frequency MHz	Level dBµV	Transd dB	Limit dBµV	Margin dB	Detector	Line	PE
0.172500	50.30	10.3	65	14.5	QP	N	GND
0.222000	49.20	10.4	63	13.5	QP	N	GND
0.285000	47.70	10.6	61	13.0	QP	N	GND
1.626000	39.50	10.3	56	16.5	QP	N	GND
1.729500	39.30	10.3	56	16.7	QP	N	GND
1.792500	38.00	10.3	56	18.0	QP	N	GND

**MEASUREMENT RESULT: "HTW1209337\_fin2"**

12/9/2013 6:03PM

Frequency MHz	Level dBµV	Transd dB	Limit dBµV	Margin dB	Detector	Line	PE
0.280500	40.10	10.6	51	10.7	AV	N	GND
0.402000	33.30	10.5	48	14.5	AV	N	GND
0.631500	34.10	10.3	46	11.9	AV	N	GND
0.690000	34.20	10.3	46	11.8	AV	N	GND
1.140000	32.90	10.3	46	13.1	AV	N	GND
1.707000	31.50	10.3	46	14.5	AV	N	GND

## 4.2. Radiated Emission

### TEST CONFIGURATION

Frequency range 9KHz – 30MHz

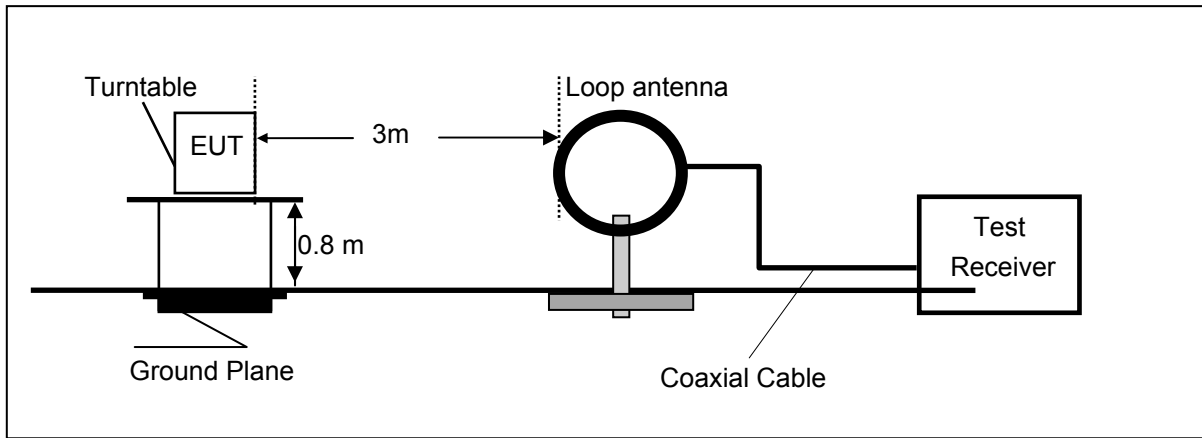

Frequency range 30MHz – 100MHz

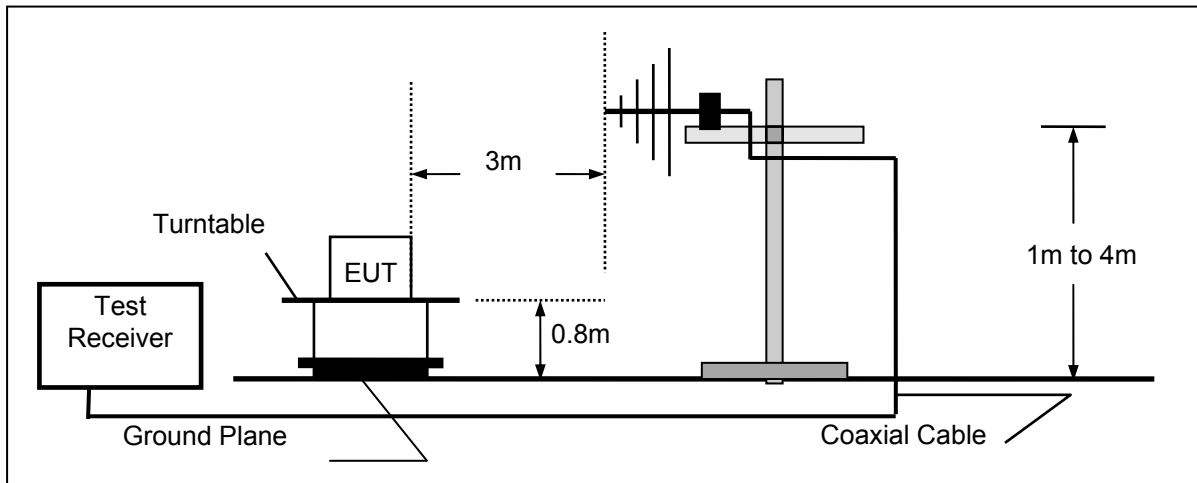

Frequency range above 1GHz-25GHz

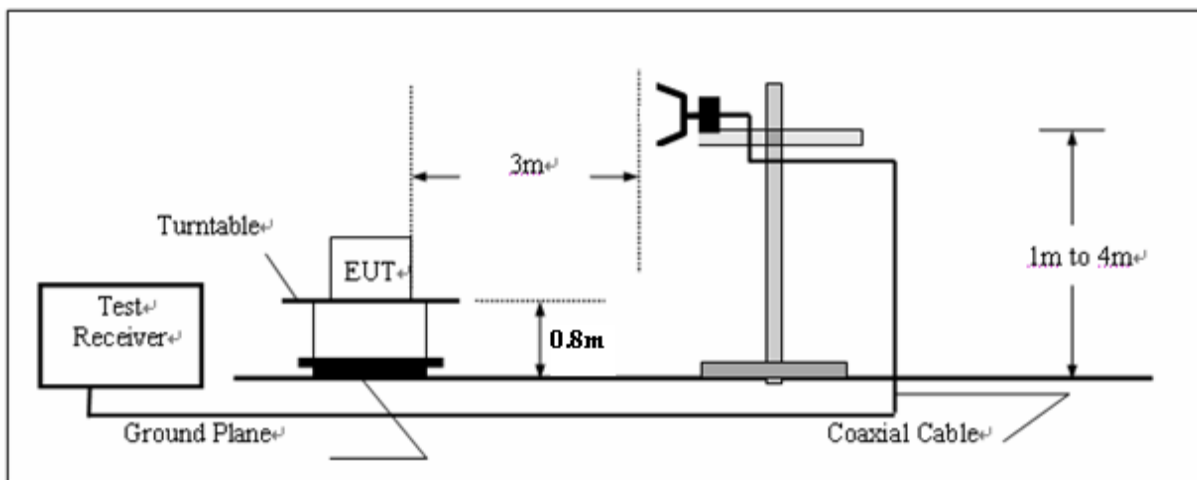

### TEST PROCEDURE

1. The EUT was placed on a turn table which is 0.8m above ground plane.
2. Maximum procedure was performed by raising the receiving antenna from 1m to 4m and rotating the turn table from 0° to 360° to acquire the highest emissions from EUT.

3. And also, each emission was to be maximized by changing the polarization of receiving antenna both horizontal and vertical.
4. Repeat above procedures until all frequency measurements have been completed.
5. The EUT minimum operation frequency was 32.768KHz and maximum operation frequency was 2462MHz.so radiated emission test frequency band from 9KHz to 25GHz.

### Field Strength Calculation

The field strength is calculated by adding the Antenna Factor and Cable Factor and subtracting the Amplifier Gain and Duty Cycle Correction Factor(if any) from the measured reading. The basic equation with a sample calculation is as follows:

$$FS = RA + AF + CL - AG$$

Where FS = Field Strength	CL = Cable Attenuation Factor (Cable Loss)
RA = Reading Amplitude	AG = Amplifier Gain
AF = Antenna Factor	

### RADIATION LIMIT

For intentional device, according to § 15.209(a), the general requirement of field strength of radiated emission from intentional radiators at a distance of 3 meters shall not exceed the following table. According to § 15.247(d), in any 100kHz bandwidth outside the frequency band in which the EUT is operating, the radio frequency power that is produced by the intentional radiator shall be at least 20dB below that in the 100kHz bandwidth within the band that contains the highest level of desired power.

The frequency spectrum above 1 GHz for Transmitter was investigated. All emission not reported are much lower than the prescribed limits. Set the RBW=1MHz,VBW=3MHz for Peak Detector while the RBW=1MHz,VBW=10Hz for Average Detector,Readings are both peak and average values.

Frequency (MHz)	Distance (Meters)	Radiated (dBµV/m)	Radiated (µV/m)
0.009-0.49	300	20log(2400/F(KHz))+80	2400/F(KHz)
0.49-1.705	30	20log(24000/F(KHz))+40	24000/F(KHz)
1.705-30	30	20log(30)+40	30
30-88	3	40.0	100
88-216	3	43.5	150
216-960	3	46.0	200
Above 960	3	54.0	500

### TEST RESULTS

Remark:

1. The radiated measurement are performed the each test mode (b/g/n) and channel (low/mid/high), the datum recorded below (802.11b mode,the middle channel) is the worst case for all the test mode and channel.
2. ULTRA-BROADBAND ANTENNA for the radiation emission test below 1G.
3. HORN ANTENNA for the radiation emission test above 1G.
4. We tested both battery powered and powered by adapter charging mode at three orientations,recored woest case at powered by adapter charging mode.

#### **For 9KHz to 30MHz**

Frequency (MHz)	Corrected Reading (dBµV/m)@3m	FCC Limit (dBµV/m) @3m	Margin (dB)	Detector	Result
12.00	41.87	69.54	27.67	QP	PASS
24.00	39.43	69.54	30.11	QP	PASS

For 30MHz to 1000MHz

**SWEEP TABLE: "test (30M-1G)"**

Short Description: Field Strength

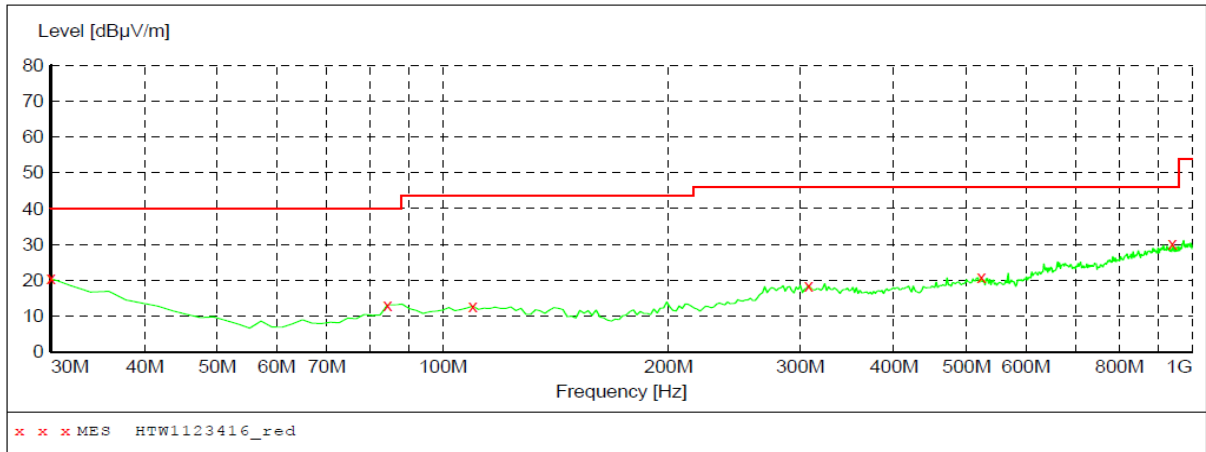

**MEASUREMENT RESULT: "HTW1123416\_red"**

12/09/2013 11:56AM

Frequency MHz	Level dBµV/m	Transd dB	Limit dBµV/m	Margin dB	Det.	Height cm	Azimuth deg	Polarization
30.000000	20.50	-10.0	40.0	19.5	Pk	100.0	266.00	HORIZONTAL
84.428858	13.10	-19.7	40.0	26.9	Pk	100.0	24.00	HORIZONTAL
109.699399	12.80	-18.1	43.5	30.7	Pk	100.0	45.00	HORIZONTAL
307.975952	18.60	-14.8	46.0	27.4	Pk	100.0	283.00	HORIZONTAL
523.747495	20.80	-11.0	46.0	25.2	Pk	100.0	127.00	HORIZONTAL
941.683367	30.10	-4.7	46.0	15.9	Pk	100.0	81.00	HORIZONTAL

**SWEEP TABLE: "test (30M-1G)"**

Short Description: Field Strength

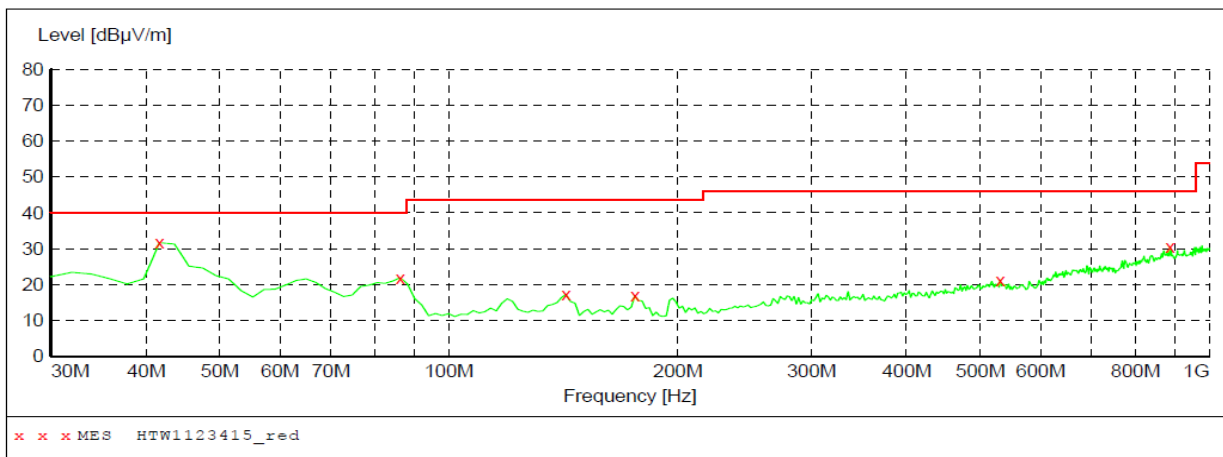

**MEASUREMENT RESULT: "HTW1123415\_red"**

12/09/2013 11:54AM

Frequency MHz	Level dBµV/m	Transd dB	Limit dBµV/m	Margin dB	Det.	Height cm	Azimuth deg	Polarization
41.663327	31.60	-16.2	40.0	8.4	Pk	100.0	280.00	VERTICAL
86.372745	21.90	-19.4	40.0	18.1	Pk	100.0	352.00	VERTICAL
142.745491	17.30	-20.4	43.5	26.2	Pk	200.0	137.00	VERTICAL
175.791583	16.90	-21.0	43.5	26.6	Pk	200.0	321.00	VERTICAL
531.523046	21.30	-11.1	46.0	24.7	Pk	100.0	306.00	VERTICAL
889.198397	30.40	-4.1	46.0	15.6	Pk	100.0	260.00	VERTICAL

For 1GHz to 25GHz

**802.11b Mode(above 1GHz)**

<b>ANTENNA POLARITY &amp; TEST DISTANCE: HORIZONTAL AT 3 M (802.11b--2412MHz)</b>												
No.	Frequency (MHz)	Emission Level (dBuV/m)		Limit (dBuV/m)	Margin (dB)	Antenna Height (m)	Table Angle (Degree)	Raw Value (dBuV)	Antenna Factor (dB/m)	Cable Factor (dB)	Pre-amplifier	Correction Factor (dB/m)
1	4824.00	54.91	PK	74.00	19.09	1.00 H	39	52.81	31.60	7.00	36.5	2.10
1	4824.00	46.32	AV	54.00	7.68	1.00 H	39	44.22	31.60	7.00	36.5	2.10
2	7236.00	58.47	PK	74.00	15.53	1.00 H	131	47.54	37.33	8.90	35.3	10.93
2	7236.00	42.25	AV	54.00	11.75	1.00 H	131	31.32	37.33	8.90	35.3	10.93

<b>ANTENNA POLARITY &amp; TEST DISTANCE: VERTICAL AT 3 M (802.11b--2412MHz)</b>												
No.	Frequency (MHz)	Emission Level (dBuV/m)		Limit (dBuV/m)	Margin (dB)	Antenna Height (m)	Table Angle (Degree)	Raw Value (dBuV)	Antenna Factor (dB/m)	Cable Factor (dB)	Pre-amplifier	Correction Factor (dB/m)
1	4824.00	62.91	PK	74.00	11.09	1.00 H	301	60.81	31.60	7.00	36.5	2.10
1	4824.00	50.72	AV	54.00	3.28	1.00 H	301	48.62	31.60	7.00	36.5	2.10
2	7236.00	60.63	PK	74.00	13.37	1.00 H	157	49.7	37.33	8.90	35.3	10.93
2	7236.00	50.65	AV	54.00	3.35	1.00 H	157	39.72	37.33	8.90	35.3	10.93

<b>ANTENNA POLARITY &amp; TEST DISTANCE: HORIZONTAL AT 3 M (802.11b--2437MHz)</b>												
No.	Frequency (MHz)	Emission Level (dBuV/m)		Limit (dBuV/m)	Margin (dB)	Antenna Height (m)	Table Angle (Degree)	Raw Value (dBuV)	Antenna Factor (dB/m)	Cable Factor (dB)	Pre-amplifier	Correction Factor (dB/m)
1	4874.00	59.26	PK	74.00	14.74	1.00 H	215	57.14	31.02	7.60	36.5	2.12
1	4874.00	48.16	AV	54.00	5.84	1.00 H	215	46.04	31.02	7.60	36.5	2.12
2	7311.00	62.13	PK	74.00	11.87	1.00 H	193	51.05	37.28	8.60	34.8	11.08
2	7311.00	49.22	AV	54.00	4.78	1.00 H	193	38.14	37.28	8.60	34.8	11.08

<b>ANTENNA POLARITY &amp; TEST DISTANCE: VERTICAL AT 3 M (802.11b--2437MHz)</b>												
No.	Frequency (MHz)	Emission Level (dBuV/m)		Limit (dBuV/m)	Margin (dB)	Antenna Height (m)	Table Angle (Degree)	Raw Value (dBuV)	Antenna Factor (dB/m)	Cable Factor (dB)	Pre-amplifier	Correction Factor (dB/m)
1	4874.00	59.26	PK	74.00	14.74	1.00 H	131	57.14	31.02	7.60	36.5	2.12
1	4874.00	48.17	AV	54.00	5.83	1.00 H	131	46.05	31.02	7.60	36.5	2.12
2	7311.00	58.22	PK	74.00	15.78	1.00 H	39	47.14	37.28	8.60	34.8	11.08
2	7311.00	48.13	AV	54.00	5.87	1.00 H	39	37.05	37.28	8.60	34.8	11.08

<b>ANTENNA POLARITY &amp; TEST DISTANCE: HORIZONTAL AT 3 M (802.11b--2462MHz)</b>												
No.	Frequency (MHz)	Emission Level (dBuV/m)		Limit (dBuV/m)	Margin (dB)	Antenna Height (m)	Table Angle (Degree)	Raw Value (dBuV)	Antenna Factor (dB/m)	Cable Factor (dB)	Pre-amplifier	Correction Factor (dB/m)
1	4924.00	59.61	PK	74.00	14.39	1.00 H	319	57.23	31.58	7.00	36.2	2.38
1	4924.00	49.70	AV	54.00	4.30	1.00 H	319	47.32	31.58	7.00	36.2	2.38
2	7386.00	61.95	PK	74.00	12.05	1.00 H	127	50.24	38.51	8.50	35.3	11.71
2	7386.00	48.95	AV	54.00	5.05	1.00 H	127	37.24	38.51	8.50	35.3	11.71

<b>ANTENNA POLARITY &amp; TEST DISTANCE: VERTICAL AT 3 M (802.11b--2462MHz)</b>												
No.	Frequency (MHz)	Emission Level (dBuV/m)		Limit (dBuV/m)	Margin (dB)	Antenna Height (m)	Table Angle (Degree)	Raw Value (dBuV)	Antenna Factor (dB/m)	Cable Factor (dB)	Pre-amplifier	Correction Factor (dB/m)
1	4924.00	62.8	PK	74.00	11.2	1.00 H	312	60.42	31.58	7.00	36.2	2.38
1	4924.00	49.23	AV	54.00	4.77	1.00 H	312	46.85	31.58	7.00	36.2	2.38
2	7386.00	64.00	PK	74.00	10.00	1.00 H	207	52.29	38.51	8.50	35.3	11.71
2	7386.00	48.94	AV	54.00	5.06	1.00 H	207	37.23	38.51	8.50	35.3	11.71



- REMARKS:**
1. Emission level (dBuV/m)=Raw Value(dBuV)+Correction Factor(dB/m)
  2. Correction Factor (dB/m) = Antenna Factor (dB/m)+Cable Factor (dB)-Pre-amplifier Factor
  3. The other emission levels were very low against the limit.
  4. Margin value = Limit value- Emission level.
  5. For Wireless 802.11b mode at 1Mbps.

**802.11g Mode(above 1GHz)**

<b>ANTENNA POLARITY &amp; TEST DISTANCE: HORIZONTAL AT 3 M (802.11g--2412MHz)</b>												
No.	Frequency (MHz)	Emission Level (dBuV/m)		Limit (dBuV/m)	Margin (dB)	Antenna Height (m)	Table Angle (Degree)	Raw Value (dBuV)	Antenna Factor (dB/m)	Cable Factor (dB)	Pre-amplifier	Correction Factor (dB/m)
1	4824.00	57.34	PK	74.00	16.66	1.00 H	30	55.24	31.6	7.00	36.5	2.10
1	4824.00	49.44	AV	54.00	4.56	1.00 H	30	47.34	31.6	7.00	36.5	2.10
2	7236.00	61.91	PK	74.00	12.09	1.00 H	242	50.98	37.33	8.90	35.3	10.93
2	7236.00	49.13	AV	54.00	4.87	1.00 H	242	38.2	37.33	8.90	35.3	10.93

<b>ANTENNA POLARITY &amp; TEST DISTANCE: VERTICAL AT 3 M (802.11g--2412MHz)</b>												
No.	Frequency (MHz)	Emission Level (dBuV/m)		Limit (dBuV/m)	Margin (dB)	Antenna Height (m)	Table Angle (Degree)	Raw Value (dBuV)	Antenna Factor (dB/m)	Cable Factor (dB)	Pre-amplifier	Correction Factor (dB/m)
1	4824.00	63.33	PK	74.00	10.67	1.00 H	49	61.23	31.60	7.00	36.5	2.10
1	4824.00	49.44	AV	54.00	4.56	1.00 H	49	47.34	31.60	7.00	36.5	2.10
2	7236.00	61.09	PK	74.00	12.91	1.00 H	290	50.16	37.33	8.90	35.3	10.93
2	7236.00	48.35	AV	54.00	5.65	1.00 H	290	37.42	37.33	8.90	35.3	10.93

<b>ANTENNA POLARITY &amp; TEST DISTANCE: HORIZONTAL AT 3 M (802.11g--2437MHz)</b>												
No.	Frequency (MHz)	Emission Level (dBuV/m)		Limit (dBuV/m)	Margin (dB)	Antenna Height (m)	Table Angle (Degree)	Raw Value (dBuV)	Antenna Factor (dB/m)	Cable Factor (dB)	Pre-amplifier	Correction Factor (dB/m)
1	4874.00	62.60	PK	74.00	11.40	1.00 H	110	60.48	31.02	7.60	36.5	2.12
1	4874.00	49.27	AV	54.00	4.73	1.00 H	110	47.15	31.02	7.60	36.5	2.12
2	7311.00	60.34	PK	74.00	13.66	1.00 H	57	49.26	37.28	8.60	34.8	11.08
2	7311.00	48.21	AV	54.00	5.79	1.00 H	57	37.13	37.28	8.60	34.8	11.08

<b>ANTENNA POLARITY &amp; TEST DISTANCE: VERTICAL AT 3 M (802.11g--2437MHz)</b>												
No.	Frequency (MHz)	Emission Level (dBuV/m)		Limit (dBuV/m)	Margin (dB)	Antenna Height (m)	Table Angle (Degree)	Raw Value (dBuV)	Antenna Factor (dB/m)	Cable Factor (dB)	Pre-amplifier	Correction Factor (dB/m)
1	4874.00	63.67	PK	74.00	10.33	1.00 H	135	61.55	31.02	7.60	36.5	2.12
1	4874.00	49.64	AV	54.00	4.36	1.00 H	135	47.52	31.02	7.60	36.5	2.12
2	7311.00	62.36	PK	74.00	11.64	1.00 H	279	51.28	37.28	8.60	34.8	11.08
2	7311.00	47.62	AV	54.00	6.38	1.00 H	279	36.54	37.28	8.60	34.8	11.08

<b>ANTENNA POLARITY &amp; TEST DISTANCE: HORIZONTAL AT 3 M (802.11g--2462MHz)</b>												
No.	Frequency (MHz)	Emission Level (dBuV/m)		Limit (dBuV/m)	Margin (dB)	Antenna Height (m)	Table Angle (Degree)	Raw Value (dBuV)	Antenna Factor (dB/m)	Cable Factor (dB)	Pre-amplifier	Correction Factor (dB/m)
1	4924.00	59.85	PK	74.00	14.15	1.00 H	324	57.47	31.58	7.00	36.2	2.38
1	4924.00	47.71	AV	54.00	6.29	1.00 H	324	45.33	31.58	7.00	36.2	2.38
2	7311.00	62.34	PK	74.00	11.66	1.00 H	216	50.63	38.51	8.50	35.3	11.71
2	7311.00	49.05	AV	54.00	4.95	1.00 H	216	37.34	38.51	8.50	35.3	11.71

ANTENNA POLARITY & TEST DISTANCE: VERTICAL AT 3 M (802.11g--2462MHz)												
No.	Frequency (MHz)	Emission Level (dBuV/m)		Limit (dBuV/m)	Margin (dB)	Antenna Height (m)	Table Angle (Degree)	Raw Value (dBuV)	Antenna Factor (dB/m)	Cable Factor (dB)	Pre-amplifier	Correction Factor (dB/m)
1	4924.00	61.58	PK	74.00	12.42	1.00 H	149	59.2	31.58	7.00	36.2	2.38
1	4924.00	48.62	AV	54.00	5.38	1.00 H	149	46.24	31.58	7.00	36.2	2.38
2	7386.00	63.94	PK	74.00	10.06	1.00 H	21	52.23	38.51	8.50	35.3	11.71
2	7386.00	48.95	AV	54.00	5.05	1.00 H	21	37.24	38.51	8.50	35.3	11.71

- REMARKS:**
1. Emission level (dBuV/m) = Raw Value (dBuV) + Correction Factor (dB/m)
  2. Correction Factor (dB/m) = Antenna Factor (dB/m) + Cable Factor (dB) - Pre-amplifier Factor
  3. The other emission levels were very low against the limit.
  4. Margin value = Limit value - Emission level.
  5. For Wireless 802.11g mode at 6Mbps.

**802.11n(20MHz) Mode(above 1GHz)**

ANTENNA POLARITY & TEST DISTANCE: HORIZONTAL AT 3 M (802.11n20--2412MHz)												
No.	Frequency (MHz)	Emission Level (dBuV/m)		Limit (dBuV/m)	Margin (dB)	Antenna Height (m)	Table Angle (Degree)	Raw Value (dBuV)	Antenna Factor (dB/m)	Cable Factor (dB)	Pre-amplifier	Correction Factor (dB/m)
1	4824.00	63.80	PK	74.00	10.20	1.00 H	78	61.7	31.60	7.00	36.5	2.10
1	4824.00	48.44	AV	54.00	5.56	1.00 H	78	46.34	31.60	7.00	36.5	2.10
2	7236.00	62.16	PK	74.00	11.84	1.00 H	180	51.23	37.33	8.90	35.3	10.93
2	7236.00	48.47	AV	54.00	5.53	1.00 H	180	37.54	37.33	8.90	35.3	10.93

ANTENNA POLARITY & TEST DISTANCE: VERTICAL AT 3 M (802.11n20--2412MHz)												
No.	Frequency (MHz)	Emission Level (dBuV/m)		Limit (dBuV/m)	Margin (dB)	Antenna Height (m)	Table Angle (Degree)	Raw Value (dBuV)	Antenna Factor (dB/m)	Cable Factor (dB)	Pre-amplifier	Correction Factor (dB/m)
1	4824.00	63.66	PK	74.00	10.34	1.00 H	47	61.56	31.60	7.00	36.5	2.10
1	4824.00	49.23	AV	54.00	4.77	1.00 H	47	47.13	31.60	7.00	36.5	2.10
2	7236.00	63.27	PK	74.00	10.73	1.00 H	180	52.34	37.33	8.90	35.3	10.93
2	7236.00	49.61	AV	54.00	4.39	1.00 H	180	38.68	37.33	8.90	35.3	10.93

ANTENNA POLARITY & TEST DISTANCE: HORIZONTAL AT 3 M (802.11n20--2437MHz)												
No.	Frequency (MHz)	Emission Level (dBuV/m)		Limit (dBuV/m)	Margin (dB)	Antenna Height (m)	Table Angle (Degree)	Raw Value (dBuV)	Antenna Factor (dB/m)	Cable Factor (dB)	Pre-amplifier	Correction Factor (dB/m)
1	4874.00	59.74	PK	74.00	14.26	1.00 H	210	57.62	31.02	7.60	36.5	2.12
1	4874.00	49.36	AV	54.00	4.64	1.00 H	210	47.24	31.02	7.60	36.5	2.12
2	7311.00	62.43	PK	74.00	11.57	1.00 H	181	51.35	37.28	8.60	34.8	11.08
2	7311.00	49.37	AV	54.00	4.63	1.00 H	181	38.29	37.28	8.60	34.8	11.08

ANTENNA POLARITY & TEST DISTANCE: VERTICAL AT 3 M (802.11n20--2437MHz)												
No.	Frequency (MHz)	Emission Level (dBuV/m)		Limit (dBuV/m)	Margin (dB)	Antenna Height (m)	Table Angle (Degree)	Raw Value (dBuV)	Antenna Factor (dB/m)	Cable Factor (dB)	Pre-amplifier	Correction Factor (dB/m)
1	4874.00	60.36	PK	74.00	13.64	1.00 H	241	58.24	31.02	7.60	36.5	2.12
1	4874.00	49.47	AV	54.00	4.53	1.00 H	241	47.35	31.02	7.60	36.5	2.12
2	7311.00	61.70	PK	74.00	12.30	1.00 H	215	50.62	37.28	8.60	34.8	11.08
2	7311.00	49.73	AV	54.00	4.27	1.00 H	215	38.65	37.28	8.60	34.8	11.08

**ANTENNA POLARITY & TEST DISTANCE: HORIZONTAL AT 3 M (802.11n20--2462MHz)**

No.	Frequency (MHz)	Emission Level (dBuV/m)		Limit (dBuV/m)	Margin (dB)	Antenna Height (m)	Table Angle (Degree)	Raw Value (dBuV)	Antenna Factor (dB/m)	Cable Factor (dB)	Pre-amplifier	Correction Factor (dB/m)
1	4924.00	58.81	PK	74.00	15.19	1.00 H	139	56.43	31.58	7.00	36.2	2.38
1	4924.00	45.92	AV	54.00	8.08	1.00 H	139	43.54	31.58	7.00	36.2	2.38
2	7386.00	60.95	PK	74.00	13.05	1.00 H	220	49.24	38.51	8.50	35.3	11.71
2	7386.00	49.07	AV	54.00	4.93	1.00 H	220	37.36	38.51	8.50	35.3	11.71

**ANTENNA POLARITY & TEST DISTANCE: VERTICAL AT 3 M (802.11n20--2462MHz)**

No.	Frequency (MHz)	Emission Level (dBuV/m)		Limit (dBuV/m)	Margin (dB)	Antenna Height (m)	Table Angle (Degree)	Raw Value (dBuV)	Antenna Factor (dB/m)	Cable Factor (dB)	Pre-amplifier	Correction Factor (dB/m)
1	4924.00	59.75	PK	74.00	14.25	1.00 H	158	57.37	31.58	7.00	36.2	2.38
1	4924.00	48.62	AV	54.00	5.38	1.00 H	158	46.24	31.58	7.00	36.2	2.38
2	7386.00	61.97	PK	74.00	12.03	1.00 H	270	50.26	38.51	8.50	35.3	11.71
2	7386.00	49.03	AV	54.00	4.97	1.00 H	270	37.32	38.51	8.50	35.3	11.71

- REMARKS:**
1. Emission level (dBuV/m) = Raw Value (dBuV) + Correction Factor (dB/m)
  2. Correction Factor (dB/m) = Antenna Factor (dB/m) + Cable Factor (dB) - Pre-amplifier Factor
  3. The other emission levels were very low against the limit.
  4. Margin value = Limit value - Emission level.
  5. For Wireless 802.11n (20MHz) mode at 6.5Mbps.

**802.11n(40MHz) Mode(above 1GHz)****ANTENNA POLARITY & TEST DISTANCE: HORIZONTAL AT 3 M (802.11n40--2422MHz)**

No.	Frequency (MHz)	Emission Level (dBuV/m)		Limit (dBuV/m)	Margin (dB)	Antenna Height (m)	Table Angle (Degree)	Raw Value (dBuV)	Antenna Factor (dB/m)	Cable Factor (dB)	Pre-amplifier	Correction Factor (dB/m)
1	4844.00	61.94	PK	74.00	12.06	1.00 H	60	59.83	31.01	7.30	36.2	2.11
1	4844.00	46.33	AV	54.00	7.67	1.00 H	60	44.22	31.01	7.30	36.2	2.11
2	7266.00	61.86	PK	74.00	12.14	1.00 H	169	51.06	36.70	8.90	34.8	10.80
2	7266.00	47.19	AV	54.00	6.81	1.00 H	169	36.39	36.70	8.90	34.8	10.80

**ANTENNA POLARITY & TEST DISTANCE: VERTICAL AT 3 M (802.11n40--2422MHz)**

No.	Frequency (MHz)	Emission Level (dBuV/m)		Limit (dBuV/m)	Margin (dB)	Antenna Height (m)	Table Angle (Degree)	Raw Value (dBuV)	Antenna Factor (dB/m)	Cable Factor (dB)	Pre-amplifier	Correction Factor (dB/m)
1	4844.00	60.29	PK	74.00	13.71	1.00 H	346	58.18	31.01	7.30	36.2	2.11
1	4844.00	47.67	AV	54.00	6.33	1.00 H	346	45.56	31.01	7.30	36.2	2.11
2	7266.00	62.60	PK	74.00	11.40	1.00 H	126	51.8	36.70	8.90	34.8	10.80
2	7266.00	47.59	AV	54.00	6.41	1.00 H	126	36.79	36.70	8.90	34.8	10.80

**ANTENNA POLARITY & TEST DISTANCE: HORIZONTAL AT 3 M (802.11n40--2437MHz)**

No.	Frequency (MHz)	Emission Level (dBuV/m)		Limit (dBuV/m)	Margin (dB)	Antenna Height (m)	Table Angle (Degree)	Raw Value (dBuV)	Antenna Factor (dB/m)	Cable Factor (dB)	Pre-amplifier	Correction Factor (dB/m)
1	4874.00	61.35	PK	74.00	12.65	1.00 H	241	59.23	31.02	7.60	36.5	2.12
1	4874.00	49.36	AV	54.00	4.64	1.00 H	241	47.24	31.02	7.60	36.5	2.12
2	7311.00	64.65	PK	74.00	9.35	1.00 H	159	53.57	37.28	8.60	34.8	11.08
2	7311.00	49.31	AV	54.00	4.69	1.00 H	159	38.23	37.28	8.60	34.8	11.08

ANTENNA POLARITY & TEST DISTANCE: VERTICAL AT 3 M (802.11n40--2437MHz)												
No.	Frequency (MHz)	Emission Level (dBuV/m)		Limit (dBuV/m)	Margin (dB)	Antenna Height (m)	Table Angle (Degree)	Raw Value (dBuV)	Antenna Factor (dB/m)	Cable Factor (dB)	Pre-amplifier	Correction Factor (dB/m)
1	4874.00	59.04	PK	74.00	14.96	1.00 H	319	56.92	31.02	7.60	36.5	2.12
1	4874.00	49.88	AV	54.00	4.12	1.00 H	319	47.76	31.02	7.60	36.5	2.12
2	7311.00	64.01	PK	74.00	9.99	1.00 H	171	52.93	37.28	8.60	34.8	11.08
2	7311.00	49.28	AV	54.00	4.72	1.00 H	171	38.2	37.28	8.60	34.8	11.08

ANTENNA POLARITY & TEST DISTANCE: HORIZONTAL AT 3 M (802.11n40--2452MHz)												
No.	Frequency (MHz)	Emission Level (dBuV/m)		Limit (dBuV/m)	Margin (dB)	Antenna Height (m)	Table Angle (Degree)	Raw Value (dBuV)	Antenna Factor (dB/m)	Cable Factor (dB)	Pre-amplifier	Correction Factor (dB/m)
1	4904.00	58.50	PK	74.00	15.50	1.00 H	50	56.23	31.47	7.00	36.2	2.27
1	4904.00	45.50	AV	54.00	8.50	1.00 H	50	43.23	31.47	7.00	36.2	2.27
2	7356.00	61.62	PK	74.00	12.38	1.00 H	190	49.97	38.45	8.50	35.3	11.65
2	7356.00	47.88	AV	54.00	6.12	1.00 H	190	36.23	38.45	8.50	35.3	11.65

ANTENNA POLARITY & TEST DISTANCE: VERTICAL AT 3 M (802.11n40--2452MHz)												
No.	Frequency (MHz)	Emission Level (dBuV/m)		Limit (dBuV/m)	Margin (dB)	Antenna Height (m)	Table Angle (Degree)	Raw Value (dBuV)	Antenna Factor (dB/m)	Cable Factor (dB)	Pre-amplifier	Correction Factor (dB/m)
1	4904.00	60.40	PK	74.00	13.60	1.00 H	190	58.13	31.47	7.00	36.2	2.27
1	4904.00	46.50	AV	54.00	7.50	1.00 H	190	44.23	31.47	7.00	36.2	2.27
2	7356.00	60.78	PK	74.00	13.22	1.00 H	185	49.13	38.45	8.50	35.3	11.65
2	7356.00	47.81	AV	54.00	6.19	1.00 H	185	36.16	38.45	8.50	35.3	11.65

- REMARKS:**
1. Emission level (dBuV/m) = Raw Value (dBuV) + Correction Factor (dB/m)
  2. Correction Factor (dB/m) = Antenna Factor (dB/m) + Cable Factor (dB) - Pre-amplifier Factor
  3. The other emission levels were very low against the limit.
  4. Margin value = Limit value - Emission level.
  5. For Wireless 802.11n (40MHz) mode at 13.5Mbps.

### 4.3. Maximum Peak Output Power

#### TEST CONFIGURATION

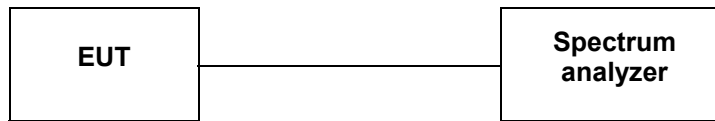

#### TEST PROCEDURE

The EUT was directly connected to the spectrum analyzer and antenna output port as show in the block diagram as TEST CONFIGURATION shows.

Accoding to KDB558074 D01 V03 Integrated band power method for this procedure may be used when the maximum available RBW of the measurement instrument is less than the DTS bandwidth.

1. Set the RBW = 1 MHz.
2. Set the VBW  $\geq$  3 RBW
3. Set the span  $\geq$  1.5 x DTS bandwidth.
4. Detector = peak.
5. Sweep time = auto couple.
6. Trace mode = max hold.
7. Allow trace to fully stabilize.
8. Use the instrument's band/channel power measurement function with the band limits set equal to the DTS bandwidth edges (for some instruments, this may require a manual override to select peak detector). If the instrument does not have a band power function, sum the spectrum levels (in linear power units) at intervals equal to the RBW extending across the DTS channel bandwidth.

#### LIMIT

The Maximum Peak Output Power Measurement is 30dBm.

#### TEST RESULTS

Remark:We measured output power at difference data rate for each mode and recorded woest case for each mode.

##### 4.3.1 802.11b Test Mode

###### A. Test Verdict

Channel	Frequency (MHz)	Measured Output Peak Power (dBm)	Refer to Plot	Limits (dBm)	Verdict
1	2412	15.52	Plot 4.3.1 A	30	PASS
6	2437	15.63	Plot 4.3.1 B	30	PASS
11	2462	16.06	Plot 4.3.1 C	30	PASS

- Note: 1. For 802.11b mode at finial test to get the worst-case emission at 1Mbps.  
2.The test results including the cable lose.

###### B. Test Plots

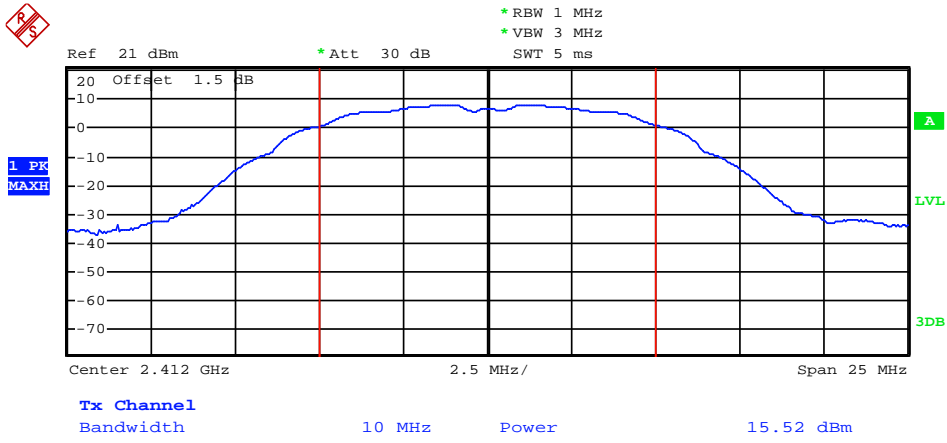

Date: 15.DEC.2013 11:47:11

(Plot 4.3.1 A: Channel 1: 2412MHz @ 802.11b)

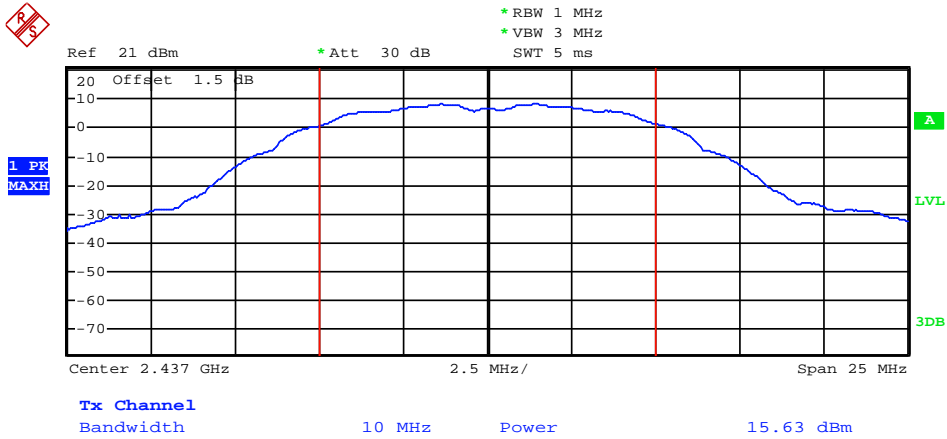

Date: 15.DEC.2013 11:47:34

(Plot 4.3.1 B: Channel 1: 2437MHz @ 802.11b)

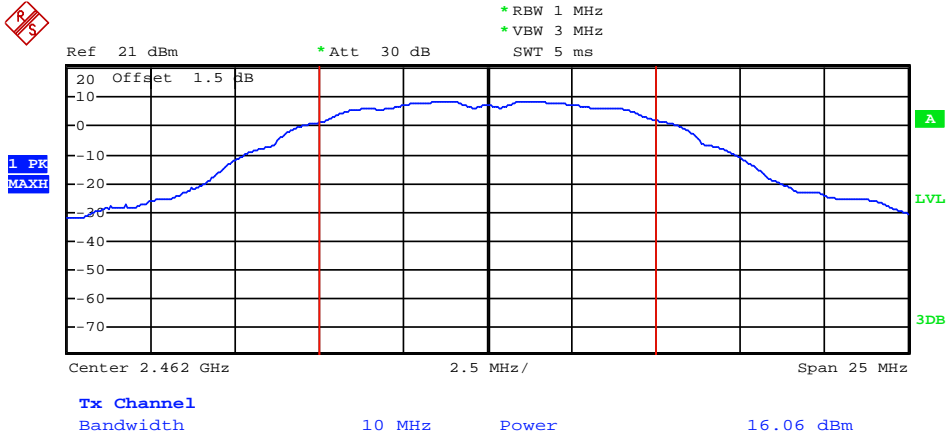

Date: 15.DEC.2013 11:48:00

(Plot 4.3.1 C: Channel 11: 2462MHz @ 802.11b)

**4.3.2 802.11g Test Mode**

**A. Test Verdict**

Channel	Frequency (MHz)	Measured Output Peak Power (dBm)	Refer to Plot	Limits (dBm)	Verdict
1	2412	17.49	Plot 4.3.2 A	30	PASS
6	2437	17.48	Plot 4.3.2 B	30	PASS
11	2462	18.09	Plot 4.3.2 C	30	PASS

Note: 1. For 802.11g mode at final test to get the worst-case emission at 6Mbps.  
 2. The test results including the cable loss.

**B. Test Plots**

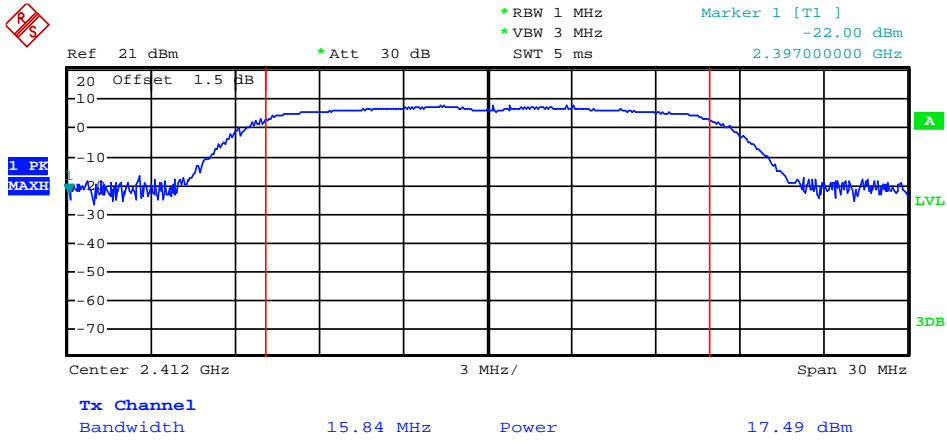

Date: 15.DEC.2013 12:26:04

(Plot 4.3.2 A: Channel 1: 2412MHz @ 802.11g)

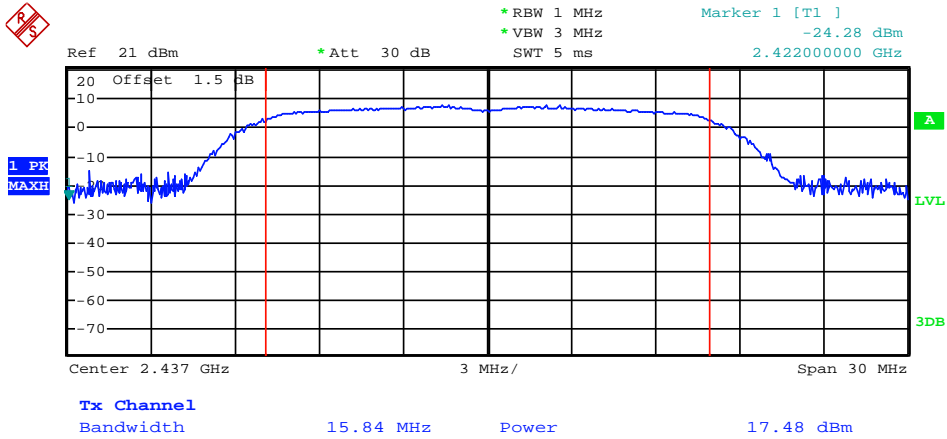

Date: 15.DEC.2013 12:26:53

(Plot 4.3.2 B: Channel 1: 2437MHz @ 802.11g)



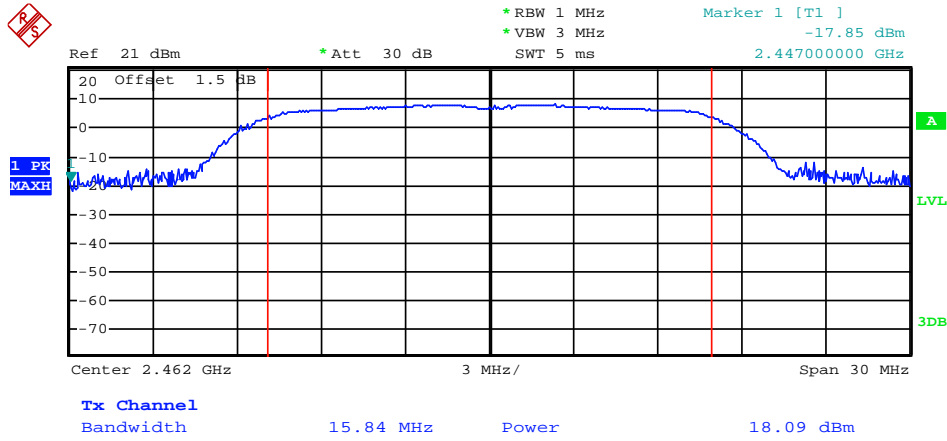

Date: 15.DEC.2013 12:27:42

(Plot 4.3.2 C: Channel 11: 2462MHz @ 802.11g)

**4.3.3 802.11n(20MHz) Test Mode**

**A. Test Verdict**

Channel	Frequency (MHz)	Measured Output Peak Power (dBm)	Refer to Plot	Limits (dBm)	Verdict
1	2412	16.44	Plot 4.3.3 A	30	PASS
6	2437	16.70	Plot 4.3.3 B	30	PASS
11	2462	17.03	Plot 4.3.3 C	30	PASS

Note: 1. For 802.11n(20MHz) mode at final test to get the worst-case emission at 6.5Mbps.  
 2. The test results including the cable loss.

**B. Test Plots**

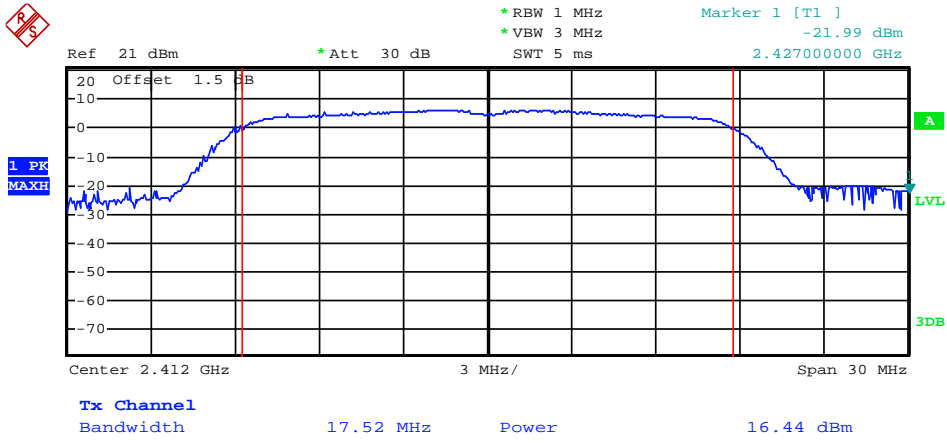

Date: 15.DEC.2013 12:29:59

(Plot 4.3.3 A: Channel 1: 2412MHz @ 802.11n(20MHz))

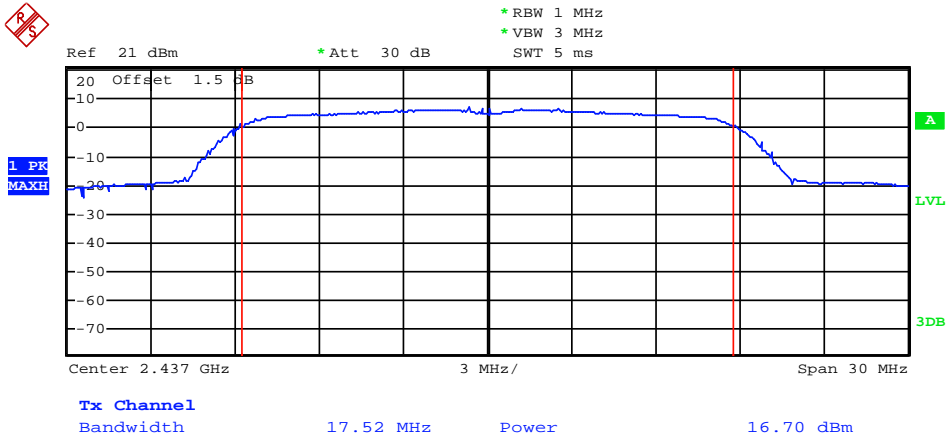

Date: 15.DEC.2013 12:31:00

(Plot 4.3.3 B: Channel 6: 2437MHz @ 802.11n(20MHz))

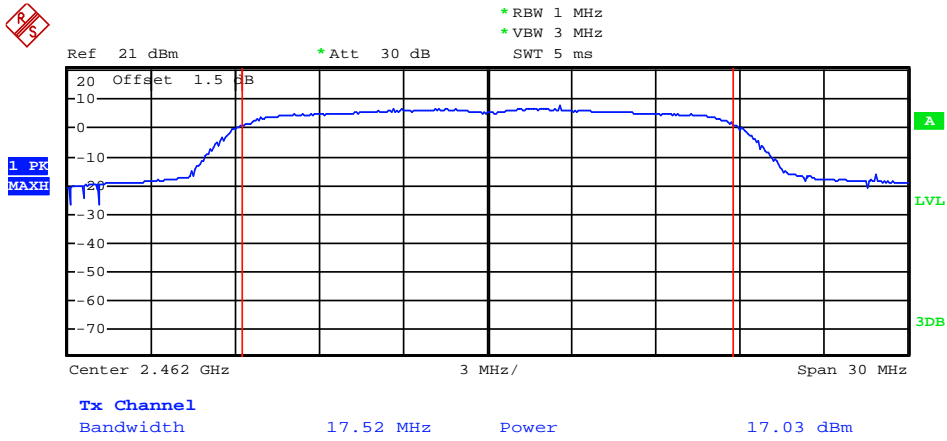

Date: 15.DEC.2013 12:32:09

(Plot 4.3.3 C: Channel 11: 2462MHz @ 802.11n(20MHz))

**4.3.4 802.11n(40MHz) Test Mode**

**A. Test Verdict**

Channel	Frequency (MHz)	Measured Output Peak Power (dBm)	Refer to Plot	Limits (dBm)	Verdict
3	2422	16.35	Plot 4.3.4 A	30	PASS
6	2437	16.58	Plot 4.3.4 B	30	PASS
9	2452	16.35	Plot 4.3.4 C	30	PASS

Note: 1. For 802.11n(40MHz) mode at final test to get the worst-case emission at 13.5Mbps.  
 2. The test results including the cable loss.

**B. Test Plots**

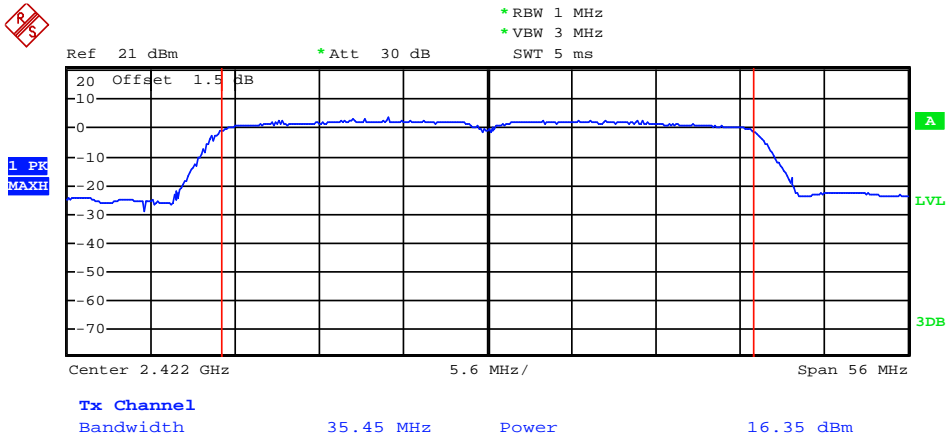

Date: 15.DEC.2013 12:33:31

(Plot 4.3.4 A: Channel 3: 2422MHz @ 802.11n(40MHz))

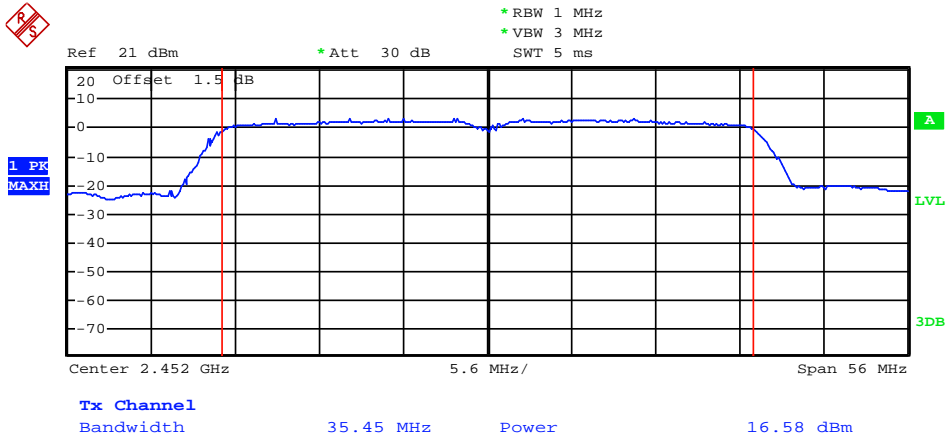

Date: 15.DEC.2013 12:35:20

(Plot 4.3.4 B: Channel 6: 2437MHz @ 802.11n(40MHz))

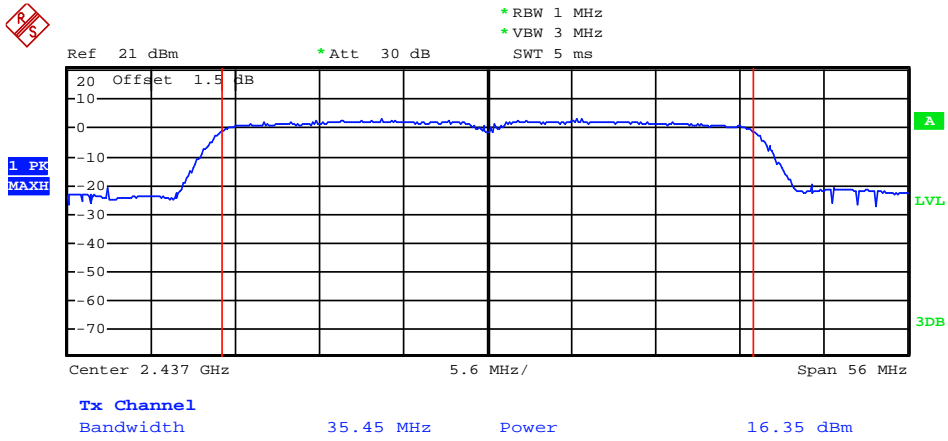

Date: 15.DEC.2013 12:34:33

(Plot 4.3.4 C: Channel 9: 2452MHz @ 802.11n(40MHz))

## 4.4. Power Spectral Density

### TEST CONFIGURATION

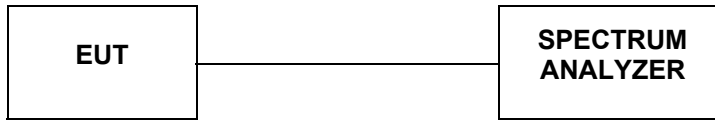

### TEST PROCEDURE

According to KDB 558074 D01 V03 Method PKPSD (peak PSD) This procedure shall be used if maximum peak conducted output power was used to demonstrate compliance, and is optional if the maximum conducted (average) output power was used to demonstrate compliance.

1. Set analyzer center frequency to DTS channel center frequency.
2. Set the span to 1.5 times the DTS bandwidth.
3. Set the RBW to:  $3 \text{ kHz} \leq \text{RBW} \leq 100 \text{ kHz}$ .
4. Set the VBW  $\geq 3 \text{ RBW}$ .
5. Detector = peak.
6. Sweep time = auto couple.
7. Trace mode = max hold.
8. Allow trace to fully stabilize.
9. Use the peak marker function to determine the maximum amplitude level within the RBW.
10. If measured value exceeds limit, reduce RBW (no less than 3 kHz) and repeat.

### LIMIT

For digitally modulated systems, the power spectral density conducted from the intentional radiator to the antenna shall not be greater than 8 dBm in any 3 kHz band during any time interval of continuous transmission.

### TEST RESULTS

#### 4.4.1 802.11b Test Mode

##### A. Test Verdict

Channel	Frequency (MHz)	Report PSD (dBm/3kHz)	Refer to Plot	Limits (dBm/3KHz)	Verdict
1	2412	-11.65	Plot 4.4.1 A	8	PASS
6	2437	-9.73	Plot 4.4.1 B	8	PASS
11	2462	-11.51	Plot 4.4.1 C	8	PASS

Note: 1. For 802.11b mode at final test to get the worst-case emission at 1Mbps.  
2. The test results including the cable loss.

##### B. Test Plots



\*RBW 3 kHz      Marker 1 [T1 ]  
\*VBW 10 kHz      -11.65 dBm  
\*SWT 1.7 s      2.412810000 GHz

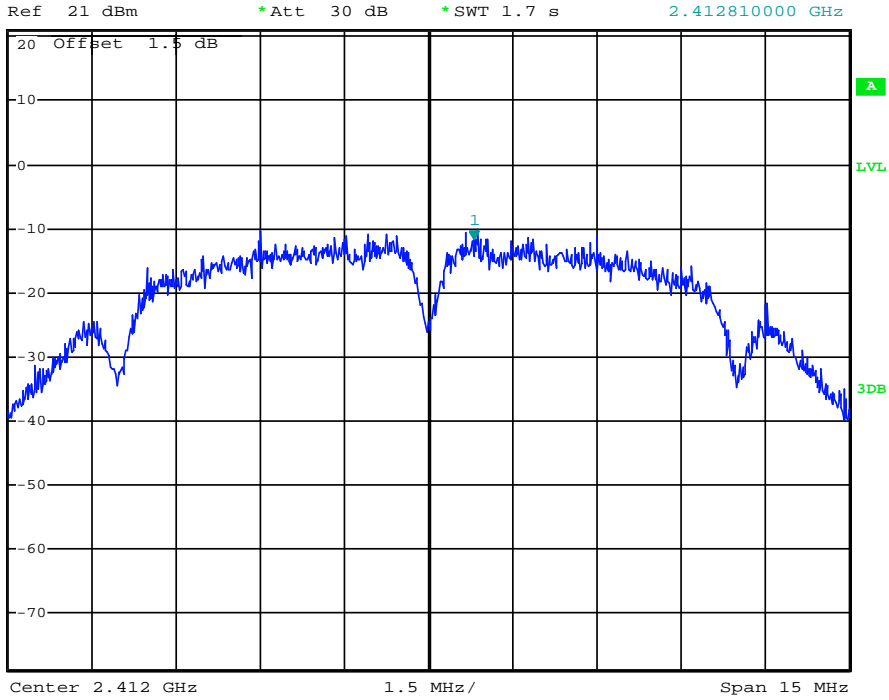

Date: 15.DEC.2013 11:35:03

(Plot 4.4.1 A: Channel 1: 2412MHz @ 802.11b)



\*RBW 3 kHz      Marker 1 [T1 ]  
\*VBW 10 kHz      -9.73 dBm  
\*SWT 1.7 s      2.435320000 GHz

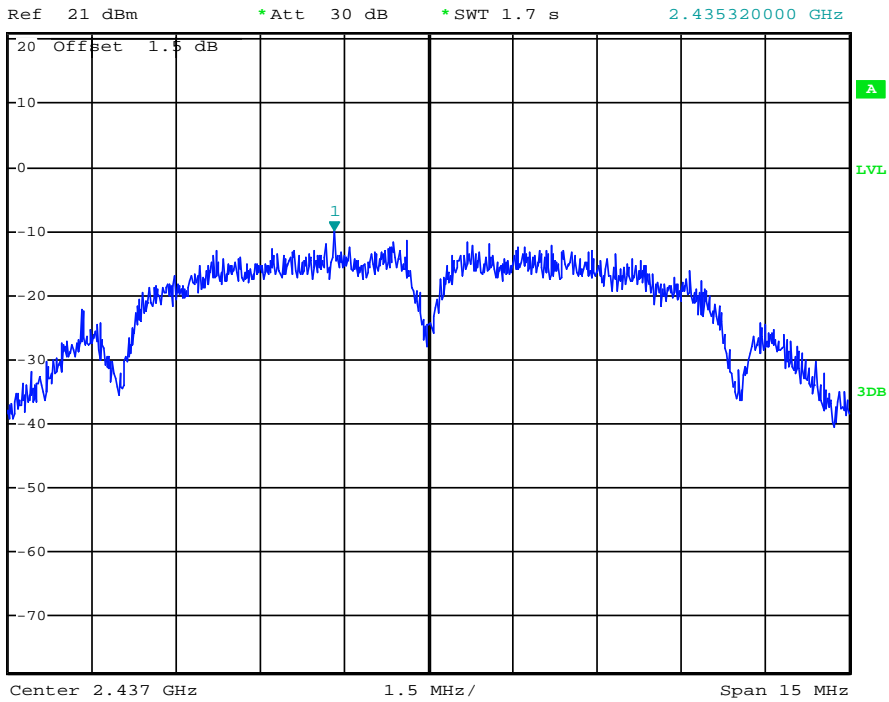

Date: 15.DEC.2013 11:35:30

(Plot 4.4.1 B: Channel 6: 2437MHz @ 802.11b)



\*RBW 3 kHz      Marker 1 [T1 ]  
 \*VBW 10 kHz      -11.51 dBm  
 \*SWT 1.7 s      2.462855000 GHz

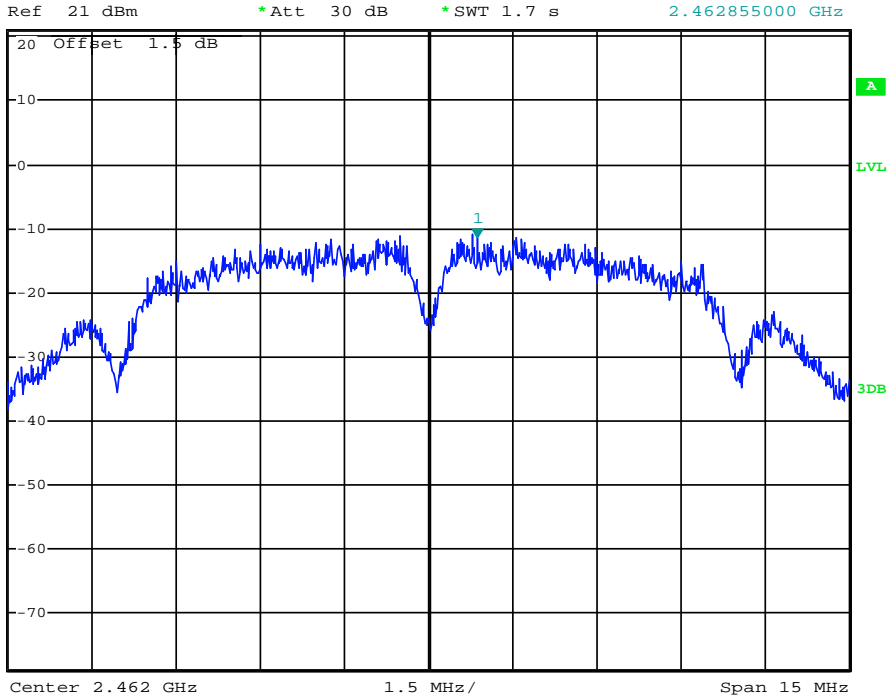

Date: 15.DEC.2013 11:35:59

(Plot 4.4.1 C: Channel 11: 2462MHz @ 802.11b)

**4.4.2 802.11g Test Mode**

**A. Test Verdict**

Channel	Frequency (MHz)	Report PSD (dBm/3kHz)	Refer to Plot	Limits (dBm/3KHz)	Verdict
1	2412	-15.29	Plot 4.4.2 A	8	PASS
6	2437	-15.68	Plot 4.4.2 B	8	PASS
11	2462	-15.58	Plot 4.4.2 C	8	PASS

Note: 1. For 802.11g mode at final test to get the worst-case emission at 6Mbps.  
 2. The test results including the cable loss.

**B. Test Plots**





Ref 21 dBm \*Att 30 dB \*RBW 3 kHz Marker 1 [T1] -15.29 dBm  
\*VBW 10 kHz 2.411002080 GHz  
SWT 2.7 s

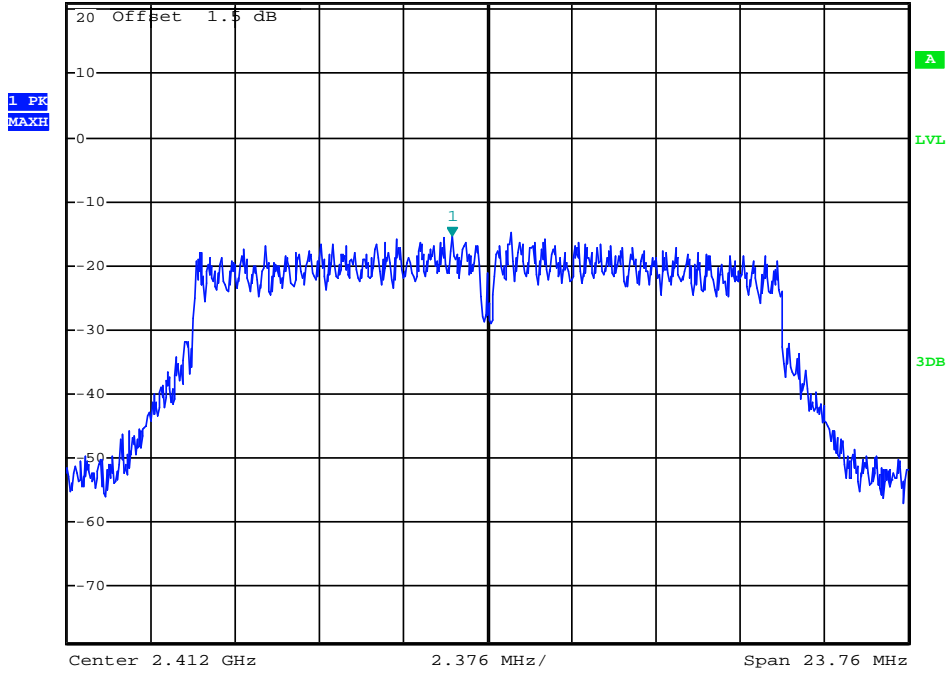

Date: 15.DEC.2013 11:37:26

(Plot 4.4.2 A: Channel 1: 2412MHz @ 802.11g)



Ref 21 dBm \*Att 30 dB \*RBW 3 kHz Marker 1 [T1] -15.68 dBm  
\*VBW 10 kHz 2.439542320 GHz  
SWT 2.7 s

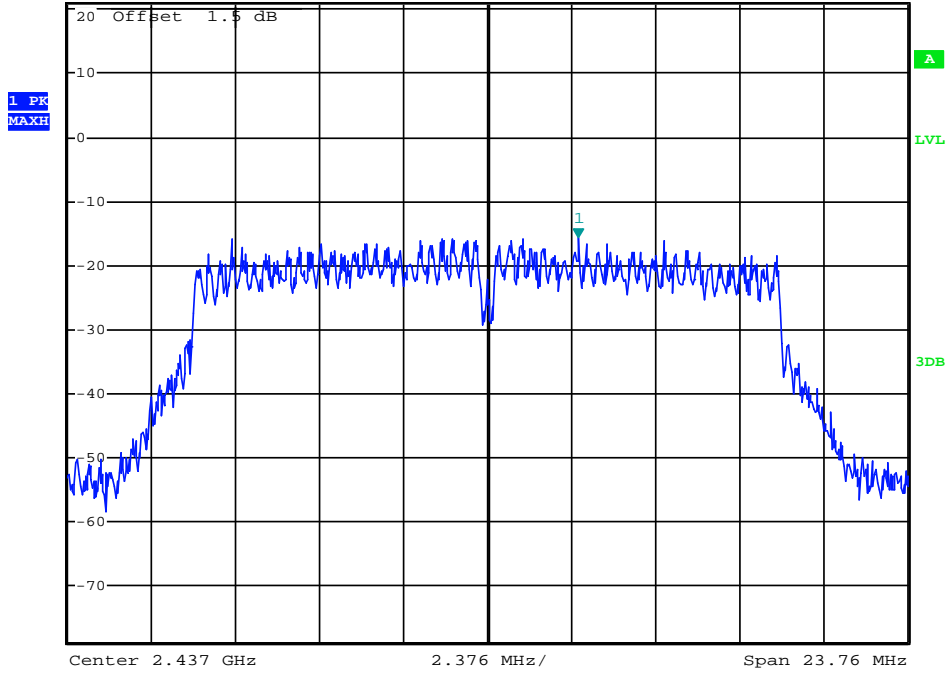

Date: 15.DEC.2013 11:37:57

(Plot 4.4.2 B: Channel 6: 2437MHz @ 802.11g)



\*RBW 3 kHz      Marker 1 [T1 ]  
 \*VBW 10 kHz      -15.58 dBm  
 SWI 2.7 s      2.462594000 GHz

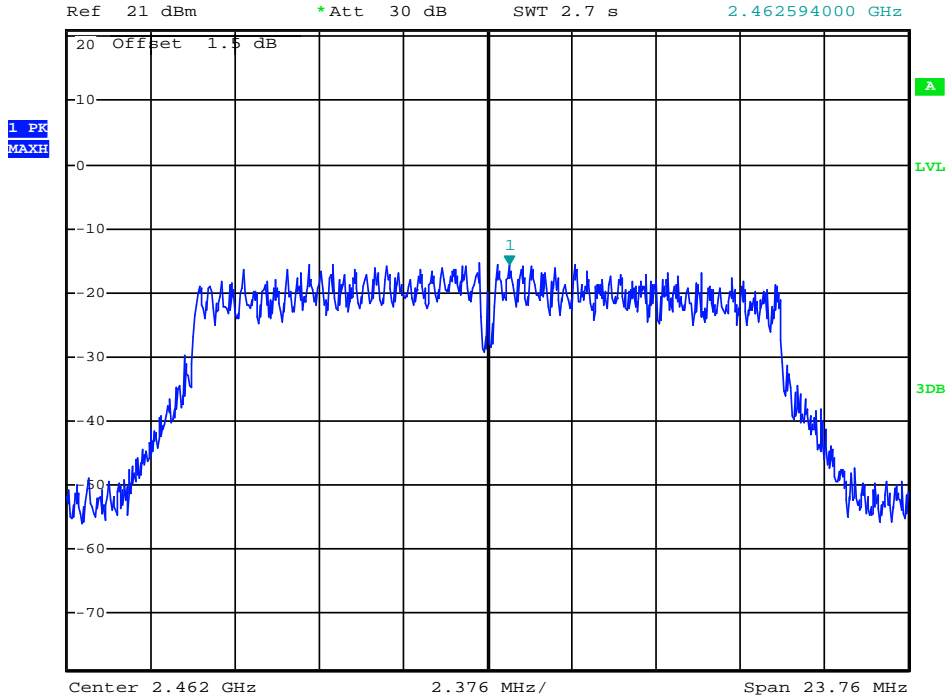

Date: 15.DEC.2013 11:38:25

(Plot 4.4.2 C: Channel 11: 2462MHz @ 802.11g)

**4.4.3 802.11n(20MHz) Test Mode**

**A. Test Verdict**

Channel	Frequency (MHz)	Report PSD (dBm/3kHz)	Refer to Plot	Limits (dBm/3KHz)	Verdict
1	2412	-16.88	Plot 4.4.3 A	8	PASS
6	2437	-16.42	Plot 4.4.3 B	8	PASS
11	2462	-16.27	Plot 4.4.3 C	8	PASS

Note: 1. For 802.11n(20MHz) mode at final test to get the worst-case emission at 6.5Mbps.  
 2.The test results including the cable lose.

**B. Test Plots**



\*RBW 3 kHz      Marker 1 [T1 ]  
\*VBW 10 kHz      -16.88 dBm  
SWT 3 s      2.410764840 GHz

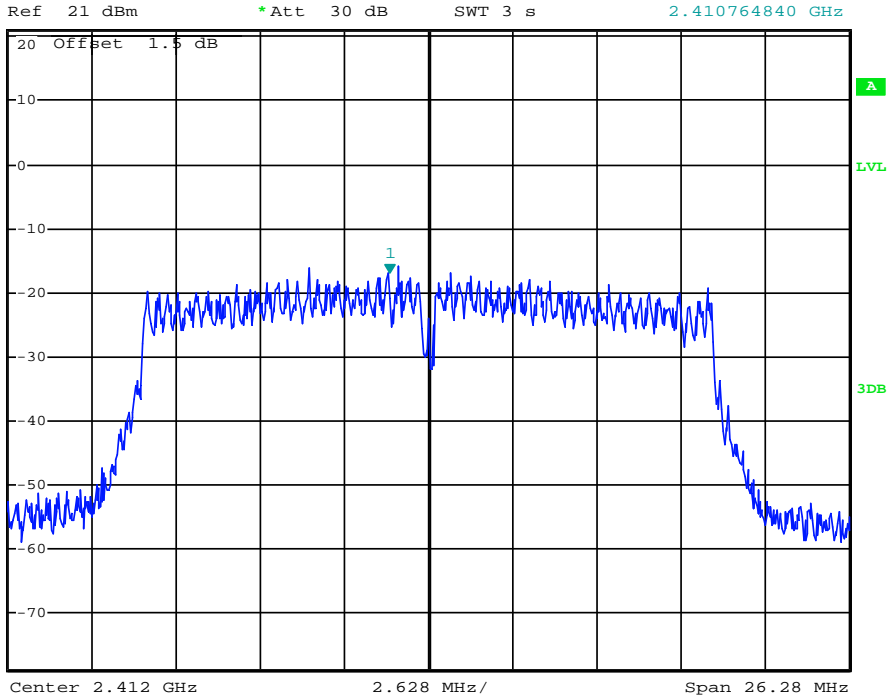

Date: 15.DEC.2013 11:41:37

(Plot 4.4.3 A: Channel 1: 2412MHz @ 802.11n(20MHz))



\*RBW 3 kHz      Marker 1 [T1 ]  
\*VBW 10 kHz      -16.42 dBm  
SWT 3 s      2.433872680 GHz

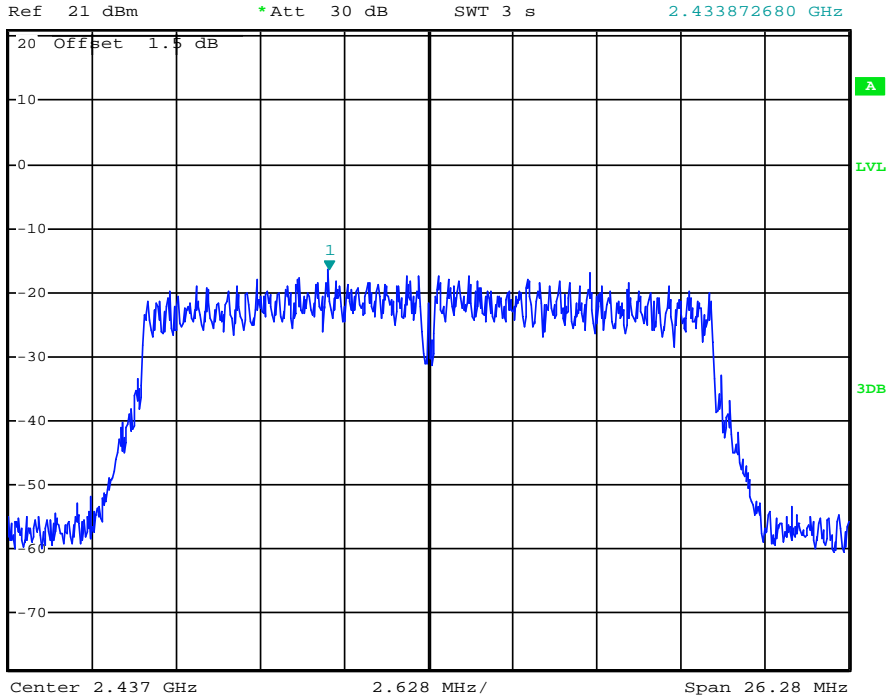

Date: 15.DEC.2013 11:42:15

(Plot 4.4.3 B: Channel 6: 2437MHz @ 802.11n(20MHz))



\*RBW 3 kHz      Marker 1 [T1 ]  
 \*VBW 10 kHz      -16.27 dBm  
 Ref 21 dBm      \*Att 30 dB      SWT 3 s      2.464470320 GHz

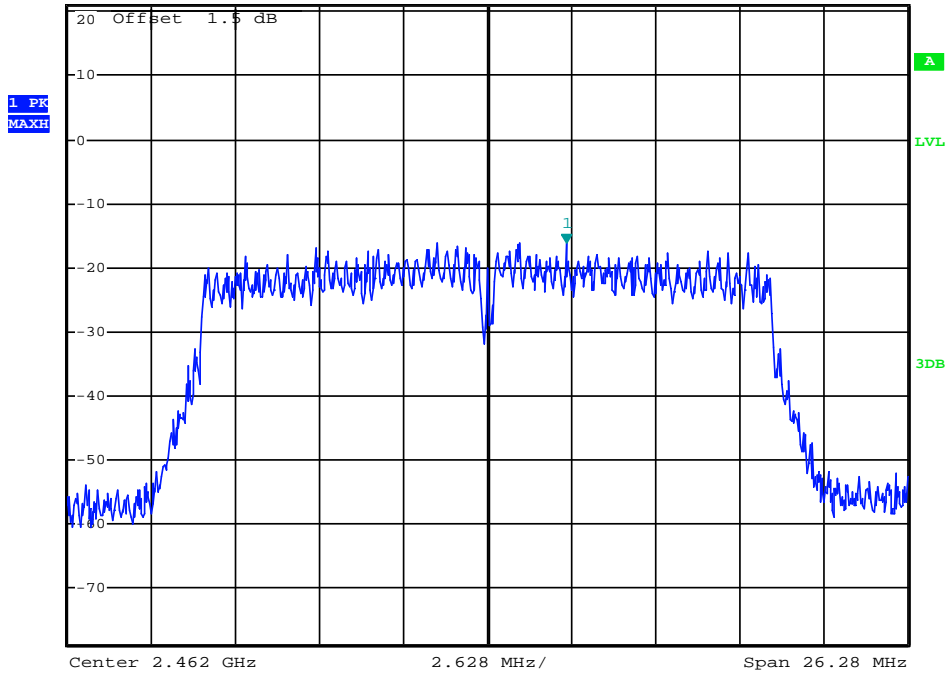

Date: 15.DEC.2013 11:42:39

(Plot 4.4.3 C: Channel 11: 2462MHz @ 802.11n(20MHz))

**4.4.4 802.11n(40MHz) Test Mode**

**A. Test Verdict**

Channel	Frequency (MHz)	Report PSD (dBm/3kHz)	Refer to Plot	Limits (dBm/3KHz)	Verdict
3	2422	-20.48	Plot 4.4.4 A	8	PASS
6	2437	-19.67	Plot 4.4.4 B	8	PASS
9	2452	-19.77	Plot 4.4.4 C	8	PASS

Note: 1. For 802.11n(40MHz) mode at final test to get the worst-case emission at 13.5Mbps.  
 2.The test results including the cable lose.

**B. Test Plots**



\*RBW 3 kHz    Marker 1 [T1 ]  
\*VBW 10 kHz    -20.48 dBm  
SWT 6 s    2.409131650 GHz

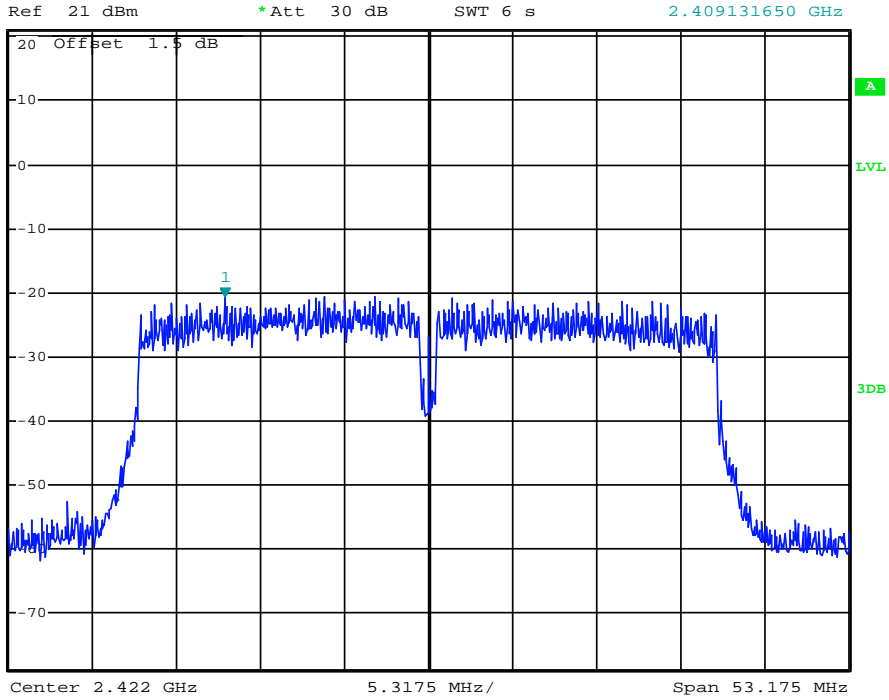

Date: 15.DEC.2013 11:44:19

(Plot 4.4.4 A: Channel 3: 2422MHz @ 802.11n(40MHz))



\*RBW 3 kHz    Marker 1 [T1 ]  
\*VBW 10 kHz    -19.67 dBm  
SWT 6 s    2.427641200 GHz

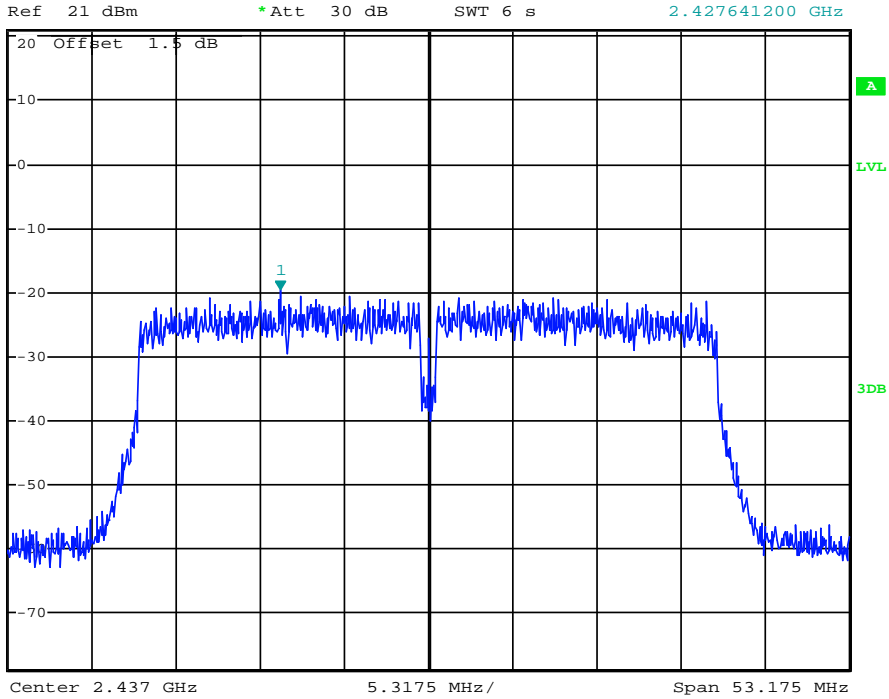

Date: 15.DEC.2013 11:45:02

(Plot 4.4.4 B: Channel 6: 2437MHz @ 802.11n(40MHz))



\*RBW 3 kHz      Marker 1 [T1 ]  
\*VBW 10 kHz      -19.77 dBm  
SWT 6 s            2.460454825 GHz

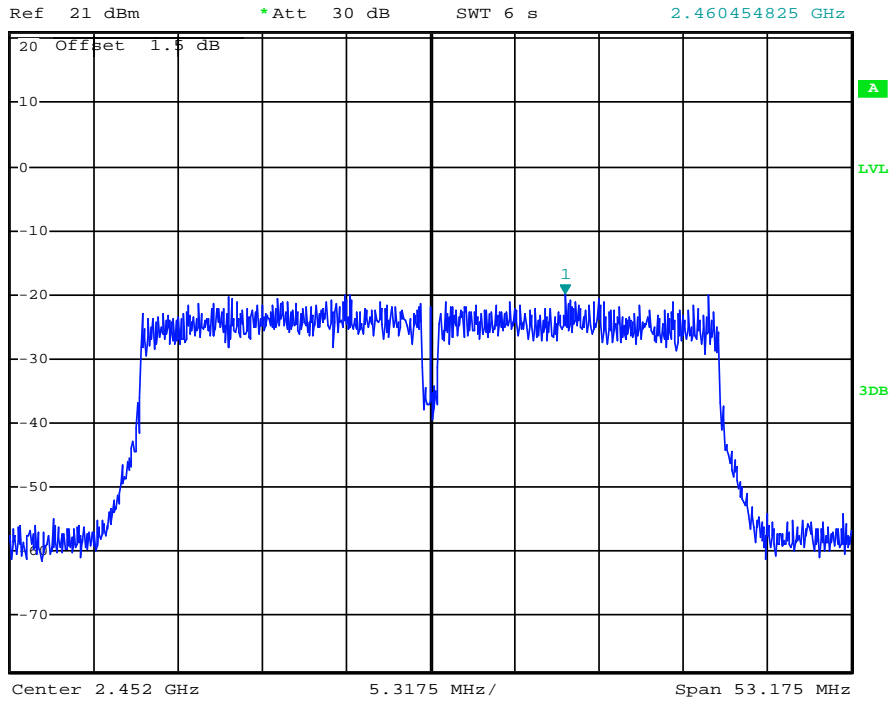

Date: 15.DEC.2013 11:45:45

(Plot 4.4.4 C: Channel 6: 2452MHz @ 802.11n(40MHz))

## 4.5. Band Edge Compliance of RF Emission

### TEST REQUIREMENT

In any 100 kHz bandwidth outside the frequency band in which the spread spectrum or digitally modulated intentional radiator is operating, the radio frequency power that is produced by the intentional radiator shall be at least 20 dB below that in the 100 kHz bandwidth within the band that contains the highest level of the desired power, based on either an RF conducted or a radiated measurement, provided the transmitter demonstrates compliance with the peak conducted power limits. If the transmitter complies with the conducted power limits based on the use of RMS averaging over a time interval, as permitted under paragraph (b)(3) of this section, the attenuation required under this paragraph shall be 30 dB instead of 20 dB. Attenuation below the general limits specified in §15.209(a) is not required. In addition, radiated emissions which fall in the restricted bands, as defined in §15.205(a), must also comply with the radiated emission limits specified in §15.209(a) (see §15.205(c)).

### TEST PROCEDURE

According to KDB 558074 D01 V03 for Antenna-port conducted measurement. Antenna-port conducted measurements may also be used as an alternative to radiated measurements for demonstrating compliance in the restricted frequency bands. If conducted measurements are performed, then proper impedance matching must be ensured and an additional radiated test for cabinet/case spurious emissions is required.

1. Check the calibration of the measuring instrument using either an internal calibrator or a known signal from an external generator.
2. Remove the antenna from the EUT and then connect to a low loss RF cable from the antenna port to a EMI test receiver, then turn on the EUT and make it operate in transmitting mode. Then set it to Low Channel and High Channel within its operating range, and make sure the instrument is operated in its linear range.
3. Set both RBW and VBW of spectrum analyzer to 100 kHz with a convenient frequency span including 100kHz bandwidth from band edge, for Radiated emissions restricted band RBW=1MHz, VBW=3MHz for peak detector and RBW=1MHz, VBW=10Hz for average detector.
4. Measure the highest amplitude appearing on spectral display and set it as a reference level. Plot the graph with marking the highest point and edge frequency.
5. Repeat above procedures until all measured frequencies were complete.
6. Measure the conducted output power (in dBm) using the detector specified by the appropriate regulatory agency (see 12.2.2, 12.2.3, and 12.2.4 for guidance regarding measurement procedures for determining quasi-peak, peak, and average conducted output power, respectively).
7. Add the maximum transmit antenna gain (in dBi) to the measured output power level to determine the EIRP level (see 12.2.5 for guidance on determining the applicable antenna gain)
8. Add the appropriate maximum ground reflection factor to the EIRP level (6 dB for frequencies  $\leq$  30 MHz, 4.7 dB for frequencies between 30 MHz and 1000 MHz, inclusive and 0 dB for frequencies  $>$  1000 MHz).
9. For devices with multiple antenna-ports, measure the power of each individual chain and sum the EIRP of all chains in linear terms (e.g., Watts, mW).
10. Convert the resultant EIRP level to an equivalent electric field strength using the following relationship:  
$$E = \sqrt{EIRP - 20 \log D + 104.8}$$

where:

E = electric field strength in dB $\mu$ V/m,

EIRP = equivalent isotropic radiated power in dBm

D = specified measurement distance in meters.

11. Compare the resultant electric field strength level to the applicable regulatory limit.
12. Perform radiated spurious emission test

### LIMIT

Below -20dB of the highest emission level in operating band.

Radiated emissions which fall in the restricted bands, as defined in § 15.205(a), must also comply with the radiated emission limits specified in § 15.209(a)

### TEST RESULTS

Remark: The Bandedge was measured at difference data rate for each mode and recorded worst case for each mode.

4.5.1 802.11b Test Mode

A. Test Verdict

Frequency (MHz)	Conducted Power (dBm)	Antenna Gain (dBi)	Ground Reflection Factor (dB)	Covert Radiated E Level At 3m (dBuV/m)	Detector	Limit (dBuV/m)	Refer to Plot
2390.00	-40.43	0.40	0.00	55.23	Peak	74.00	Plot 4.5.1 A1
2390.00	-48.45	0.40	0.00	47.21	AV	54.00	Plot 4.5.1 A2
2413.44	8.12	0.40	0.00	103.78	Peak	---	Plot 4.5.1 A1
2411.28	3.69	0.40	0.00	99.35	AV	---	Plot 4.5.1 A2
2463.45	8.80	0.40	0.00	104.46	Peak	---	Plot 4.5.1 A3
2461.25	3.92	0.40	0.00	99.58	AV	---	Plot 4.5.1 A4
2483.50	-37.18	0.40	0.00	58.48	Peak	74.00	Plot 4.5.1 A3
2483.50	-41.97	0.40	0.00	53.69	AV	54.00	Plot 4.5.1 A4

- Note: 1. For 802.11b mode at final test to get the worst-case emission at 1Mbps.  
 2. The test results including the cable lose.  
 3. "----" means that the fundamental frequency not for 15.209 limits requirement.

B. Test Plots

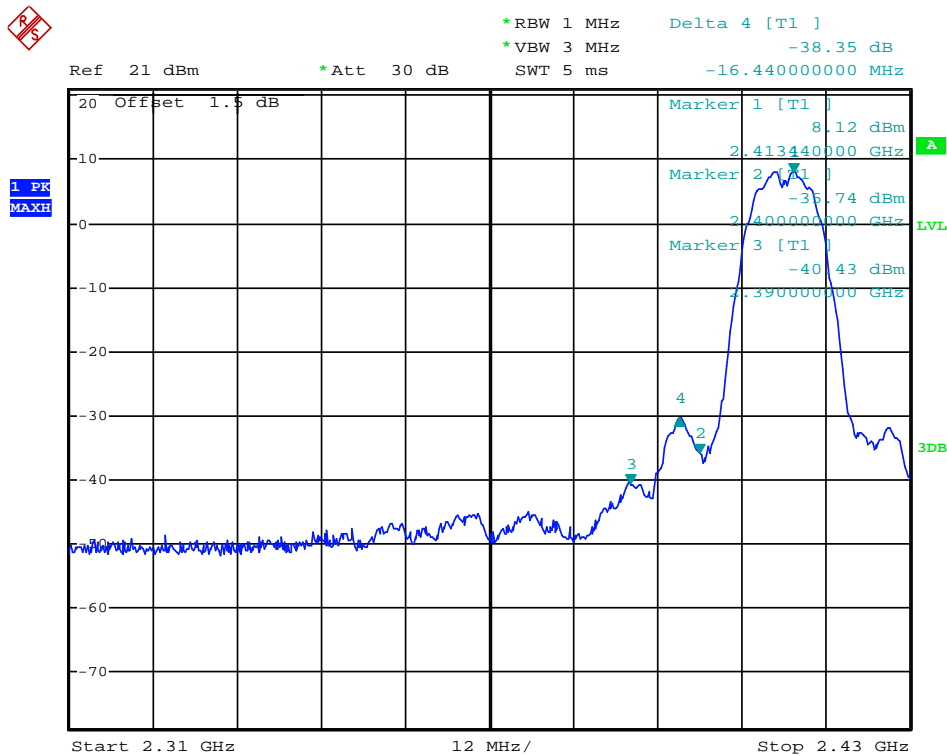

Date: 15.DEC.2013 12:37:04

(Plot 4.5.1 A1: Channel 1: 2412MHz @ 802.11b)





\*RBW 1 MHz      Delta 4 [T1 ]  
\*VBW 10 Hz      -39.26 dB  
SWT 9.6 s      -13.44000000 MHz

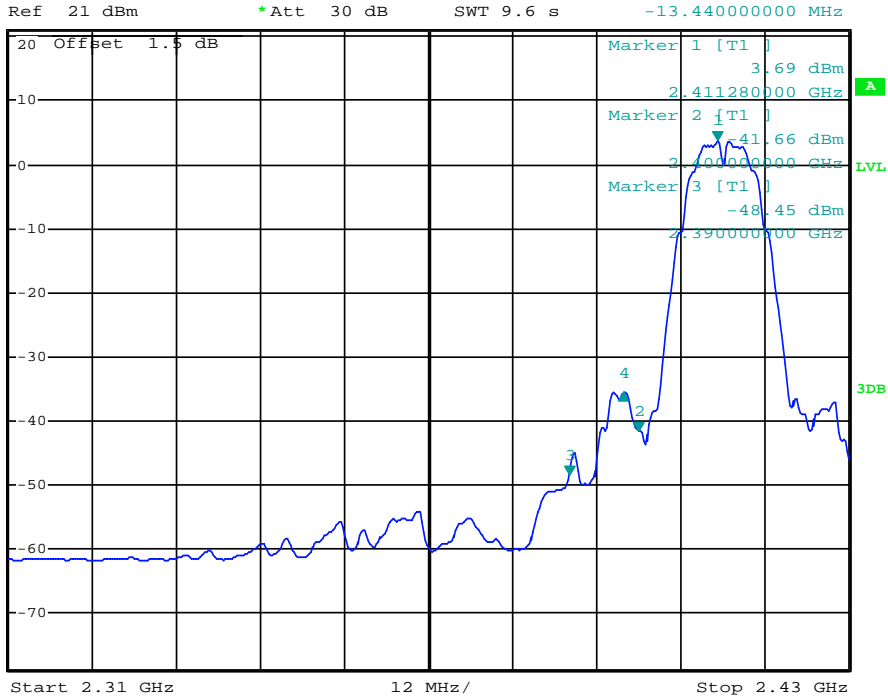

Date: 15.DEC.2013 12:38:25

(Plot 4.5.1 A2: Channel 1: 2412MHz @ 802.11b)



\*RBW 1 MHz      Marker 1 [T1 ]  
\*VBW 3 MHz      -37.18 dBm  
SWT 5 ms      2.483500000 GHz

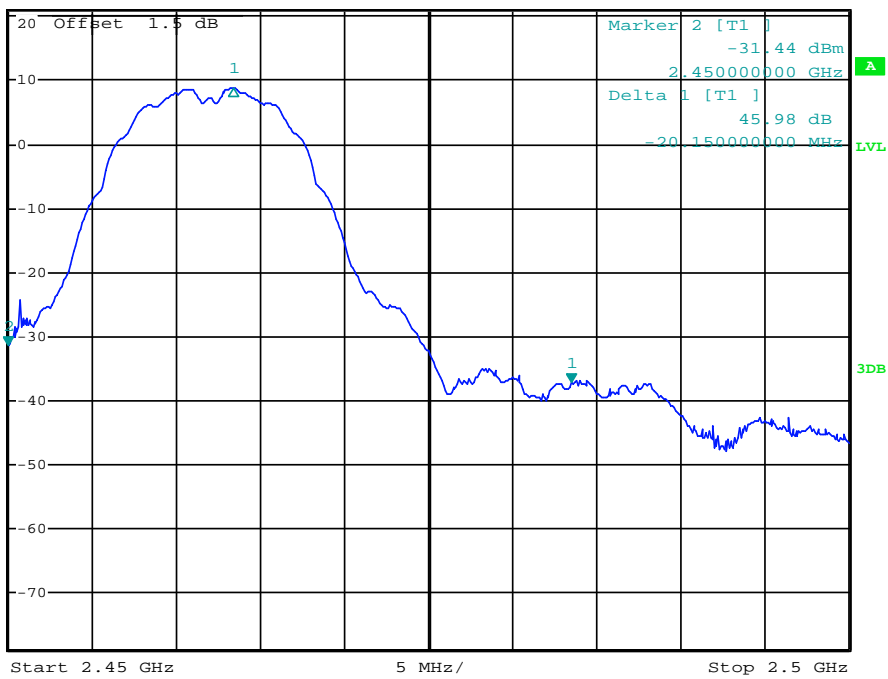

Date: 15.DEC.2013 12:47:59

(Plot 4.5.1 A3: Channel 11: 2462MHz @ 802.11b)

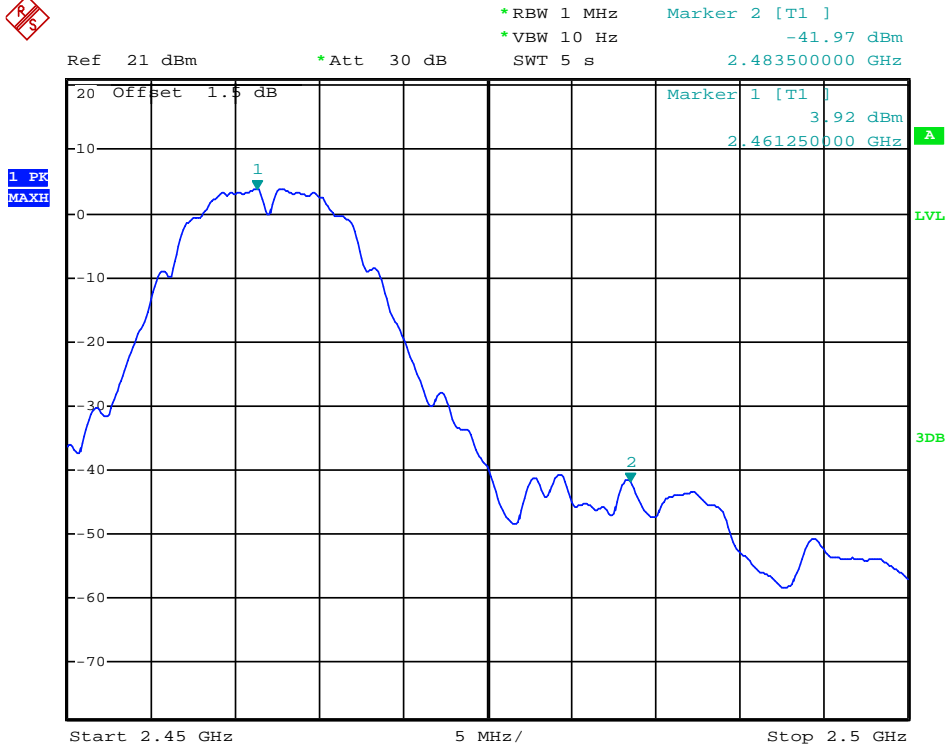

Date: 15.DEC.2013 12:48:40

(Plot 4.5.1 A4: Channel 11: 2462MHz @ 802.11b)

4.5.2 802.11g Test Mode

A. Test Verdict

Frequency (MHz)	Conducted Power (dBm)	Antenna Gain (dBi)	Ground Reflection Factor (dB)	Covert Radiated E Level At 3m (dBuV/m)	Detector	Limit (dBuV/m)	Refer to Plot
2390.00	-27.88	0.40	0.00	67.78	Peak	74.00	Plot 4.5.2 A1
2390.00	-45.90	0.40	0.00	49.76	AV	54.00	Plot 4.5.2 A2
2411.16	7.81	0.40	0.00	103.47	Peak	---	Plot 4.5.2 A1
2411.16	2.21	0.40	0.00	97.87	AV	---	Plot 4.5.2 A2
2463.60	8.96	0.40	0.00	104.62	Peak	---	Plot 4.5.2 A3
2460.85	-1.43	0.40	0.00	94.23	AV	---	Plot 4.5.2 A4
2483.50	-23.61	0.40	0.00	72.05	Peak	74.00	Plot 4.5.2 A3
2483.50	-42.95	0.40	0.00	52.71	AV	54.00	Plot 4.5.2 A4

- Note:
1. For 802.11g mode at final test to get the worst-case emission at 6Mbps.
  2. The test results including the cable lose.
  3. “---” means that the fundamental frequency not for 15.209 limits requirement.

B. Test Plots

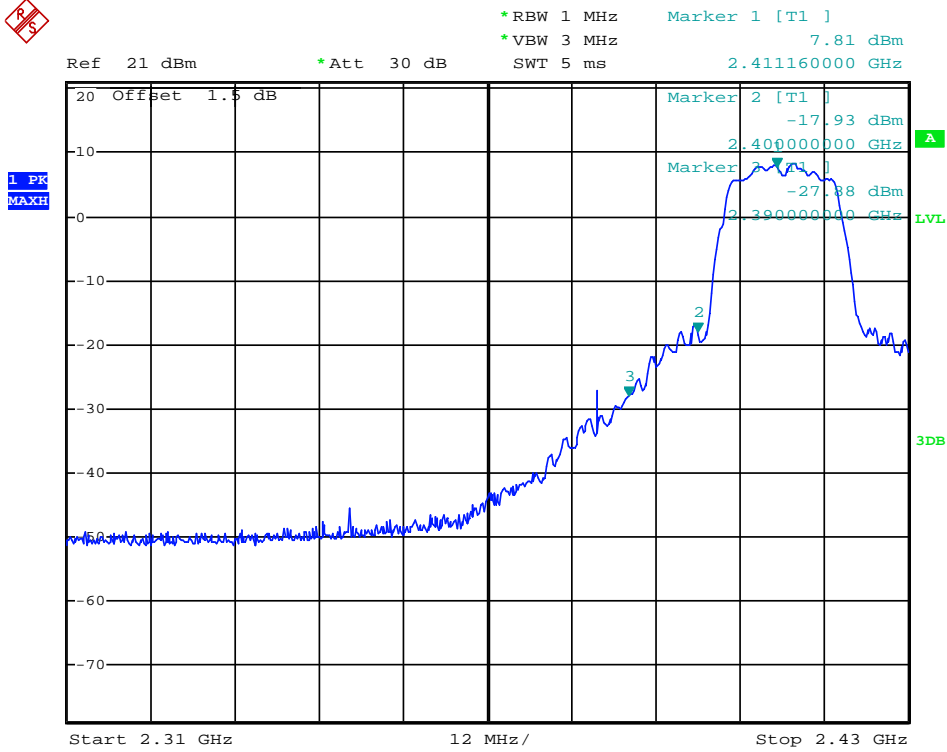

Date: 15.DEC.2013 12:42:08

(Plot 4.5.2 A1: Channel 1: 2412MHz @ 802.11g)

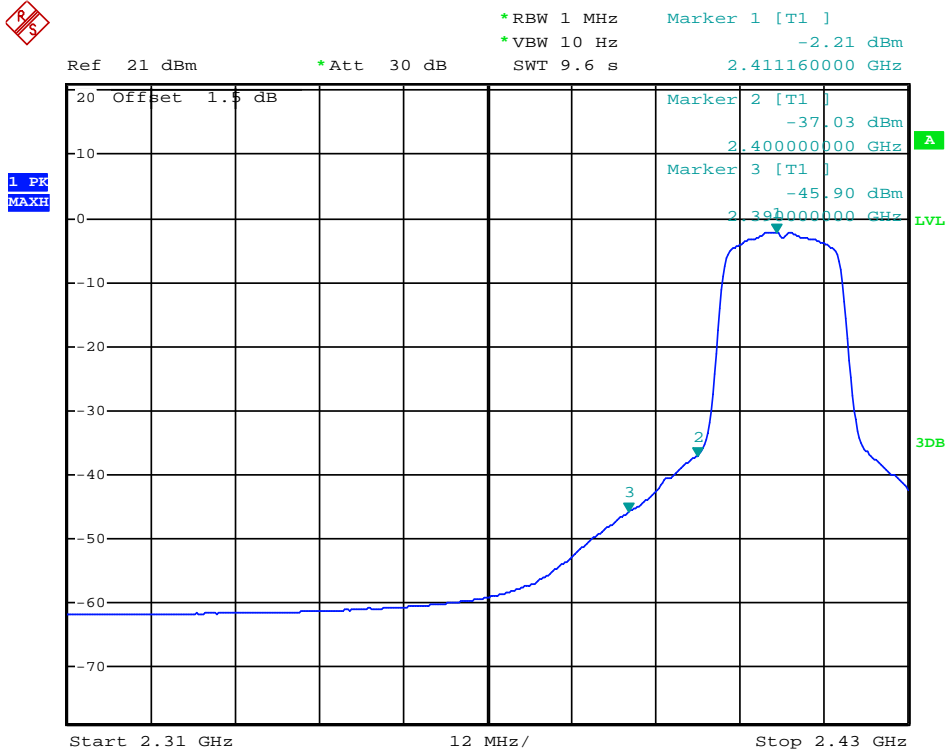

Date: 15.DEC.2013 12:39:40

(Plot 4.5.2 A2: Channel 1: 2412MHz @ 802.11g)



\*RBW 1 MHz      Marker 1 [T1 ]  
\*VBW 3 MHz      8.96 dBm  
SWT 5 ms      2.463600000 GHz

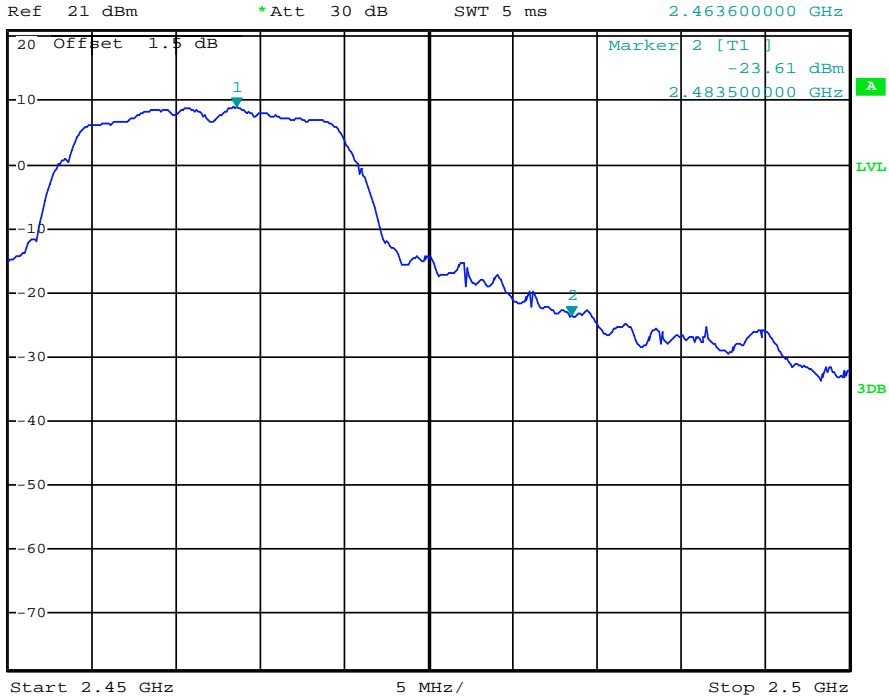

Date: 15.DEC.2013 12:49:42

(Plot 4.5.2 A3: Channel 11: 2462MHz @ 802.11g)



\*RBW 1 MHz      Marker 1 [T1 ]  
\*VBW 10 Hz      -1.43 dBm  
SWT 5 s      2.460850000 GHz

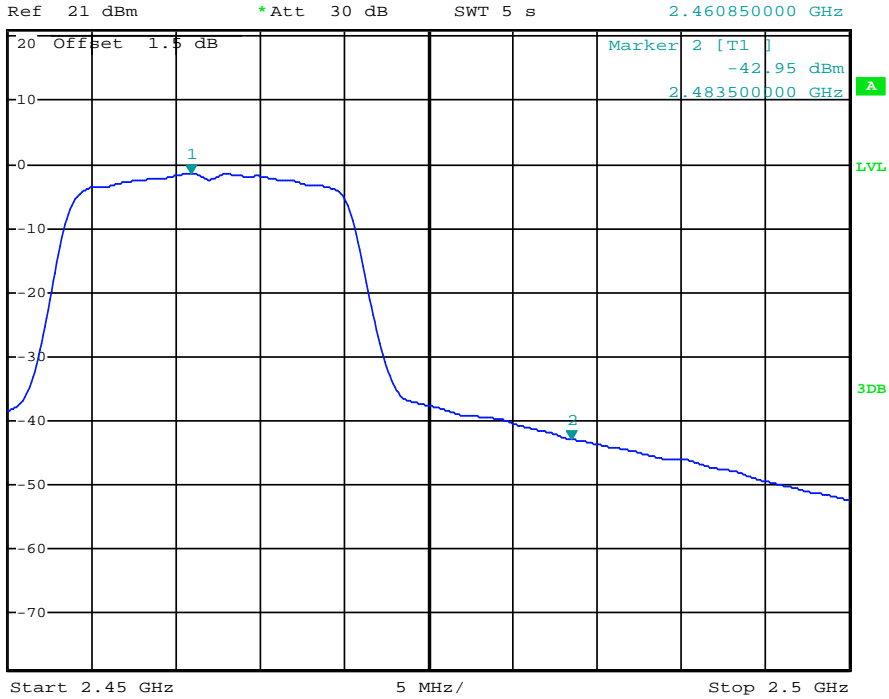

Date: 15.DEC.2013 12:49:21

(Plot 4.5.2 A4: Channel 11: 2462MHz @ 802.11g)

4.5.3 802.11n(20MHz) Test Mode

A. Test Verdict

Frequency (MHz)	Conducted Power (dBm)	Antenna Gain (dBi)	Ground Reflection Factor (dB)	Covert Radiated E Level At 3m (dBuV/m)	Detector	Limit (dBuV/m)	Refer to Plot
2390.00	-30.80	0.40	0.00	64.86	Peak	74.00	Plot 4.5.3 A1
2390.00	-47.18	0.40	0.00	48.48	AV	54.00	Plot 4.5.3 A2
2410.44	7.07	0.40	0.00	102.73	Peak	---	Plot 4.5.3 A1
2410.56	-3.77	0.40	0.00	91.89	AV	---	Plot 4.5.3 A2
2463.80	7.45	0.40	0.00	103.11	Peak	---	Plot 4.5.3 A3
2463.55	-3.51	0.40	0.00	92.15	AV	---	Plot 4.5.3 A4
2483.50	-24.84	0.40	0.00	70.82	Peak	74.00	Plot 4.5.3 A3
2483.50	-47.39	0.40	0.00	48.27	AV	54.00	Plot 4.5.3 A4

- Note: 1. For 802.11n(20MHz) mode at final test to get the worst-case emission at 6.5Mbps.  
 2. The test results including the cable lose.  
 3. "----" means that the fundamental frequency not for 15.209 limits requirement.

B. Test Plots

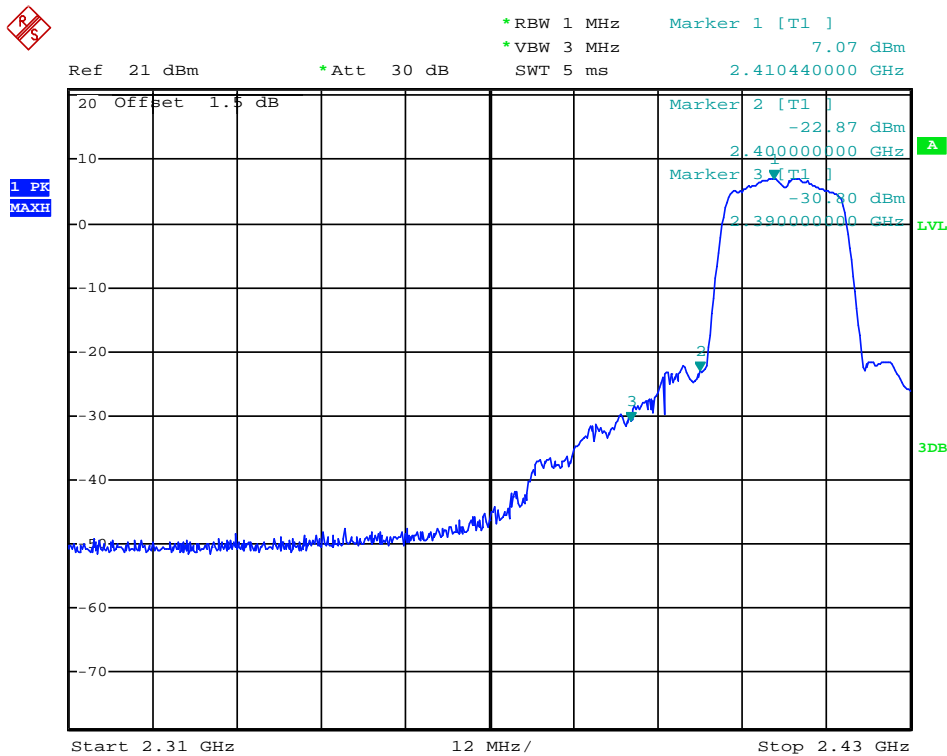

Date: 15.DEC.2013 12:45:05

(Plot 4.5.3 A1: Channel 1: 2412MHz @ 802.11n(20MHz))

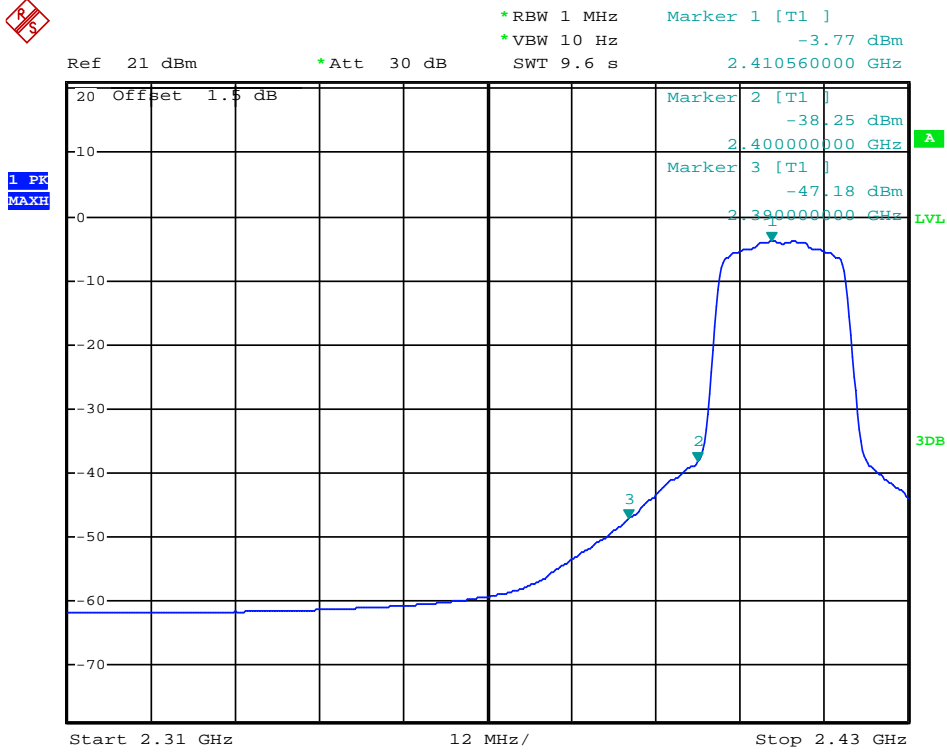

Date: 15.DEC.2013 12:45:43

(Plot 4.5.3 A2: Channel 1: 2412MHz @ 802.11n(20MHz))

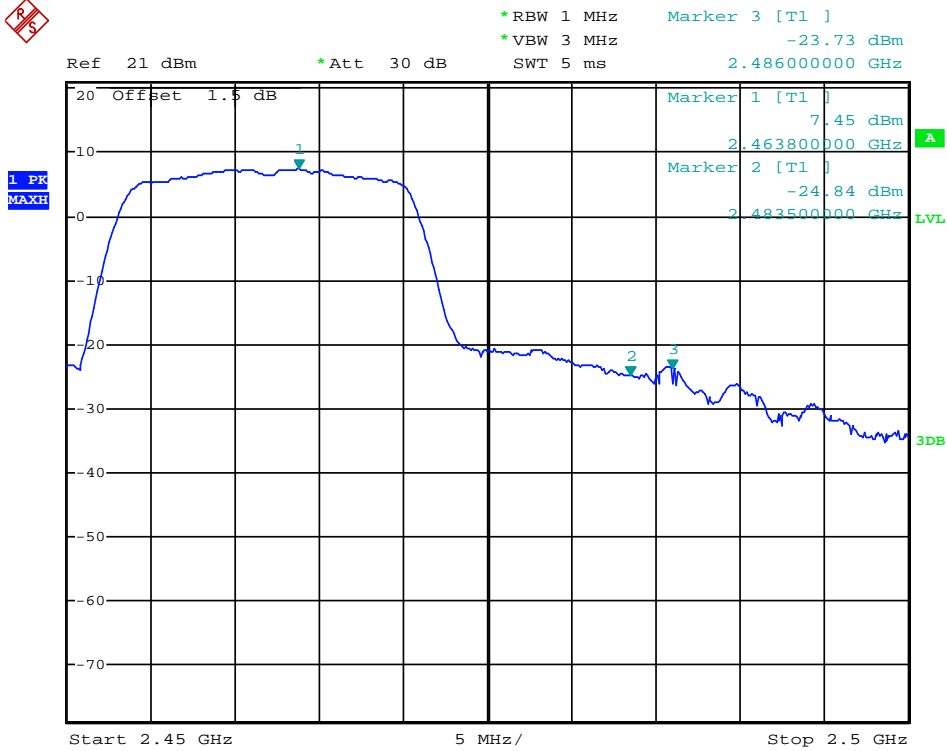

Date: 15.DEC.2013 12:51:41

(Plot 4.5.3 A3: Channel 11: 2462MHz @ 802.11n(20MHz))

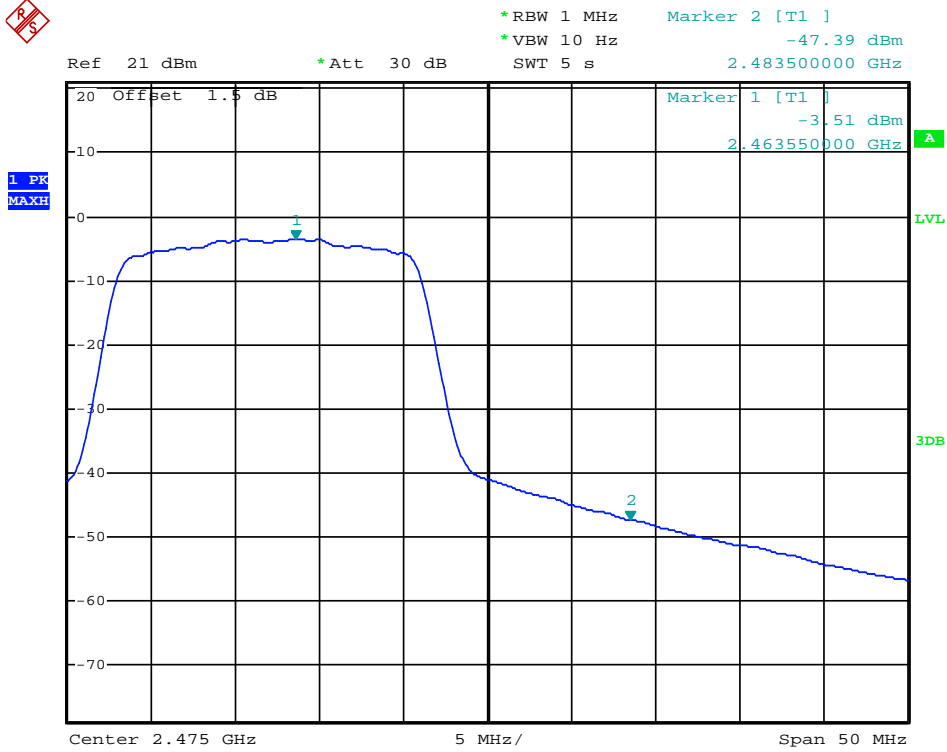

Date: 15.DEC.2013 13:19:37

(Plot 4.5.3 A4: Channel 11: 2462MHz @ 802.11n(20MHz))

**4.5.4 802.11n(40MHz) Test Mode**

**A. Test Verdict**

Frequency (MHz)	Conducted Power (dBm)	Antenna Gain (dBi)	Ground Reflection Factor (dB)	Covert Radiated E Level At 3m (dBuV/m)	Detector	Limit (dBuV/m)	Refer to Plot
2390.00	-28.07	0.40	0.00	67.59	Peak	74.00	Plot 4.5.4 A1
2390.00	-43.41	0.40	0.00	52.25	AV	54.00	Plot 4.5.4 A2
2416.68	4.40	0.40	0.00	100.06	Peak	---	Plot 4.5.4 A1
2416.40	-6.19	0.40	0.00	89.47	AV	---	Plot 4.5.4 A2
2460.94	3.94	0.40	0.00	99.6	Peak	---	Plot 4.5.4 A3
2458.14	-6.54	0.40	0.00	89.12	AV	---	Plot 4.5.4 A4
2483.50	-25.82	0.40	0.00	69.84	Peak	74.00	Plot 4.5.4 A3
2483.50	-44.53	0.40	0.00	51.13	AV	54.00	Plot 4.5.4 A4

Note: 1. For 802.11n(40MHz) mode at final test to get the worst-case emission at 13.5Mbps.  
 2. The test results including the cable loss.  
 3. “---” means that the fundamental frequency not for 15.209 limits requirement.

**B. Test Plots**

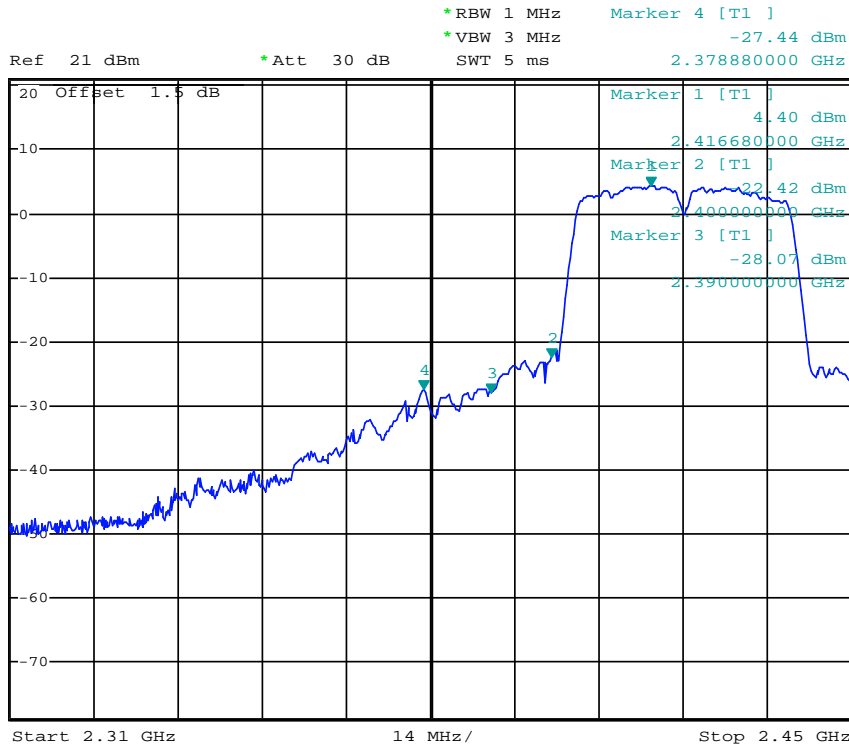

Date: 15.DEC.2013 12:56:44

(Plot 4.5.4 A1: Channel 3: 2422MHz @ 802.11n(40MHz))

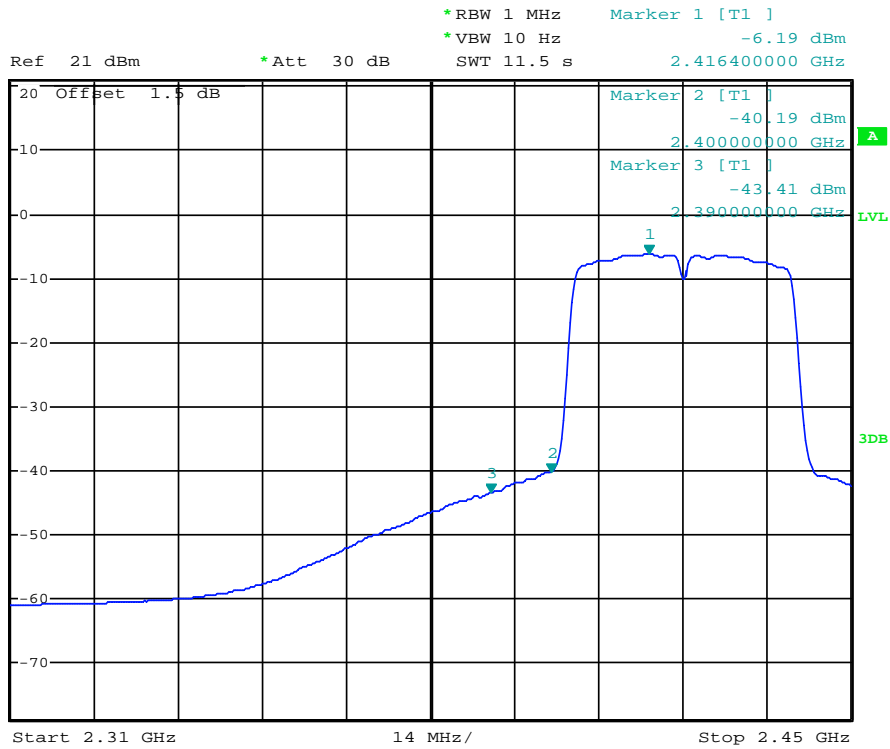

Date: 15.DEC.2013 12:58:06

(Plot 4.5.4 A2: Channel 3: 2422MHz @ 802.11n(40MHz))





\*RBW 1 MHz      Marker 1 [T1 ]  
\*VBW 3 MHz      3.94 dBm  
SWT 5 ms      2.460940000 GHz

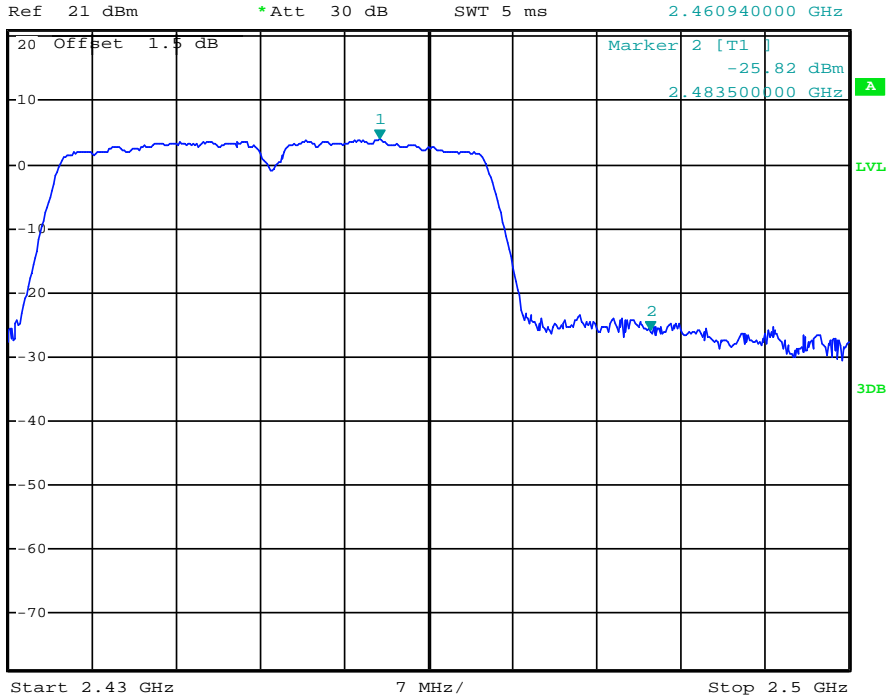

Date: 15.DEC.2013 12:54:06

(Plot 4.5.4 A3: Channel 9: 2452MHz @ 802.11n(40MHz))



\*RBW 1 MHz      Marker 1 [T1 ]  
\*VBW 10 Hz      -6.54 dBm  
SWT 5.6 s      2.458140000 GHz

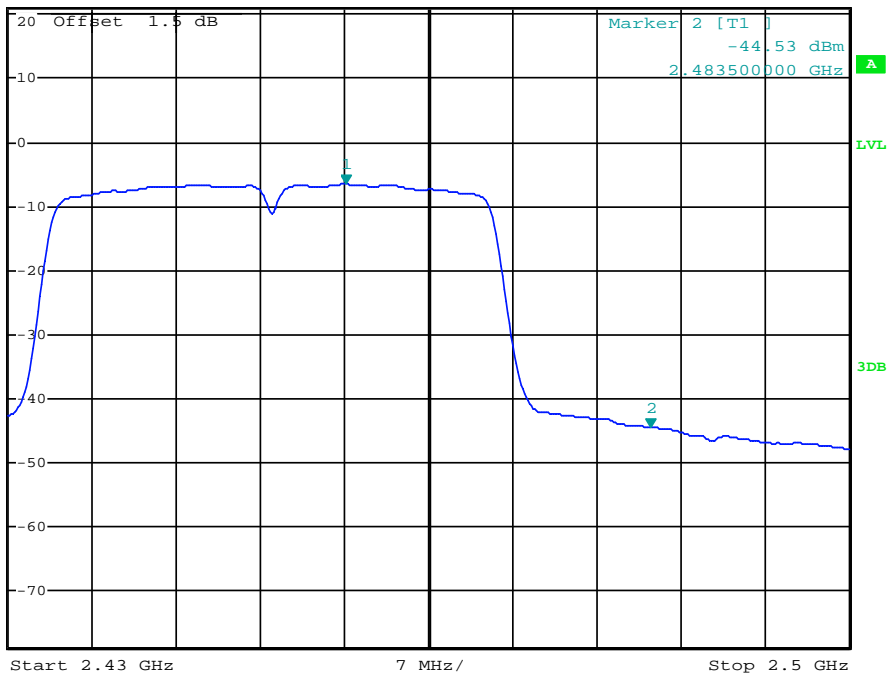

Date: 15.DEC.2013 12:54:52

(Plot 4.5.4 A4: Channel 9: 2452MHz @ 802.11n(40MHz))

## 4.6. Spurious RF Conducted Emission

### TEST CONFIGURATION

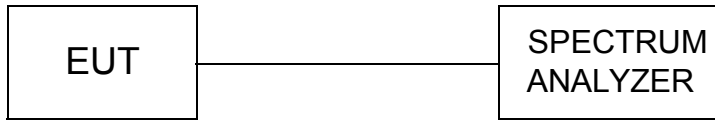

### TEST PROCEDURE

The Spurious RF conducted emissions compliance of RF radiated emission should be measured by following the guidance in ANSI C63.10-2009 with respect to maximizing the emission by rotating the EUT, measuring the emission while the EUT is situated in three orthogonal planes (if appropriate), adjusting the measurement antenna height and polarization etc. Set RBW=100kHz and VBM= 300KHz to measure the peak field strength, and measure frequency range from 30MHz to 26.5GHz.

### LIMIT

1. Below -20dB of the highest emission level in operating band.
2. Fall in the restricted bands listed in section 15.205. The maximum permitted average field strength is listed in section 15.209.

### TEST RESULTS

Remark: The measurement frequency range is from 30MHz to the 10<sup>th</sup> harmonic of the fundamental frequency. The lowest, middle and highest channels are tested to verify the spurious emissions and bandedge measurement data.

#### 4.6.1 802.11b Test Mode

##### A. Test Verdict

Channel	Frequency (MHz)	Refer to Plot	Limit (dBc)	Verdict
1	2412	Plot 4.6.1 A1	-20	PASS
		Plot 4.6.1 A2	-20	PASS
		Plot 4.6.1 A3	-20	PASS
6	2437	Plot 4.6.1 B1	-20	PASS
		Plot 4.6.1 B2	-20	PASS
		Plot 4.6.1 B3	-20	PASS
11	2462	Plot 4.6.1 C1	-20	PASS
		Plot 4.6.1 C2	-20	PASS
		Plot 4.6.1 C3	-20	PASS

Frequency (MHz)	Delta Peak to Band emission (dBc)	Detector	Limit (dBc)	Refer to Plot	Verdict
2400.00	-39.62	Peak	-20	Plot 4.6.1 D	PASS
2483.50	-44.63	Peak	-20	Plot 4.6.1 E	PASS

- Note: 1. For 802.11b mode at final test to get the worst-case emission at 1Mbps.  
2. The test results including the cable loss.

##### B. Test Plots

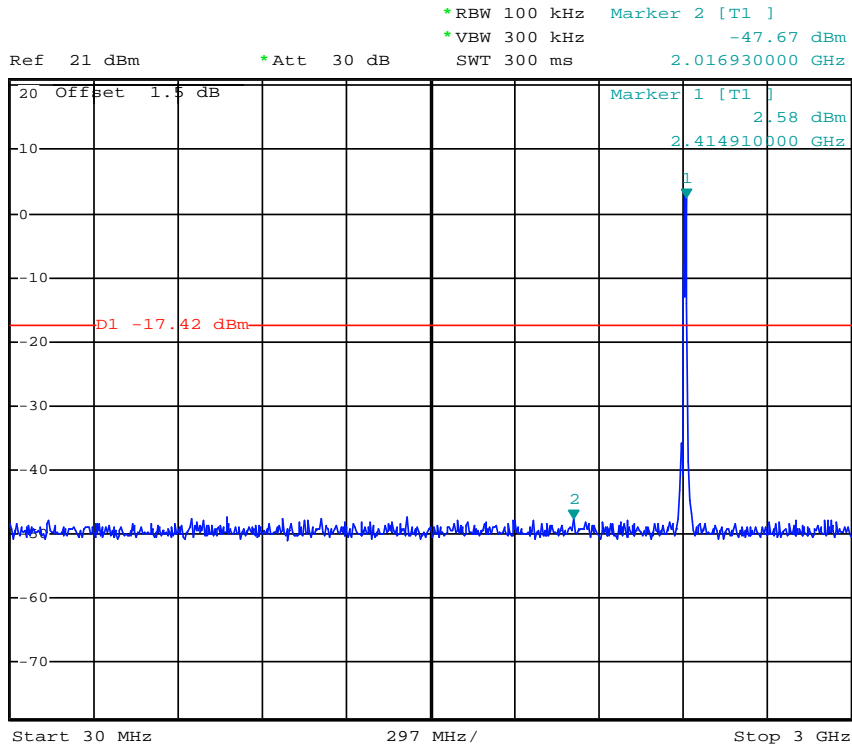

Date: 15.DEC.2013 13:46:03

(Plot 4.6.1 A1: Channel 1: 2412MHz @ 802.11b)

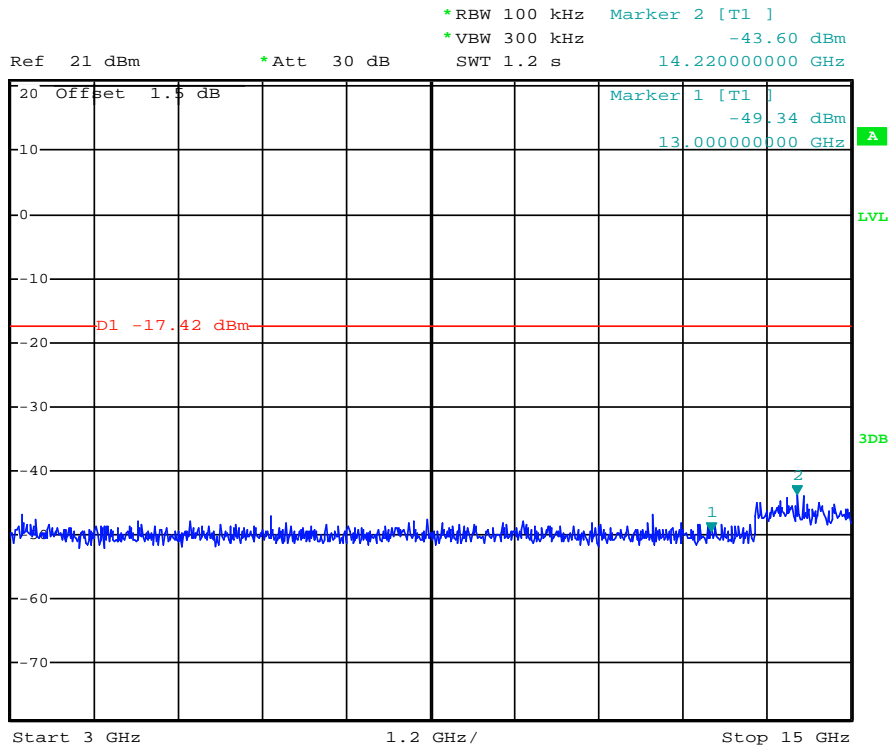

Date: 15.DEC.2013 13:46:21

(Plot 4.6.1 A2: Channel 1: 2412MHz @ 802.11b)



\*RBW 100 kHz Marker 1 [T1 ]  
\*VBW 300 kHz -42.17 dBm  
SWT 1 s 24.85000000 GHz

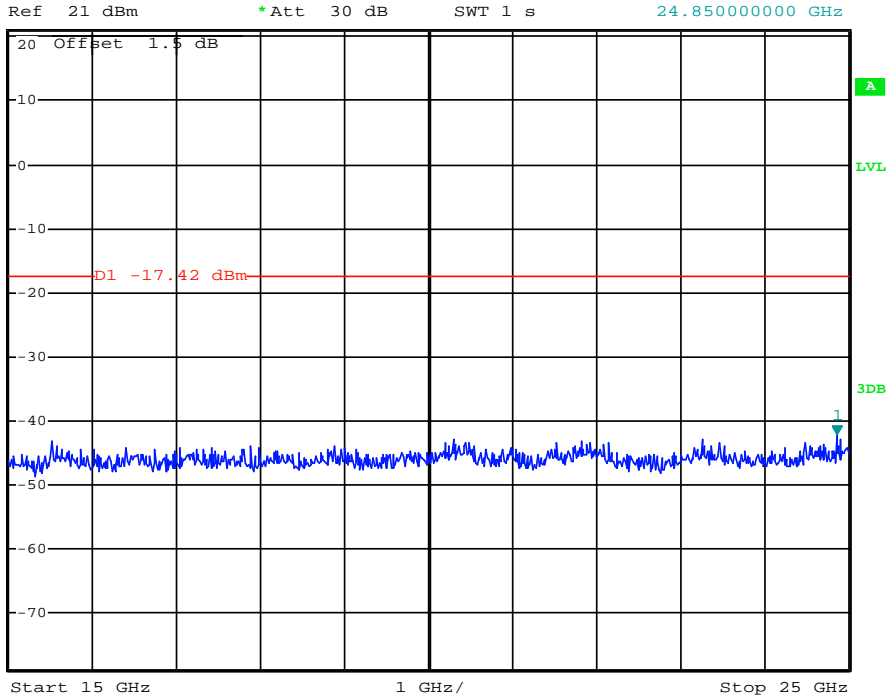

Date: 15.DEC.2013 13:46:44

(Plot 4.6.1 A3: Channel 1: 2412MHz @ 802.11b)



\*RBW 100 kHz Marker 2 [T1 ]  
\*VBW 300 kHz -47.31 dBm  
SWT 300 ms 2.224830000 GHz

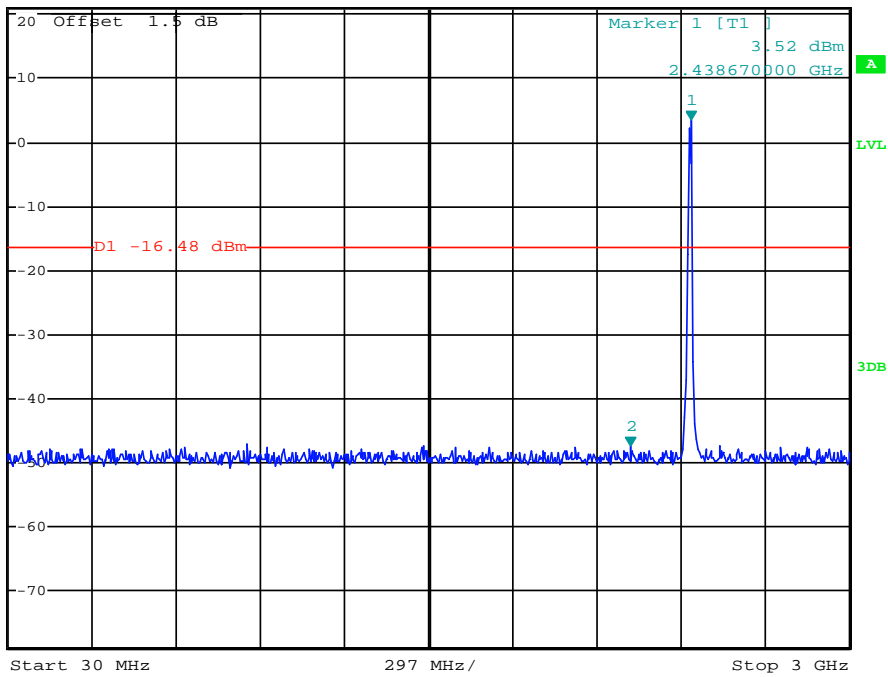

Date: 15.DEC.2013 13:47:45

(Plot 4.6.1 B1: Channel 6: 2437MHz @ 802.11b)



\*RBW 100 kHz Marker 1 [T1 ]  
\*VBW 300 kHz -44.39 dBm  
SWT 1.2 s 14.124000000 GHz

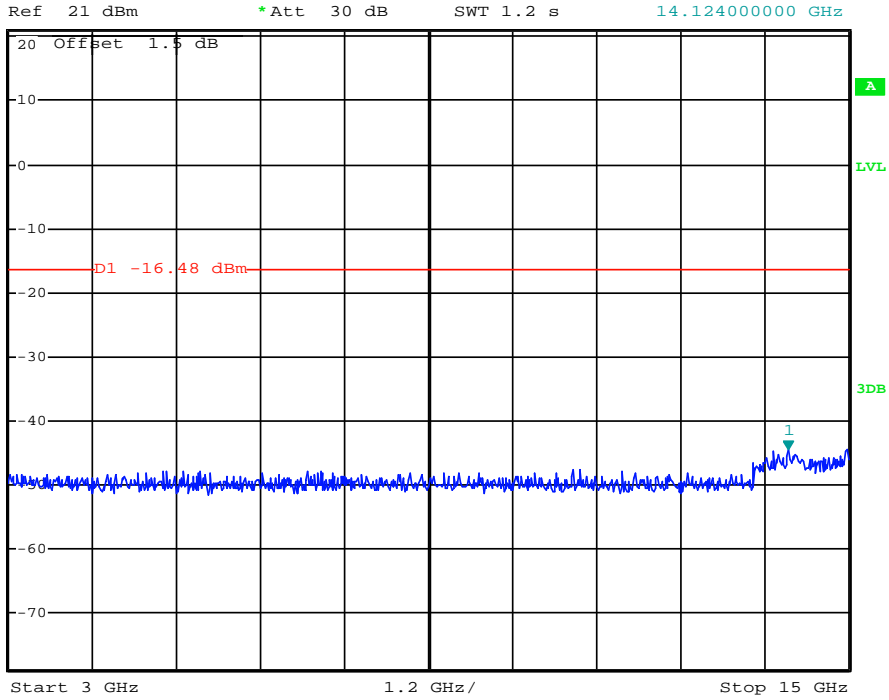

Date: 15.DEC.2013 13:48:02

(Plot 4.6.1 B2: Channel 6: 2437MHz @ 802.11b)



\*RBW 100 kHz Marker 1 [T1 ]  
\*VBW 300 kHz -42.84 dBm  
SWT 1 s 24.920000000 GHz

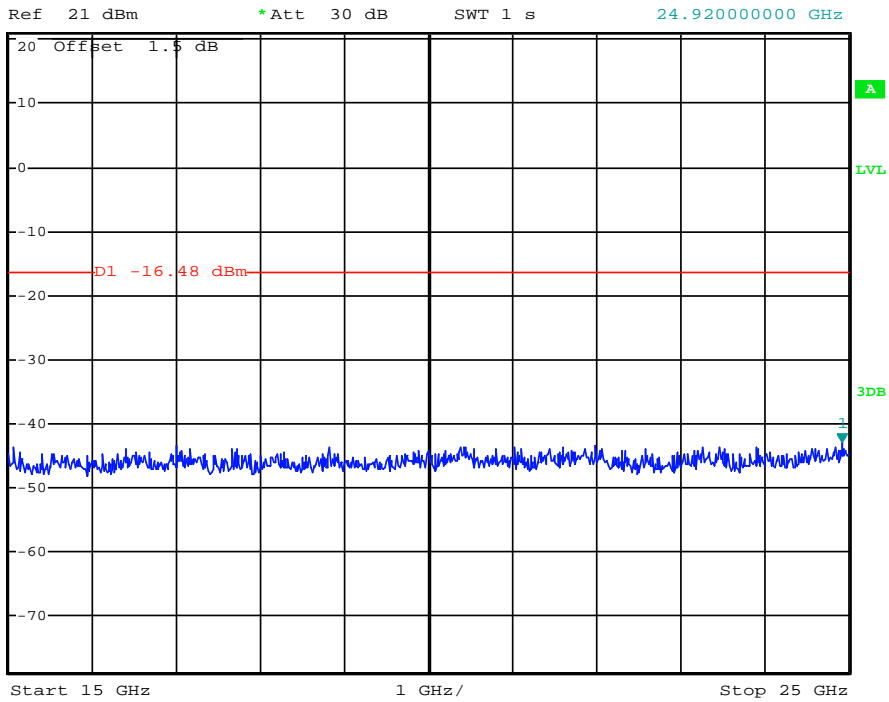

Date: 15.DEC.2013 13:48:13

(Plot 4.6.1 B3: Channel 6: 2437MHz @ 802.11b)

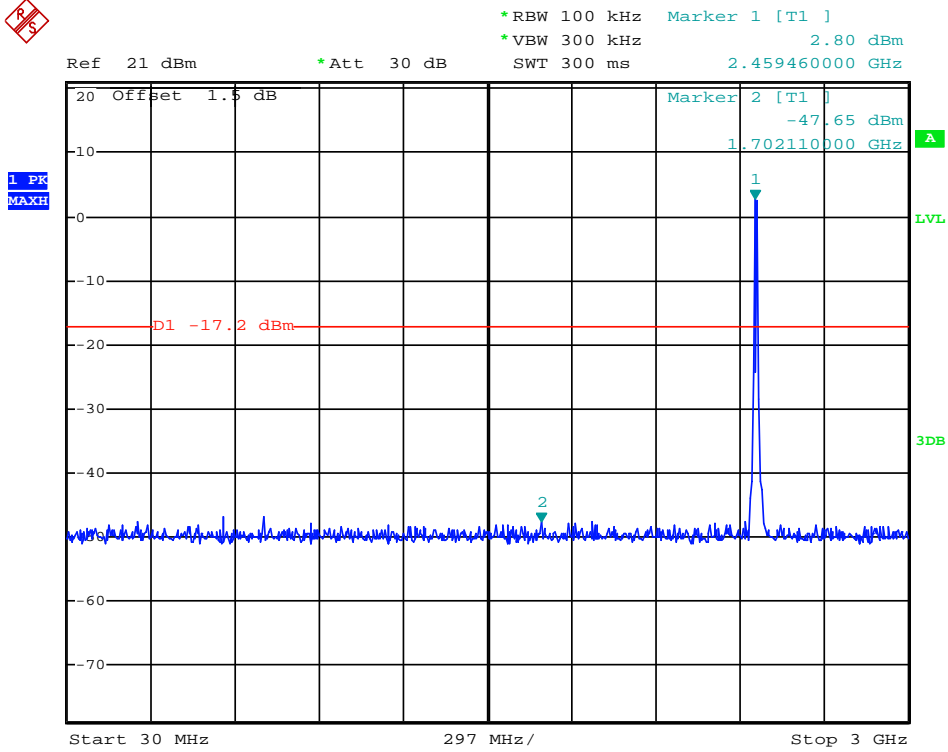

Date: 15.DEC.2013 13:48:46

(Plot 4.6.1 C1: Channel 11: 2462MHz @ 802.11b)

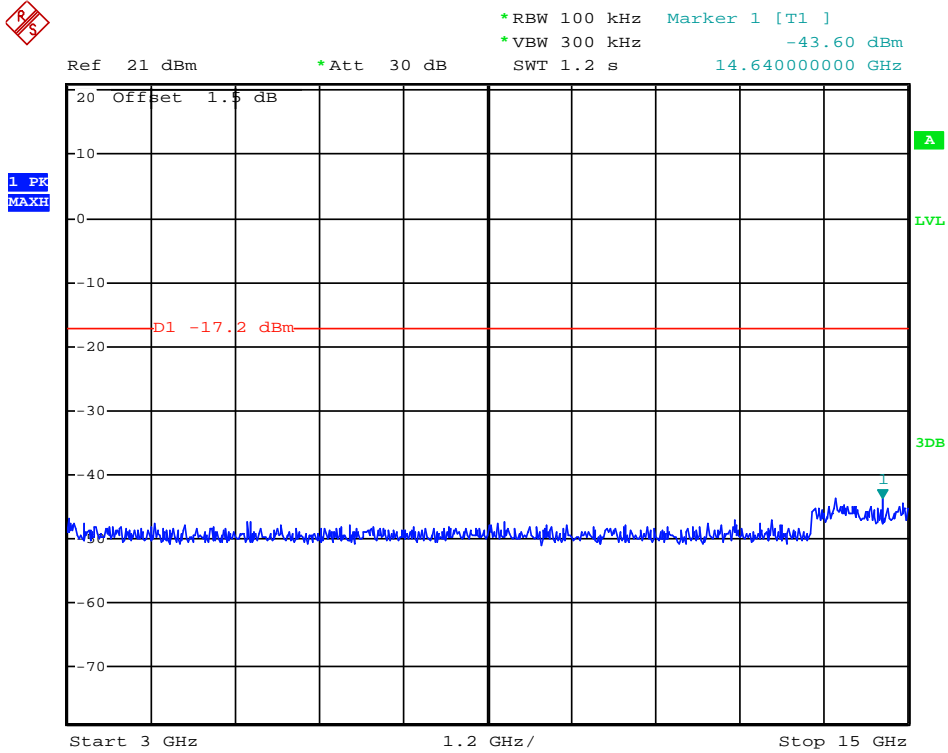

Date: 15.DEC.2013 13:49:07

(Plot 4.6.1 C2: Channel 11: 2462MHz @ 802.11b)



\*RBW 100 kHz Marker 1 [T1 ]  
\*VBW 300 kHz -42.58 dBm  
SWT 1 s 21.57000000 GHz

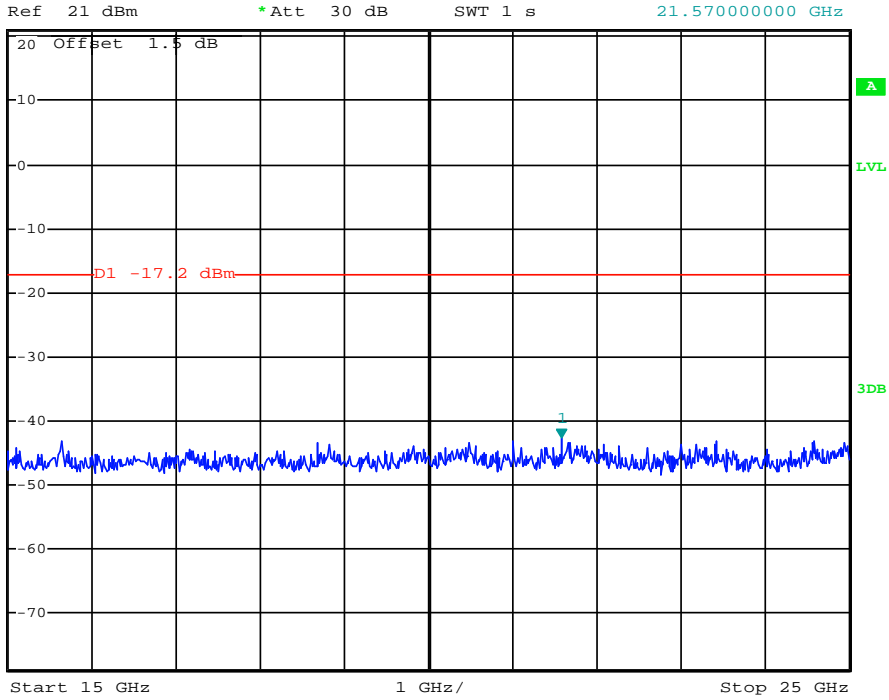

Date: 15.DEC.2013 13:49:17

(Plot 4.6.1 C3: Channel 11: 2462MHz @ 802.11b)



\*RBW 100 kHz Marker 3 [T1 ]  
\*VBW 300 kHz -36.08 dBm  
SWT 15 ms 2.397000000 GHz

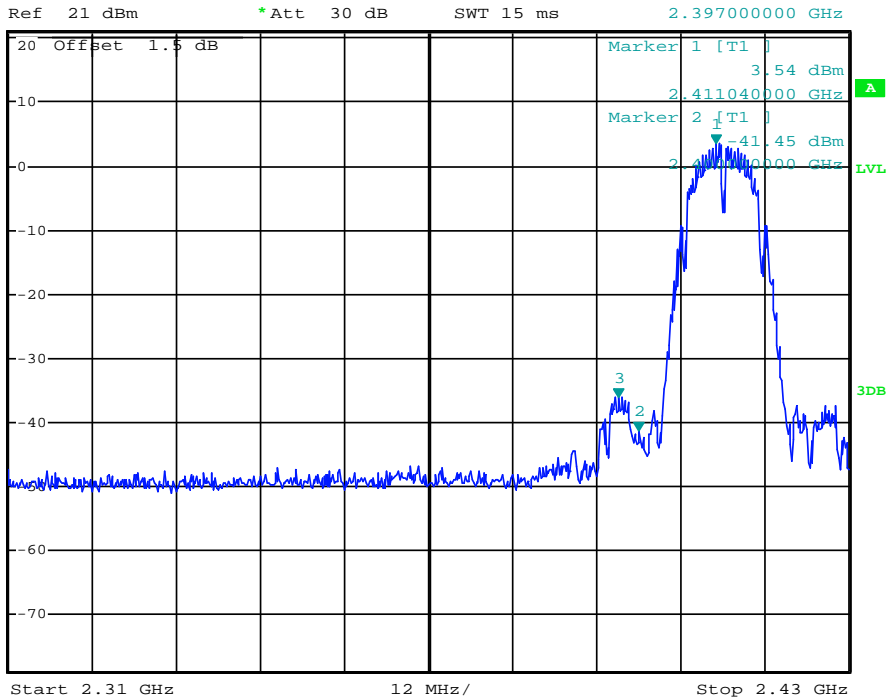

Date: 15.DEC.2013 13:22:06

(Plot 4.6.1 D: Channel 1: 2412MHz @ 802.11b)

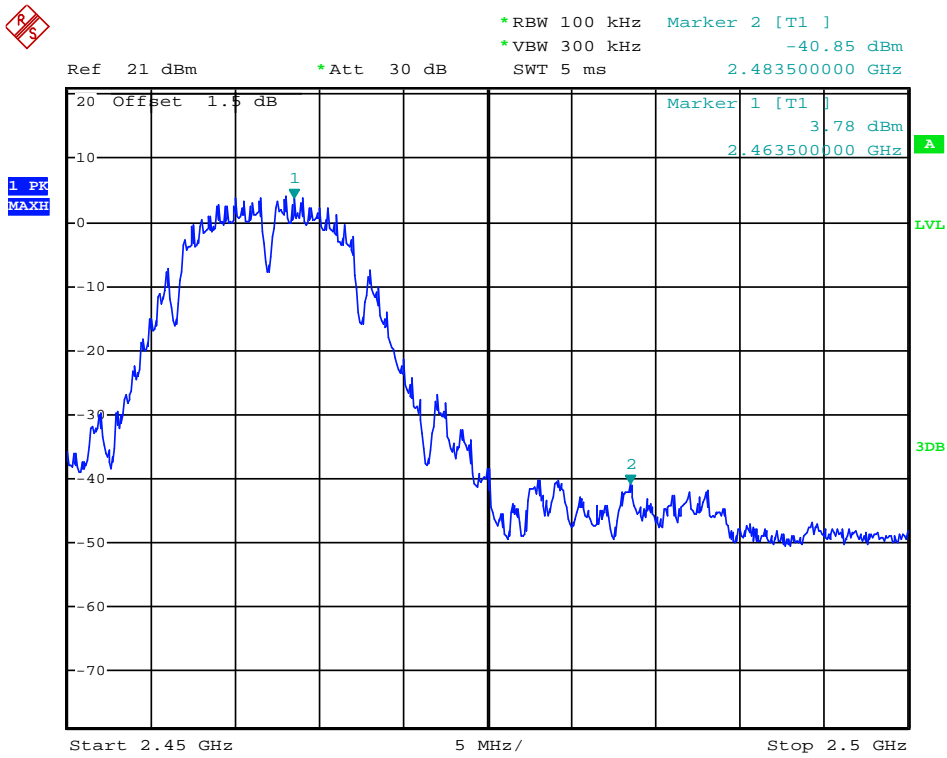

Date: 15.DEC.2013 13:25:48

(Plot 4.6.1 E: Channel 11: 2462MHz @ 802.11b)

4.6.2 802.11g Test Mode

A. Test Verdict

Channel	Frequency (MHz)	Refer to Plot	Limit (dBc)	Verdict
1	2412	Plot 4.6.2 A1	-20	PASS
		Plot 4.6.2 A2	-20	PASS
		Plot 4.6.2 A3	-20	PASS
6	2437	Plot 4.6.2 B1	-20	PASS
		Plot 4.6.2 B2	-20	PASS
		Plot 4.6.2 B3	-20	PASS
11	2462	Plot 4.6.2 C1	-20	PASS
		Plot 4.6.2 C2	-20	PASS
		Plot 4.6.2 C3	-20	PASS

Frequency (MHz)	Delta Peak to Band emission (dBc)	Detector	Limit (dBc)	Refer to Plot	Verdict
2400.00	-28.70	Peak	-20	Plot 4.6.2 D	PASS
2483.50	-34.04	Peak	-20	Plot 4.6.2 E	PASS

Note: 1. For 802.11g mode at final test to get the worst-case emission at 6Mbps.  
 2. The test results including the cable lose.

B. Test Plots



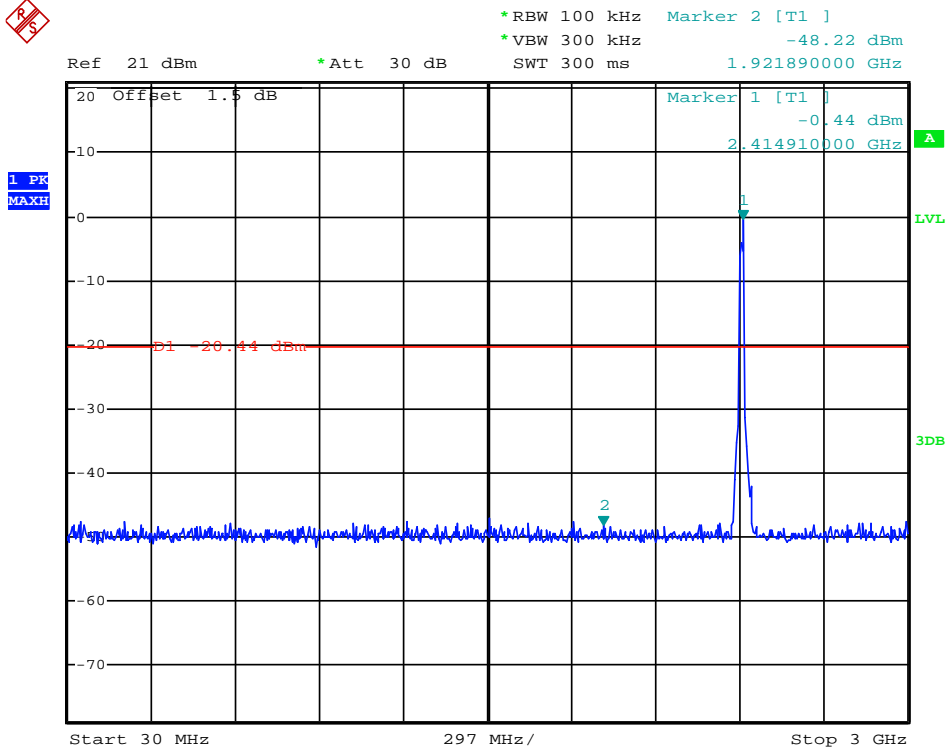

Date: 15.DEC.2013 13:50:12

(Plot 4.6.2 A1: Channel 1: 2412MHz @ 802.11g)

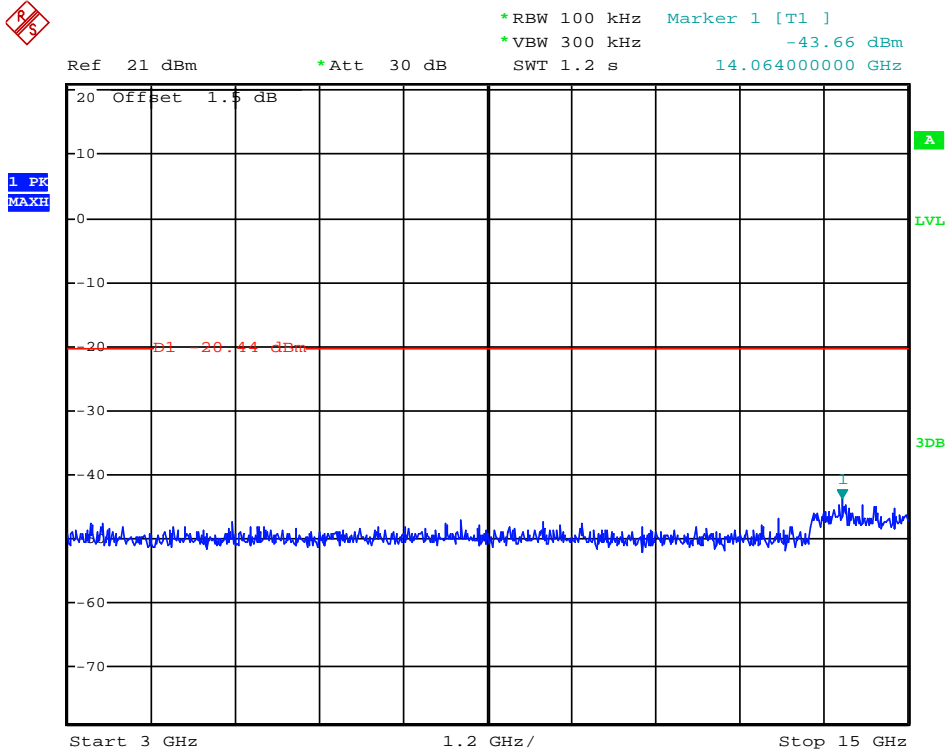

Date: 15.DEC.2013 13:50:27

(Plot 4.6.2 A2: Channel 1: 2412MHz @ 802.11g)



\*RBW 100 kHz Marker 1 [T1 ]  
\*VBW 300 kHz -42.66 dBm  
SWT 1 s 21.58000000 GHz

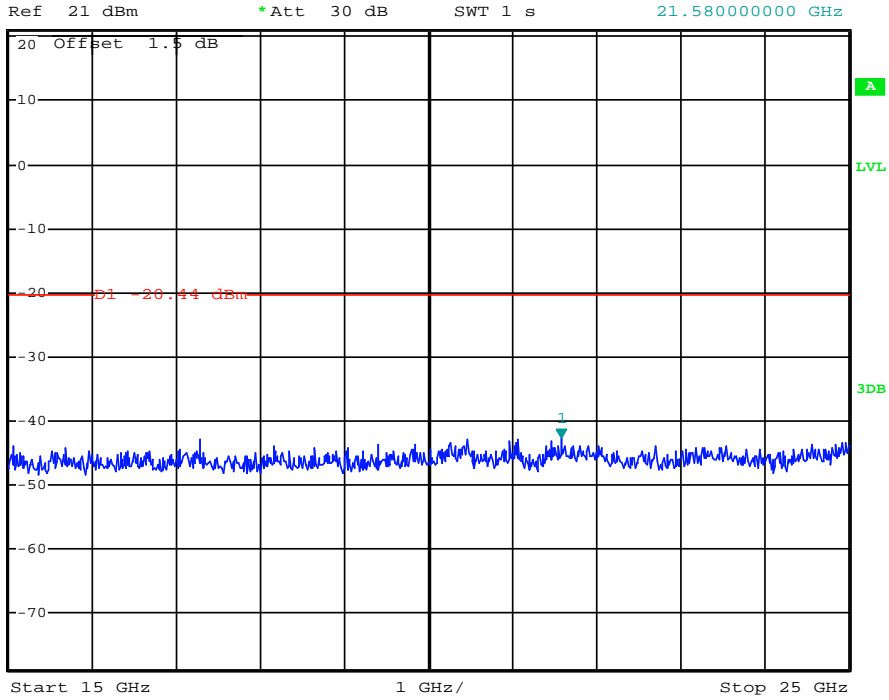

Date: 15.DEC.2013 13:50:37

(Plot 4.6.2 A3: Channel 1: 2412MHz @ 802.11g)



\*RBW 100 kHz Marker 1 [T1 ]  
\*VBW 300 kHz -1.76 dBm  
SWT 300 ms 2.432730000 GHz

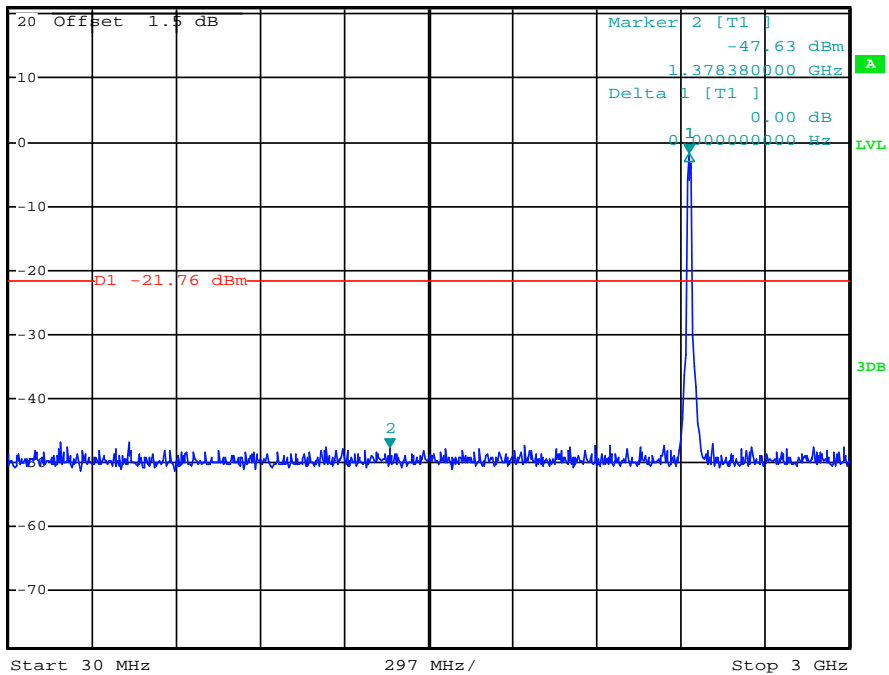

Date: 15.DEC.2013 13:51:25

(Plot 4.6.2 B1: Channel 6: 2437MHz @ 802.11g)

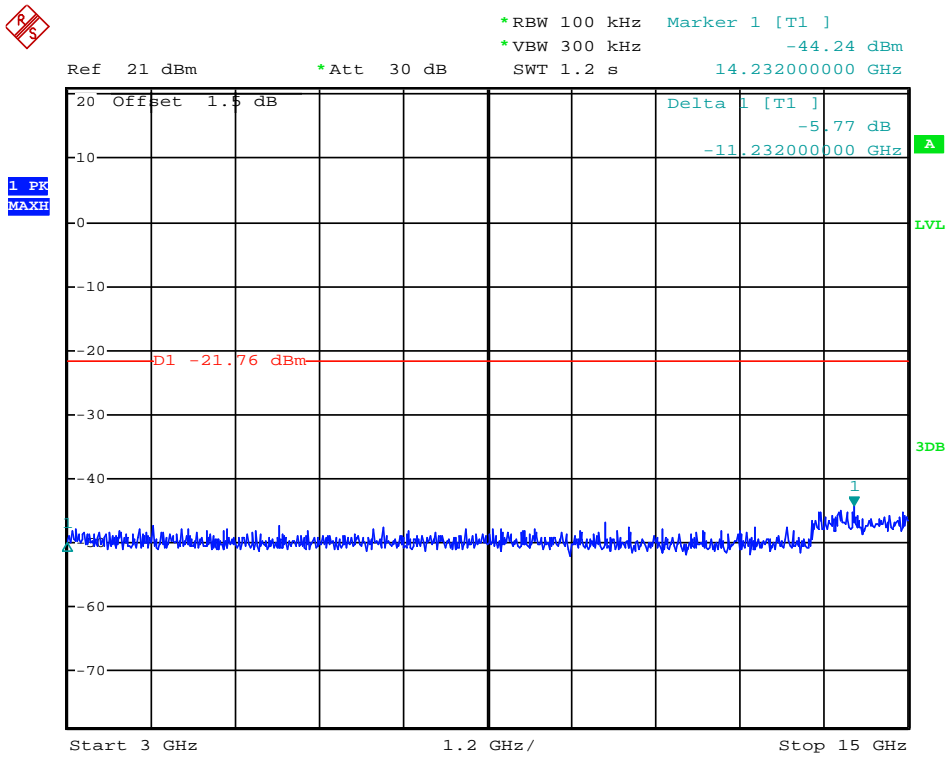

Date: 15.DEC.2013 13:51:41

(Plot 4.6.2 B2: Channel 6: 2437MHz @ 802.11g)

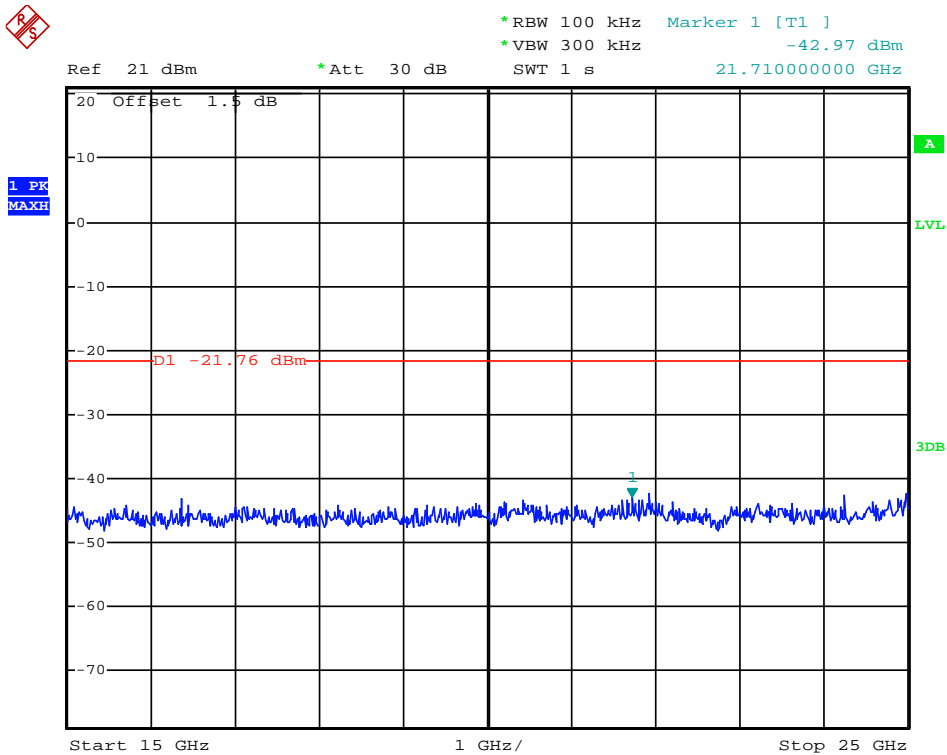

Date: 15.DEC.2013 13:52:02

(Plot 4.6.2 B3: Channel 6: 2437MHz @ 802.11g)

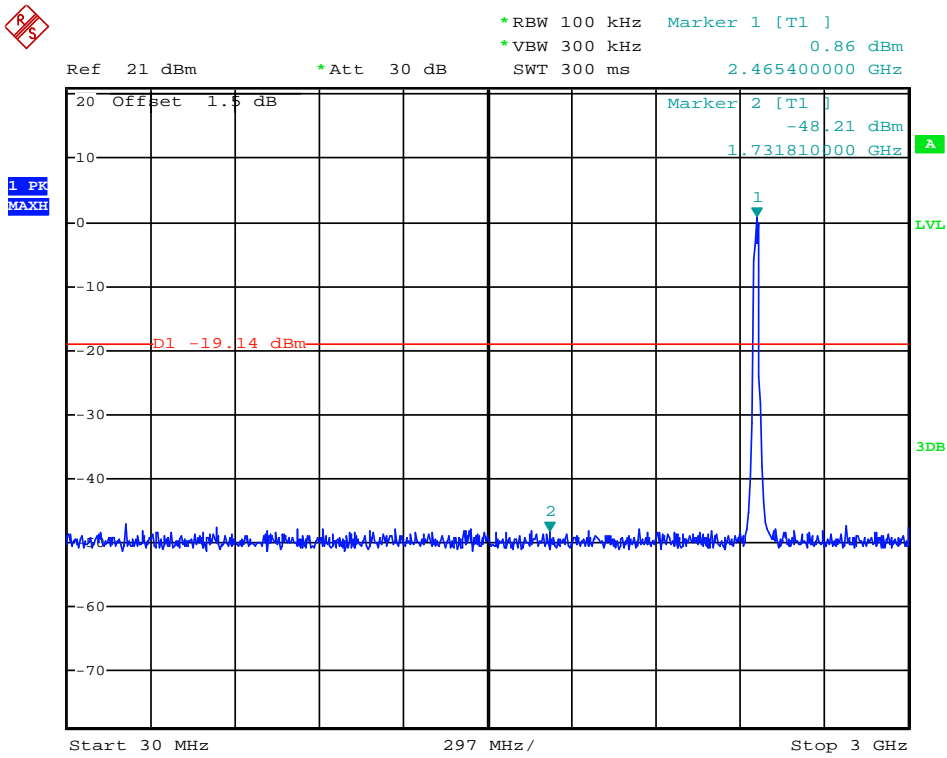

Date: 15.DEC.2013 13:52:37

(Plot 4.6.2 C1: Channel 11: 2462MHz @ 802.11g)

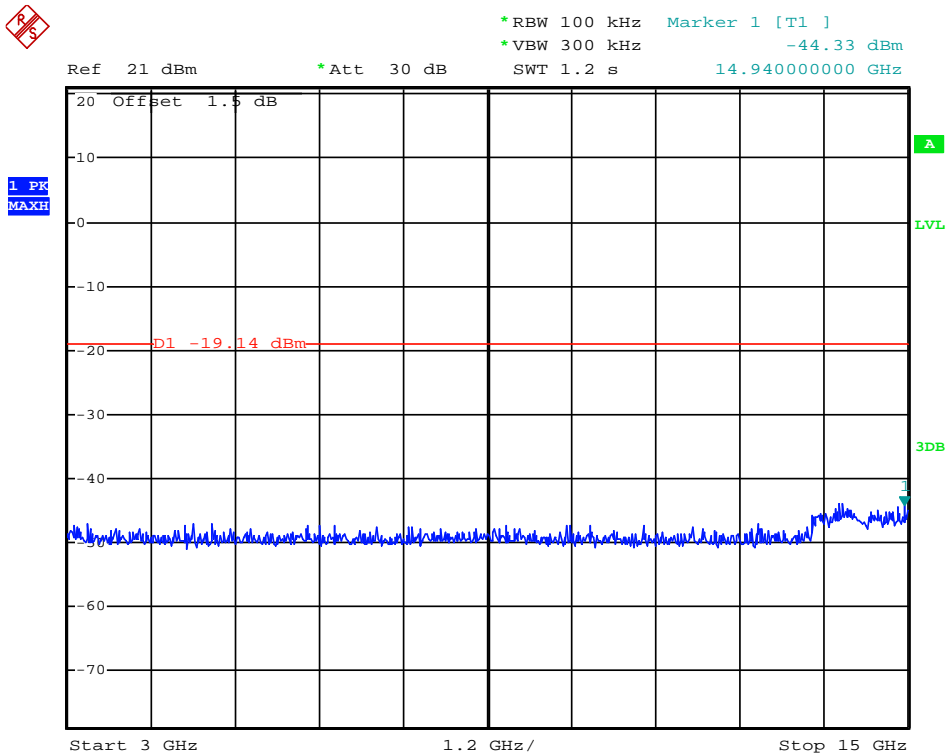

Date: 15.DEC.2013 13:53:10

(Plot 4.6.2 C2: Channel 11: 2462MHz @ 802.11g)

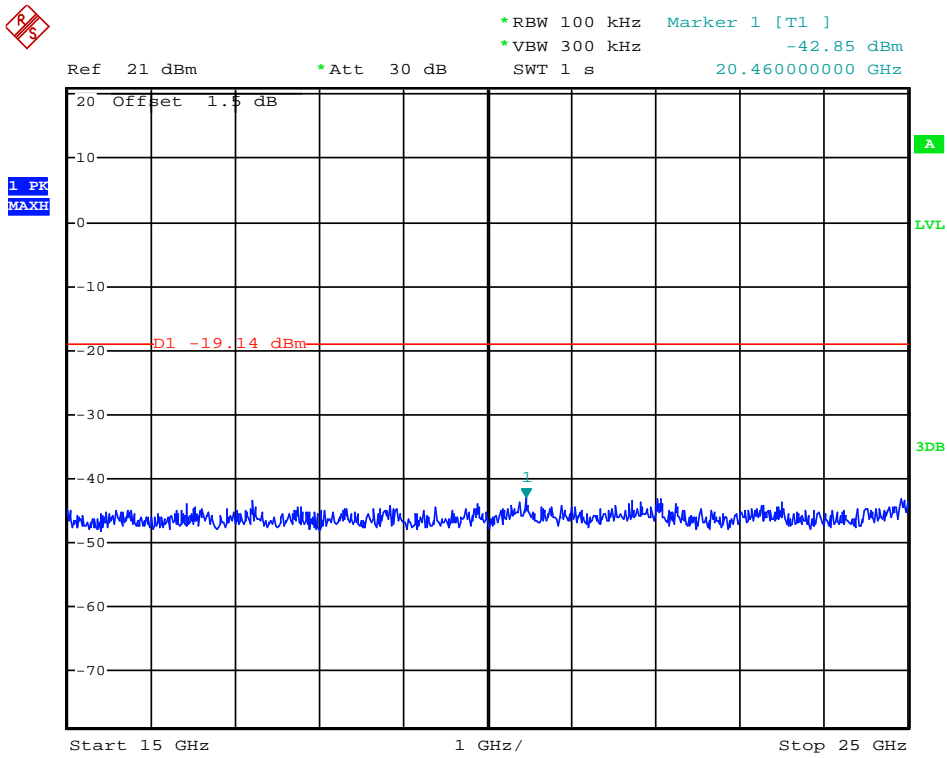

Date: 15.DEC.2013 13:53:21

(Plot 4.6.2 C3: Channel 11: 2462MHz @ 802.11g)

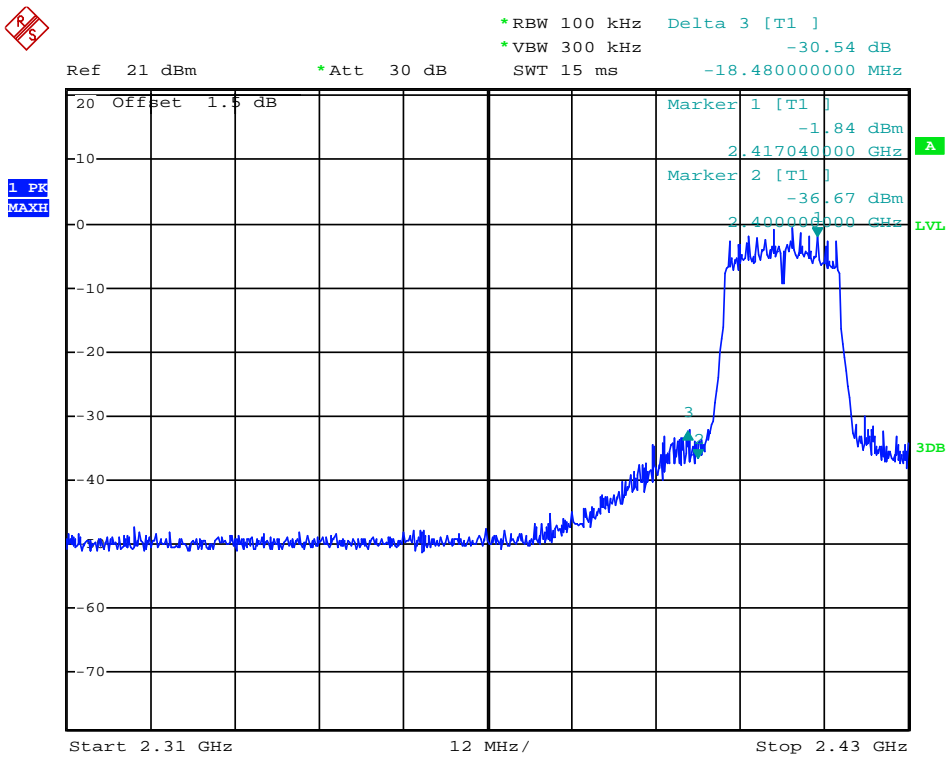

Date: 15.DEC.2013 13:23:43

(Plot 4.6.2 D: Channel 1: 2412MHz @ 802.11g)

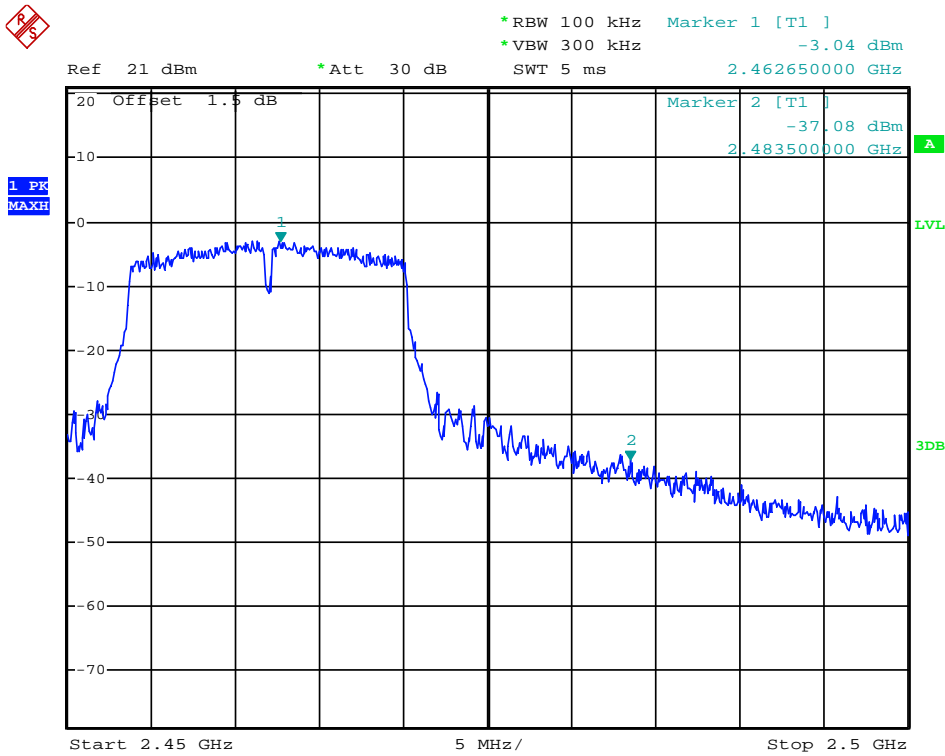

Date: 15.DEC.2013 13:27:59

(Plot 4.6.2 E: Channel 11: 2462MHz @ 802.11g)

4.6.3 802.11n(20MHz) Test Mode

A. Test Verdict

Channel	Frequency (MHz)	Refer to Plot	Limit (dBc)	Verdict
1	2412	Plot 4.6.3 A1	-20	PASS
		Plot 4.6.3 A2	-20	PASS
		Plot 4.6.3 A3	-20	PASS
6	2437	Plot 4.6.3 B1	-20	PASS
		Plot 4.6.3 B2	-20	PASS
		Plot 4.6.3 B3	-20	PASS
11	2462	Plot 4.6.3 C1	-20	PASS
		Plot 4.6.3 C2	-20	PASS
		Plot 4.6.3 C3	-20	PASS

Frequency (MHz)	Delta Peak to Band emission (dBc)	Detector	Limit (dBc)	Refer to Plot	Verdict
2400.00	-39.31	Peak	-20	Plot 4.6.3 D	PASS
2483.50	-38.30	Peak	-20	Plot 4.6.3 E	PASS

Note: 1. For 802.11n(20MHz) mode at final test to get the worst-case emission at 6.5Mbps.  
 2. The test results including the cable loss.

B. Test Plots

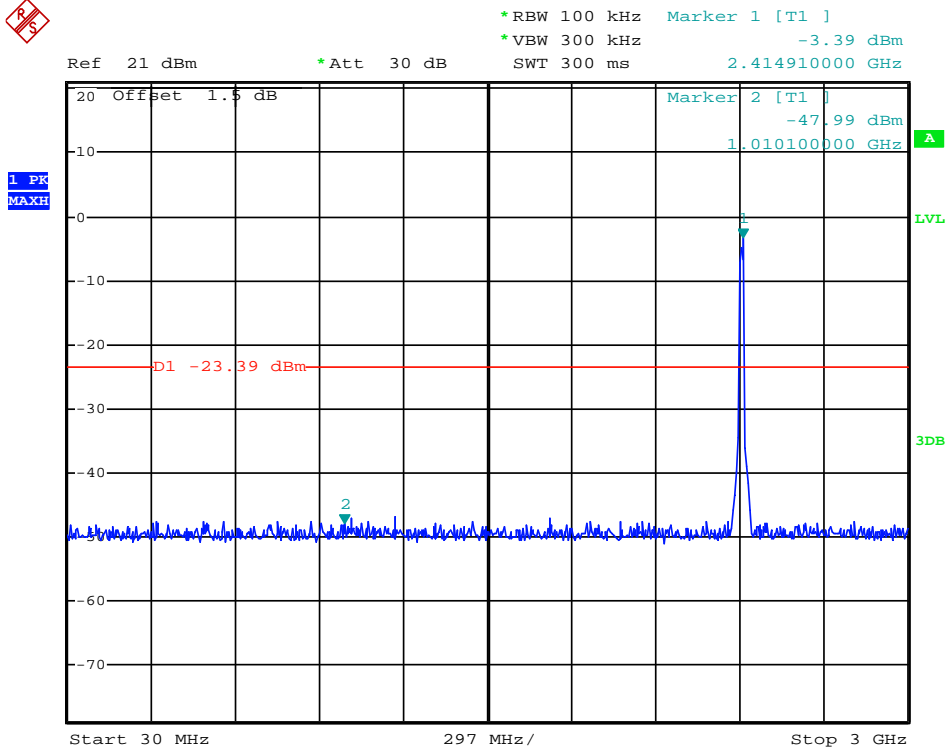

Date: 15.DEC.2013 13:54:22

(Plot 4.6.3 A1: Channel 1: 2412MHz @ 802.11n(20MHz))

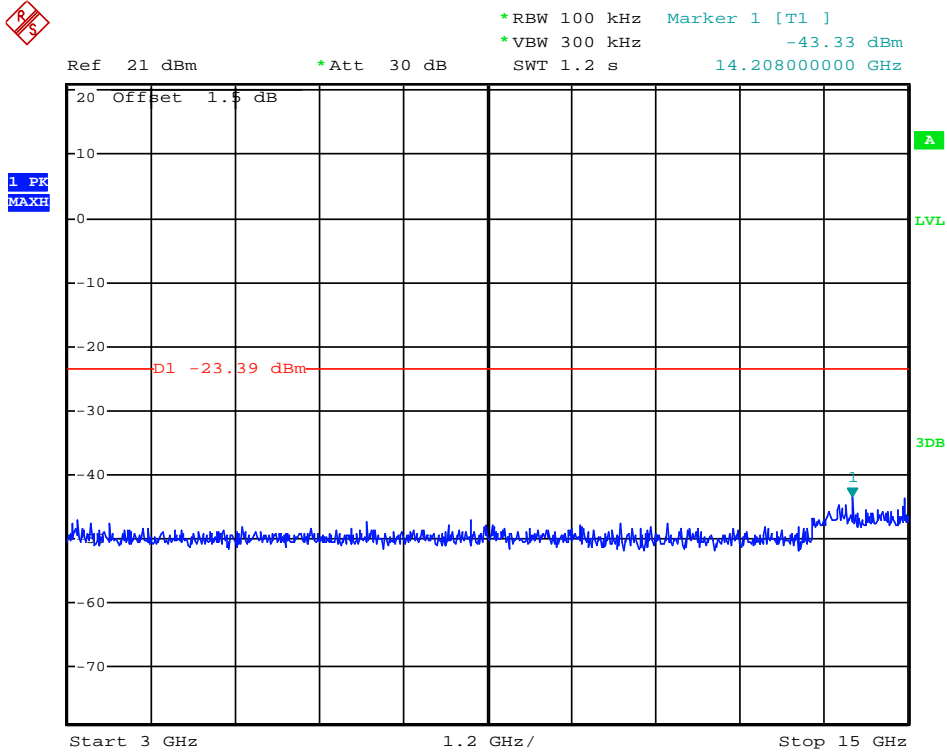

Date: 15.DEC.2013 13:54:37

(Plot 4.6.3 A2: Channel 1: 2412MHz @ 802.11n(20MHz))



\*RBW 100 kHz Marker 1 [T1 ]  
\*VBW 300 kHz -43.07 dBm  
SWT 1 s 22.29000000 GHz

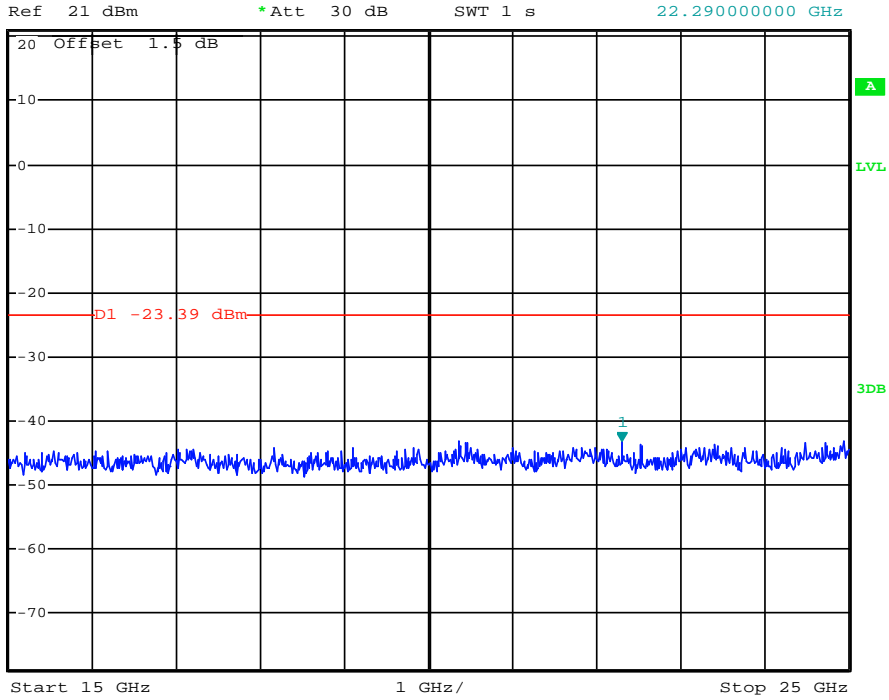

Date: 15.DEC.2013 13:54:49

(Plot 4.6.3 A3: Channel 1: 2412MHz @ 802.11n(20MHz))



\*RBW 100 kHz Marker 1 [T1 ]  
\*VBW 300 kHz -2.54 dBm  
SWT 300 ms 2.444610000 GHz

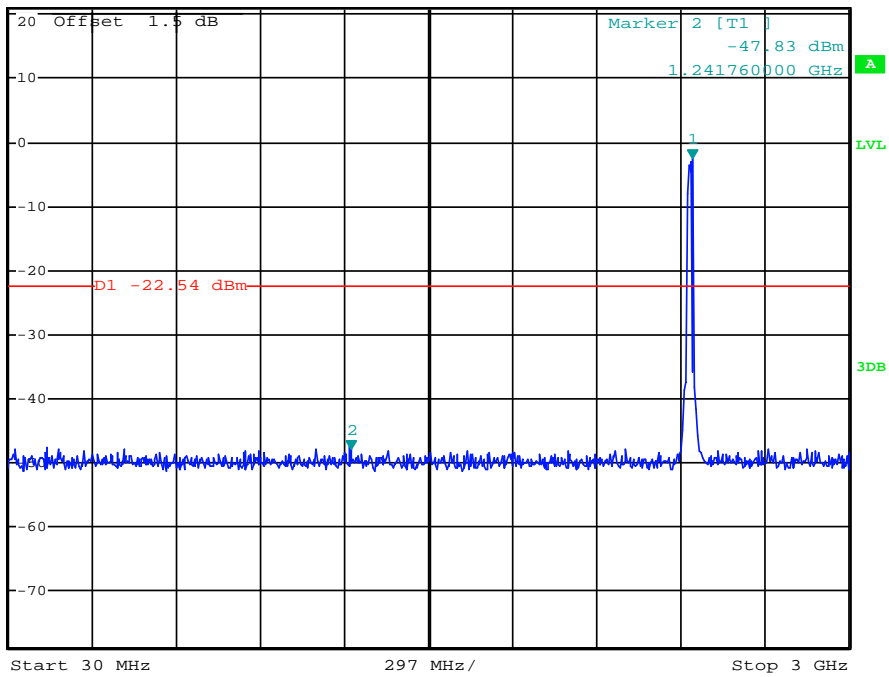

Date: 15.DEC.2013 13:55:33

(Plot 4.6.3 B1: Channel 6: 2437MHz @ 802.11n(20MHz))





\*RBW 100 kHz Marker 1 [T1 ]  
\*VBW 300 kHz -44.30 dBm  
SWT 1.2 s 13.968000000 GHz

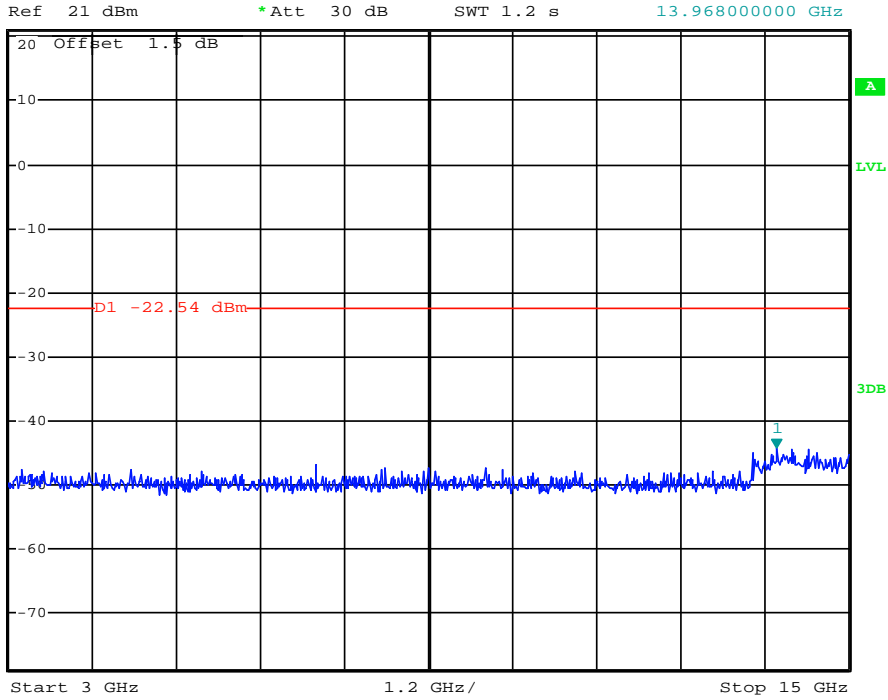

Date: 15.DEC.2013 13:55:52

(Plot 4.6.3 B2: Channel 6: 2437MHz @ 802.11n(20MHz))



\*RBW 100 kHz Marker 1 [T1 ]  
\*VBW 300 kHz -42.51 dBm  
SWT 1 s 20.380000000 GHz

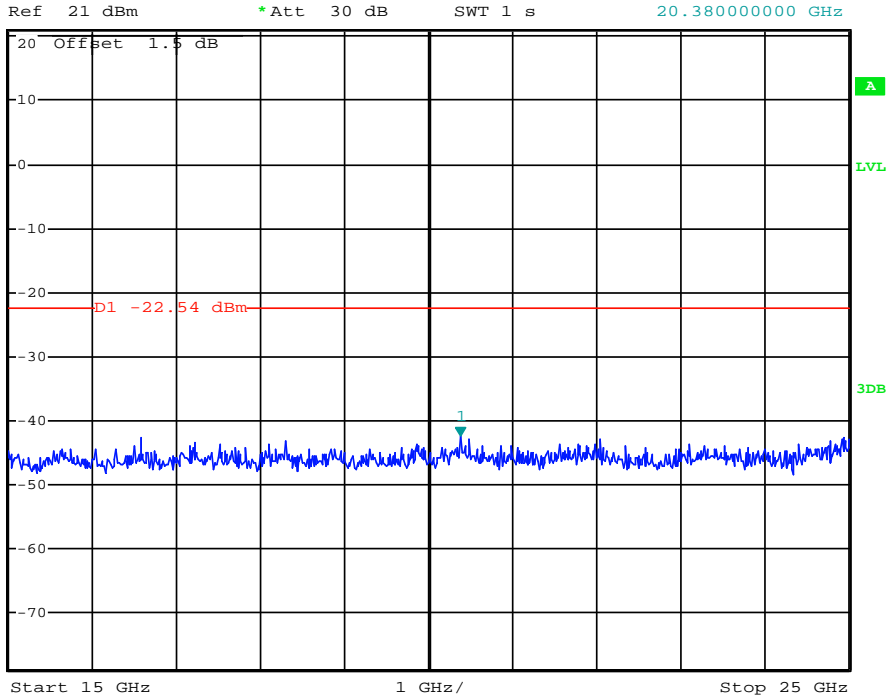

Date: 15.DEC.2013 13:56:03

(Plot 4.6.3 B3: Channel 6: 2437MHz @ 802.11n(20MHz))

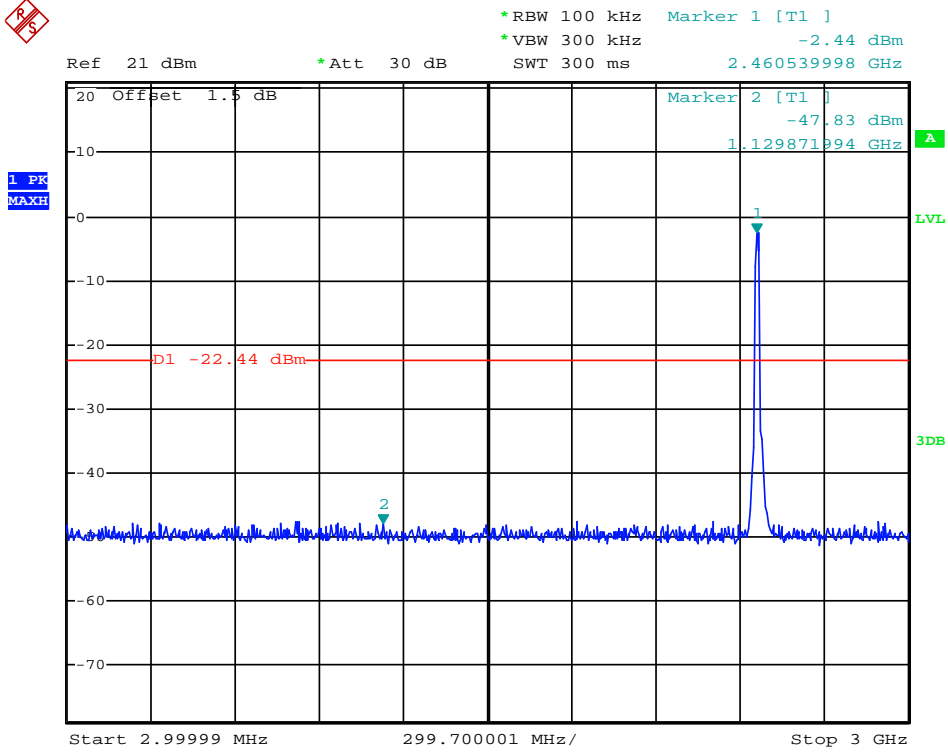

Date: 15.DEC.2013 13:56:44

(Plot 4.6.3 C1: Channel 11: 2462MHz @ 802.11n(20MHz))

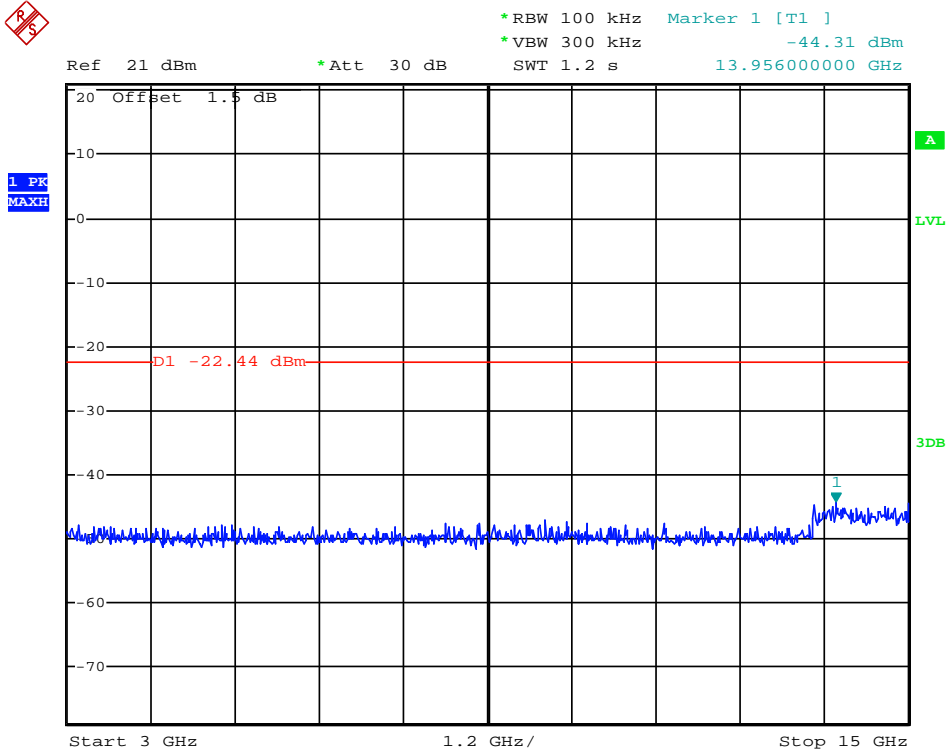

Date: 15.DEC.2013 13:56:58

(Plot 4.6.3 C2: Channel 11: 2462MHz @ 802.11n(20MHz))

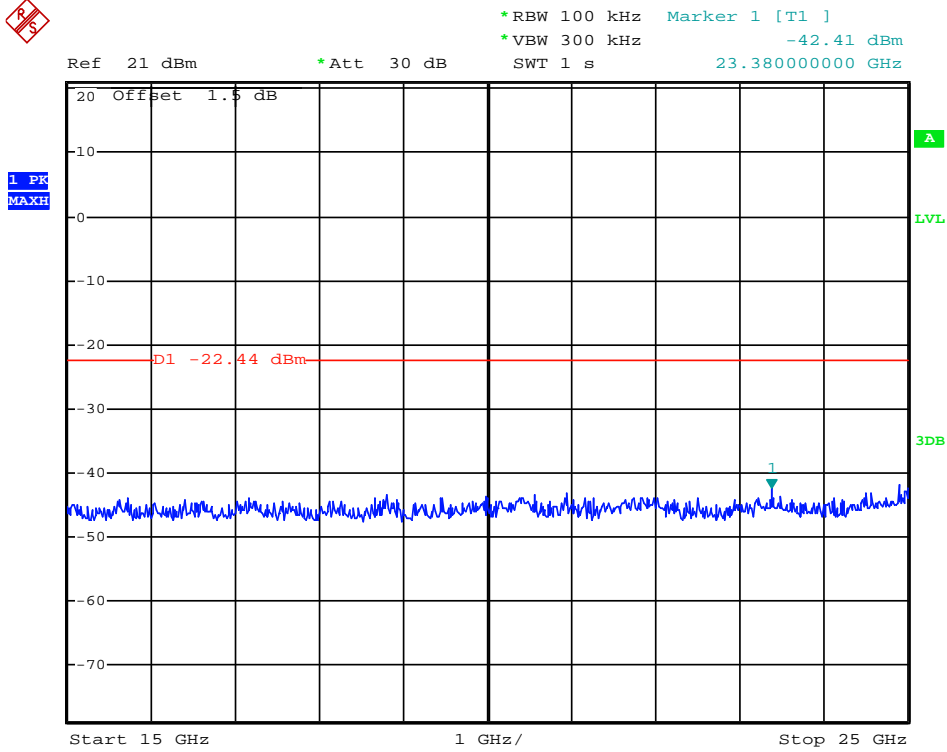

Date: 15.DEC.2013 13:57:12

(Plot 4.6.3 C3: Channel 11: 2462MHz @ 802.11n(20MHz))

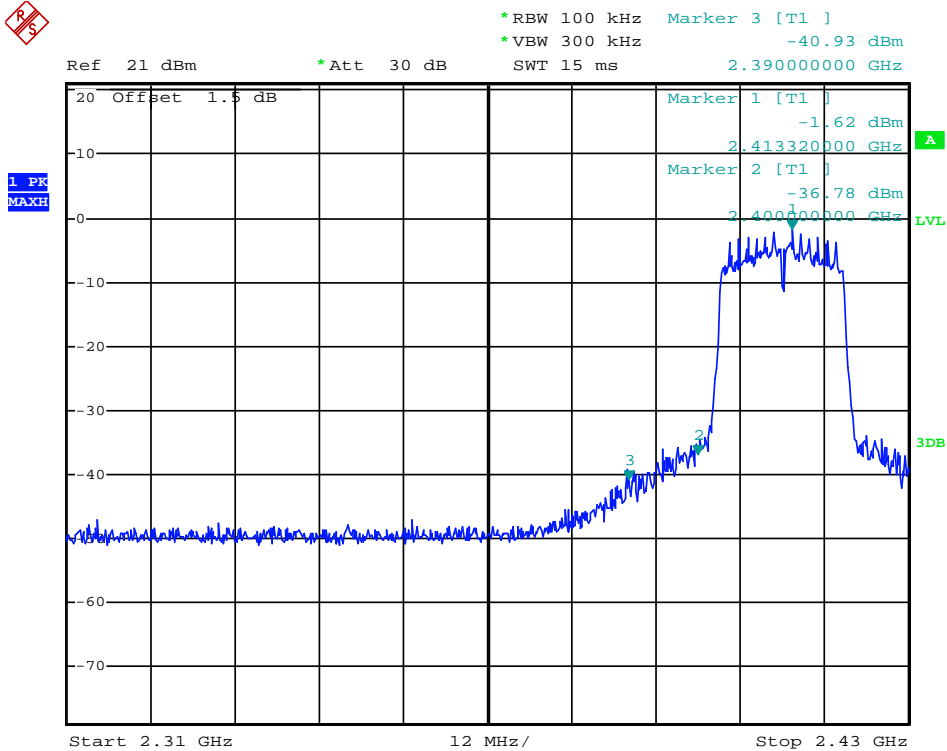

Date: 15.DEC.2013 13:24:35

(Plot 4.6.3 D: Channel 1: 2412MHz @ 802.11n(20MHz))

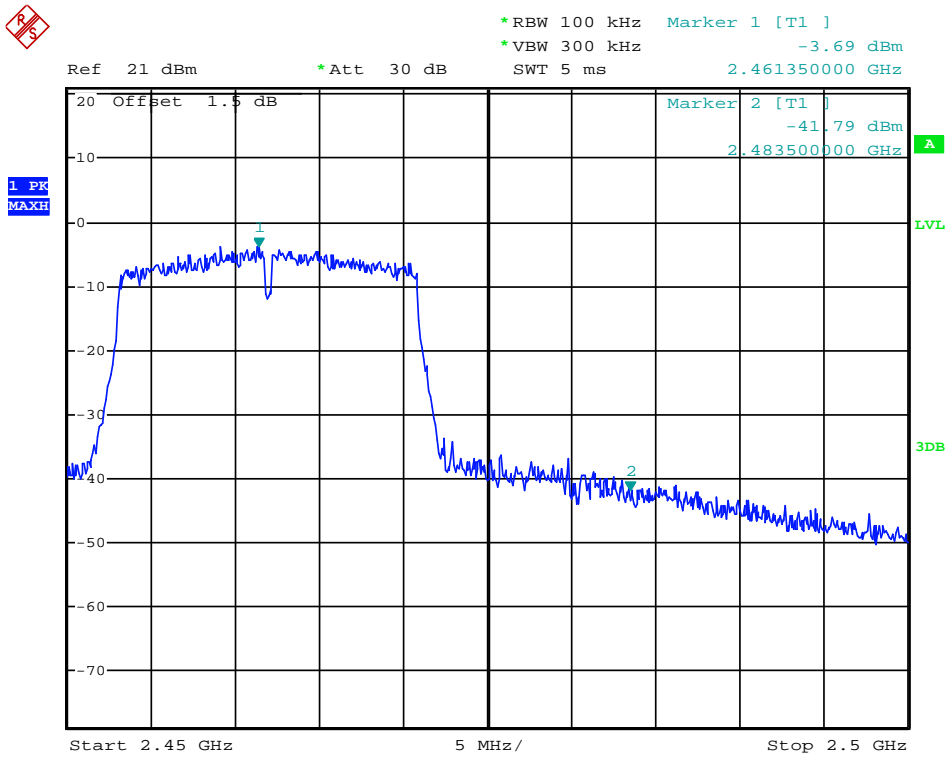

Date: 15.DEC.2013 13:28:56

(Plot 4.6.3 E: Channel 11: 2462MHz @ 802.11n(20MHz))

4.6.4 802.11n(40MHz) Test Mode

A. Test Verdict

Channel	Frequency (MHz)	Refer to Plot	Limit (dBc)	Verdict
3	2422	Plot 4.6.4 A1	-20	PASS
		Plot 4.6.4 A2	-20	PASS
		Plot 4.6.4 A3	-20	PASS
6	2437	Plot 4.6.4 B1	-20	PASS
		Plot 4.6.4 B2	-20	PASS
		Plot 4.6.4 B3	-20	PASS
9	2452	Plot 4.6.4 C1	-20	PASS
		Plot 4.6.4 C2	-20	PASS
		Plot 4.6.4 C3	-20	PASS

Frequency (MHz)	Delta Peak to Band emission (dBc)	Detector	Limit (dBc)	Refer to Plot	Verdict
2400.00	-35.39	Peak	-20	Plot 4.6.3 D	PASS
2483.50	-36.14	Peak	-20	Plot 4.6.3 E	PASS

Note: 1. For 802.11n(40MHz) mode at final test to get the worst-case emission at 13.5Mbps.  
 2. The test results including the cable lose.

B. Test Plots

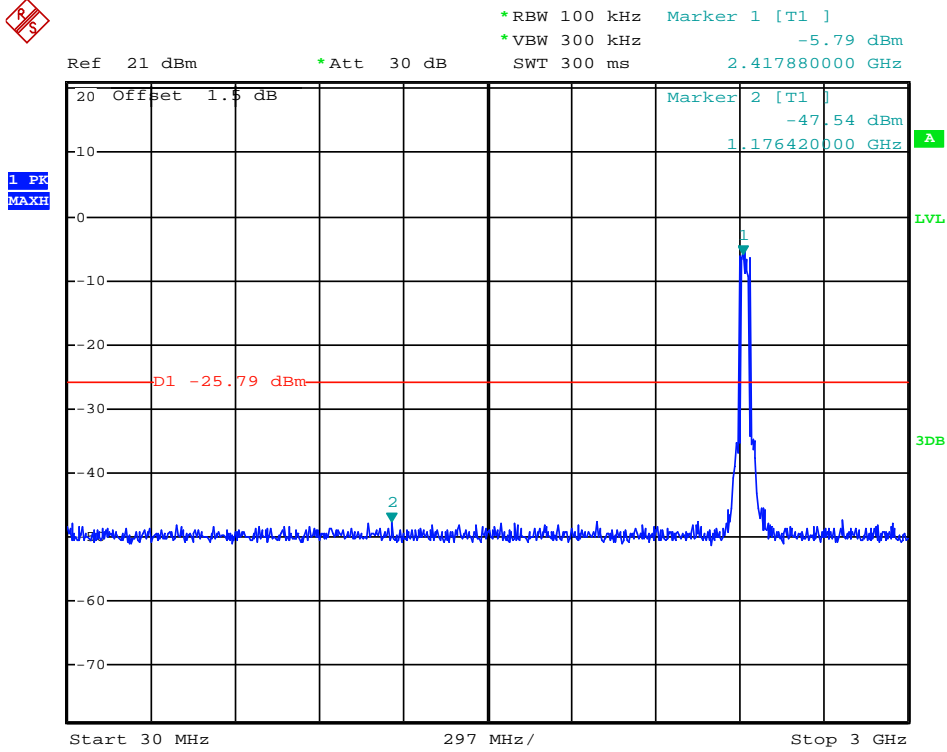

Date: 15.DEC.2013 13:57:52

(Plot 4.6.4 A1: Channel 3: 2422MHz @ 802.11n(40MHz))

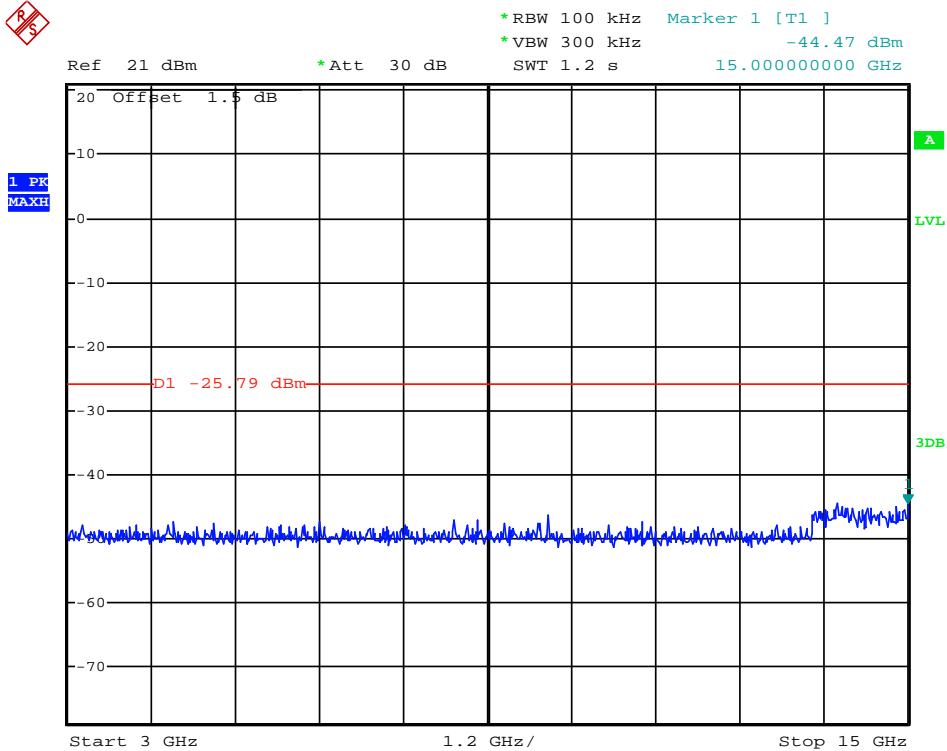

Date: 15.DEC.2013 13:58:09

(Plot 4.6.4 A2: Channel 3: 2422MHz @ 802.11n(40MHz))



\*RBW 100 kHz Marker 1 [T1 ]  
\*VBW 300 kHz -42.91 dBm  
SWT 1 s 21.56000000 GHz

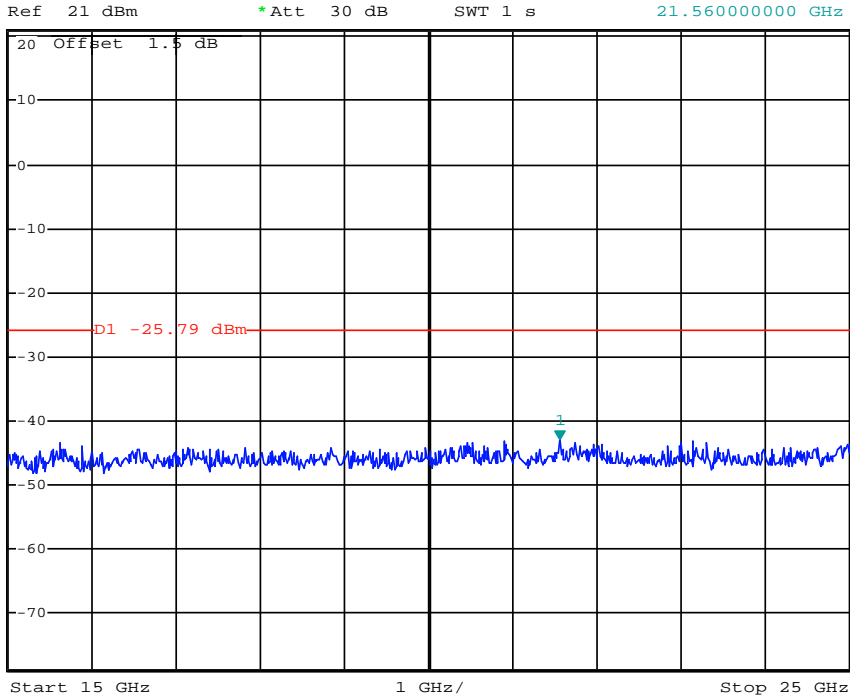

Date: 15.DEC.2013 13:58:22

(Plot 4.6.4 A3: Channel 3: 2422MHz @ 802.11n(40MHz))



\*RBW 100 kHz Marker 1 [T1 ]  
\*VBW 300 kHz -5.30 dBm  
SWT 300 ms 2.45055000 GHz

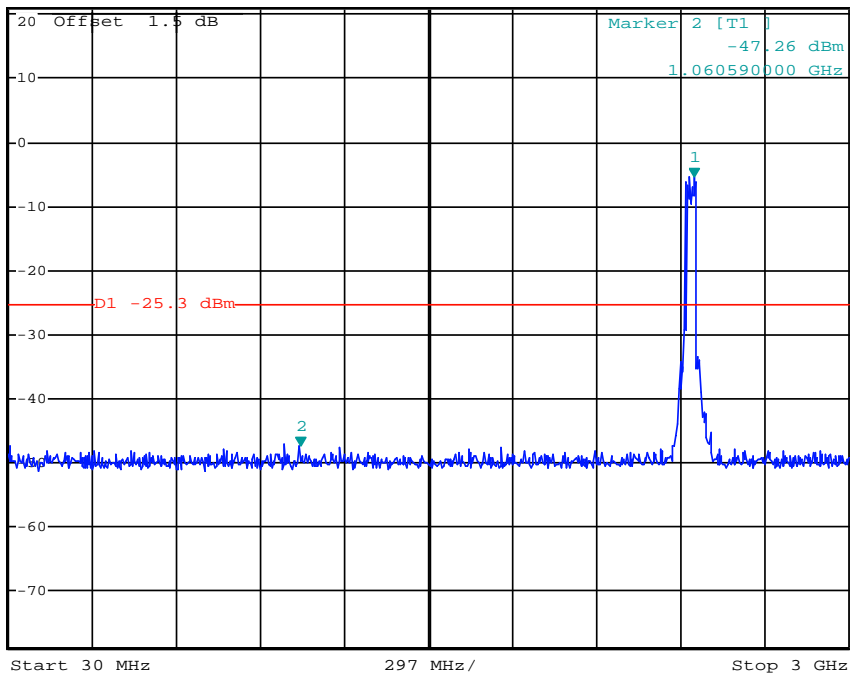

Date: 15.DEC.2013 13:59:05

(Plot 4.6.4 B1: Channel 6: 2437MHz @ 802.11n(40MHz))



\*RBW 100 kHz Marker 1 [T1 ]  
\*VBW 300 kHz -44.35 dBm  
SWT 1.2 s 14.148000000 GHz

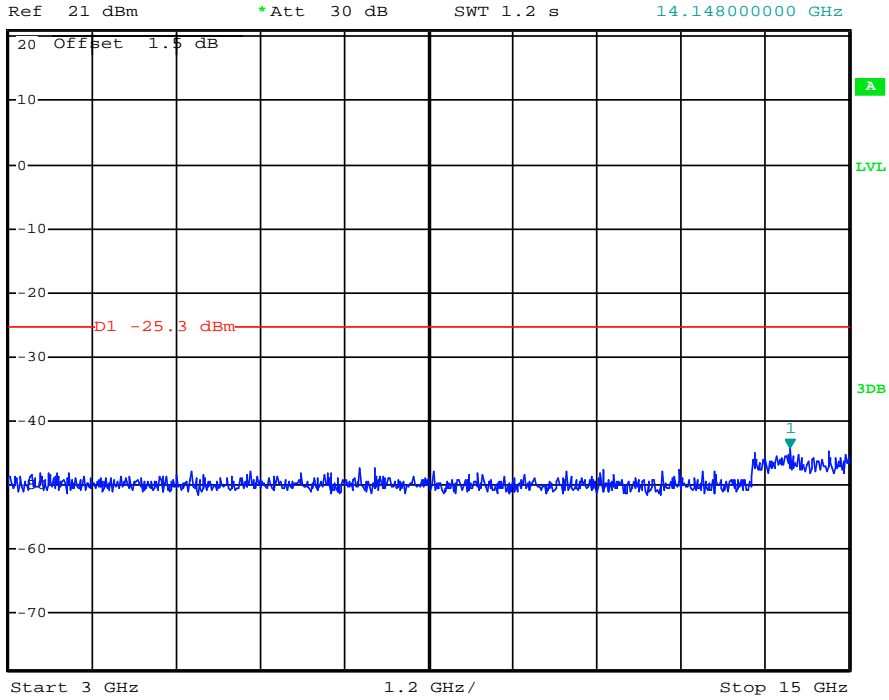

Date: 15.DEC.2013 13:59:18

(Plot 4.6.4 B2: Channel 6: 2437MHz @ 802.11n(40MHz))



\*RBW 100 kHz Marker 1 [T1 ]  
\*VBW 300 kHz -42.79 dBm  
SWT 1 s 19.730000000 GHz

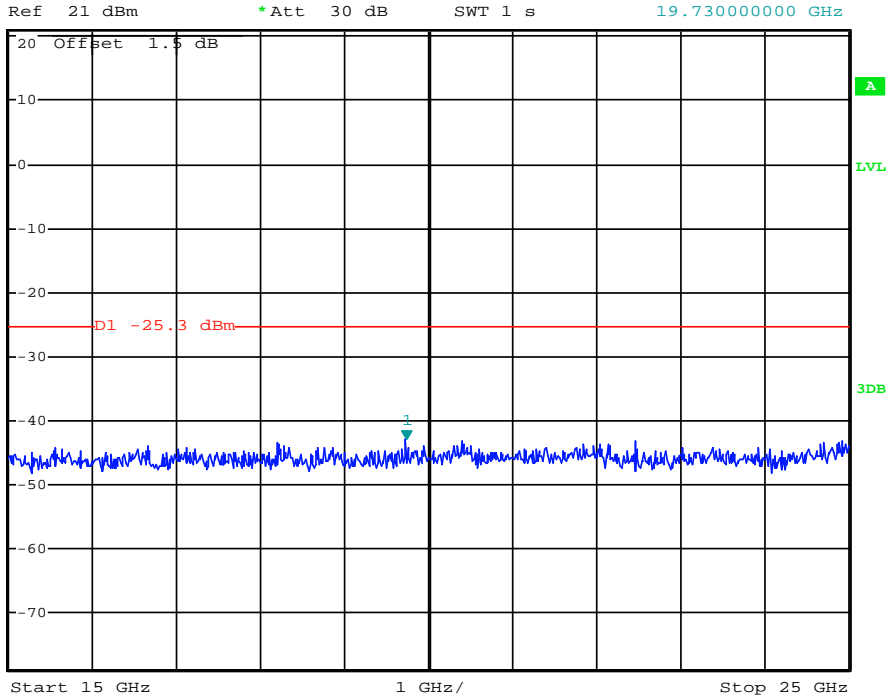

Date: 15.DEC.2013 13:59:28

(Plot 4.6.4 B3: Channel 6: 2437MHz @ 802.11n(40MHz))

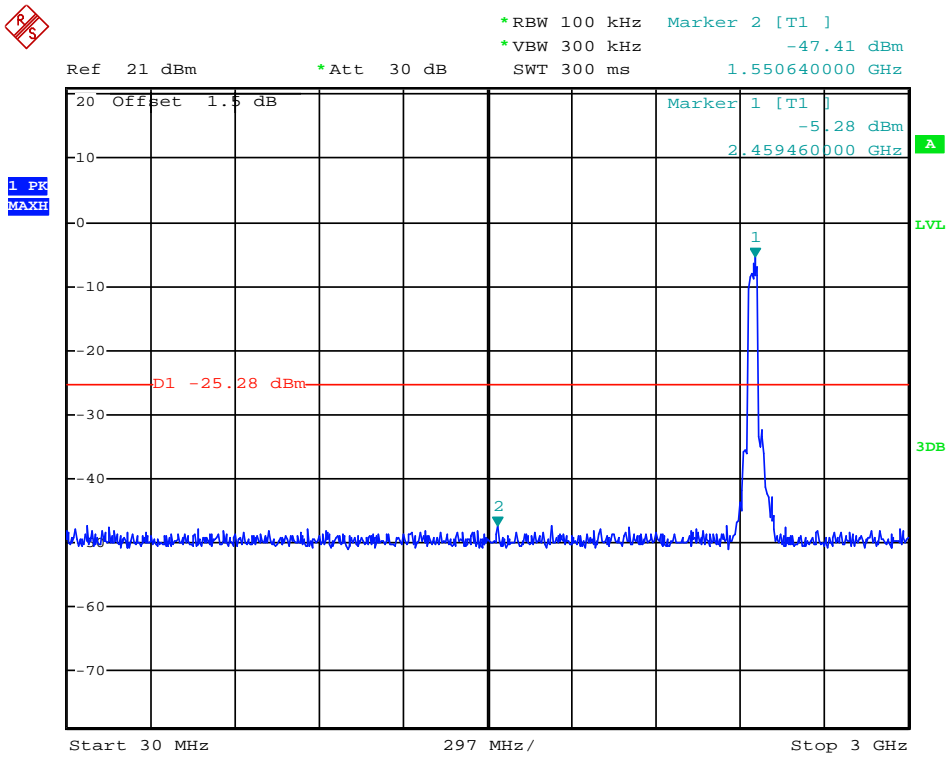

Date: 15.DEC.2013 14:00:14

(Plot 4.6.4 C1: Channel 9: 2452MHz @ 802.11n(40MHz))

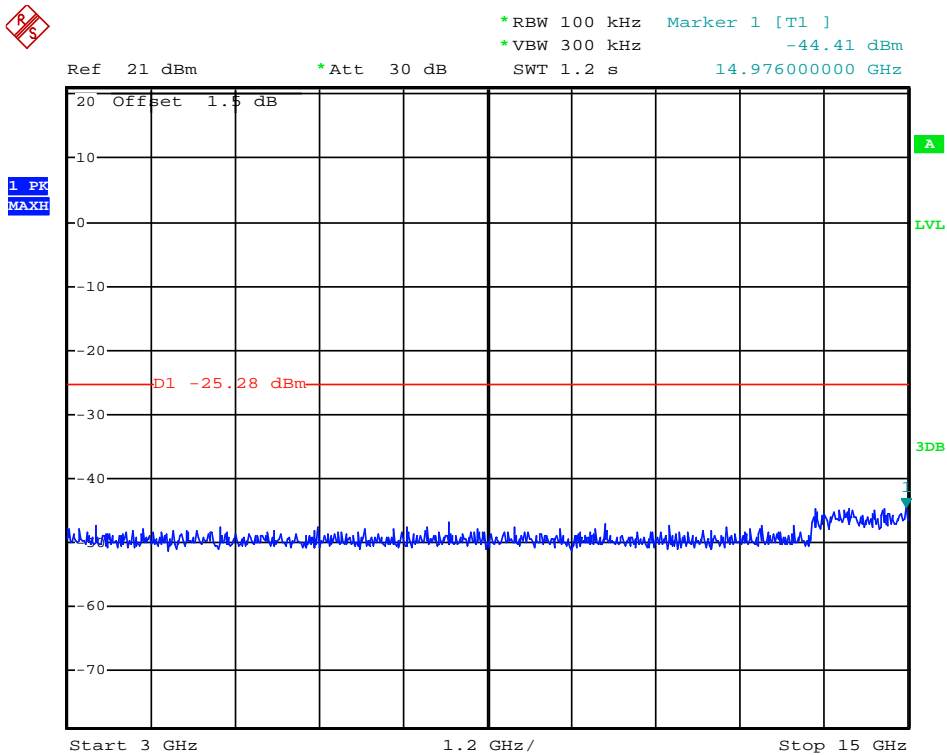

Date: 15.DEC.2013 14:00:30

(Plot 4.6.4 C2: Channel 9: 2452MHz @ 802.11n(40MHz))



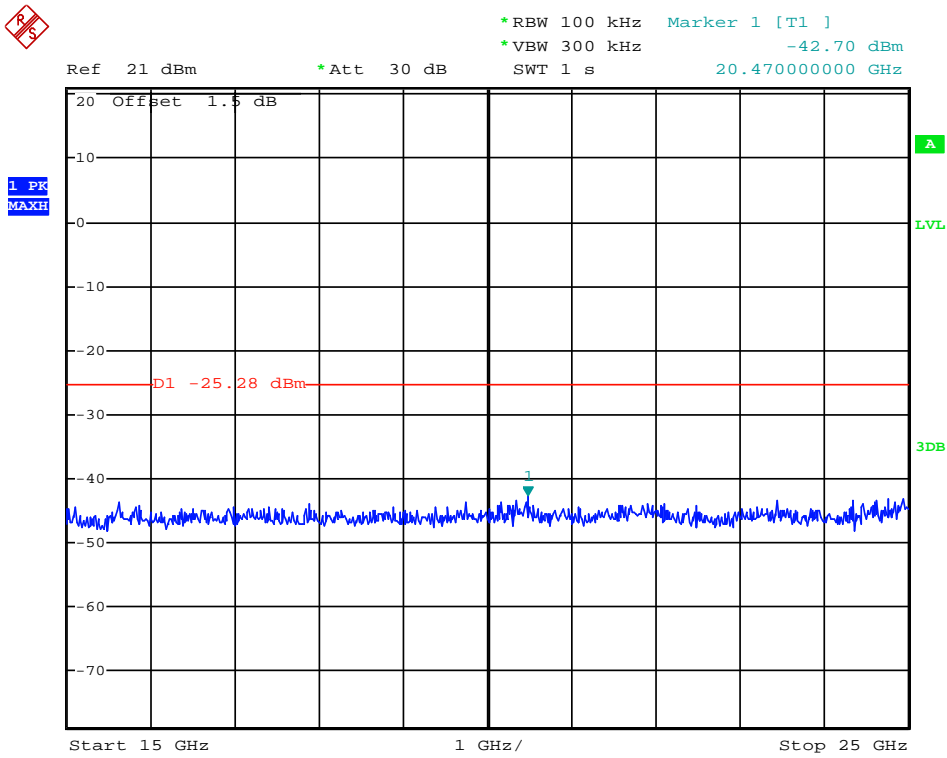

Date: 15.DEC.2013 14:00:40

(Plot 4.6.4 C3: Channel 9: 2452MHz @ 802.11n(40MHz))

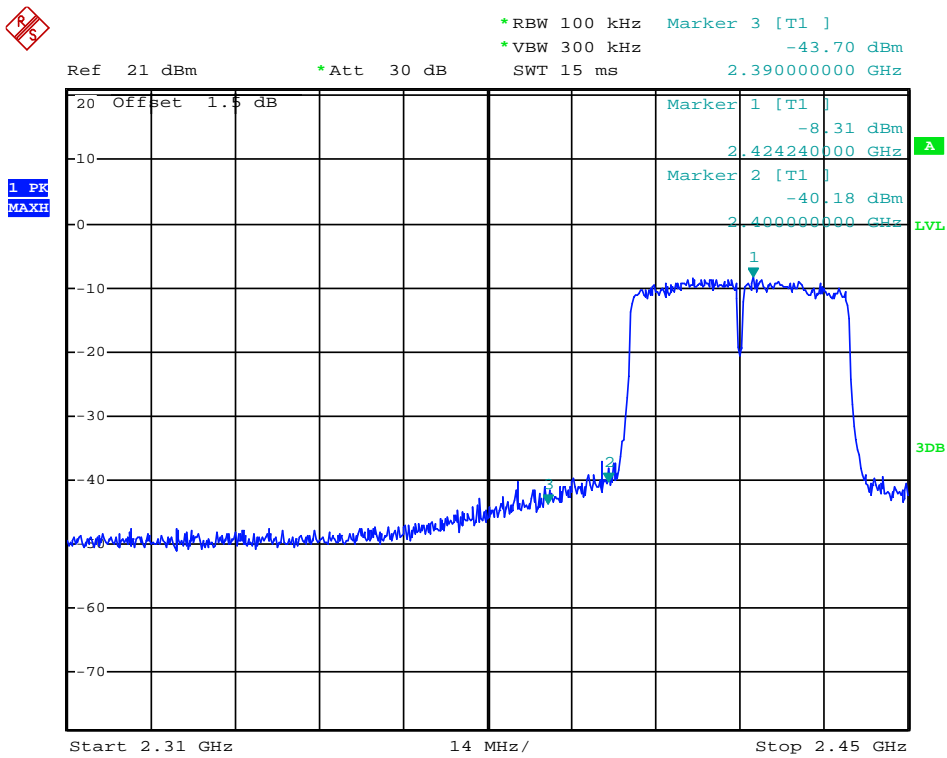

Date: 15.DEC.2013 13:33:47

(Plot 4.6.4 D: Channel 3: 2422MHz @ 802.11n(40MHz))

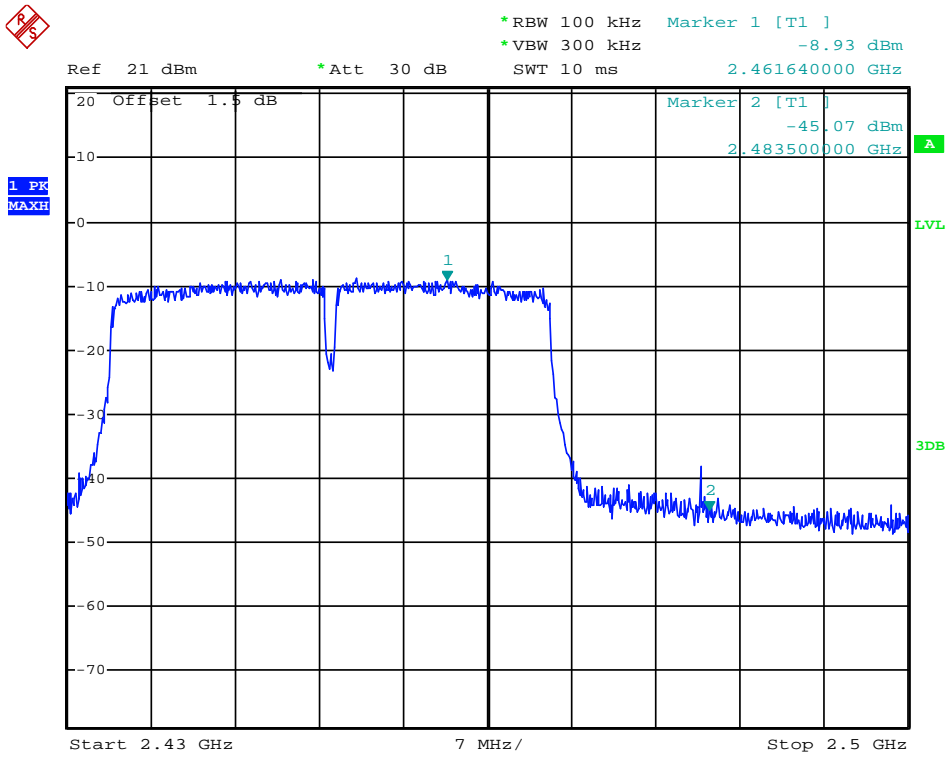

Date: 15.DEC.2013 13:32:39

(Plot 4.6.4 E: Channel 9: 2452MHz @ 802.11n(40MHz))

## 4.7. 6dB Bandwidth

### TEST CONFIGURATION

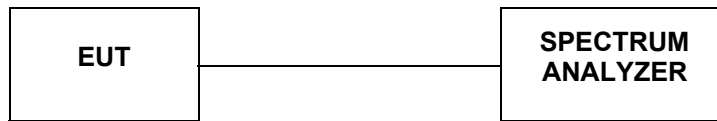

### TEST PROCEDURE

The transmitter output was connected to the spectrum analyzer through an attenuator. The bandwidth of the fundamental frequency was measured by spectrum analyzer with 100 KHz RBW and 300KHz VBW. The 6dB bandwidth is defined as the total spectrum the power of which is higher than peak power minus 6dB. According to KDB558074 D01 V03 for one of the following procedures may be used to determine the modulated DTS device signal bandwidth.

1. Set RBW = 100 kHz.
2. Set the video bandwidth (VBW)  $\geq 3$  RBW.
3. Detector = Peak.
4. Trace mode = max hold.
5. Sweep = auto couple.
6. Allow the trace to stabilize.
7. Measure the maximum width of the emission that is constrained by the frequencies associated with the two outermost amplitude points (upper and lower frequencies) that are attenuated by 6 dB relative to the maximum level measured in the fundamental emission.

### LIMIT

For digital modulation systems, the minimum 6 dB bandwidth shall be at least 500 kHz.

### TEST RESULTS

#### 4.7.1 801.11b Test Mode

##### A. Test Verdict

Channel	Frequency (MHz)	6 dB Bandwidth (MHz)	Refer to Plot	Limits (kHz)	Verdict
1	2412	10.00	Plot 4.7.1 A	$\geq 500$	PASS
6	2437	10.00	Plot 4.7.1 B	$\geq 500$	PASS
11	2462	10.00	Plot 4.7.1 C	$\geq 500$	PASS

Note: 1. For 802.11b mode at final test to get the worst-case emission at 1Mbps.  
2. The test results including the cable loss.

##### B. Test Plots

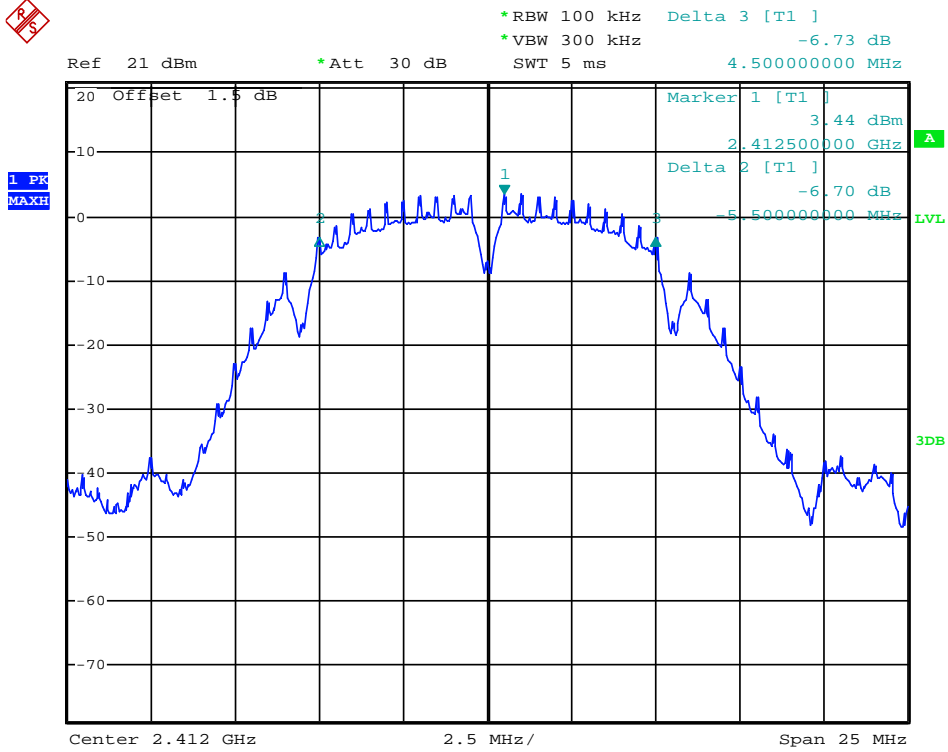

Date: 15.DEC.2013 10:54:13

(Plot 4.7.1 A: Channel 1: 2412MHz @ 802.11b)

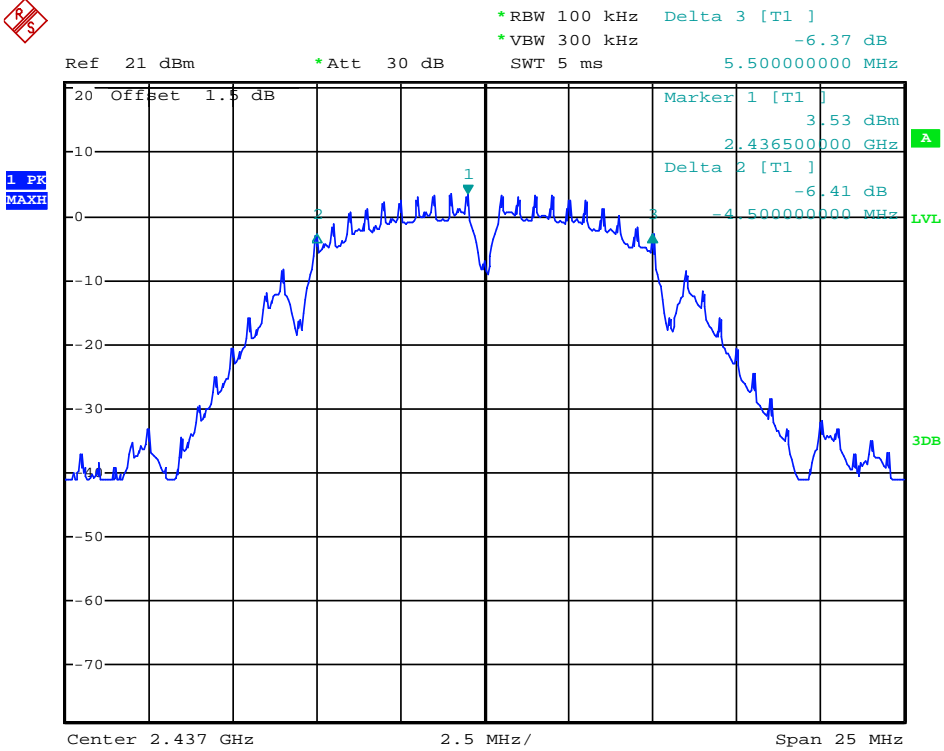

Date: 15.DEC.2013 10:55:38

(Plot 4.7.1 B: Channel 6: 2437MHz @ 802.11b)

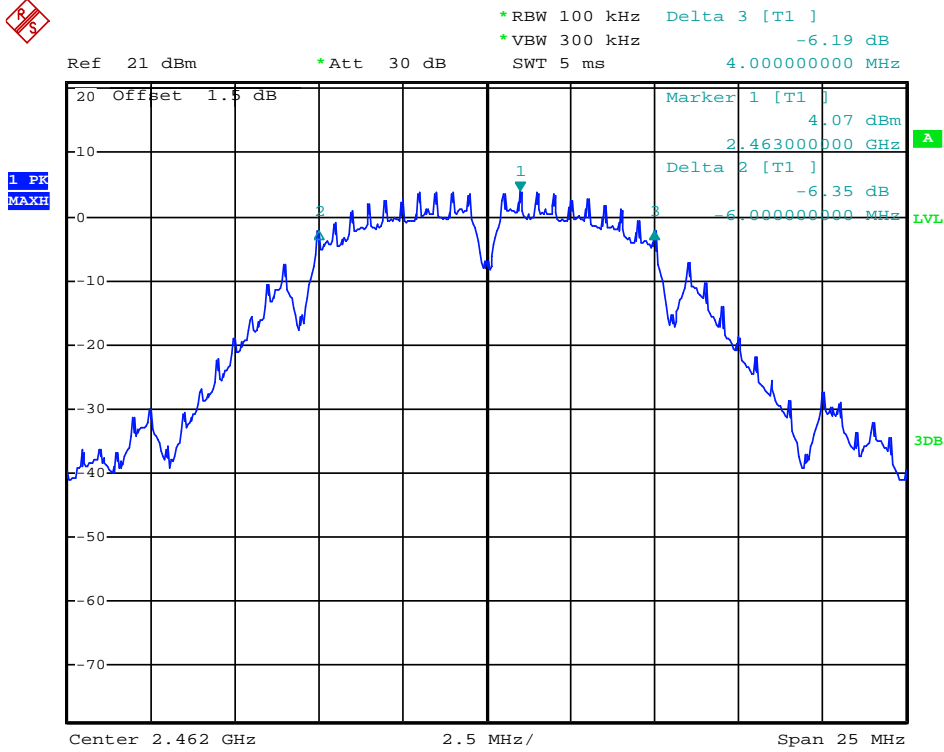

Date: 15.DEC.2013 10:56:29

(Plot 4.7.1 C: Channel 11: 2462MHz @ 802.11b)

4.7.2 801.11g Test Mode

A. Test Verdict

Channel	Frequency (MHz)	6 dB Bandwidth (MHz)	Refer to Plot	Limits (kHz)	Verdict
1	2412	15.84	Plot 4.7.2 A	≥500	PASS
6	2437	15.84	Plot 4.7.2 B	≥500	PASS
11	2462	15.84	Plot 4.7.2 C	≥500	PASS

Note: 1. For 802.11g mode at final test to get the worst-case emission at 6Mbps.  
 2. The test results including the cable lose.

B. Test Plots

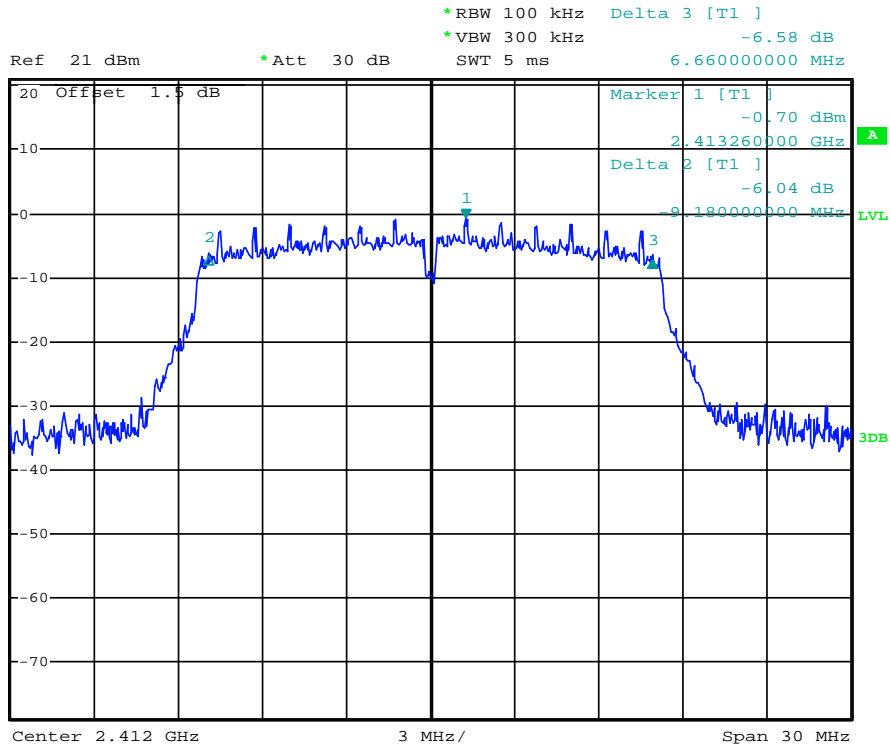

Date: 15.DEC.2013 11:24:03

(Plot 4.7.2 A: Channel 1: 2412MHz @ 802.11g)

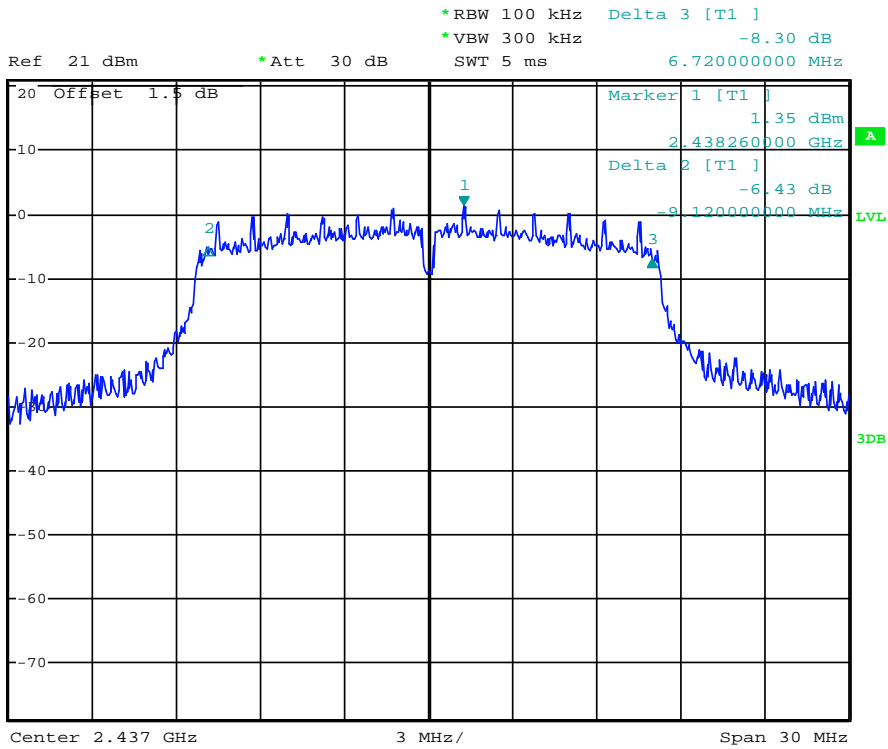

Date: 15.DEC.2013 11:25:17

(Plot 4.7.2 B: Channel 6: 2437MHz @ 802.11g)

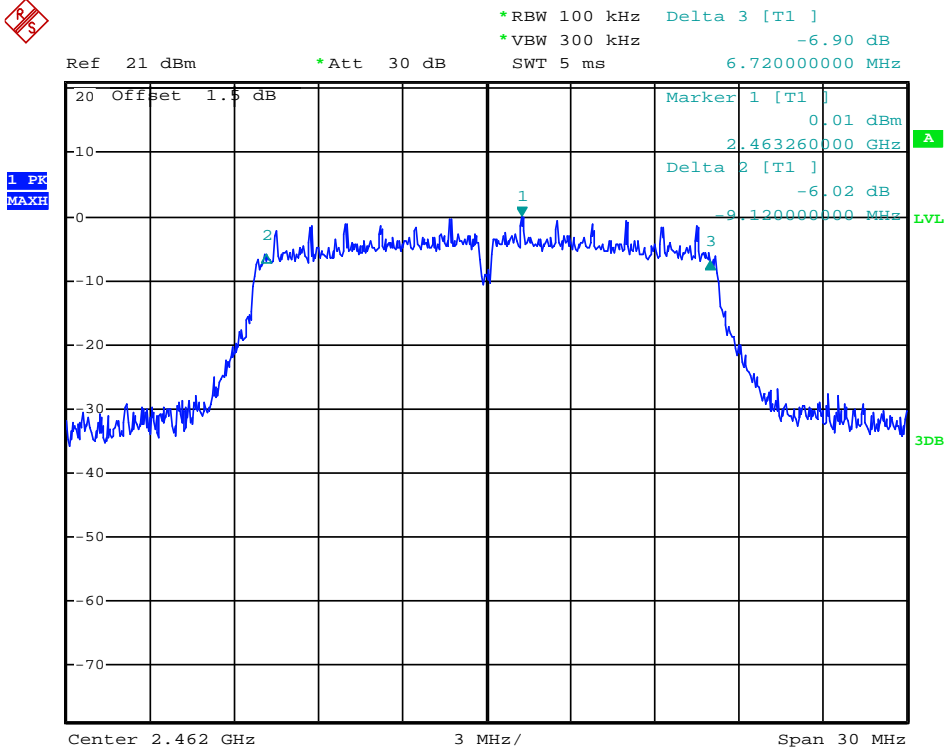

Date: 15.DEC.2013 11:26:17

(Plot 4.7.2 C: Channel 11: 2462MHz @ 802.11g)

**4.7.3 801.11n(20MHz) Test Mode**

A. Test Verdict

Channel	Frequency (MHz)	6 dB Bandwidth (MHz)	Refer to Plot	Limits (kHz)	Verdict
1	2412	17.52	Plot 4.7.3 A	≥500	PASS
6	2437	17.52	Plot 4.7.3 B	≥500	PASS
11	2462	17.52	Plot 4.7.3 C	≥500	PASS

Note: 1. For 802.11n(20MHz) mode at final test to get the worst-case emission at 6.5Mbps.  
 2. The test results including the cable lose.

B. Test Plots

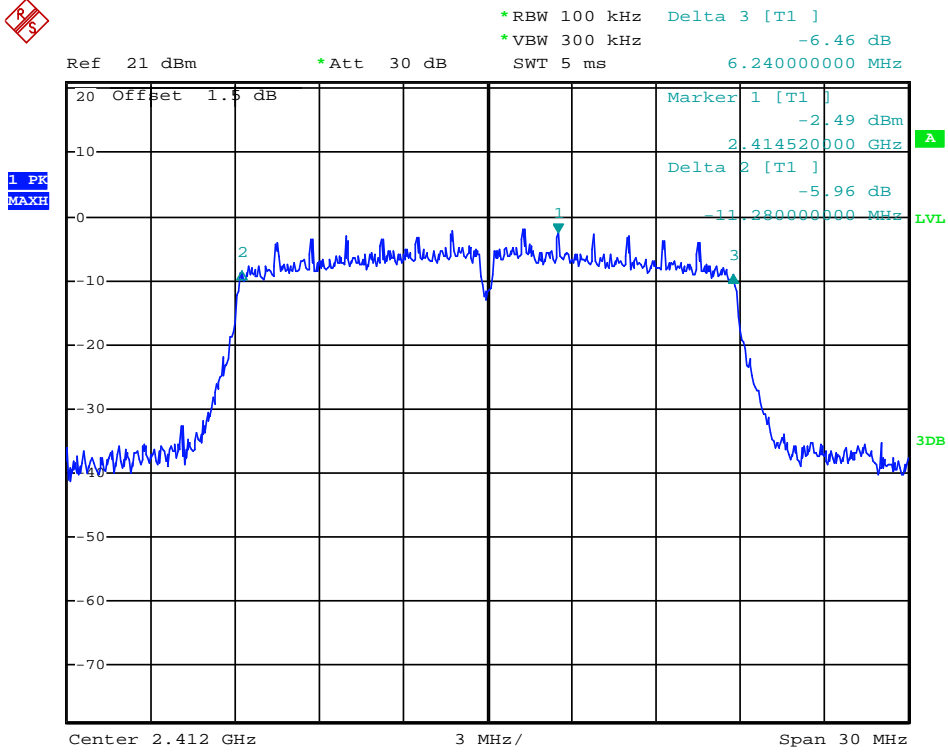

Date: 15.DEC.2013 11:27:39

(Plot 4.7.3 A: Channel 1: 2412MHz @ 802.11n(20MHz))

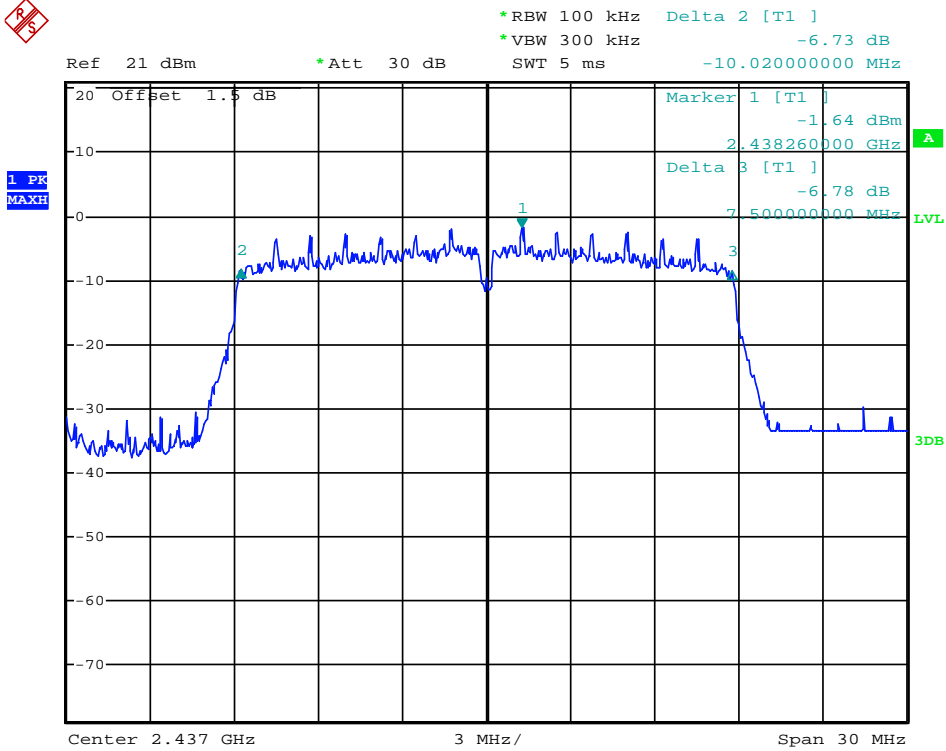

Date: 15.DEC.2013 11:29:13

(Plot 4.7.3 B: Channel 6: 2437MHz @ 802.11n(20MHz))



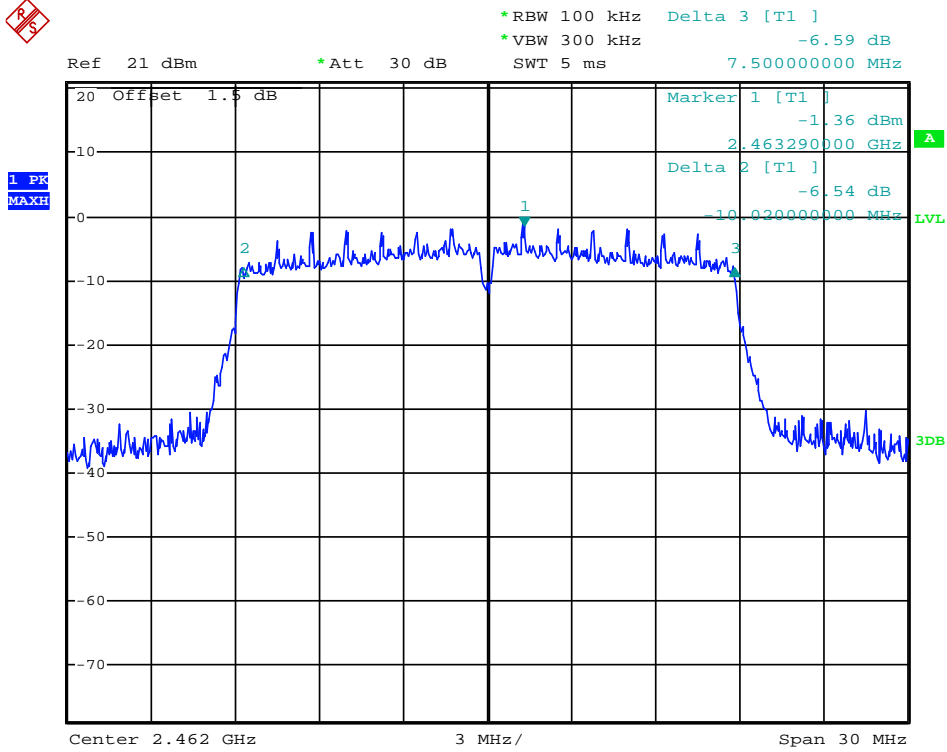

Date: 15.DEC.2013 11:29:52

(Plot 4.7.3 C: Channel 11: 2462MHz @ 802.11n(20MHz))

**4.7.4 801.11n(40MHz) Test Mode**

**A. Test Verdict**

Channel	Frequency (MHz)	6 dB Bandwidth (MHz)	Refer to Plot	Limits (kHz)	Verdict
3	2422	35.55	Plot 4.7.4 A	≥500	PASS
6	2437	35.50	Plot 4.7.4 B	≥500	PASS
9	2452	35.55	Plot 4.7.4 C	≥500	PASS

Note: 1. For 802.11n(40MHz) mode at final test to get the worst-case emission at 13.5Mbps.  
 2.The test results including the cable lose.

**B. Test Plots**

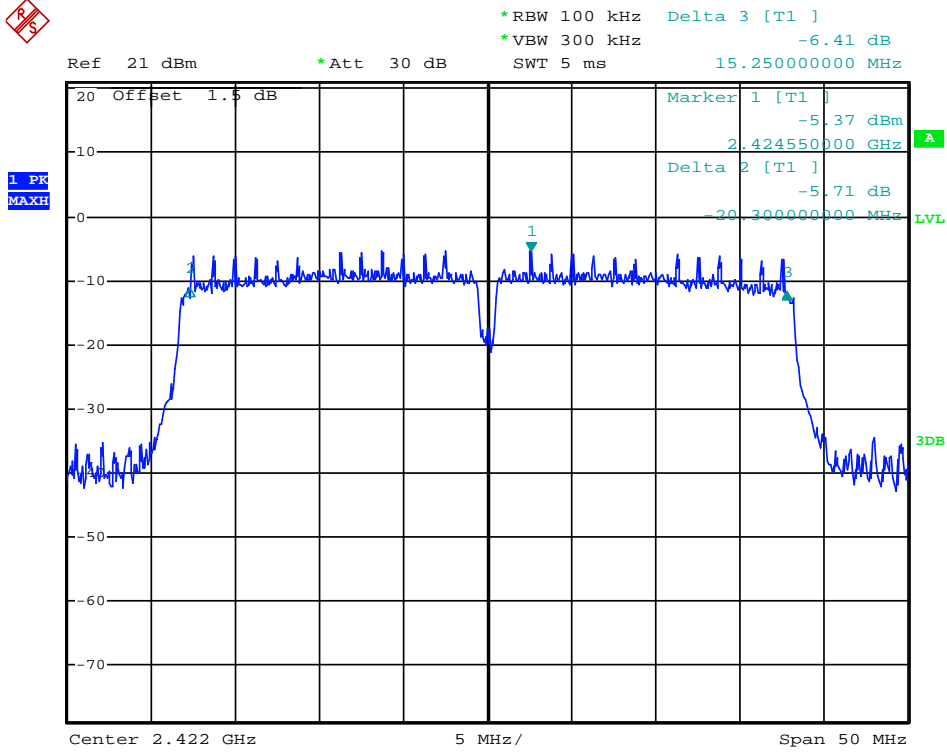

Date: 15.DEC.2013 11:31:04

(Plot 4.7.4 A: Channel 3: 2422MHz @ 802.11n(40MHz))

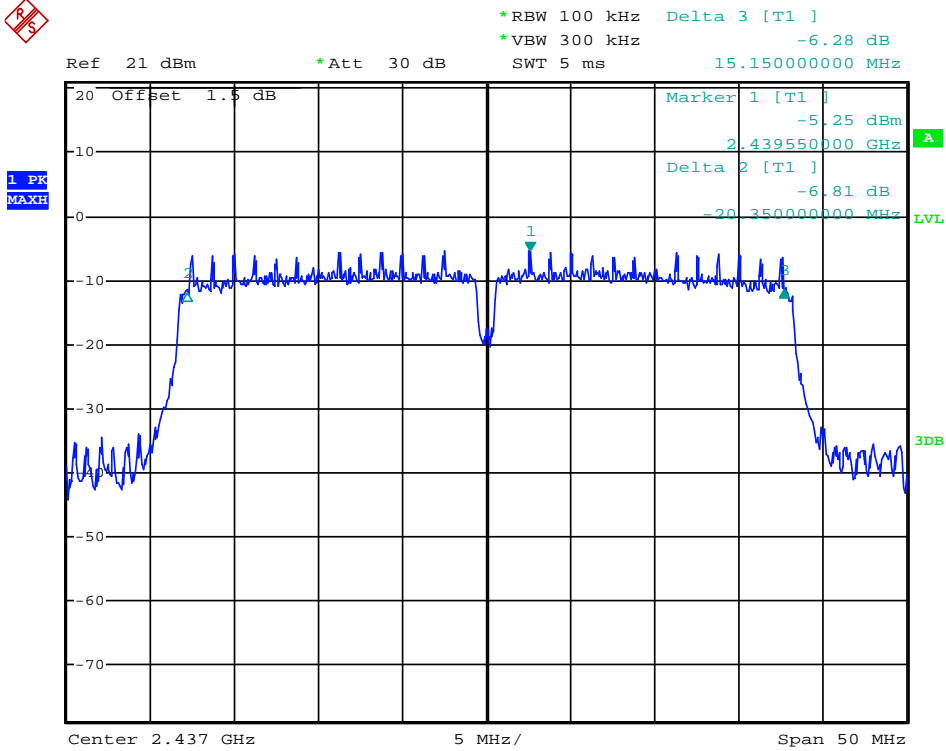

Date: 15.DEC.2013 11:32:12

(Plot 4.7.3 B: Channel 6: 2437MHz @ 802.11n(40MHz))



\*RBW 100 kHz Delta 3 [T1 ]  
\*VBW 300 kHz -5.67 dB  
SWT 5 ms 15.250000000 MHz

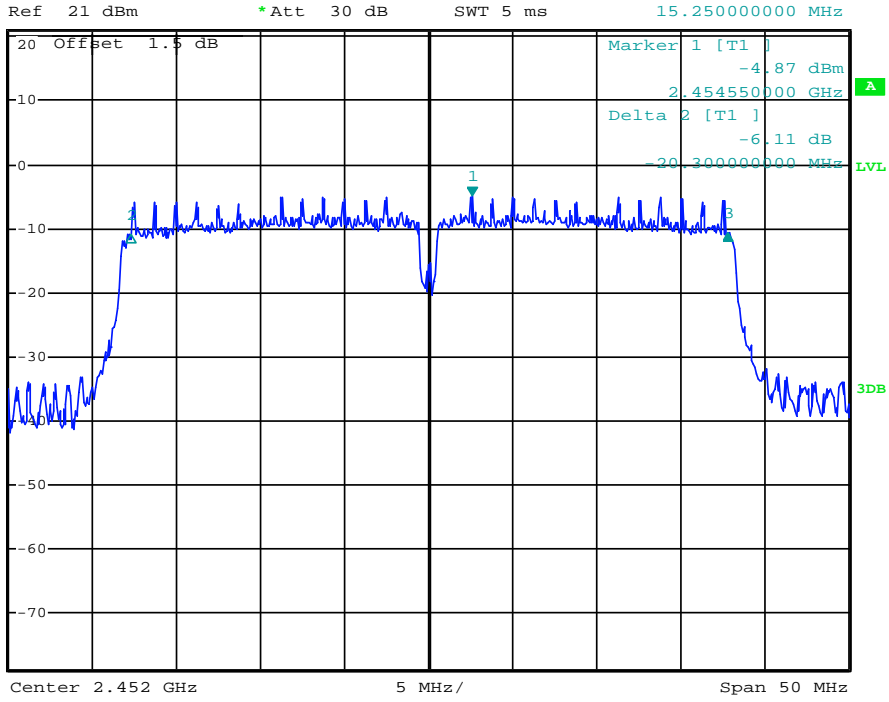

Date: 15.DEC.2013 11:33:22

(Plot 4.7.4 C: Channel 9: 2452MHz @ 802.11n(40MHz))

## 4.8. Antenna Requirement

### Standard Applicable

For intentional device, according to FCC 47 CFR Section 15.203, an intentional radiator shall be designed to ensure that no antenna other than that furnished by the responsible party shall be used with the device.

And according to FCC 47 CFR Section 15.247 (c), if transmitting antennas of directional gain greater than 6dBi are used, the power shall be reduced by the amount in dB that the directional gain of the antenna exceeds 6dBi.

### Refer to statement below for compliance

The manufacturer may design the unit so that the user can replace a broken antenna, but the use of a standard antenna jack or electrical connector is prohibited. Further, this requirement does not apply to intentional radiators that must be professionally installed.

### Antenna Connected Construction

The WLAN and Bluetooth sharing same antenna and the maximum antenna gain of WLAN used was 0.40 dBi.

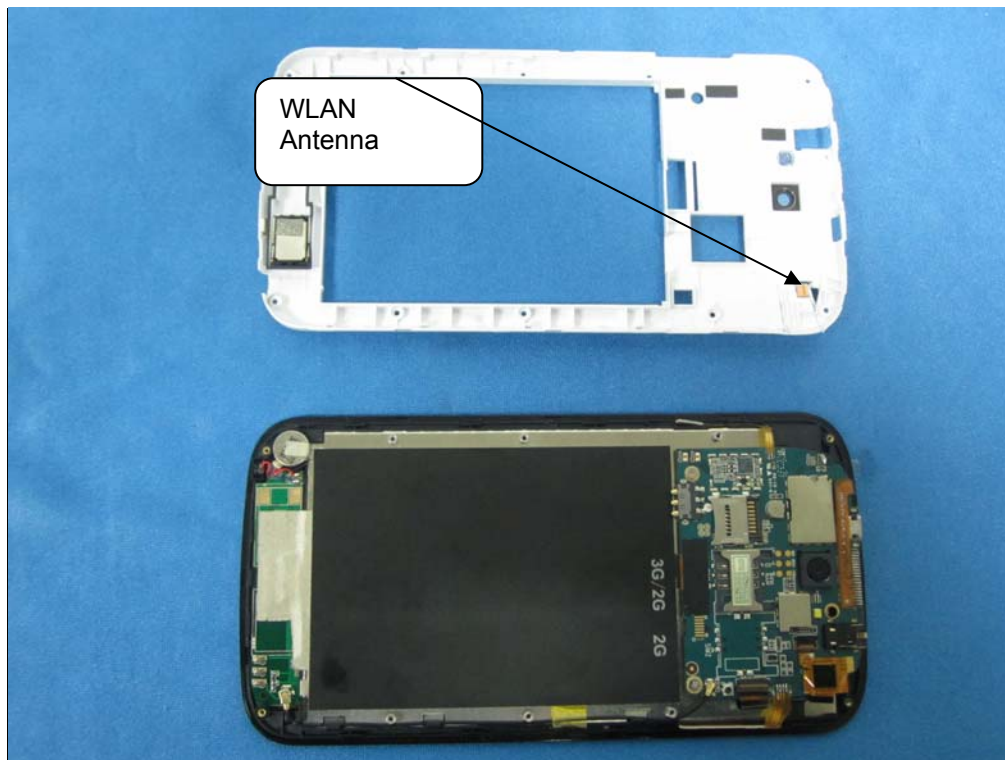

## 5. Test Setup Photos of the EUT

Radiated Emission (30MHz-1GHz)



Radiated Emission (above 1GHz)



Radiated Emission (Below 30MHz)



Conducted Emission (AC Mains)



## 6. External and Internal Photos of the EUT

### External photos of the EUT











**Internal photos of the EUT**

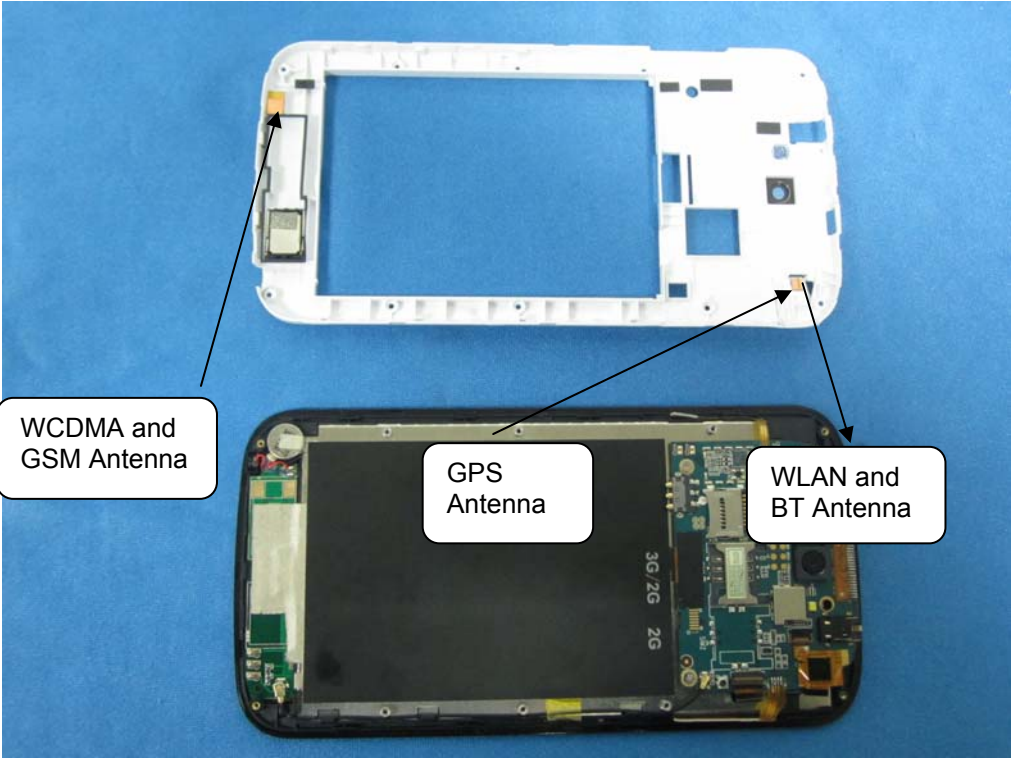





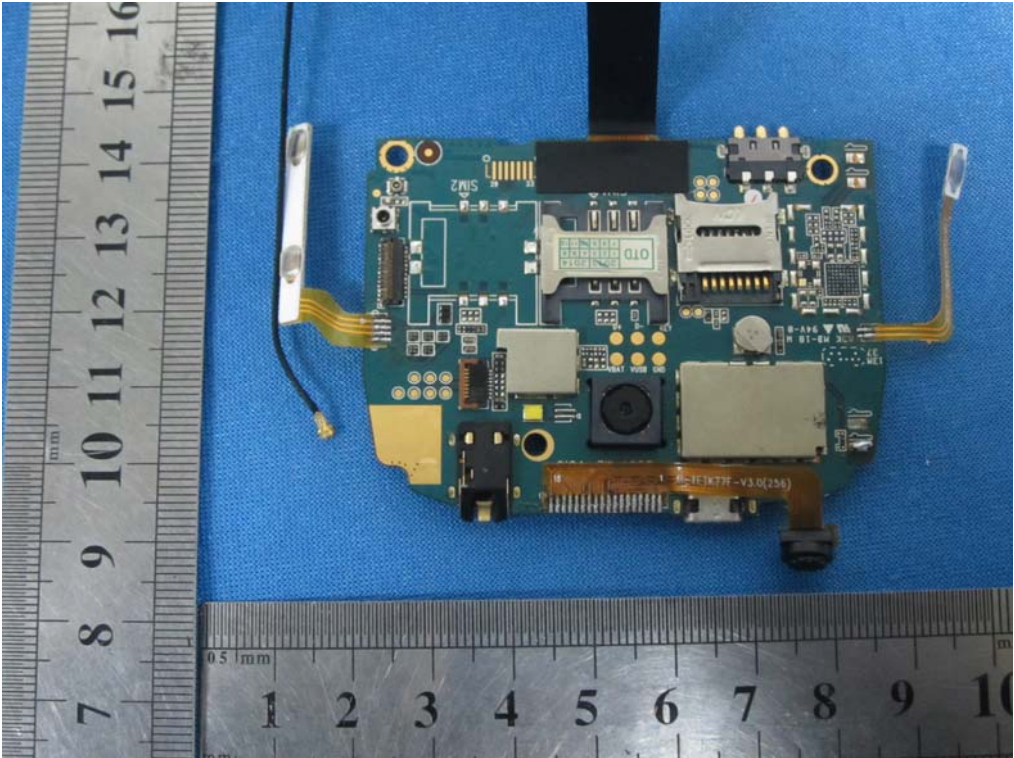

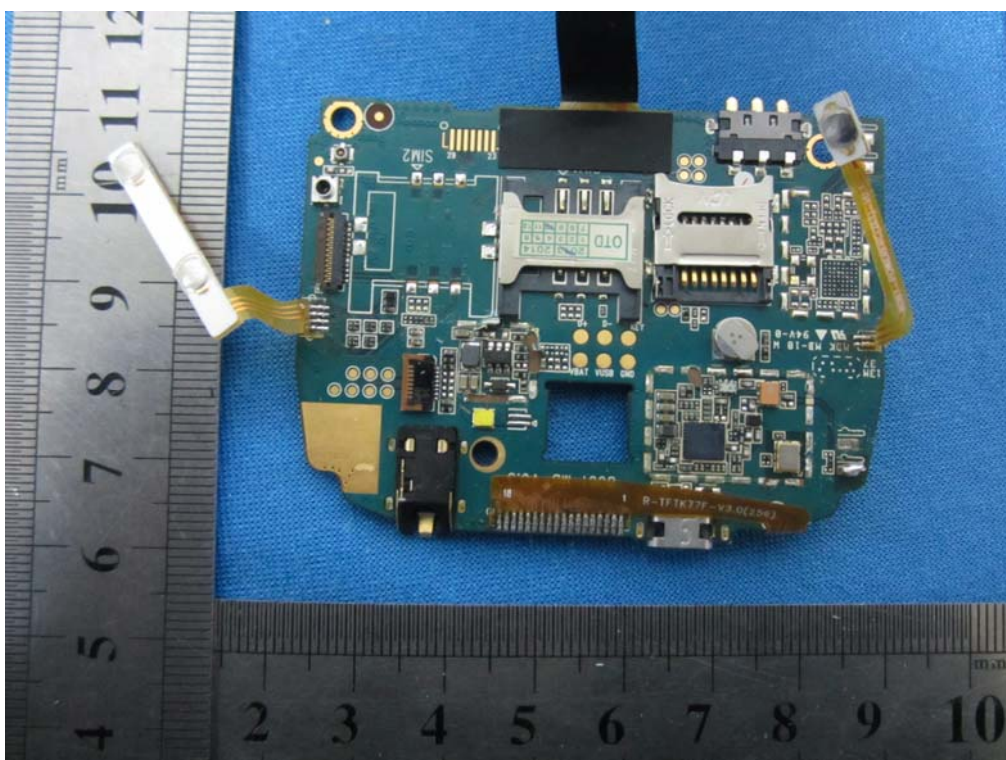
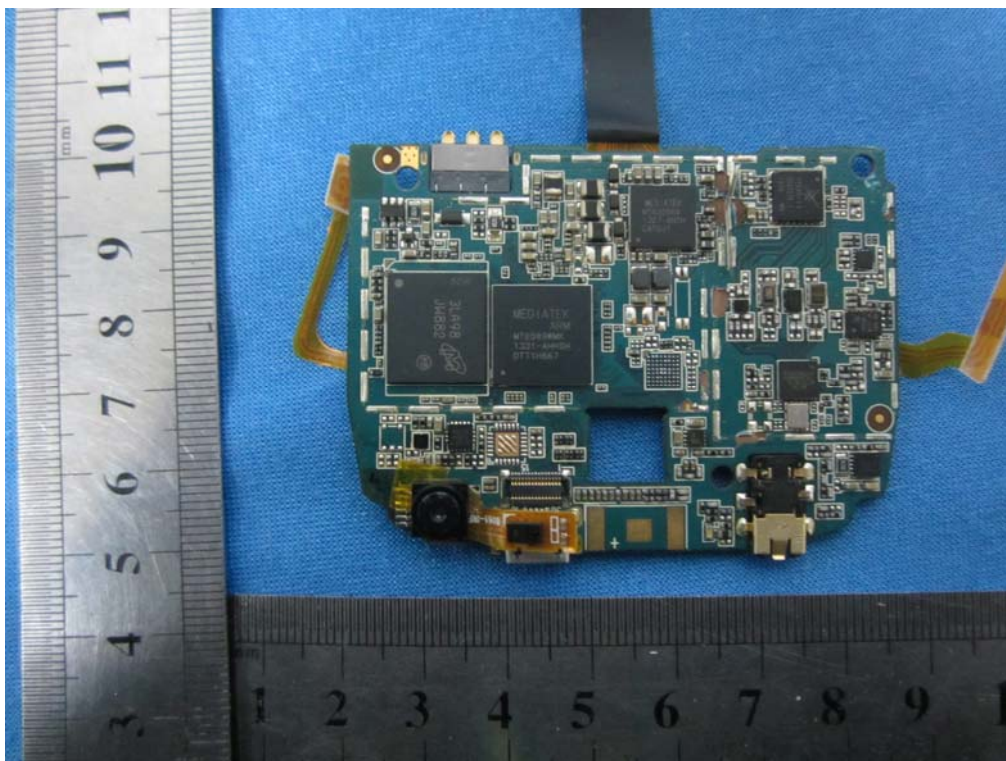



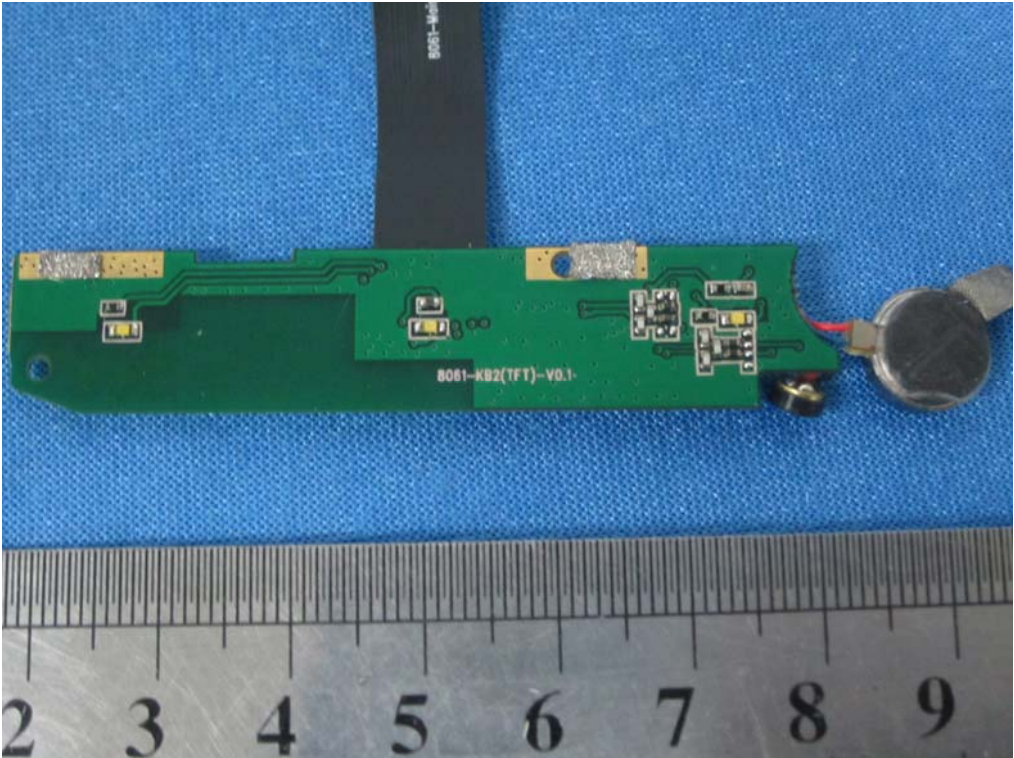
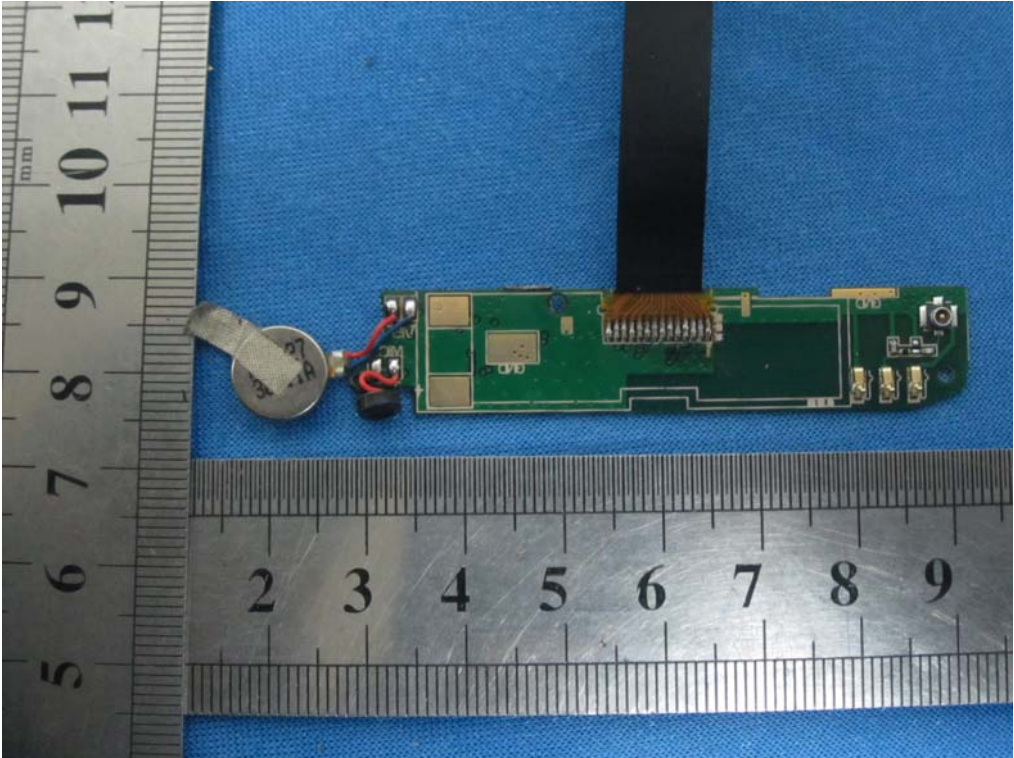

.....End of Report.....