



FCC Part 15B TEST REPORT

Report No.: STS1912170E01

Issued for

ITALCOM GROUP

1728 Coral Way, Coral Gables, Miami, Florida, United States
33145(Zip code : 518048)

Product Name:	4G LTE
Brand Name:	NYX Mobile
Model Name:	SILVER
Series Model:	N/A
FCC ID:	YPVITALCOMSILVER
Test Standard:	FCC 47 CFR Part 15: Subpart B



Any reproduction of this document must be done in full. No single part of this document may be reproduced without permission from STS, All Test Data Presented in this report is only applicable to presented Test sample.



TEST RESULT CERTIFICATION

Applicant's Name: ITALCOM GROUP
Address.....: 1728 Coral Way, Coral Gables, Miami, Florida, United States
33145(Zip code : 518048)
Manufacture's Name: Teesso intelligent technology co. LTD
Address.....: Room 702, Qilong Center, Xili Town, NanShan District, Shenzhen,
China.
Product Description:
Product Name: 4G LTE
Brand Name.....: NYX Mobile
Model Name: SILVER
Series Model: N/A
Standards.....: FCC 47 CFR Part 15: Subpart B
Test Procedure.....: ANSI C63.4-2014

This device described above has been tested by STS, and the test results show that the equipment under test (EUT) is in compliance with the FCC requirements. And it is applicable only to the tested sample identified in the report.

This report shall not be reproduced except in full, without the written approval of STS, this document may be altered or revised by STS, personal only, and shall be noted in the revision of the document.

Date of Test.....:
Date of Performance of Tests: 04 Dec. 2019~08 Dec. 2019
Date of Issue.....: 09 Dec. 2019
Test Result: Pass

Compiled by : Mickey Deng

(Mickey Deng)

Technical Manager : Chopin Xiao

(Chopin Xiao)

Authorized Signatory : Vita Li

(Vita Li)





Table of Contents

1. SUMMARY OF THE TEST RESULTS	5
1.1 TEST FACTORY	5
1.2 MEASUREMENT UNCERTAINTY	5
2. GENERAL INFORMATION	6
2.1 GENERAL DESCRIPTION OF THE EUT	6
2.2 DESCRIPTION OF THE TEST MODES	8
2.3 BLOCK DIGRAM SHOWING THE CONFIGURATION OF THE SYSTEM TESTED	9
2.4 DESCRIPTION OF THE SUPPORT UNITS	10
2.5 EQUIPMENTS LIST FOR ALL TEST ITEMS	11
3. EMC EMISSION TEST	12
3.1 CONDUCTED EMISSION MEASUREMENT	12
3.2 RADIATED EMISSION MEASUREMENT	16

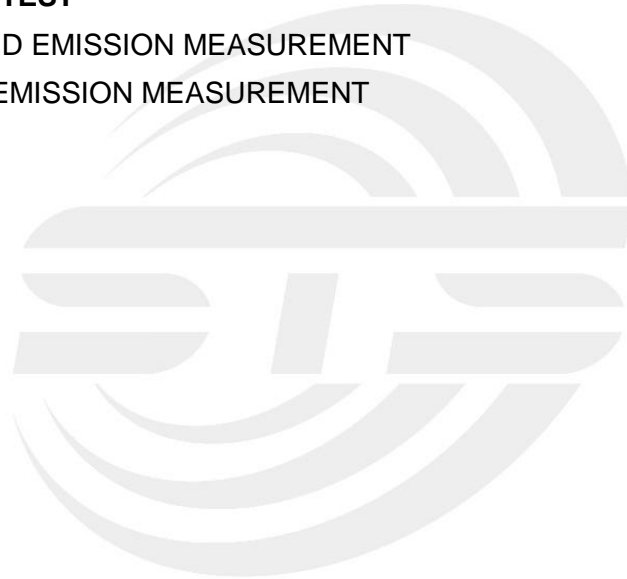



Revision History

Rev.	Issue Date	Report No.	Effect Page	Contents
00	09 Dec. 2019	STS1912170E01	ALL	Initial Issue





1. SUMMARY OF THE TEST RESULTS

Test procedures according to the technical standards:

EMISSION			
Standard	Item	Result	Remarks
FCC 47 CFR Part 15 Subpart B	Conducted Emission	PASS	Meet Class B limit
	Radiated Emission	PASS	Meet Class B limit

NOTE:

(1) "N/A" denotes test is not applicable in this Test Report

1.1 TEST FACTORY

Company Name:	SHENZHEN STS TEST SERVICES CO.,LTD.
Address:	A 1/F, Building B, Zhuoke Science Park, No.190 Chongqing Road, HepingShequ, Fuyong Sub-District, Bao'an District, Shenzhen, Guang Dong, China
Telephone:	+86-755 3688 6288
Fax:	+86-755 3688 6277
Registration No.:	FCC test Firm Registration Number: 625569
	IC test Firm Registration Number: 12108A
	A2LA Certificate No.: 4338.01

1.2 MEASUREMENT UNCERTAINTY

The reported uncertainty of measurement $y \pm U$, where expanded uncertainty U is based on a standard uncertainty multiplied by a coverage factor of $k=2$, providing a level of confidence of approximately 95 %.

No.	Item	Uncertainty
1	Conducted Emission (9KHz-150KHz)	$\pm 4.43\text{dB}$
2	Conducted Emission (150KHz-30MHz)	$\pm 5.00\text{dB}$
3	All emissions, radiated (<1G) 30MHz-1000MHz	$\pm 5.6\text{dB}$
4	All emissions, radiated (>1G) 1GHz-6GHz	$\pm 5.5\text{dB}$
5	All emissions, radiated (>1G) 6GHz-18GHz	$\pm 5.8\text{dB}$



2. GENERAL INFORMATION

2.1 GENERAL DESCRIPTION OF THE EUT

Product Name	4G LTE	
Brand Name	NYX Mobile	
Model Name	SILVER	
Series Model	N/A	
Product Differences	N/A	
Frequency Bands	GSM	850: 824.2~848.8MHz 1900: 1850.2~1909.8MHz
	WCDMA	Band II: 1852.4~1907.6MHz Band V: 826.4~846.6MHz
	LTE	Band 4: 1710.7~1754.3MHz
	WLAN	802.11b/g/n(HT20):2412~2462MHz
	Bluetooth	2402~2480MHz
	GPS	1575.42MHz
	FM	87.5~108MHz
Modulation Mode	GSM	GMSK for GSM/GPRS; GMSK and 8PSK for EDGE
	WCDMA	QPSK; HSDPA:QPSK/16QAM; HSUPA:BPSK
	LTE	QPSK/16QAM;
	WLAN	802.11b(DSSS):CCK,DQPSK,DBPSK
		802.11g(OFDM):BPSK,QPSK,16-QAM,64-QAM
		802.11n(OFDM):BPSK,QPSK,16-QAM,64-QAM
	Bluetooth	BT(1Mbps): GFSK
		BT EDR(2Mbps): $\pi/4$ -DQPSK
BT EDR(3Mbps): 8DPSK		
BLE	GFSK	
GPS	BPSK	
FM	FM	
Adapter	Input: AC100-240V, 0.2A,50-60Hz Output: DC5V, 1000mA	
Battery	Rated Voltage: 3.8V Charge Limit: 4.35V Capacity: 2450mAh	



Hardware Version Number	WW867-MB-V8.9
Software Version Number	SILVER_AMXNYX_V001R

Note: For a more detailed features description, please refer to the manufacturer's specifications or the User's Manual.





2.2 DESCRIPTION OF THE TEST MODES

To investigate the maximum EMI emission characteristics generates from EUT, the test system was pre-scanning tested base on the consideration of following EUT operation mode or test configuration mode which possible have effect on EMI emission level. Each of these EUT operation mode(s) or test configuration mode(s) mentioned above was evaluated respectively.

Pretest Mode	Description
Mode 1	GSM850 Link + Adapter + USB cable + Earphone + BT Link + GPS Rx
Mode 2	PCS1900 Link + Adapter + USB cable + Earphone + BT Link + GPS Rx
Mode 3	WCDMA1900 Link + Adapter + USB cable + Earphone + BT Link + WLAN Link + GPS Rx
Mode 4	WCDMA850 Link + Adapter + USB cable + Earphone + BT Link + WLAN Link + GPS Rx
Mode 5	LTE B4 Link + Adapter + USB cable + Earphone + BT Link + WLAN Link + GPS Rx
Mode 6	PC + USB Transmission + SD Card
Mode 7	Charging + Audio + Video + Earphone
Mode 8	Charging + FM

For Conducted Test	
Final Test Mode	Description
Mode 1	GSM850 Link + Adapter + USB cable + Earphone + BT Link + GPS Rx

For Radiated Test	
Final Test Mode	Description
Mode 1	GSM850 Link + Adapter + USB cable + Earphone + BT Link + GPS Rx

Note:

1. For conducted emission test, test mode 1 was the worst case and only this mode was presented in this report.
2. For radiated emission test, test mode 1 was the worst case and only this mode was presented in this report.
3. We have be tested for all avaiable U.S. voltage and frequencies (For 120V, 50/60Hz) for which the device is capable of operation.

2.3 BLOCK DIGRAM SHOWING THE CONFIGURATION OF THE SYSTEM TESTED

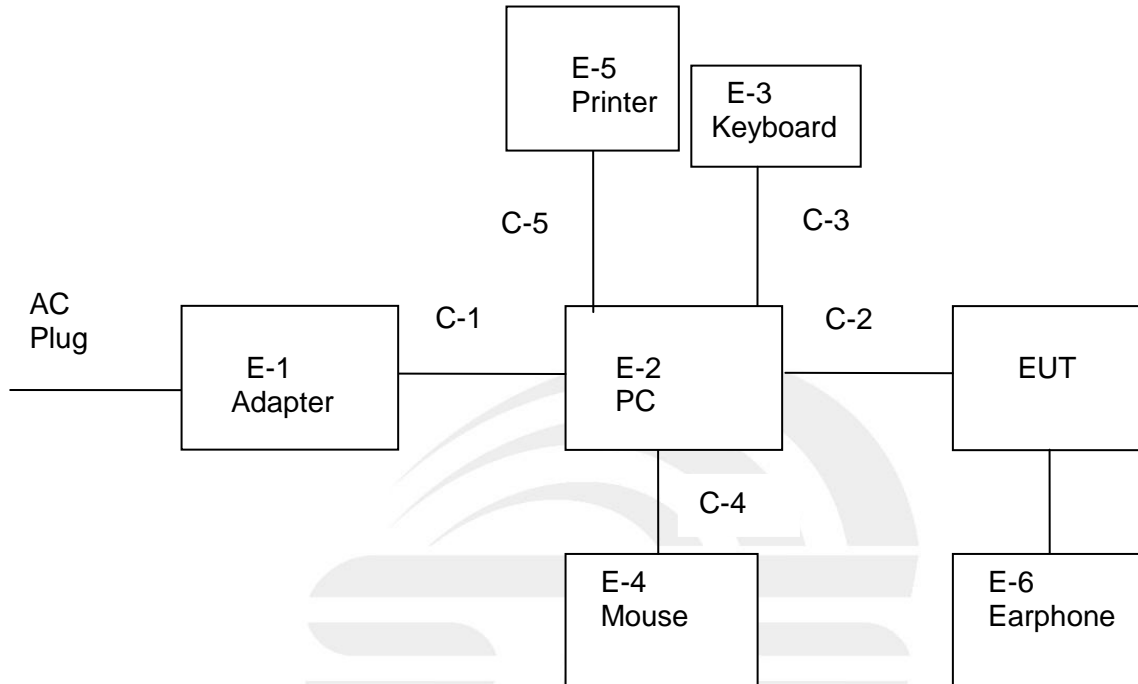

2.4 DESCRIPTION OF THE SUPPORT UNITS

The EUT has been tested as an independent unit together with other necessary accessories or support units. The following support units or accessories were used to form a representative test configuration during the tests.

Accessories equipment

Item	Equipment	Mfr/Brand	Model/Type No.
E-6	Earphone	NYX Mobile	SILVER

Auxiliary equipment

Item	Equipment	Mfr/Brand	Model/Type No.
E-1	Adapter	HP	HSTNN-CA15
E-2	PC	DELL	Inspiron 14-3467
E-3	Keyboard	Acer	SK-9624
E-4	Mouse	HP	MODGUO
E-5	Printer	LENOVO	LJ2400L

Cable

Item	Type	Shielded Type	Ferrite Core	Length
C-1	N/A	Shielded	NO	150cm
C-2	USB Cable (FTP)	Shielded	NO	100cm
C-3	USB Cable (FTP)	Shielded	NO	180cm
C-4	USB Cable (FTP)	Shielded	NO	180cm
C-5	USB Cable (FTP)	Shielded	NO	120cm

Note:

- (1) The support equipment was authorized by Declaration of Confirmation.
- (2) For detachable type I/O cable should be specified the length in cm in 『Length』 column.
- (3) “YES” is means “shielded” “with core”; “NO” is means “unshielded” “without core”.
- (4) PC is the FCC DOC is approved.



2.5 EQUIPMENTS LIST FOR ALL TEST ITEMS

The EUT has been tested as an independent unit together with other necessary accessories or support units. The following support units or accessories were used to form a representative test configuration during the tests.

Radiation Test equipment

Kind of Equipment	Manufacturer	Type No.	Serial No.	Last Calibration	Calibrated Until
EMI Test Receiver	R&S	ESCI	101427	2019.07.29	2020.07.28
Bi-log Antenna	TESEQ	CBL6111D	34678	2017.11.02	2020.11.01
Horn Antenna	SCHWARZB ECK	BBHA 9120D	9120D-1343	2018.10.19	2021.10.18
Pre-amplifier(1G-26.5G)	Agilent	8449B	3008A02383	2019.10.11	2020.10.10
Pre-amplifier(0.1M-3 GHz)	EM	EM330	060665	2019.10.09	2020.10.08
Spectrum Analyzer	Agilent	N9020A	MY49100060	2019.10.09	2020.10.08
RE Cable (9K-1G)	N/A	R01	N/A	2019.10.12	2020.10.11
RE Cable (1G-26G)	N/A	R02	N/A	2019.10.12	2020.10.11
Temperature & Humidity	Mieo	HH660	N/A	2019.10.12	2020.10.11
Horn Antenna(18-40GHz)	A-INFO	LB-180400-KF	J211020657	2018.03.11	2021.03.10
Testing Software	EZ-EMC(Ver.STSLAB-03A1 RE)				

Conduction Test equipment

Kind of Equipment	Manufacturer	Type No.	Serial No.	Last Calibration	Calibrated Until
EMI Test Receiver	R&S	ESCI	101427	2019.07.29	2020.07.28
LISN	R&S	ENV216	101242	2019.10.09	2020.10.08
LISN	ETS	3810/2NM	00023625	2019.10.09	2020.10.08
Absorbing Clamp	R&S	MDS-21	100668	2019.07.19	2020.07.18
CE Cable	N/A	C01	N/A	2019.10.12	2020.10.11
Temperature & Humidity	Mieo	HH660	N/A	2019.10.12	2020.10.11
Testing Software	EZ-EMC(Ver.STSLAB-03A1 CE)				



3. EMC EMISSION TEST

3.1 CONDUCTED EMISSION MEASUREMENT

3.1.1 POWER LINE CONDUCTED EMISSION Limits

FREQUENCY (MHz)	Conducted Emission Limits (dBuV)			
	Class A		Class B	
	Quasi-peak	Average	Quasi-peak	Average
0.15 -0.5	79.00	66.00	66 - 56 *	56 - 46 *
0.50 -5.0	73.00	60.00	56.00	46.00
5.0 -30.0	73.00	60.00	60.00	50.00

Note:

- (1) The tighter limit applies at the band edges.
- (2) The limit of " * " marked band means the limitation decreases linearly with the logarithm of the frequency in the range.

The following table is the setting of the receiver

Receiver Parameters	Setting
Attenuation	10 dB
Start Frequency	0.15 MHz
Stop Frequency	30 MHz
IF Bandwidth	9 kHz

3.1.2 TEST PROCEDURE

- a. The EUT was placed 0.4 meters from the horizontal ground plane with EUT being connected to the power mains through a line impedance stabilization network (LISN). All other support equipment powered from additional LISN(s). The LISN provide 50 Ohm/ 50uH of coupling impedance for the measuring instrument.
- b. Interconnecting cables that hang closer than 40 cm to the ground plane shall be folded back and forth in the center forming a bundle 30 to 40 cm long.
- c. I/O cables that are not connected to a peripheral shall be bundled in the center. The end of the cable may be terminated, if required, using the correct terminating impedance. The overall length shall not exceed 1 m.
- d. For the actual test configuration, please refer to the related Item –EUT Test Photos.

3.1.3 DEVIATION FROM TEST STANDARD

No deviation

3.1.4 TEST SETUP

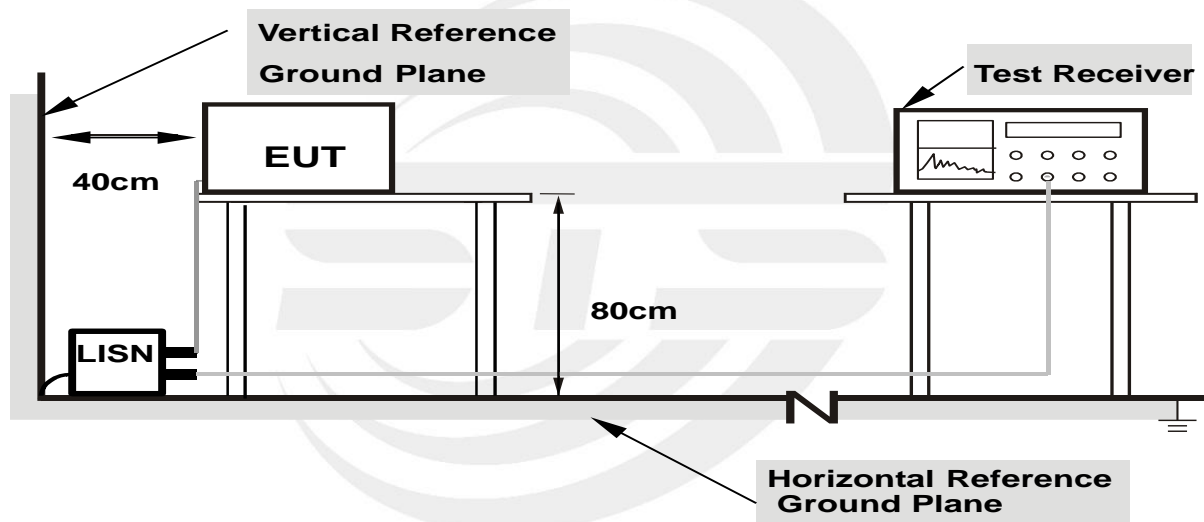

- Note: 1.Support units were connected to second LISN.
 2.Both of LISNs (AMN) are 80 cm from EUT and at least 80 from other units and other metal planes**

3.1.5 EUT OPERATING CONDITIONS

The EUT was configured for testing in a typical fashion (as a customer would normally use it). The EUT has been programmed to continuously transmit during test. This operating condition was tested and used to collect the included data.



3.1.6 TEST RESULTS

Temperature:	26.4 °C	Relative Humidity:	56%
Phase:	L	Test Mode:	Mode 1
Test Voltage:	AC 120V/60Hz	Test Date:	2019.12.05

No.	Frequency (MHz)	Reading (dBUV)	Correct Factor (dB)	Result (dBUV)	Limit (dBUV)	Margin (dB)	Detector
1	0.1500	38.64	20.59	59.23	66.00	-6.77	QP
2	0.1500	20.07	20.59	40.66	56.00	-15.34	AVG
3	0.4500	19.86	20.16	40.02	56.88	-16.86	QP
4	0.4500	6.14	20.16	26.30	46.88	-20.58	AVG
5	0.7220	11.91	20.09	32.00	56.00	-24.00	QP
6	0.7220	1.09	20.09	21.18	46.00	-24.82	AVG
7	5.3140	10.50	20.38	30.88	60.00	-29.12	QP
8	5.3140	-0.70	20.38	19.68	50.00	-30.32	AVG
9	13.8020	13.34	20.72	34.06	60.00	-25.94	QP
10	13.8020	3.37	20.72	24.09	50.00	-25.91	AVG
11	19.4820	14.56	21.38	35.94	60.00	-24.06	QP
12	19.4820	4.35	21.38	25.73	50.00	-24.27	AVG

Remark:

1. All readings are Quasi-Peak and Average values
2. Margin = Result (Result = Reading + Factor) - Limit
3. Factor = Insertion loss + Cable loss

100.0 dBUV

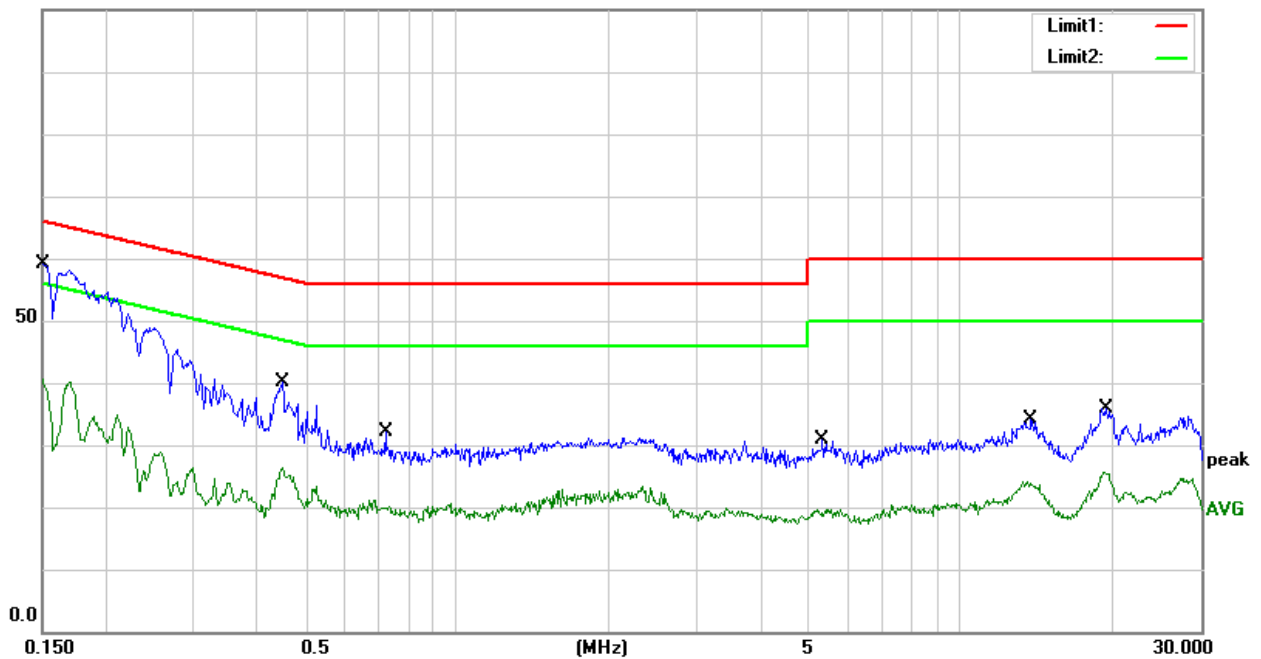



Temperature:	26.4 °C	Relative Humidity:	56%
Phase:	N	Test Mode:	Mode 1
Test Voltage:	AC 120V/60Hz	Test Date:	2019.12.05

No.	Frequency (MHz)	Reading (dBuV)	Correct Factor (dB)	Result (dBuV)	Limit (dBuV)	Margin (dB)	Detector
1	0.1500	39.38	20.59	59.97	66.00	-6.03	QP
2	0.1500	19.25	20.59	39.84	56.00	-16.16	AVG
3	0.5100	14.19	19.99	34.18	56.00	-21.82	QP
4	0.5100	7.29	19.99	27.28	46.00	-18.72	AVG
5	1.5460	14.09	19.69	33.78	56.00	-22.22	QP
6	1.5460	5.44	19.69	25.13	46.00	-20.87	AVG
7	5.6300	10.13	20.36	30.49	60.00	-29.51	QP
8	5.6300	-0.29	20.36	20.07	50.00	-29.93	AVG
9	13.7140	13.46	20.72	34.18	60.00	-25.82	QP
10	13.7140	3.68	20.72	24.40	50.00	-25.60	AVG
11	18.9260	15.34	21.34	36.68	60.00	-23.32	QP
12	18.9260	5.22	21.34	26.56	50.00	-23.44	AVG

Remark:

1. All readings are Quasi-Peak and Average values
2. Margin = Result (Result = Reading + Factor) – Limit
3. Factor = Insertion loss + Cable loss

100.0 dBuV

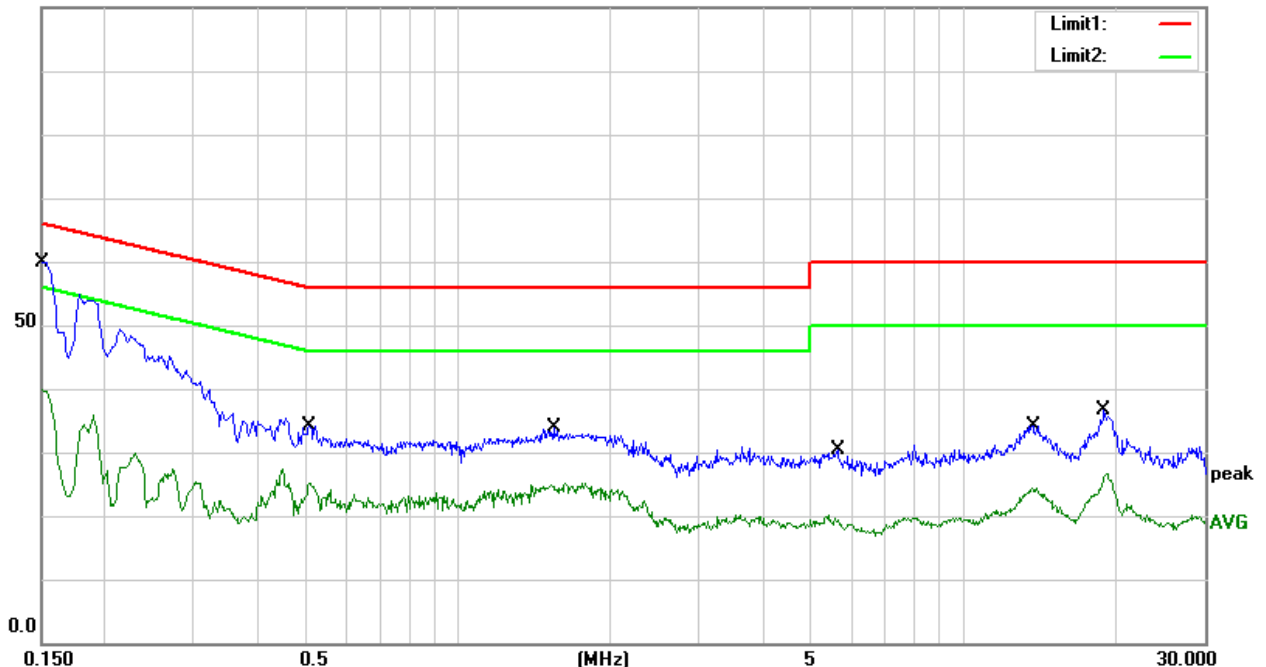

Note: The test voltage is 100-240V, both of which have assessment tests, and the worst test data is in the report.



3.2 RADIATED EMISSION MEASUREMENT

3.2.1 Radiated Emission Limits

Class A: ITE that meets the conditions for Class A operation defined in Section 2.2 shall comply with the Class A radiated limits set out in Table 4 determined at a distance of 3 metres.

Class A Radiated Limits Below 1 GHz:

Frequencies (MHz)	Class A (dB μ V/m)
	Quasi-peak
30~88	49.5
88~216	53.9
216~960	56.9
960~1000	60

Class B: ITE that does not meet the conditions for Class A operation shall comply with the Class B radiated limits set out in Table 5 determined at a distance of 3 metres.

Class B Radiated Limits Below 1 GHz:

Frequencies (MHz)	Class B (dB μ V/m)
	Quasi-peak
30~88	40
88~216	43.5
216~960	46
960~1000	54

In case the emission 109(a) limit in the table below has to be followed.

Frequencies (MHz)	Field Strength (microrvolts/meter)	Measurement Distance (meters)
30~88	100	3
88~216	150	3
216~960	200	3
Above 960	500	3



LIMITS OF RADIATED EMISSION MEASUREMENT

FREQUENCY (MHz)	Class A (dBuV/m) (at 3M)		Class B (dBuV/m) (at 3M)	
	PEAK	AVERAGE	PEAK	AVERAGE
Above 1000	80	60	74	54

Note:

- (1) The limit for radiated test was performed in the following: FCC PART 15B.
- (2) The tighter limit applies at the band edges.
- (3) Emission level (dBuV/m) = 20log Emission level (uV/m).

FREQUENCY RANGE OF THE RADIATED MEASUREMENT (For unintentional radiators)

Highest frequency generated or Upper frequency of measurement used in the device or on which the device operates or tunes (MHz)	Range (MHz)
Below 1.705	30
1.705 – 108	1000
108 – 500	2000
500 – 1000	5000
Above 1000	5th harmonic of the highest frequency or 40 GHz, whichever is lower



Spectrum Parameter	Setting
Attenuation	Auto
Detector	Peak
Start Frequency	1000 MHz(Peak/AV)
Stop Frequency	5th harmonic (Peak/AV)
RB / VB (emission in restricted band)	30MHz to 1000MHz: 100 KHz / 300 KHz Above 1000MHz: 1 MHz / 3 MHz

Receiver Parameter	Setting
Attenuation	Auto
Start ~ Stop Frequency	30MHz to 1000MHz: 100 KHz / 300 KHz Above 1000MHz: 1 MHz / 3 MHz

3.2.2 TEST PROCEDURE

- The EUT was placed on the top of a rotating table 0.8 meters above the ground at a 3 meter semi-anechoic chamber room. The table was rotated 360 degrees to determine the position of the highest radiation.
- The EUT was set 3 meters away from the interference-receiving antenna, which was mounted on the top of a variable-height antenna tower.
- The height of antenna is varied from 1 meter to 4 meters above the ground to determine the maximum value of the field strength. Both horizontal and vertical polarizations of the antenna are set to make the measurement.
- For each suspected emission, the EUT was arranged to its worst case and then the antenna was tuned to heights from 1 meter to 4 meters and the rotatable table was turned from 0 degrees to 360 degrees to find the maximum reading.
- The test-receiver system was set to quasi-peak detect function and specified bandwidth with maximum hold mode when the test frequency is below 1GHz.
- For the actual test configuration, please refer to the related Item –EUT Test Photos.

Note: Both horizontal and vertical antenna polarities were tested and performed pretest to three orthogonal axis. The worst case emissions were reported

3.2.3 DEVIATION FROM TEST STANDARD

No deviation

3.2.4 TEST SETUP

(A) Radiated Emission Test-Up Frequency 30MHz~1GHz

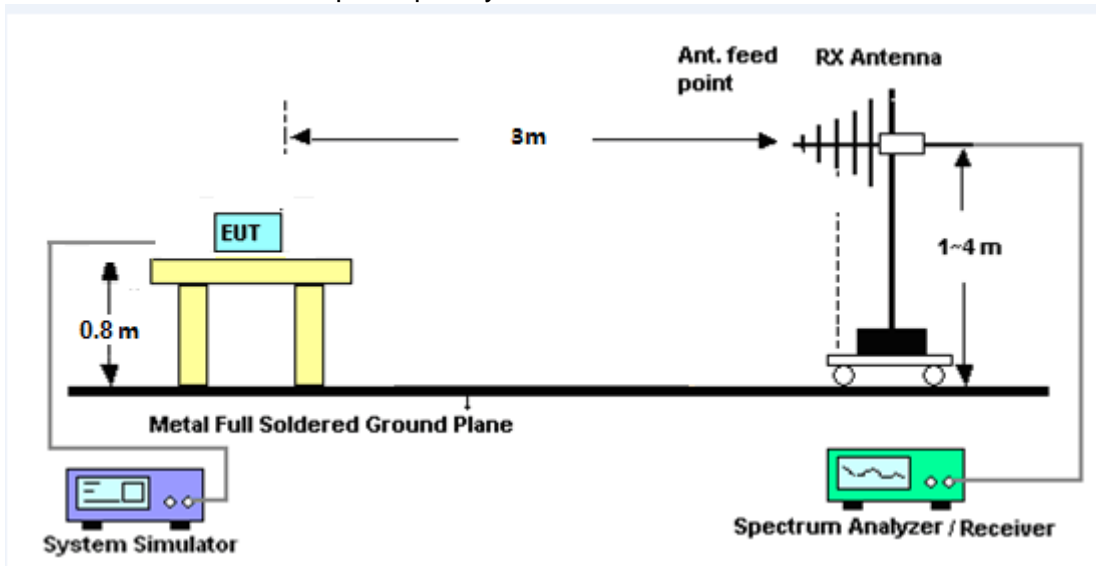

(B) Radiated Emission Test-Up Frequency Above 1GHz

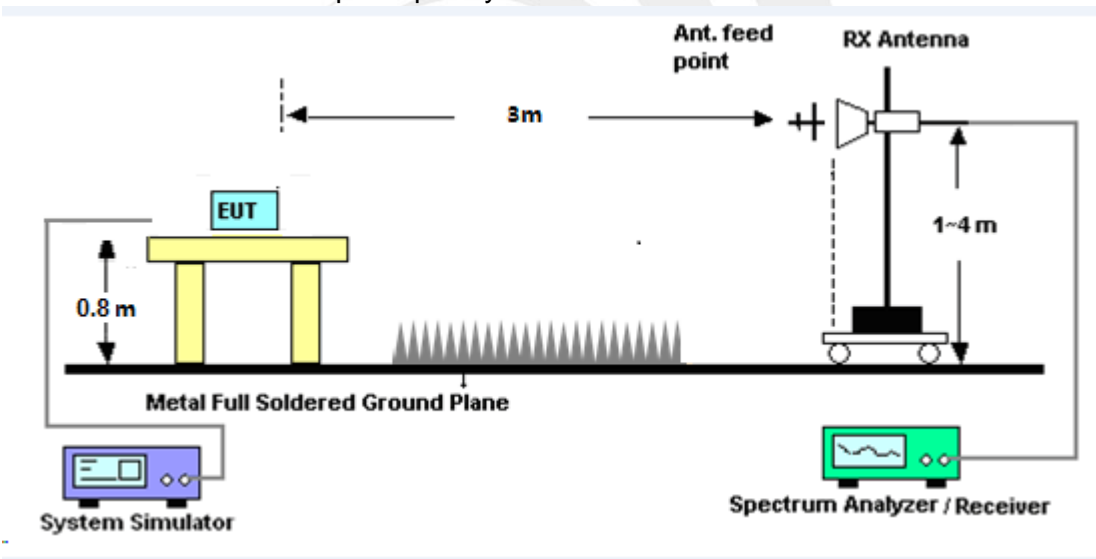

3.2.5 EUT OPERATING CONDITIONS

The EUT tested system was configured as the statements of 2.4 Unless otherwise a special operating condition is specified in the following during the testing.



3.2.6 TEST RESULTS

30MHz -1000MHz

Temperature:	22.1 °C	Relative Humidity:	30%
Phase:	Horizontal	Test Mode:	Mode 1
Test Voltage:	AC 120V/60Hz	Test Date:	2019.12.04

No.	Frequency (MHz)	Reading (dBuV)	Correct Factor (dB)	Results (dBuV/m)	Limit (dBuV/m)	Margin (dB)	Detector
1	48.8430	42.50	-21.21	21.29	40.00	-18.71	QP
2	148.9625	40.25	-18.53	21.72	43.50	-21.78	QP
3	239.9873	49.56	-19.90	29.66	46.00	-16.34	QP
4	582.7423	39.20	-9.40	29.80	46.00	-16.20	QP
5	721.7260	37.28	-7.23	30.05	46.00	-15.95	QP
6	996.4995	36.50	-3.53	32.97	54.00	-21.03	QP

Remark:

1. All readings are Quasi-Peak
2. Margin = Result (Result =Reading + Factor)–Limit
3. Factor= Cable Loss +Antenna Factor-Amplifier Gain

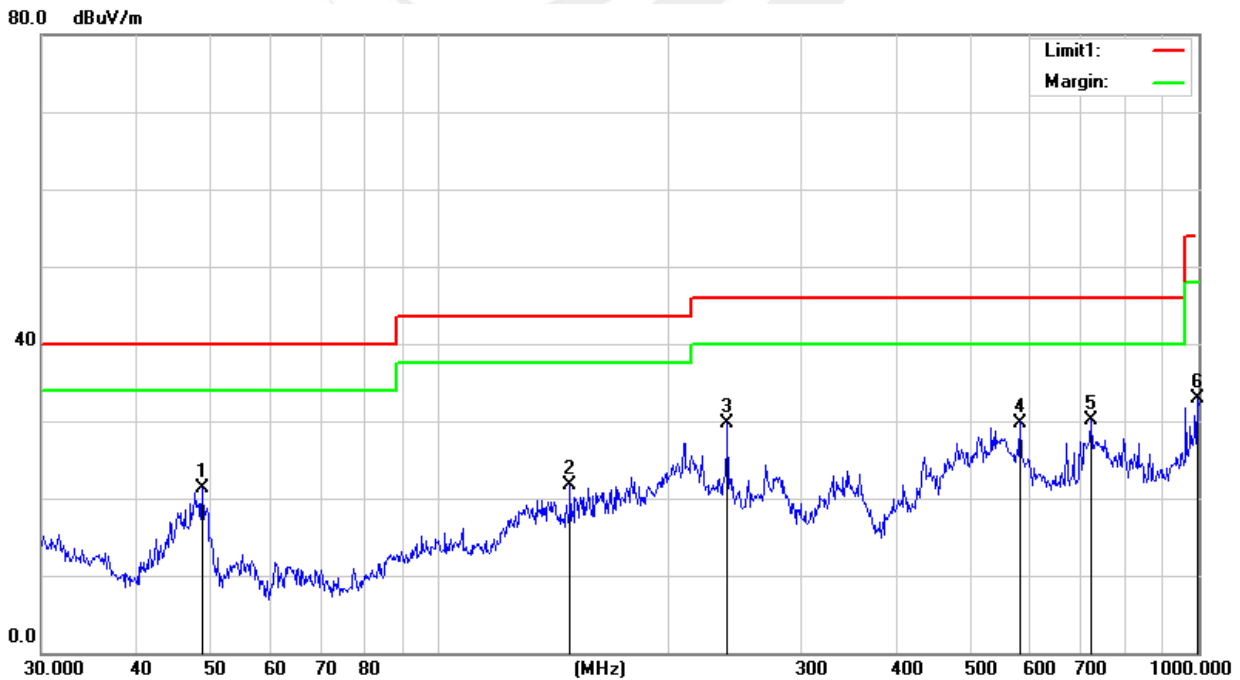



Temperature:	22.1 °C	Relative Humidity:	30%
Phase:	Vertical	Test Mode:	Mode 1
Test Voltage:	AC 120V/60Hz	Test Date:	2019.12.04

No.	Frequency (MHz)	Reading (dBUV)	Correct Factor (dB)	Results (dBUV/m)	Limit (dBUV/m)	Margin (dB)	Detector
1	48.3318	38.70	-21.84	16.86	40.00	-23.14	QP
2	120.2766	37.52	-19.38	18.14	43.50	-25.36	QP
3	215.2677	45.09	-21.25	23.84	43.50	-19.66	QP
4	326.7395	42.20	-16.24	25.96	46.00	-20.04	QP
5	531.9634	41.71	-10.27	31.44	46.00	-14.56	QP
6	962.1622	36.33	-3.67	32.66	54.00	-21.34	QP

Remark:

1. All readings are Quasi-Peak
2. Margin = Result (Result = Reading + Factor) – Limit
3. Factor = Cable Loss + Antenna Factor - Amplifier Gain

80.0 dBUV/m

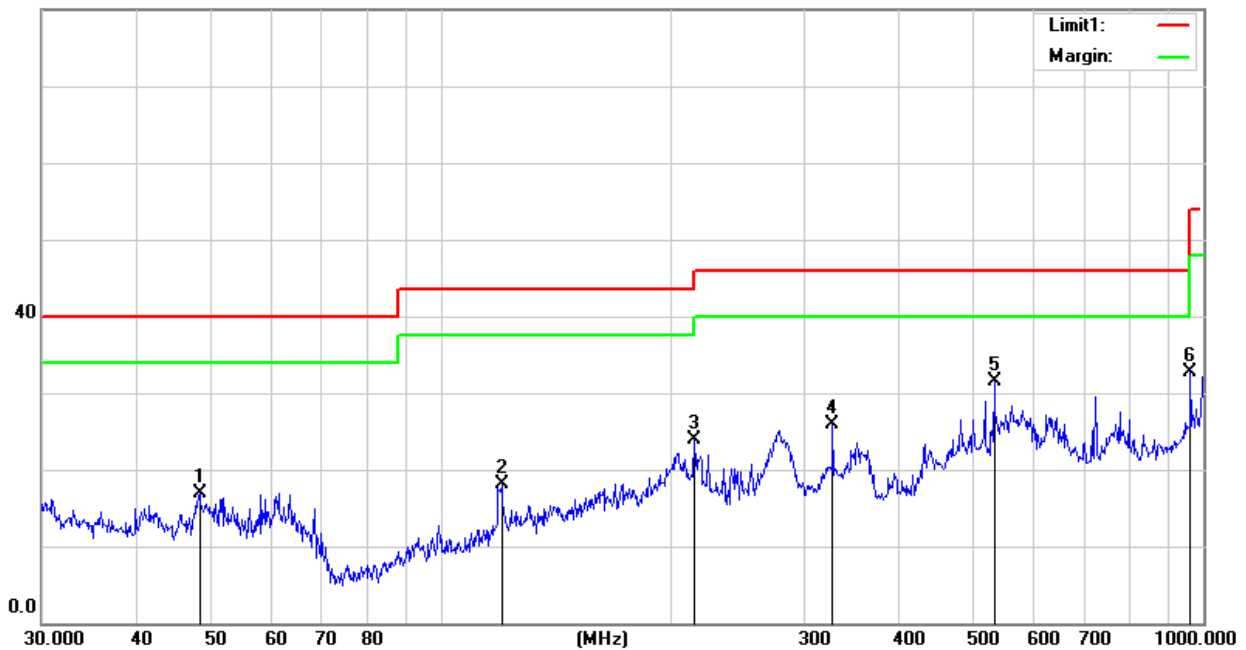



(1 GHz to 25GHz.)

Temperature:	22.1 °C	Relative Humidity:	30%
Phase:	Horizontal	Test Mode:	Mode 1
Test Voltage:	AC 120V/60Hz	Test Date:	2019.12.04

No.	Frequency (MHz)	Reading (dBuV)	Correct Factor (dB)	Result (dBuV)	Limit (dBuV)	Margin (dB)	Remark
1	18728.000	25.27	24.69	49.96	74.00	-24.04	Peak
2	18728.000	14.85	24.69	39.54	54.00	-14.46	AVG
3	20282.000	25.27	24.82	50.09	74.00	-23.91	Peak
4	20282.000	15.61	24.82	40.43	54.00	-13.57	AVG
5	21591.000	27.44	24.71	52.15	74.00	-21.85	Peak
6	21591.000	19.30	24.71	44.01	54.00	-9.99	AVG
7	22627.000	28.80	24.45	53.25	74.00	-20.75	Peak
8	22627.000	19.78	24.45	44.23	54.00	-9.77	AVG
9	23985.000	29.70	24.84	54.54	74.00	-19.46	Peak
10	23985.000	21.50	24.84	46.34	54.00	-7.66	AVG
11	24958.000	32.49	24.96	57.45	74.00	-16.55	Peak
12	24958.000	23.18	24.96	48.14	54.00	-5.86	AVG

Remark:

1. All readings are Peak and Average values
2. Margin = Result (Result =Reading + Factor)–Limit
3. Factor= Cable Loss +Antenna Factor-Amplifier Gain

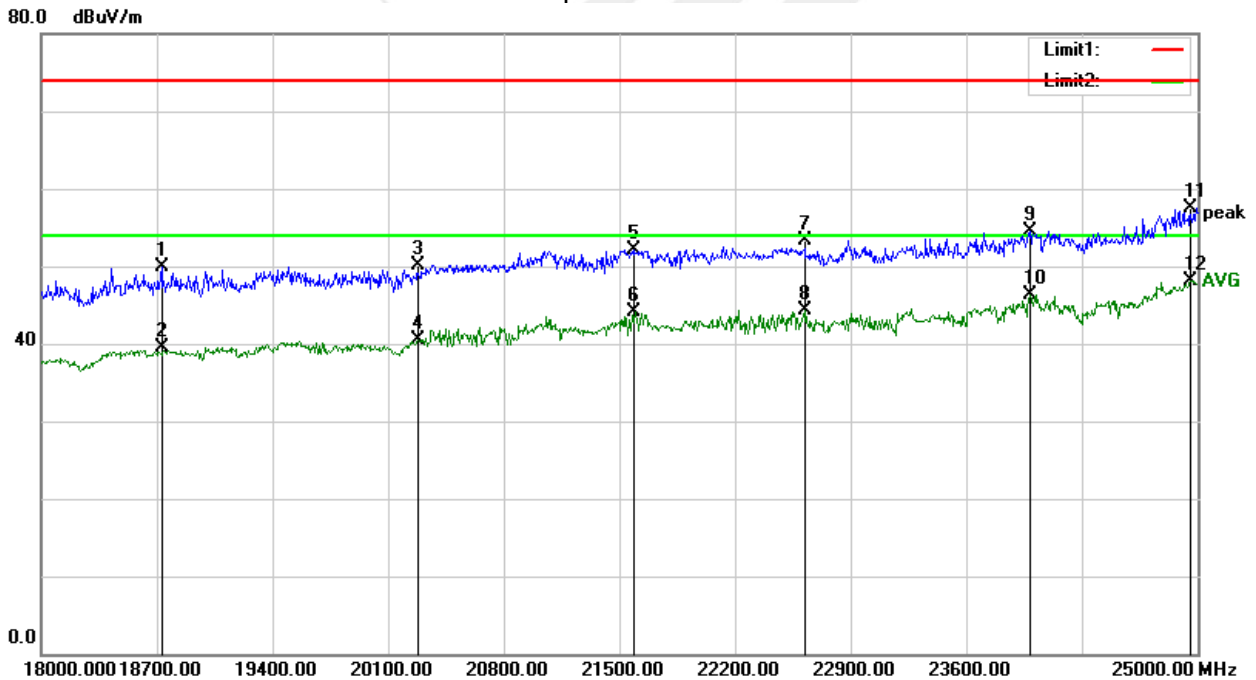



Temperature:	22.1 °C	Relative Humidity:	30%
Phase:	Vertical	Test Mode:	Mode 1
Test Voltage:	AC 120V/60Hz	Test Date:	2019.12.04

No.	Frequency (MHz)	Reading (dBuV)	Correct Factor (dB)	Result (dBuV)	Limit (dBuV)	Margin (dB)	Remark
1	18952.000	25.61	24.45	50.06	74.00	-23.94	Peak
2	18952.000	16.54	24.45	40.99	54.00	-13.01	AVG
3	20625.000	26.33	24.94	51.27	74.00	-22.73	Peak
4	20625.000	17.41	24.94	42.35	54.00	-11.65	AVG
5	21598.000	28.99	24.71	53.70	74.00	-20.30	Peak
6	21598.000	18.86	24.71	43.57	54.00	-10.43	AVG
7	22396.000	29.18	24.45	53.63	74.00	-20.37	Peak
8	22396.000	21.10	24.45	45.55	54.00	-8.45	AVG
9	23754.000	32.01	24.79	56.80	74.00	-17.20	Peak
10	23754.000	24.06	24.79	48.85	54.00	-5.15	AVG
11	24552.000	32.60	24.95	57.55	74.00	-16.45	Peak
12	24552.000	23.36	24.95	48.31	54.00	-5.69	AVG

Remark:

1. All readings are Peak and Average values
2. Margin = Result (Result = Reading + Factor) – Limit
3. Factor = Cable Loss + Antenna Factor - Amplifier Gain

80.0 dBuV/m

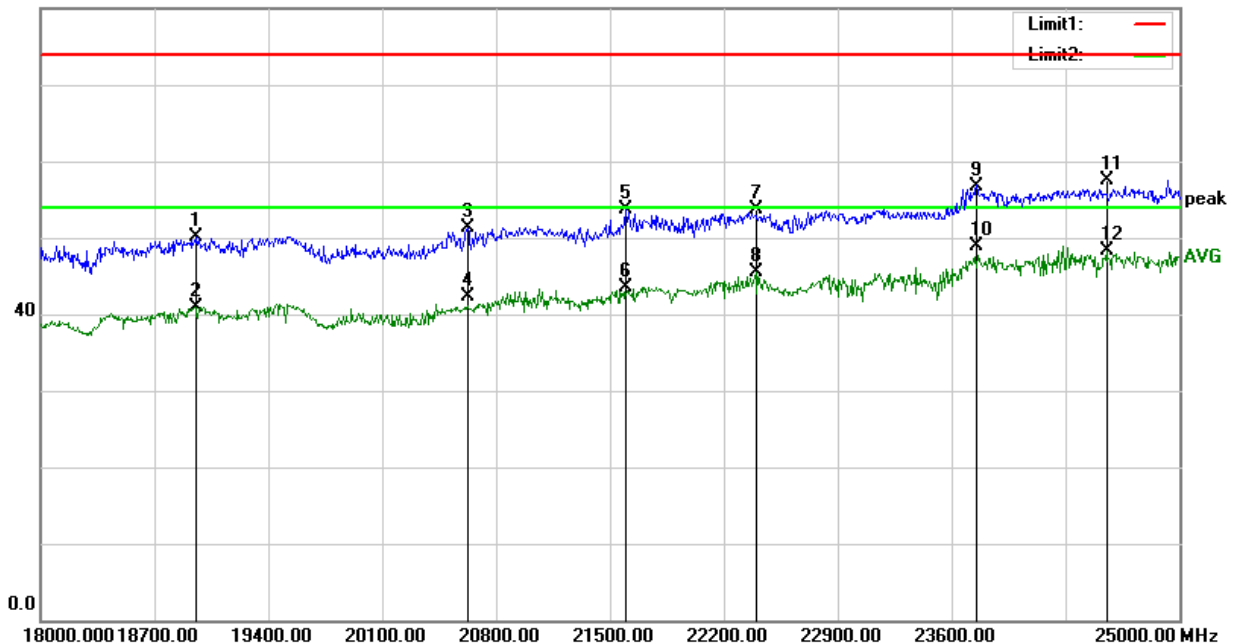

Notes:

1. Measuring frequencies from 1 GHz to 25GHz.
2. Radiated emissions measured in frequency above 1000MHz were made with an instrument using Peak detector mode of the emission shown in Actual FS column.

END OF THE REPORT