

FCC PART 22H, PART 24E
MEASUREMENT AND TEST REPORT

For

ITALCOM GROUP

1728 Coral Way, Coral Gables, Miami, Florida, USA

FCC ID: YPVITALCOMNOA1

Report Type: Original Report	Product Type: GSM Mobile Phone
Test Engineer: Felix Li	<i>Felix Li</i>
Report Number: RSZ120111004-00A	
Report Date: 2012-01-19	
Reviewed By: EMC Engineer	<i>Alvin Huang</i>
Test Laboratory: Bay Area Compliance Laboratories Corp. (Shenzhen) 6/F, the 3rd Phase of WanLi Industrial Building, ShiHua Road, FuTian Free Trade Zone Shenzhen, Guangdong, China Tel: +86-755-33320018 Fax: +86-755-33320008 www.baclcorp.com.cn	

Note: This test report is prepared for the customer shown above and for the device described herein. It may not be duplicated or used in part without prior written consent from Bay Area Compliance Laboratories Corp. This report **must not** be used by the customer to claim product certification, approval, or endorsement by NVLAP*, or any agency of the Federal Government.

* This report contains data that are not covered by the NVLAP accreditation and are marked with an asterisk "★" (Rev.2)

TABLE OF CONTENTS

GENERAL INFORMATION.....4

 PRODUCT DESCRIPTION FOR EQUIPMENT UNDER TEST (EUT)4

 OBJECTIVE4

 RELATED SUBMITTAL(S)/GRANT(S).....4

 TEST METHODOLOGY4

 TEST FACILITY5

SYSTEM TEST CONFIGURATION.....6

 JUSTIFICATION6

 EQUIPMENT MODIFICATIONS6

 REMOTE SUPPORT EQUIPMENT LIST AND DETAILS6

 CONFIGURATION OF TEST SETUP6

 BLOCK DIAGRAM OF TEST SETUP7

SUMMARY OF TEST RESULTS8

FCC §1.1307 & §2.1093 - RF EXPOSURE.....9

 APPLICABLE STANDARD9

 TEST RESULT9

FCC §2.1047 - MODULATION CHARACTERISTIC10

FCC §2.1046, §22.913 (A) & §24.232 (C) - RF OUTPUT POWER.....11

 APPLICABLE STANDARD11

 TEST PROCEDURE11

 TEST EQUIPMENT LIST AND DETAILS.....11

 TEST DATA12

FCC §2.1049, §22.917, §22.905 & §24.238 - OCCUPIED BANDWIDTH14

 APPLICABLE STANDARD14

 TEST PROCEDURE14

 TEST EQUIPMENT LIST AND DETAILS.....14

 TEST DATA14

FCC §2.1051, §22.917(A) & §24.238(A) - SPURIOUS EMISSIONS AT ANTENNA TERMINALS18

 APPLICABLE STANDARD18

 TEST PROCEDURE18

 TEST EQUIPMENT LIST AND DETAILS.....18

 TEST DATA18

FCC §2.1053, §22.917 & §24.238 - SPURIOUS RADIATED EMISSIONS21

 APPLICABLE STANDARD21

 TEST PROCEDURE21

 TEST EQUIPMENT LIST AND DETAILS.....21

 TEST DATA22

FCC §22.917(A) & §24.238(A) - BAND EDGES.....23

 APPLICABLE STANDARD23

 TEST PROCEDURE23

 TEST EQUIPMENT LIST AND DETAILS.....23

 TEST DATA23

FCC §2.1055, §22.355 & §24.235 - FREQUENCY STABILITY.....27
APPLICABLE STANDARD27
TEST PROCEDURE27
TEST EQUIPMENT LIST AND DETAILS.....28
TEST DATA28

GENERAL INFORMATION

Product Description for Equipment under Test (EUT)

The *ITALCOM GROUP*'s product, model number: *NOA+ (FCC ID: YPVITALCOMNOA1)* (the "EUT") in this report was a *Mobile Phone*, which was measured approximately: 10.0 cm (L) x 4.0 cm (W) x 1.5 cm (H), rated input voltage: DC 3.7V Lithium battery.

Frequency Range:

Cellular Band: 824-849 MHz (Tx), 869-894 MHz (Rx)
PCS Band: 1850-1910 MHz (Tx), 1930-1990 MHz (Rx)

Modulation Mode: GMSK

Transmitter Output Power:

Cellular Band: 32.25 dBm (Conducted)
PCS Band: 30.68 dBm (Conducted)

** All measurement and test data in this report was gathered from production sample serial number: 1201027 (Assigned by BACL, Shenzhen). The EUT was received on 2012-01-11.*

Objective

This report is prepared on behalf of *ITALCOM GROUP* in accordance with Part 2-Subpart J, Part 22-Subpart H, and Part 24-Subpart E of the Federal Communication Commissions rules.

The objective is to determine compliance with FCC rules for output power, modulation characteristic, occupied bandwidth, spurious emission at antenna terminal, spurious radiated emission, frequency stability and band edge.

Related Submittal(s)/Grant(s)

No related submittal(s)

Test Methodology

All tests and measurements indicated in this document were performed in accordance with the Code of Federal Regulations Title 47 Part 2, Sub-part J as well as the following parts:

Part 22 Subpart H - Public Mobile Services
Part 24 Subpart E - Personal Communication Services

Applicable Standards: TIA/EIA 603-C, ANSI C63.4-2009.

All radiated and conducted emissions measurements were performed at Bay Area Compliance Laboratories Corp. The radiated testing was performed at an antenna-to-EUT distance of 3 meters.

The uncertainty of any RF tests which use conducted method measurement is ± 0.96 dB, the uncertainty of any radiation on emissions measurement is ± 4.0 dB

Test Facility

The Test site used by Bay Area Compliance Laboratories Corp.(Shenzhen) to collect test data is located on the 6/F, the 3rd Phase of WanLi Industrial Building, ShiHua Road, FuTian Free Trade Zone Shenzhen, Guangdong, China.

Test site at Bay Area Compliance Laboratories Corp. (Shenzhen) has been fully described in reports submitted to the Federal Communication Commission (FCC). The details of these reports have been found to be in compliance with the requirements of Section 2.948 of the FCC Rules on December 06, 2010. The facility also complies with the radiated and AC line conducted test site criteria set forth in ANSI C63.4-2009.

The Federal Communications Commission has the reports on file and is listed under FCC Registration No.: 382179. The test site has been approved by the FCC for public use and is listed in the FCC Public Access Link (PAL) database.

Additionally, Bay Area Compliance Laboratories Corp. (Shenzhen) is an ISO/IEC 17025 accredited laboratory, and is accredited by National Voluntary Laboratory Accredited Program (Lab Code 200707-0).



The current scope of accreditations can be found at <http://ts.nist.gov/Standards/scopes/2007070.htm>

SYSTEM TEST CONFIGURATION

Justification

The EUT was configured for testing according to TIA/EIA-603-C.

The GSM/PCS item test was performed with the EUT operating at normal mode.

Equipment Modifications

No modification was made to the EUT.

Remote Support Equipment List and Details

Manufacturer	Description	Model	Serial Number	Calibration Date
R & S	Universal Radio Communication Tester	CMU200	109038	2011-10-28

Configuration of Test Setup

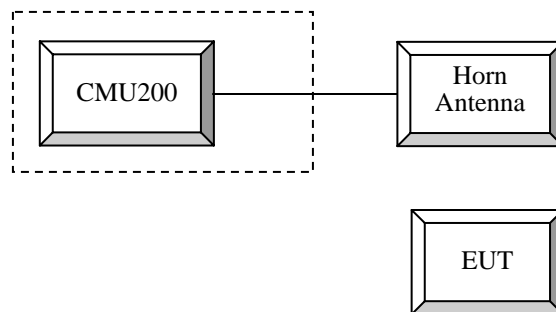

Block Diagram of Test Setup

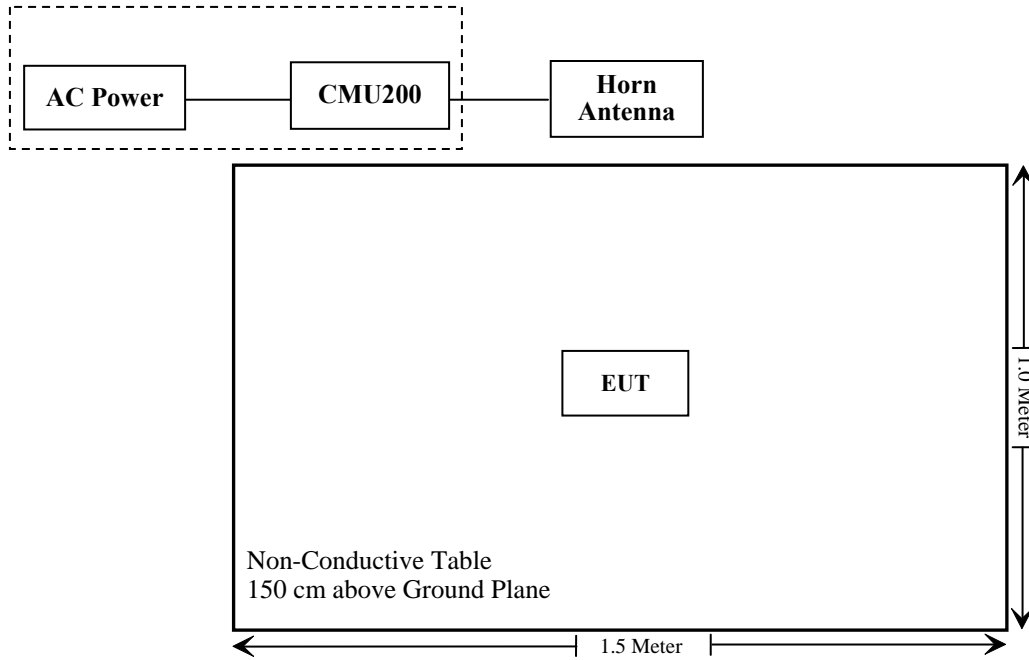

SUMMARY OF TEST RESULTS

FCC Rules	Description of Test	Result
§1.1307, §2.1093	RF Exposure (SAR)	Compliance*
§2.1046; §22.913 (a); §24.232 (c)	RF Output Power	Compliance
§2.1047	Modulation Characteristics	Not Applicable
§2.1049; §22.905 §22.917; §24.238	Occupied Bandwidth	Compliance
§2.1051, §22.917 (a); §24.238 (a)	Spurious Emissions at Antenna Terminal	Compliance
§2.1053 §22.917 (a); §24.238 (a)	Field Strength of Spurious Radiation	Compliance
§22.917 (a); §24.238 (a)	Out of band emission, Band Edge	Compliance
§2.1055 §22.355; §24.235	Frequency stability vs. temperature Frequency stability vs. voltage	Compliance

Note: * Please refer to SAR report released by BACL, report number: RSZ120111004-20

FCC §1.1307 & §2.1093 - RF EXPOSURE

Applicable Standard

FCC §1.1307 and §2.1093.

Test Result

Compliance, please refer to the SAR report: RSZ120111004-20

FCC §2.1047 - MODULATION CHARACTERISTIC

According to FCC §2.1047(d), Part 22H & 24E there is no specific requirement for digital modulation, therefore modulation characteristic is not presented.

FCC §2.1046, §22.913 (a) & §24.232 (c) - RF OUTPUT POWER

Applicable Standard

According to FCC §2.1046 and §22.913 (a), the ERP of mobile transmitters and auxiliary test transmitters must not exceed 7 watts.

According to FCC §2.1046 and §24.232 (c), mobile and portable stations are limited to 2 watts EIRP and the equipment must employ a means for limiting power to the minimum necessary for successful communications.

Test Procedure

Conducted method:

The RF output of the transmitter was connected to the wireless test set and the spectrum analyzer through sufficient attenuation.

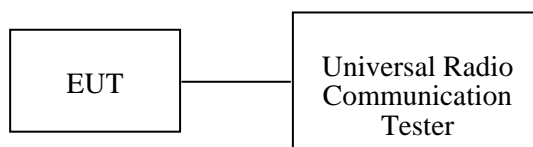

Radiated method:

TIA 603-C section 2.2.17

Test Equipment List and Details

Manufacturer	Description	Model	Serial Number	Calibration Date	Calibration Due Date
Sunol Sciences	Horn Antenna	DRH-118	A052604	2011-05-05	2012-05-04
Rohde & Schwarz	Signal Analyzer	FSIQ 26	609358	2011-07-08	2012-07-07
Sunol Sciences	Broadband Antenna	JB1	A040904-1	2011-07-05	2012-07-04
Mini-Circuits	Amplifier	ZVA-213+	T-E27H	2011-03-08	2012-03-07
HP	Signal Generator	HP8657A	2849U00982	2011-10-28	2012-10-27
HP	Amplifier	HP8447D	2944A09795	2011-08-02	2012-08-02
HP	Synthesized Sweeper	8341B	2624A00116	2011-11-07	2012-11-06
COM POWER	Dipole Antenna	AD-100	041000	2011-09-25	2012-09-25
A.H. System	Horn Antenna	SAS-200/571	135	2011-05-17	2012-05-17

* **Statement of Traceability:** Bay Area Compliance Laboratories Corp. (Shenzhen) attests that all calibrations have been performed in accordance to NVLAP requirements, traceable to the NIST.

Test Data**Environmental Conditions**

Temperature:	25 °C
Relative Humidity:	56 %
ATM Pressure:	100.0kPa

The testing was performed by Felix Li on 2011-12-01.

Conducted Power:

Cellular Band (Part 22H)

Mode	Channel	Frequency (MHz)	Output Power (dBm)	Limit (dBm)
GSM	128	824.2	32.25	38.45
	190	836.6	31.83	38.45
	251	848.8	31.88	38.45

PCS Band (Part 24E)

Mode	Channel	Frequency (MHz)	Output Power (dBm)	Limit (dBm)
GSM	512	1850.2	30.68	33
	661	1880.0	30.21	33
	810	1909.8	29.10	33

ERP & EIRP

ERP for Cellular Band (Part 22H)

Indicated		Table Angle Degree	Test Antenna		Substituted			Antenna Gain Correction (dBd)	Cable Loss (dB)	Absolute Level (dBm)	Part 22H Limit (dBm)
Frequency (MHz)	S.A. Reading (dBµV)		Height (m)	Polar (H/V)	Frequency (MHz)	S.G. Level (dBm)	Ant. Polar (H/V)				
Low Channel											
824.2	88.78	214	1.6	H	824.2	21.4	H	0	1.0	20.4	38.45
824.2	100.96	314	1.4	V	824.2	30.7	V	0	1.0	29.7	38.45

EIRP for PCS Band (Part 24E)

Indicated		Table Angle Degree	Test Antenna		Substituted			Antenna Gain Correction (dBi)	Cable Loss (dB)	Absolute Level (dBm)	Part 24E Limit (dBm)
Frequency (MHz)	S.A. Reading (dBµV)		Height (m)	Polar (H/V)	Frequency (MHz)	S.G. Level (dBm)	Ant. Polar (H/V)				
Low Channel											
1850.2	83.51	232	1.8	H	1850.2	16.5	H	6.1	1.3	21.3	33
1850.2	88.68	154	1.6	V	1850.2	22.7	V	6.1	1.3	27.5	33

FCC §2.1049, §22.917, §22.905 & §24.238 - OCCUPIED BANDWIDTH

Applicable Standard

FCC §2.1049, §22.917, §22.905 and §24.238.

Test Procedure

The RF output of the transmitter was connected to the simulator and the spectrum analyzer through sufficient attenuation.

The resolution bandwidth of the spectrum analyzer was set at 3 kHz (Cellular /PCS) and the 26 dB & 99% bandwidth was recorded.

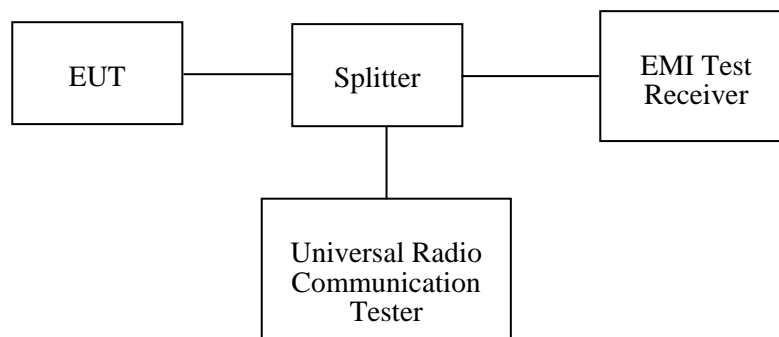

Test Equipment List and Details

Manufacturer	Description	Model	Serial Number	Calibration Date	Calibration Due Date
Rohde & Schwarz	EMI Test Receiver	ESCI	100224	2011-11-24	2012-11-23

* **Statement of Traceability:** Bay Area Compliance Laboratories Corp. (Shenzhen) attests that all calibrations have been performed in accordance to NVLAP requirements, traceable to the NIST.

Test Data

Environmental Conditions

Temperature:	25 °C
Relative Humidity:	56%
ATM Pressure:	100.0kPa

The testing was performed by Felix Li on 2012-01-13.

Please refer to the following tables and plots.

Cellular Band (Part 22H)

Channel	Frequency (MHz)	99% Occupied Bandwidth (kHz)	26 dB Occupied Bandwidth (kHz)
190	836.6	242.00	318.00

PCS Band (Part 24E)

Channel	Frequency (MHz)	99% Occupied Bandwidth (kHz)	26 dB Occupied Bandwidth (kHz)
661	1880.0	244.00	318.00

Cellular Band (Part 22H)

99% Occupied Bandwidth

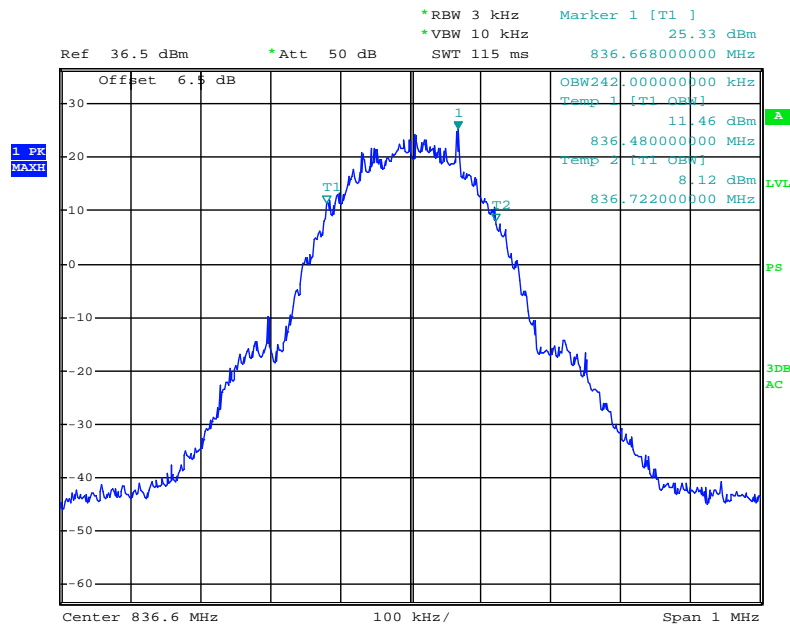

Date: 13.JAN.2012 09:04:42

26 dB Occupied Bandwidth

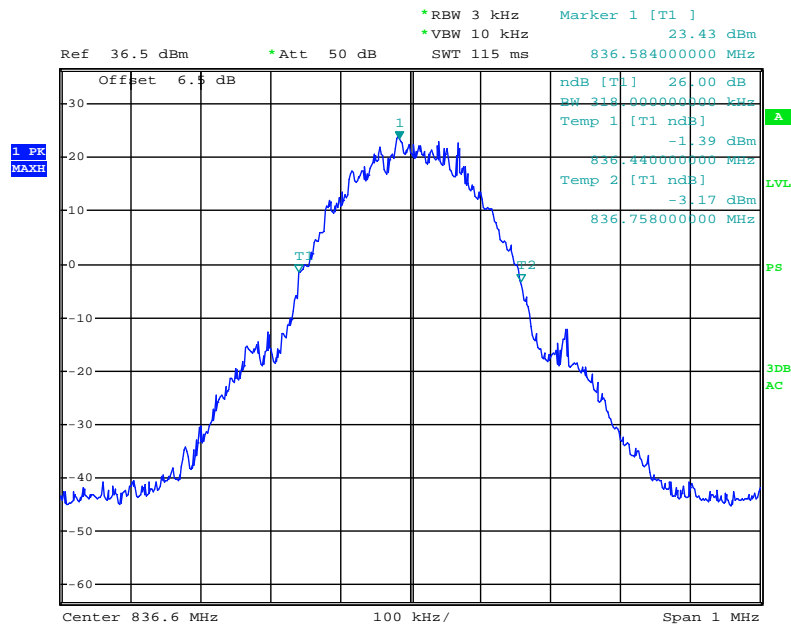

Date: 13.JAN.2012 09:05:21

PCS Band (Part 24E)

99% Occupied Bandwidth

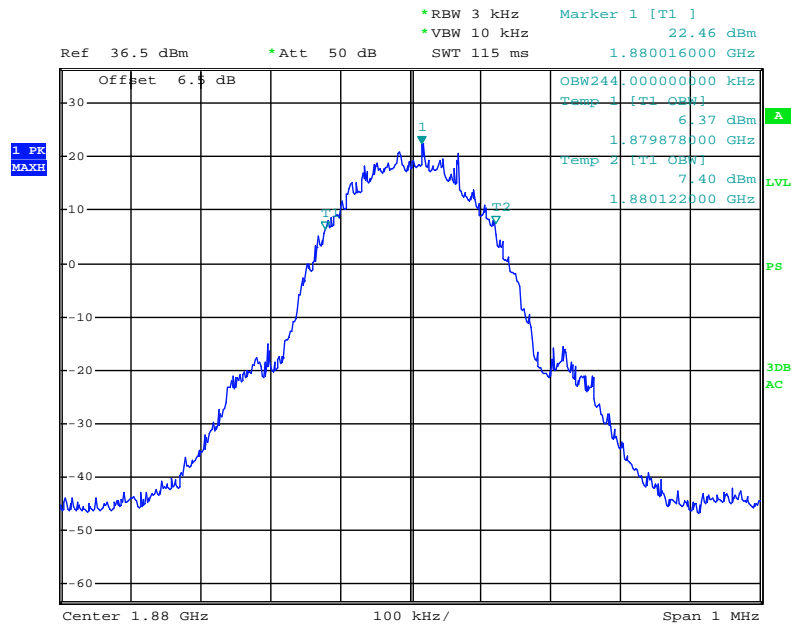

Date: 13.JAN.2012 08:22:25

26 dB Occupied Bandwidth

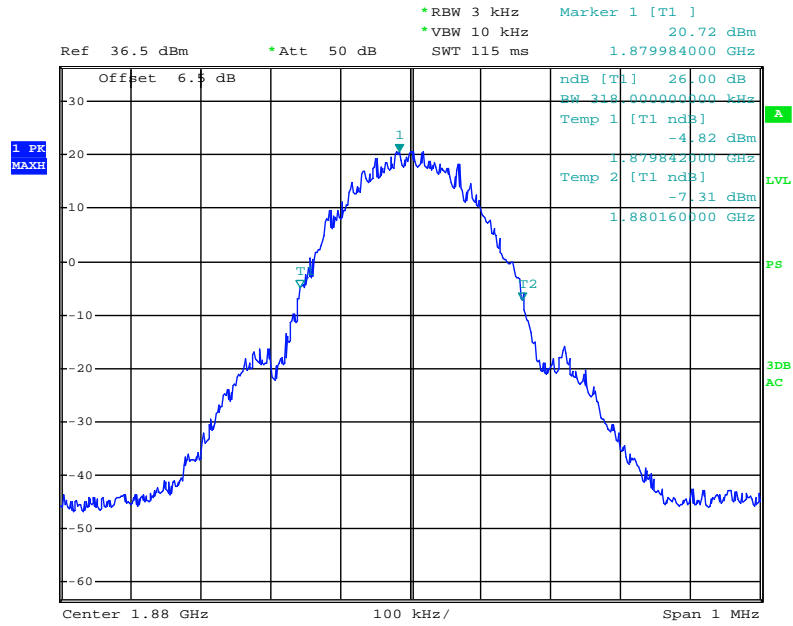

Date: 13.JAN.2012 08:23:14

FCC §2.1051, §22.917(a) & §24.238(a) - SPURIOUS EMISSIONS AT ANTENNA TERMINALS

Applicable Standard

FCC §2.1051, §22.917(a) and §24.238(a).

The spectrum was to be investigated to the tenth harmonics of the highest fundamental frequency as specified in § 2.1051.

Test Procedure

The RF output of the transceiver was connected to a spectrum analyzer and simulator through appropriate attenuation. The resolution bandwidth of the spectrum analyzer was set at 100 kHz. Sufficient scans were taken to show any out of band emissions up to 10th harmonic.

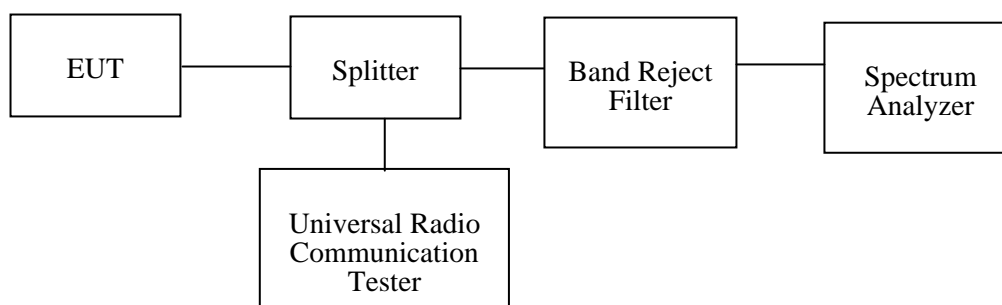

Test Equipment List and Details

Manufacturer	Description	Model	Serial Number	Calibration Date	Calibration Due Date
Rohde & Schwarz	Signal Analyzer	FSIQ 26	609358	2011-07-08	2012-07-07
Rohde & Schwarz	EMI Test Receiver	ESCI	100224	2011-11-24	2012-11-23
Wainwright Germany	Band Reject Filter	WRCG1850/191 0-1835/1925- 40/8SS	22	2011-02-28	2012-02-28
Wainwright Germany	Band Reject Filter	WRCG823/850- 813/860-40/8SS	7	2011-02-28	2012-02-28

* **Statement of Traceability:** Bay Area Compliance Laboratories Corp. (Shenzhen) attests that all calibrations have been performed in accordance to NVLAP requirements, traceable to the NIST.

Test Data

Environmental Conditions

Temperature:	25 °C
Relative Humidity:	56 %
ATM Pressure:	100.0kPa

The testing was performed by Felix Li on 2012-01-13.

Please refer to the following plots.

Cellular Band (Part 22H)-worst case

30 MHz – 1 GHz - Low Channel

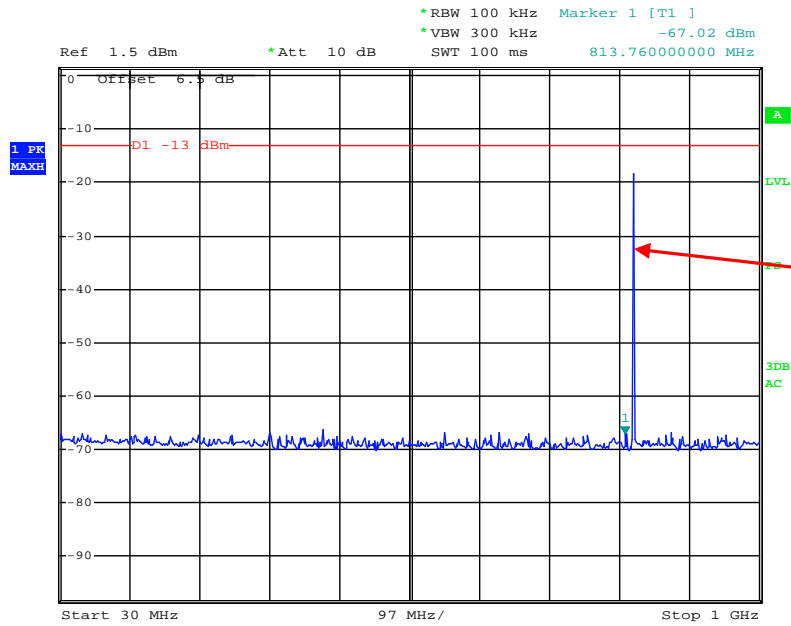

Fundamental
(with notch
Filter)

Date: 13.JAN.2012 08:41:17

1 GHz – 10 GHz – Low Channel

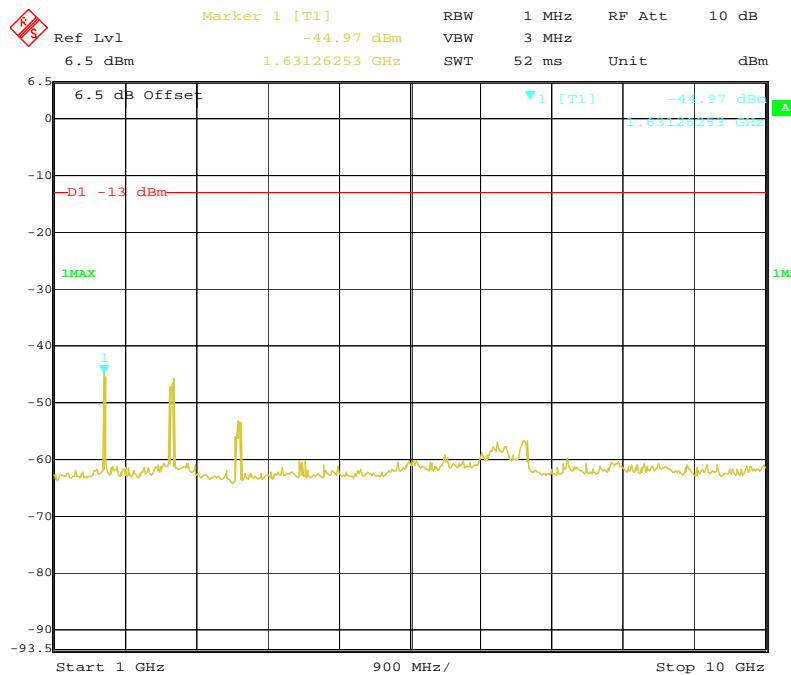

Date: 13.JAN.2012 09:40:08

PCS Band (Part 24E)-worst case

30 MHz - 1 GHz - Low Channel

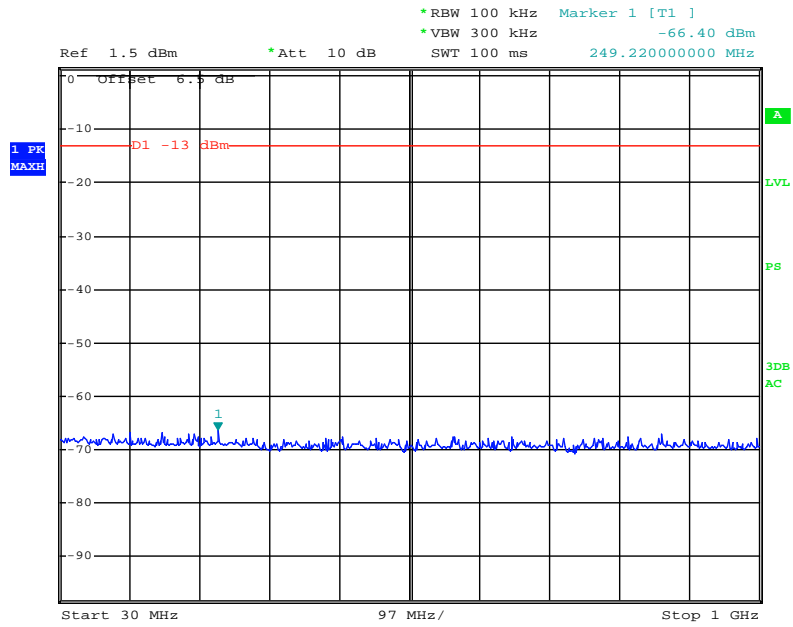

Date: 13.JAN.2012 08:35:24

1 GHz - 20 GHz - Low Channel

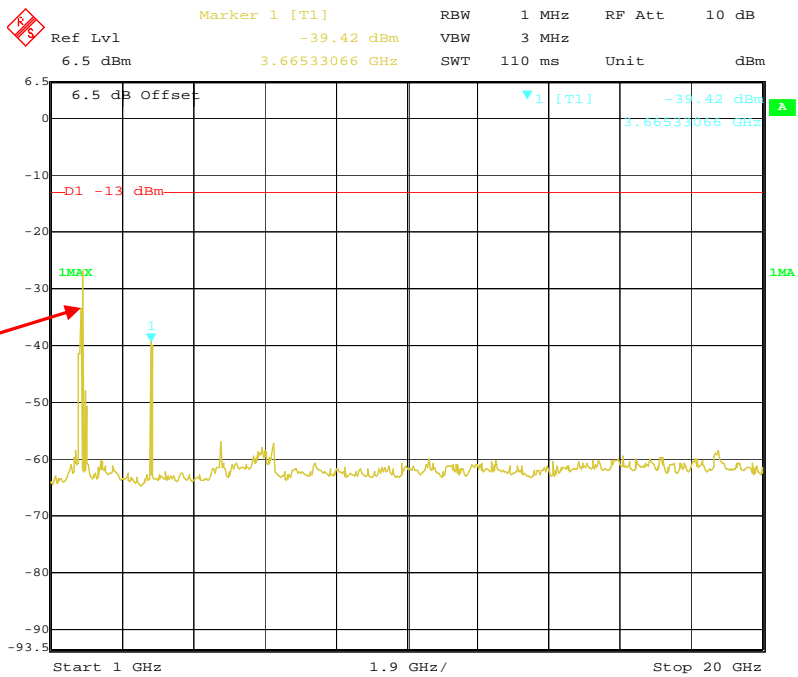

Fundamental
(with notch
Filter)

Date: 13.JAN.2012 09:43:24

FCC §2.1053, §22.917 & §24.238 - SPURIOUS RADIATED EMISSIONS

Applicable Standard

FCC §2.1053, §22.917 and §24.238.

Test Procedure

The transmitter was placed on a wooden turntable, and it was transmitting into a non-radiating load which was also placed on the turntable.

The measurement antenna was placed at a distance of 3 meters from the EUT. During the tests, the antenna height and polarization as well as EUT azimuth were varied in order to identify the maximum level of emissions from the EUT. The test was performed by placing the EUT on 3-orthogonal axis.

The frequency range up to tenth harmonic of the fundamental frequency was investigated.

Remove the EUT and replace it with substitution antenna. A signal generator was connected to the substitution antenna by a non-radiating cable. The absolute levels of the spurious emissions were measured by the substitution.

Spurious emissions in dB = $10 \lg(\text{TXpwr in Watts}/0.001)$ – the absolute level

Spurious attenuation limit in dB = $43 + 10 \text{Log}_{10}(\text{power out in Watts})$

Test Equipment List and Details

Manufacturer	Description	Model	Serial Number	Calibration Date	Calibration Due Date
Sunol Sciences	Horn Antenna	DRH-118	A052604	2011-05-05	2012-05-04
Sunol Sciences	Broadband Antenna	JB1	A040904-1	2011-07-05	2012-07-04
Rohde & Schwarz	Signal Analyzer	FSIQ 26	609358	2011-07-08	2012-07-07
Mini-Circuits	Amplifier	ZVA-213+	T-E27H	2011-03-08	2012-03-07
HP	Signal Generator	HP8657A	2849U00982	2011-10-28	2012-10-27
HP	Amplifier	HP8447D	2944A09795	2011-08-02	2012-08-02
HP	Synthesized Sweeper	8341B	2624A00116	2011-11-07	2012-11-06
COM POWER	Dipole Antenna	AD-100	041000	2011-09-25	2012-09-25
A.H. System	Horn Antenna	SAS-200/571	135	2011-05-17	2012-05-17
Electro-Mechanics	Horn Antenna	3116	9510-2270	2011-10-11	2012-10-10

* **Statement of Traceability:** Bay Area Compliance Laboratories Corp. (Shenzhen) attests that all calibrations have been performed in accordance to NVLAP requirements, traceable to the NIST.

Test Data**Environmental Conditions**

Temperature:	25 °C
Relative Humidity:	56 %
ATM Pressure:	100.0kPa

The testing was performed by Felix Li on 2012-01-13.

EUT Operation Mode: Transmitting

Cellular Band (Part 22H)

30 MHz-10 GHz:

Indicated		Table Angle Degree	Test Antenna		Substituted				Absolute Level (dBm)	Limit (dBm)	Margin (dB)
Frequency (MHz)	S.A. Reading (dBμV)		Height (m)	Polar (H/V)	Frequency (MHz)	Level (dBm)	Ant. Gain (dB)	Cable Loss (dB)			
Low Channel											
1648.4	49.35	169	2.3	H	1648.4	-52.1	6.2	1.2	-47.1	-13	34.1
1648.4	54.40	321	1.6	V	1648.4	-49.1	6.1	1.2	-44.2	-13	31.2
2472.6	47.43	180	1.1	H	2472.6	-53.9	7.4	1.5	-48.0	-13	35.0
2472.6	48.09	140	2.1	V	2472.6	-49.6	7.4	1.5	-43.7	-13	30.7
4121.0	48.40	135	1.5	H	4121.0	-48.5	7.6	2.0	-42.9	-13	29.9
4121.0	45.94	241	1.7	V	4121.0	-49.0	7.6	2.0	-43.4	-13	30.4

PCS Band (Part 24E)

30 MHz-20 GHz:

Indicated		Table Angle Degree	Test Antenna		Substituted				Absolute Level (dBm)	Limit (dBm)	Margin (dB)
Frequency (MHz)	S.A. Reading (dBμV)		Height (m)	Polar (H/V)	Frequency (MHz)	Level (dBm)	Ant. Gain (dB)	Cable Loss (dB)			
Low Channel											
3700.4	43.06	170	1.7	H	3700.4	-52.2	7.1	1.6	-46.7	-13	33.7
3700.4	43.89	314	1.9	V	3700.4	-47.1	7.1	1.6	-41.6	-13	28.6
5550.6	50.93	186	2.4	H	5550.6	-42.4	8.3	2.2	-36.3	-13	23.3
5550.6	47.67	200	2.5	V	5550.6	-44	8.3	2.2	-37.9	-13	24.9
7400.8	37.25	257	1.9	H	7400.8	-52.4	7.8	3.0	-47.6	-13	34.6
7400.8	35.24	170	1.5	V	7400.8	-55.1	7.8	3.0	-50.3	-13	37.3

FCC §22.917(a) & §24.238(a) - BAND EDGES

Applicable Standard

According to FCC §22.917(a), the power of any emissions outside of the authorized operating frequency ranges must be attenuated below the transmitting power (P) by a factor of at least $43 + 10 \log(P)$ dB.

According to FCC §24.238(a), the power of any emissions outside of the authorized operating frequency ranges must be attenuated below the transmitting power (P) by a factor of at least $43 + 10 \log(P)$ dB.

Test Procedure

The RF output of the transmitter was connected to the input of the spectrum analyzer through sufficient attenuation.

The center of the spectrum analyzer was set to block edge frequency, RBW set to 3 kHz.

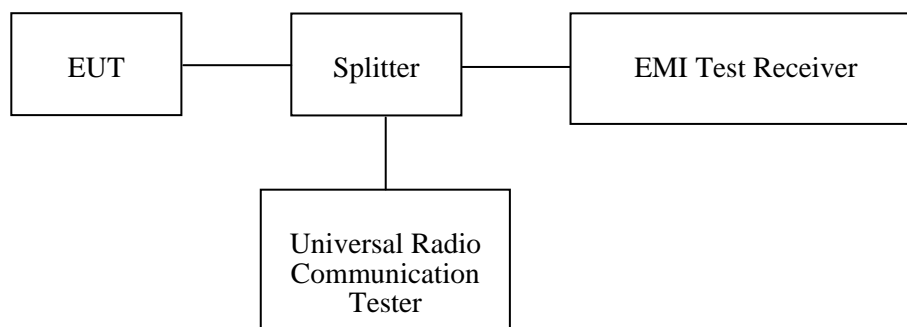

Test Equipment List and Details

Manufacturer	Description	Model	Serial Number	Calibration Date	Calibration Due Date
Rohde & Schwarz	EMI Test Receiver	ESCI	100224	2011-11-24	2012-11-23

* **Statement of Traceability:** Bay Area Compliance Laboratories Corp. (Shenzhen) attests that all calibrations have been performed in accordance to NVLAP requirements, traceable to the NIST.

Test Data

Environmental Conditions

Temperature:	25 °C
Relative Humidity:	56 %
ATM Pressure:	100.0kPa

The testing was performed by Felix Li on 2012-01-13

Please refer to the following tables and plots.

Cellular Band (Part 22H)

Frequency (MHz)	Emission (dBm)	<Limit (dBm)
823.998	-15.27	-13
849.022	-14.96	-13

PCS Band (Part 24E)

Frequency (MHz)	Emission (dBm)	<Limit (dBm)
1849.996	-15.49	-13
1910.020	-18.27	-13

Cellular Band, Left Band Edge

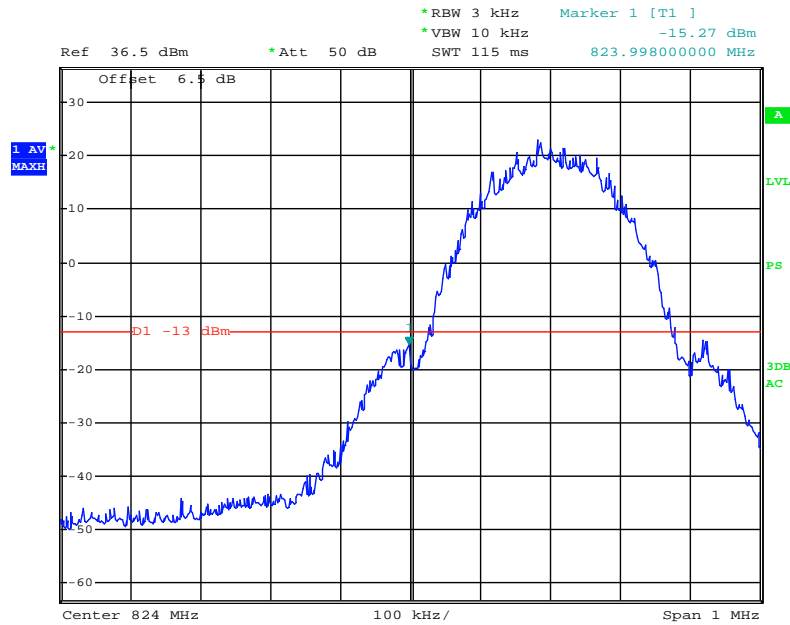

Date: 13.JAN.2012 08:56:30

Cellular Band, Right Band Edge

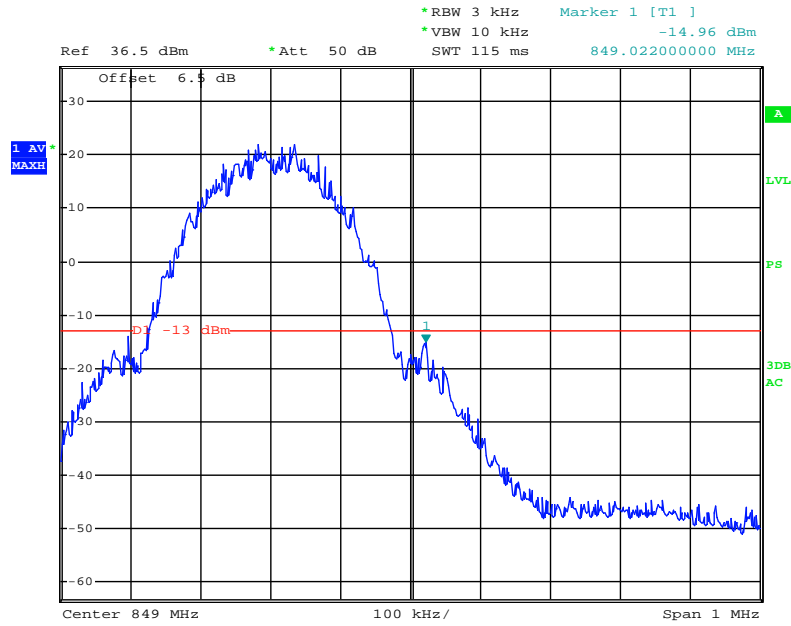

Date: 13.JAN.2012 09:02:10

PCS Band, Left Band Edge

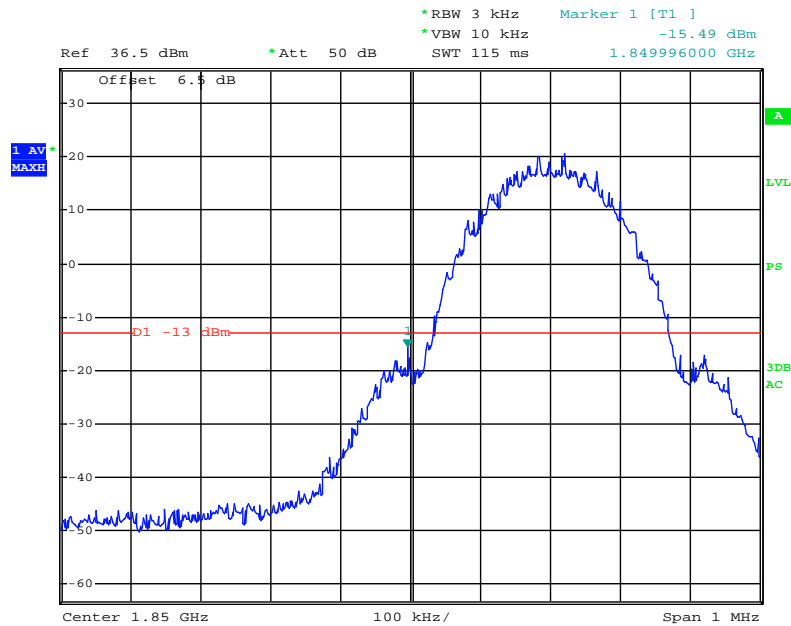

Date: 13.JAN.2012 09:08:51

PCS Band, Right Band Edge

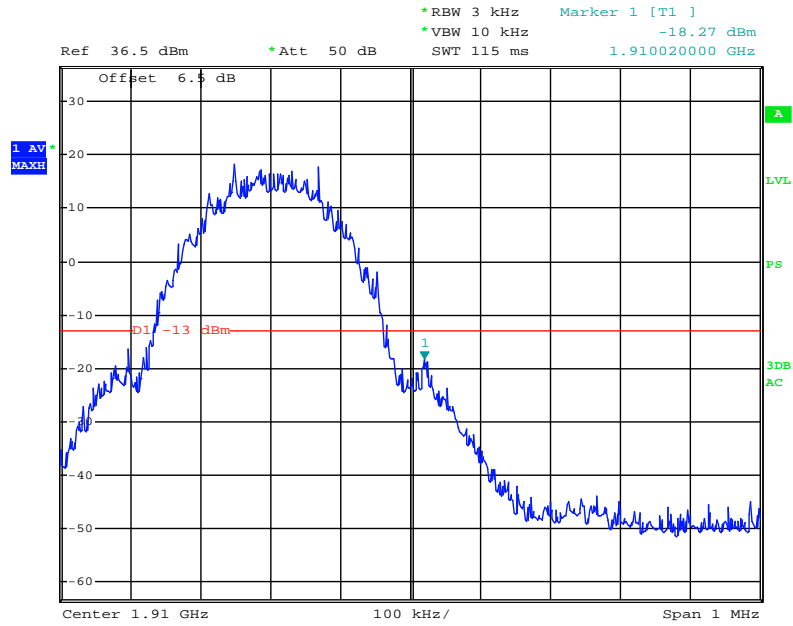

Date: 13.JAN.2012 09:09:37

FCC §2.1055, §22.355 & §24.235 - FREQUENCY STABILITY

Applicable Standard

FCC § 2.1055 (a), § 2.1055 (d), §22.355, §24.235

According to §22.355, the carrier frequency of each transmitter in the Public Mobile Services must be maintained within the tolerances given in Table below:

Frequency Tolerance for Transmitters in the Public Mobile Services

Frequency Range (MHz)	Base, fixed (ppm)	Mobile ≤ 3 watts (ppm)	Mobile ≤ 3 watts (ppm)
25 to 50	20.0	20.0	50.0
50 to 450	5.0	5.0	50.0
450 to 512	2.5	5.0	5.0
821 to 896	1.5	2.5	2.5
928 to 929.	5.0	N/A	N/A
929 to 960.	1.5	N/A	N/A
2110 to 2220	10.0	N/A	N/A

According to §24.235, the frequency stability shall be sufficient to ensure that the fundamental emissions stays within the authorized frequency block.

Test Procedure

Frequency Stability vs. Temperature: The equipment under test was connected to an external DC power supply and the RF output was connected to communication test set via feed-through attenuators. The EUT was placed inside the temperature chamber. The DC leads and RF output cable exited the chamber through an opening made for the purpose.

After the temperature stabilized for approximately 20 minutes, the frequency output was recorded from the communication test set.

Frequency Stability vs. Voltage: An external variable DC power supply was connected to the battery terminals of the equipment under test. The voltage was set to 115% of the nominal value and was then decreased until the transmitter light no longer illuminated; i.e., the battery end point. The output frequency was recorded for each battery voltage.

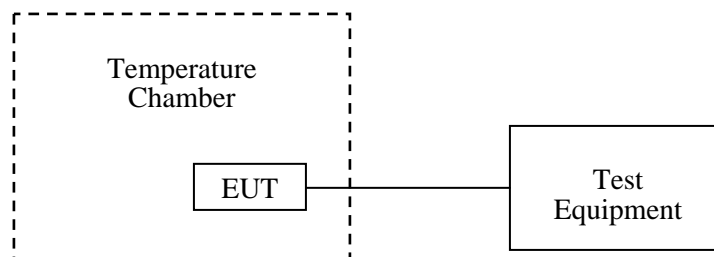

Test Equipment List and Details

Manufacturer	Description	Model	Serial Number	Calibration Date	Calibration Due Date
WUHUAN	Temperature & Humidity Chamber	HTP205	20021115	2011-06-04	2012-06-03
Rohde & Schwarz	Universal Radio Communication Tester	CMU200	109038	2011-10-28	2012-10-27

* **Statement of Traceability:** Bay Area Compliance Laboratories Corp. (Shenzhen) attests that all calibrations have been performed in accordance to NVLAP requirements, traceable to the NIST.

Test Data

Environmental Conditions

Temperature:	25 °C
Relative Humidity:	56 %
ATM Pressure:	100.0kPa

The testing was performed by Felix Li on 2012-01-13.

Cellular Band (Part 22H)

Middle Channel, $f_0 = 836.6$ MHz				
Temperature (°C)	Power Supplied (V _{DC})	Frequency Error (Hz)	Frequency Error (ppm)	Limit (ppm)
-30	3.7	-12	-0.01434	2.5
-20		-10	-0.01195	2.5
-10		-13	-0.01554	2.5
0		-10	-0.01195	2.5
10		1	0.001195	2.5
20		2	0.002391	2.5
30		-4	-0.00478	2.5
40		-9	-0.01076	2.5
50		-6	-0.00717	2.5
25		V _{max} =4.2	-11	-0.01315
	V _{min} = 3.5	-13	-0.01554	2.5

PCS Band (Part 24E)

Middle Channel, $f_0 = 1880.0$ MHz				
Temperature (°C)	Power Supplied (V _{DC})	Frequency Error (Hz)	Frequency Error (ppm)	Result
-30	3.7	-15	-0.01793	pass
-20		-10	-0.01195	pass
-10		-8	-0.00956	pass
0		-11	-0.01315	pass
10		-8	-0.00956	pass
20		8	0.009563	pass
30		3	0.003586	pass
40		13	0.015539	pass
50		-6	-0.00717	pass
25		V _{max} =4.2	-10	-0.01195
	V _{min} = 3.5	-14	-0.01673	pass

***** END OF REPORT *****