

SAR EVALUATION REPORT

For

ITALCOM GROUP

1728 Coral Way, Coral Gables, Miami, Florida, United States

FCC ID: YPVITALCOMMYQ-TV

Report Type: Original Report	Product Type: Mobile Phone
Test Engineer: Sandy Wang	<i>Sandy Wang</i>
Report Number: RSZ130626002-20	
Report Date: 2013-07-31	
Reviewed By: Alvin Huang RF Leader	<i>Alvin Huang</i>
Prepared By:	Bay Area Compliance Laboratories Corp. (Shenzhen) 6/F, the 3rd Phase of WanLi Industrial Building, ShiHua Road, FuTian Free Trade Zone Shenzhen, Guangdong, China Tel: +86-755-33320018 Fax: +86-755-33320008 www.baclcorp.com.cn

Attestation of Test Results		
EUT Information	Company Name	ITALCOM GROUP
	EUT Description	Mobile Phone
	FCC ID	FCC ID: PVITALCOMMYQ-TV
	Model Number	MyQ-tv
	Test Date	2013-07-16 to 2013-07-18 and 2013-07-30
Frequency	Max. SAR Level(s) Reported	Limit(W/Kg)
GSM 850	0.856 W/kg 1g Head SAR 0.549 W/kg 1g Body SAR	1.6
PCS 1900	0.293 W/kg 1g Head SAR 0.329 W/kg 1g Body SAR	
WCDMA 850	0.458 W/kg 1g Head SAR 0.332 W/kg 1g Body SAR	
WCDMA 1900	0.455 W/kg 1g Head SAR 0.504 W/kg 1g Body SAR	
WiFi	0.018 W/kg 1g Head SAR 0.016 W/kg 1g Body SAR	
Simultaneous	0.988 W/kg 1g Head SAR 0.593 W/kg 1g Body SAR	
Applicable Standards	ANSI / IEEE C95.1 : 2005 IEEE Standard for Safety Levels with Respect to Human Exposure to Radio Frequency Electromagnetic Fields,3 kHz to 300 GHz.	
	ANSI / IEEE C95.3 : 2002 IEEE Recommended Practice for Measurements and Computations of Radio Frequency Electromagnetic Fields With Respect to Human Exposure to SuchFields,100 kHz—300 GHz.	
	OET BULLETIN 65 SUPPLEMENT C Evaluating Compliance with FCC Guidelines for Human Exposure To Radiofrequency Electromagnetic Fields	
	IEEE1528:2003 IEEE Recommended Practice for Determining the Peak Spatial-Average Specific Absorption Rate (SAR) in the Human Head from Wireless Communications Devices: Measurement Techniques	
<p>Note: This wireless device has been shown to be capable of compliance for localized specific absorption rate (SAR) for General Population/Uncontrolled Exposure limits specified in ANSI/IEEE Standards and has been tested in accordance with the measurement procedures specified in FCC OET 65 Supplement C and IEEE 1528-2003.</p> <p>The results and statements contained in this report pertain only to the device(s) evaluated.</p>		

TABLE OF CONTENTS

DOCUMENT REVISION HISTORY	5
EUT DESCRIPTION	6
TECHNICAL SPECIFICATION	6
REFERENCE, STANDARDS, AND GUIDELINES	7
SAR LIMITS	8
FACILITIES AND ACCREDITATION	9
DESCRIPTION OF TEST SYSTEM	10
EQUIPMENT LIST AND CALIBRATION	17
EQUIPMENTS LIST & CALIBRATION INFORMATION	17
SAR MEASUREMENT SYSTEM VERIFICATION	18
LIQUID VERIFICATION	18
SYSTEM ACCURACY VERIFICATION	26
SAR SYSTEM VALIDATION DATA	27
SAR SYSTEM VALIDATION DATA	39
EUT TEST STRATEGY AND METHODOLOGY	47
TEST POSITIONS FOR DEVICE OPERATING NEXT TO A PERSON’S EAR	47
CHEEK/TOUCH POSITION	48
EAR/TILT POSITION	48
TEST POSITIONS FOR BODY-WORN AND OTHER CONFIGURATIONS	49
SAR EVALUATION PROCEDURE	50
CONDUCTED OUTPUT POWER MEASUREMENT	51
PROVISION APPLICABLE	51
TEST PROCEDURE	51
MAXIMUM OUTPUT POWER AMONG PRODUCTION UNITS	51
SAR MEASUREMENT RESULTS	58
SAR TEST DATA	58
SAR SIMULTANEOUS TRANSMISSION DESCRIPTION	63
EUT SCAN RESULTS	68
APPENDIX A MEASUREMENT UNCERTAINTY	108
APPENDIX B PROBE CALIBRATION CERTIFICATES	109
APPENDIX C DIPOLE CALIBRATION CERTIFICATES	119
APPENDIX D EUT TEST POSITION PHOTOS	149
LIQUID DEPTH \geq 15CM	149
BODY-WORN-HEADSET FRONT SETUP PHOTO	149
BODY-WORN-HEADSET BACK SETUP PHOTO	150
BODY-RIGHT SETUP PHOTO	150
BODY-TOP SETUP PHOTO	151
LEFT HEAD TOUCH SETUP PHOTO	151
LEFT HEAD TILT SETUP PHOTO	152
RIGHT HEAD TOUCH SETUP PHOTO	152
RIGHT HEAD TILT SETUP PHOTO	153
APPENDIX E EUT PHOTOS	154
EUT – FRONT VIEW	154
EUT – BACK VIEW	154

EUT – LEFT SIDE VIEW 155
EUT – RIGHT SIDE VIEW 155
EUT –TOP VIEW 156
EUT –BOTTOM VIEW 156
EUT –ANTENNA VIEW 157
EUT –UNCOVERED VIEW 157
APPENDIX F INFORMATIVE REFERENCES 158

DOCUMENT REVISION HISTORY

Revision Number	Report Number	Description of Revision	Date of Revision
0	RSZ130626002-20	Original Report	2013-07-31

EUT DESCRIPTION

This report has been prepared on behalf of ITALCOM GROUP and their product, FCC ID: YPVITALCOMMYQ-TV, Model: MyQ-tv or the EUT (Equipment under Test) as referred to in the rest of this report. The EUT is a Mobile Phone.

Technical Specification

Product Type	Portable
Exposure Category:	Population / Uncontrolled
Antenna Type(s):	Internal Antenna
Body-Worn Accessories:	Headset
Face-Head Accessories:	None
Hotspot:	Not support
Multi-slot Class:	Class12
Operation Mode :	GSM Voice , GPRS Data, WCDMA , Bluetooth and WiFi
Frequency Band:	Cellular Band : 824-849 MHz(TX) ; 869-894 MHz(RX) PCS Band : 1850-1910 MHz(TX) ; 1930-1990 MHz(RX) WCDMA850 : 824-849 MHz(TX) ; 869-894 MHz(RX) WCDMA1900 : 1850-1910 MHz(TX) ; 1930-1990 MHz(RX) WiFi: 2412-2462 MHz Bluetooth : 2400MHz-2483.5MHz
Conducted RF Power:	Cellular Band :32.05dBm PCS Band : 30.10dBm WCDMA850 : 23.14dBm WCDMA1900 : 22.87dBm Bluetooth : 4.85dBm WiFi : 15.85dBm
Dimensions (L*W*H):	104.0mm (L)× 60.0mm (W)× 14.0mm (H)
Weight:	85.7g
Power Source:	3.7VDC/800mAh Rechargeable Battery
Normal Operation:	Head and Body-worn

REFERENCE, STANDARDS, AND GUIDELINES

FCC:

The Report and Order requires routine SAR evaluation prior to equipment authorization of portable transmitter devices, including portable telephones. For consumer products, the applicable limit is 1.6 mW/g as recommended by the ANSI/IEEE standard C95.1-1992 [6] for an uncontrolled environment (Paragraph 65). According to the Supplement C of OET Bulletin 65 "Evaluating Compliance with FCC Guide-lines for Human Exposure to Radio frequency Electromagnetic Fields", released on Jun 29, 2001 by the FCC, the device should be evaluated at maximum output power (radiated from the antenna) under "worst-case" conditions for normal or intended use, incorporating normal antenna operating positions, device peak performance frequencies and positions for maximum RF energy coupling.

This report describes the methodology and results of experiments performed on wireless data terminal. The objective was to determine if there is RF radiation and if radiation is found, what is the extent of radiation with respect to safety limits. SAR (Specific Absorption Rate) is the measure of RF exposure determined by the amount of RF energy absorbed by human body (or its parts) – to determine how the RF energy couples to the body or head which is a primary health concern for body worn devices. The limit below which the exposure to RF is considered safe by regulatory bodies in North America is 1.6 mW/g average over 1 gram of tissue mass.

CE:

The order requires routine SAR evaluation prior to equipment authorization of portable transmitter devices, including portable telephones. For consumer products, the applicable limit is 2 mW/g as recommended by EN62209-1 for an uncontrolled environment. According to the Standard, the device should be evaluated at maximum output power (radiated from the antenna) under "worst-case" conditions for normal or intended use, incorporating normal antenna operating positions, device peak performance frequencies and positions for maximum RF energy coupling.

This report describes the methodology and results of experiments performed on wireless data terminal. The objective was to determine if there is RF radiation and if radiation is found, what is the extent of radiation with respect to safety limits. SAR (Specific Absorption Rate) is the measure of RF exposure determined by the amount of RF energy absorbed by human body (or its parts) – to determine how the RF energy couples to the body or head which is a primary health concern for body worn devices. The limit below which the exposure to RF is considered safe by regulatory bodies in Europe is 2 mW/g average over 10 gram of tissue mass.

The test configurations were laid out on a specially designed test fixture to ensure the reproducibility of measurements. Each configuration was scanned for SAR. Analysis of each scan was carried out to characterize the above effects in the device.

SAR Limits

FCC Limit (1g Tissue)

EXPOSURE LIMITS	SAR (W/kg)	
	(General Population / Uncontrolled Exposure Environment)	(Occupational / Controlled Exposure Environment)
Spatial Average (averaged over the whole body)	0.08	0.4
Spatial Peak (averaged over any 1 g of tissue)	1.60	8.0
Spatial Peak (hands/wrists/feet/ankles averaged over 10 g)	4.0	20.0

CE Limit (10g Tissue)

EXPOSURE LIMITS	SAR (W/kg)	
	(General Population / Uncontrolled Exposure Environment)	(Occupational / Controlled Exposure Environment)
Spatial Average (averaged over the whole body)	0.08	0.4
Spatial Peak (averaged over any 10 g of tissue)	2.0	10
Spatial Peak (hands/wrists/feet/ankles averaged over 10 g)	4.0	20.0

Population/Uncontrolled Environments are defined as locations where there is the exposure of individual who have no knowledge or control of their exposure.

Occupational/Controlled Environments are defined as locations where there is exposure that may be incurred by people who are aware of the potential for exposure (i.e. as a result of employment or occupation).

General Population/Uncontrolled environments Spatial Peak limit 1.6W/kg (FCC) & 2 W/kg (CE) applied to the EUT.

FACILITIES AND ACCREDITATION

The test site used by Bay Area Compliance Laboratories Corp. (Shenzhen) to collect data is located at 6/F, the 3rd Phase of WanLi Industrial Building, Shi Hua Road, Fu Tian Free Trade Zone, Shenzhen, Guangdong, P.R. of China

DESCRIPTION OF TEST SYSTEM

These measurements were performed with ALSAS 10 Universal Integrated SAR Measurement system from APREL Laboratories.

ALSAS-10U System Description

ALSAS-10-U is fully compliant with the technical and scientific requirements of IEEE 1528, IEC 62209, CENELEC, ARIB, ACA, and the Federal Communications Commission. The system comprises of a six axes articulated robot which utilizes a dedicated controller.

ALSAS-10U uses the latest methodologies. And FDTD modeling to provide a platform which is repeatable with minimum uncertainty.

Applications

Predefined measurement procedures compliant with the guidelines of CENELEC, IEEE, IEC, FCC, etc are utilized during the assessment for the device. Automatic detection for all SAR maxima are embedded within the core architecture for the system, ensuring that peak locations used for centering the zoom scan are within a 1mm resolution and a 0.05mm repeatable position. System operation range currently available up-to 6 GHz in simulated tissue.

Area Scans

Area scans are defined prior to the measurement process being executed with a user defined variable spacing between each measurement point (integral) allowing low uncertainty measurements to be conducted. Scans defined for FCC applications utilize a 10mm² step integral, with 1mm interpolation used to locate the peak SAR area used for zoom scan assessments.

Where the system identifies multiple SAR peaks (which are within 25% of peak value) the system will provide the user with the option of assessing each peak location individually for zoom scan averaging.

Zoom Scan (Cube Scan Averaging)

The averaging zoom scan volume utilized in the ALSAS-10U software is in the shape of a cube and the side dimension of a 1 g or 10 g mass is dependent on the density of the liquid representing the simulated tissue. A density of 1000 kg/m³ is used to represent the head and body tissue density and not the phantom liquid density, in order to be consistent with the definition of the liquid dielectric properties, i.e. the side length of the 1 g cube is 10mm, with the side length of the 10 g cube 21,5mm.

When the cube intersects with the surface of the phantom, it is oriented so that 3 vertices touch the surface of the shell or the center of a face is tangent to the surface. The face of the cube closest to the surface is modified in order to conform to the tangent surface.

The zoom scan integer steps can be user defined so as to reduce uncertainty, but normal practice for typical test applications (including FCC) utilize a physical step of 5x5x8 (8mmx8mmx5mm) providing a volume of 32mm³ in the X & Y axis, and 35mm in the Z axis.



ALSAS-10U Interpolation and Extrapolation Uncertainty

The overall uncertainty for the methodology and algorithms the used during the SAR calculation was evaluated using the data from IEEE 1528 based on the example f3 algorithm:

$$f_3(x, y, z) = A \frac{a^2}{\frac{a^2}{4} + x'^2 + y'^2} \cdot \left(e^{-\frac{2z}{a}} + \frac{a^2}{2(a + 2z)^2} \right)$$

Isotropic E-Field Probe

The isotropic E-Field probe has been fully calibrated and assessed for isotropicity, and boundary effect within a controlled environment. Depending on the frequency for which the probe is calibrated the method utilized for calibration will change.

The E-Field probe utilizes a triangular sensor arrangement as detailed in the diagram below:

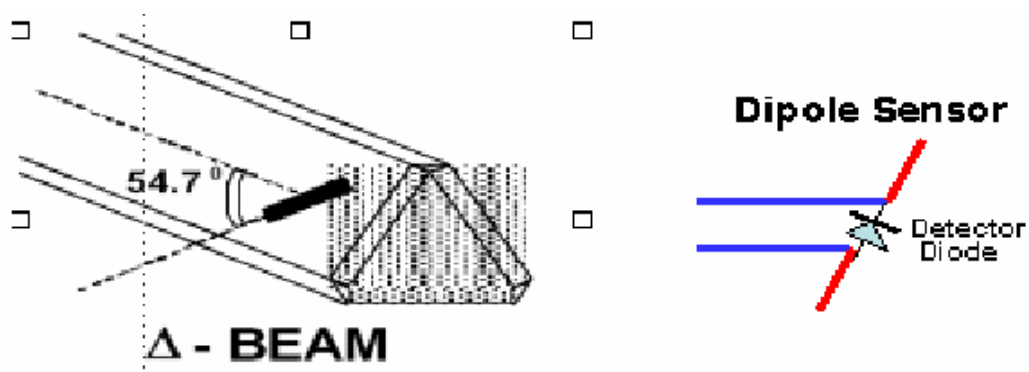

SAR is assessed with a calibrated probe which moves at a default height of 5mm from the center of the diode, which is mounted to the sensor, to the phantom surface (in the Z Axis). The 5mm offset height has been selected so as to minimize any resultant boundary effect due to the probe being in close proximity to the phantom surface.

The following algorithm is an example of the function used by the system for linearization of the output from the probe when measuring complex modulation schemes.

$$V_i = U_i + U_i^2 \cdot \frac{cf}{dcp_i}$$

Isotropic E-Field Probe Specification

Calibration Method	Frequency Dependent Below 1 GHz Calibration in air performed in a TEM Cell Above 1 GHz Calibration in air performed in waveguide
Sensitivity	0.70 $\mu\text{V}/(\text{V}/\text{m})^2$ to 0.85 $\mu\text{V}/(\text{V}/\text{m})^2$
Dynamic Range	0.0005 W/kg to 100 W/kg
Isotropic Response	Better than 0.1 dB
Diode Compression Point (DCP)	Calibration for Specific Frequency
Probe Tip Diameter	< 2.9 mm
Sensor Offset	1.56 (+/- 0.02 mm)
Probe Length	289 mm
Video Bandwidth	@ 500 Hz: 1 dB @ 1.02 kHz: 3 dB
Boundary Effect	Less than 2.1% for distance greater than 0.58 mm
Spatial Resolution	The spatial resolution uncertainty is less than 1.5% for 4.9mm diameter probe. The spatial resolution uncertainty is less than 1.0% for 2.5mm diameter probe

Boundary Detection Unit and Probe Mounting Device

ALSAS-10U incorporates a boundary detection unit with a sensitivity of 0.05mm for detecting all types of surfaces. The robust design allows for detection during probe tilt (probe normalize) exercises, and utilizes a second stage emergency stop. The signal electronics are fed directly into the robot controller for high accuracy surface detection in lateral and axial detection modes (X, Y, & Z).

The probe is mounted directly onto the Boundary Detection unit for accurate tooling and displacement calculations controlled by the robot kinematics. The probe is connect to an isolated probe interconnect where the output stage of the probe is fed directly into the amplifier stage of the Daq-Paq.

Daq-Paq (Analog to Digital Electronics)

ALSAS-10U incorporates a fully calibrated Daq-Paq (analog to digital conversion system) which has a 4 channel input stage, sent via a 2 stage auto-set amplifier module. The input signal is amplified accordingly so as to offer a dynamic range from 5 μV to 800mV. Integration of the fields measured is carried out at board level utilizing a Co-Processor which then sends the measured fields down into the main computational module in digitized form via an RS232 communications port. Probe linearity and duty cycle compensation is carried out within the main Daq-Paq module.

ADC	12 Bit
Amplifier Range	20 mV to 200 mV and 150 mV to 800 mV
Field Integration	Local Co-Processor utilizing proprietary integration algorithms
Number of Input Channels	4 in total 3 dedicated and 1 spare
Communication	Packet data via RS232

Axis Articulated Robot

ALSAS-10U utilizes a six axis articulated robot, which is controlled using a Pentium based real-time movement controller. The movement kinematics engine utilizes proprietary (Thermo CRS) interpolation and extrapolation algorithms, which allow full freedom of movement for each of the six joints within the working envelope. Utilization of joint 6 allows for full probe rotation with a tolerance better than 0.05mm around the central axis.



Robot/Controller Manufacturer	Thermo CRS
Number of Axis	Six independently controlled axis
Positioning Repeatability	0.05 mm
Controller Type	Single phase Pentium based C500C
Robot Reach	710 mm
Communication	RS232 and LAN compatible

ALSAS Universal Workstation

ALSAS Universal workstation allows for repeatability and fast adaptability. It allows users to do calibration, testing and measurements using different types of phantoms with one set up, which significantly speeds up the measurement process.

Universal Device Positioner

The universal device positioner allows complete freedom of movement of the EUT. Developed to hold a EUT in a free-space scenario any additional loading attributable to the material used in the construction of the positioner has been eliminated. Repeatability has been enhanced through the linear scales which form the design used to indicate positioning for any given test scenario in all major axes. A 15° tilt indicator is included for the of aid cheek to tilt movements for head SAR analysis. Overall uncertainty for measurements have been reduced due to the design of the Universal device positioner, which allows positioning of a device in as near to a free-space scenario as possible, and by providing the means for complete repeatability.



Phantom Types

The ALSAS-10U allows the integration of multiple phantom types. SAM Phantoms fully compliant with IEEE 1528, Universal Phantom, and Universal Flat.

APREL SAM Phantoms

The SAM phantoms developed using the IEEE SAM CAD file. They are fully compliant with the requirements for both IEEE 1528 and FCC Supplement C. Both the left and right SAM phantoms are interchangeable, transparent and include the IEEE 1528 grid with visible NF and MB lines.

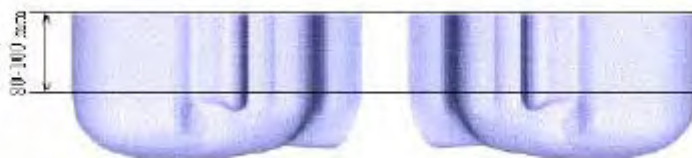

APREL Laboratories Universal Phantom

The Universal Phantom is used on the ALSAS-10U as a system validation phantom. The Universal Phantom has been fully validated both experimentally from 800MHz to 6GHz and numerically using XFDTD numerical software.

The shell thickness is 2mm overall, with a 4mm spacer located at the NF/MB intersection providing an overall thickness of 6mm in line with the requirements of IEEE-1528.

The design allows for fast and accurate measurements, of handsets, by allowing the conservative SAR to be evaluated at on frequency for both left and right head experiments in one measurement.



Tissue Dielectric Parameters for Head and Body Phantoms

The head tissue dielectric parameters recommended by the IEEE SCC-34/SC-2 in P1528 have been incorporated in the following table. These head parameters are derived from planar layer models simulating the highest expected SAR for the dielectric properties and tissue thickness variations in a human head. Other head and body tissue parameters that have not been specified in P1528 are derived from the tissue dielectric parameters computed from the 4-Cole-Cole equations described in Reference [12] and extrapolated according to the head parameters specified in P1528.

Ingredients (% by weight)	Frequency (MHz)									
	450		835		915		1900		2450	
Tissue Type	Head	Body	Head	Body	Head	Body	Head	Body	Head	Body
Water	38.56	51.16	41.45	52.4	41.05	56.0	54.9	40.4	62.7	73.2
Salt (Nacl)	3.95	1.49	1.45	1.4	1.35	0.76	0.18	0.5	0.5	0.04
Sugar	56.32	46.78	56.0	45.0	56.5	41.76	0.0	58.0	0.0	0.0
HEC	0.98	0.52	1.0	1.0	1.0	1.21	0.0	1.0	0.0	0.0
Bactericide	0.19	0.05	0.1	0.1	0.1	0.27	0.0	0.1	0.0	0.0
Triton x-100	0.0	0.0	0.0	0.0	0.0	0.0	0.0	0.0	36.8	0.0
DGBE	0.0	0.0	0.0	0.0	0.0	0.0	44.92	0.0	0.0	26.7
Dielectric Constant	43.42	58.0	42.54	56.1	42.0	56.8	39.9	54.0	39.8	52.5
Conductivity (s/m)	0.85	0.83	0.91	0.95	1.0	1.07	1.42	1.45	1.88	1.78

Recommended Tissue Dielectric Parameters for Head and Body

Frequency (MHz)	Head Tissue		Body Tissue	
	ϵ_r	σ (S/m)	ϵ_r	σ (S/m)
150	52.3	0.76	61.9	0.80
300	45.3	0.87	58.2	0.92
450	43.5	0.87	56.7	0.94
835	41.5	0.90	55.2	0.97
900	41.5	0.97	55.0	1.05
915	41.5	0.98	55.0	1.06
1450	40.5	1.20	54.0	1.30
1610	40.3	1.29	53.8	1.40
1800-2000	40.0	1.40	53.3	1.52
2450	39.2	1.80	52.7	1.95
3000	38.5	2.40	52.0	2.73
5800	35.3	5.27	48.2	6.00

EQUIPMENT LIST AND CALIBRATION

Equipments List & Calibration Information

Equipment	Model	Calibration Date	S/N
CRS F3 robot	ALS-F3	N/A	RAF0805352
CRS F3 Software	ALS-F3-SW	N/A	N/A
CRS C500C controller	ALS-C500	N/A	RCF0805379
Probe mounting device & Boundary Detection Sensor System	ALS-PMDPS-3	N/A	120-00270
Universal Work Station	ALS-UWS	N/A	100-00157
Data Acquisition Package	ALS-DAQ-PAQ-3	2013-05-12	110-00212
Miniature E-Field Probe	ALS-E-020	2012-08-08	500-00283
Dipole, 835MHz	ALS-D-835-S-2	2011-08-25	180-00558
Dipole, 1900MHz	ALS-D-1900-S-2	2011-08-25	210-00710
Dipole, 2450MHz	ALS-D-2450-S-2	2011-08-25	220-00758
Dipole Spacer	ALS-DS-U	N/A	250-00907
Device holder/Positioner	ALS-H-E-SET-2	N/A	170-00510
Left ear SAM phantom	ALS-P-SAM-L	N/A	130-00311
Right ear SAM phantom	ALS-P-SAM-R	N/A	140-00359
UniPhantom	ALS-P-UP-1	N/A	150-00413
Simulated Tissue 835 MHz Head	ALS-TS-835-H	Each Time	270-01002
Simulated Tissue 835 MHz Body	ALS-TS-835-B	Each Time	270-02101
Simulated Tissue 1900 MHz Head	ALS-TS-1900-H	Each Time	295-01103
Simulated Tissue 1900 MHz Body	ALS-TS-1900-B	Each Time	295-02102
Simulated Tissue 2450 MHz Head	ALS-TS-2450-H	Each Time	296-01001
Simulated Tissue 2450 MHz Body	ALS-TS-2450-B	Each Time	296-01002
Power Amplifier	5S1G4	N/A	71377
Synthesized Sweeper	HP 8341B	2013-05-16	2624A00116
UNIVERSAL RADIO COMMUNICATION TESTER	CMU 200	2012-12-06	1100.0008.02
EMI Test Receiver	ESCI	2012-08-08	101122

SAR MEASUREMENT SYSTEM VERIFICATION

Liquid Verification

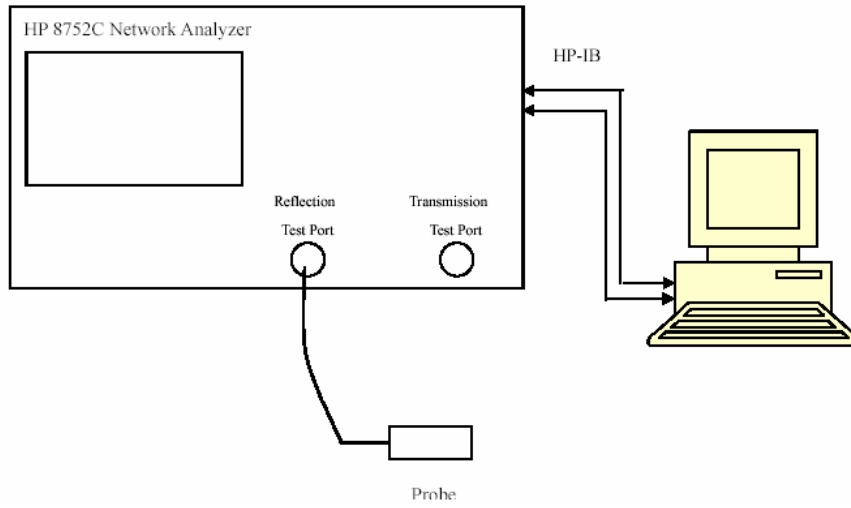

Liquid Verification Setup Block Diagram

Liquid Verification Results 1

Frequency	Liquid Type	Liquid Parameter		Target Value		Delta (%)		Tolerance (%)
		ϵ_r	σ (S/m)	ϵ_r	σ (S/m)	$\Delta\epsilon_r$	$\Delta\sigma$ (S/m)	
824.2	Head	41.09	0.90	41.50	0.90	-0.988	0.000	±5
	Body	55.14	0.95	55.20	0.97	-0.109	-2.062	±5
826.4	Head	40.96	0.90	41.50	0.90	-1.301	0.000	±5
	Body	55.15	0.95	55.20	0.97	-0.091	-2.062	±5
836.6	Head	41.03	0.91	41.50	0.90	-1.133	1.111	±5
	Body	55.21	0.97	55.20	0.97	0.018	0.000	±5
846.6	Head	40.88	0.93	41.50	0.90	-1.494	3.333	±5
	Body	55.28	0.98	55.20	0.97	0.145	1.031	±5
848.8	Head	40.80	0.93	41.50	0.90	-1.687	3.333	±5
	Body	55.29	0.99	55.20	0.97	0.163	2.062	±5
1850.2	Head	40.12	1.38	40.00	1.40	0.300	-1.429	±5
	Body	54.11	1.49	53.30	1.52	1.520	-1.974	±5
1852.4	Head	40.12	1.38	40.00	1.40	0.300	-1.429	±5
	Body	54.02	1.49	53.30	1.52	1.351	-1.974	±5
1880.0	Head	40.17	1.40	40.00	1.40	0.425	0.000	±5
	Body	53.86	1.51	53.30	1.52	1.051	-0.658	±5
1907.6	Head	40.27	1.42	40.00	1.40	0.675	1.429	±5
	Body	53.83	1.55	53.30	1.52	0.994	1.974	±5
1909.8	Head	40.27	1.42	40.00	1.40	0.675	1.429	±5
	Body	53.94	1.54	53.30	1.52	1.201	1.316	±5
2412	Head	40.12	1.79	39.20	1.80	2.347	-0.556	±5
	Body	51.88	1.93	52.70	1.95	-1.556	-1.026	±5
2437	Head	40.17	1.81	39.20	1.80	2.474	0.556	±5
	Body	51.69	1.98	52.70	1.95	-1.917	1.538	±5
2462	Head	40.28	1.83	39.20	1.80	2.755	1.667	±5
	Body	51.52	2.01	52.70	1.95	-2.239	3.077	±5

*Liquid Verification was performed on 2013-7-16.

Please refer to the following tables.

850 MHz Head				850 MHz Body		
Frequency (MHz)	e'	e''		Frequency (MHz)	e'	e''
824.0	41.085949	19.632533		824.0	55.135353	20.653224
824.5	41.045834	19.634391		824.5	55.138491	20.552735
825.0	41.029174	19.634945		825.0	55.141624	20.565253
825.5	40.924034	19.635499		825.5	55.144767	20.577687
826.0	40.942392	19.636054		826.0	55.147905	20.712749
826.5	40.964285	19.636607		826.5	55.151043	20.776480
827.0	40.940772	19.637161		827.0	55.154181	20.690979
827.5	40.988093	19.637715		827.5	55.157319	20.569115
828.0	41.007699	19.638269		828.0	55.160457	20.603677
828.5	41.014125	19.638824		828.5	55.163595	20.561100
829.0	41.065056	19.639377		829.0	55.166733	20.665255
829.5	41.013549	19.639932		829.5	55.169871	20.608084
830.0	41.049917	19.640486		830.0	55.173009	20.485981
830.5	41.009946	19.641040		830.5	55.176147	20.550369
831.0	40.982944	19.641594		831.0	55.179285	20.535544
831.5	41.002499	19.642148		831.5	55.182423	20.742968
832.0	40.964317	19.642702		832.0	55.185561	20.720632
832.5	40.939141	19.643256		832.5	55.188699	20.497331
833.0	40.979677	19.643810		833.0	55.191837	20.430695
833.5	41.011096	19.644364		833.5	55.194975	20.542162
834.0	41.008521	19.644918		834.0	55.198113	20.694019
834.5	41.007101	19.645474		834.5	55.201251	20.586981
835.0	41.031930	19.646027		835.0	55.205389	20.530440
835.5	41.032930	19.646882		835.5	55.207527	20.778147
836.0	41.036530	19.647737		836.0	55.210665	20.785070
836.5	41.025562	19.648592		836.5	55.213803	20.642877
837.0	41.008359	19.649448		837.0	55.216941	20.469960
837.5	41.002566	19.650306		837.5	55.220079	20.506226
838.0	41.025739	19.651158		838.0	55.223217	20.790509
838.5	40.984269	19.652015		838.5	55.226355	20.805713
839.0	40.974200	19.652869		839.0	55.229493	20.727725
839.5	40.976670	19.653724		839.5	55.232631	20.662683
840.0	40.987737	19.654579		840.0	55.235768	20.729826
840.5	40.977099	19.655434		840.5	55.238906	20.775190
841.0	40.960371	19.656290		841.0	55.242044	20.730318
841.5	40.989813	19.657145		841.5	55.245182	20.667055
842.0	40.991515	19.658000		842.0	55.248320	20.842895
842.5	40.995211	19.658855		842.5	55.251458	20.811408
843.0	40.989306	19.649677		843.0	55.254596	20.771806
843.5	40.913009	19.650528		843.5	55.257734	20.727317
844.0	40.989261	19.651384		844.0	55.260872	20.744975
844.5	40.943552	19.652238		844.5	55.264010	20.770882
845.0	40.869570	19.653097		845.0	55.267148	20.680300
845.5	40.884872	19.653949		845.5	55.270286	20.626686
846.0	40.839455	19.674880		846.0	55.273424	20.799687
846.5	40.880394	19.675735		846.5	55.276562	20.861091
847.0	40.860663	19.676591		847.0	55.279700	20.809950
847.5	40.863847	19.677446		847.5	55.282838	20.730251
848.0	40.837449	19.678301		848.0	55.285976	20.820408
848.5	40.842044	19.679156		848.5	55.289114	20.898492
849.0	40.802312	19.680011		849.0	55.292252	20.898674

1900 MHz Head				1900 MHz Body		
Frequency (MHz)	e'	e''		Frequency (MHz)	e'	e''
1850.0	40.118288	13.373321		1850.0	54.107845	14.460056
1851.2	40.117289	13.373519		1851.2	54.039764	14.417473
1852.4	40.115291	13.373717		1852.4	54.024608	14.418577
1853.6	40.113293	13.373915		1853.6	54.035191	14.394850
1854.8	40.114292	13.374113		1854.8	53.938027	14.414333
1856.0	40.115291	13.374311		1856.0	54.041050	14.450754
1857.2	40.116290	13.374509		1857.2	54.034221	14.476739
1858.4	40.117289	13.374707		1858.4	54.016235	14.397955
1859.6	40.118288	13.374905		1859.6	53.997906	14.392298
1860.8	40.122284	13.375103		1860.8	53.893697	14.445094
1862.0	40.126280	13.375301		1862.0	53.921373	14.272297
1863.2	40.130276	13.375499		1863.2	53.867354	14.285102
1864.4	40.134272	13.375697		1864.4	53.902106	14.302185
1865.6	40.138268	13.375895		1865.6	53.908579	14.273220
1866.8	40.142264	13.376093		1866.8	53.983589	14.263790
1868.0	40.146260	13.376291		1868.0	54.052033	14.279863
1869.2	40.150256	13.376489		1869.2	54.061095	14.302289
1870.4	40.154252	13.376687		1870.4	53.974593	14.353740
1871.6	40.158248	13.376885		1871.6	53.916973	14.354449
1872.8	40.162244	13.377083		1872.8	53.955407	14.383439
1874.0	40.163243	13.377281		1874.0	53.881872	14.391748
1875.2	40.164242	13.377479		1875.2	53.945035	14.455005
1876.4	40.165241	13.377677		1876.4	53.848150	14.377786
1877.6	40.166240	13.377875		1877.6	53.950433	14.457827
1878.8	40.167239	13.378073		1878.8	53.978220	14.589663
1880.0	40.168238	13.378271		1880.0	53.860541	14.608618
1881.2	40.171235	13.378469		1881.2	53.818781	14.605654
1882.4	40.174232	13.378667		1882.4	53.914323	14.577032
1883.6	40.177229	13.378865		1883.6	53.879824	14.533055
1884.8	40.180226	13.379063		1884.8	53.904721	14.555796
1886.0	40.183223	13.379261		1886.0	53.939932	14.487990
1887.2	40.186220	13.379459		1887.2	53.920707	14.464156
1888.4	40.191215	13.379657		1888.4	54.010484	14.498465
1889.6	40.196210	13.379855		1889.6	53.940975	14.503077
1890.8	40.201205	13.380053		1890.8	53.986650	14.559906
1892.0	40.206200	13.380251		1892.0	53.974614	14.356089
1893.2	40.211195	13.380449		1893.2	53.947066	14.317010
1894.4	40.216190	13.380647		1894.4	53.919704	14.366092
1895.6	40.221185	13.380845		1895.6	53.912552	14.699893
1896.8	40.226180	13.381043		1896.8	53.902453	14.698000
1898.0	40.231175	13.381241		1898.0	53.902783	14.678560
1899.2	40.236170	13.381439		1899.2	53.979784	14.679000
1900.4	40.241165	13.381637		1900.4	53.944700	14.577657
1901.6	40.246160	13.381835		1901.6	53.948183	14.667003
1902.8	40.250156	13.382033		1902.8	53.917274	14.627025
1904.0	40.254152	13.382231		1904.0	53.998985	14.595842
1905.2	40.258148	13.382429		1905.2	53.910742	14.564363
1906.4	40.262144	13.382627		1906.4	53.900654	14.489297
1907.6	40.266140	13.382825		1907.6	53.826334	14.606088
1908.8	40.270136	13.383023		1908.8	53.910614	14.541516
1910.0	40.274132	13.383221		1910.0	53.937137	14.505138

2450 MHz Head				2450 MHz Body		
Frequency (MHz)	e'	e''		Frequency (MHz)	e'	e''
2410	40.124441	13.436269		2410	51.898886	14.393490
2411	40.123442	13.436467		2411	51.889856	14.400487
2412	40.121444	13.436665		2412	51.880844	14.405489
2413	40.119446	13.436863		2413	51.871835	14.410486
2414	40.120445	13.437061		2414	51.862824	14.415489
2415	40.121444	13.437259		2415	51.853821	14.420494
2416	40.122443	13.437457		2416	51.844812	14.425489
2417	40.123442	13.437655		2417	51.835797	14.430489
2418	40.124441	13.437853		2418	51.826789	14.435488
2419	40.128437	13.438051		2419	51.817780	14.440486
2420	40.132433	13.438249		2420	51.808785	14.445493
2421	40.136429	13.438447		2421	51.799754	14.470489
2422	40.140425	13.438645		2422	51.792745	14.477492
2423	40.144421	13.438843		2423	51.785737	14.484489
2424	40.148417	13.439041		2424	51.778729	14.491488
2425	40.152413	13.439239		2425	51.771722	14.498489
2426	40.156409	13.439437		2426	51.764714	14.505488
2427	40.160405	13.439635		2427	51.757706	14.512487
2428	40.164401	13.439833		2428	51.750698	14.519494
2429	40.168397	13.440031		2429	51.743691	14.526489
2430	40.169396	13.440229		2430	51.736687	14.533486
2431	40.170395	13.440427		2431	51.729675	14.540486
2432	40.171394	13.440625		2432	51.722667	14.547488
2433	40.172393	13.440823		2433	51.715659	14.554493
2434	40.173392	13.441021		2434	51.708652	14.561488
2435	40.174301	13.441209		2435	51.701644	14.568488
2436	40.177388	13.441417		2436	51.694636	14.575493
2437	40.174391	13.441219		2437	51.687628	14.582492
2438	40.183382	13.441813		2438	51.680620	14.589492
2439	40.183380	13.441917		2439	51.680622	14.591490
2440	40.186379	13.442011		2440	51.673618	14.596488
2441	40.189376	13.442209		2441	51.666605	14.603487
2442	40.192373	13.442407		2442	51.659597	14.610486
2443	40.197368	13.442605		2443	51.652589	14.614485
2444	40.202363	13.442803		2444	51.645582	14.618488
2445	40.207358	13.443001		2445	51.638574	14.622491
2446	40.212353	13.443199		2446	51.631566	14.626490
2447	40.217348	13.443397		2447	51.624558	14.630489
2448	40.222343	13.443595		2448	51.617550	14.634487
2449	40.227338	13.443793		2449	51.610547	14.638487
2450	40.232333	13.443991		2450	51.603535	14.642488
2451	40.237328	13.444189		2451	51.596527	14.646487
2452	40.242323	13.444387		2452	51.589519	14.650486
2453	40.247318	13.444585		2453	51.582511	14.654487
2454	40.252313	13.444783		2454	51.575504	14.658491
2455	40.256309	13.444981		2455	51.568496	14.662487
2456	40.260305	13.445179		2456	51.561488	14.666487
2457	40.264301	13.445377		2457	51.554480	14.670494
2458	40.268297	13.445575		2458	51.547474	14.674487
2459	40.272293	13.445773		2459	51.540465	14.678492
2460	40.276289	13.445971		2460	51.533457	14.682487
2461	40.237328	13.444189		2461	51.526449	14.686490
2462	40.280285	13.446169		2462	51.519441	14.690485

Liquid Verification Results 2

Frequency	Liquid Type	Liquid Parameter		Target Value		Delta (%)		Tolerance (%)
		ϵ_r	σ (S/m)	ϵ_r	σ (S/m)	$\Delta\epsilon_r$	$\Delta\sigma$ (S/m)	
824.2	Head	41.10	0.90	41.50	0.90	-0.964	0.000	±5
	Body	55.14	0.95	55.20	0.97	-0.109	-2.062	±5
836.6	Head	41.05	0.91	41.50	0.90	-1.084	1.111	±5
	Body	55.21	0.97	55.20	0.97	0.018	0.000	±5
848.8	Head	40.82	0.93	41.50	0.90	-1.639	3.333	±5
	Body	55.29	0.99	55.20	0.97	0.163	2.062	±5
1850.2	Head	40.37	1.39	40.00	1.40	0.925	-0.714	±5
	Body	54.36	1.50	53.30	1.52	1.989	-1.316	±5
1880.0	Head	40.42	1.41	40.00	1.40	1.050	0.714	±5
	Body	54.11	1.54	53.30	1.52	1.520	1.316	±5
1909.8	Head	40.52	1.44	40.00	1.40	1.300	2.857	±5
	Body	54.19	1.56	53.30	1.52	1.670	2.632	±5

*Liquid Verification was performed on 2013-7-30.

Please refer to the following tables.

850 MHz Head				850 MHz Body		
Frequency (MHz)	e'	e''		Frequency (MHz)	e'	e''
824.0	41.096922	19.562246		824.0	55.137568	20.656110
824.5	41.065893	19.562800		824.5	55.138908	20.555621
825.0	41.049233	19.563354		825.0	55.142041	20.568139
825.5	40.944093	19.563908		825.5	55.145184	20.580573
826.0	40.962451	19.564463		826.0	55.148322	20.715635
826.5	40.984344	19.565016		826.5	55.151460	20.779366
827.0	40.960831	19.565570		827.0	55.154598	20.693865
827.5	41.008152	19.566124		827.5	55.157736	20.572001
828.0	41.027758	19.566678		828.0	55.160874	20.606563
828.5	41.034184	19.567233		828.5	55.164012	20.563986
829.0	41.085115	19.567786		829.0	55.167150	20.668141
829.5	41.033608	19.568341		829.5	55.170288	20.610970
830.0	41.069976	19.568895		830.0	55.173425	20.488867
830.5	41.030005	19.569449		830.5	55.176563	20.553255
831.0	41.003003	19.570003		831.0	55.179701	20.538430
831.5	41.022558	19.570557		831.5	55.182839	20.745854
832.0	40.984376	19.571111		832.0	55.185977	20.723518
832.5	40.959200	19.571665		832.5	55.189115	20.500217
833.0	40.999736	19.572219		833.0	55.192253	20.433581
833.5	41.031155	19.572773		833.5	55.195391	20.545048
834.0	41.028580	19.573327		834.0	55.198529	20.696905
834.5	41.027160	19.573883		834.5	55.201667	20.589867
835.0	41.051989	19.574436		835.0	55.204805	20.533326
835.5	41.052989	19.575291		835.5	55.207943	20.781033
836.0	41.056589	19.576146		836.0	55.211081	20.787956
836.5	41.046621	19.577001		836.5	55.214219	20.645763
837.0	41.028418	19.577857		837.0	55.217357	20.472846
837.5	41.022625	19.578715		837.5	55.220495	20.509112
838.0	41.045798	19.579567		838.0	55.223633	20.793395
838.5	41.004328	19.580424		838.5	55.226771	20.808599
839.0	40.994259	19.581278		839.0	55.229909	20.730611
839.5	40.996729	19.582133		839.5	55.233047	20.665569
840.0	41.007796	19.582988		840.0	55.236185	20.732712
840.5	40.997158	19.583843		840.5	55.239323	20.778076
841.0	40.980430	19.584699		841.0	55.242461	20.733204
841.5	41.009872	19.585554		841.5	55.245599	20.669941
842.0	41.011574	19.586409		842.0	55.248737	20.845781
842.5	41.015270	19.587264		842.5	55.251875	20.814294
843.0	41.009365	19.578086		843.0	55.255013	20.774692
843.5	40.933068	19.578937		843.5	55.258151	20.730203
844.0	41.009320	19.579793		844.0	55.261289	20.747861
844.5	40.963611	19.580647		844.5	55.264427	20.773768
845.0	40.889629	19.581506		845.0	55.267565	20.683186
845.5	40.904931	19.582358		845.5	55.270703	20.629572
846.0	40.859514	19.603289		846.0	55.273840	20.802573
846.5	40.900453	19.604144		846.5	55.276978	20.863977
847.0	40.880722	19.605000		847.0	55.280116	20.812836
847.5	40.883906	19.605855		847.5	55.283254	20.733137
848.0	40.857508	19.606710		848.0	55.286392	20.823294
848.5	40.862103	19.607565		848.5	55.289530	20.901378
849.0	40.822371	19.608420		849.0	55.292668	20.901560

1900 MHz Head				1900 MHz Body		
Frequency (MHz)	e'	e''		Frequency (MHz)	e'	e''
1850.0	40.368852	13.518561		1850.0	54.358409	14.605296
1851.2	40.367853	13.518759		1851.2	54.290328	14.562713
1852.4	40.365855	13.518957		1852.4	54.275172	14.563817
1853.6	40.363857	13.519155		1853.6	54.285755	14.540090
1854.8	40.364856	13.519353		1854.8	54.188591	14.559573
1856.0	40.365855	13.519551		1856.0	54.291614	14.595994
1857.2	40.366854	13.519749		1857.2	54.284785	14.621979
1858.4	40.367853	13.519947		1858.4	54.266799	14.543195
1859.6	40.368852	13.520145		1859.6	54.248470	14.537538
1860.8	40.372848	13.520343		1860.8	54.144261	14.590334
1862.0	40.376844	13.520541		1862.0	54.171937	14.417537
1863.2	40.380840	13.520739		1863.2	54.117918	14.430342
1864.4	40.384836	13.520937		1864.4	54.152670	14.447425
1865.6	40.388832	13.521135		1865.6	54.159143	14.418460
1866.8	40.392828	13.521333		1866.8	54.234153	14.409030
1868.0	40.396824	13.521531		1868.0	54.302597	14.425103
1869.2	40.400820	13.521729		1869.2	54.311659	14.447529
1870.4	40.404816	13.521927		1870.4	54.225157	14.498980
1871.6	40.408812	13.522125		1871.6	54.167537	14.499689
1872.8	40.412808	13.522323		1872.8	54.205971	14.528679
1874.0	40.413807	13.522521		1874.0	54.132436	14.536988
1875.2	40.414806	13.522719		1875.2	54.195599	14.600245
1876.4	40.415805	13.522917		1876.4	54.098714	14.523026
1877.6	40.416804	13.523115		1877.6	54.200997	14.603067
1878.8	40.417803	13.523313		1878.8	54.228784	14.734903
1880.0	40.418802	13.523511		1880.0	54.111105	14.753858
1881.2	40.421799	13.523709		1881.2	54.069345	14.750894
1882.4	40.424796	13.523907		1882.4	54.164887	14.722272
1883.6	40.427793	13.524105		1883.6	54.130388	14.678295
1884.8	40.430790	13.524303		1884.8	54.155285	14.701036
1886.0	40.433787	13.524501		1886.0	54.190496	14.633230
1887.2	40.436784	13.524699		1887.2	54.171271	14.609396
1888.4	40.441779	13.524897		1888.4	54.261048	14.643705
1889.6	40.446774	13.525095		1889.6	54.191539	14.648317
1890.8	40.451769	13.525293		1890.8	54.237214	14.705146
1892.0	40.456764	13.525491		1892.0	54.225178	14.501329
1893.2	40.461759	13.525689		1893.2	54.197630	14.462250
1894.4	40.466754	13.525887		1894.4	54.170268	14.511332
1895.6	40.471749	13.526085		1895.6	54.163116	14.845133
1896.8	40.476744	13.526283		1896.8	54.153017	14.843240
1898.0	40.481739	13.526481		1898.0	54.153347	14.823800
1899.2	40.486734	13.526679		1899.2	54.230348	14.824240
1900.4	40.491729	13.526877		1900.4	54.195264	14.722897
1901.6	40.496724	13.527075		1901.6	54.198747	14.812243
1902.8	40.500720	13.527273		1902.8	54.167838	14.772265
1904.0	40.504716	13.527471		1904.0	54.249549	14.741082
1905.2	40.508712	13.527669		1905.2	54.161306	14.709603
1906.4	40.512708	13.527867		1906.4	54.151218	14.634537
1907.6	40.516704	13.528065		1907.6	54.076898	14.751328
1908.8	40.520700	13.528263		1908.8	54.161178	14.686756
1910.0	40.524696	13.528461		1910.0	54.187701	14.650378

System Accuracy Verification

Prior to the assessment, the system validation kit was used to test whether the system was operating within its specifications of $\pm 10\%$. The validation results are tabulated below. And also the corresponding SAR plot is attached as well in the SAR plots files.

System Verification Setup Block Diagram

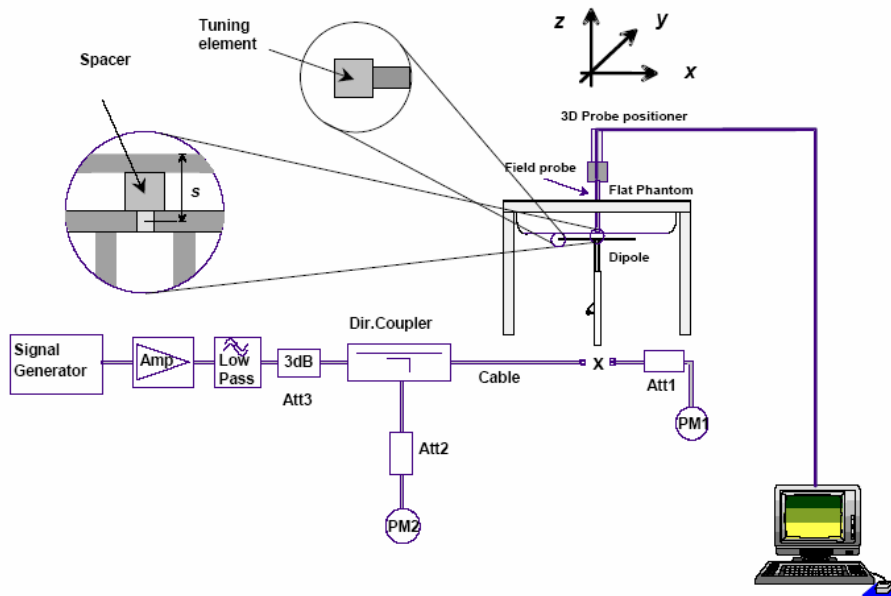

Probe and dipole antenna List and Detail

Manufacturer	Description	Model	Serial Number	Calibration Date	Calibration Due Date
APREL	Probe	ALS-E-020	500-00283	2012-08-08	2013-08-07
APREL	Dipole antenna(835MHz)	ALS-D-835-S-2	180-00558	2011-08-25	2014-08-24
APREL	Dipole antenna(1900MHz)	ALS-D-1900-S-2	210-00710	2011-08-25	2014-08-24
APREL	Dipole antenna(2450MHz)	ALS-D-2450-S-2	220-00758	2011-08-25	2014-08-24

System Accuracy Check Results 1

Date	Frequency Band	Liquid Type	Measured SAR (W/Kg)	Target Value (W/Kg)	Delta (%)	Tolerance (%)	
2013-7-16	835	Head	1g	9.854	9.590	2.679	± 10
		Body	1g	9.779	9.684	0.971	± 10
	1900	Head	1g	40.815	39.648	2.859	± 10
		Body	1g	40.137	39.769	0.917	± 10
	2450	Head	1g	52.155	52.667	-0.982	± 10
		Body	1g	53.674	52.561	2.074	± 10

*All SAR values are normalized to 1 Watt forward power.

SAR SYSTEM VALIDATION DATA**Test Laboratory: Bay Area Compliance Lab Corp. (Shenzhen)****System Performance Check 835 MHz Head Liquid****Dipole 835 MHz; Type: ALS-D-835-S-2; S/N: 180-00558**

Product Data

Device Name : Dipole 835 MHz
Serial No. : 180-00558
Type : Dipole
Model : ALS-D-835-S-2
Frequency Band : 835
Max. Transmit Pwr : 1 W
Drift Time : 3 min(s)
Power Drift-Start : 10.001 W/kg
Power Drift-Finish : 10.087 W/kg
Power Drift (%) : 0.870

Phantom Data

Name : APREL-Uni
Type : Uni-Phantom
Size (mm) : 280 x 280 x 200
Serial No. : System Default
Location : Center
Description : Default
Phantom Data

Tissue Data

Type : Head
Serial No. : 270-01002
Frequency : 835.0 MHz
Last Calib. Date : 16-Jul-2013
Temperature : 20.00 °C
Ambient Temp. : 21.00 °C
Humidity : 56.00 RH%
Epsilon : 41.03 F/m
Sigma : 0.91 S/m
Density : 1000.00 kg/cu. m

Probe Data

Name : E-Field
Model : E-020
Type : E-Field Triangle
Serial No. : 500-00283
Last Calib. Date : 08-Aug-2012
Frequency Band : 835
Duty Cycle Factor : 1
Conversion Factor : 6.6
Probe Sensitivity : 1.20 1.20 1.20 $\mu\text{V}/(\text{V}/\text{m})^2$
Compression Point : 95.00 mV
Offset : 1.56 mm

Measurement Data

Crest Factor : 1
Scan Type : Complete
Tissue Temp. : 21.00 °C
Ambient Temp. : 21.00 °C
Area Scan : 7x9x1 : Measurement x=10mm, y=10mm, z=4mm
Zoom Scan : 7x7x7 : Measurement x=5mm, y=5mm, z=5mm

1 gram SAR value : 9.854 W/kg
10 gram SAR value : 5.910 W/kg
Area Scan Peak SAR : 10.732 W/kg
Zoom Scan Peak SAR : 17.411 W/kg

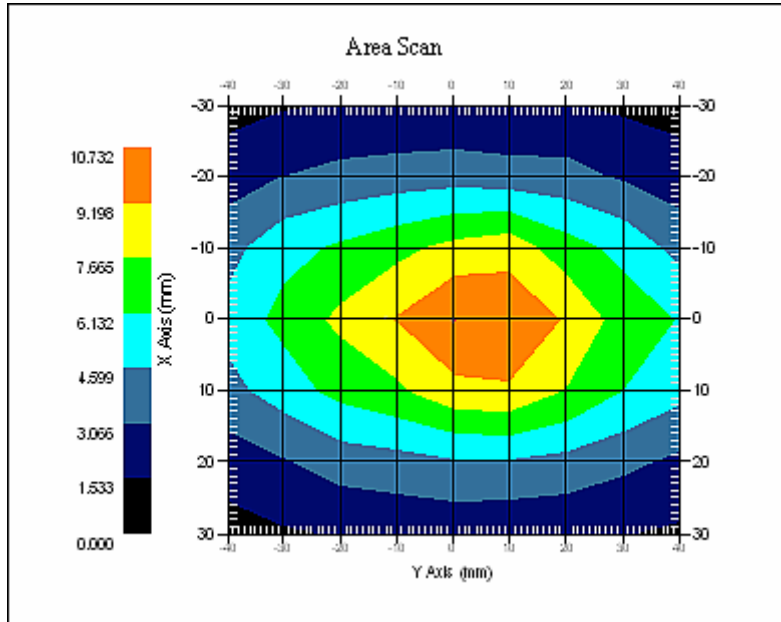

835 MHz System Validation with Head Tissue

Test Laboratory: Bay Area Compliance Lab Corp. (Shenzhen)**System Performance Check 835 MHz Body Liquid****Dipole 835 MHz; Type: ALS-D-835-S-2; S/N: 180-00558**

Product Data

Device Name : Dipole 835 MHz
 Serial No. : 180-00558
 Type : Dipole
 Model : ALS-D-835-S-2
 Frequency Band : 835
 Max. Transmit Pwr : 1 W
 Drift Time : 3 min(s)
 Power Drift-Start : 10.005 W/kg
 Power Drift-Finish : 10.079W/kg
 Power Drift (%) : 0.736

Phantom Data

Name : APREL-Uni
 Type : Uni-Phantom
 Size (mm) : 280 x 280 x 200
 Serial No. : System Default
 Location : Center
 Description : Default
 Phantom Data

Tissue Data

Type : Body
 Serial No. : 270-02101
 Frequency : 835.0 MHz
 Last Calib. Date : 16-Jul-2013
 Temperature : 20.00 °C
 Ambient Temp. : 21.00 °C
 Humidity : 56.00 RH%
 Epsilon : 55.21 F/m
 Sigma : 0.97 S/m
 Density : 1000.00 kg/cu. m

Probe Data

Name : E-Field
 Model : E-020
 Type : E-Field Triangle
 Serial No. : 500-00283
 Last Calib. Date : 08-Aug-2012
 Frequency Band : 835
 Duty Cycle Factor : 1
 Conversion Factor : 6.6
 Probe Sensitivity : 1.20 1.20 1.20 $\mu\text{V}/(\text{V}/\text{m})^2$
 Compression Point : 95.00 mV
 Offset : 1.56 mm

Measurement Data

Crest Factor : 1
 Scan Type : Complete
 Tissue Temp. : 21.00 °C
 Ambient Temp. : 21.00 °C
 Area Scan : 7x9x1 : Measurement x=10mm, y=10mm, z=4mm
 Zoom Scan : 7x7x7 : Measurement x=5mm, y=5mm, z=5mm

1 gram SAR value : 9.779 W/kg
 10 gram SAR value : 5.730W/kg
 Area Scan Peak SAR : 10.556 W/kg
 Zoom Scan Peak SAR : 17.199 W/kg

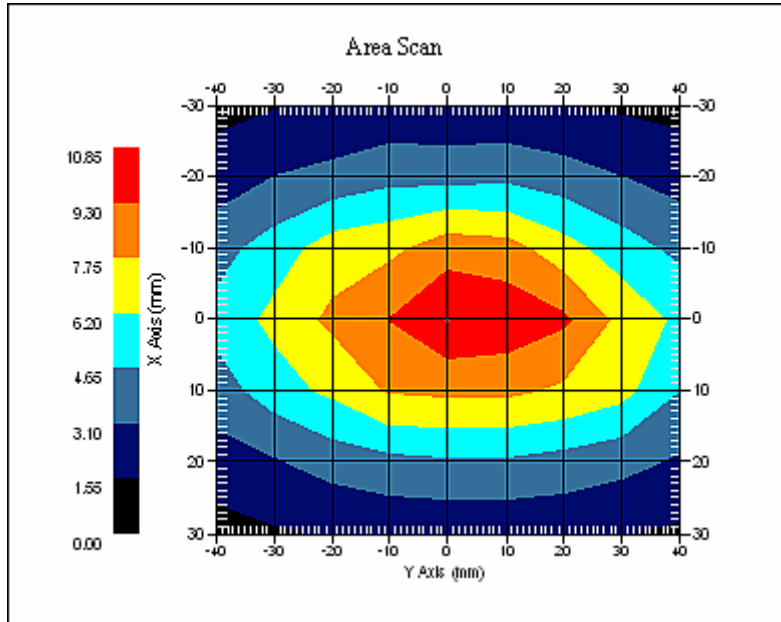

835 MHz System Validation with Body Tissue

Test Laboratory: Bay Area Compliance Lab Corp. (Shenzhen)**System Performance Check 1900 MHz Head Liquid****Dipole 1900 MHz; Type: ALS-D-1900-S-2; S/N: 210-00710**

Product Data

Device Name : Dipole 1900MHz
Serial No. : 210-00710
Type : Dipole
Model : ALS-D-1900-S-2
Frequency Band : 1900
Max. Transmit Pwr : 1 W
Drift Time : 3 min(s)
Power Drift-Start : 40.001 W/kg
Power Drift-Finish : 40.165 W/kg
Power Drift (%) : 0.412

Phantom Data

Name : APREL-Uni
Type : Uni-Phantom
Size (mm) : 280 x 280 x 200
Serial No. : System Default
Location : Center
Description : Default

Tissue Data

Type : Head
Serial No. : 295-01103
Frequency : 1900.00 MHz
Last Calib. Date : 16-Jul-2013
Temperature : 20.00 °C
Ambient Temp. : 21.00 °C
Humidity : 56.00 RH%
Epsilon : 40.24 F/m
Sigma : 1.41 S/m
Density : 1000.00 kg/cu. M

Probe Data

Name : E-Field
Model : E-020
Type : E-Field Triangle
Serial No. : 500-00283
Last Calib. Date : 08-Aug-2012
Frequency Band : 1900
Duty Cycle Factor : 1
Conversion Factor : 5.20
Probe Sensitivity : 1.20 1.20 1.20 $\mu\text{V}/(\text{V}/\text{m})^2$
Compression Point : 95.00 mV
Offset : 1.56 mm

Measurement Data

Crest Factor : 1
Scan Type : Complete
Tissue Temp. : 20.00 °C
Ambient Temp. : 20.00 °C
Area Scan : 7x9x1 : Measurement x=10mm, y=10mm, z=4mm
Zoom Scan : 7x7x7 : Measurement x=5mm, y=5mm, z=5mm

1 gram SAR value : 40.815 W/kg
10 gram SAR value : 22.122 W/kg
Area Scan Peak SAR : 43.100 W/kg
Zoom Scan Peak SAR : 82.180 W/kg

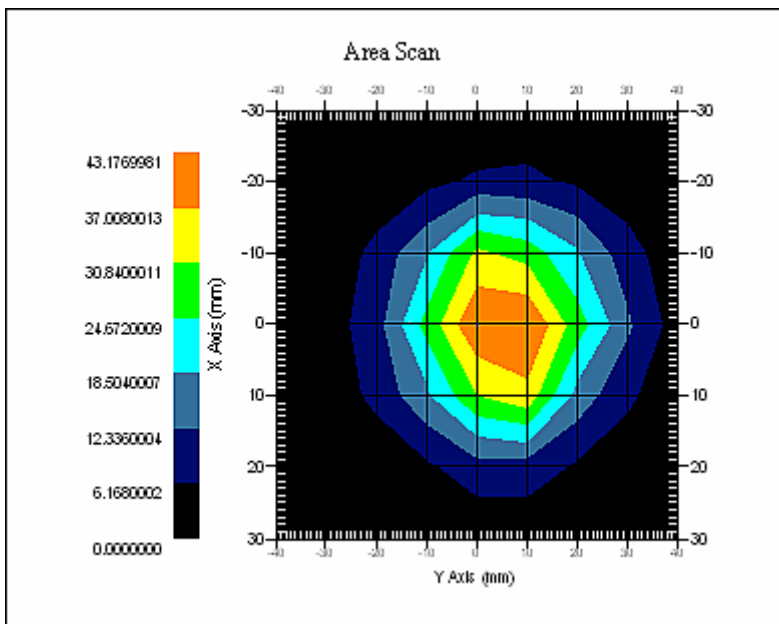

1900 MHz System Validation with Head Tissue

Test Laboratory: Bay Area Compliance Lab Corp. (Shenzhen)**System Performance Check 1900 MHz Body Liquid****Dipole 1900 MHz; Type: ALS-D-1900-S-2; S/N: 210-00710**

Product Data

Device Name : Dipole 1900MHz
Serial No. : 210-00710
Type : Dipole
Model : ALS-D-1900-S-2
Frequency Band : 1900
Max. Transmit Pwr : 1 W
Drift Time : 3 min(s)
Power Drift-Start : 40.014 W/kg
Power Drift-Finish : 40.334 W/kg
Power Drift (%) : 0.798

Phantom Data

Name : APREL-Uni
Type : Uni-Phantom
Size (mm) : 280 x 280 x 200
Serial No. : System Default
Location : Center
Description : Default

Tissue Data

Type : Body
Serial No. : 295-02102
Frequency : 1900.00 MHz
Last Calib. Date : 16-Jul-2013
Temperature : 20.00 °C
Ambient Temp. : 21.00 °C
Humidity : 56.00 RH%
Epsilon : 53.94 F/m
Sigma : 1.54 S/m
Density : 1000.00 kg/cu. m

Probe Data

Name : E-Field
Model : E-020
Type : E-Field Triangle
Serial No. : 500-00283
Last Calib. Date : 08-Aug-2012
Frequency Band : 1900
Duty Cycle Factor : 1
Conversion Factor : 5.0
Probe Sensitivity : 1.20 1.20 1.20 $\mu\text{V}/(\text{V}/\text{m})^2$
Compression Point : 95.00 mV
Offset : 1.56 mm

Measurement Data

Crest Factor : 1
Scan Type : Complete
Tissue Temp. : 20.00 °C
Ambient Temp. : 21.00 °C
Area Scan : 7x9x1 : Measurement x=10mm, y=10mm, z=4mm
Zoom Scan : 7x7x7 : Measurement x=5mm, y=5mm, z=5mm

1 gram SAR value : 40.137 W/kg
 10 gram SAR value : 21.920 W/kg
 Area Scan Peak SAR : 41.210 W/kg
 Zoom Scan Peak SAR : 88.246 W/kg

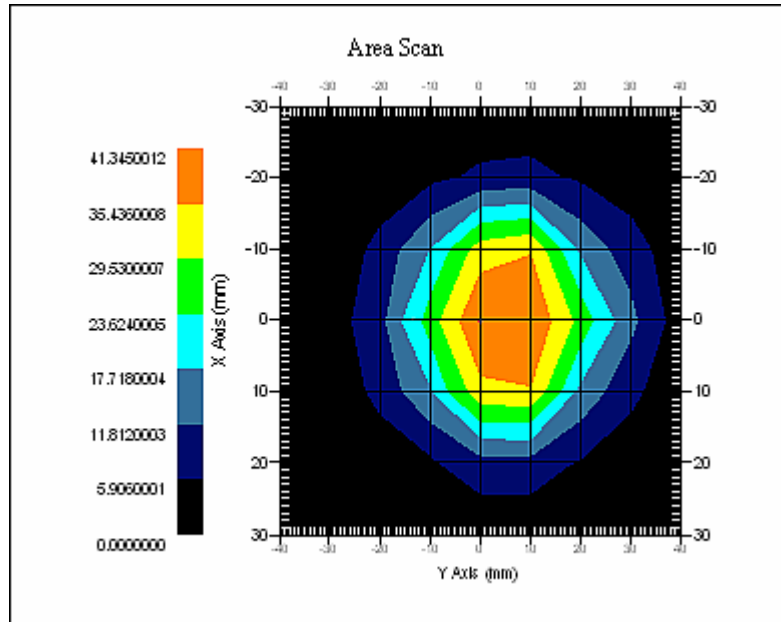

1900 MHz System Validation with Body Tissue

Test Laboratory: Bay Area Compliance Lab Corp. (Shenzhen)**System Performance Check 2450 MHz Head Liquid****Dipole 2450 MHz; Type: ALS-D-2450-S-2; S/N: 220-00758**

Product Data

Device Name : Dipole 2450MHz
Serial No. : 220-00758
Type : Dipole
Model : ALS-D-2450-S-2
Frequency Band : 2450 MHz
Max. Transmit Pwr : 1 W
Drift Time : 3 min(s)
Power Drift-Start : 56.738 W/kg
Power Drift-Finish : 57.820 W/kg
Power Drift (%) : 1.876

Phantom Data

Name : APREL-Uni
Type : Uni-Phantom
Size (mm) : 280 x 280 x 200
Serial No. : System Default
Location : Center
Description : Default

Tissue Data

Type : Head
Serial No. : 296-01001
Frequency : 2450.0 MHz
Last Calib. Date : 16-Jul-2013
Temperature : 20.00 °C
Ambient Temp. : 21.00 °C
Humidity : 50.00 RH%
Epsilon : 40.23 F/m
Sigma : 1.83 S/m
Density : 1000.00 kg/cu. M

Probe Data

Name : E-Field
Model : E-020
Type : E-Field Triangle
Serial No. : 500-00283
Last Calib. Date : 14-Jul-2011
Frequency Band : 2450 MHz
Duty Cycle Factor : 1
Conversion Factor : 4.9
Probe Sensitivity : 1.20 1.20 1.20 $\mu\text{V}/(\text{V}/\text{m})^2$
Compression Point : 95.00 mV
Offset : 1.56 mm

Measurement Data

Crest Factor : 1
Scan Type : Complete
Tissue Temp. : 20.00 °C
Ambient Temp. : 20.00 °C
Area Scan : 7x9x1 : Measurement x=10mm, y=10mm, z=4mm
Zoom Scan : 7x7x7 : Measurement x=5mm, y=5mm, z=5mm

1 gram SAR value : 52.155 W/kg
10 gram SAR value : 23.210 W/kg
Area Scan Peak SAR : 54.953 W/kg
Zoom Scan Peak SAR : 100.185 W/kg

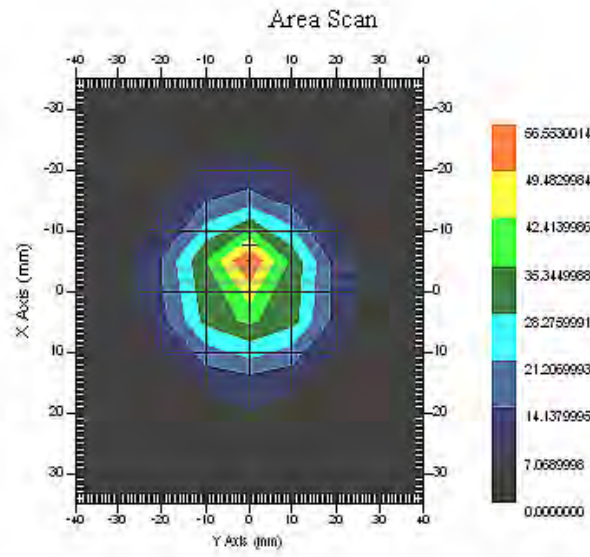

2450 MHz System Validation

Test Laboratory: Bay Area Compliance Lab Corp. (Shenzhen)**System Performance Check 2450 MHz Body Liquid****Dipole 2450 MHz; Type: ALS-D-2450-S-2; S/N: 220-00758**

Product Data

Device Name : Dipole 2450MHz
Serial No. : 220-00758
Type : Dipole
Model : ALS-D-2450-S-2
Frequency Band : 2450 MHz
Max. Transmit Pwr : 1 W
Drift Time : 3 min(s)
Power Drift-Start : 52.114 W/kg
Power Drift-Finish : 52.496 W/kg
Power Drift (%) : 1.168

Phantom Data

Name : APREL-Uni
Type : Uni-Phantom
Size (mm) : 280 x 280 x 200
Serial No. : System Default
Location : Center
Description : Default

Tissue Data

Type : BODY
Serial No. : 296-01002
Frequency : 2450.0 MHz
Last Calib. Date : 16-Jul-2013
Temperature : 20.00 °C
Ambient Temp. : 21.00 °C
Humidity : 50.00 RH%
Epsilon : 51.60 F/m
Sigma : 1.99 S/m
Density : 1000.00 kg/cu. M

Probe Data

Name : E-Field
Model : E-020
Type : E-Field Triangle
Serial No. : 500-00283
Last Calib. Date : 14-Jul-2011
Frequency Band : 2450 MHz
Duty Cycle Factor : 1
Conversion Factor : 4.3
Probe Sensitivity : 1.20 1.20 1.20 $\mu\text{V}/(\text{V}/\text{m})^2$
Compression Point : 95.00 mV
Offset : 1.56 mm

Measurement Data

Crest Factor : 1
Scan Type : Complete
Tissue Temp. : 20.00 °C
Ambient Temp. : 20.00 °C
Area Scan : 8x9x1 : Measurement x=10mm, y=10mm, z=4mm
Zoom Scan : 7x7x7 : Measurement x=5mm, y=5mm, z=5mm

1 gram SAR value : 53.674 W/kg
 10 gram SAR value : 25.710 W/kg
 Area Scan Peak SAR : 55.520 W/kg
 Zoom Scan Peak SAR : 98.852 W/kg

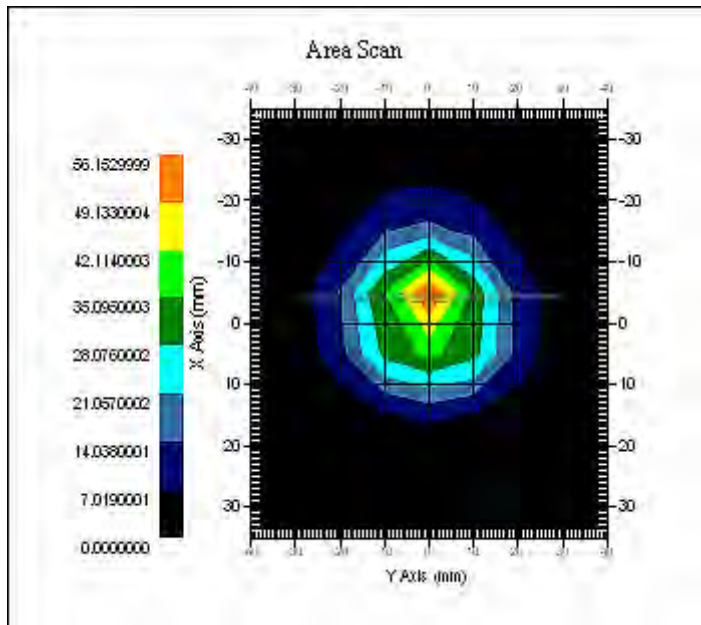

2450 MHz System Validation

System Accuracy Check Results 2

Date	Frequency Band	Liquid Type	Measured SAR (W/Kg)		Target Value (W/Kg)	Delta (%)	Tolerance (%)
2013-7-30	835	Head	1g	9.621	9.590	0.323	±10
		Body	1g	9.594	9.684	-0.929	±10
	1900	Head	1g	41.211	39.648	3.942	±10
		Body	1g	41.338	39.769	3.945	±10

*All SAR values are normalized to 1 Watt forward power.

SAR SYSTEM VALIDATION DATA (July 30, 2013)**Test Laboratory: Bay Area Compliance Lab Corp. (Shenzhen)****System Performance Check 835 MHz Head Liquid****Dipole 835 MHz; Type: ALS-D-835-S-2; S/N: 180-00558**

Product Data

Device Name : Dipole 835 MHz
Serial No. : 180-00558
Type : Dipole
Model : ALS-D-835-S-2
Frequency Band : 835
Max. Transmit Pwr : 1 W
Drift Time : 3 min(s)
Power Drift-Start : 9.427 W/kg
Power Drift-Finish : 9.515W/kg
Power Drift (%) : 2.934

Phantom Data

Name : APREL-Uni
Type : Uni-Phantom
Size (mm) : 280 x 280 x 200
Serial No. : System Default
Location : Center
Description : Default
Phantom Data

Tissue Data

Type : Head
Serial No. : 270-01002
Frequency : 835.0 MHz
Last Calib. Date : 30-Jul-2013
Temperature : 20.00 °C
Ambient Temp. : 21.00 °C
Humidity : 56.00 RH%
Epsilon : 41.05 F/m
Sigma : 0.91 S/m
Density : 1000.00 kg/cu. m

Probe Data

Name : E-Field
Model : E-020
Type : E-Field Triangle
Serial No. : 500-00283
Last Calib. Date : 08-Aug-2012
Frequency Band : 835
Duty Cycle Factor : 1
Conversion Factor : 6.6
Probe Sensitivity : 1.20 1.20 1.20 $\mu\text{V}/(\text{V}/\text{m})^2$
Compression Point : 95.00 mV
Offset : 1.56 mm

Measurement Data

Crest Factor : 1
Scan Type : Complete
Tissue Temp. : 21.00 °C
Ambient Temp. : 21.00 °C
Area Scan : 7x9x1 : Measurement x=10mm, y=10mm, z=4mm
Zoom Scan : 7x7x7 : Measurement x=5mm, y=5mm, z=5mm

1 gram SAR value : 9.621 W/kg
10 gram SAR value : 6.283 W/kg
Area Scan Peak SAR : 10.285 W/kg
Zoom Scan Peak SAR : 16.415 W/kg

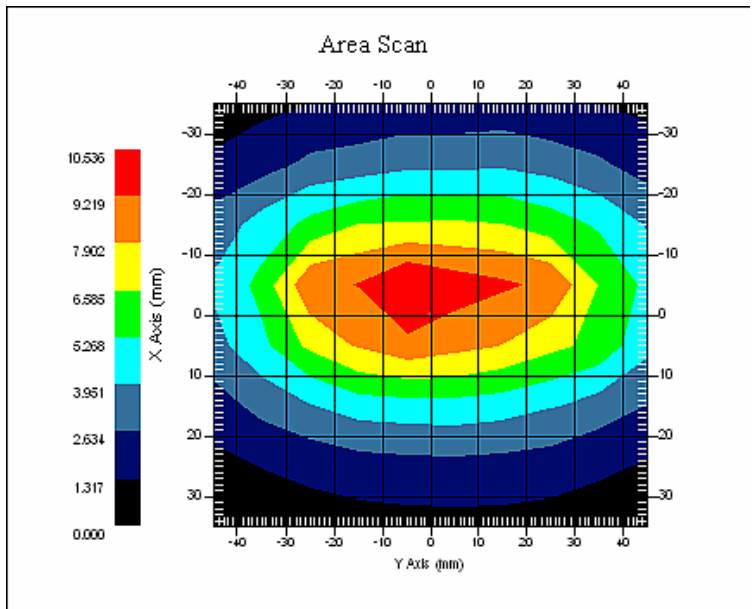

835 MHz System Validation with Head Tissue

Test Laboratory: Bay Area Compliance Lab Corp. (Shenzhen)**System Performance Check 835 MHz Body Liquid****Dipole 835 MHz; Type: ALS-D-835-S-2; S/N: 180-00558**

Product Data

Device Name : Dipole 835 MHz
Serial No. : 180-00558
Type : Dipole
Model : ALS-D-835-S-2
Frequency Band : 835
Max. Transmit Pwr : 1 W
Drift Time : 3 min(s)
Power Drift-Start : 9.856 W/kg
Power Drift-Finish : 9.843 W/kg
Power Drift (%) : -1.627

Phantom Data

Name : APREL-Uni
Type : Uni-Phantom
Size (mm) : 280 x 280 x 200
Serial No. : System Default
Location : Center
Description : Default
Phantom Data

Tissue Data

Type : Body
Serial No. : 270-02101
Frequency : 835.0 MHz
Last Calib. Date : 30-Jul-2013
Temperature : 20.00 °C
Ambient Temp. : 21.00 °C
Humidity : 56.00 RH%
Epsilon : 55.20 F/m
Sigma : 0.97 S/m
Density : 1000.00 kg/cu. m

Probe Data

Name : E-Field
Model : E-020
Type : E-Field Triangle
Serial No. : 500-00283
Last Calib. Date : 08-Aug-2012
Frequency Band : 835
Duty Cycle Factor : 1
Conversion Factor : 6.6
Probe Sensitivity : 1.20 1.20 1.20 $\mu\text{V}/(\text{V}/\text{m})^2$
Compression Point : 95.00 mV
Offset : 1.56 mm

Measurement Data

Crest Factor : 1
Scan Type : Complete
Tissue Temp. : 21.00 °C
Ambient Temp. : 21.00 °C
Area Scan : 7x9x1 : Measurement x=10mm, y=10mm, z=4mm
Zoom Scan : 7x7x7 : Measurement x=5mm, y=5mm, z=5mm

1 gram SAR value : 9.594 W/kg
10 gram SAR value : 5.380 W/kg
Area Scan Peak SAR : 10.438 W/kg
Zoom Scan Peak SAR : 17.146 W/kg

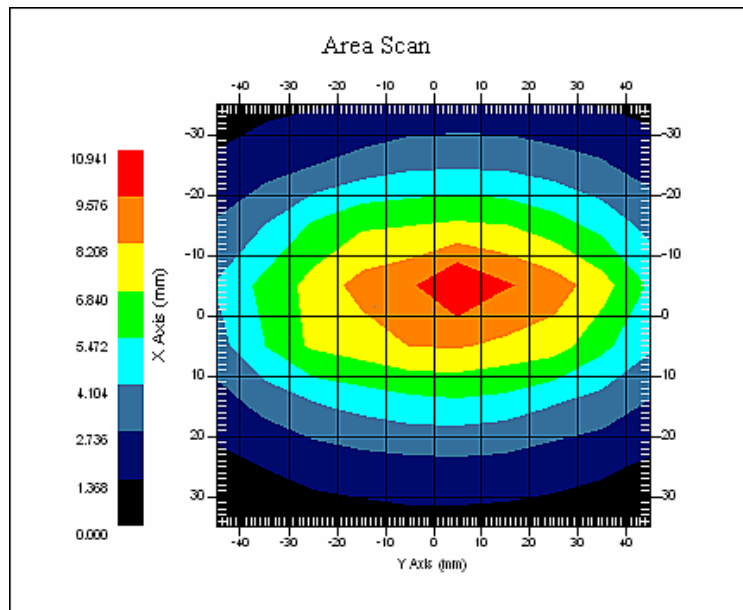

835 MHz System Validation with Body Tissue

Test Laboratory: Bay Area Compliance Lab Corp. (Shenzhen)**System Performance Check 1900 MHz Head Liquid****Dipole 1900 MHz; Type: ALS-D-1900-S-2; S/N: 210-00710**

Product Data

Device Name : Dipole 1900MHz
Serial No. : 210-00710
Type : Dipole
Model : ALS-D-1900-S-2
Frequency Band : 1900
Max. Transmit Pwr : 1 W
Drift Time : 3 min(s)
Power Drift-Start : 38.532 W/kg
Power Drift-Finish : 38.169 W/kg
Power Drift (%) : -1.801

Phantom Data

Name : APREL-Uni
Type : Uni-Phantom
Size (mm) : 280 x 280 x 200
Serial No. : System Default
Location : Center
Description : Default

Tissue Data

Type : Head
Serial No. : 295-01103
Frequency : 1900.00 MHz
Last Calib. Date : 30-Jul-2013
Temperature : 20.00 °C
Ambient Temp. : 21.00 °C
Humidity : 56.00 RH%
Epsilon : 40.49 F/m
Sigma : 1.43 S/m
Density : 1000.00 kg/cu. M

Probe Data

Name : E-Field
Model : E-020
Type : E-Field Triangle
Serial No. : 500-00283
Last Calib. Date : 08-Aug-2012
Frequency Band : 1900
Duty Cycle Factor : 1
Conversion Factor : 5.20
Probe Sensitivity : 1.20 1.20 1.20 $\mu\text{V}/(\text{V}/\text{m})^2$
Compression Point : 95.00 mV
Offset : 1.56 mm

Measurement Data

Crest Factor : 1
Scan Type : Complete
Tissue Temp. : 20.00 °C
Ambient Temp. : 20.00 °C
Area Scan : 7x9x1 : Measurement x=10mm, y=10mm, z=4mm
Zoom Scan : 7x7x7 : Measurement x=5mm, y=5mm, z=5mm

1 gram SAR value : 41.211 W/kg
10 gram SAR value : 17.634 W/kg
Area Scan Peak SAR : 43.550 W/kg
Zoom Scan Peak SAR : 90.879 W/kg

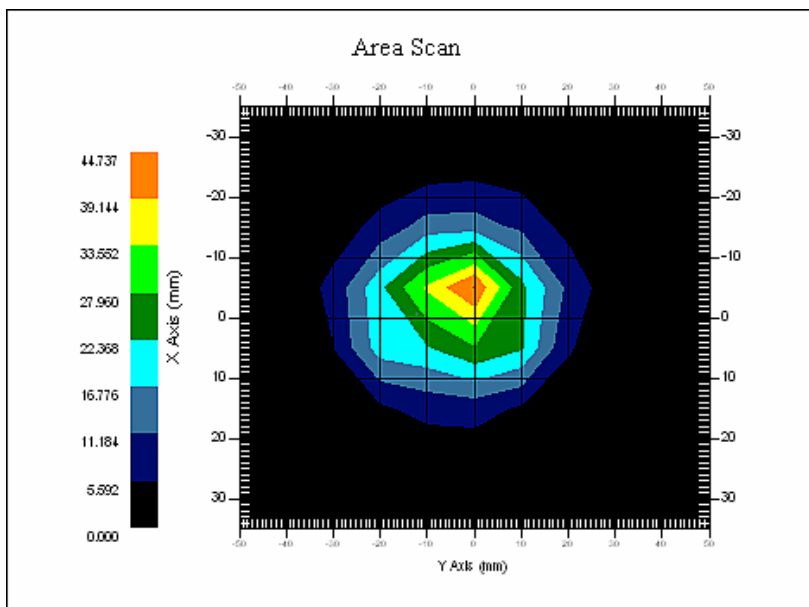

1900 MHz System Validation with Head Tissue

Test Laboratory: Bay Area Compliance Lab Corp. (Shenzhen)**System Performance Check 1900 MHz Body Liquid****Dipole 1900 MHz; Type: ALS-D-1900-S-2; S/N: 210-00710**

Product Data

Device Name : Dipole 1900MHz
Serial No. : 210-00710
Type : Dipole
Model : ALS-D-1900-S-2
Frequency Band : 1900
Max. Transmit Pwr : 1 W
Drift Time : 3 min(s)
Power Drift-Start : 41.782 W/kg
Power Drift-Finish : 41.426 W/kg
Power Drift (%) : 1.638

Phantom Data

Name : APREL-Uni
Type : Uni-Phantom
Size (mm) : 280 x 280 x 200
Serial No. : System Default
Location : Center
Description : Default

Tissue Data

Type : Body
Serial No. : 295-02102
Frequency : 1900.00 MHz
Last Calib. Date : 30-Jul-2013
Temperature : 20.00 °C
Ambient Temp. : 21.00 °C
Humidity : 56.00 RH%
Epsilon : 54.20 F/m
Sigma : 1.56 S/m
Density : 1000.00 kg/cu. m

Probe Data

Name : E-Field
Model : E-020
Type : E-Field Triangle
Serial No. : 500-00283
Last Calib. Date : 08-Aug-2012
Frequency Band : 1900
Duty Cycle Factor : 1
Conversion Factor : 5.0
Probe Sensitivity : 1.20 1.20 1.20 $\mu\text{V}/(\text{V}/\text{m})^2$
Compression Point : 95.00 mV
Offset : 1.56 mm

Measurement Data

Crest Factor : 1
Scan Type : Complete
Tissue Temp. : 20.00 °C
Ambient Temp. : 21.00 °C
Area Scan : 7x9x1 : Measurement x=10mm, y=10mm, z=4mm
Zoom Scan : 7x7x7 : Measurement x=5mm, y=5mm, z=5mm

1 gram SAR value : 41.338 W/kg
 10 gram SAR value : 21.501 W/kg
 Area Scan Peak SAR : 42.816 W/kg
 Zoom Scan Peak SAR : 87.166 W/kg

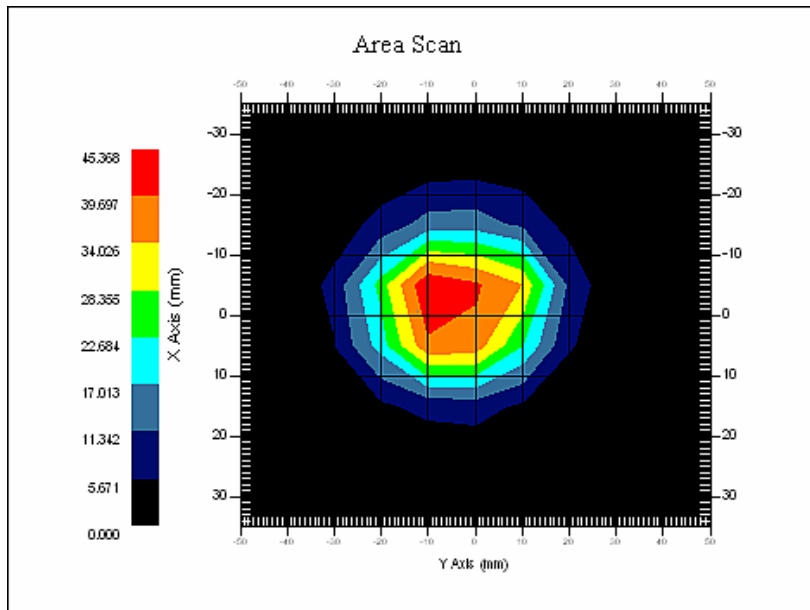

1900 MHz System Validation with Body Tissue

EUT TEST STRATEGY AND METHODOLOGY

Test Positions for Device Operating Next to a Person’s Ear

This category includes most wireless handsets with fixed, retractable or internal antennas located toward the top half of the device, with or without a foldout, sliding or similar keypad cover. The handset should have its earpiece located within the upper ¼ of the device, either along the centerline or off-centered, as perceived by its users. This type of handset should be positioned in a normal operating position with the “test device reference point” located along the “vertical centerline” on the front of the device aligned to the “ear reference point”. The “test device reference point” should be located at the same level as the center of the earpiece region. The “vertical centerline” should bisect the front surface of the handset at its top and bottom edges. A “ear reference point” is located on the outer surface of the head phantom on each ear spacer. It is located 1.5 cm above the center of the ear canal entrance in the “phantom reference plane” defined by the three lines joining the center of each “ear reference point” (left and right) and the tip of the mouth.

A handset should be initially positioned with the earpiece region pressed against the ear spacer of a head phantom. For the SCC-34/SC-2 head phantom, the device should be positioned parallel to the “N-F” line defined along the base of the ear spacer that contains the “ear reference point”. For interim head phantoms, the device should be positioned parallel to the cheek for maximum RF energy coupling. The “test device reference point” is aligned to the “ear reference point” on the head phantom and the “vertical centerline” is aligned to the “phantom reference plane”. This is called the “initial ear position”. While maintaining these three alignments, the body of the handset is gradually adjusted to each of the following positions for evaluating SAR:

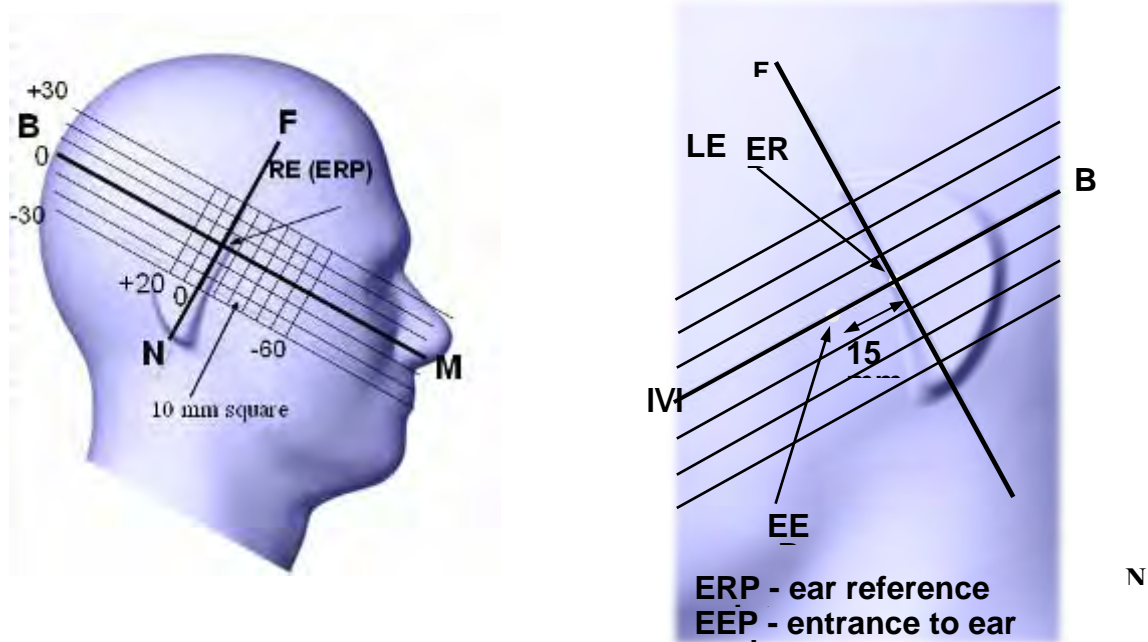

Cheek/Touch Position

The device is brought toward the mouth of the head phantom by pivoting against the “ear reference point” or along the “N-F” line for the SCC-34/SC-2 head phantom.

This test position is established:

- When any point on the display, keypad or mouthpiece portions of the handset is in contact with the phantom.
- (or) When any portion of a foldout, sliding or similar keypad cover opened to its intended self-adjusting normal use position is in contact with the cheek or mouth of the phantom.

For existing head phantoms – when the handset loses contact with the phantom at the pivoting point, rotation should continue until the device touches the cheek of the phantom or breaks its last contact from the ear spacer.

Cheek /Touch Position

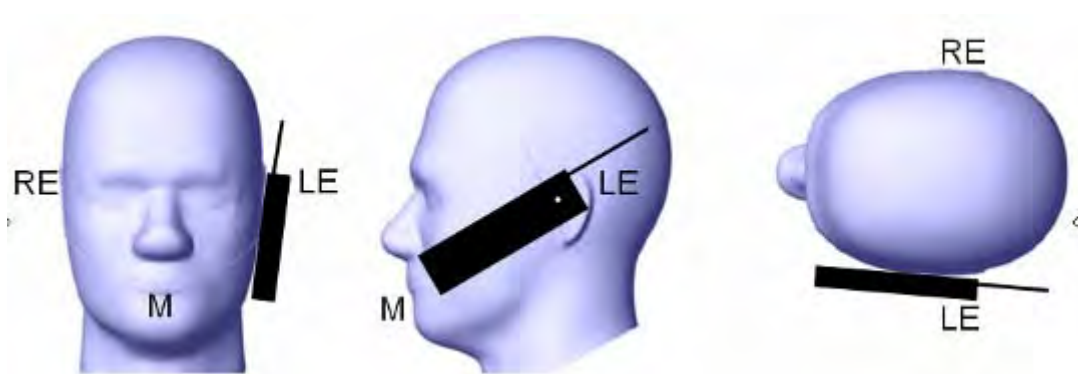

Ear/Tilt Position

With the handset aligned in the “Cheek/Touch Position”:

1) If the earpiece of the handset is not in full contact with the phantom’s ear spacer (in the “Cheek/Touch position”) and the peak SAR location for the “Cheek/Touch” position is located at the ear spacer region or corresponds to the earpiece region of the handset, the device should be returned to the “initial ear position” by rotating it away from the mouth until the earpiece is in full contact with the ear spacer.

2) (otherwise) The handset should be moved (translated) away from the cheek perpendicular to the line passes through both “ear reference points” (note: one of these ear reference points may not physically exist on a split head model) for approximate 2-3 cm. While it is in this position, the device handset is tilted away from the mouth with respect to the “test device reference point” until the inside angle between the vertical centerline on the front surface of the phone and the horizontal line passing through the ear reference point is by 15 80°. After the tilt, it is then moved (translated) back toward the head perpendicular to the line passes through both “ear reference points” until the device touches the phantom or the ear spacer. If the antenna touches the head first, the positioning process should be repeated with a tilt angle less than 15° so that the device and its antenna would touch the phantom simultaneously. This test position may require a device holder or positioner to achieve the translation and tilting with acceptable positioning repeatability.

If a device is also designed to transmit with its keypad cover closed for operating in the head position, such positions should also be considered in the SAR evaluation. The device should be tested on the left and right side of the head phantom in the “Cheek/Touch” and “Ear/Tilt” positions. When applicable, each configuration should be tested with the antenna in its fully extended and fully retracted positions. These test configurations should be tested at the high, middle and low frequency channels of each operating mode; for example, AMPS, CDMA, and TDMA. If the SAR measured at the middle channel for each test configuration (left, right, Cheek/Touch, Tile/Ear, extended and retracted) is at least 2.0 dB lower than the SAR limit, testing at the high and low channels is optional for such test configuration(s). If the transmission band of the test device is less than 10 MHz, testing at the high and low frequency channels is optional.

Ear /Tilt 15° Position

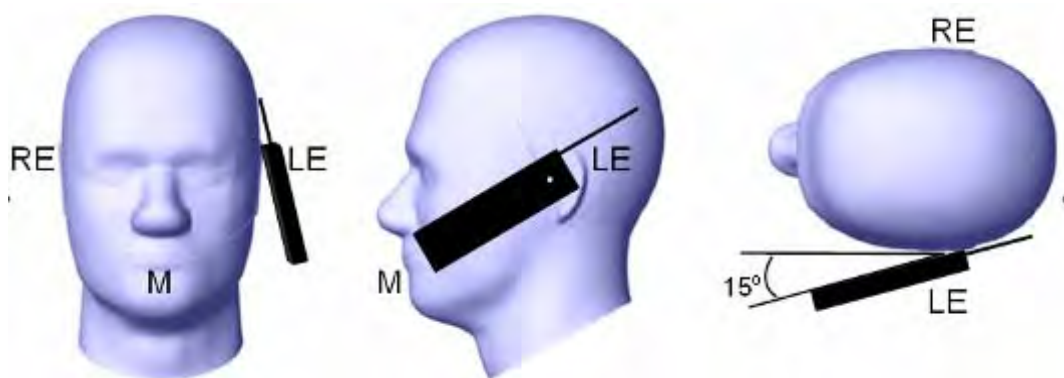

Test positions for body-worn and other configurations

Body-worn operating configurations should be tested with the belt-clips and holsters attached to the device and positioned against a flat phantom in normal use configurations. Devices with a headset output should be tested with a headset connected to the device. When multiple accessories that do not contain metallic components are supplied with the device, the device may be tested with only the accessory that dictates the closest spacing to the body. When multiple accessories that contain metallic components are supplied with the device, the device must be tested with each accessory that contains a unique metallic component. If multiple accessories share an identical metallic component (e.g., the same metallic belt-clip used with different holsters with no other metallic components), only the accessory that dictates the closest spacing to the body must be tested.

Body-worn accessories may not always be supplied or available as options for some devices that are intended to be authorized for body-worn use. A separation distance of 1.5 cm between the back of the device and a flat phantom is recommended for testing body-worn SAR compliance under such circumstances. Other separation distances may be used, but they should not exceed 2.5 cm. In these cases, the device may use body-worn accessories that provide a separation distance greater than that tested for the device provided however that the accessory contains no metallic components.

SAR Evaluation Procedure

The evaluation was performed with the following procedure:

Step 1: Measurement of the SAR value at a fixed location above the ear point or central position was used as a reference value for assessing the power drop. The SAR at this point is measured at the start of the test and then again at the end of the testing.

Step 2: The SAR distribution at the exposed side of the head was measured at a distance of 4 mm from the inner surface of the shell. The area covered the entire dimension of the head or EUT and the horizontal grid spacing was 10 mm x 10 mm. Based on these data, the area of the maximum absorption was determined by spline interpolation. The first Area Scan covers the entire dimension of the EUT to ensure that the hotspot was correctly identified.

Step 3: Around this point, a volume of 35 mm x 35 mm x 35 mm was assessed by measuring 7x 7 x 7 points. On the basis of this data set, the spatial peak SAR value was evaluated under the following procedure:

- 1) The data at the surface were extrapolated, since the center of the dipoles is 1.2 mm away from the tip of the probe and the distance between the surface and the lowest measuring point is 1.3 mm. The extrapolation was based on a least square algorithm. A polynomial of the fourth order was calculated through the points in z-axes. This polynomial was then used to evaluate the points between the surface and the probe tip.
- 2) The maximum interpolated value was searched with a straightforward algorithm. Around this maximum the SAR values averaged over the spatial volumes (1 g or 10 g) were computed by the 3D-Spline interpolation algorithm. The 3D-Spline is composed of three one dimensional splines with the "Not a knot"-condition (in x, y and z-directions). The volume was integrated with the trapezoidal-algorithm. One thousand points (10 x 10 x 10) were interpolated to calculate the averages.

All neighboring volumes were evaluated until no neighboring volume with a higher average value was found.

Step 4: Re-measurement of the SAR value at the same location as in Step 1. If the value changed by more than 5%, the evaluation was repeated.

CONDUCTED OUTPUT POWER MEASUREMENT

Provision Applicable

The measured peak output power should be greater and within 5% than EMI measurement.

Test Procedure

The RF output of the transmitter was connected to the input of the EMI Test Receiver through sufficient attenuation.

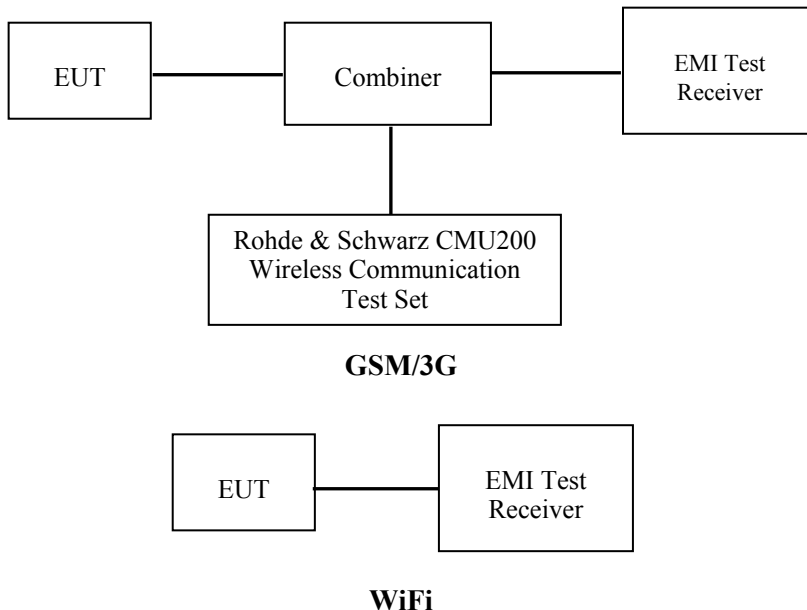

Maximum Output Power among production units

Max Target Power for Production Unit (dBm)			
Mode/Band	Channel		
	Low	Middle	High
GSM 850	32.50	32.50	32.50
GPRS 1 slot	33.00	33.00	33.00
GPRS 2 slot	32.50	32.50	32.50
GPRS 3 slot	31.00	31.00	31.00
GPRS 4 slot	30.00	30.00	30.00
PCS 1900	30.50	30.50	30.50
GPRS 1 slot	30.00	30.00	30.00
GPRS 2 slot	30.00	30.00	30.00
GPRS 3 slot	28.50	28.50	28.50
GPRS 4 slot	27.00	27.00	27.00
WCDMA850	23.50	23.50	23.50
WCDMA1900	23.00	23.00	23.00

Max Target Power for Production Unit (dBm)			
Mode/Band	Channel		
	Low	Middle	High
Bluetooth	5.00	5.00	5.00
WiFi 802.11b	16.00	16.00	16.00
WiFi 802.11g	13.50	13.50	13.50
WiFi 802.11n-20	13.50	13.50	13.50
WiFi 802.11n-40	13.50	13.50	13.50

Test Results:

GSM

Band	Frequency (MHz)	Conducted Peak Output Power	
		Meas. Power (dBm)	Meas. Power (W)
GSM 850	824.2	31.88	1.542
	836.6	32.03	1.596
	848.8	32.05	1.603
PCS 1900	1850.2	30.10	1.023
	1880.0	29.93	0.984
	1909.8	29.29	0.849

GPRS

Band	Channel No.	Frequency (MHz)	RF Peak Output Power (dBm)			
			1 slot	2 slot	3 slots	4 slots
GSM 850	128	824.2	32.37	31.96	30.53	29.50
	190	836.6	32.55	32.10	30.69	29.62
	251	848.8	32.59	32.15	30.74	29.67
PCS 1900	512	1850.2	29.35	29.78	28.05	26.98
	661	1880.0	29.22	29.61	27.83	26.81
	810	1909.8	28.40	28.81	26.87	25.80

For SAR, the time based average power is relevant, the difference in between depends on the duty cycle of the TDMA signal.

Number of Time slot	1	2	3	4
Duty Cycle	1:8	1:4	1:2.66	1:2
Time based Ave. power compared to slotted Ave. power	-9 dB	-6 dB	-4.25 dB	-3 dB
Crest Factor	8	4	2.66	2

The time based average power for GPRS

Band	Channel No.	Frequency (MHz)	Time based average Power (dBm)			
			1 slot	2 slot	3 slots	4 slots
GSM 850	128	824.2	23.37	25.96	26.28	26.50
	190	836.6	23.55	26.10	26.44	26.62
	251	848.8	23.59	26.15	26.49	26.67
PCS 1900	512	1850.2	20.35	23.78	23.80	23.98
	661	1880.0	20.22	23.61	23.58	23.81
	810	1909.8	19.40	22.81	22.62	22.80

Note:

1. Rohde & Schwarz Radio Communication Tester (CMU200) was used for the measurement of GSM peak and average output power for active timeslots.
2. For GSM voice, 1 timeslot has been activated with power level 5 (850 MHz band) and 0 (1900 MHz band).
3. For GPRS, 1, 2, 3 and 4 timeslots has been activated separately with power level 5(850 MHz band) and 0(1900 MHz band).

WCDMA-Release 99:

The following tests were conducted according to the test requirements outlines in section 5.2 of the 3GPP TS34.121-1 specification. The EUT has a nominal maximum output power of 24dBm (+1.7/-3.7).

WCDMA General Settings	Loopback Mode	Test Mode 1
	Rel99 RMC	12.2kbps RMC
	Power Control Algorithm	Algorithm2
	β_c / β_d	8/15

Results (12.2kbps RMC)

Band	Frequency (MHz)	Channel NO.	Conducted Output Power	
			(dBm)	(Watt)
WCDMA 850	826.4	4132	23.14	0.206
	836.6	4183	22.93	0.196
	846.6	4233	22.77	0.189
WCDMA 1900	1852.4	9262	22.59	0.182
	1880.0	9400	22.87	0.194
	1907.6	9538	21.70	0.148

WCDMA HSDPA

The following tests were conducted according to the test requirements outlines in section 5.2 of the 3GPP TS34.121-1 specification.

	Mode	HSDPA	HSDPA	HSDPA	HSDPA
	Subset	1	2	3	4
WCDMA General Settings	Loopback Mode	Test Mode 1			
	Rel99 RMC	12.2kbps RMC			
	HSDPA FRC	H-Set1			
	Power Control Algorithm	Algorithm2			
	β_c	2/15	12/15	15/15	15/15
	β_d	15/15	15/15	8/15	4/15
	β_d (SF)	64			
	β_c / β_d	2/15	12/15	15/8	15/4
	β_{hs}	4/15	24/15	30/15	30/15
	MPR(dB)	0	0	0.5	0.5
HSDPA Specific Settings	D_{ACK}	8			
	D_{NAK}	8			
	D_{CQI}	8			
	Ack-Nack repetition factor	3			
	CQI Feedback	4ms			
	CQI Repetition Factor	2			
	$A_{hs} = \beta_{hs} / \beta_c$	30/15			

Results (HSDPA)

Band	Frequency (MHz)	Channel NO.	Conducted Output Power			
			Subset 1	Subset 2	Subset 3	Subset 4
WCDMA 850	826.4	4132	22.85	23.00	23.03	22.99
	836.6	4183	22.64	22.82	22.74	22.74
	846.6	4233	22.68	22.59	22.72	22.67
WCDMA 1900	1852.4	9262	22.35	22.49	22.53	22.51
	1880.0	9400	22.53	22.72	22.70	22.71
	1907.6	9538	21.68	21.58	21.61	21.60

WCDMA HSUPA

The following tests were conducted according to the test requirements outlines in section 5.2 of the 3GPP TS34.121-1 specification.

	Mode	HSUPA	HSUPA	HSUPA	HSUPA	HSUPA
	Subset	1	2	3	4	5
WCDMA General Settings	Loopback Mode	Test Mode 1				
	Rel99 RMC	12.2kbps RMC				
	HSDPA FRC	H-Set1				
	HSUPA Test	HSUPA Loopback				
	Power Control Algorithm	Algorithm2				
	β_c	11/15	6/15	15/15	2/15	15/15
	β_d	15/15	15/15	9/15	15/15	0
	β_{ec}	209/225	12/15	30/15	2/15	5/15
	β_c/β_d	11/15	6/15	15/9	2/15	-
	β_{hs}	22/15	12/15	30/15	4/15	5/15
CM(dB)	1.0	3.0	2.0	3.0	1.0	
MPR(dB)	0	2	1	2	0	
HSDPA Specific Settings	DACK	8				
	DNAK	8				
	DCQI	8				
	Ack-Nack repetition factor	3				
	CQI Feedback	4ms				
	CQI Repetition Factor	2				
	$A_{hs} = \beta_{hs}/\beta_c$	30/15				
HSUPA Specific Settings	DE-DPCCH	6	8	8	5	7
	DHARQ	0	0	0	0	0
	AG Index	20	12	15	17	21
	ETFCI	75	67	92	71	81
	Associated Max UL Data Rate kbps	242.1	174.9	482.8	205.8	308.9
	Reference E_FCIs	E-TFCI 11 E E-TFCI PO 4 E-TFCI 67 E-TFCI PO 18 E-TFCI 71 E-TFCI PO23 E-TFCI 75 E-TFCI PO26 E-TFCI 81 E-TFCI PO 27		E-TFCI 11 E-TFCI PO4 E-TFCI 92 E-TFCI PO 18		E-TFCI 11 E E-TFCI PO 4 E-TFCI 67 E-TFCI PO 18 E-TFCI 71 E-TFCI PO23 E-TFCI 75 E-TFCI PO26 E-TFCI 81 E-TFCI PO 27

Results (HSUPA)

Band	Frequency (MHz)	Channel NO.	Conducted Output Power				
			Subset 1	Subset 2	Subset 3	Subset 4	Subset 5
WCDMA 850	826.4	4132	22.97	23.00	22.96	23.01	23.00
	836.6	4183	22.80	22.91	22.83	22.71	22.80
	846.6	4233	22.65	22.67	22.74	22.60	22.76
WCDMA 1900	1852.4	9262	22.46	22.48	22.43	22.45	22.46
	1880.0	9400	22.65	22.63	22.66	22.63	22.64
	1907.6	9538	21.56	21.52	21.53	21.56	21.54

Note:

1. The default test configuration is to measure SAR with an established radio link between the EUT and a communication test set using a 12.2 kbps RMC (reference measurement Channel) Configured in Test Loop Model 1.
2. KDB 941225 D01-Body SAR is not required for HSDPA when the maximum average output of each RF channel with HSDPA active is less than ¼ dB higher than measured without HSDPA using 12.2kbps RMC or the maximum SAR for 12.2kbps RMC is < 75% of SAR limit.
3. KDB 941225 D01-Body SAR is not required for HSUPA when the maximum average output of each RF channel with HSUPA active is less than ¼ dB higher than measured without HSUPA using 12.2kbps RMC and the maximum SAR for 12.2kbps RMC is < 75% of SAR limit.

Bluetooth

Mode	Channel frequency (MHz)	Reading power (dBm)	Power output (mw)	Limit (mw)
BDR(GFSK)	(Low)2402	3.92	2.466	1000
	(Middle)2441	4.70	2.951	1000
	(High)2480	4.58	2.871	1000
EDR(4-DQPSK)	(Low)2402	3.70	2.344	1000
	(Middle)2441	4.58	2.871	1000
	(High)2480	4.46	2.793	1000
EDR-8DPSK	(Low)2402	3.59	2.286	1000
	(Middle)2441	4.85	3.055	1000
	(High)2480	4.58	2.871	1000

WiFi

Band	Frequency (MHz)	Average Conducted Output Power	
		(dBm)	(mw)
802.11b	2412	15.85	38.459
	2437	15.15	32.734
	2462	15.19	33.037
802.11g	2412	13.38	21.777
	2437	12.72	18.707
	2462	12.59	18.155
802.11n20	2412	13.17	20.749
	2437	12.93	19.634
	2462	12.57	18.072
802.11n40	2412	13.37	21.727
	2437	12.78	18.967
	2462	12.91	19.543

Note:

1. The output power was tested under data rate 1Mbps for 802.11b, 6Mbps for 802.11g, 6.5Mbps for 802.11n-20 and 13.5Mbps for 802.11n-40.
2. KDB248227-SAR is not required for 802.11g/802.11n channels when the maximum average output power is less than 1/4 dB higher than that measured on the corresponding 802.11b channels.

SAR MEASUREMENT RESULTS

This page summarizes the results of the performed dosimetric evaluation.

SAR Test Data

Environmental Conditions

Temperature:	21-22° C
Relative Humidity:	50-53%
ATM Pressure:	1001-1002 mbar

* Testing was performed by Sandy Wang on 2013-7-16 to 2013-7-18 and 2013-7-30.

Cellular Band:

EUT Position	Date	Frequency (MHz)		Test Mode	Power Drift (%)	Max. Meas. Power (dBm)	Max. Rated Power (dBm)	FCC 1g SAR (W/Kg)		
		Channel	MHz					Scaled Factor	Meas. SAR	Scaled SAR
Left Head Cheek	2013-7-30	128(Low)	824.2	GSM	1.538	31.88	32.50	1.153	0.630	0.726
	2013-7-30	190(Middle)	836.6	GSM	0.923	32.03	32.50	1.114	0.765	0.856
	2013-7-16	251(High)	848.8	GSM	0.773	32.05	32.50	1.109	0.720	0.798
Left Head Tilt	/	128(Low)	824.2	GSM	/	/	/	/	/	/
	2013-7-30	190(Middle)	836.6	GSM	-1.625	32.03	32.50	1.114	0.451	0.502
	/	251(High)	848.8	GSM	/	/	/	/	/	/
Right Head Cheek	/	128(Low)	824.2	GSM	/	/	/	/	/	/
	2013-7-30	190(Middle)	836.6	GSM	2.493	32.03	32.50	1.114	0.712	0.793
	/	251(High)	848.8	GSM	/	/	/	/	/	/
Right Head Tilt	/	128(Low)	824.2	GSM	/	/	/	/	/	/
	2013-7-30	190(Middle)	836.6	GSM	1.746	32.03	32.50	1.114	0.430	0.479
	/	251(High)	848.8	GSM	/	/	/	/	/	/
Body-Front-Headset (15mm)	/	128(Low)	824.2	GSM	/	/	/	/	/	/
	2013-7-30	190(Middle)	836.6	GSM	2.367	32.03	32.50	1.114	0.223	0.248
	/	251(High)	848.8	GSM	/	/	/	/	/	/
Body-Back-Headset (15mm)	/	128(Low)	824.2	GSM	/	/	/	/	/	/
	2013-7-30	190(Middle)	836.6	GSM	-1.378	32.03	32.50	1.114	0.278	0.310
	/	251(High)	848.8	GSM	/	/	/	/	/	/
Body-Front (15mm)	/	128(Low)	824.2	GPRS	/	/	/	/	/	/
	2013-7-30	190(Middle)	836.6	GPRS	-1.462	32.03	32.50	1.114	0.372	0.414
	/	251(High)	848.8	GPRS	/	/	/	/	/	/
Body-Back (15mm)	/	128(Low)	824.2	GPRS	/	/	/	/	/	/
	2013-7-30	190(Middle)	836.6	GPRS	-1.340	32.03	32.50	1.114	0.493	0.549
	/	251(High)	848.8	GPRS	/	/	/	/	/	/

PCS Band:

EUT Position	Date	Frequency (MHz)		Test Mode	Power Drift (%)	Max. Meas. Power (dBm)	Max. Rated Power (dBm)	FCC 1g SAR (W/Kg)		
		Channel	MHz					Scaled Factor	Meas. SAR	Scaled SAR
Left Head Cheek	2013-7-16	512(Low)	1850.2	GSM	0.868	30.10	30.50	1.097	0.226	0.248
	2013-7-30	661(Middle)	1880.0	GSM	1.862	29.93	30.50	1.140	0.221	0.252
	2013-7-30	810(High)	1909.8	GSM	1.384	29.29	30.50	1.321	0.222	0.293
Left Head Tilt	/	512(Low)	1850.2	GSM	/	/	/	/	/	/
	2013-7-30	661(Middle)	1880.0	GSM	-1.742	29.93	30.50	1.140	0.069	0.079
	/	810(High)	1909.8	GSM	/	/	/	/	/	/
Right Head Cheek	/	512(Low)	1850.2	GSM	/	/	/	/	/	/
	2013-7-30	661(Middle)	1880.0	GSM	-0.948	29.93	30.50	1.140	0.216	0.246
	/	810(High)	1909.8	GSM	/	/	/	/	/	/
Right Head Tilt	/	512(Low)	1850.2	GSM	/	/	/	/	/	/
	2013-7-30	661(Middle)	1880.0	GSM	1.527	29.93	30.50	1.140	0.069	0.079
	/	810(High)	1909.8	GSM	/	/	/	/	/	/
Body-Front-Headset (15mm)	/	512(Low)	1850.2	GSM	/	/	/	/	/	/
	2013-7-30	661(Middle)	1880.0	GSM	-0.548	29.93	30.50	1.140	0.094	0.107
	/	810(High)	1909.8	GSM	/	/	/	/	/	/
Body-Back-Headset (15mm)	/	512(Low)	1850.2	GSM	/	/	/	/	/	/
	2013-7-30	661(Middle)	1880.0	GSM	-1.139	29.93	30.50	1.140	0.192	0.219
	/	810(High)	1909.8	GSM	/	/	/	/	/	/
Body-Front (15mm)	/	512(Low)	1850.2	GPRS	/	/	/	/	/	/
	2013-7-30	661(Middle)	1880.0	GPRS	3.428	29.93	30.50	1.140	0.162	0.185
	/	810(High)	1909.8	GPRS	/	/	/	/	/	/
Body-Back (15mm)	/	512(Low)	1850.2	GPRS	/	/	/	/	/	/
	2013-7-30	661(Middle)	1880.0	GPRS	2.307	29.93	30.50	1.140	0.289	0.329
	/	810(High)	1909.8	GPRS	/	/	/	/	/	/

Note:

1. When the 1-g SAR is $\leq 0.8\text{W/Kg}$, testing for other channels are optional.
2. The EUT is a Capability Class B mobile phone which can be attached to both GPRS and GSM services.
3. The Multi-slot Classes of EUT is Class 12 which has maximum 4 Downlink slots and 4 Uplink slots, the maximum active slots is 5, when perform the multiple slots scan, 1DL+4UL is the worse case.
4. The EUT transmit and receive through the same GSM antenna while testing SAR.
5. When SAR or MPE is not measured at the maximum power level allowed for production units, the results must be scaled to the maximum tune-up tolerance limit according to the power applied to the individual channels tested to determine compliance.

WCDMA 850

Date: 2013-07-16

EUT Position	Frequency (MHz)		Test Mode	Power Drift (%)	Max. Meas. Power (dBm)	Max. Rated Power (dBm)	FCC 1g SAR (W/Kg)		
	Channel	MHz					Scaled Factor	Meas. SAR	Scaled SAR
Left Head Cheek	4132	826.4	WCDMA 850	0.754	23.14	23.50	1.087	0.421	0.458
	4183	836.6	WCDMA 850	/	/	/	/	/	/
	4233	846.6	WCDMA 850	/	/	/	/	/	/
Left Head Tilt	4132	826.4	WCDMA 850	0.925	23.14	23.50	1.087	0.284	0.309
	4183	836.6	WCDMA 850	/	/	/	/	/	/
	4233	846.6	WCDMA 850	/	/	/	/	/	/
Right Head Cheek	4132	826.4	WCDMA 850	-0.593	23.14	23.50	1.087	0.417	0.453
	4183	836.6	WCDMA 850	/	/	/	/	/	/
	4233	846.6	WCDMA 850	/	/	/	/	/	/
Right Head Tilt	4132	826.4	WCDMA 850	0.686	23.14	23.50	1.087	0.279	0.303
	4183	836.6	WCDMA 850	/	/	/	/	/	/
	4233	846.6	WCDMA 850	/	/	/	/	/	/
Body-Front (15mm)	4132	826.4	WCDMA 850	0.680	23.14	23.50	1.087	0.170	0.185
	4183	836.6	WCDMA 850	/	/	/	/	/	/
	4233	846.6	WCDMA 850	/	/	/	/	/	/
Body-Back (15mm)	4132	826.4	WCDMA 850	0.356	23.14	23.50	1.087	0.305	0.332
	4183	836.6	WCDMA 850	/	/	/	/	/	/
	4233	846.6	WCDMA 850	/	/	/	/	/	/

WCDMA1900**Date: 2013-07-16**

EUT Position	Frequency (MHz)		Test Mode	Power Drift (%)	Max. Meas. Power (dBm)	Max. Rated Power (dBm)	FCC 1g SAR (W/Kg)		
	Channel	MHz					Scaled Factor	Meas. SAR	Scaled SAR
Left Head Cheek	9262	1852.4	WCDMA1900	/	/	/	/	/	/
	9400	1880.0	WCDMA1900	-0.856	22.87	23.00	1.031	0.441	0.455
	9538	1907.6	WCDMA1900		/	/	/		
Left Head Tilt	9262	1852.4	WCDMA1900	/	/	/	/	/	/
	9400	1880.0	WCDMA1900	0.617	22.87	23.00	1.031	0.151	0.156
	9538	1907.6	WCDMA1900		/	/	/		
Right Head Cheek	9262	1852.4	WCDMA1900	/	/	/	/	/	/
	9400	1880.0	WCDMA1900	0.589	22.87	23.00	1.031	0.425	0.438
	9538	1907.6	WCDMA1900		/	/	/		
Right Head Tilt	9262	1852.4	WCDMA1900	/	/	/	/	/	/
	9400	1880.0	WCDMA1900	1.152	22.87	23.00	1.031	0.148	0.153
	9538	1907.6	WCDMA1900		/	/	/		
Body-Front (15mm)	9262	1852.4	WCDMA1900	/	/	/	/	/	/
	9400	1880.0	WCDMA1900	-1.000	22.87	23.00	1.031	0.127	0.131
	9538	1907.6	WCDMA1900		/	/	/		
Body-Back (15mm)	9262	1852.4	WCDMA1900	/	/	/	/	/	/
	9400	1880.0	WCDMA1900	0.713	22.87	23.00	1.031	0.489	0.504
	9538	1907.6	WCDMA1900		/	/	/		

Note:

1. When the 1-g SAR is ≤ 0.8 W/Kg, testing for other channels are optional.
2. The default test configuration is to measure SAR with an established radio link between the EUT and a communication test set using a 12.2 kbps RMC (reference measurement Channel) Configured in Test Loop Model.
3. KDB 941225 D01-Body SAR is not required for HSDPA when the maximum average output of each RF channel with HSDPA active is less than $\frac{1}{4}$ dB higher than measured without HSDPA using 12.2kbps RMC or the maximum SAR for 12.2kbps RMC is $< 75\%$ of SAR limit.
4. KDB 941225 D01-Body SAR is not required for HSUPA when the maximum average output of each RF channel with HSUPA active is less than $\frac{1}{4}$ dB higher than measured without HSUPA using 12.2kbps RMC and the maximum SAR for 12.2kbps RMC is $< 75\%$ of SAR limit.
5. When SAR or MPE is not measured at the maximum power level allowed for production units, the results must be scaled to the maximum tune-up tolerance limit according to the power applied to the individual channels tested to determine compliance.

Wi-Fi:**Date: 2013-07-16**

EUT Position	Frequency (MHz)		Test Mode	Power Drift (%)	Max. Meas. Power (dBm)	Max. Rated Power (dBm)	FCC 1g SAR (W/Kg)		
	Channel	MHz					Scaled Factor	Meas. SAR	Scaled SAR
Left Head Cheek	1	2412	802.11b	0.569	15.85	16.00	1.053	0.017	0.018
	6	2437	802.11b	/	/	/	/	/	/
	11	2462	802.11b	/	/	/	/	/	/
Left Head Tilt	1	2412	802.11b	0.859	15.85	16.00	1.053	0.013	0.014
	6	2437	802.11b	/	/	/	/	/	/
	11	2462	802.11b	/	/	/	/	/	/
Right Head Cheek	1	2412	802.11b	-0.527	15.85	16.00	1.053	0.015	0.016
	6	2437	802.11b	/	/	/	/	/	/
	11	2462	802.11b	/	/	/	/	/	/
Right Head Tilt	1	2412	802.11b	0.746	15.85	16.00	1.053	0.011	0.012
	6	2437	802.11b	/	/	/	/	/	/
	11	2462	802.11b	/	/	/	/	/	/
Body-Front (15mm)	1	2412	802.11b	0.882	15.85	16.00	1.053	0.014	0.015
	6	2437	802.11b	/	/	/	/	/	/
	11	2462	802.11b	/	/	/	/	/	/
Body-Back (15mm)	1	2412	802.11b	-0.539	15.85	16.00	1.053	0.015	0.016
	6	2437	802.11b	/	/	/	/	/	/
	11	2462	802.11b	/	/	/	/	/	/
Body-Right (15mm)	1	2412	802.11b	0.923	15.85	16.00	1.053	0.011	0.012
	6	2437	802.11b	/	/	/	/	/	/
	11	2462	802.11b	/	/	/	/	/	/
Body-Top (15mm)	1	2412	802.11b	-0.754	15.85	16.00	1.053	0.010	0.011
	6	2437	802.11b	/	/	/	/	/	/
	11	2462	802.11b	/	/	/	/	/	/

Note:

1. When the 1-g SAR is $\leq 0.8\text{W/Kg}$, testing for other channels are optional.
2. The output power was tested under data rate 1Mbps for 802.11b.
3. When SAR or MPE is not measured at the maximum power level allowed for production units, the results must be scaled to the maximum tune-up tolerance limit according to the power applied to the individual channels tested to determine compliance.

SAR SIMULTANEOUS TRANSMISSION DESCRIPTION

KDB 447498D01 General RF Exposure Guidance v05 KDB 648474 D04 SAR Handsets Multi Xmitter and Ant v01

Stand-alone and simultaneous SAR evaluation for a cell phone with multiple transmitters is base on the antennas distance of each radio.

BT&WiFi and GSM Antenna Location:

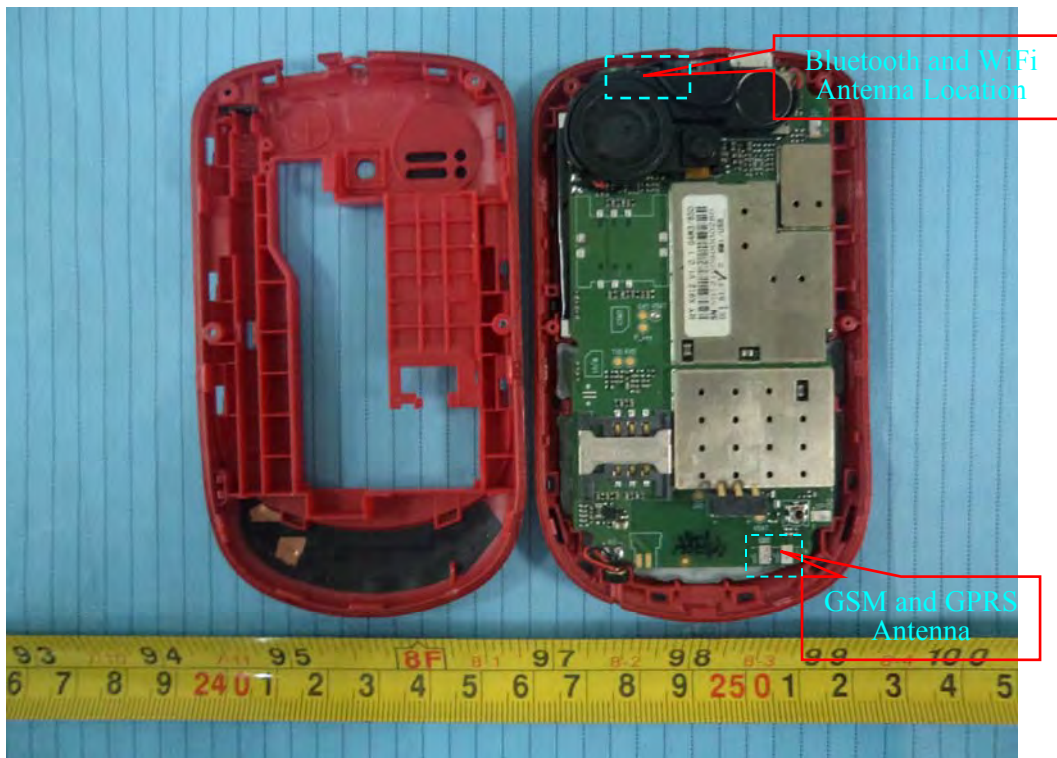

Antenna Information:

Description of Simultaneous Transmit Capabilities		Antennas Distance (mm)
Transmitter Combination	Simultaneous?	
GSM + GPRS	×	0
GSM + WCDMA	×	0
GSM + Bluetooth	√	72.0
GSM + WiFi	√	72.0
GPRS + WCDMA	×	0
GPRS + Bluetooth	√	72.0
GPRS + WiFi	√	72.0
WCDMA + Bluetooth	√	72.0
WCDMA + WiFi	√	72.0
WiFi+ Bluetooth	×	2.0

Standalone SAR test exclusion considerations

Head Position:

Mode	Frequency (MHz)	P _{avg} (dBm)	P _{avg} (mW)	Distance (mm)	Calculated value	Threshold (1-g)	SAR Test Exclusion
GSM850	850	23.05	201.837	0	37.2	3.0	No
PCS1900	1900	21.10	128.825	0	35.5	3.0	No
WCDMSA850	850	23.14	206.063	0	38.0	3.0	No
WCDMSA1900	1900	22.87	193.642	0	53.4	3.0	No
Bluetooth	2450	4.85	3.055	0	1.0	3.0	Yes
WiFi	2450	15.85	38.459	0	12.0	3.0	No

Body Position:

Mode	Frequency (MHz)	P _{avg} (dBm)	P _{avg} (mW)	Distance (mm)	Calculated value	Threshold (1-g)	SAR Test Exclusion
GSM850	850	26.67	464.515	15	28.6	3.0	No
PCS1900	1900	23.98	250.035	15	23.0	3.0	No
WCDMSA850	850	23.14	206.063	15	12.7	3.0	No
WCDMSA1900	1900	22.87	193.642	15	17.8	3.0	No
Bluetooth	2450	4.85	3.055	15	0.3	3.0	Yes
WiFi	2450	15.85	38.459	15	4.0	3.0	No

The 1-g and 10-g SAR test exclusion thresholds for 100 MHz to 6 GHz at *test separation distances* ≤ 50 mm are determined by:

$[(\text{max. power of channel, including tune-up tolerance, mW})/(\text{min. test separation distance, mm})] \cdot [\sqrt{f(\text{GHz})}] \leq 3.0$ for 1-g SAR and ≤ 7.5 for 10-g extremity SAR, where

1. f(GHz) is the RF channel transmit frequency in GHz.
2. Power and distance are rounded to the nearest mW and mm before calculation.
3. The result is rounded to one decimal place for comparison.
4. When the minimum test separation distance is < 5 mm, a distance of 5 mm is applied to determine SAR test Exclusion.

Simultaneous SAR test exclusion considerations:

GSM with Wi-Fi:

Mode	Position	Reported SAR (W/kg)		ΣSAR
		GSM	Wi-Fi	(W/kg)
GSM850	Left Head Cheek	0.856	0.018	0.874
	Left Head Tile	0.502	0.014	0.516
	Right Head Cheek	0.793	0.016	0.809
	Right Head Tilt	0.479	0.012	0.491
	Body-Headset-Front	0.248	0.015	0.263
	Body-Headset-Back	0.310	0.016	0.326
	Body-Front	0.414	0.015	0.429
	Body-Back	0.549	0.016	0.565
PCS1900	Left Head Cheek	0.293	0.018	0.311
	Left Head Tile	0.079	0.014	0.093
	Right Head Cheek	0.246	0.016	0.262
	Right Head Tilt	0.079	0.012	0.091
	Body-Headset-Front	0.107	0.015	0.122
	Body-Headset-Back	0.219	0.016	0.235
	Body-Front	0.185	0.015	0.200
	Body-Back	0.329	0.016	0.345

GSM with BT:

Mode	Position	Reported SAR (W/kg)		ΣSAR
		GSM	BT	(W/kg)
GSM850	Left Head Cheek	0.856	0.132	0.988
	Left Head Tile	0.502	0.132	0.634
	Right Head Cheek	0.793	0.132	0.925
	Right Head Tilt	0.479	0.132	0.611
	Body-Headset-Front	0.248	0.044	0.292
	Body-Headset-Back	0.310	0.044	0.354
	Body-Front	0.414	0.044	0.458
	Body-Back	0.549	0.044	0.593
PCS1900	Left Head Cheek	0.293	0.132	0.425
	Left Head Tile	0.079	0.132	0.211
	Right Head Cheek	0.246	0.132	0.378
	Right Head Tilt	0.079	0.132	0.211
	Body-Headset-Front	0.107	0.044	0.151
	Body-Headset-Back	0.219	0.044	0.263
	Body-Front	0.185	0.044	0.229
	Body-Back	0.329	0.044	0.373

WCDMA with Wi-Fi:

Mode	Position	Reported SAR (W/kg)		ΣSAR
		WCDMA	WiFi	(W/kg)
WCDMA 850	Left Head Cheek	0.458	0.018	0.476
	Left Head Tile	0.309	0.014	0.323
	Right Head Cheek	0.453	0.016	0.469
	Right Head Tilt	0.303	0.012	0.315
	Body-Headset-Front	0.185	0.015	0.200
	Body-Headset-Back	0.332	0.016	0.348
WCDMA 1900	Left Head Cheek	0.455	0.018	0.473
	Left Head Tile	0.156	0.014	0.170
	Right Head Cheek	0.438	0.016	0.454
	Right Head Tilt	0.153	0.012	0.165
	Body-Headset-Front	0.131	0.015	0.146
	Body-Headset-Back	0.504	0.016	0.520

WCDMA with BT:

Mode	Position	Reported SAR (W/kg)		ΣSAR
		WCDMA	BT	<(W/kg)
WCDMA 850	Left Head Cheek	0.458	0.132	0.590
	Left Head Tile	0.309	0.132	0.441
	Right Head Cheek	0.453	0.132	0.585
	Right Head Tilt	0.303	0.132	0.435
	Body-Headset-Front	0.185	0.044	0.229
	Body-Headset-Back	0.332	0.044	0.376
WCDMA 1900	Left Head Cheek	0.455	0.132	0.587
	Left Head Tile	0.156	0.132	0.288
	Right Head Cheek	0.438	0.132	0.57
	Right Head Tilt	0.153	0.132	0.285
	Body-Headset-Front	0.131	0.044	0.175
	Body-Headset-Back	0.504	0.044	0.548

Mode	Frequency (GHz)	Distance (mm)	P _{avg} (dBm)	P _{avg} (mW)	Estimated 1-g (W/kg)
Bluetooth Head	2.45	0	5	3.162	0.132
Bluetooth Body	2.45	15	5	3.162	0.044

Note:

When standalone SAR test exclusion applies to an antenna that transmits simultaneously with other antennas, the standalone SAR must be estimated according to following to determine simultaneous transmission SAR test exclusion:

$$[(\text{max. power of channel, including tune-up tolerance, mW})/(\text{min. test separation distance, mm})] \cdot [\sqrt{f(\text{GHz})}/x]$$

W/kg for test separation distances ≤ 50 mm;

where x = 7.5 for 1-g SAR.

When the minimum test separation distance is < 5 mm, a distance of 5 mm is applied to determine SAR test Exclusion

Conclusion:

ΣSAR < 1.6 W/kg therefore simultaneous transmission SAR with Volume Scans is **not** required.

EUT SCAN RESULTS

Test Laboratory: Bay Area Compliance Lab Corp. (Shenzhen)

Left Head Cheek (824.2 MHz Low Channel); Date: 2013-07-30

Measurement Data

Test mode : GSM
 Crest Factor : 8
 Scan Type : Complete
 Area Scan : 11x8x1: Measurement x=10mm, y=10mm, z=4mm
 Zoom Scan : 7x7x7: Measurement x=5mm, y=5mm, z=5mm
 Power Drift-Start : 0.009 W/kg
 Power Drift-Finish : 0.009 W/kg
 Power Drift (%) : 1.538

Tissue Data

Type : Head
 Frequency : 824.2 MHz
 Epsilon : 41.10 F/m
 Sigma : 0.90 S/m
 Density : 1000.00 kg/cu. m

Probe Data

Serial No. : 500-00283
 Frequency Band : 835
 Duty Cycle Factor : 8
 Conversion Factor : 6.6
 Probe Sensitivity : 1.20 1.20 1.20 $\mu\text{V}/(\text{V}/\text{m})^2$
 Compression Point : 95.00 mV
 Offset : 1.56 mm

1 gram SAR value : 0.630 W/kg
 10 gram SAR value : 0.496 W/kg
 Area Scan Peak SAR : 0.697 W/kg
 Zoom Scan Peak SAR : 1.172 W/kg

Plot 1#

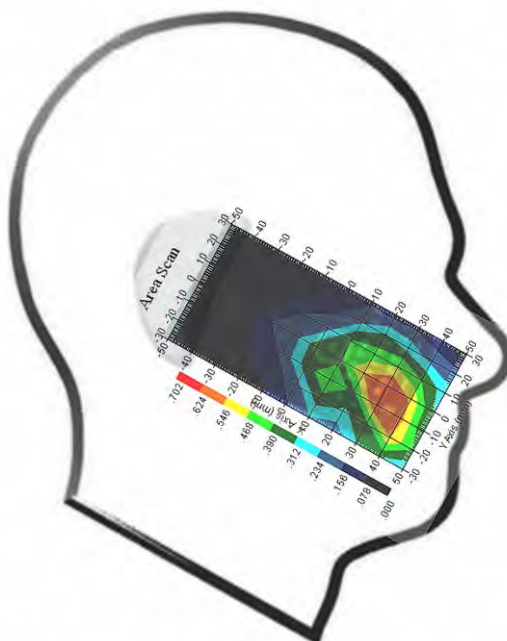

Test Laboratory: Bay Area Compliance Lab Corp. (Shenzhen)

Left Head Cheek (836.6 MHz Middle Channel); Date: 2013-07-30

Measurement Data

Test mode : GSM
 Crest Factor : 8
 Scan Type : Complete
 Area Scan : 11x8x1: Measurement x=10mm, y=10mm, z=4mm
 Zoom Scan : 7x7x7: Measurement x=5mm, y=5mm, z=5mm
 Power Drift-Start : 0.016 W/kg
 Power Drift-Finish : 0.017 W/kg
 Power Drift (%) : 0.923

Tissue Data

Type : Head
 Frequency : 836.6 MHz
 Epsilon : 41.05 F/m
 Sigma : 0.91 S/m
 Density : 1000.00 kg/cu. m

Probe Data

Serial No. : 500-00283
 Frequency Band : 835
 Duty Cycle Factor : 8
 Conversion Factor : 6.6
 Probe Sensitivity : 1.20 1.20 1.20 $\mu\text{V}/(\text{V}/\text{m})^2$
 Compression Point : 95.00 mV
 Offset : 1.56 mm

1 gram SAR value : 0.765 W/kg
 10 gram SAR value : 0.533 W/kg
 Area Scan Peak SAR : 0.808 W/kg
 Zoom Scan Peak SAR : 1.418 W/kg

Plot 2#

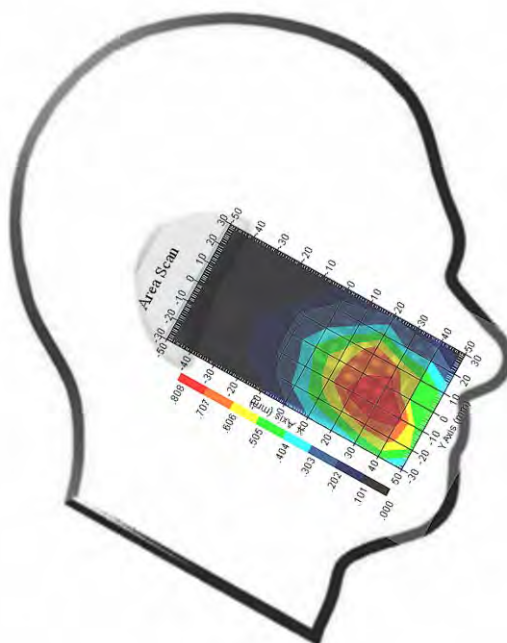

Test Laboratory: Bay Area Compliance Lab Corp. (Shenzhen)

Left Head Cheek (848.8MHz High Channel); Date: 2013-07-16

Measurement Data

Test mode : GSM
 Crest Factor : 8
 Scan Type : Complete
 Area Scan : 11x8x1: Measurement x=10mm, y=10mm, z=4mm
 Zoom Scan : 7x7x7: Measurement x=5mm, y=5mm, z=5mm
 Power Drift-Start : 0.012 W/kg
 Power Drift-Finish : 0.012 W/kg
 Power Drift (%) : 0.773

Tissue Data

Type : Head
 Frequency : 848.8 MHz
 Epsilon : 40.80 F/m
 Sigma : 0.93 S/m
 Density : 1000.00 kg/cu. m

Probe Data

Serial No. : 500-00283
 Frequency Band : 835
 Duty Cycle Factor : 8
 Conversion Factor : 6.6
 Probe Sensitivity : 1.20 1.20 1.20 $\mu\text{V}/(\text{V}/\text{m})^2$
 Compression Point : 95.00 mV
 Offset : 1.56 mm

1 gram SAR value : 0.720 W/kg
 10 gram SAR value : 0.501 W/kg
 Area Scan Peak SAR : 0.742 W/kg
 Zoom Scan Peak SAR : 1.201 W/kg

Plot 3#

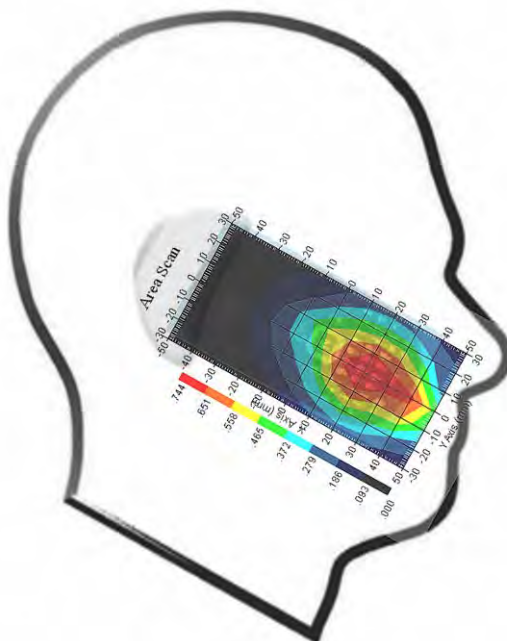

Test Laboratory: Bay Area Compliance Lab Corp. (Shenzhen)

Left Head Tilt (836.6MHz Middle Channel); Date: 2013-07-30

Measurement Data

Test mode : GSM
 Crest Factor : 8
 Scan Type : Complete
 Area Scan : 11x8x1: Measurement x=10mm, y=10mm, z=4mm
 Zoom Scan : 7x7x7: Measurement x=5mm, y=5mm, z=5mm
 Power Drift-Start : 0.013 W/kg
 Power Drift-Finish : 0.012 W/kg
 Power Drift (%) : -1.625

Tissue Data

Type : Head
 Frequency : 836.6 MHz
 Epsilon : 41.05 F/m
 Sigma : 0.91 S/m
 Density : 1000.00 kg/cu. m

Probe Data

Serial No. : 500-00283
 Frequency Band : 835
 Duty Cycle Factor : 8
 Conversion Factor : 6.6
 Probe Sensitivity : 1.20 1.20 1.20 $\mu\text{V}/(\text{V}/\text{m})^2$
 Compression Point : 95.00 mV
 Offset : 1.56 mm

1 gram SAR value : 0.451 W/kg
 10 gram SAR value : 0.242 W/kg
 Area Scan Peak SAR : 0.456 W/kg
 Zoom Scan Peak SAR : 0.620 W/kg

Plot 4#

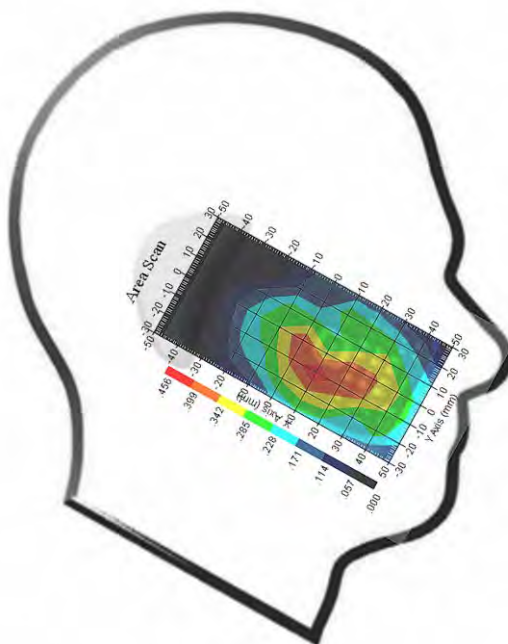

Test Laboratory: Bay Area Compliance Lab Corp. (Shenzhen)

Right Head Cheek (836.6MHz Middle Channel); Date: 2013-07-30

Measurement Data

Test mode : GSM
 Crest Factor : 8
 Scan Type : Complete
 Area Scan : 11x8x1: Measurement x=10mm, y=10mm, z=4mm
 Zoom Scan : 7x7x7: Measurement x=5mm, y=5mm, z=5mm
 Power Drift-Start : 0.016 W/kg
 Power Drift-Finish : 0.017 W/kg
 Power Drift (%) : 2.493

Tissue Data

Type : Head
 Frequency : 836.6 MHz
 Epsilon : 41.05 F/m
 Sigma : 0.91 S/m
 Density : 1000.00 kg/cu. m

Probe Data

Serial No. : 500-00283
 Frequency Band : 835
 Duty Cycle Factor : 8
 Conversion Factor : 6.6
 Probe Sensitivity : 1.20 1.20 1.20 $\mu\text{V}/(\text{V}/\text{m})^2$
 Compression Point : 95.00 mV
 Offset : 1.56 mm

1 gram SAR value : 0.712 W/kg
 10 gram SAR value : 0.419 W/kg
 Area Scan Peak SAR : 0.813 W/kg
 Zoom Scan Peak SAR : 1.353 W/kg

Plot 5#

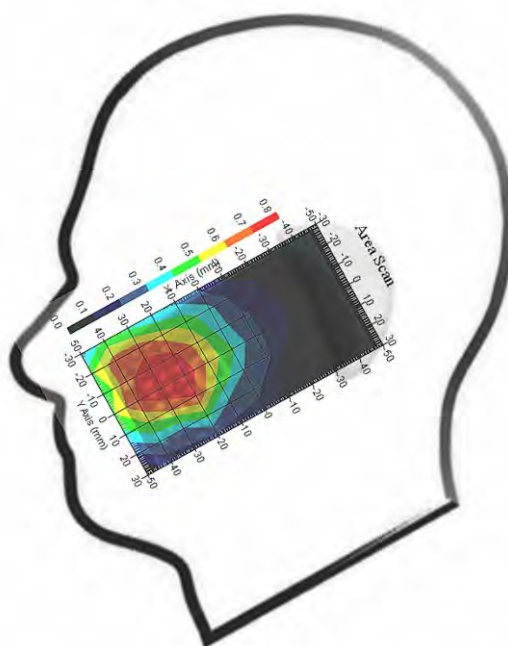

Test Laboratory: Bay Area Compliance Lab Corp. (Shenzhen)

Right Head Tilt (836.6MHz Middle Channel); Date: 2013-07-30

Measurement Data

Test mode : GSM
 Crest Factor : 8
 Scan Type : Complete
 Area Scan : 11x8x1: Measurement x=10mm, y=10mm, z=4mm
 Zoom Scan : 7x7x7: Measurement x=5mm, y=5mm, z=5mm
 Power Drift-Start : 0.012 W/kg
 Power Drift-Finish : 0.011 W/kg
 Power Drift (%) : 1.746

Tissue Data

Type : Head
 Frequency : 836.6 MHz
 Epsilon : 41.05 F/m
 Sigma : 0.91 S/m
 Density : 1000.00 kg/cu. m

Probe Data

Serial No. : 500-00283
 Frequency Band : 835
 Duty Cycle Factor : 8
 Conversion Factor : 6.6
 Probe Sensitivity : 1.20 1.20 1.20 $\mu\text{V}/(\text{V}/\text{m})^2$
 Compression Point : 95.00 mV
 Offset : 1.56 mm

1 gram SAR value : 0.430 W/kg
 10 gram SAR value : 0.262 W/kg
 Area Scan Peak SAR : 0.457 W/kg
 Zoom Scan Peak SAR : 0.610 W/kg

Plot 6#

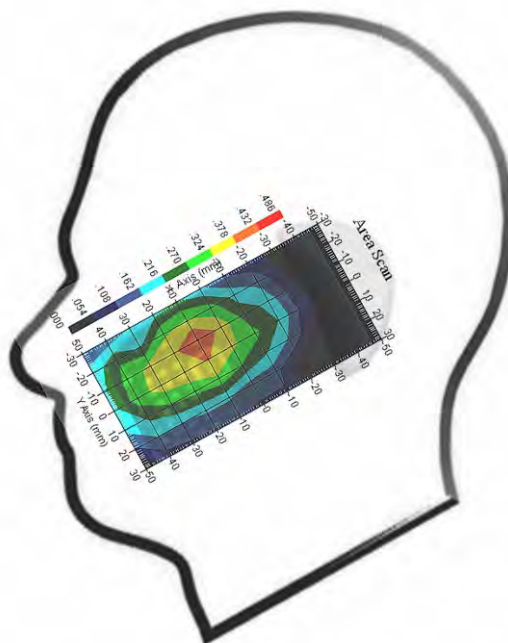

Test Laboratory: Bay Area Compliance Lab Corp. (Shenzhen)

Body-worn Front-Headset (836.6MHz Middle Channel); Date: 2013-07-30

Measurement Data

Test mode : GSM
 Crest Factor : 8
 Scan Type : Complete
 Area Scan : 8x11x1 : Measurement x=10mm, y=10mm, z=4mm
 Zoom Scan : 7x7x7 : Measurement x=5mm, y=5mm, z=5mm
 Power Drift-Start : 0.211 W/kg
 Power Drift-Finish : 0.216 W/kg
 Power Drift (%) : 2.367

Tissue Data

Type : Body
 Frequency : 836.6 MHz
 Epsilon : 55.21 F/m
 Sigma : 0.97 S/m
 Density : 1000.00 kg/cu. m

Probe Data

Serial No. : 500-00283
 Frequency Band : 835
 Duty Cycle Factor : 8
 Conversion Factor : 6.6
 Probe Sensitivity : 1.20 1.20 1.20 $\mu\text{V}/(\text{V}/\text{m})^2$
 Compression Point : 95.00 mV
 Offset : 1.56 mm

1 gram SAR value : 0.223 W/kg
 10 gram SAR value : 0.117 W/kg
 Area Scan Peak SAR : 0.231 W/kg
 Zoom Scan Peak SAR : 0.394 W/kg

Plot 7#

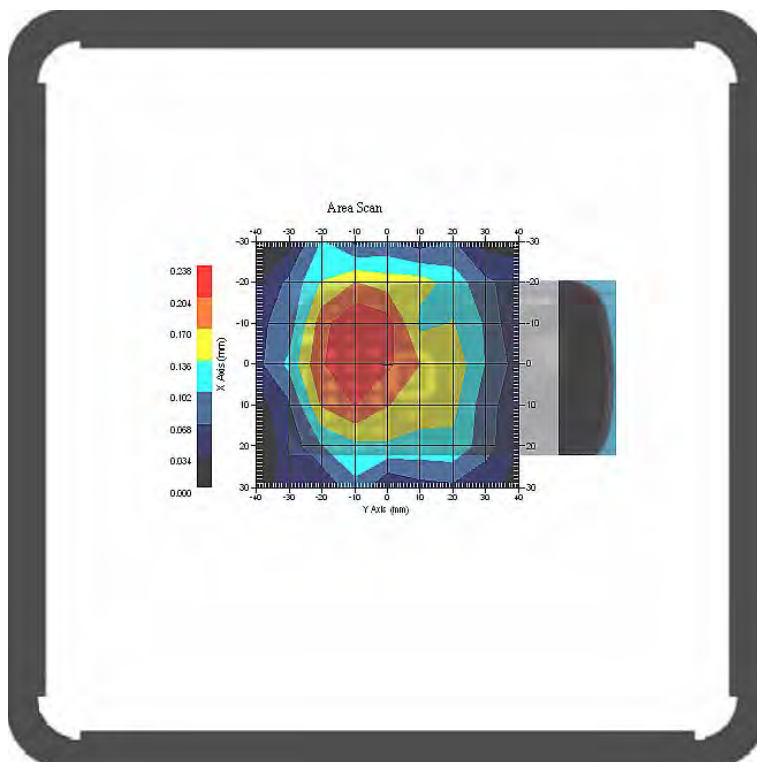

Test Laboratory: Bay Area Compliance Lab Corp. (Shenzhen)

Body-worn Back-Headset (836.6MHz Middle Channel); Date: 2013-07-30

Measurement Data

Test mode : GSM
 Crest Factor : 8
 Scan Type : Complete
 Area Scan : 8x11x1 : Measurement x=10mm, y=10mm, z=4mm
 Zoom Scan : 7x7x7 : Measurement x=5mm, y=5mm, z=5mm
 Power Drift-Start : 0.290 W/kg
 Power Drift-Finish : 0.286 W/kg
 Power Drift (%) : -1.378

Tissue Data

Type : Body
 Frequency : 836.6 MHz
 Epsilon : 55.21 F/m
 Sigma : 0.97 S/m
 Density : 1000.00 kg/cu. m

Probe Data

Serial No. : 500-00283
 Frequency Band : 835
 Duty Cycle Factor : 8
 Conversion Factor : 6.6
 Probe Sensitivity : 1.20 1.20 1.20 $\mu\text{V}/(\text{V}/\text{m})^2$
 Compression Point : 95.00 mV
 Offset : 1.56 mm

1 gram SAR value : 0.278 W/kg
 10 gram SAR value : 0.172 W/kg
 Area Scan Peak SAR : 0.300 W/kg
 Zoom Scan Peak SAR : 0.561 W/kg

Plot 8#

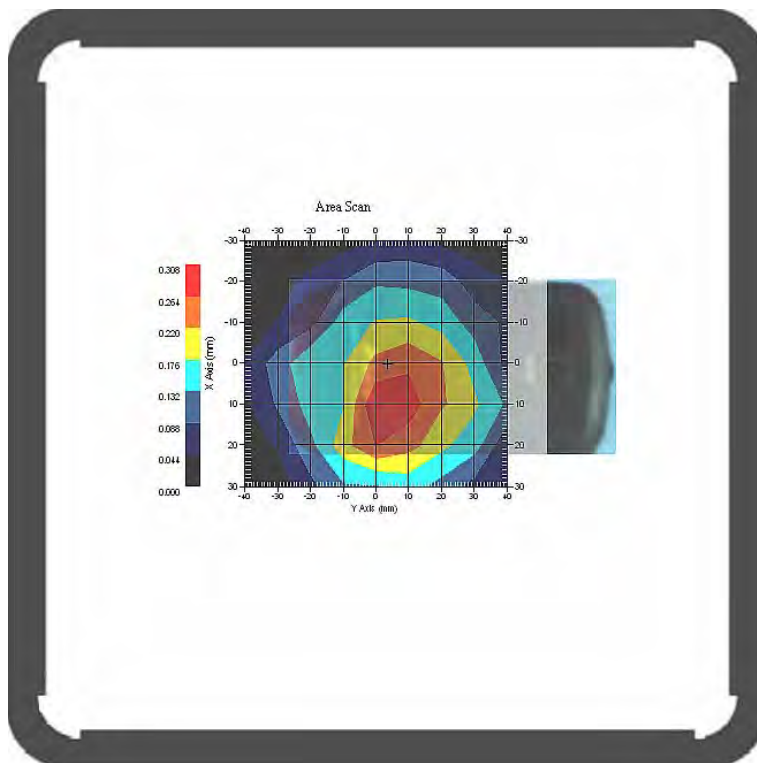

Test Laboratory: Bay Area Compliance Lab Corp. (Shenzhen)

Body-worn Front (836.6MHz Middle Channel); Date: 2013-07-30

Measurement Data

Test mode : GPRS
 Crest Factor : 2
 Scan Type : Complete
 Area Scan : 8x11x1 : Measurement x=10mm, y=10mm, z=4mm
 Zoom Scan : 7x7x7 : Measurement x=5mm, y=5mm, z=5mm
 Power Drift-Start : 0.342 W/kg
 Power Drift-Finish : 0.337 W/kg
 Power Drift (%) : -1.462

Tissue Data

Type : Body
 Frequency : 836.6 MHz
 Epsilon : 55.21 F/m
 Sigma : 0.97 S/m
 Density : 1000.00 kg/cu. m

Probe Data

Serial No. : 500-00283
 Frequency Band : 835
 Duty Cycle Factor : 2
 Conversion Factor : 6.6
 Probe Sensitivity : 1.20 1.20 1.20 $\mu\text{V}/(\text{V}/\text{m})^2$
 Compression Point : 95.00 mV
 Offset : 1.56 mm

1 gram SAR value : 0.372 W/kg
 10 gram SAR value : 0.192 W/kg
 Area Scan Peak SAR : 0.403 W/kg
 Zoom Scan Peak SAR : 0.622 W/kg

Plot 9#

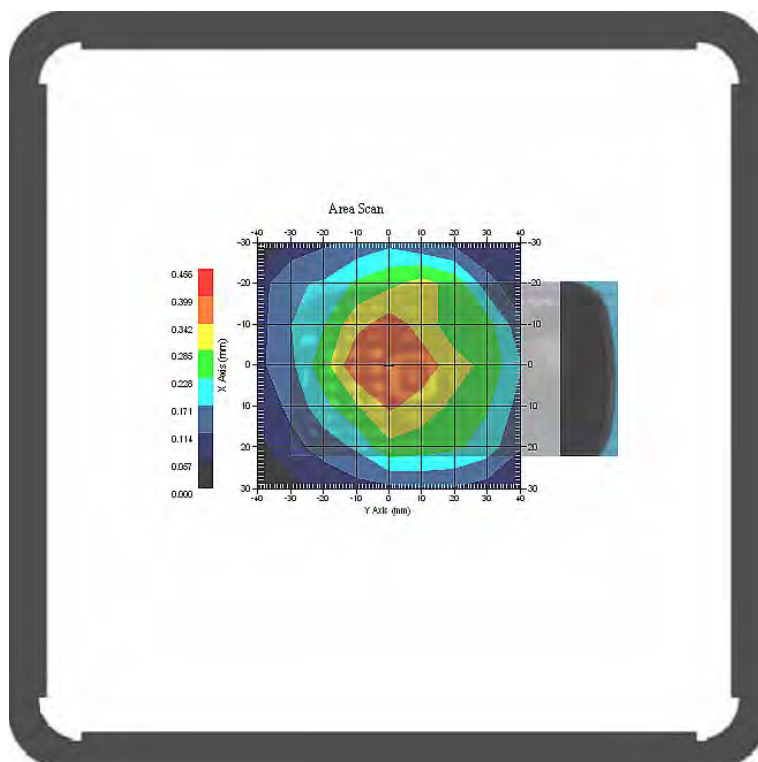

Test Laboratory: Bay Area Compliance Lab Corp. (Shenzhen)

Body-worn Back (836.6MHz Middle Channel); Date: 2013-07-30

Measurement Data

Test mode : GPRS
 Crest Factor : 2
 Scan Type : Complete
 Area Scan : 8x11x1 : Measurement x=10mm, y=10mm, z=4mm
 Zoom Scan : 7x7x7 : Measurement x=5mm, y=5mm, z=5mm
 Power Drift-Start : 0.531 W/kg
 Power Drift-Finish : 0.525 W/kg
 Power Drift (%) : -1.340

Tissue Data

Type : Body
 Frequency : 836.6 MHz
 Epsilon : 55.21 F/m
 Sigma : 0.97 S/m
 Density : 1000.00 kg/cu. m

Probe Data

Serial No. : 500-00283
 Frequency Band : 835
 Duty Cycle Factor : 2
 Conversion Factor : 6.6
 Probe Sensitivity : 1.20 1.20 1.20 $\mu\text{V}/(\text{V/m})^2$
 Compression Point : 95.00 mV
 Offset : 1.56 mm

1 gram SAR value : 0.493 W/kg
 10 gram SAR value : 0.241 W/kg
 Area Scan Peak SAR : 0.536 W/kg
 Zoom Scan Peak SAR : 0.864 W/kg

Plot 10#

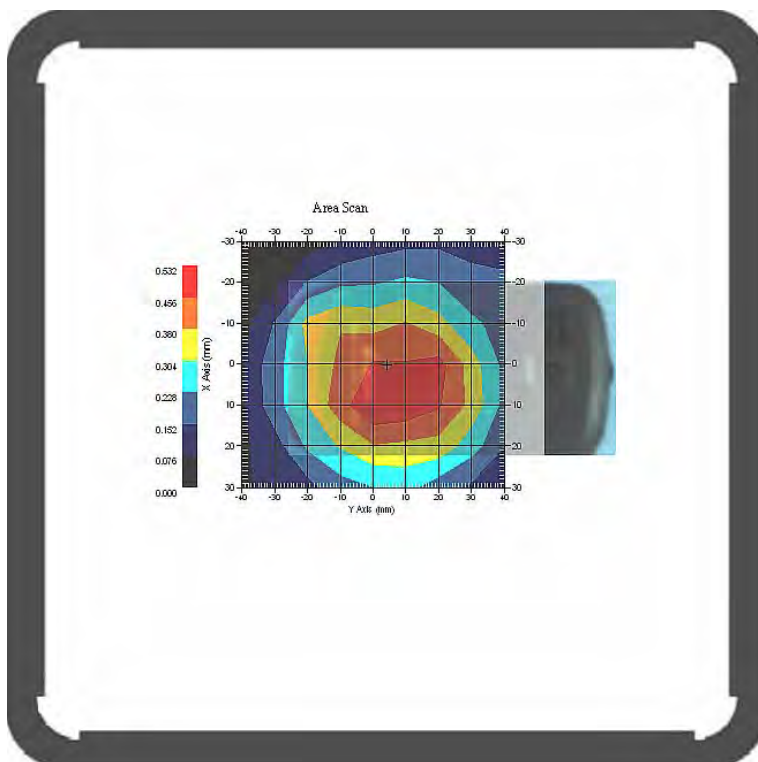

Test Laboratory: Bay Area Compliance Lab Corp. (Shenzhen)

Left Head Cheek (1850.2 MHz Low Channel); Date: 2013-07-16

Measurement Data

Test mode : GSM
 Crest Factor : 8
 Scan Type : Complete
 Area Scan : 11x8x1 : Measurement x=10mm, y=10mm, z=4mm
 Zoom Scan : 7x7x7 : Measurement x=5mm, y=5mm, z=5mm
 Power Drift-Start : 0.007 W/kg
 Power Drift-Finish : 0.007 W/kg
 Power Drift (%) : 0.868

Tissue Data

Type : Head
 Frequency : 1850.2 MHz
 Epsilon : 40.12 F/m
 Sigma : 1.38 S/m
 Density : 1000.00 kg/cu. m

Probe Data

Serial No. : 500-00283
 Frequency Band : 1900
 Duty Cycle Factor : 8
 Conversion Factor : 5.2
 Probe Sensitivity : 1.20 1.20 1.20 $\mu\text{V}/(\text{V}/\text{m})^2$
 Compression Point : 95.00 mV
 Offset : 1.56 mm

1 gram SAR value : 0.226 W/kg
 10 gram SAR value : 0.141 W/kg
 Area Scan Peak SAR : 0.236 W/kg
 Zoom Scan Peak SAR : 0.450 W/kg

Plot 11#

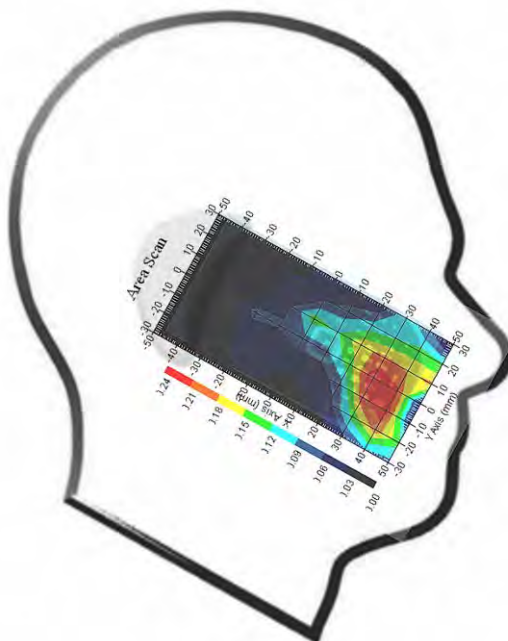

Test Laboratory: Bay Area Compliance Lab Corp. (Shenzhen)

Left Head Cheek (1880.0 MHz Middle Channel); Date: 2013-07-30

Measurement Data

Test mode : GSM
 Crest Factor : 8
 Scan Type : Complete
 Area Scan : 11x8x1 : Measurement x=10mm, y=10mm, z=4mm
 Zoom Scan : 7x7x7 : Measurement x=5mm, y=5mm, z=5mm
 Power Drift-Start : 0.007 W/kg
 Power Drift-Finish : 0.008 W/kg
 Power Drift (%) : 1.862

Tissue Data

Type : Head
 Frequency : 1880.0 MHz
 Epsilon : 40.42 F/m
 Sigma : 1.41 S/m
 Density : 1000.00 kg/cu. m

Probe Data

Serial No. : 500-00283
 Frequency Band : 1900
 Duty Cycle Factor : 8
 Conversion Factor : 5.2
 Probe Sensitivity : 1.20 1.20 1.20 $\mu\text{V}/(\text{V}/\text{m})^2$
 Compression Point : 95.00 mV
 Offset : 1.56 mm

1 gram SAR value : 0.221 W/kg
 10 gram SAR value : 0.125 W/kg
 Area Scan Peak SAR : 0.230 W/kg
 Zoom Scan Peak SAR : 0.445 W/kg

Plot 12#

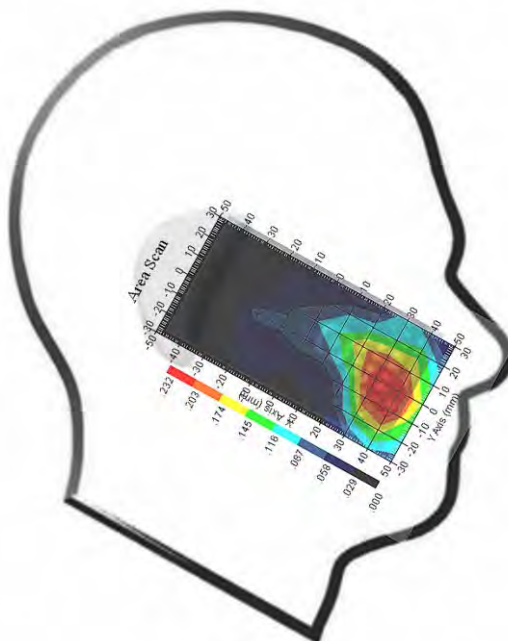

Test Laboratory: Bay Area Compliance Lab Corp. (Shenzhen)

Left Head Cheek (1909.8 MHz High Channel); Date: 2013-07-30

Measurement Data

Test mode : GSM
 Crest Factor : 8
 Scan Type : Complete
 Area Scan : 11x8x1 : Measurement x=10mm, y=10mm, z=4mm
 Zoom Scan : 7x7x7 : Measurement x=5mm, y=5mm, z=5mm
 Power Drift-Start : 0.009 W/kg
 Power Drift-Finish : 0.009 W/kg
 Power Drift (%) : 1.384

Tissue Data

Type : Head
 Frequency : 1909.8 MHz
 Epsilon : 40.52 F/m
 Sigma : 1.44 S/m
 Density : 1000.00 kg/cu. m

Probe Data

Serial No. : 500-00283
 Frequency Band : 1900
 Duty Cycle Factor : 8
 Conversion Factor : 5.2
 Probe Sensitivity : 1.20 1.20 1.20 $\mu\text{V}/(\text{V}/\text{m})^2$
 Compression Point : 95.00 mV
 Offset : 1.56 mm

1 gram SAR value : 0.222 W/kg
 10 gram SAR value : 0.137 W/kg
 Area Scan Peak SAR : 0.243 W/kg
 Zoom Scan Peak SAR : 0.472 W/kg

Plot 13#

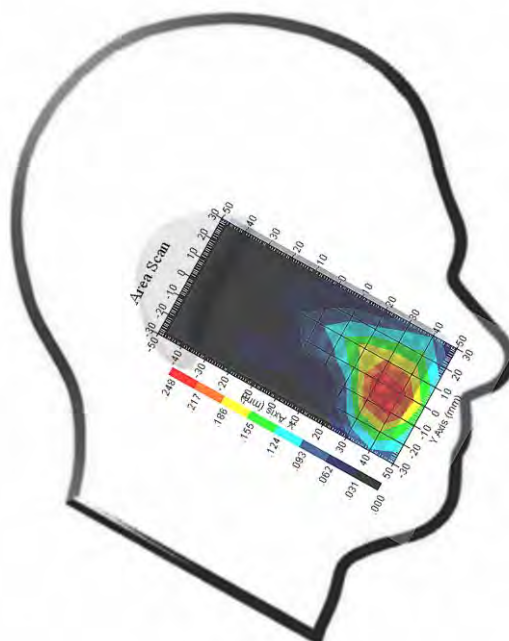

Test Laboratory: Bay Area Compliance Lab Corp. (Shenzhen)

Left Head Tilt (1880.0 MHz Middle Channel); Date: 2013-07-30

Measurement Data

Test mode : GSM
 Crest Factor : 8
 Scan Type : Complete
 Area Scan : 11x8x1 : Measurement x=10mm, y=10mm, z=4mm
 Zoom Scan : 7x7x7 : Measurement x=5mm, y=5mm, z=5mm
 Power Drift-Start : 0.003 W/kg
 Power Drift-Finish : 0.003 W/kg
 Power Drift (%) : -1.742

Tissue Data

Type : Head
 Frequency : 1880.0 MHz
 Epsilon : 40.42 F/m
 Sigma : 1.41 S/m
 Density : 1000.00 kg/cu. M

Probe Data

Serial No. : 500-00283
 Frequency Band : 1900
 Duty Cycle Factor : 8
 Conversion Factor : 5.2
 Probe Sensitivity : 1.20 1.20 1.20 $\mu\text{V}/(\text{V}/\text{m})^2$
 Compression Point : 95.00 mV
 Offset : 1.56 mm

1 gram SAR value : 0.069 W/kg
 10 gram SAR value : 0.034 W/kg
 Area Scan Peak SAR : 0.075 W/kg
 Zoom Scan Peak SAR : 0.128 W/kg

Plot 14#

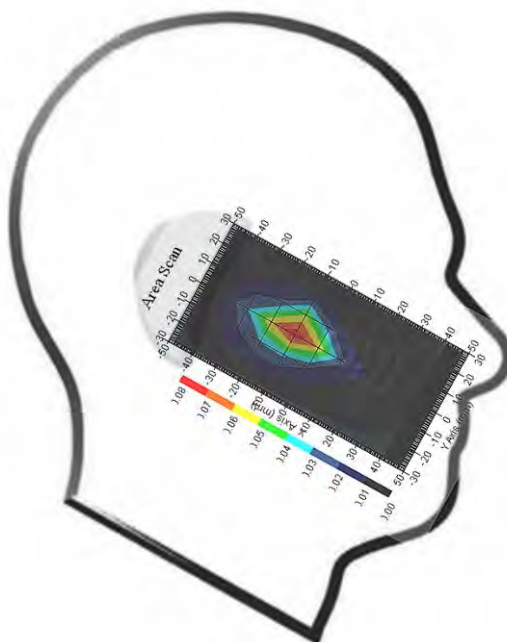

Test Laboratory: Bay Area Compliance Lab Corp. (Shenzhen)

Right Head Cheek (1880.0 MHz Middle Channel); Date: 2013-07-30

Measurement Data

Test mode : GSM
 Crest Factor : 8
 Scan Type : Complete
 Area Scan : 11x8x1 : Measurement x=10mm, y=10mm, z=4mm
 Zoom Scan : 7x7x7 : Measurement x=5mm, y=5mm, z=5mm
 Power Drift-Start : 0.014 W/kg
 Power Drift-Finish : 0.013W/kg
 Power Drift (%) : -0.948

Tissue Data

Type : Head
 Frequency : 1880.0 MHz
 Epsilon : 40.42 F/m
 Sigma : 1.41 S/m
 Density : 1000.00 kg/cu. m

Probe Data

Serial No. : 500-00283
 Frequency Band : 1900
 Duty Cycle Factor : 8
 Conversion Factor : 5.2
 Probe Sensitivity : 1.20 1.20 1.20 $\mu\text{V}/(\text{V/m})^2$
 Compression Point : 95.00 mV
 Offset : 1.56 mm

1 gram SAR value : 0.216 W/kg
 10 gram SAR value : 0.125 W/kg
 Area Scan Peak SAR : 0.237 W/kg
 Zoom Scan Peak SAR : 0.411 W/kg

Plot 15#

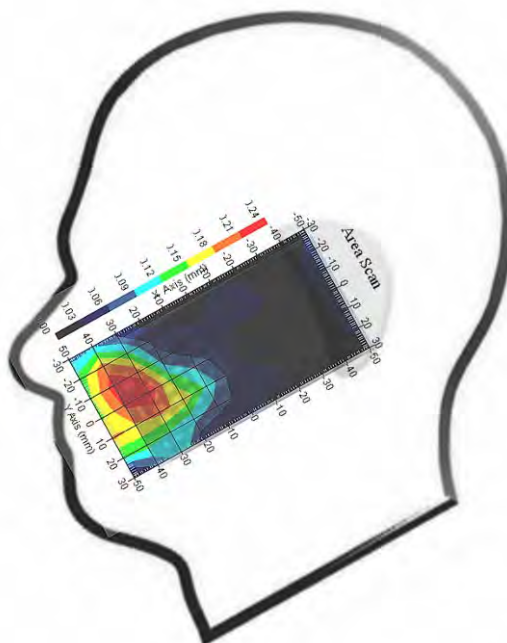

Test Laboratory: Bay Area Compliance Lab Corp. (Shenzhen)

Right Head Tilt (1880.0 MHz Middle Channel); Date: 2013-07-30

Measurement Data

Test mode : GSM
 Crest Factor : 8
 Scan Type : Complete
 Area Scan : 11x8x1 : Measurement x=10mm, y=10mm, z=4mm
 Zoom Scan : 7x7x7 : Measurement x=5mm, y=5mm, z=5mm
 Power Drift-Start : 0.005 W/kg
 Power Drift-Finish : 0.006 W/kg
 Power Drift (%) : 1.527

Tissue Data

Type : Head
 Frequency : 1880.0 MHz
 Epsilon : 40.42 F/m
 Sigma : 1.41 S/m
 Density : 1000.00 kg/cu. m

Probe Data

Serial No. : 500-00283
 Frequency Band : 1900
 Duty Cycle Factor : 8
 Conversion Factor : 5.2
 Probe Sensitivity : 1.20 1.20 1.20 $\mu\text{V}/(\text{V}/\text{m})^2$
 Compression Point : 95.00 mV
 Offset : 1.56 mm

1 gram SAR value : 0.069 W/kg
 10 gram SAR value : 0.033 W/kg
 Area Scan Peak SAR : 0.071 W/kg
 Zoom Scan Peak SAR : 0.124 W/kg

Plot 16#

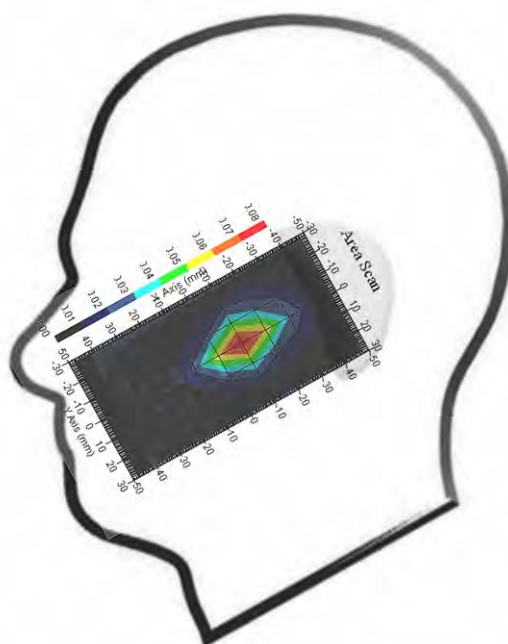

Test Laboratory: Bay Area Compliance Lab Corp. (Shenzhen)

Body-worn Front-Headset (1880.0 MHz Middle Channel); Date: 2013-07-30

Measurement Data

Test mode : GSM
 Crest Factor : 8
 Scan Type : Complete
 Area Scan : 8x11x1 : Measurement x=10mm, y=10mm, z=4mm
 Zoom Scan : 7x7x7 : Measurement x=5mm, y=5mm, z=5mm
 Power Drift-Start : 0.079 W/kg
 Power Drift-Finish : 0.078 W/kg
 Power Drift (%) : -0.548

Tissue Data

Type : Body
 Frequency : 1880.0 MHz
 Epsilon : 54.11 F/m
 Sigma : 1.54 S/m
 Density : 1000.00 kg/cu. m

Probe Data

Serial No. : 500-00283
 Frequency Band : 1900
 Duty Cycle Factor : 8
 Conversion Factor : 5.0
 Probe Sensitivity : 1.20 1.20 1.20 $\mu\text{V}/(\text{V}/\text{m})^2$
 Compression Point : 95.00 mV
 Offset : 1.56 mm

1 gram SAR value : 0.094 W/kg
 10 gram SAR value : 0.058 W/kg
 Area Scan Peak SAR : 0.129 W/kg
 Zoom Scan Peak SAR : 0.162 W/kg

Plot 17#

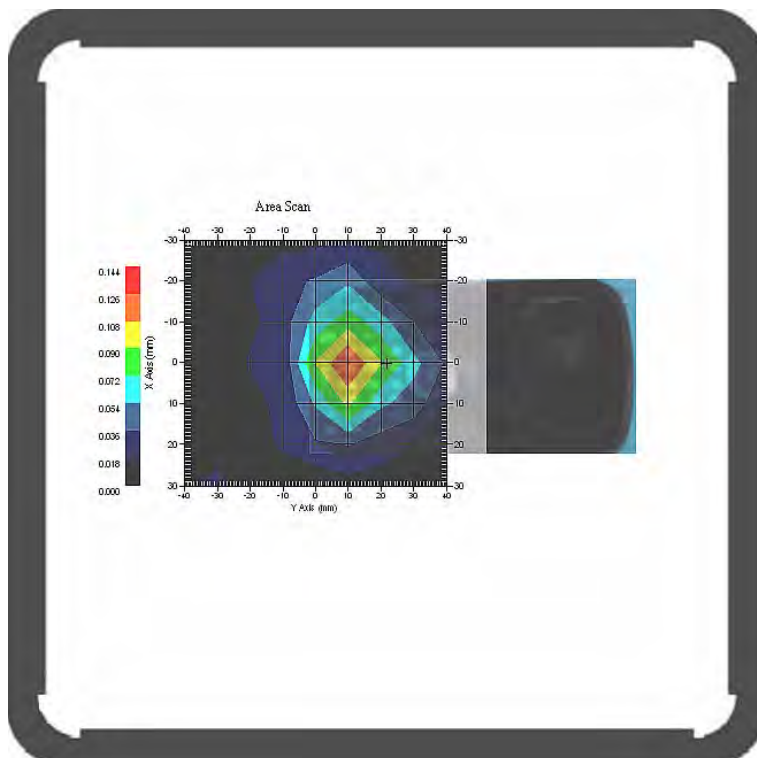

Test Laboratory: Bay Area Compliance Lab Corp. (Shenzhen)

Body-worn Back- Headset (1880.0 MHz Middle Channel); Date: 2013-07-30

Measurement Data

Test mode : GSM
 Crest Factor : 8
 Scan Type : Complete
 Area Scan : 8x11x1 : Measurement x=10mm, y=10mm, z=4mm
 Zoom Scan : 7x7x7 : Measurement x=5mm, y=5mm, z=5mm
 Power Drift-Start : 0.139 W/kg
 Power Drift-Finish : 0.134 W/kg
 Power Drift (%) :-1.139

Tissue Data

Type : Body
 Frequency : 1880.0 MHz
 Epsilon : 54.11 F/m
 Sigma : 1.54 S/m
 Density : 1000.00 kg/cu. m

Probe Data

Serial No. : 500-00283
 Frequency Band : 1900
 Duty Cycle Factor : 8
 Conversion Factor : 5.0
 Probe Sensitivity : 1.20 1.20 1.20 $\mu\text{V}/(\text{V/m})^2$
 Compression Point : 95.00 mV
 Offset : 1.56 mm

1 gram SAR value : 0.192 W/kg
 10 gram SAR value : 0.101 W/kg
 Area Scan Peak SAR : 0.212 W/kg
 Zoom Scan Peak SAR : 0.364 W/kg

Plot 18#

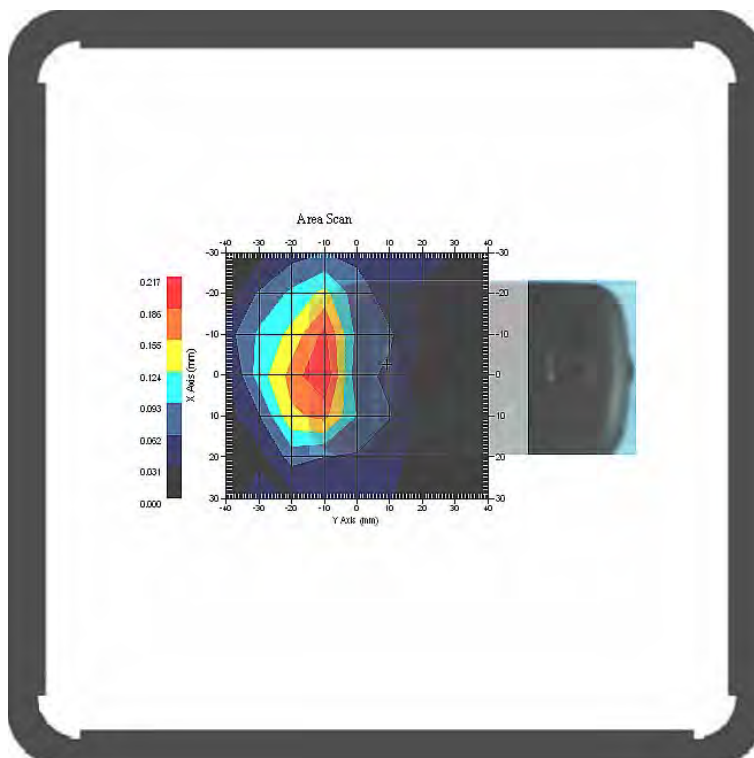

Test Laboratory: Bay Area Compliance Lab Corp. (Shenzhen)

Body-worn Front (1880.0 MHz Middle Channel); Date: 2013-07-30

Measurement Data

Test mode : GPRS
Crest Factor : 2
Scan Type : Complete
Area Scan : 8x11x1 : Measurement x=10mm, y=10mm, z=4mm
Zoom Scan : 7x7x7 : Measurement x=5mm, y=5mm, z=5mm
Power Drift-Start : 0.157 W/kg
Power Drift-Finish : 0.162 W/kg
Power Drift (%) : 3.428

Tissue Data

Type : Body
Frequency : 1880.0 MHz
Epsilon : 54.11 F/m
Sigma : 1.54 S/m
Density : 1000.00 kg/cu. m

Probe Data

Serial No. : 500-00283
Frequency Band : 1900
Duty Cycle Factor : 2
Conversion Factor : 5.0
Probe Sensitivity : 1.20 1.20 1.20 $\mu\text{V}/(\text{V/m})^2$
Compression Point : 95.00 mV
Offset : 1.56 mm

1 gram SAR value : 0.162 W/kg
10 gram SAR value : 0.098 W/kg
Area Scan Peak SAR : 0.185 W/kg
Zoom Scan Peak SAR : 0.274 W/kg

Plot 19#

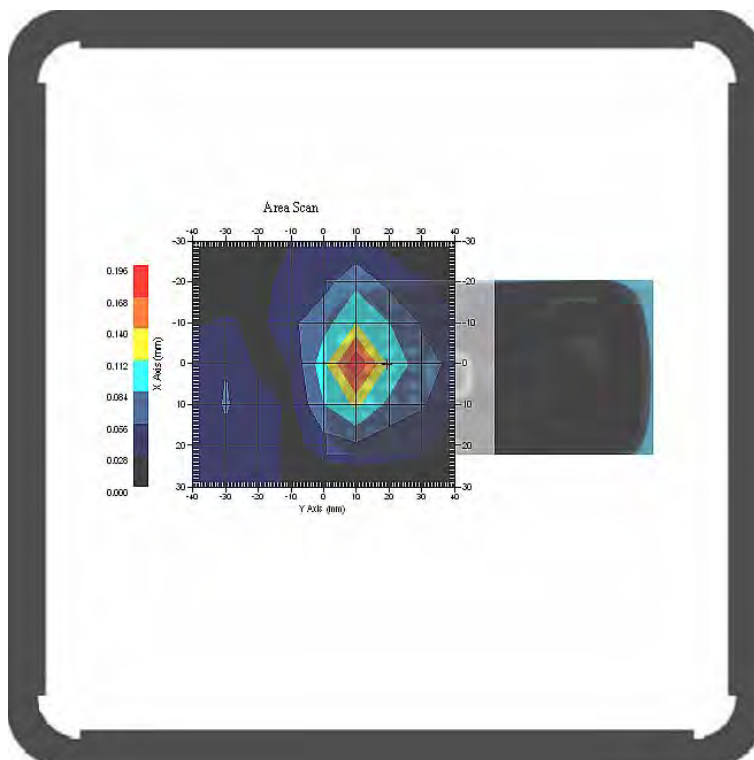

Test Laboratory: Bay Area Compliance Lab Corp. (Shenzhen)

Body-worn Back (1880.0 MHz Middle Channel); Date: 2013-07-30

Measurement Data

Test mode : GPRS
 Crest Factor : 2
 Scan Type : Complete
 Area Scan : 8x11x1 : Measurement x=10mm, y=10mm, z=4mm
 Zoom Scan : 7x7x7 : Measurement x=5mm, y=5mm, z=5mm
 Power Drift-Start : 0.233 W/kg
 Power Drift-Finish : 0.240 W/kg
 Power Drift (%) : 2.307

Tissue Data

Type : Body
 Frequency : 1880.0 MHz
 Epsilon : 54.11 F/m
 Sigma : 1.54 S/m
 Density : 1000.00 kg/cu. m

Probe Data

Serial No. : 500-00283
 Frequency Band : 1900
 Duty Cycle Factor : 2
 Conversion Factor : 5.0
 Probe Sensitivity : 1.20 1.20 1.20 $\mu\text{V}/(\text{V}/\text{m})^2$
 Compression Point : 95.00 mV
 Offset : 1.56 mm

1 gram SAR value : 0.289 W/kg
 10 gram SAR value : 0.172 W/kg
 Area Scan Peak SAR : 0.328 W/kg
 Zoom Scan Peak SAR : 0.492 W/kg

Plot 20#

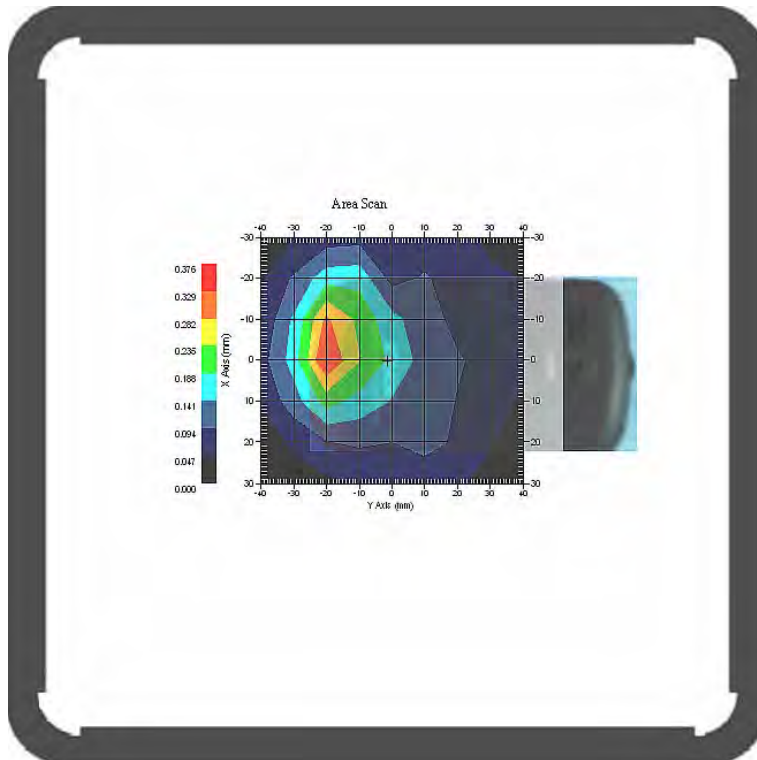

Test Laboratory: Bay Area Compliance Lab Corp. (Shenzhen)

WCDMA850; Left Head Cheek (826.4 MHz Low Channel); Date: 2013-07-16

Measurement Data

Test mode : WCDMA850
 Crest Factor : 1
 Scan Type : Complete
 Area Scan : 11x8x1: Measurement x=10mm, y=10mm, z=4mm
 Zoom Scan : 7x7x7: Measurement x=5mm, y=5mm, z=5mm
 Power Drift-Start : 0.012 W/kg
 Power Drift-Finish : 0.012 W/kg
 Power Drift (%) : 0.754

Tissue Data

Type : Head
 Frequency : 826.4 MHz
 Epsilon : 40.96 F/m
 Sigma : 0.90 S/m
 Density : 1000.00 kg/cu. m

Probe Data

Serial No. : 500-00283
 Frequency Band : 835
 Duty Cycle Factor : 1
 Conversion Factor : 6.6
 Probe Sensitivity : 1.20 1.20 1.20 $\mu\text{V}/(\text{V}/\text{m})^2$
 Compression Point : 95.00 mV
 Offset : 1.56 mm

1 gram SAR value : 0.421 W/kg
 10 gram SAR value : 0.213 W/kg
 Area Scan Peak SAR : 0.441 W/kg
 Zoom Scan Peak SAR : 0.590 W/kg

Plot 21#

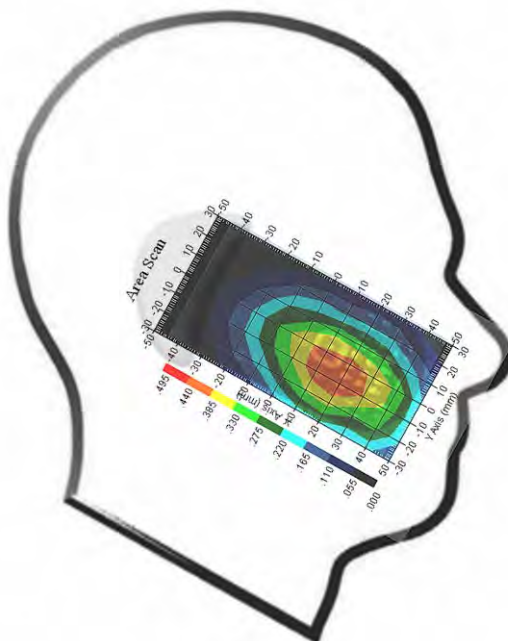

Test Laboratory: Bay Area Compliance Lab Corp. (Shenzhen)

WCDMA850; Left Head Tilt (826.4 MHz Low Channel); Date: 2013-07-16

Measurement Data

Test mode : WCDMA850
 Crest Factor : 1
 Scan Type : Complete
 Area Scan : 11x8x1: Measurement x=10mm, y=10mm, z=4mm
 Zoom Scan : 7x7x7: Measurement x=5mm, y=5mm, z=5mm
 Power Drift-Start : 0.011 W/kg
 Power Drift-Finish : 0.011 W/kg
 Power Drift (%) : 0.925

Tissue Data

Type : Head
 Frequency : 826.4 MHz
 Epsilon : 40.96 F/m
 Sigma : 0.90 S/m
 Density : 1000.00 kg/cu. m

Probe Data

Serial No. : 500-00283
 Frequency Band : 835
 Duty Cycle Factor : 1
 Conversion Factor : 6.6
 Probe Sensitivity : 1.20 1.20 1.20 $\mu\text{V}/(\text{V}/\text{m})^2$
 Compression Point : 95.00 mV
 Offset : 1.56 mm

1 gram SAR value : 0.284 W/kg
 10 gram SAR value : 0.145 W/kg
 Area Scan Peak SAR : 0.292 W/kg
 Zoom Scan Peak SAR : 0.380 W/kg

Plot 22#

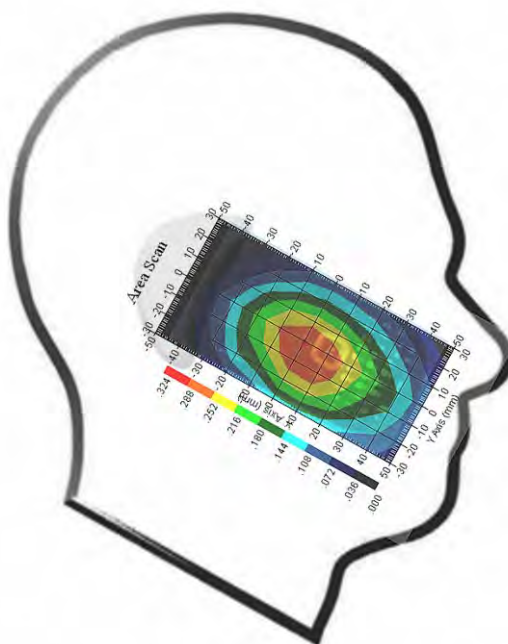

Test Laboratory: Bay Area Compliance Lab Corp. (Shenzhen)

WCDMA850; Right Head Cheek (826.4 MHz Low Channel); Date: 2013-07-16

Measurement Data

Test mode : WCDMA850
 Crest Factor : 1
 Scan Type : Complete
 Area Scan : 11x8x1: Measurement x=10mm, y=10mm, z=4mm
 Zoom Scan : 7x7x7: Measurement x=5mm, y=5mm, z=5mm
 Power Drift-Start : 0.008 W/kg
 Power Drift-Finish : 0.008 W/kg
 Power Drift (%) : -0.593

Tissue Data

Type : Head
 Frequency : 826.4 MHz
 Epsilon : 40.96 F/m
 Sigma : 0.90 S/m
 Density : 1000.00 kg/cu. m

Probe Data

Serial No. : 500-00283
 Frequency Band : 835
 Duty Cycle Factor : 1
 Conversion Factor : 6.6
 Probe Sensitivity : 1.20 1.20 1.20 $\mu\text{V}/(\text{V/m})^2$
 Compression Point : 95.00 mV
 Offset : 1.56 mm

1 gram SAR value : 0.417 W/kg
 10 gram SAR value : 0.210 W/kg
 Area Scan Peak SAR : 0.432 W/kg
 Zoom Scan Peak SAR : 0.580 W/kg

Plot 23#

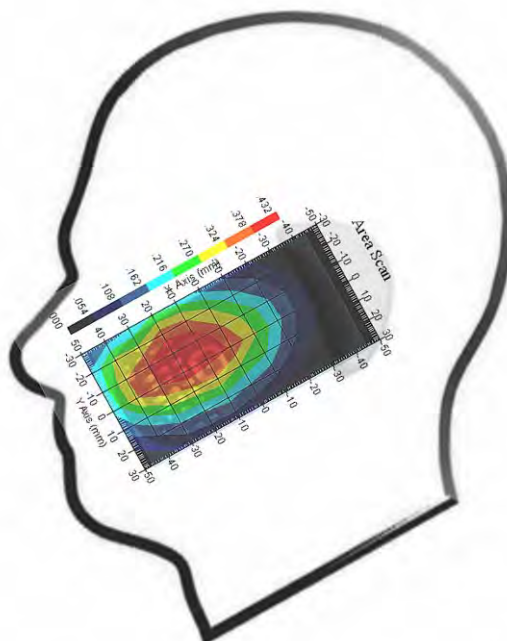

Test Laboratory: Bay Area Compliance Lab Corp. (Shenzhen)

WCDMA850; Right Head Tilt (826.4 MHz Low Channel); Date: 2013-07-16

Measurement Data

Test mode : WCDMA850
 Crest Factor : 1
 Scan Type : Complete
 Area Scan : 11x8x1: Measurement x=10mm, y=10mm, z=4mm
 Zoom Scan : 7x7x7: Measurement x=5mm, y=5mm, z=5mm
 Power Drift-Start : 0.004 W/kg
 Power Drift-Finish : 0.004 W/kg
 Power Drift (%) : 0.686

Tissue Data

Type : Head
 Frequency : 826.4 MHz
 Epsilon : 40.96 F/m
 Sigma : 0.90 S/m
 Density : 1000.00 kg/cu. m

Probe Data

Serial No. : 500-00283
 Frequency Band : 835
 Duty Cycle Factor : 1
 Conversion Factor : 6.6
 Probe Sensitivity : 1.20 1.20 1.20 $\mu\text{V}/(\text{V}/\text{m})^2$
 Compression Point : 95.00 mV
 Offset : 1.56 mm

1 gram SAR value : 0.279 W/kg
 10 gram SAR value : 0.136 W/kg
 Area Scan Peak SAR : 0.288 W/kg
 Zoom Scan Peak SAR : 0.450 W/kg

Plot 24#

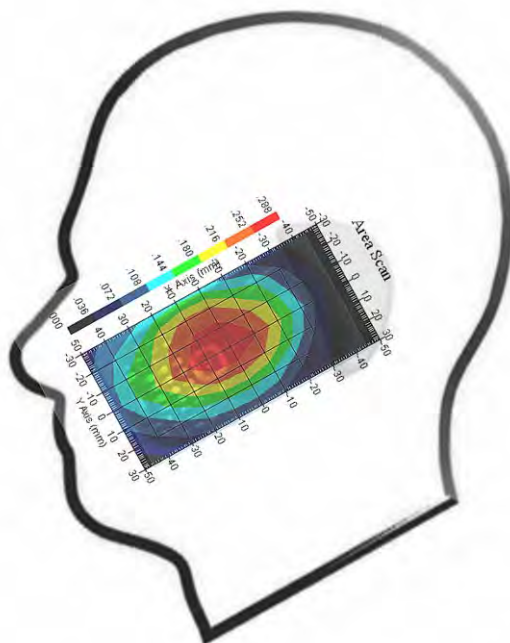

Test Laboratory: Bay Area Compliance Lab Corp. (Shenzhen)

WCDMA850; Body-Front (826.4 MHz Low Channel); Date: 2013-07-16

Measurement Data

Test mode : WCDMA850
 Crest Factor : 1
 Scan Type : Complete
 Area Scan : 9x11x1 : Measurement x=10mm, y=10mm, z=4mm
 Zoom Scan : 7x7x7 : Measurement x=5mm, y=5mm, z=5mm
 Power Drift-Start : 0.147 W/kg
 Power Drift-Finish : 0.148 W/kg
 Power Drift (%) : 0.680

Tissue Data

Type : Body
 Frequency : 826.4 MHz
 Epsilon : 55.15 F/m
 Sigma : 0.95 S/m
 Density : 1000.00 kg/cu. m

Probe Data

Serial No. : 500-00283
 Frequency : 835
 Duty Cycle Factor : 1
 Conversion Factor : 6.6
 Probe Sensitivity : 1.20 1.20 1.20 $\mu\text{V}/(\text{V}/\text{m})^2$
 Compression Point : 95.00 mV
 Offset : 1.56 mm

1 gram SAR value : 0.170 W/kg
 10 gram SAR value : 0.108 W/kg
 Area Scan Peak SAR : 0.179 W/kg
 Zoom Scan Peak SAR : 0.290 W/kg

Plot 25#

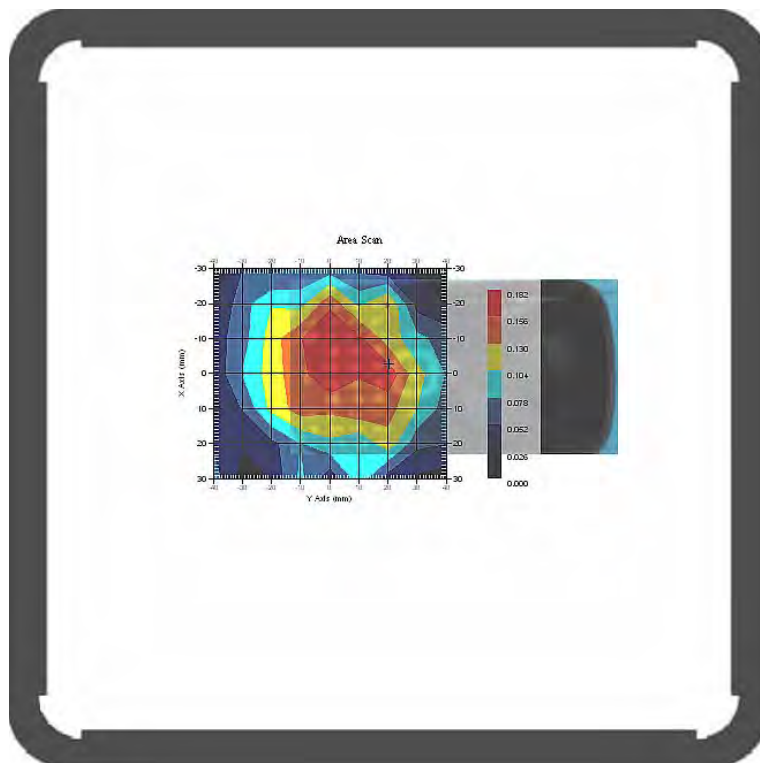

Test Laboratory: Bay Area Compliance Lab Corp. (Shenzhen)

WCDMA850; Body-Back (826.4 MHz Low Channel); Date: 2013-07-16

Measurement Data

Test mode : WCDMA850
Crest Factor : 1
Scan Type : Complete
Area Scan : 9x11x1 : Measurement x=10mm, y=10mm, z=4mm
Zoom Scan : 7x7x7 : Measurement x=5mm, y=5mm, z=5mm
Power Drift-Start : 0.281 W/kg
Power Drift-Finish : 0.282 W/kg
Power Drift (%) : 0.356

Tissue Data

Type : Body
Frequency : 826.4 MHz
Epsilon : 55.15 F/m
Sigma : 0.95 S/m
Density : 1000.00 kg/cu. m

Probe Data

Serial No. : 500-00283
Frequency : 835
Duty Cycle Factor : 1
Conversion Factor : 6.6
Probe Sensitivity : 1.20 1.20 1.20 $\mu\text{V}/(\text{V}/\text{m})^2$
Compression Point : 95.00 mV
Offset : 1.56 mm

1 gram SAR value : 0.305 W/kg
10 gram SAR value : 0.200 W/kg
Area Scan Peak SAR : 0.333 W/kg
Zoom Scan Peak SAR : 0.530 W/kg

Plot 26#

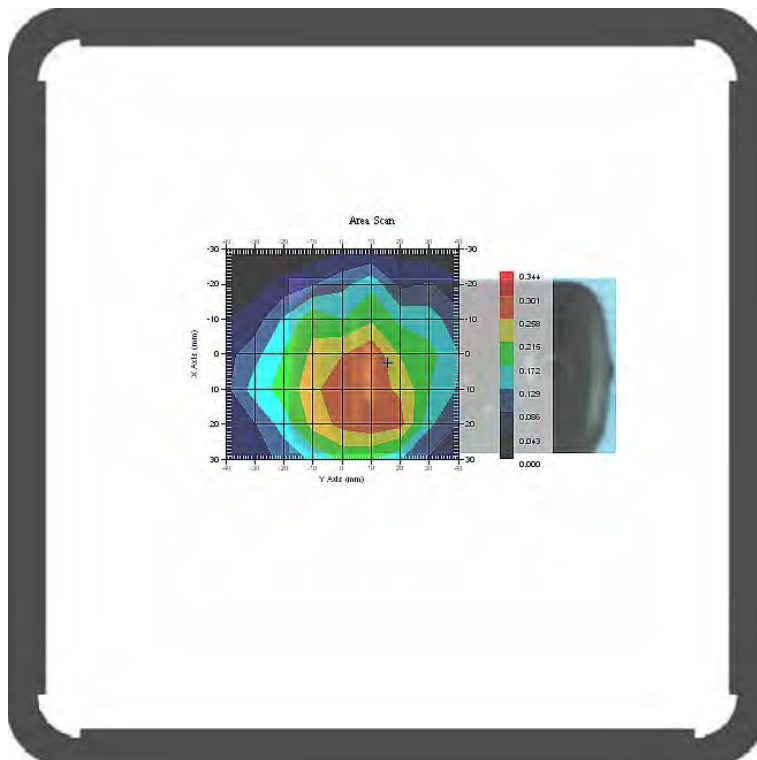

Test Laboratory: Bay Area Compliance Lab Corp. (Shenzhen)

WCDMA1900; Left Head Cheek (1880 MHz Middle Channel); Date: 2013-07-16

Measurement Data

Test mode : WCDMA1900
 Crest Factor : 1
 Scan Type : Complete
 Area Scan : 11x9x1: Measurement x=10mm, y=10mm, z=4mm
 Zoom Scan : 7x7x7: Measurement x=5mm, y=5mm, z=5mm
 Power Drift-Start : 0.006 W/kg
 Power Drift-Finish : 0.006 W/kg
 Power Drift (%) : -0.856

Tissue Data

Type : Head
 Frequency : 1880.0 MHz
 Epsilon : 40.17 F/m
 Sigma : 1.40 S/m
 Density : 1000.00 kg/cu. m

Probe Data

Serial No. : 500-00283
 Frequency Band : 1900
 Duty Cycle Factor : 1
 Conversion Factor : 5.2
 Probe Sensitivity : 1.20 1.20 1.20 $\mu\text{V}/(\text{V}/\text{m})^2$
 Compression Point : 95.00 mV
 Offset : 1.56 mm

1 gram SAR value : 0.441 W/kg
 10 gram SAR value : 0.224 W/kg
 Area Scan Peak SAR : 0.489 W/kg
 Zoom Scan Peak SAR : 0.710 W/kg

Plot 27#

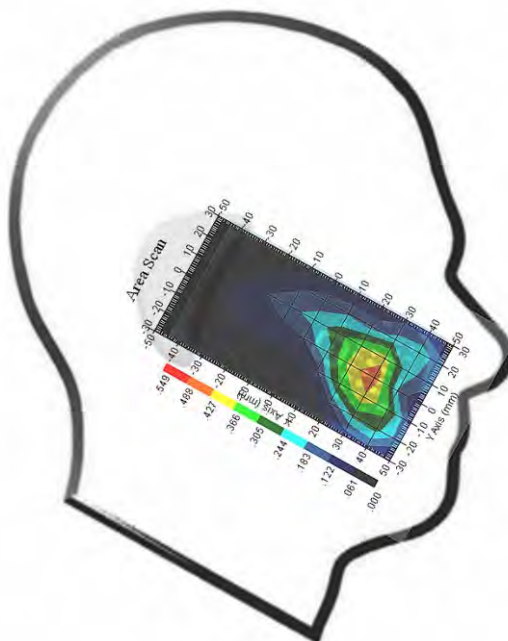

Test Laboratory: Bay Area Compliance Lab Corp. (Shenzhen)

WCDMA1900; Left Head Tilt (1880 MHz Middle Channel); Date: 2013-07-16

Measurement Data

Test mode : WCDMA1900
 Crest Factor : 1
 Scan Type : Complete
 Area Scan : 11x9x1: Measurement x=10mm, y=10mm, z=4mm
 Zoom Scan : 7x7x7: Measurement x=5mm, y=5mm, z=5mm
 Power Drift-Start : 0.013 W/kg
 Power Drift-Finish : 0.013 W/kg
 Power Drift (%) : 0.617

Tissue Data

Type : Head
 Frequency : 1880 MHz
 Epsilon : 40.17 F/m
 Sigma : 1.40 S/m
 Density : 1000.00 kg/cu. m

Probe Data

Serial No. : 500-00283
 Frequency Band : 1900
 Duty Cycle Factor : 1
 Conversion Factor : 5.2
 Probe Sensitivity : 1.20 1.20 1.20 $\mu\text{V}/(\text{V}/\text{m})^2$
 Compression Point : 95.00 mV
 Offset : 1.56 mm

1 gram SAR value : 0.151 W/kg
 10 gram SAR value : 0.076 W/kg
 Area Scan Peak SAR : 0.153 W/kg
 Zoom Scan Peak SAR : 0.320 W/kg

Plot 28#

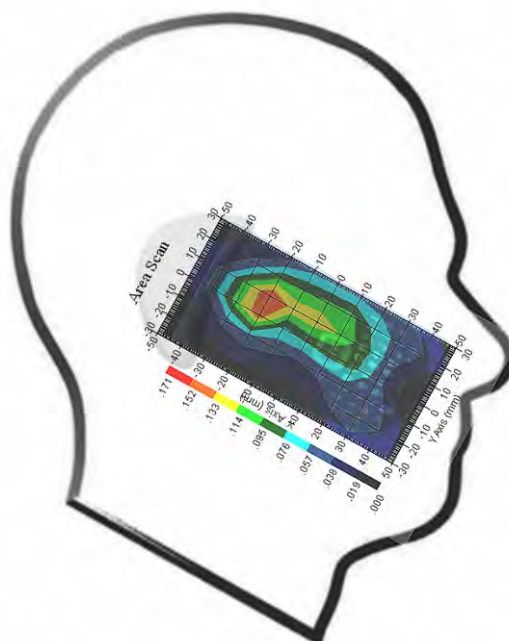

Test Laboratory: Bay Area Compliance Lab Corp. (Shenzhen)

WCDMA1900; Right Head Cheek (1880 MHz Middle Channel); Date: 2013-07-16

Measurement Data

Test mode : WCDMA1900
 Crest Factor : 1
 Scan Type : Complete
 Area Scan : 11x9x1: Measurement x=10mm, y=10mm, z=4mm
 Zoom Scan : 7x7x7: Measurement x=5mm, y=5mm, z=5mm
 Power Drift-Start : 0.007 W/kg
 Power Drift-Finish : 0.007 W/kg
 Power Drift (%) : 0.589

Tissue Data

Type : Head
 Frequency : 1880 MHz
 Epsilon : 40.17 F/m
 Sigma : 1.40 S/m
 Density : 1000.00 kg/cu. m

Probe Data

Serial No. : 500-00283
 Frequency Band : 1900
 Duty Cycle Factor : 1
 Conversion Factor : 5.2
 Probe Sensitivity : 1.20 1.20 1.20 $\mu\text{V}/(\text{V}/\text{m})^2$
 Compression Point : 95.00 mV
 Offset : 1.56 mm

1 gram SAR value : 0.425 W/kg
 10 gram SAR value : 0.209 W/kg
 Area Scan Peak SAR : 0.464 W/kg
 Zoom Scan Peak SAR : 0.700 W/kg

Plot 29#

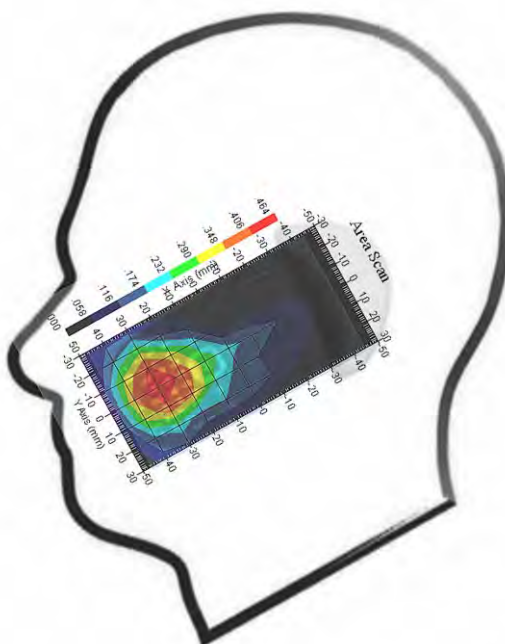

Test Laboratory: Bay Area Compliance Lab Corp. (Shenzhen)

WCDMA1900; Right Head Tilt (1880 MHz Middle Channel); Date: 2013-07-16

Measurement Data

Test mode : WCDMA1900
 Crest Factor : 1
 Scan Type : Complete
 Area Scan : 11x9x1: Measurement x=10mm, y=10mm, z=4mm
 Zoom Scan : 7x7x7: Measurement x=5mm, y=5mm, z=5mm
 Power Drift-Start : 0.022 W/kg
 Power Drift-Finish : 0.022 W/kg
 Power Drift (%) : 1.152

Tissue Data

Type : Head
 Frequency : 1880 MHz
 Epsilon : 40.17 F/m
 Sigma : 1.40 S/m
 Density : 1000.00 kg/cu. m

Probe Data

Serial No. : 500-00283
 Frequency Band : 1900
 Duty Cycle Factor : 1
 Conversion Factor : 5.2
 Probe Sensitivity : 1.20 1.20 1.20 $\mu\text{V}/(\text{V}/\text{m})^2$
 Compression Point : 95.00 mV
 Offset : 1.56 mm

1 gram SAR value : 0.148 W/kg
 10 gram SAR value : 0.072 W/kg
 Area Scan Peak SAR : 0.152 W/kg
 Zoom Scan Peak SAR : 0.300 W/kg

Plot 30#

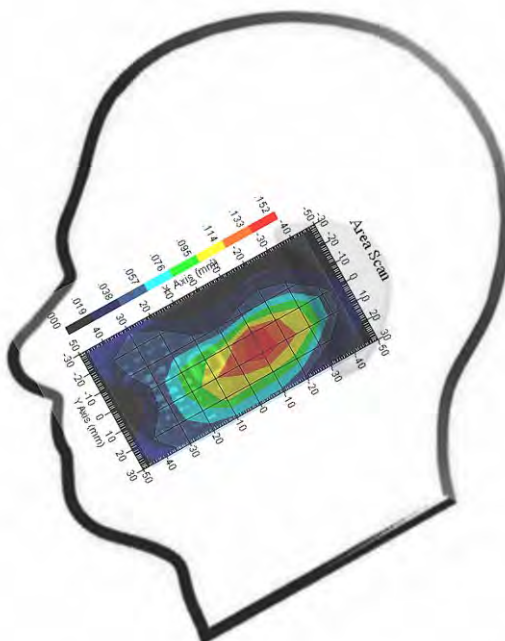

Test Laboratory: Bay Area Compliance Lab Corp. (Shenzhen)

WCDMA1900; Body-Front (1880 MHz Middle Channel); Date: 2013-07-16

Measurement Data

Test mode : WCDMA1900
 Crest Factor : 1
 Scan Type : Complete
 Area Scan : 9x11x1 : Measurement x=10mm, y=10mm, z=4mm
 Zoom Scan : 7x7x7 : Measurement x=5mm, y=5mm, z=5mm
 Power Drift-Start : 0.100 W/kg
 Power Drift-Finish : 0.099 W/kg
 Power Drift (%) : -1.000

Tissue Data

Type : Body
 Frequency : 1880 MHz
 Epsilon : 53.86 F/m
 Sigma : 1.51 S/m
 Density : 1000.00 kg/cu. m

Probe Data

Serial No. : 500-00283
 Frequency : 1900
 Duty Cycle Factor : 1
 Conversion Factor : 5.0
 Probe Sensitivity : 1.20 1.20 1.20 $\mu\text{V}/(\text{V}/\text{m})^2$
 Compression Point : 95.00 mV
 Offset : 1.56 mm

1 gram SAR value : 0.127 W/kg
 10 gram SAR value : 0.071 W/kg
 Area Scan Peak SAR : 0.133 W/kg
 Zoom Scan Peak SAR : 0.240 W/kg

Plot 31#

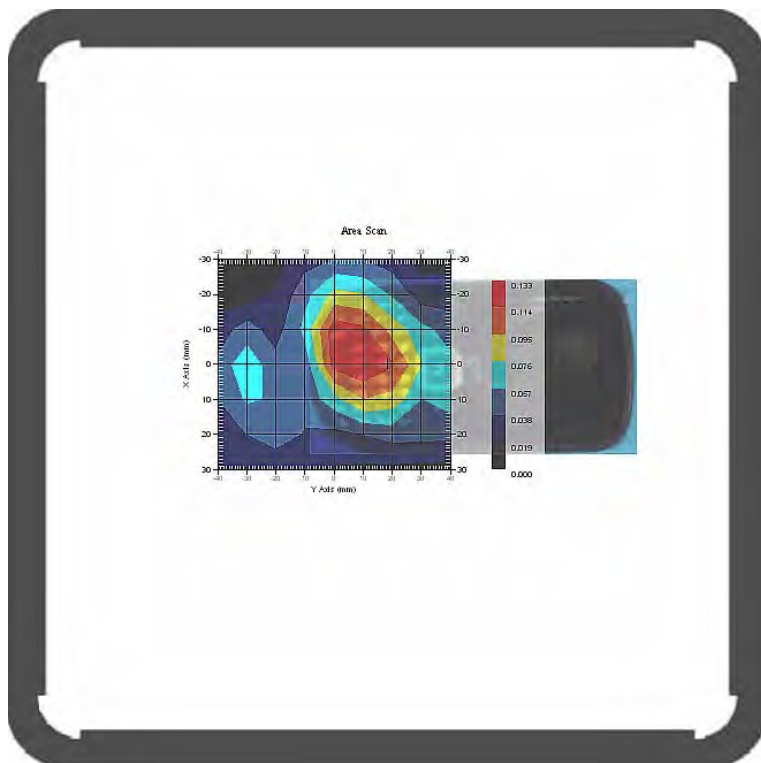

Test Laboratory: Bay Area Compliance Lab Corp. (Shenzhen)

WCDMA1900; Body-Back (1880 MHz Middle Channel); Date: 2013-07-16

Measurement Data

Test mode : WCDMA1900
 Crest Factor : 1
 Scan Type : Complete
 Area Scan : 9x11x1 : Measurement x=10mm, y=10mm, z=4mm
 Zoom Scan : 7x7x7 : Measurement x=5mm, y=5mm, z=5mm
 Power Drift-Start : 0.272 W/kg
 Power Drift-Finish : 0.274 W/kg
 Power Drift (%) : 0.713

Tissue Data

Type : Body
 Frequency : 1880 MHz
 Epsilon : 53.86 F/m
 Sigma : 1.51 S/m
 Density : 1000.00 kg/cu. m

Probe Data

Serial No. : 500-00283
 Frequency : 1900
 Duty Cycle Factor : 1
 Conversion Factor : 5.0
 Probe Sensitivity : 1.20 1.20 1.20 $\mu\text{V}/(\text{V}/\text{m})^2$
 Compression Point : 95.00 mV
 Offset : 1.56 mm

1 gram SAR value : 0.489 W/kg
 10 gram SAR value : 0.249 W/kg
 Area Scan Peak SAR : 0.537 W/kg
 Zoom Scan Peak SAR : 0.930 W/kg

Plot 32#

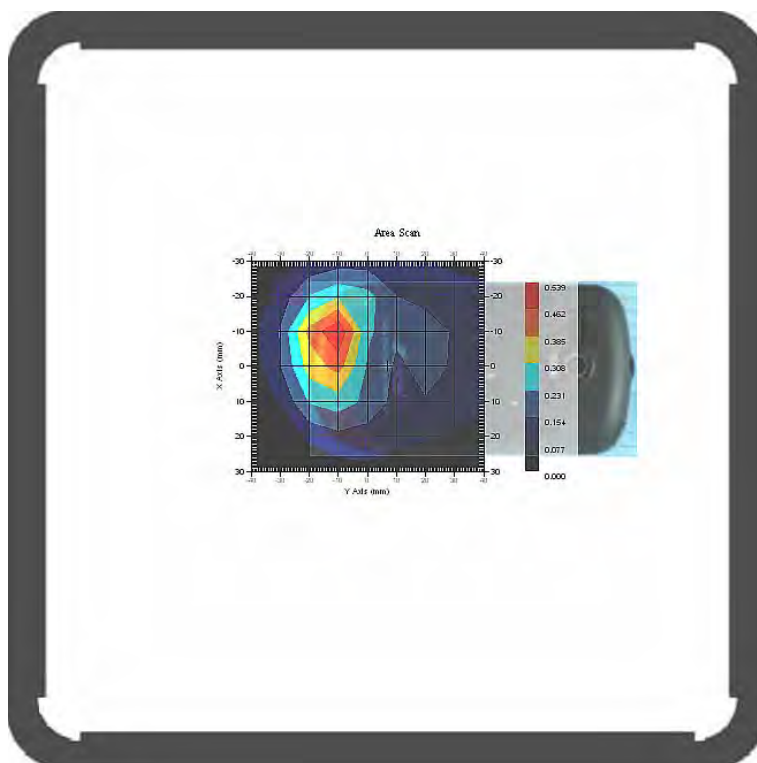

Test Laboratory: Bay Area Compliance Lab Corp. (Shenzhen)

802.11b; Left Head Cheek (2412 MHz Channel 1); Date: 2013-07-16

Measurement Data

Crest Factor : 1
 Scan Type : Complete
 Area Scan : 10x6x1 : Measurement x=10mm, y=10mm, z=4mm
 Zoom Scan : 7x7x7 : Measurement x=5mm, y=5mm, z=5mm
 Power Drift-Start : 0.001 W/kg
 Power Drift-Finish : 0.001 W/kg
 Power Drift (%) : 0.569

Tissue Data

Type : Head
 Frequency : 2412.00 MHz
 Epsilon : 40.12 F/m
 Sigma : 1.79 S/m
 Density : 1000.00 kg/cu. m

Probe Data

Serial No. : 500-00283
 Frequency : 2450 MHz
 Duty Cycle Factor : 1
 Conversion Factor : 4.9
 Probe Sensitivity : 1.20 1.20 1.20 $\mu\text{V}/(\text{V}/\text{m})^2$
 Compression Point : 95.00 mV
 Offset : 1.56 mm

1 gram SAR value : 0.017 W/kg
 10 gram SAR value : 0.010 W/kg
 Area Scan Peak SAR : 0.018 W/kg
 Zoom Scan Peak SAR : 0.030 W/kg

Plot 33#

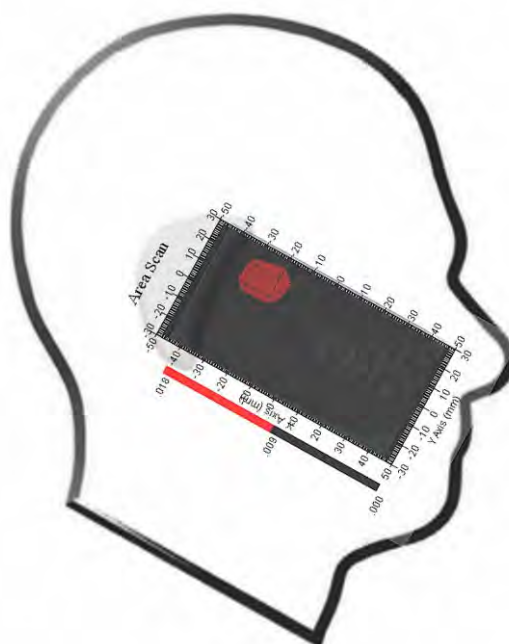

Test Laboratory: Bay Area Compliance Lab Corp. (Shenzhen)

802.11b; Left Head Tilt (2412 MHz Channel 1); Date: 2013-07-16

Measurement Data

Crest Factor : 1
 Scan Type : Complete
 Area Scan : 10x6x1 : Measurement x=10mm, y=10mm, z=4mm
 Zoom Scan : 7x7x7 : Measurement x=5mm, y=5mm, z=5mm
 Power Drift-Start : 0.001 W/kg
 Power Drift-Finish : 0.001 W/kg
 Power Drift (%) : 0.859

Tissue Data

Type : Head
 Frequency : 2412.00 MHz
 Epsilon : 40.12 F/m
 Sigma : 1.79 S/m
 Density : 1000.00 kg/cu. m

Probe Data

Serial No. : 500-00283
 Frequency : 2450 MHz
 Duty Cycle Factor : 1
 Conversion Factor : 4.9
 Probe Sensitivity : 1.20 1.20 1.20 $\mu\text{V}/(\text{V}/\text{m})^2$
 Compression Point : 95.00 mV
 Offset : 1.56 mm

1 gram SAR value : 0.013 W/kg
 10 gram SAR value : 0.006 W/kg
 Area Scan Peak SAR : 0.014 W/kg
 Zoom Scan Peak SAR : 0.020 W/kg

Plot 34#

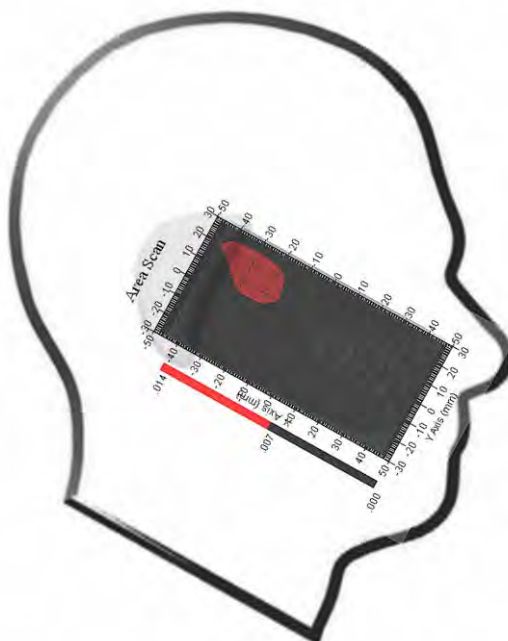

Test Laboratory: Bay Area Compliance Lab Corp. (Shenzhen)

802.11b; Right Head Cheek (2412 MHz Channel 1); Date: 2013-07-16

Measurement Data

Crest Factor : 1
 Scan Type : Complete
 Area Scan : 10x6x1 : Measurement x=10mm, y=10mm, z=4mm
 Zoom Scan : 7x7x7 : Measurement x=5mm, y=5mm, z=5mm
 Power Drift-Start : 0.001 W/kg
 Power Drift-Finish : 0.001 W/kg
 Power Drift (%) : -0.527

Tissue Data

Type : Head
 Frequency : 2412.00 MHz
 Epsilon : 40.12 F/m
 Sigma : 1.79 S/m
 Density : 1000.00 kg/cu. m

Probe Data

Serial No. : 500-00283
 Frequency : 2450 MHz
 Duty Cycle Factor : 1
 Conversion Factor : 4.9
 Probe Sensitivity : 1.20 1.20 1.20 $\mu\text{V}/(\text{V}/\text{m})^2$
 Compression Point : 95.00 mV
 Offset : 1.56 mm

1 gram SAR value : 0.015 W/kg
 10 gram SAR value : 0.007 W/kg
 Area Scan Peak SAR : 0.016 W/kg
 Zoom Scan Peak SAR : 0.025 W/kg

Plot 35#

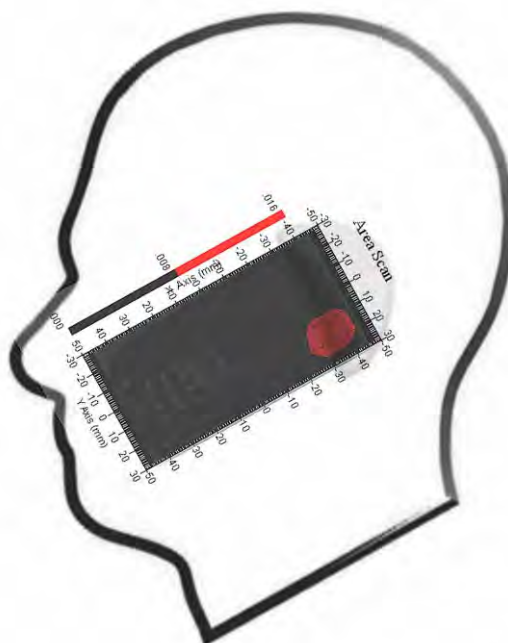

Test Laboratory: Bay Area Compliance Lab Corp. (Shenzhen)

802.11b; Right Head Tilt (2412 MHz Channel 1); Date: 2013-07-16

Measurement Data

Crest Factor : 1
 Scan Type : Complete
 Area Scan : 10x6x1 : Measurement x=10mm, y=10mm, z=4mm
 Zoom Scan : 7x7x7 : Measurement x=5mm, y=5mm, z=5mm
 Power Drift-Start : 0.001 W/kg
 Power Drift-Finish : 0.001 W/kg
 Power Drift (%) : 0.746

Tissue Data

Type : Head
 Frequency : 2412.00 MHz
 Epsilon : 40.12 F/m
 Sigma : 1.79 S/m
 Density : 1000.00 kg/cu. m

Probe Data

Serial No. : 500-00283
 Frequency : 2450 MHz
 Duty Cycle Factor : 1
 Conversion Factor : 4.9
 Probe Sensitivity : 1.20 1.20 1.20 $\mu\text{V}/(\text{V}/\text{m})^2$
 Compression Point : 95.00 mV
 Offset : 1.56 mm

1 gram SAR value : 0.011 W/kg
 10 gram SAR value : 0.006 W/kg
 Area Scan Peak SAR : 0.012 W/kg
 Zoom Scan Peak SAR : 0.020 W/kg

Plot 36#

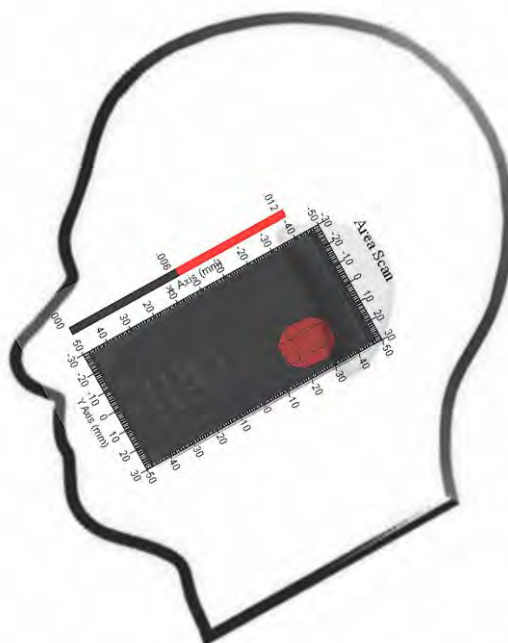

Test Laboratory: Bay Area Compliance Lab Corp. (Shenzhen)

802.11b; Body-Front (2412 MHz Channel 1); Date: 2013-07-16

Measurement Data

Crest Factor : 1
 Scan Type : Complete
 Area Scan : 7x9x1 : Measurement x=10mm, y=10mm, z=4mm
 Zoom Scan : 7x7x7 : Measurement x=5mm, y=5mm, z=5mm
 Power Drift-Start : 0.005 W/kg
 Power Drift-Finish : 0.005 W/kg
 Power Drift (%) : 0.882

Tissue Data

Type : Body
 Frequency : 2412.00 MHz
 Epsilon : 51.88 F/m
 Sigma : 1.93 S/m
 Density : 1000.00 kg/cu. m

Probe Data

Serial No. : 500-00283
 Frequency Band : 2450
 Duty Cycle Factor : 1
 Conversion Factor : 4.3
 Probe Sensitivity : 1.20 1.20 1.20 $\mu\text{V}/(\text{V}/\text{m})^2$
 Compression Point : 95.00 mV
 Offset : 1.56 mm

1 gram SAR value : 0.014 W/kg
 10 gram SAR value : 0.007 W/kg
 Area Scan Peak SAR : 0.015 W/kg
 Zoom Scan Peak SAR : 0.025 W/kg

Plot 37#

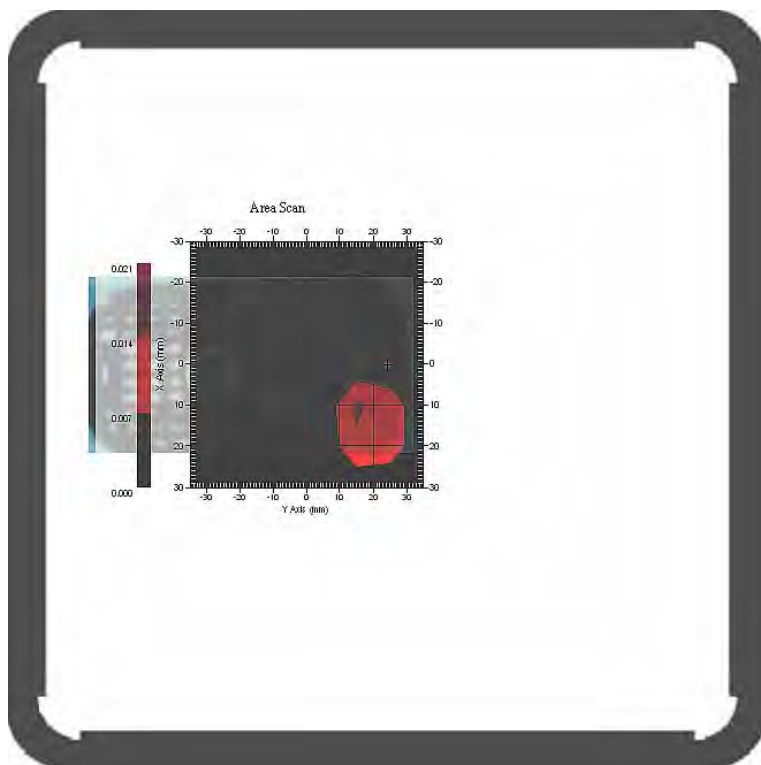

Test Laboratory: Bay Area Compliance Lab Corp. (Shenzhen)

802.11b; Body-Back (2412 MHz Channel 1); Date: 2013-07-16

Measurement Data

Crest Factor : 1
 Scan Type : Complete
 Area Scan : 7x9x1 : Measurement x=10mm, y=10mm, z=4mm
 Zoom Scan : 7x7x7 : Measurement x=5mm, y=5mm, z=5mm
 Power Drift-Start : 0.011 W/kg
 Power Drift-Finish : 0.011 W/kg
 Power Drift (%) : -0.539

Tissue Data

Type : Body
 Frequency : 2412.00 MHz
 Epsilon : 51.88 F/m
 Sigma : 1.93 S/m
 Density : 1000.00 kg/cu. m

Probe Data

Serial No. : 500-00283
 Frequency Band : 2450
 Duty Cycle Factor : 1
 Conversion Factor : 4.3
 Probe Sensitivity : 1.20 1.20 1.20 $\mu\text{V}/(\text{V}/\text{m})^2$
 Compression Point : 95.00 mV
 Offset : 1.56 mm

1 gram SAR value : 0.015 W/kg
 10 gram SAR value : 0.008 W/kg
 Area Scan Peak SAR : 0.016 W/kg
 Zoom Scan Peak SAR : 0.030 W/kg

Plot 38#

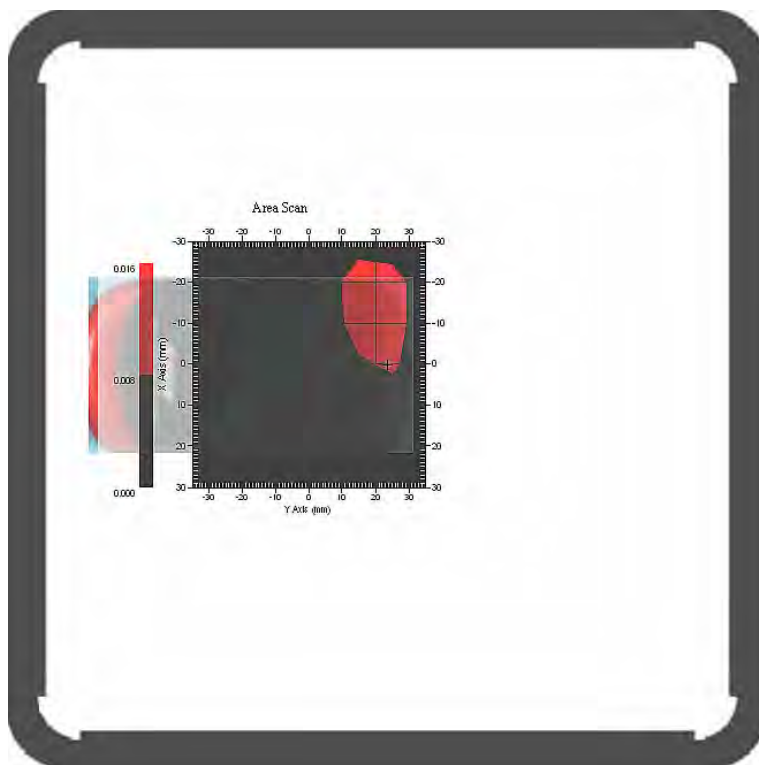

Test Laboratory: Bay Area Compliance Lab Corp. (Shenzhen)

802.11b; Body-Right (2412 MHz Channel 1); Date: 2013-07-16

Measurement Data

Crest Factor : 1
 Scan Type : Complete
 Area Scan : 7x11x1 : Measurement x=10mm, y=10mm, z=4mm
 Zoom Scan : 7x7x7 : Measurement x=5mm, y=5mm, z=5mm
 Power Drift-Start : 0.011 W/kg
 Power Drift-Finish : 0.011 W/kg
 Power Drift (%) : 0.923

Tissue Data

Type : Body
 Frequency : 2412.00 MHz
 Epsilon : 51.88 F/m
 Sigma : 1.93 S/m
 Density : 1000.00 kg/cu. m

Probe Data

Serial No. : 500-00283
 Frequency Band : 2450
 Duty Cycle Factor : 1
 Conversion Factor : 4.3
 Probe Sensitivity : 1.20 1.20 1.20 $\mu\text{V}/(\text{V}/\text{m})^2$
 Compression Point : 95.00 mV
 Offset : 1.56 mm

1 gram SAR value : 0.011 W/kg
 10 gram SAR value : 0.004 W/kg
 Area Scan Peak SAR : 0.011 W/kg
 Zoom Scan Peak SAR : 0.020 W/kg

Plot 39#

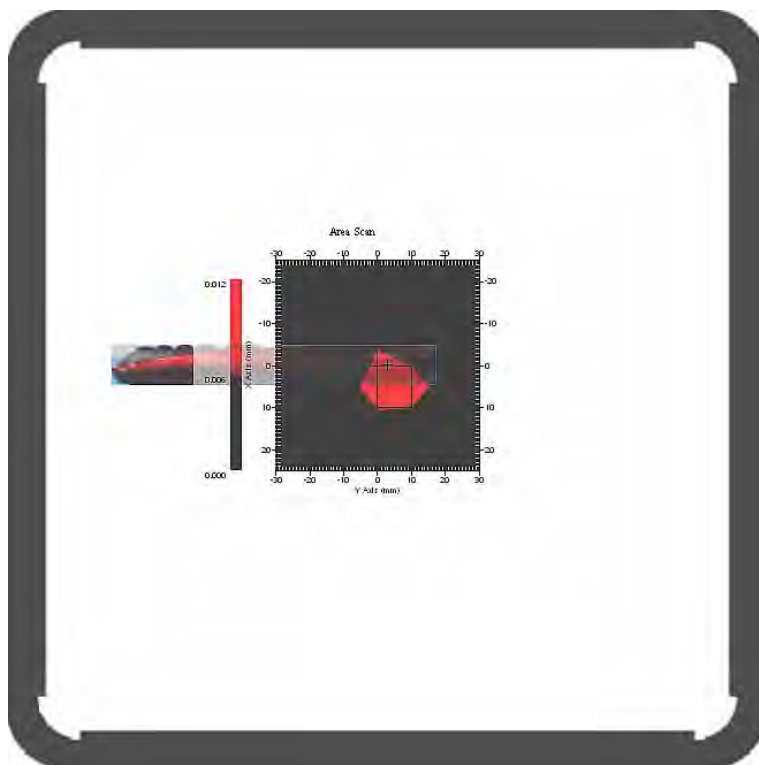

Test Laboratory: Bay Area Compliance Lab Corp. (Shenzhen)

802.11b; Body-Top (2412 MHz Channel 1); Date: 2013-07-16

Measurement Data

Crest Factor : 1
 Scan Type : Complete
 Area Scan : 7x9x1 : Measurement x=10mm, y=10mm, z=4mm
 Zoom Scan : 7x7x7 : Measurement x=5mm, y=5mm, z=5mm
 Power Drift-Start : 0.009 W/kg
 Power Drift-Finish : 0.009 W/kg
 Power Drift (%) : -0.754

Tissue Data

Type : Body
 Frequency : 2412.00 MHz
 Epsilon : 51.88 F/m
 Sigma : 1.93 S/m
 Density : 1000.00 kg/cu. m

Probe Data

Serial No. : 500-00283
 Frequency Band : 2450
 Duty Cycle Factor : 1
 Conversion Factor : 4.3
 Probe Sensitivity : 1.20 1.20 1.20 $\mu\text{V}/(\text{V}/\text{m})^2$
 Compression Point : 95.00 mV
 Offset : 1.56 mm

1 gram SAR value : 0.010 W/kg
 10 gram SAR value : 0.006 W/kg
 Area Scan Peak SAR : 0.012 W/kg
 Zoom Scan Peak SAR : 0.020 W/kg

Plot 40#

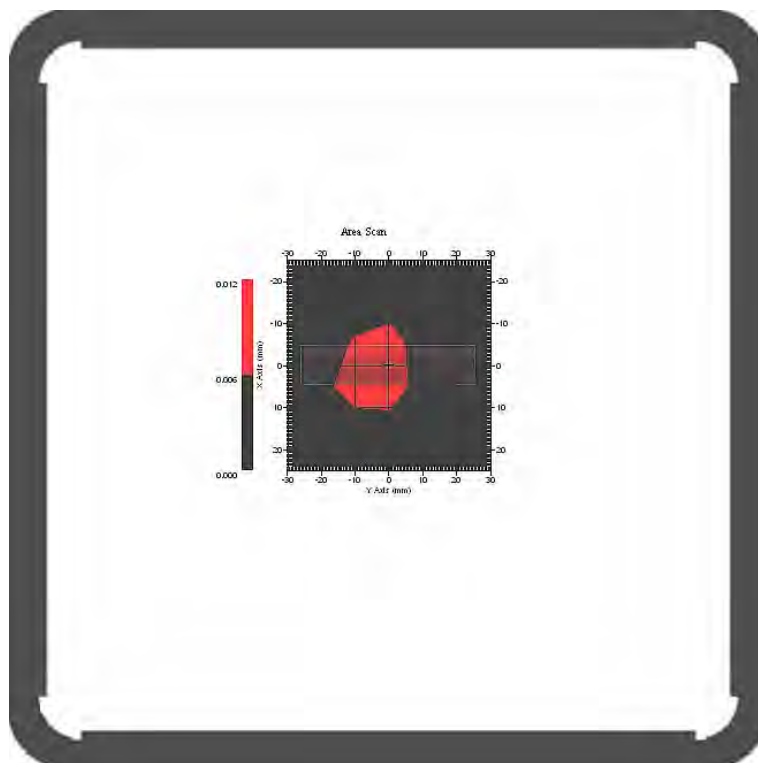

APPENDIX A MEASUREMENT UNCERTAINTY

The uncertainty budget has been determined for the measurement system and is given in the following Table.

Measurement Uncertainty for 300MHz to 3GHz

Source of Uncertainty	Tolerance Value	Probability Distribution	Divisor	c_i^1 (1-g)	c_i^1 (10-g)	Standard Uncertainty (1-g) %	Standard Uncertainty (10-g) %
Measurement System							
Probe Calibration	3.5	normal	1	1	1	3.5	3.5
Axial Isotropy	3.7	rectangular	$\sqrt{3}$	$(1-cp)^{1/2}$	$(\frac{1-cp}{2})^{1/2}$	1.5	1.5
Hemispherical Isotropy	10.9	rectangular	$\sqrt{3}$	\sqrt{cp}	\sqrt{cp}	4.4	4.4
Boundary Effect	1.0	rectangular	$\sqrt{3}$	1	1	0.6	0.6
Linearity	4.7	rectangular	$\sqrt{3}$	1	1	2.7	2.7
Detection Limit	1.0	rectangular	$\sqrt{3}$	1	1	0.6	0.6
Readout Electronics	1.0	normal	1	1	1	1.0	1.0
Response Time	0.8	rectangular	$\sqrt{3}$	1	1	0.5	0.5
Integration Time	1.7	rectangular	$\sqrt{3}$	1	1	1.0	1.0
RF Ambient Condition -Noise	0.006	rectangular	$\sqrt{3}$	1	1	0.003	0.003
RF Ambient Condition - Reflections	3.0	rectangular	$\sqrt{3}$	1	1	1.7	1.7
Probe Positioner Mech. Restrictions	0.4	rectangular	$\sqrt{3}$	1	1	0.2	0.2
Restriction							
Probe Positioning with respect to Phantom Shell	2.9	rectangular	$\sqrt{3}$	1	1	1.7	1.7
Extrapolation and Integration	3.7	rectangular	$\sqrt{3}$	1	1	2.1	2.1
Test Sample Positioning	0.023	normal	1	1	1	0.023	0.023
Device Holder Uncertainty	6.215	normal	1	1	1	6.215	6.215
Drift of Output Power	4.627	rectangular	$\sqrt{3}$	1	1	2.67	2.67
Phantom and Setup							
Phantom Uncertainty(shape & thickness tolerance)	3.4	rectangular	$\sqrt{3}$	1	1	2.0	2.0
Liquid Conductivity(target)	5.0	rectangular	$\sqrt{3}$	0.7	0.5	2.0	1.4
Liquid Conductivity(meas.)	1.938	normal	1	0.7	0.5	1.36	0.97
Liquid Permittivity(target)	5.0	rectangular	$\sqrt{3}$	0.6	0.5	1.7	1.4
Liquid Permittivity(meas.)	3.093	normal	1	0.6	0.5	1.86	1.55
Combined Uncertainty		RSS				10.78	10.55
Expanded uncertainty (coverage factor=2)		Normal(k=2)				21.56	21.10

APPENDIX B PROBE CALIBRATION CERTIFICATES

NCL CALIBRATION LABORATORIES

Calibration File No.: 1427-1430

Client.: BACL Lab

CERTIFICATE OF CALIBRATION

It is certified that the equipment identified below has been calibrated in the **NCL CALIBRATION LABORATORIES** by qualified personnel following recognized procedures and using transfer standards traceable to NRC/NIST.

Equipment: Miniature Isotropic RF Probe

Record of Calibration

Head and Body

Manufacturer: APREL Laboratories

Model No.: E-020

Serial No.: 500-00283

Calibration Procedure: D01-032-E020-V2, D22-012-Tissue, D28-002-Dipole
Project No: BACL-5673

Calibrated: 8th August 2012
Released on: 9th August 2012

This Calibration Certificate is Incomplete Unless Accompanied with the Calibration Results Summary

Released By: _____



Art Brennan, Quality Manager

NCL CALIBRATION LABORATORIES

Suite 102, 303 Terry Fox Dr,
OTTAWA, ONTARIO
CANADA K2K 3J1

Division of APREL Lab.
TEL: (613) 435-8300
FAX: (613) 435-8306

NCL Calibration Laboratories

Division of APREL Inc.

Introduction

This Calibration Report reproduces the results of the calibration performed in line with the references listed below. Calibration is performed using accepted methodologies as per the references listed below. Probes are calibrated for air, and tissue and the values reported are the results from the physical quantification of the probe through meteorological practices.

Calibration Method

Probes are calibrated using the following methods.

<1000MHz

TEM Cell for sensitivity in air

Standard phantom using temperature transfer method for sensitivity in tissue

>1000MHz

Waveguide* method to determine sensitivity in air and tissue

*Waveguide is numerically (simulation) assessed to determine the field distribution and power

The boundary effect for the probe is assessed using a standard flat phantom where the probe output is compared against a numerically simulated series of data points

References

- IEEE Standard 1528 (2003) including Amendment 1
IEEE Recommended Practice for Determining the Peak Spatial-Average Specific Absorption Rate (SAR) in the Human Head from Wireless Communications Devices: Measurement Techniques
- EN 62209-1 (2006)
Human Exposure to RF Fields from hand-held and body-mounted wireless communication devices - Human models, instrumentation, and procedures-Part 1: Procedure to measure the Specific Absorption Rate (SAR) for hand-held mobile wireless devices
- IEC 62209-2 Ed. 1.0 (2010-03)
Human exposure to RF fields from hand-held and body-mounted wireless devices - Human models, instrumentation, and procedures - Part 2: specific absorption rate (SAR) for wireless communication devices (30 MHz - 6 GHz)
- TP-D01-032-E020-V2 E-Field probe calibration procedure
- D22-012-Tissue dielectric tissue calibration procedure
- D28-002-Dipole procedure for validation of SAR system using a dipole
- IEEE 1309 Draft Standard for Calibration of Electromagnetic Field Sensors and Probes, Excluding Antennas, from 9kHz to 40GHz

Page 2 of 10

This page has been reviewed for content and attested to on Page 2 of this document.

NCL Calibration Laboratories

Division of APREL Inc.

Conditions

Probe 500-00283 was a recalibration with the exception frequency of 450 MHz .which was a new calibration

Ambient Temperature of the Laboratory: 22 °C +/- 1.5°C
Temperature of the Tissue: 21 °C +/- 1.5°C
Relative Humidity: < 60%

Primary Measurement Standards

Instrument	Serial Number	Cal due date
Power meter Anritsu MA2408A	90025437	Nov.4, 2012
Power Sensor Anritsu MA2481D	103555	Nov 4, 2012
Attenuator HP 8495A (70dB)	1944A10711	Sept. 14, 2012
Network Analyzer Anritsu MT8801C	MB11855	Feb. 8, 2013

Secondary Measurement Standards

Signal Generator Agilent E4438C -506 MY55182336 June 7, 2013

Attestation

The below named signatories have conducted the calibration and review of the data which is presented in this calibration report.

We the undersigned attest that to the best of our knowledge the calibration of this subject has been accurately conducted and that all information contained within the results pages have been reviewed for accuracy.



Art Brennan, Quality Manager



Dan Brooks, Test Engineer

Page 3 of 10

This page has been reviewed for content and attested to on Page 2 of this document.

NCL Calibration Laboratories

Division of APREL Inc.

Probe Summary

Probe Type:	E-Field Probe E020
Serial Number:	500-00283
Frequency:	As presented on page 5
Sensor Offset:	1.56
Sensor Length:	2.5
Tip Enclosure:	Composite*
Tip Diameter:	< 2.9 mm
Tip Length:	55 mm
Total Length:	289 mm

*Resistive to recommended tissue recipes per IEEE-1528

Sensitivity in Air

Channel X:	1.2 $\mu\text{V}/(\text{V}/\text{m})^2$
Channel Y:	1.2 $\mu\text{V}/(\text{V}/\text{m})^2$
Channel Z:	1.2 $\mu\text{V}/(\text{V}/\text{m})^2$
Diode Compression Point:	95 mV

Page 4 of 10

This page has been reviewed for content and attested to on Page 2 of this document.

NCL Calibration Laboratories

Division of APREL Inc.

Calibration for Tissue (Head H, Body B)

Frequency	Tissue Type	Measured Epsilon	Measured Sigma	Calibration Uncertainty	Tolerance Uncertainty for 5%*	Conversion Factor
450 H	Head	43.98	0.9	3.5	3.4	6
450 B	Body	57.07	0.92	3.5	3.4	6
750 H	Head	X	X	X	X	X
750 B	Body	X	X	X	X	X
835 H	Head	42.35	0.938	3.5	3.4	6.6
835 B	Body	56.65	1.018	3.5	3.4	6.6
900 H	Head	41.35	0.98	3.5	3.4	6
900 B	Body	56.08	1.05	3.5	3.4	6
1450 H	Head	X	X	X	X	X
1450 B	Body	X	X	X	X	X
1500 H	Head	X	X	X	X	X
1500 B	Body	X	X	X	X	X
1640 H	Head	X	X	X	X	X
1640 B	Body	X	X	X	X	X
1750 H	Head	X	X	X	X	X
1750 B	Body	X	X	X	X	X
1800 H	Head	X	X	X	X	X
1800 B	Body	X	X	X	X	X
1900 H	Head	38.72	1.35	3.5	2.7	5.2
1900 B	Body	51.62	1.48	3.5	2.7	5
2000 H	Head	X	X	X	X	X
2000 B	Body	X	X	X	X	X
2100 H	Head	X	X	X	X	X
2100 B	Body	X	X	X	X	X
2300 H	Head	X	X	X	X	X
2300 B	Body	X	X	X	X	X
2450 H	Head	38.06	1.87	3.5	3.5	4.9
2450 B	Body	50.22	2.03	3.5	3.5	4.3
2600 H	Head	X	X	X	X	X
2600 B	Body	X	X	X	X	X
3000 H	Head	X	X	X	X	X
3000 B	Body	X	X	X	X	X
3600 H	Head	X	X	X	X	X
3600 B	Body	X	X	X	X	X
5200 H	Head	X	X	X	X	X
5200 B	Body	X	X	X	X	X
5600 H	Head	X	X	X	X	X
5600 B	Body	X	X	X	X	X
5800 H	Head	X	X	X	X	X
5800 B	Body	X	X	X	X	X

NCL Calibration Laboratories

Division of APREL Inc.

Boundary Effect:

Uncertainty resulting from the boundary effect is less than 2.1% for the distance between the tip of the probe and the tissue boundary, when less than 0.58mm.

Spatial Resolution:

The spatial resolution uncertainty is less than 1.5% for 4.9mm diameter probe.
The spatial resolution uncertainty is less than 1.0% for 2.5mm diameter probe.

DAQ-PAQ Contribution

To minimize the uncertainty calculation all tissue sensitivity values were calculated using a load impedance of 5 M Ω .

Boundary Effect:

For a distance of 0.58mm the worst case evaluated uncertainty (increase in the probe sensitivity) is less than 2.1%.

NOTES:

*The maximum deviation from the centre frequency when comparing the lower to upper range is listed.

Page 6 of 10

This page has been reviewed for content and attested to on Page 2 of this document.

NCL Calibration Laboratories

Division of APREL Inc.

Receiving Pattern Air

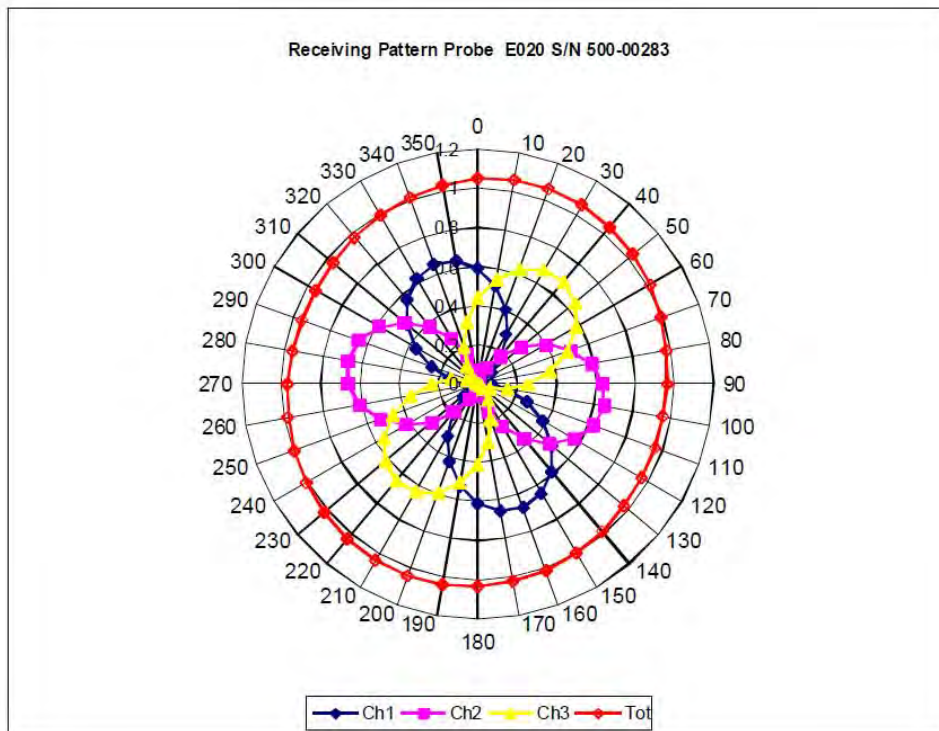

Page 7 of 10

This page has been reviewed for content and attested to on Page 2 of this document.

NCL Calibration Laboratories

Division of APREL Inc.

Isotropy Error Air

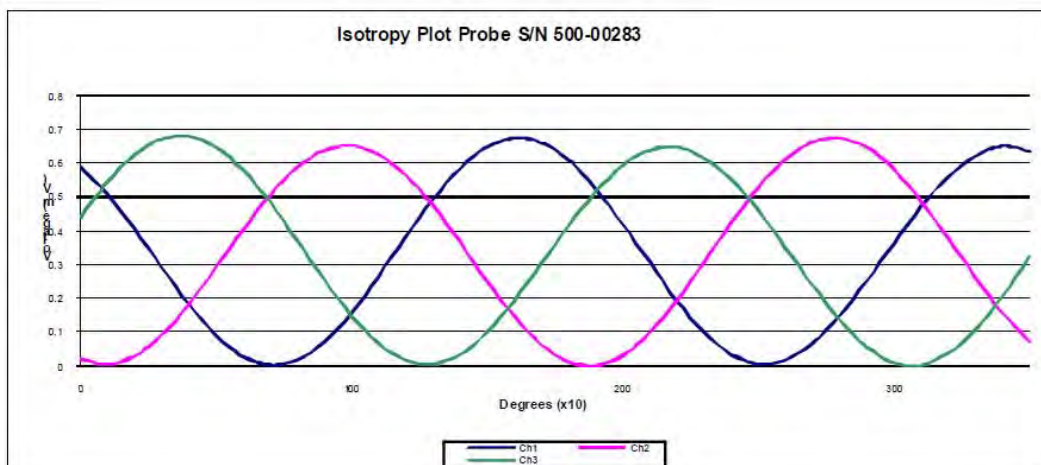
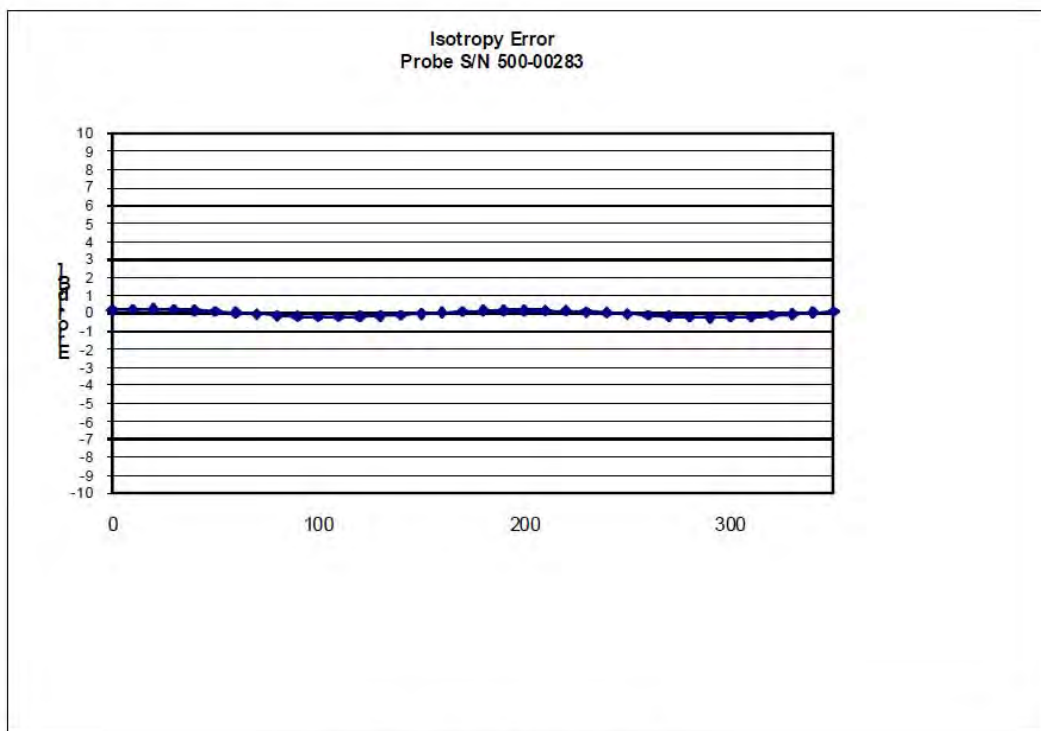

Isotropicity Tissue:

0.10 dB

NCL Calibration Laboratories

Division of APREL Inc.

Dynamic Range

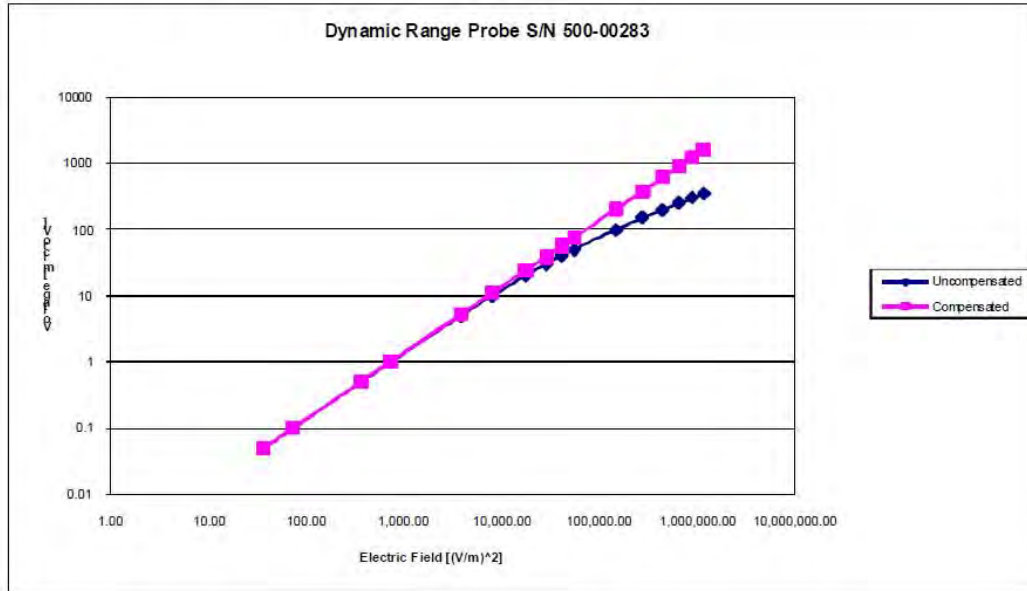

NCL Calibration Laboratories

Division of APREL Inc.

Video Bandwidth

Probe Frequency Characteristics

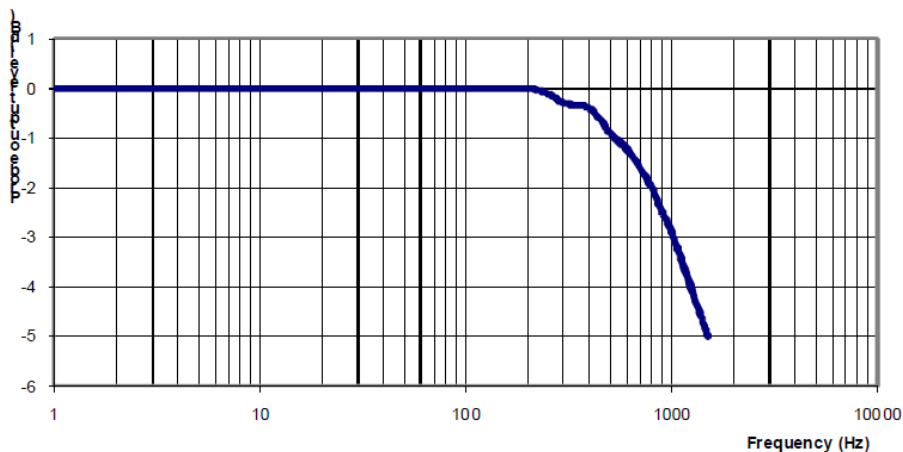

Video Bandwidth at 500 Hz 1 dB
 Video Bandwidth at 1.02 KHz: 3 dB

Test Equipment

The test equipment used during Probe Calibration, manufacturer, model number and, current calibration status are listed and located on the main APREL server R:\NCL\Calibration Equipment\Instrument List May 2012.

APPENDIX C DIPOLE CALIBRATION CERTIFICATES

NCL CALIBRATION LABORATORIES

Calibration File No: DC-1327
Project Number: BAC-dipole-cal-5618

CERTIFICATE OF CALIBRATION

It is certified that the equipment identified below has been calibrated in the
NCL CALIBRATION LABORATORIES by qualified personnel following recognized
procedures and using transfer standards traceable to NRC/NIST.

Validation Dipole(Head and Body)

Manufacturer: APREL Laboratories
Part number: ALS-D-835-S-2
Frequency: 835 MHz
Serial No: 180-00558

Customer: Bay Area Compliance Laboratory

Calibrated: 25th August 2011
Released on: 25th August 2011

This Calibration Certificate is Incomplete Unless Accompanied with the Calibration Results Summary

Released By: _____

NCL CALIBRATION LABORATORIES

Suite 102, 303 Terry Fox Dr.
Kanata, ONTARIO
CANADA K2K 3J1

Division of APREL Lab.
TEL: (613) 435-8300
FAX: (613)435-8306

NCL Calibration Laboratories

Division of APREL Laboratories.

Conditions

Dipole 180-00558 was received in good condition and a re-calibration.

Ambient Temperature of the Laboratory: 22 °C +/- 0.5°C

Temperature of the Tissue: 21 °C +/- 0.5°C

We the undersigned attest that to the best of our knowledge the calibration of this device has been accurately conducted and that all information contained within this report has been reviewed for accuracy.



Stuart Nicol



C. Teodorian

Primary Measurement Standards Instrument	Serial Number	Cal due date
Power meter Anritsu MA2408A	245025437	Nov.4, 2011
Power Sensor Anritsu MA2481D	103555	Nov 4, 2011
Attenuator HP 8495A (70dB) 1	944A10711	Aug.8, 2012
Network Analyzer Agilent E5071C	1334746J	Feb. 8, 2012
Secondary Measurement Standards		
Signal Generator Agilent E4438C	-506 MY55182336	June 7, 2012

This page has been reviewed for content and attested to by signature within this document.

NCL Calibration Laboratories

Division of APREL Laboratories.

Calibration Results Summary

The following results relate the Calibrated Dipole and should be used as a quick reference for the user.

Mechanical Dimensions

Length: 162.2 mm
Height: 89.4 mm

Electrical Specification

Tissue	Frequency	SWR:	Return Loss	Impedance
Head	835 MHz	1.0417 U	-35.395dB	49.020 Ω
Body	835 MHz	1.1177 U	-25.424dB	55.435 Ω

System Validation Results

Tissue	Frequency	1 Gram	10 Gram	Peak
Head	835 MHz	9.590	6.003	15.013
Body	835 MHz	9.684	6.263	14.23

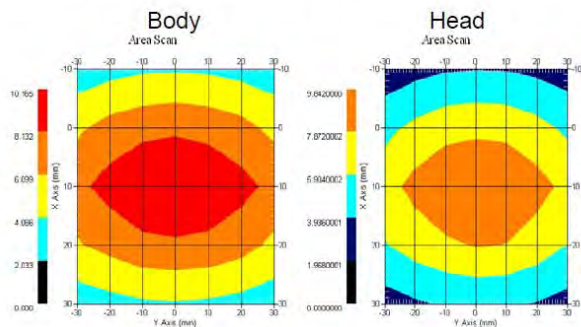

This page has been reviewed for content and attested to by signature within this document.

NCL Calibration Laboratories

Division of APREL Laboratories.

Introduction

This Calibration Report has been produced in line with the SSI Dipole Calibration Procedure SSI-TP-018-ALSAS. The results contained within this report are for Validation Dipole 180-00558. The calibration routine consisted of a three-step process. Step 1 was a mechanical verification of the dipole to ensure that it meets the mechanical specifications. Step 2 was an Electrical Calibration for the Validation Dipole, where the SWR, Impedance, and the Return loss were assessed. Step 3 involved a System Validation using the ALSAS-10U, along with APREL E-020 130 MHz to 26 GHz E-Field Probe Serial Number 212.

References

SSI-TP-018-ALSAS Dipole Calibration Procedure
 SSI-TP-016 Tissue Calibration Procedure
 IEEE 1528 "Recommended Practice for Determining the Peak Spatial-Average Specific Absorption Rate (SAR) in the Human Body Due to Wireless Communications Devices: Experimental Techniques"

Conditions

Dipole 180-00558 was new taken from stock.

Ambient Temperature of the Laboratory: 22 °C +/- 0.5°C
Temperature of the Tissue: 20 °C +/- 0.5°C

Dipole Calibration uncertainty

The calibration uncertainty for the dipole is made up of various parameters presented below.

Mechanical	1%
Positioning Error	1.22%
Electrical	1.7%
Tissue	2.2%
Dipole Validation	2.2%
TOTAL	8.32% (16.64% K=2)

This page has been reviewed for content and attested to by signature within this document.

NCL Calibration Laboratories

Division of APREL Laboratories.

Dipole Calibration Results

Mechanical Verification

APREL Length	APREL Height	Measured Length	Measured Height
161.0 mm	89.8 mm	162.2 mm	89.4 mm

Tissue Type	Return Loss:	SWR:	Impedance:
Head	-35.395 dB	1.0417 U	49.020Ω
Body	-25.454 dB	1.1177 U	55.435Ω

Tissue Validation

	Dielectric constant, ϵ_r	Conductivity, σ [S/m]
Head Tissue 835MHz	41.78	0.92
Body Tissue 835MHz	56.37	0.95

This page has been reviewed for content and attested to by signature within this document.

NCL Calibration Laboratories

Division of APREL Laboratories.

The Following Graphs are the results as displayed on the Vector Network Analyzer.

S11 Parameter Return Loss

Head Tissue

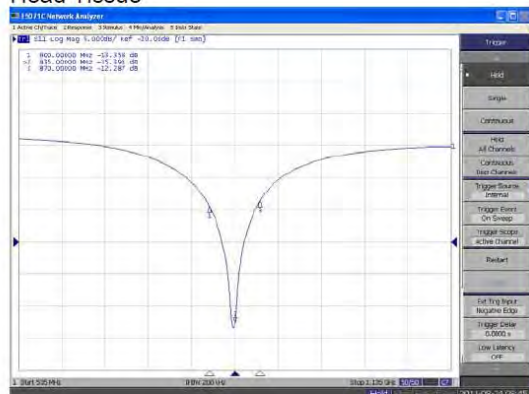

Body Tissue

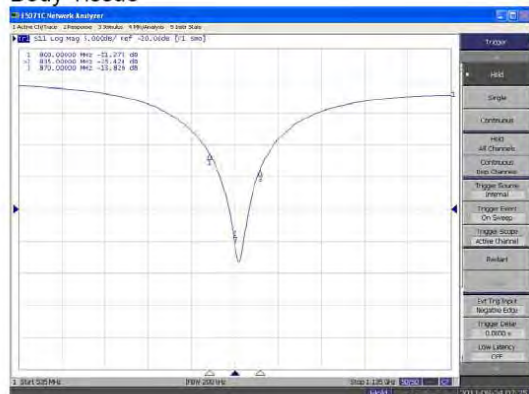

This page has been reviewed for content and attested to by signature within this document.

NCL Calibration Laboratories

Division of APREL Laboratories.

**SWR
Head**

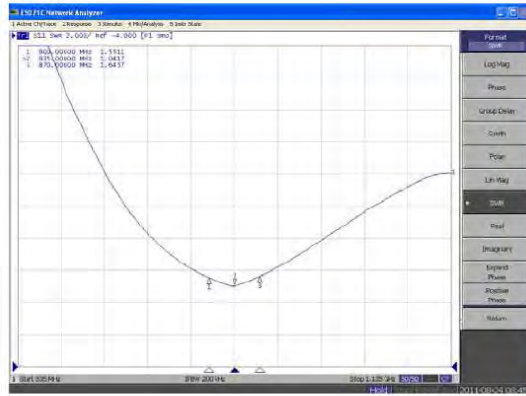

Body

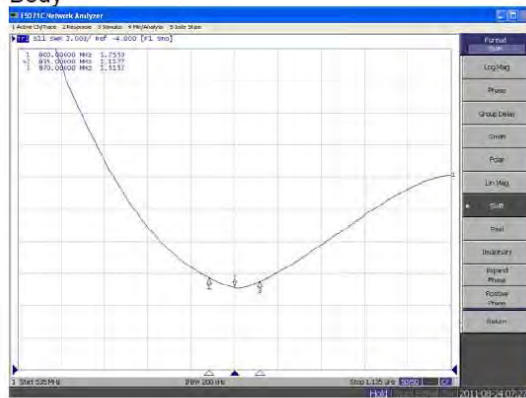

This page has been reviewed for content and attested to by signature within this document.

NCL Calibration Laboratories

Division of APREL Laboratories.

Smith Chart Dipole Impedance

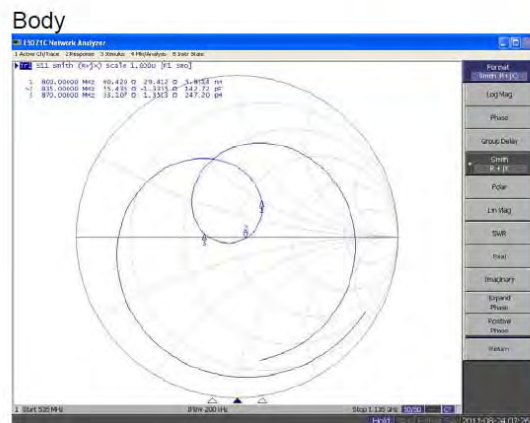
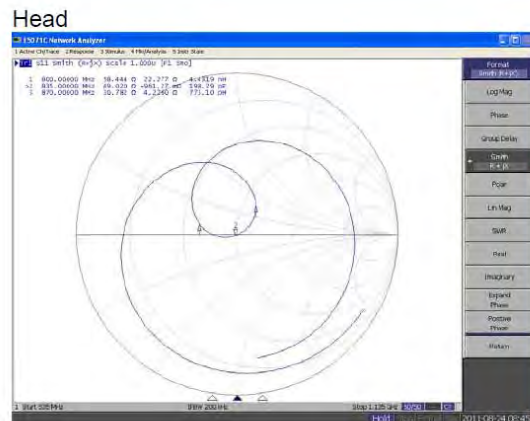

This page has been reviewed for content and attested to by signature within this document.

NCL Calibration Laboratories

Division of APREL Laboratories.

Test Equipment

The test equipment used during Probe Calibration, manufacturer, model number and, current calibration status are listed and located on the main APREL server R:\NCL\Calibration Equipment\Instrument List 2011.

This page has been reviewed for content and attested to by signature within this document.

9

835MHz Dipole Calibration By BACL at 2012-12-12

Mechanical Verification

APREL Length	APREL Height	Measured Length	Measured Height
161.0 mm	89.8 mm	161.2 mm	89.5 mm

Tissue Type	Measured Return Loss	Measured Impedance
Head	-36.177 dB	50.207 Ω
Body	-24.964 dB	49.594 Ω

Test Graphs:

Head Tissue

Return Loss :

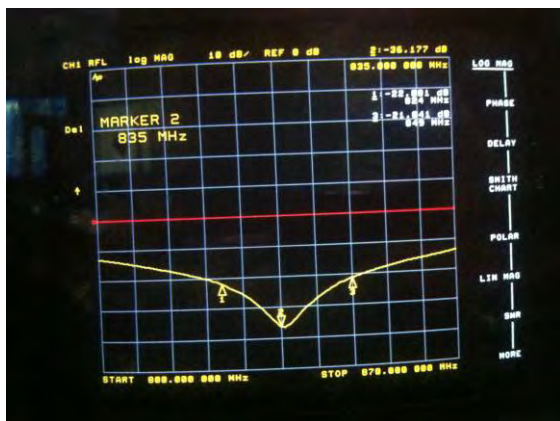

Impedance :



Body Tissue

Return Loss :

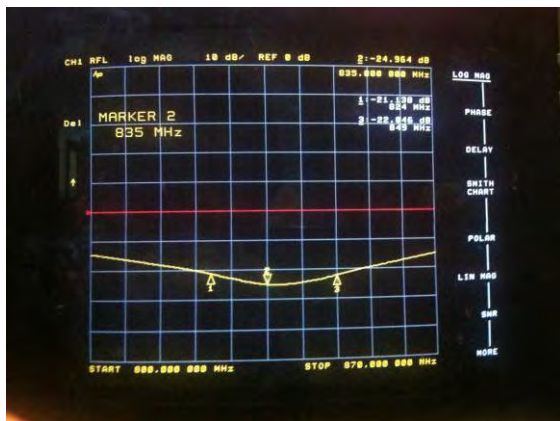

Impedance :



NCL CALIBRATION LABORATORIES

Calibration File No: DC-1331
Project Number: BAC-dipole –cal-5615

CERTIFICATE OF CALIBRATION

It is certified that the equipment identified below has been calibrated in the **NCL CALIBRATION LABORATORIES** by qualified personnel following recognized procedures and using transfer standards traceable to NRC/NIST.

Validation Dipole (Head & Body)

Manufacturer: APREL Laboratories
Part number: ALS-D-1900-S-2
Frequency: 1900 MHz
Serial No: 210-00710

Customer: Bay Area Compliance Laboratory

Calibrated: 25th August, 2011
Released on: 25th August, 2011

This Calibration Certificate is Incomplete Unless Accompanied with the Calibration Results Summary

Released By: _____

NCL CALIBRATION LABORATORIES

Suite 102, 303 Terry Fox Dr.
Kanata, ONTARIO
CANADA K2K 3J1

Division of APREL Lab.
TEL: (613) 435-8300
FAX: (613)435-8306

NCL Calibration Laboratories

Division of APREL Laboratories.

Conditions

Dipole 210-00710 was received in good condition and was a re-calibration.

Ambient Temperature of the Laboratory: 22 °C +/- 0.5°C

Temperature of the Tissue: 21 °C +/- 0.5°C

We the undersigned attest that to the best of our knowledge the calibration of this device has been accurately conducted and that all information contained within this report has been reviewed for accuracy.

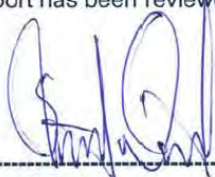

Stuart Nicol



C. Teodorian

Primary Measurement Standards

Instrument	Serial Number	Cal due date
Power meter Anritsu MA2408A	245025437	Nov.4, 2011
Power Sensor Anritsu MA2481D	103555	Nov 4, 2011
Attenuator HP 8495A (70dB) 1	944A10711	Aug.8, 2012
Network Analyzer Agilent E5071C	1334746J	Feb. 8, 2012

Secondary Measurement Standards

Signal Generator Agilent E4438C	-506 MY55182336	June 7, 2012
---------------------------------	-----------------	--------------

This page has been reviewed for content and attested to by signature within this document.

NCL Calibration Laboratories

Division of APREL Laboratories.

Calibration Results Summary

The following results relate the Calibrated Dipole and should be used as a quick reference for the user.

Mechanical Dimensions

Length: 67.1 mm
Height: 38.9 mm

Electrical Specification

Tissue	Frequency	SWR:	Return Loss	Impedance
Head	1900MHz	1.0417 U	-35.395dB	49.020 Ω
Body	1900MHz	1.1177 U	-25.424dB	55.435 Ω

System Validation Results

Tissue	Frequency	1 Gram	10 Gram	Peak
Head	1900 MHz	39.648	20.311	73.365
Body	1900 MHz	39.769	20.176	75.866

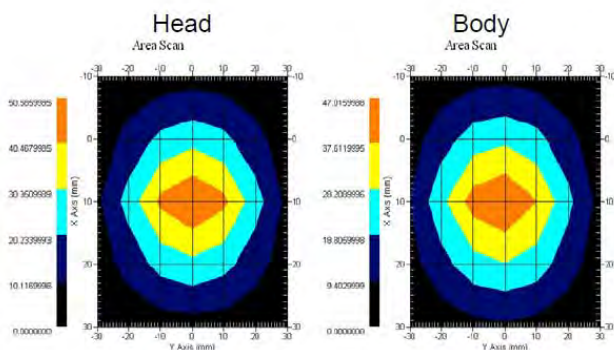

This page has been reviewed for content and attested to by signature within this document.

NCL Calibration Laboratories

Division of APREL Laboratories.

Introduction

This Calibration Report has been produced in line with the SSI Dipole Calibration Procedure SSI-TP-018-ALSAS. The results contained within this report are for Validation Dipole 210-00710. The calibration routine consisted of a three-step process. Step 1 was a mechanical verification of the dipole to ensure that it meets the mechanical specifications. Step 2 was an Electrical Calibration for the Validation Dipole, where the SWR, Impedance, and the Return loss were assessed. Step 3 involved a System Validation using the ALSAS-10U, along with APREL E-020 130 MHz to 26 GHz E-Field Probe Serial Number 212.

References

SSI-TP-018-ALSAS Dipole Calibration Procedure
 SSI-TP-016 Tissue Calibration Procedure
 IEEE 1528 "Recommended Practice for Determining the Peak Spatial-Average Specific Absorption Rate (SAR) in the Human Body Due to Wireless Communications Devices: Experimental Techniques"

Conditions

Dipole 210-00710 was new taken from stock.

Ambient Temperature of the Laboratory: 22 °C +/- 0.5°C
Temperature of the Tissue: 20 °C +/- 0.5°C

Dipole Calibration uncertainty

The calibration uncertainty for the dipole is made up of various parameters presented below.

Mechanical	1%
Positioning Error	1.22%
Electrical	1.7%
Tissue	2.2%
Dipole Validation	2.2%
TOTAL	8.32% (16.64% K=2)

This page has been reviewed for content and attested to by signature within this document.

NCL Calibration Laboratories

Division of APREL Laboratories.

Dipole Calibration Results

Mechanical Verification

APREL Length	APREL Height	Measured Length	Measured Height
68.0 mm	39.5 mm	67.1mm	38.9 mm

Electrical Validation

Tissue Type	Return Loss:	SWR:	Impedance:
Head	-29.360 dB	1.0732 U	47.869 Ω
Body	-22.799 dB	1.1566 U	48.022 Ω

Tissue Validation

	Dielectric constant, ϵ_r	Conductivity, σ [S/m]
Head Tissue 1900MHz	38.4	1.43
Body Tissue 1900MHz	51.87	1.59

This page has been reviewed for content and attested to by signature within this document.

NCL Calibration Laboratories

Division of APREL Laboratories.

The Following Graphs are the results as displayed on the Vector Network Analyzer.

S11 Parameter Return Loss

Head

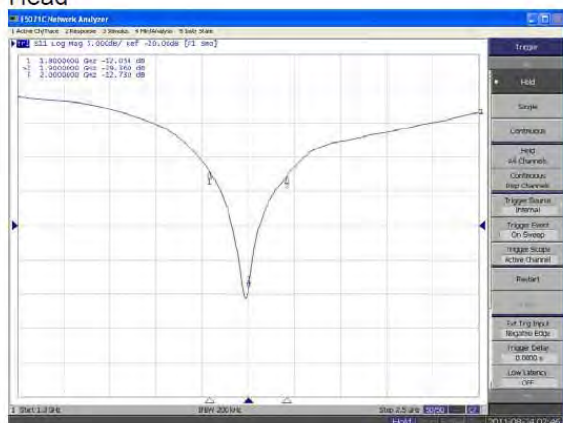

Body

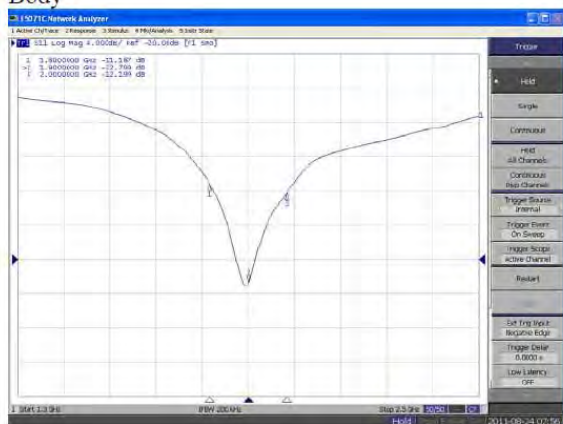

This page has been reviewed for content and attested to by signature within this document.

NCL Calibration Laboratories

Division of APREL Laboratories.

SWR

Head

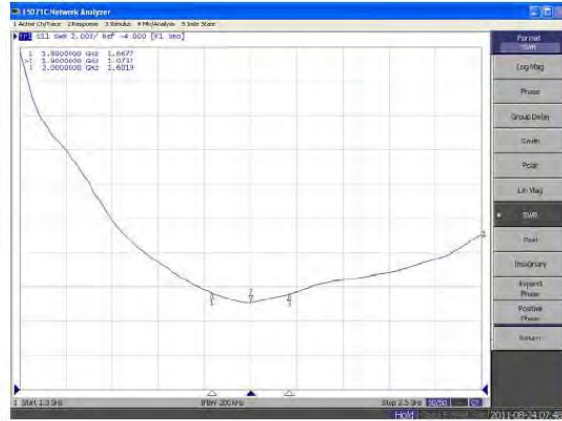

Body

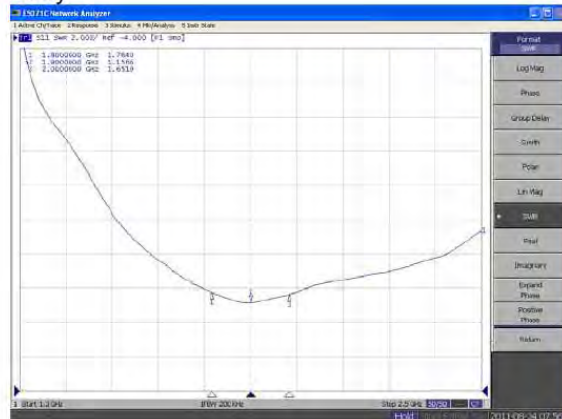

This page has been reviewed for content and attested to by signature within this document.

NCL Calibration Laboratories

Division of APREL Laboratories.

Smith Chart Dipole Impedance

Head

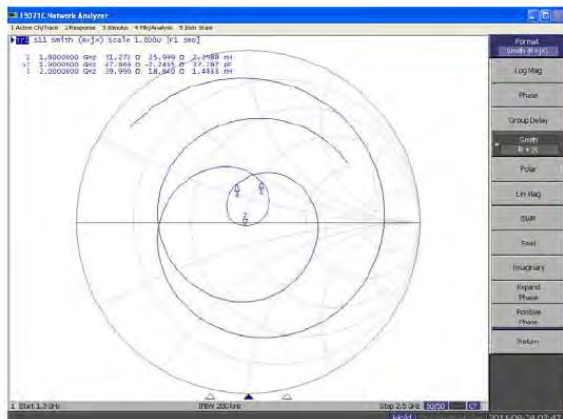

Body

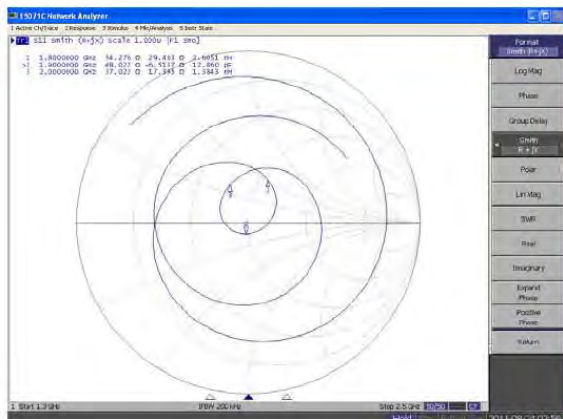

This page has been reviewed for content and attested to by signature within this document.

NCL Calibration Laboratories

Division of APREL Laboratories.

Test Equipment

The test equipment used during Probe Calibration, manufacturer, model number and, current calibration status are listed and located on the main APREL server R:\NCL\Calibration Equipment\Instrument List 2011

This page has been reviewed for content and attested to by signature within this document.

9

1900MHz Dipole Calibration By BACL at 2012-12-12

Mechanical Verification

APREL Length	APREL Height	Measured Length	Measured Height
68.0 mm	39.5 mm	68.2 mm	39.2 mm

Tissue Type	Measured Return Loss	Measured Impedance
Head	-28.284 dB	49.471 Ω
Body	-22.445 dB	51.588 Ω

Test Graphs:

Head Tissue

Return Loss :

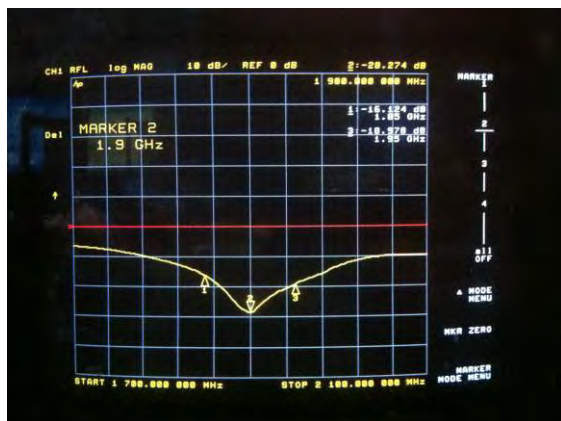

Impedance :



Body Tissue

Return Loss :

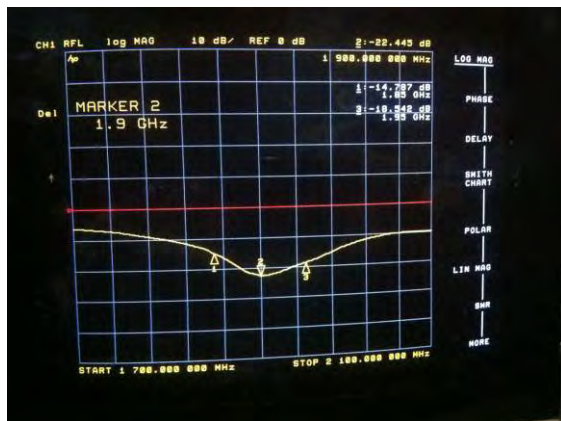

Impedance :



NCL CALIBRATION LABORATORIES

Calibration File No: DC-1330
Project Number: BAC-dipole-cal-5619

CERTIFICATE OF CALIBRATION

It is certified that the equipment identified below has been calibrated in the **NCL CALIBRATION LABORATORIES** by qualified personnel following recognized procedures and using transfer standards traceable to NRC/NIST.

Validation Dipole (Head & Body)

Manufacturer: APREL Laboratories
Part number: ALS-D-2450-S-2
Frequency: 2450 MHz
Serial No: 220-00758

Customer: Bay Area Compliance Laboratory

Calibrated: 25th August, 2011
Released on: 25th August, 2011

This Calibration Certificate is Incomplete Unless Accompanied with the Calibration Results Summary

Released By: _____

NCL CALIBRATION LABORATORIES

Suite 102, 303 Terry Fox Dr.
Kanata, ONTARIO
CANADA K2K 3J1

Division of APREL Lab.
TEL: (613) 435-8300
FAX: (613)435-8306

NCL Calibration Laboratories

Division of APREL Laboratories.

Conditions

Dipole 220-00758 was received in good condition and was a re-calibration.

Ambient Temperature of the Laboratory: 22 °C +/- 0.5°C

Temperature of the Tissue: 21 °C +/- 0.5°C

We the undersigned attest that to the best of our knowledge the calibration of this device has been accurately conducted and that all information contained within this report has been reviewed for accuracy.



Stuart Nicol



C. Teodorian

Primary Measurement Standards

Instrument	Serial Number	Cal due date
Power meter Anritsu MA2408A	245025437	Nov.4, 2011
Power Sensor Anritsu MA2481D	103555	Nov 4, 2011
Attenuator HP 8495A (70dB) 1	944A10711	Aug.8, 2012
Network Analyzer Agilent E5071C	1334746J	Feb. 8, 2012
Secondary Measurement Standards		
Signal Generator Agilent E4438C	-506 MY55182336	June 7, 2012

This page has been reviewed for content and attested to by signature within this document.

NCL Calibration Laboratories

Division of APREL Laboratories.

Calibration Results Summary

The following results relate the Calibrated Dipole and should be used as a quick reference for the user.

Mechanical Dimensions

Length: 52.4 mm
Height: 30.3 mm

Electrical Specification

Tissue	Frequency	SWR:	Return Loss	Impedance
Head	2450 MHz	1.0459 U	-33.024 dB	48.533 Ω
Body	2450 MHz	1.1159 U	-25.235 dB	46.676 Ω

System Validation Results

Tissue	Frequency	1 Gram	10 Gram	Peak
Head	2450 MHz	52.667	24.518	105.920
Body	2450 MHz	52.561	24.104	108.940

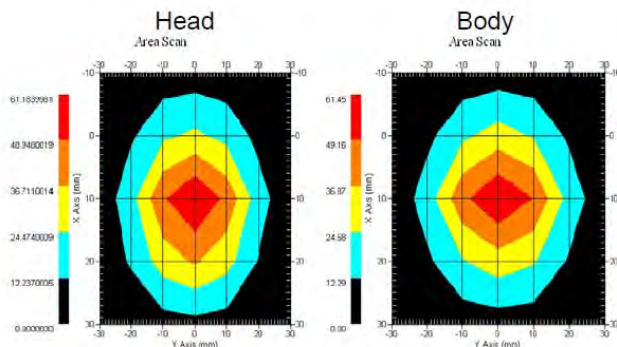

This page has been reviewed for content and attested to by signature within this document.

NCL Calibration Laboratories

Division of APREL Laboratories.

Introduction

This Calibration Report has been produced in line with the SSI Dipole Calibration Procedure SSI-TP-018-ALSAS. The results contained within this report are for Validation Dipole 220-00758. The calibration routine consisted of a three-step process. Step 1 was a mechanical verification of the dipole to ensure that it meets the mechanical specifications. Step 2 was an Electrical Calibration for the Validation Dipole, where the SWR, Impedance, and the Return loss were assessed. Step 3 involved a System Validation using the ALSAS-10U, along with APREL E-020 130 MHz to 26 GHz E-Field Probe Serial Number 212.

References

- SSI-TP-018-ALSAS Dipole Calibration Procedure
- SSI-TP-016 Tissue Calibration Procedure
- IEEE 1528 "Recommended Practice for Determining the Peak Spatial-Average Specific Absorption Rate (SAR) in the Human Body Due to Wireless Communications Devices: Experimental Techniques"
- IEC-62209 "Human exposure to radio frequency fields from hand-held and body-mounted wireless communication devices – Human models, instrumentation, and procedures"
- Part 1: "Procedure to determine the Specific Absorption Rate (SAR) for hand-held devices used in close proximity of the ear (frequency range of 300 MHz to 3 GHz)"
- IEC-62209 "Human exposure to radio frequency fields from hand-held and body-mounted wireless communication devices – Human models, instrumentation, and procedures"
- Part 2 *Draft*: "Procedure to determine the Specific Absorption Rate (SAR) for hand-held devices used in close proximity of the ear (frequency range of 30 MHz to 6 GHz)"

Conditions

Dipole 220-00758 was a re-calibration.

Ambient Temperature of the Laboratory: 22 °C +/- 0.5°C
Temperature of the Tissue: 20 °C +/- 0.5°C

Dipole Calibration uncertainty

The calibration uncertainty for the dipole is made up of various parameters presented below.

Mechanical	1%
Positioning Error	1.22%
Electrical	1.7%
Tissue	2.2%
Dipole Validation	2.2%
TOTAL	8.32% (16.64% K=2)

4

This page has been reviewed for content and attested to by signature within this document.

NCL Calibration Laboratories

Division of APREL Laboratories.

Dipole Calibration Results

Mechanical Verification

APREL Length	APREL Height	Measured Length	Measured Height
51.5 mm	30.4 mm	52.4 mm	30.3 mm

Electrical Calibration

Tissue Type	Return Loss:	SWR:	Impedance:
Head	-33.024 dB	1.0459 U	48.533 Ω
Body	-25.235 dB	1.1159 U	46.676 Ω

Tissue Validation

	Dielectric constant, ϵ_r	Conductivity, σ [S/m]
Head Tissue 2450MHz	38.2	1.82
Body Tissue 2450MHz	51.74	1.96

This page has been reviewed for content and attested to by signature within this document.

NCL Calibration Laboratories

Division of APREL Laboratories.

The Following Graphs are the results as displayed on the Vector Network Analyzer.

S11 Parameter Return Loss

Head

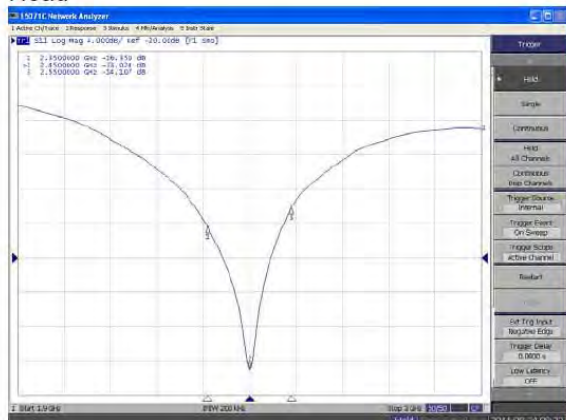

Body

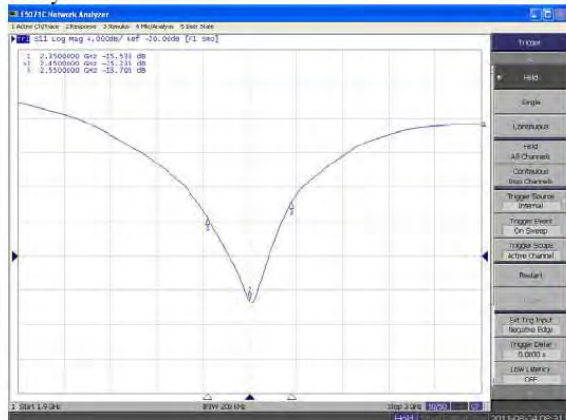

This page has been reviewed for content and attested to by signature within this document.

NCL Calibration Laboratories

Division of APREL Laboratories.

SWR

Head

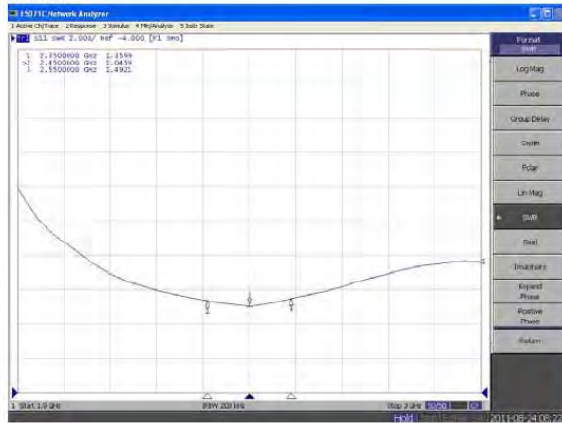

Body

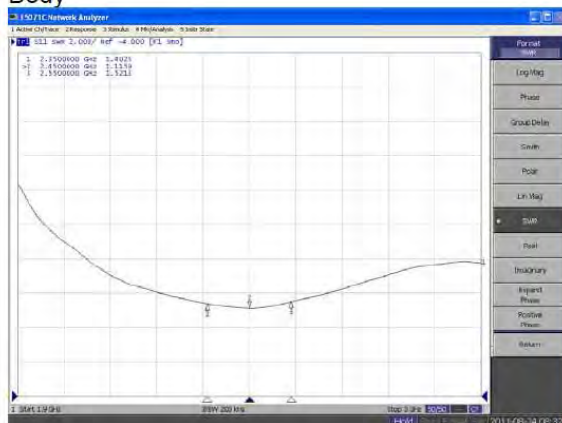

This page has been reviewed for content and attested to by signature within this document.

NCL Calibration Laboratories

Division of APREL Laboratories.

Smith Chart Dipole Impedance

Head

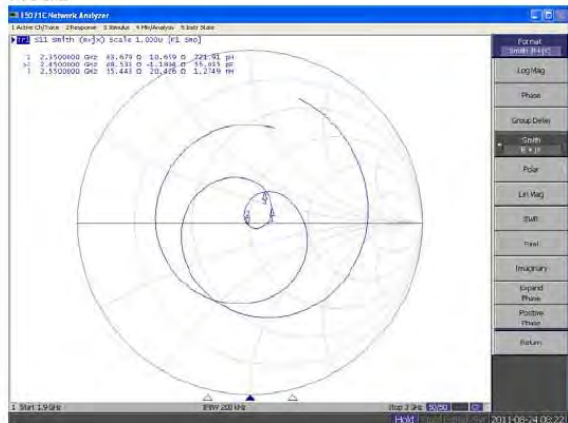

Body

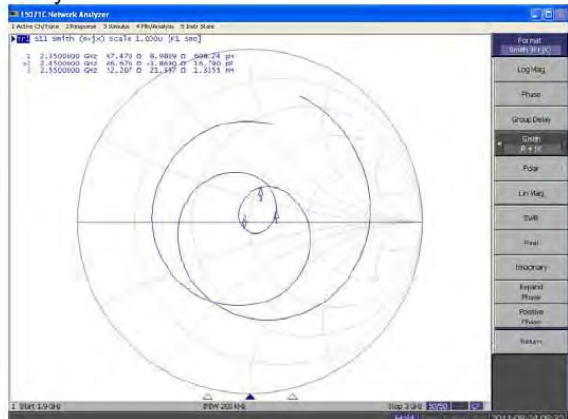

This page has been reviewed for content and attested to by signature within this document.

NCL Calibration Laboratories

Division of APREL Laboratories.

Test Equipment

The test equipment used during Probe Calibration, manufacturer, model number and, current calibration status are listed and located on the main APREL server R:\NCL\Calibration Equipment\Instrument List May 2011.

This page has been reviewed for content and attested to by signature within this document.

9

2450MHz Dipole Calibration By BACL at 2012-12-12

Mechanical Verification

APREL Length	APREL Height	Measured Length	Measured Height
51.5mm	30.4 mm	51.6 mm	30.2 mm

Tissue Type	Measured Return Loss	Measured Impedance
Head	-35.559 dB	49.627 Ω
Body	-27.477 dB	48.238 Ω

Test Graphs:

Head Tissue

Return Loss :

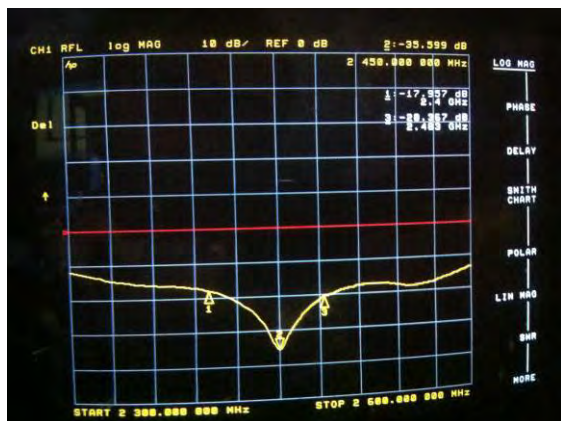

Impedance :

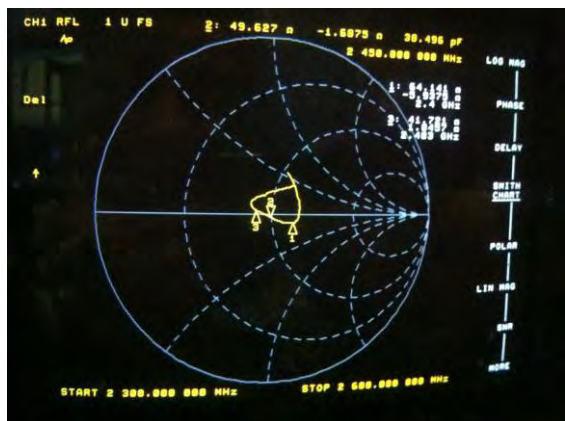

Body Tissue

Return Loss :

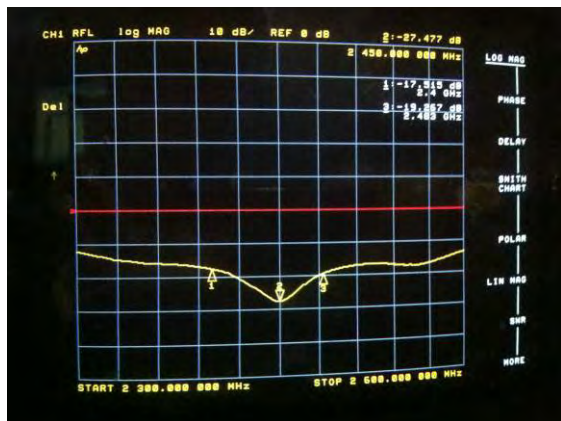

Impedance :



APPENDIX D EUT TEST POSITION PHOTOS

Liquid depth $\geq 15\text{cm}$

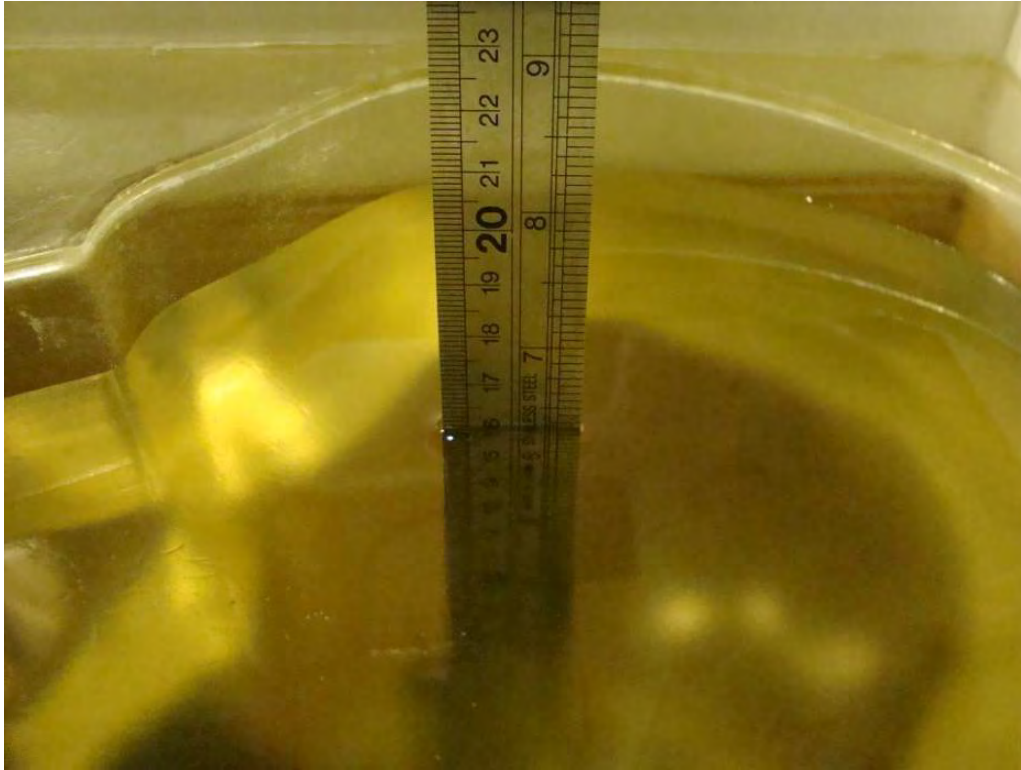

Body-worn-Headset Front Setup Photo

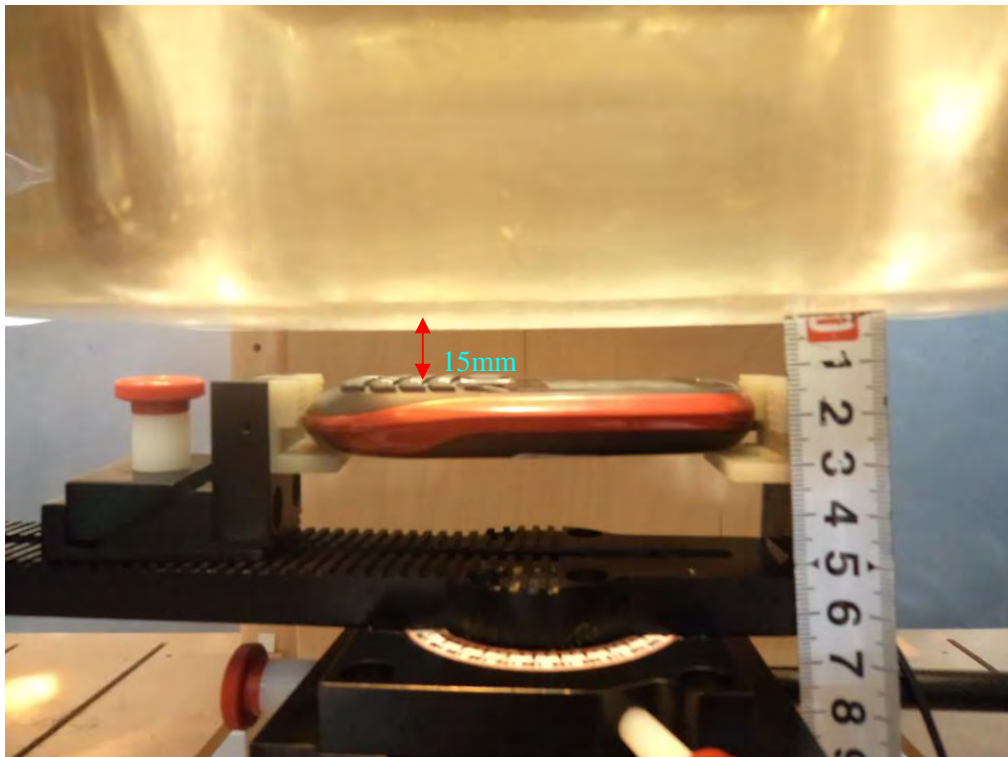

Body-worn-Headset Back Setup Photo

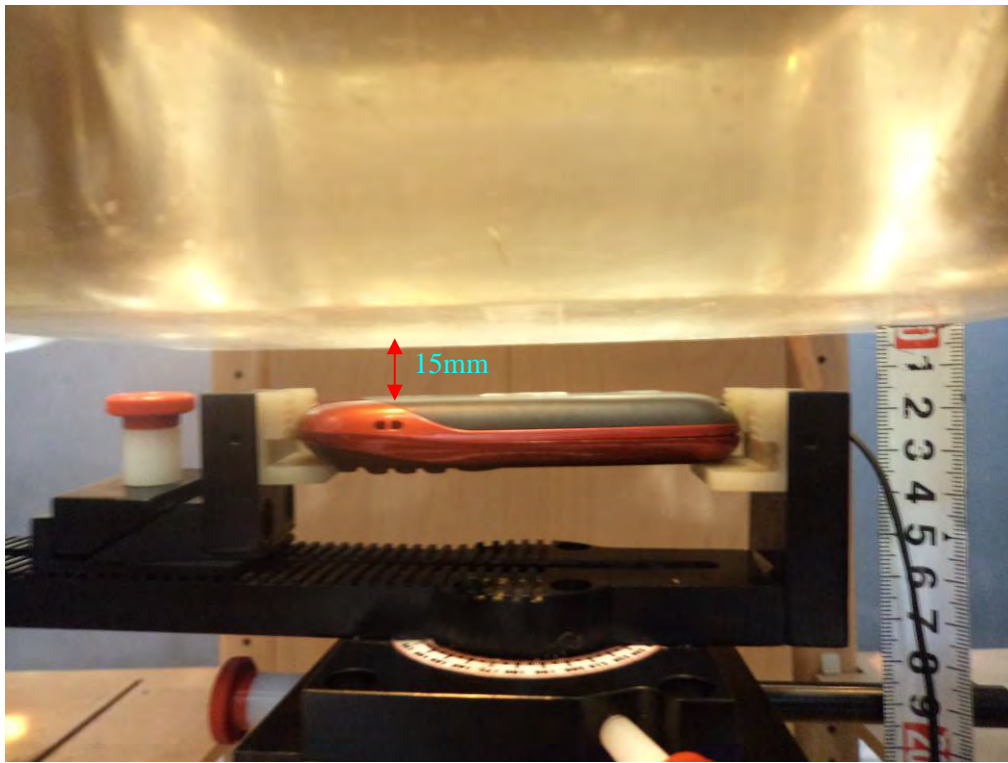

Body-Right Setup Photo



Body-Top Setup Photo

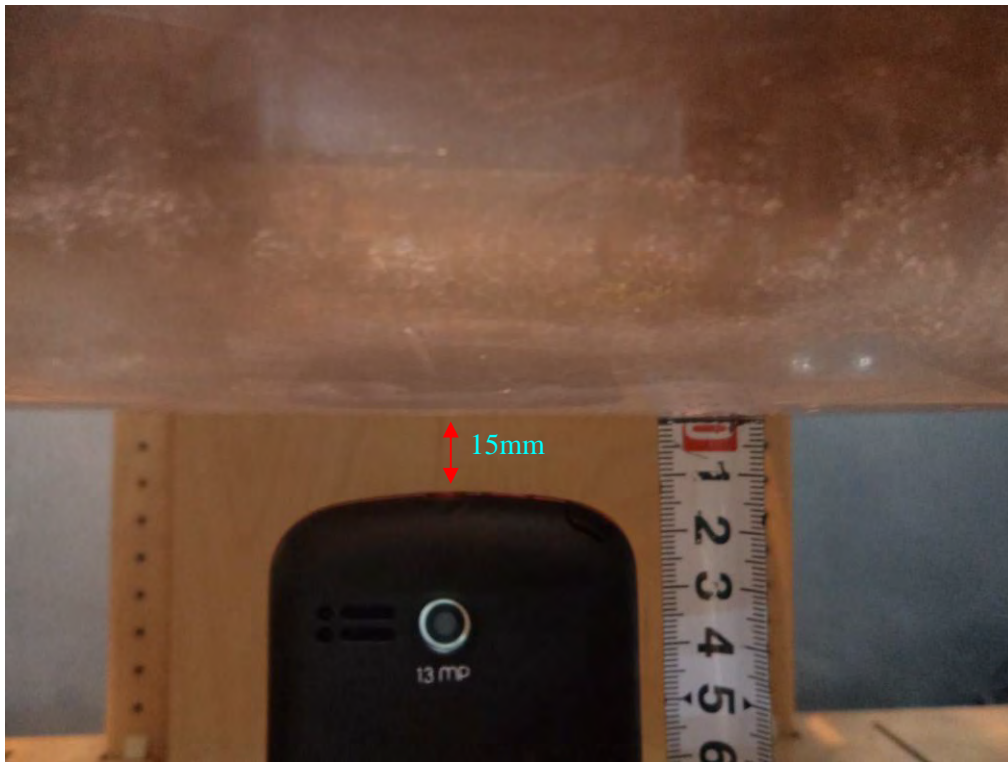

Left Head Touch Setup Photo



Left Head Tilt Setup Photo



Right Head Touch Setup Photo



Right Head Tilt Setup Photo

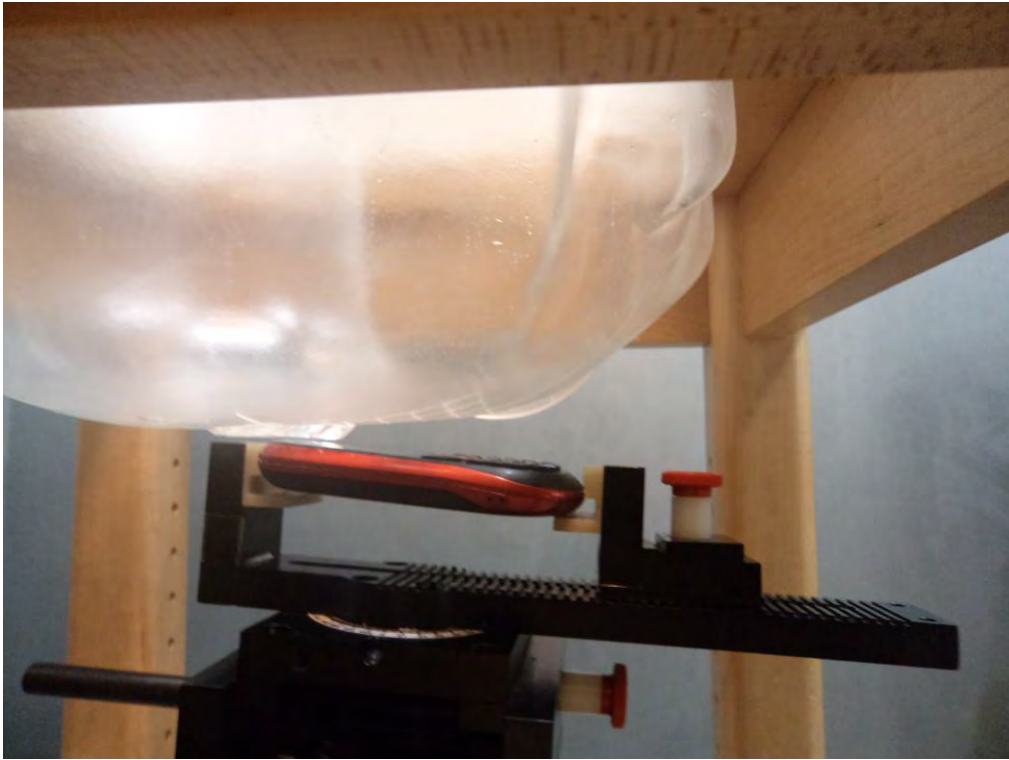

APPENDIX E EUT PHOTOS

EUT – Front View



EUT – Back View



EUT – Left Side View



EUT – Right Side View



EUT –Top View



EUT –Bottom View



EUT –Antenna View

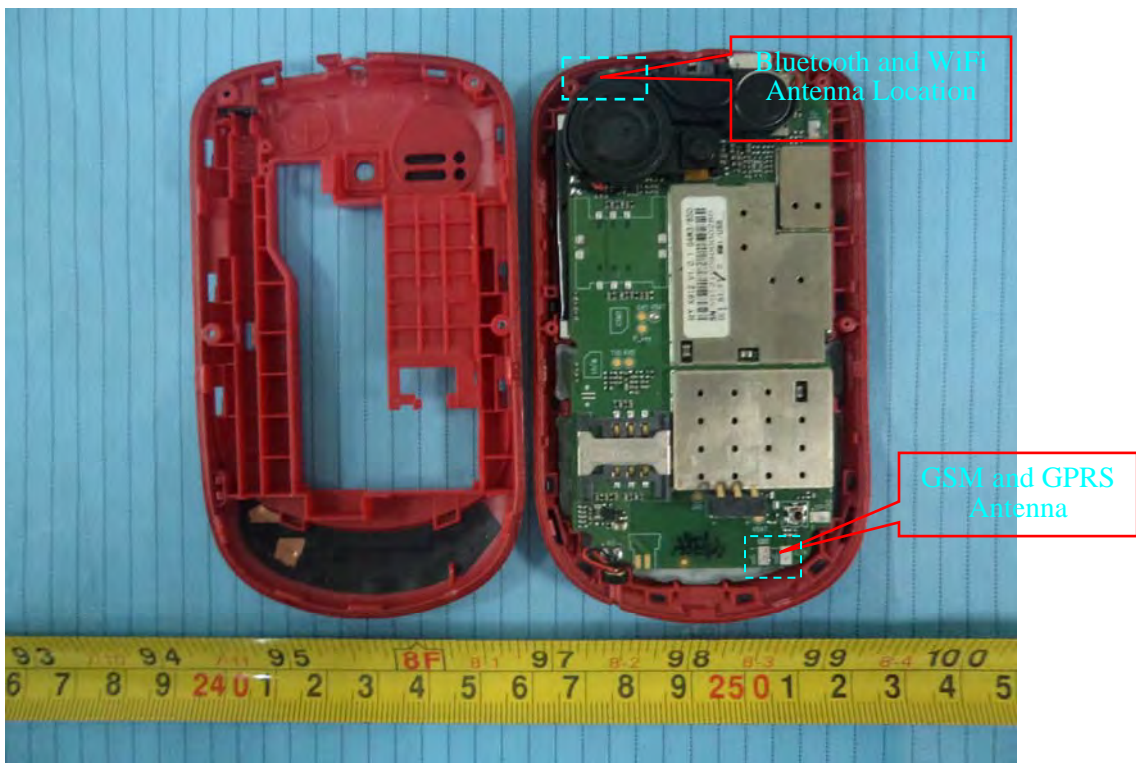

EUT –Uncovered View



APPENDIX F INFORMATIVE REFERENCES

- [1] Federal Communications Commission, \Report and order: Guidelines for evaluating the environmental effects of radiofrequency radiation", Tech. Rep. FCC 96-326, FCC, Washington, D.C. 20554, 1996.
- [2] David L. Means Kwok Chan, Robert F. Cleveland, \Evaluating compliance with FCC guidelines for human exposure to radiofrequency electromagnetic fields", Tech. Rep., Federal Communication Commission, Office of Engineering & Technology, Washington, DC, 1997.
- [3] Thomas Schmid, Oliver Egger, and Niels Kuster, \Automated E-field scanning system for dosimetric assessments", IEEE Transactions on Microwave Theory and Techniques, vol. 44, pp. 105-113, Jan. 1996.
- [4] Niels Kuster, Ralph Kastle, and Thomas Schmid, \Dosimetric evaluation of mobile communications equipment with known precision", IEICE Transactions on Communications, vol. E80-B, no. 5, pp. 645-652, May 1997.
- [5] CENELEC, \Considerations for evaluating of human exposure to electromagnetic fields (EMFs) from mobile telecommunication equipment (MTE) in the frequency range 30MHz - 6GHz", Tech. Rep., CENELEC, European Committee for Electrotechnical Standardization, Brussels, 1997.
- [6] ANSI, ANSI/IEEE C95.1-1992: IEEE Standard for Safety Levels with Respect to Human Exposure to Radio Frequency Electromagnetic Fields, 3 kHz to 300 GHz, The Institute of Electrical and Electronics Engineers, Inc., New York, NY 10017, 1992.
- [7] Katja Pokovic, Thomas Schmid, and Niels Kuster, \Robust setup for precise calibration of E-field probes in tissue simulating liquids at mobile communications frequencies", in ICECOM '97, Dubrovnik, October 15-17, 1997, pp. 120-24.
- [8] Katja Pokovic, Thomas Schmid, and Niels Kuster, \E-field probe with improved isotropy in brain simulating liquids", in Proceedings of the ELMAR, Zadar, Croatia, 23-25 June, 1996, pp. 172-175.
- [9] Volker Hombach, Klaus Meier, Michael Burkhardt, Eberhard Kuhn, and Niels Kuster, \The dependence of EM energy absorption upon human head modeling at 900 MHz", IEEE Transactions on Microwave Theory and Techniques, vol. 44, no. 10, pp. 1865-1873, Oct. 1996.
- [10] Klaus Meier, Ralf Kastle, Volker Hombach, Roger Tay, and Niels Kuster, \The dependence of EM energy absorption upon human head modeling at 1800 MHz", IEEE Transactions on Microwave Theory and Techniques, Oct. 1997, in press.
- [11] W. Gander, Computermathematik, Birkhaeuser, Basel, 1992.
- [12] W. H. Press, S. A. Teukolsky, W. T. Vetterling, and B. P. Flannery, Numerical Recipes in C, The Art of Scientific Computing, Second Edition, Cambridge University Press, 1992. Dosimetric Evaluation of Sample device, month 1998 9
- [13] NIS81 NAMAS, \The treatment of uncertainty in EMC measurement", Tech. Rep., NAMAS Executive, National Physical Laboratory, Teddington, Middlesex, England, 1994.
- [14] Barry N. Taylor and Christ E. Kuyatt, \Guidelines for evaluating and expressing the uncertainty of NIST measurement results", Tech. Rep., National Institute of Standards and Technology, 1994. Dosimetric Evaluation of Sample device, month 1998 10.

***** END OF REPORT *****