



RF TEST REPORT



Report No.: 14070594-FCC-R

Supersede Report No.: N/A

Applicant	ITALCOM GROUP	
Product Name	4G Smart Phone	
Model No.	MAXX	
Serial No.	N/A	
Test Standard	FCC Part 27: 2014; ANSI/TIA C603 D: 2010	
Test Date	February 04 to February 05, 2015	
Issue Date	February 06, 2015	
Test Result	<input checked="" type="checkbox"/> Pass <input type="checkbox"/> Fail	
Equipment complied with the specification	<input checked="" type="checkbox"/>	
Equipment did not comply with the specification	<input type="checkbox"/>	
		
Dustin Wang Test Engineer	Alex Liu Checked By	
<p>This test report may be reproduced in full only Test result presented in this test report is applicable to the tested sample only</p>		

Issued by:

SIEMIC (SHENZHEN-CHINA) LABORATORIES

Zone A, Floor 1, Building 2 Wan Ye Long Technology Park

South Side of Zhoushi Road, Bao' an District, Shenzhen, Guangdong China 518108

Phone: +86 0755 2601 4629801 Email: China@siemic.com.cn

Laboratories Introduction

SIEMIC, headquartered in the heart of Silicon Valley, with superior facilities in US and Asia, is one of the leading independent testing and certification facilities providing customers with one-stop shop services for Compliance Testing and Global Certifications.



In addition to testing and certification, SIEMIC provides initial design reviews and compliance management throughout a project. Our extensive experience with China, Asia Pacific, North America, European, and International compliance requirements, assures the fastest, most cost effective way to attain regulatory compliance for the global markets.

Accreditations for Conformity Assessment

Country/Region	Scope
USA	EMC, RF/Wireless, SAR, Telecom
Canada	EMC, RF/Wireless, SAR, Telecom
Taiwan	EMC, RF, Telecom, SAR, Safety
Hong Kong	RF/Wireless, SAR, Telecom
Australia	EMC, RF, Telecom, SAR, Safety
Korea	EMI, EMS, RF, SAR, Telecom, Safety
Japan	EMI, RF/Wireless, SAR, Telecom
Singapore	EMC, RF, SAR, Telecom
Europe	EMC, RF, SAR, Telecom, Safety

Test Report	14070594-FCC-R
Page	3 of 56

This page has been left blank intentionally.

CONTENTS

1. REPORT REVISION HISTORY	5
2. CUSTOMER INFORMATION	5
3. TEST SITE INFORMATION.....	5
4. EQUIPMENT UNDER TEST (EUT) INFORMATION	6
5. TEST SUMMARY	7
6. MEASUREMENTS, EXAMINATION AND DERIVED RESULTS	8
6.1 RF EXPOSURE (SAR).....	8
6.2 RF OUTPUT POWER	9
6.3 PEAK-AVERAGE RATIO.....	21
6.4 MODULATION CHARACTERISTIC.....	23
6.5 OCCUPIED BANDWIDTH.....	24
6.6 SPURIOUS EMISSIONS AT ANTENNA TERMINALS	33
6.7 SPURIOUS RADIATED EMISSIONS	35
6.8 BAND EDGE.....	37
6.9 FREQUENCY STABILITY	44
ANNEX A. TEST INSTRUMENT.....	46
ANNEX B. EUT AND TEST SETUP PHOTOGRAPHS.....	47
ANNEX C. TEST SETUP AND SUPPORTING EQUIPMENT.....	52
ANNEX C.II. EUT OPERATING CONKITIONS	54
ANNEX D. USER MANUAL / BLOCK DIAGRAM / SCHEMATICS / PARTLIST	55
ANNEX E. DECLARATION OF SIMILARITY.....	56

1. Report Revision History

Report No.	Report Version	Description	Issue Date
14070594-FCC-R	NONE	Original	February 06, 2015

2. Customer information

Applicant Name	ITALCOM GROUP
Applicant Add	1728 Coral Way, Coral Gables, Miami, Florida, United States
Manufacturer	UTCOM TECHNOLOGY CO.,LIMITED
Manufacturer Add	C1105-1107, Tiley Central Plaza, No3 Haide Road, Nanshan District, Shenzhen 518054

3. Test site information

Lab performing tests	SIEMIC (Shenzhen-China) LABORATORIES
Lab Address	Zone A, Floor 1, Building 2 Wan Ye Long Technology Park South Side of Zhoushi Road, Bao' an District, Shenzhen, Guangdong China 518108
FCC Test Site No.	718246
IC Test Site No.	4842E-1
Test Software	Radiated Emission Program-To Shenzhen v2.0

4. Equipment under Test (EUT) Information

Description of EUT:	4G Smart Phone
Main Model:	MAXX
Serial Model:	N/A
Date EUT received:	February 03, 2015
Test Date(s):	February 04 to February 05, 2015
Equipment Category :	PCE
Antenna Gain:	LTE Band 4: 0.35 dBi
Type of Modulation:	LTE Band: QPSK, 16QAM
RF Operating Frequency (ies):	LTE Band 4 TX: 1712.5 ~ 1752.5 MHz; RX : 2112.5 ~ 2152.5 MHz
Maximum Conducted AV Power:	LTE Band 4: 21.51 dBm
ERP/EIRP:	LTE Band 4: 17.18 dBm / EIRP
Port:	Power Port, Earphone Port, USB Port
Input Power:	Battery: Model: NYX1600A56X53 Spec: 3.7V 1600mAh Limited charger voltage: 4.2V Adapter: Input: AC 100-240V; 50/60Hz 0.15A Output: DC 5.0V; 500mA
Trade Name :	NYX
GPRS/EGPRS Multi-slot class	8/10/12
FCC ID:	YPVITALCOMMAXX

5. Test Summary

The product was tested in accordance with the following specifications.

All testing has been performed according to below product classification:

FCC Rules	Description of Test	Result
§ 1.1307; § 2.1093	RF Exposure (SAR)	Compliance
§ 27.50(c.10); § 27.50(d.4)	RF Output Power	Compliance
§ 27.50(d)	Peak-Average Ratio	Compliance
§ 2.1047	Modulation Characteristics	Compliance
§ 27.53(a.5)	99% & -26 dB Occupied Bandwidth	Compliance
§ 2.1051; § 27.53(h)	Spurious Emissions at Antenna Terminal	Compliance
§ 2.1053; § 27.53(h)	Field Strength of Spurious Radiation	Compliance
§ 27.53(h)	Out of band emission, Band Edge	Compliance
§ 2.1055; § 27.5(h); § 27.54	Frequency stability vs. temperature Frequency stability vs. voltage	Compliance

Note: Testing was performed by configuring EUT to maximum output power status, the declared output power class for different

Measurement Uncertainty

Emissions		
Test Item	Description	Uncertainty
Band Edge and Radiated Spurious Emissions	Confidence level of approximately 95% (in the case where distributions are normal), with a coverage factor of 2 (for EUTs < 0.5m X 0.5m X 0.5m)	+5.6dB/-4.5dB
-	-	-

6. MEASUREMENTS, EXAMINATION AND DERIVED RESULTS

6.1 RF Exposure (SAR)

Test Result: Pass

The EUT is a portable device, thus requires SAR evaluation;

Please refer to RF Exposure Evaluation Report: 14070594-FCC-H.

6.2 RF Output Power

Temperature	19°C
Relative Humidity	58%
Atmospheric Pressure	1008mbar
Test date :	February 04, 2015
Tested By :	Dustin Wang

Requirement(s):

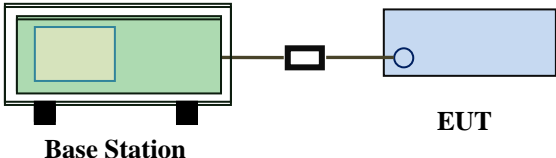
Spec	Item	Requirement	Applicable
§27.50 (c)	a)	EIRP: 30dBm	<input checked="" type="checkbox"/>
Test Setup	 <p style="text-align: center;"> Base Station EUT </p>		
Test Procedure	<p>For Conducted Power:</p> <ul style="list-style-type: none"> - The transmitter output port was connected to base station. - Set EUT at maximum power through base station. - Select lowest, middle, and highest channels for each band and different test mode. <p>For ERP/EIRP:</p> <ul style="list-style-type: none"> - The transmitter was placed on a wooden turntable, and it was transmitting into a non-radiating load which was also placed on the turntable. - The measurement antenna was placed at a distance of 3 meters from the EUT. During the tests, the antenna height and polarization as well as EUT azimuth were varied in order to identify the maximum level of emissions from the EUT. The test was performed by placing the EUT on 3-orthogonal axis. - The frequency range up to tenth harmonic of the fundamental frequency was investigated. - Remove the EUT and replace it with substitution antenna. A signal generator was connected to the substitution antenna by a non-radiating cable. The absolute levels of the spurious emissions 		

Test Report	14070594-FCC-R
Page	10 of 56

	<p>were measured by the substitution.</p> <ul style="list-style-type: none"> - Spurious emissions in dB = $10 \log (\text{TX power in Watts}/0.001)$ – the absolute level - Spurious attenuation limit in dB = $43 + 10 \text{ Log}_{10} (\text{power out in Watts})$.
Remark	
Result	<input checked="" type="checkbox"/> Pass <input type="checkbox"/> Fail

Test Data Yes N/A

Test Plot Yes (See below) N/A

Conducted Power

LTE Band 4

BW (MHz)	Ch	Freq. (MHz)	Modulation	UL RB Allocation	UL RB Offset	MPR	Average power (dBm)
20MHz	20050	1720.0	QPSK	1	0	0	21.23
				1	49	0	21.32
				1	99	0	21.18
				50	0	1	21.11
				50	24	1	21.16
				50	49	1	21.08
				100	0	1	21.05
			16QAM	1	0	1	21.03
				1	49	1	21.11
				1	99	1	21.12
				50	0	2	20.85
				50	24	2	20.82
				50	49	2	20.74
				100	0	2	20.76
	20175	1732.5	QPSK	1	0	0	21.42
				1	49	0	21.34
				1	99	0	21.45
				50	0	1	21.44
				50	24	1	21.51
				50	49	1	21.38
				100	0	1	21.42
			16QAM	1	0	1	21.01
				1	49	1	21.05
				1	99	1	20.64
50				0	2	20.49	
50				24	2	20.63	
50				49	2	20.75	
100				0	2	20.77	
20300	1745.0	QPSK	1	0	0	21.36	
			1	49	0	21.39	
			1	99	0	21.43	

				50	0	1	20.43
				50	24	1	20.43
				50	49	1	20.94
				100	0	1	20.68
			16QAM	1	0	1	20.86
				1	49	1	20.98
				1	99	1	20.84
				50	0	2	20.76
				50	24	2	20.54
				50	49	2	20.51
				100	0	2	20.55

BW (MHz)	Ch	Freq. (MHz)	Modulation	UL RB Allocation	UL RB Offset	MPR	Average power (dBm)
15MHz	20025	1717.5	QPSK	1	0	0	21.27
				1	37	0	21.35
				1	74	0	21.11
				36	0	1	21.34
				36	16	1	21.22
				36	35	1	21.03
				75	0	1	21.33
			16QAM	1	0	1	20.59
				1	37	1	20.49
				1	74	1	20.48
				36	0	2	20.97
				36	16	2	20.52
				36	35	2	20.63
				75	0	2	20.54
	20175	1732.5	QPSK	1	0	0	21.22
				1	37	0	21.19
				1	74	0	21.34
				36	0	1	20.89
				36	16	1	20.94
				36	35	1	20.88
				75	0	1	20.79
16QAM			1	0	1	20.95	
			1	37	1	20.81	

				1	74	1	20.95
				36	0	2	20.26
				36	16	2	20.37
				36	35	2	20.29
				75	0	2	20.58
	20325	1747.5	QPSK	1	0	0	21.34
				1	37	0	21.34
				1	74	0	21.36
				36	0	1	20.63
				36	16	1	20.59
				36	35	1	20.61
				75	0	1	20.65
	16QAM	1	0	1	20.37		
		1	37	1	20.66		
1		74	1	20.71			
36		0	2	20.38			
36		16	2	20.26			
36		35	2	20.32			
75		0	2	20.64			

BW (MHz)	Ch	Freq. (MHz)	Modulation	UL RB Allocation	UL RB Offset	MPR	Average power (dBm)
10MHz	20000	1715.0	QPSK	1	0	0	21.41
				1	24	0	21.45
				1	49	0	21.25
				25	0	1	20.82
				25	12	1	20.97
				25	24	1	20.86
			16QAM	50	0	1	20.85
				1	0	1	21.04
				1	24	1	20.75
				1	49	1	20.79
				25	0	2	20.31
				25	12	2	20.59
				25	24	2	20.36
	50	0	2	20.56			
20175	1732.5	QPSK	1	0	0	21.35	

					1	24	0	21.42
					1	49	0	21.36
					25	0	1	20.82
					25	12	1	20.79
					25	24	1	20.89
					50	0	1	20.87
				16QAM	1	0	1	20.63
					1	24	1	20.56
					1	49	1	20.48
					25	0	2	20.09
					25	12	2	20.23
					25	24	2	20.34
					50	0	2	20.41
					20350	1750.0	QPSK	1
	1	24	0	21.15				
	1	49	0	21.37				
	25	0	1	20.88				
	25	12	1	20.99				
	25	24	1	20.75				
	50	0	1	20.93				
	16QAM	1	0	1				20.93
		1	24	1			20.91	
		1	49	1			20.98	
		25	0	2			20.64	
		25	12	2			20.67	
		25	24	2			20.54	
				50			0	2

BW (MHz)	Ch	Freq. (MHz)	Modulation	UL RB Allocation	UL RB Offset	MPR	Average power (dBm)
5MHz	20000	1715.0	QPSK	1	0	0	21.24
				1	12	0	21.41
				1	24	0	21.37
				12	0	1	20.99
				12	6	1	20.78
				12	11	1	20.64
			16QAM	25	0	1	20.35
				1	0	1	21.01
				1	12	1	21.07
				1	24	1	20.68
				12	0	2	20.75
				12	6	2	20.62
	20175	1732.5	QPSK	12	11	2	20.55
				25	0	2	20.35
				1	0	0	21.43
				1	12	0	21.14
				1	24	0	21.19
				12	0	1	20.85
			16QAM	12	6	1	20.67
				12	11	1	20.75
				25	0	1	20.56
				1	0	1	20.73
				1	12	1	20.66
				1	24	1	20.57
20350	1750.0	QPSK	12	0	2	20.15	
			12	6	2	20.36	
			12	11	2	20.36	
			25	0	2	20.24	
			1	0	0	21.23	
			1	12	0	21.35	
1	24	0	21.35				
12	0	1	20.84				
12	6	1	20.89				
12	11	1	20.86				

				25	0	1	20.69
			16QAM	1	0	1	20.83
				1	12	1	20.86
				1	24	1	20.84
				12	0	2	20.05
				12	6	2	20.18
				12	11	2	20.32
				25	0	2	20.12

BW (MHz)	Ch	Freq. (MHz)	Modulation	UL RB Allocation	UL RB Offset	MPR	Average power (dBm)
3MHz	19965	1711.5	QPSK	1	0	0	21.42
				1	7	0	21.35
				1	14	0	21.24
				8	0	1	20.64
				8	4	1	20.56
				8	7	1	20.62
				15	0	1	20.67
			16QAM	1	0	1	20.97
				1	7	1	20.35
				1	14	1	20.68
				8	0	2	20.68
				8	4	2	20.57
				8	7	2	20.56
				15	0	2	20.49
	20175	1732.5	QPSK	1	0	0	21.29
				1	7	0	21.41
				1	14	0	21.37
				8	0	1	20.79
				8	4	1	20.75
				8	7	1	20.61
				15	0	1	20.78
			16QAM	1	0	1	20.62
				1	7	1	20.51
				1	14	1	20.83
			8	0	2	20.45	
			8	4	2	20.39	

	20385	1753.5	QPSK	8	7	2	20.29
				15	0	2	20.35
				1	0	0	21.43
				1	7	0	21.38
				1	14	0	21.32
				8	0	1	20.75
				8	4	1	20.83
				8	7	1	20.92
			16QAM	15	0	1	20.82
				1	0	1	20.61
				1	7	1	20.65
				1	14	1	20.52
				8	0	2	20.32
				8	4	2	20.25
				8	7	2	20.42
				15	0	2	20.37

BW (MHz)	Ch	Freq. (MHz)	Modulation	UL RB Allocation	UL RB Offset	MPR	Average power (dBm)
1.4MHz	19957	1710.7	QPSK	1	0	0	21.42
				1	2	0	21.31
				1	5	0	21.29
				3	0	0	21.4
				3	1	0	21.32
				3	2	0	21.41
				6	0	1	20.69
			16QAM	1	0	1	20.78
				1	2	1	20.77
				1	5	1	20.85
				3	0	1	20.82
				3	1	1	20.88
				3	2	1	20.81
				6	0	2	20.05
	20175	1732.5	QPSK	1	0	0	21.32
				1	2	0	21.39
1				5	0	21.22	
3				0	0	21.15	

					3	1	0	21.12	
					3	2	0	21.17	
					6	0	1	20.91	
				16QAM	1	0	1	20.91	
					1	2	1	20.87	
					1	5	1	20.75	
					3	0	1	20.57	
					3	1	1	20.42	
					3	2	1	20.54	
					6	0	2	20.19	
					QPSK	1	0	0	21.12
						1	2	0	21.09
		1	5	0		21.35			
		3	0	0		21.41			
		3	1	0		21.42			
		3	2	0		21.35			
		6	0	1		20.83			
		16QAM	1	0		1	20.78		
			1	2		1	20.88		
			1	5	1	20.77			
			3	0	1	20.92			
3	1		1	20.87					
3	2		1	20.23					
6	0		2	20.34					

ERP & EIRP

EIRP for LTE Band 4 (Part 27)

Frequency (MHz)	BW (MHz)	Modulation	RB Size/Offset	Substituted level (dBm)	Antenna Polarization	Antenna Gain correction (dBi)	Cable Loss (dB)	Absolute Level (dBm)	Limit (dBm)
1710.7	1.4	QPSK	1/0	9.77	V	7.95	0.79	16.93	30
1732.5	1.4	QPSK	1/0	9.92	V	7.95	0.79	17.08	30
1754.3	1.4	QPSK	1/0	9.85	V	7.95	0.79	17.01	30
1710.7	1.4	QPSK	1/0	9.97	H	7.95	0.79	17.13	30
1732.5	1.4	QPSK	1/0	9.76	H	7.95	0.79	16.92	30
1754.3	1.4	QPSK	1/0	9.74	H	7.95	0.79	16.9	30
1710.7	1.4	16-QAM	1/5	9.86	V	7.95	0.79	17.02	30
1732.5	1.4	16-QAM	1/0	10.02	V	7.95	0.79	17.18	30
1754.3	1.4	16-QAM	1/0	9.96	V	7.95	0.79	17.12	30
1710.7	1.4	16-QAM	1/5	9.97	H	7.95	0.79	17.13	30
1732.5	1.4	16-QAM	1/0	9.75	H	7.95	0.79	16.91	30
1754.3	1.4	16-QAM	1/0	9.79	H	7.95	0.79	16.95	30
1711.5	3	QPSK	1/0	9.74	V	7.95	0.79	16.9	30
1732.5	3	QPSK	1/0	9.69	V	7.95	0.79	16.85	30
1753.5	3	QPSK	1/0	9.84	V	7.95	0.79	17	30
1711.5	3	QPSK	1/0	9.68	H	7.95	0.79	16.84	30
1732.5	3	QPSK	1/0	9.74	H	7.95	0.79	16.9	30
1753.5	3	QPSK	1/0	9.69	H	7.95	0.79	16.85	30
1711.5	3	16-QAM	1/0	9.84	V	7.95	0.79	17	30
1732.5	3	16-QAM	1/0	9.89	V	7.95	0.79	17.05	30
1753.5	3	16-QAM	1/0	9.77	V	7.95	0.79	16.93	30
1711.5	3	16-QAM	1/0	9.68	H	7.95	0.79	16.84	30
1732.5	3	16-QAM	1/0	9.73	H	7.95	0.79	16.89	30
1753.5	3	16-QAM	1/0	9.79	H	7.95	0.79	16.95	30
1712.5	5	QPSK	1/0	9.65	V	7.95	0.79	16.81	30
1732.5	5	QPSK	1/0	9.59	V	7.95	0.79	16.75	30
1752.5	5	QPSK	1/24	9.75	V	7.95	0.79	16.91	30
1712.5	5	QPSK	1/0	9.69	H	7.95	0.79	16.85	30
1732.5	5	QPSK	1/0	9.81	H	7.95	0.79	16.97	30
1752.5	5	QPSK	1/24	9.62	H	7.95	0.79	16.78	30
1712.5	5	16-QAM	1/0	9.89	V	7.95	0.79	17.05	30
1732.5	5	16-QAM	1/0	9.75	V	7.95	0.79	16.91	30
1752.5	5	16-QAM	1/24	9.82	V	7.95	0.79	16.98	30
1712.5	5	16-QAM	1/0	9.78	H	7.95	0.79	16.94	30

1732.5	5	16-QAM	1/0	9.68	H	7.95	0.79	16.84	30
1752.5	5	16-QAM	1/24	9.77	H	7.95	0.79	16.93	30
1715	10	QPSK	1/0	9.78	V	7.95	0.79	16.94	30
1732.5	10	QPSK	1/49	9.89	V	7.95	0.79	17.05	30
1750	10	QPSK	1/0	9.62	V	7.95	0.79	16.78	30
1715	10	QPSK	1/0	9.77	H	7.95	0.79	16.93	30
1732.5	10	QPSK	1/49	9.68	H	7.95	0.79	16.84	30
1750	10	QPSK	1/0	9.76	H	7.95	0.79	16.92	30
1715	10	16-QAM	1/0	9.68	V	7.95	0.79	16.84	30
1732.5	10	16-QAM	1/49	9.74	V	7.95	0.79	16.9	30
1750	10	16-QAM	1/0	9.65	V	7.95	0.79	16.81	30
1715	10	16-QAM	1/0	9.78	H	7.95	0.79	16.94	30
1732.5	10	16-QAM	1/49	9.67	H	7.95	0.79	16.83	30
1750	10	16-QAM	1/0	9.69	H	7.95	0.79	16.85	30
1717.5	15	QPSK	1/0	9.74	V	7.95	0.79	16.9	30
1732.5	15	QPSK	1/74	9.59	V	7.95	0.79	16.75	30
1747.5	15	QPSK	1/0	9.62	V	7.95	0.79	16.78	30
1717.5	15	QPSK	1/0	9.64	H	7.95	0.79	16.8	30
1732.5	15	QPSK	1/74	9.58	H	7.95	0.79	16.74	30
1747.5	15	QPSK	1/0	9.66	H	7.95	0.79	16.82	30
1717.5	15	16-QAM	1/0	9.71	V	7.95	0.79	16.87	30
1732.5	15	16-QAM	1/74	9.68	V	7.95	0.79	16.84	30
1747.5	15	16-QAM	1/0	9.55	V	7.95	0.79	16.71	30
1717.5	15	16-QAM	1/0	9.49	H	7.95	0.79	16.65	30
1732.5	15	16-QAM	1/74	9.61	H	7.95	0.79	16.77	30
1747.5	15	16-QAM	1/0	9.74	H	7.95	0.79	16.9	30
1720	20	QPSK	1/99	9.52	V	7.95	0.79	16.68	30
1732.5	20	QPSK	1/99	9.64	V	7.95	0.79	16.8	30
1745	20	QPSK	1/0	9.71	V	7.95	0.79	16.87	30
1720	20	QPSK	1/99	9.65	H	7.95	0.79	16.81	30
1732.5	20	QPSK	1/99	9.64	H	7.95	0.79	16.8	30
1745	20	QPSK	1/0	9.67	H	7.95	0.79	16.83	30
1720	20	16-QAM	1/99	9.59	V	7.95	0.79	16.75	30
1732.5	20	16-QAM	1/99	9.71	V	7.95	0.79	16.87	30
1745	20	16-QAM	1/0	9.63	V	7.95	0.79	16.79	30
1720	20	16-QAM	1/99	9.79	H	7.95	0.79	16.95	30
1732.5	20	16-QAM	1/99	9.64	H	7.95	0.79	16.8	30
1745	20	16-QAM	1/0	9.73	H	7.95	0.79	16.89	30

6.3 Peak-Average Ratio

Temperature	19°C
Relative Humidity	58%
Atmospheric Pressure	1008mbar
Test date :	February 04, 2015
Tested By :	Dustin Wang

Requirement(s):

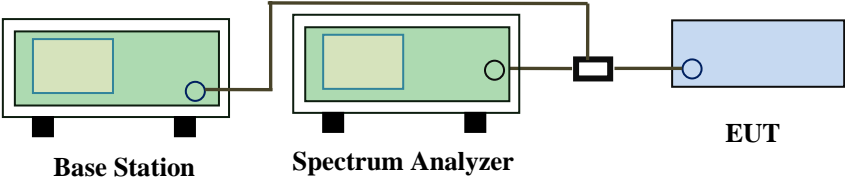
Spec	Item	Requirement	Applicable
§ 27.50(d)	a)	The peak-to-average ratio (PAR) of the transmission may not exceed 13 dB.	<input checked="" type="checkbox"/>
Test Setup	 <p style="text-align: center;"> Base Station Spectrum Analyzer EUT </p>		
Test Procedure	<p>According with KDB 971168</p> <ol style="list-style-type: none"> 1. The signal analyzer' s CCDF measurement profile is enabled 2. Frequency = carrier center frequency 3. Measurement BW > Emission bandwidth of signal 4. The signal analyzer was set to collect one million samples to generate the CCDF curve 5. The measurement interval was set depending on the type of signal analyzed. For continuous signals (>98% duty cycle), the measurement interval was set to 1ms. For burst transmissions, the spectrum analyzer is set to use an internal “ RF Burst” trigger that is synced with an incoming pulse and the measurement interval is set to less than the duration of the “ on time” of one burst to ensure that energy is only captured during a time in which the transmitter is operating at maximum power 		
Remark			
Result	<input checked="" type="checkbox"/> Pass <input type="checkbox"/> Fail		

Test Data Yes N/A
 Test Plot Yes (See below) N/A

LTE Band 4 (part 27)

BW(MHz)	Frequency (MHz)	Mode	Modulation	Conducted Power (dBm)		Peak-Average Ratio (PAR)
				Peak	Average	
1.4	1732.5	RB 1/0	QPSK	24.15	21.23	2.92
			16QAM	23.87	20.91	2.96
3	1732.5	RB 1/0	QPSK	24.12	21.29	2.83
			16QAM	23.92	20.62	3.3
5	1732.5	RB 1/0	QPSK	24.25	21.43	2.82
			16QAM	23.69	20.73	2.96
10	1732.5	RB 1/0	QPSK	24.19	21.35	2.84
			16QAM	24.12	20.63	3.49
15	1732.5	RB 1/0	QPSK	24.09	21.22	2.87
			16QAM	23.94	20.95	2.99
20	1732.5	RB 1/0	QPSK	24.25	21.42	2.83
			16QAM	24.04	21.01	3.03

Test Report	14070594-FCC-R
Page	23 of 56

6.4 Modulation Characteristic

According to FCC § 2.1047(d), Part 27 there is no specific requirement for digital modulation, therefore modulation characteristic is not presented.

6.5 Occupied Bandwidth

Temperature	19°C
Relative Humidity	58%
Atmospheric Pressure	1008mbar
Test date :	February 04, 2015
Tested By :	Dustin Wang

Requirement(s):

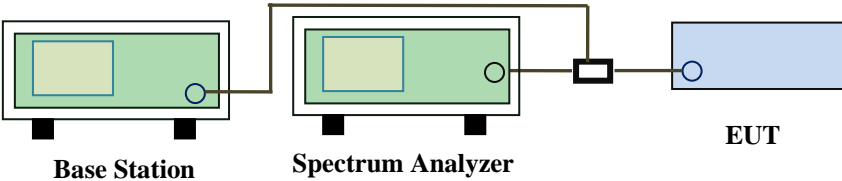
Spec	Item	Requirement	Applicable
§2.1049, §27.53(a)	a)	99% Occupied Bandwidth(kHz)	<input checked="" type="checkbox"/>
	b)	26 dB Bandwidth(kHz)	<input checked="" type="checkbox"/>
Test Setup	 <p style="text-align: center;">Base Station Spectrum Analyzer EUT</p>		
Test Procedure	<ul style="list-style-type: none"> - The EUT was connected to Spectrum Analyzer and Base Station via power divider. - The 99% and 26 dB occupied bandwidth (BW) of the middle channel for the highest RF powers. 		
Remark			
Result	<input checked="" type="checkbox"/> Pass <input type="checkbox"/> Fail		

Test Data Yes N/A

Test Plot Yes (See below) N/A

LTE Band 4 (Part 27) result

BW(MHz)	Channel	Frequency (MHz)	Modulation	99% Occupied Bandwidth (MHz)	26 dB Bandwidth (MHz)
1.4	19957	1710.7	QPSK	1.1069	1.27
			16QAM	1.0943	1.273
1.4	20175	1732.5	QPSK	1.1027	1.298
			16QAM	1.101	1.431
1.4	20393	1754.3	QPSK	1.0999	1.27
			16QAM	1.0987	1.268
3	19965	1711.5	QPSK	2.746	3.085
			16QAM	2.7539	3.092
3	20175	1732.5	QPSK	2.758	3.101
			16QAM	2.7518	3.666
3	20385	1753.5	QPSK	2.7549	3.095
			16QAM	2.7449	3.083
5	19975	1712.5	QPSK	4.5291	5.077
			16QAM	4.5154	5.086
5	20175	1732.5	QPSK	4.5151	5.092
			16QAM	4.5195	4.996
5	20375	1752.5	QPSK	4.5128	5.009
			16QAM	4.499	5.009
10	20000	1715	QPSK	9.0493	10.037
			16QAM	9.0717	10.114
10	20175	1732.5	QPSK	9.0639	10.233
			16QAM	9.0839	11.681
10	20350	1750	QPSK	9.092	10.187
			16QAM	9.0663	10.115
15	20025	1717.5	QPSK	13.4467	14.723
			16QAM	13.4386	14.728
15	20175	1732.5	QPSK	13.4871	14.836
			16QAM	13.551	15.252
15	20325	1747.5	QPSK	13.4985	14.743
			16QAM	13.4936	14.937

20	20050	1720	QPSK	17.8479	19.488
			16QAM	17.8473	19.153
20	20175	1732.5	QPSK	17.9125	19.504
			16QAM	17.9599	19.223
20	20300	1745	QPSK	17.8891	19.204
			16QAM	17.8996	19.247

Test Plots

LTE Band 4 (Part 27)

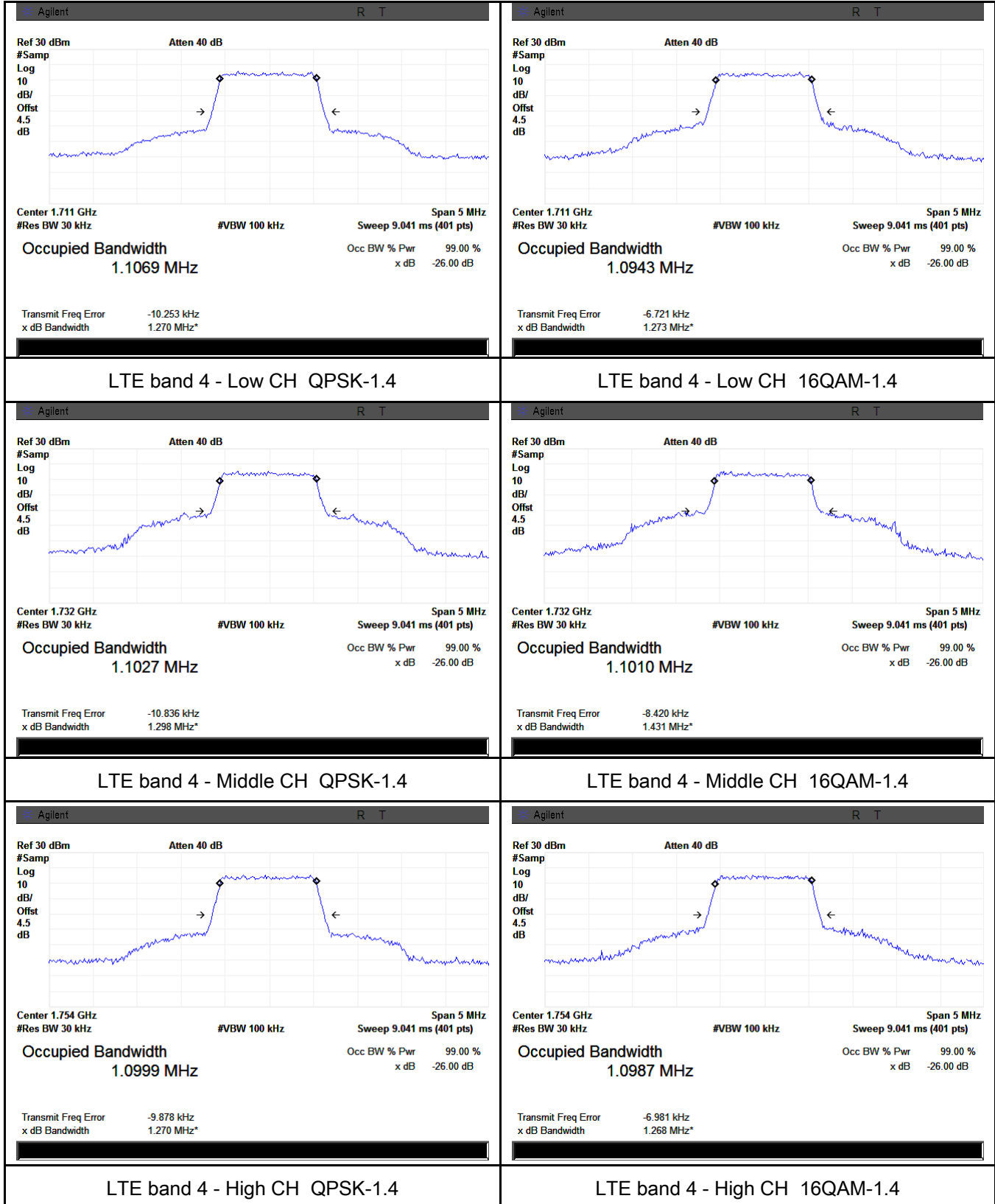

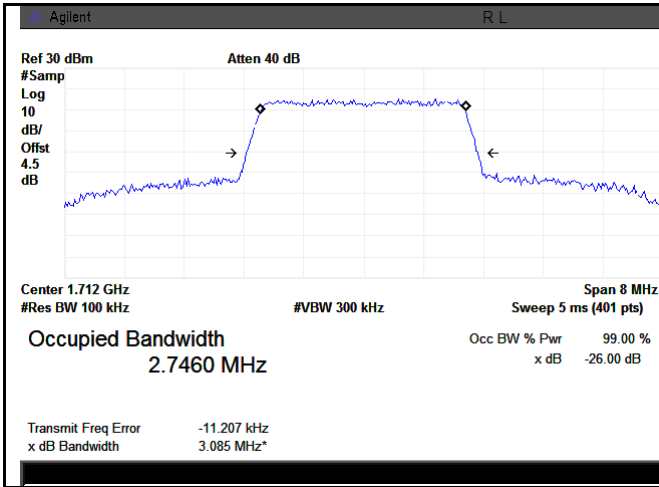

LTE band 4 - Low CH QPSK-3

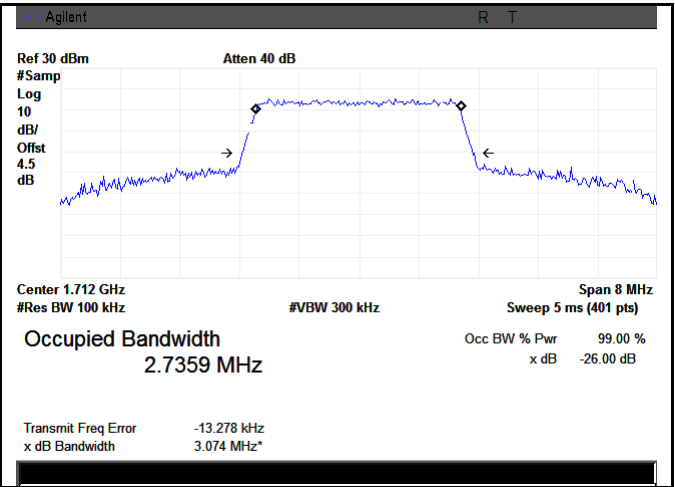

LTE band 4 - Low CH 16QAM-3

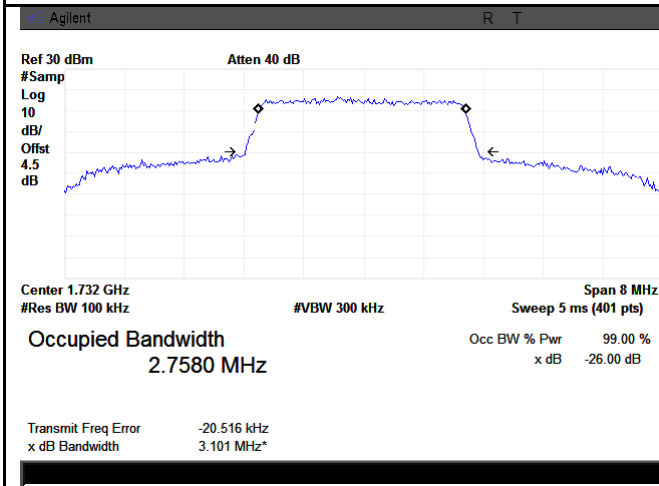

LTE band 4 - Middle CH QPSK-3

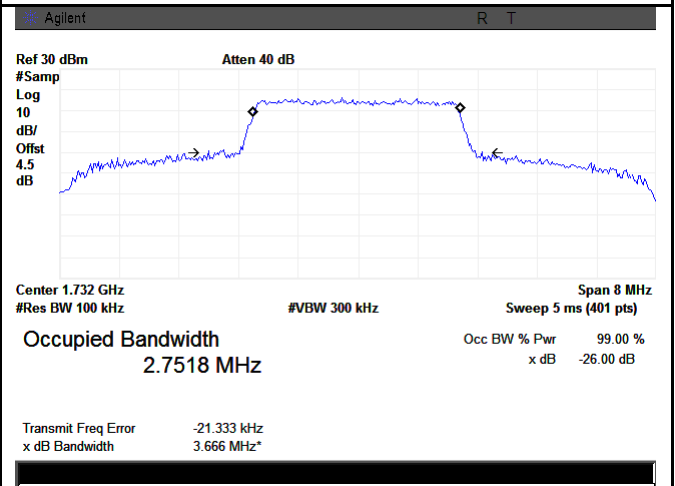

LTE band 4 - Middle CH 16QAM-3

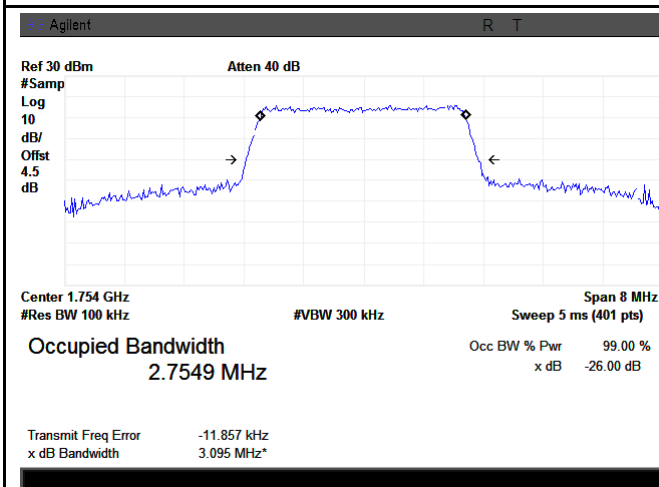

LTE band 4 - High CH QPSK-3

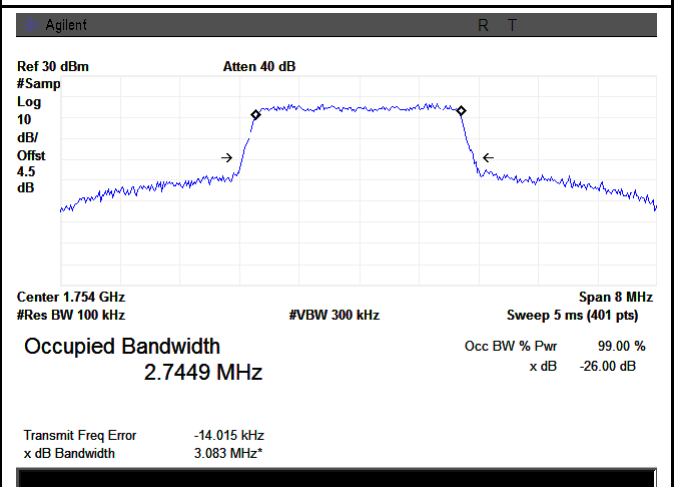

LTE band 4 - High CH 16QAM-3

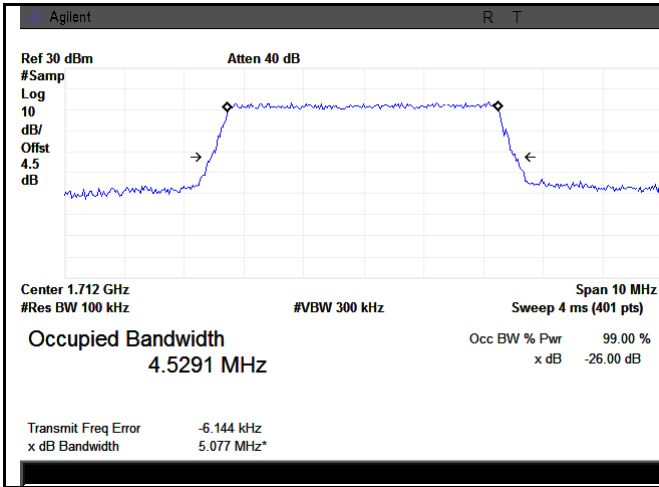

LTE band 4 - Low CH QPSK-5

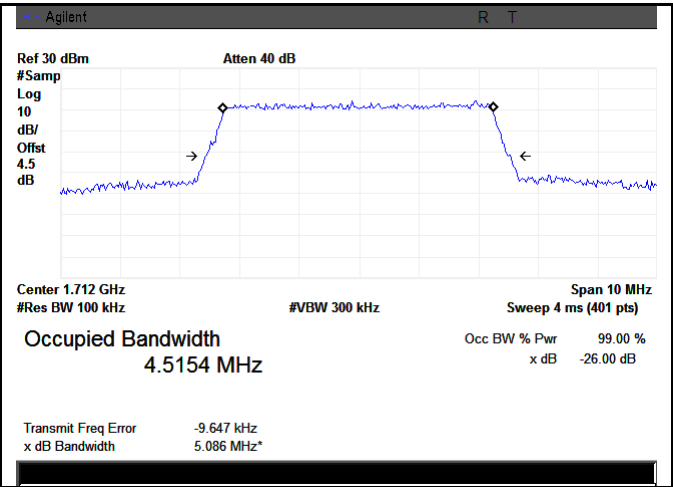

LTE band 4 - Low CH 16QAM-5

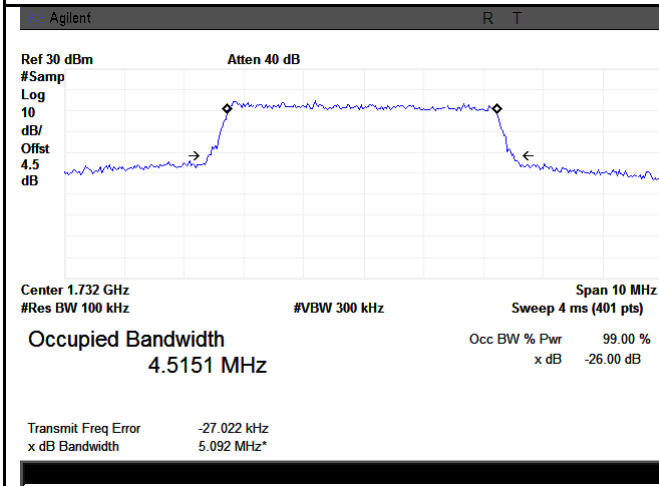

LTE band 4 - Middle CH QPSK-5

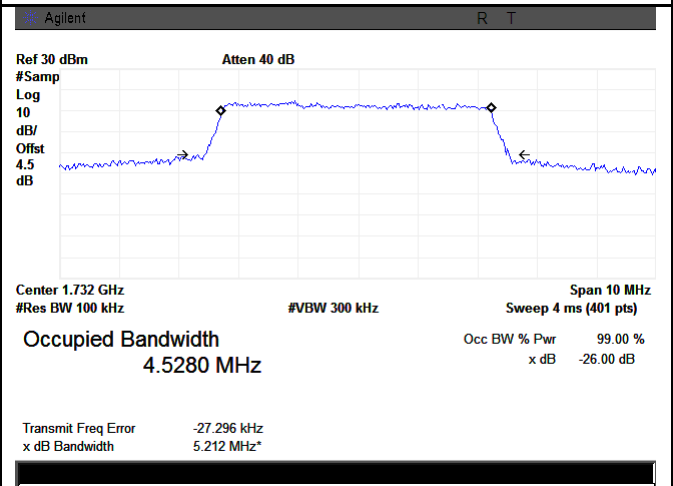

LTE band 4 - Middle CH 16QAM-5

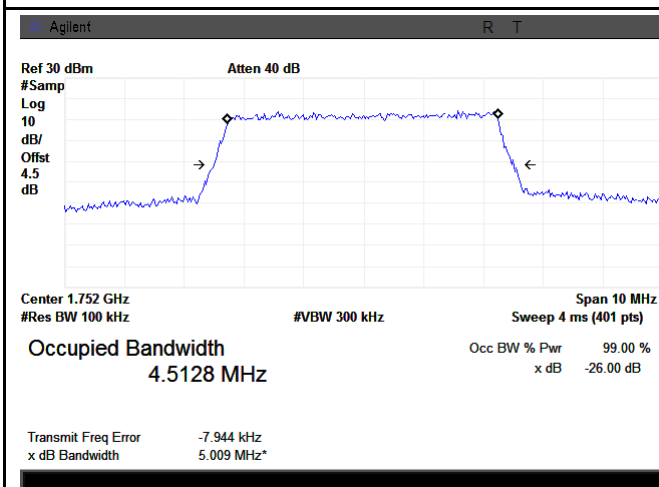

LTE band 4 - High CH QPSK-5

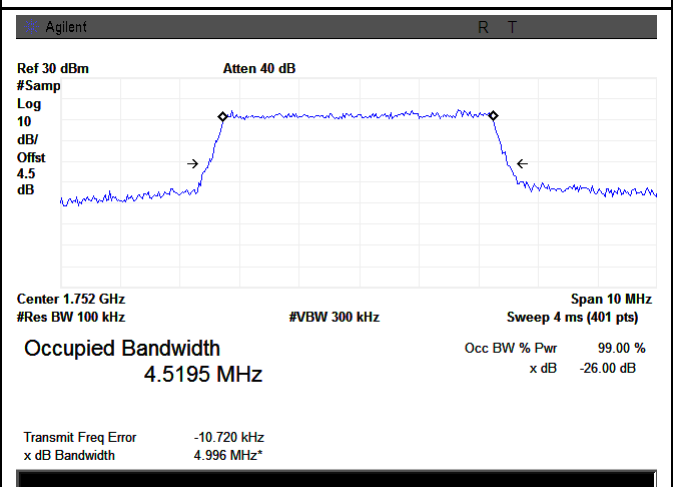

LTE band 4 - High CH 16QAM-5

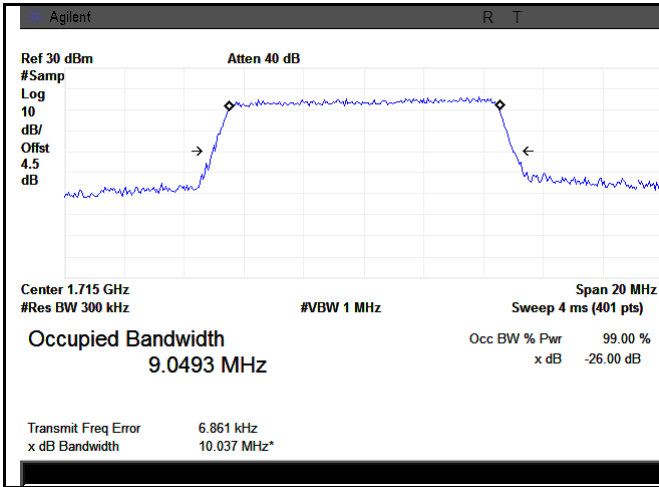

LTE band 4 - Low CH QPSK-10

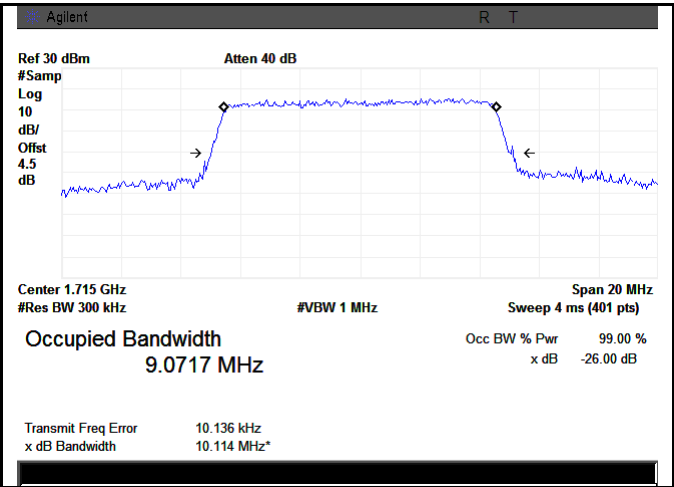

LTE band 4 - Low CH 16QAM-10

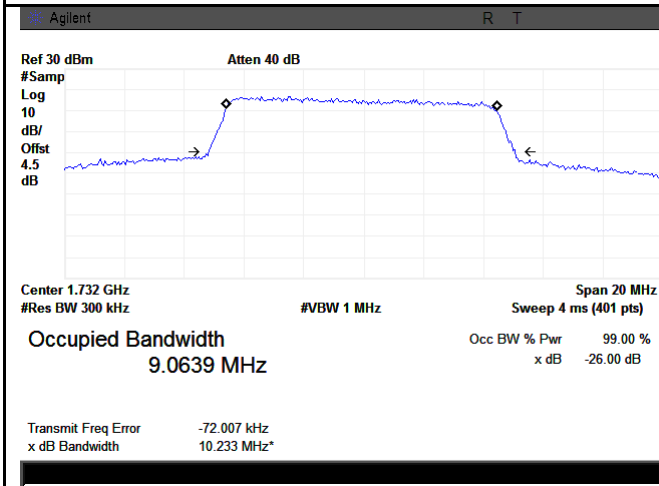

LTE band 4 - Middle CH QPSK-10

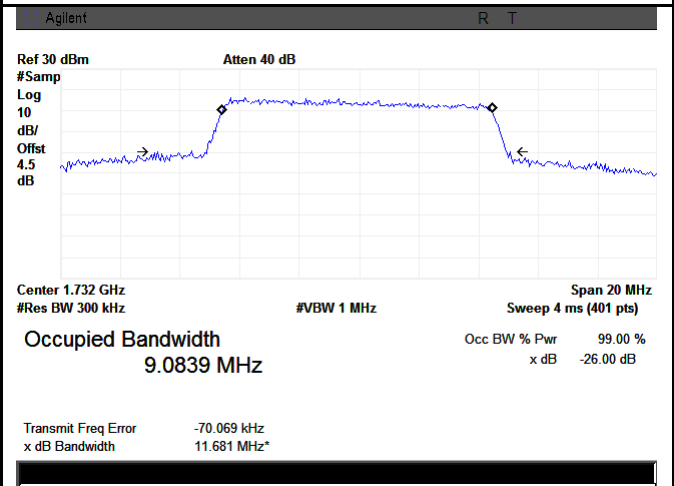

LTE band 4 - Middle CH 16QAM-10

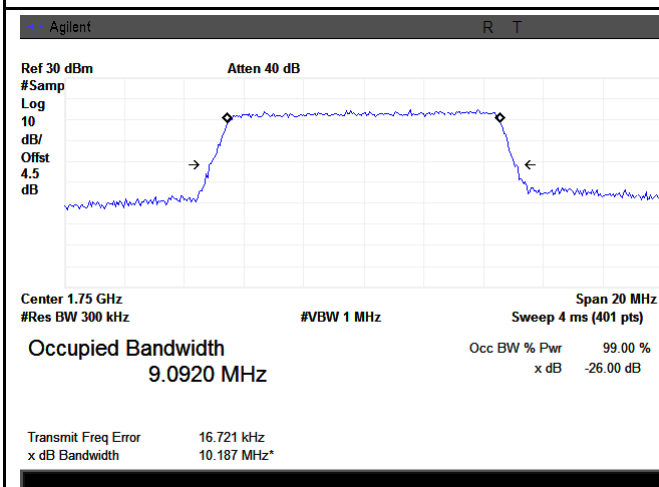

LTE band 4 - High CH QPSK-10

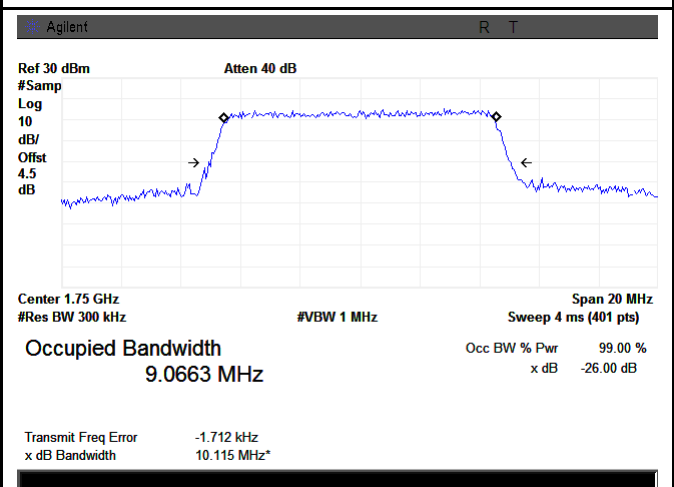

LTE band 4 - High CH 16QAM-10

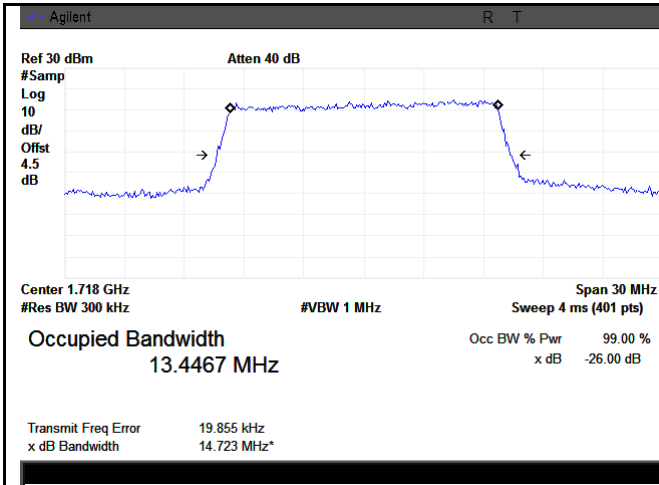

LTE band 4 - Low CH QPSK-15

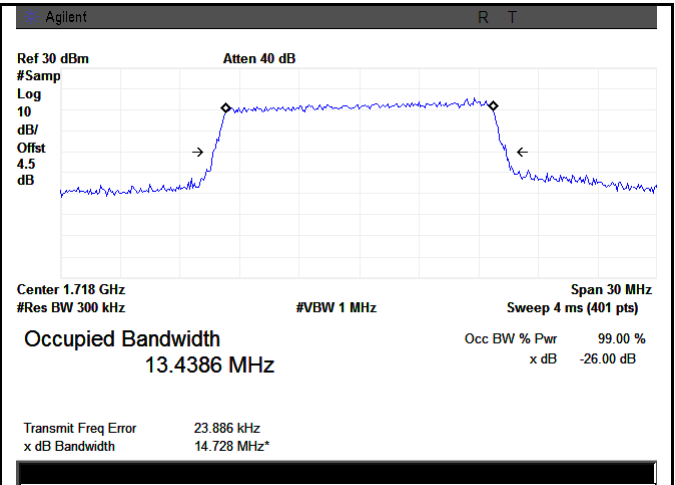

LTE band 4 - Low CH 16QAM-15

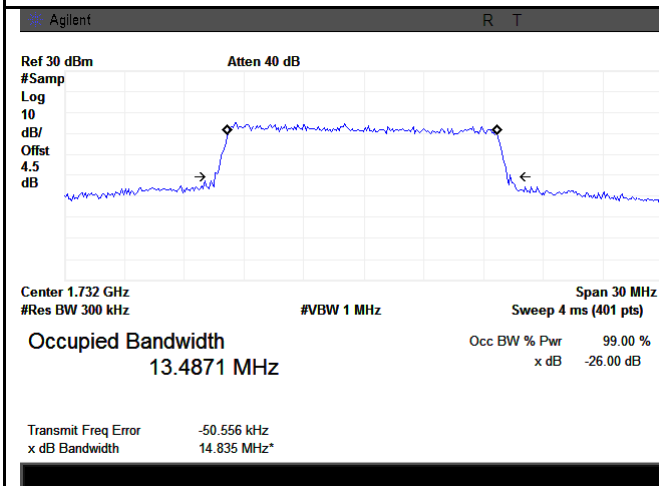

LTE band 4 - Middle CH QPSK-15

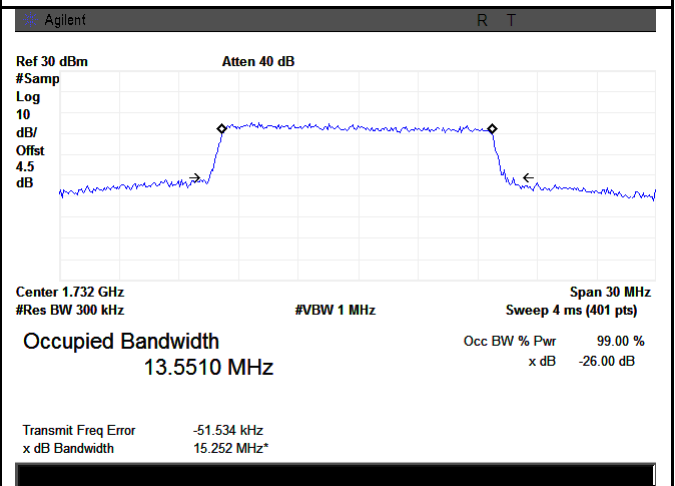

LTE band 4 - Middle CH 16QAM-15

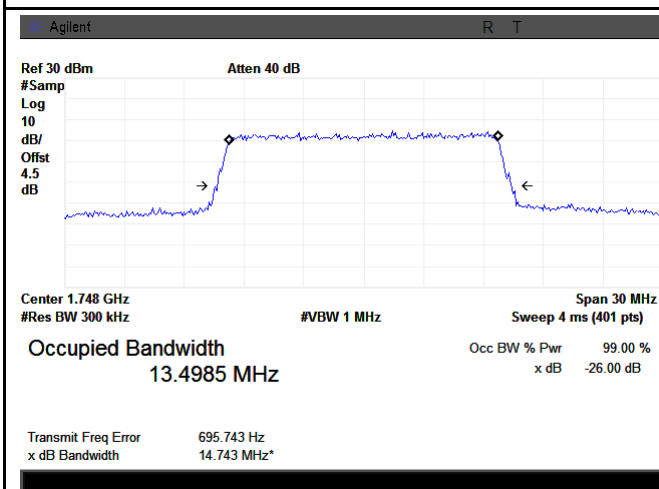

LTE band 4 - High CH QPSK-15

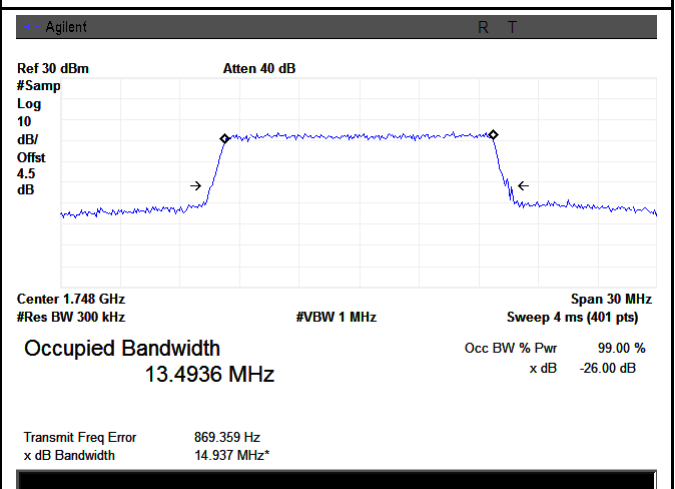

LTE band 4 - High CH 16QAM-15

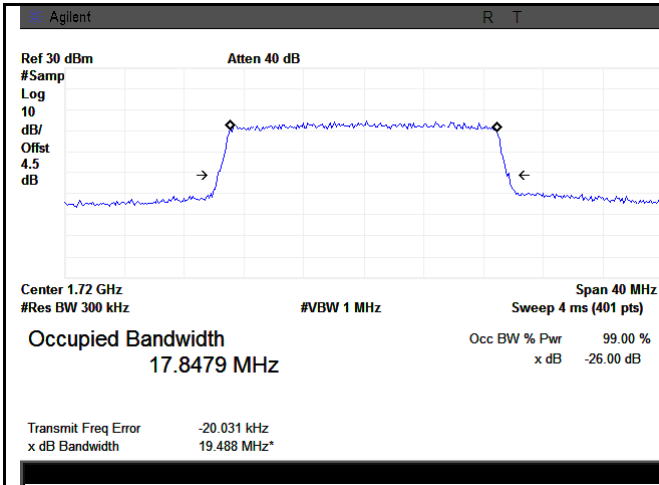

LTE band 4 - Low CH QPSK-20

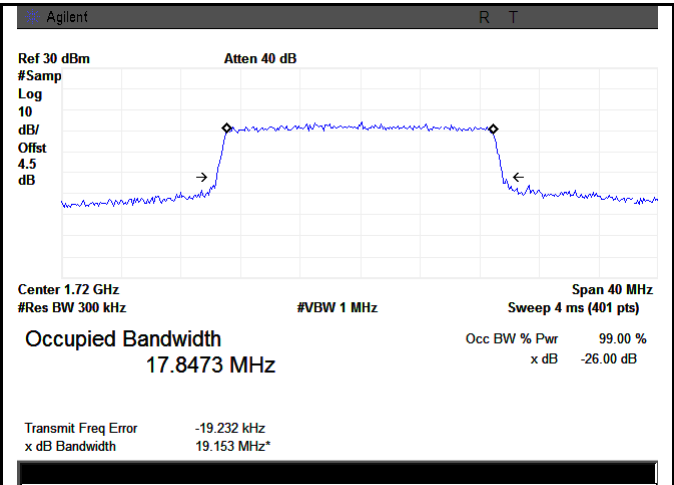

LTE band 4 - Low CH 16QAM-20

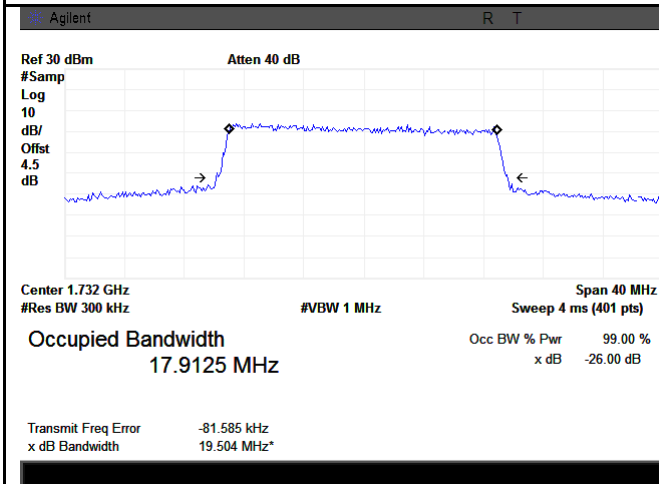

LTE band 4 - Middle CH QPSK-20

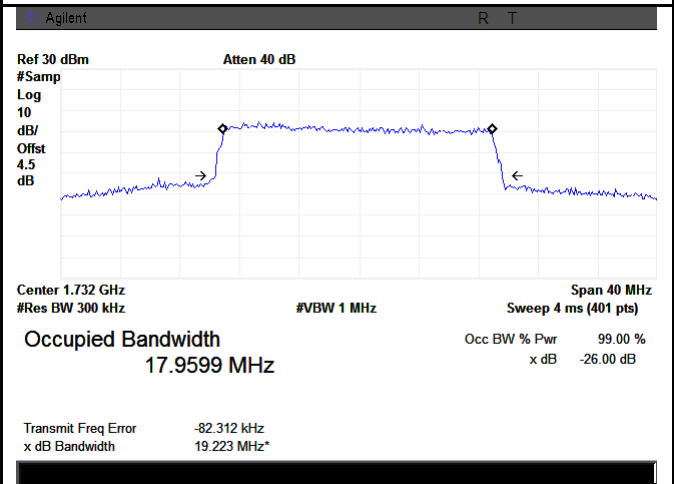

LTE band 4 - Middle CH 16QAM-20

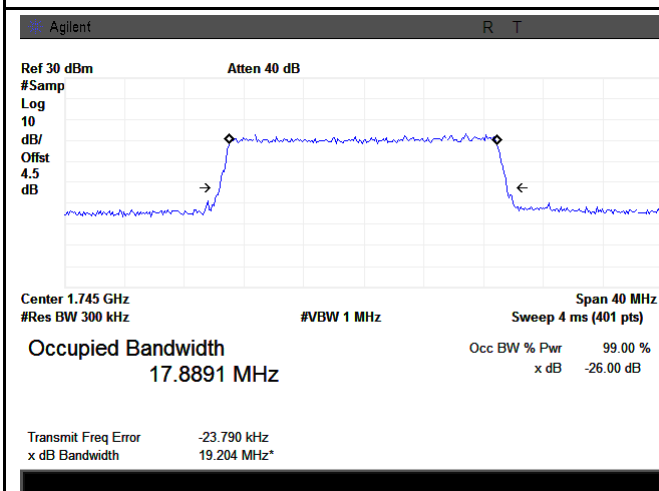

LTE band 4 - High CH QPSK-20

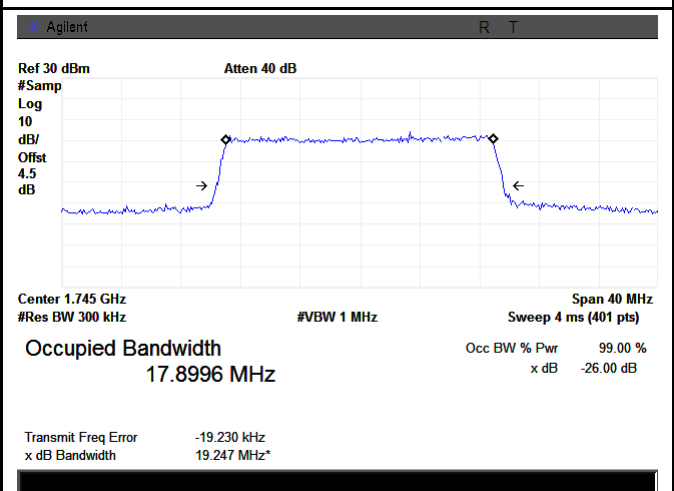

LTE band 4 - High CH 16QAM-20

6.6 Spurious Emissions at Antenna Terminals

Temperature	18°C
Relative Humidity	59%
Atmospheric Pressure	1011mbar
Test date :	February 05, 2015
Tested By :	Dustin Wang

Requirement(s):

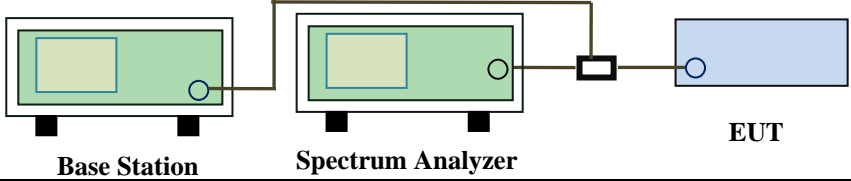
Spec	Item	Requirement	Applicable
§2.1051, § 27.53(h)	a)	The power of any emission outside of the authorized operating frequency ranges must be lower than the transmitter power (P) by a factor of at least $43 + 10 \log (P)$ dB	<input checked="" type="checkbox"/>
Test Setup	 <p>The diagram shows a Base Station (green box) connected to a Spectrum Analyzer (green box) and an EUT (blue box) through a power divider (black box). The Base Station and Spectrum Analyzer are connected to the power divider, which then splits the signal to the EUT.</p>		
Test Procedure	<ul style="list-style-type: none"> - The EUT was connected to Spectrum Analyzer and Base Station via power divider. - The Band Edges of low and high channels for the highest RF powers were measured. - Setting RBW as roughly BW/100. 		
Remark			
Result	<input checked="" type="checkbox"/> Pass <input type="checkbox"/> Fail		

Test Data Yes N/A
 Test Plot Yes (See below) N/A

Test Plots 30MHz-5GHz
LTE Band 4 (Part27) result

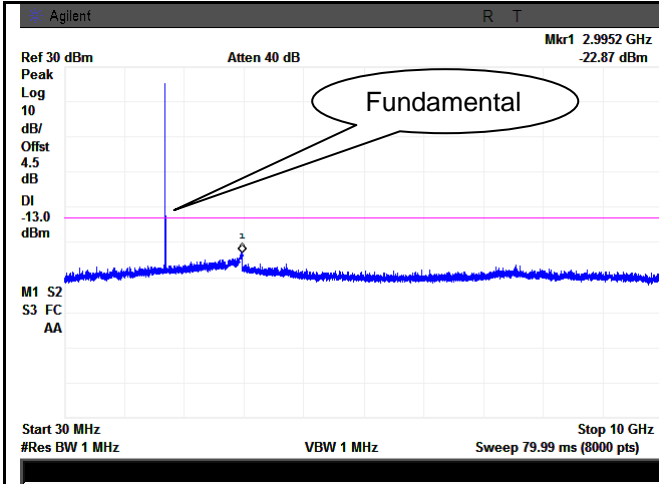

LTE Band 4 - Low Channel-1

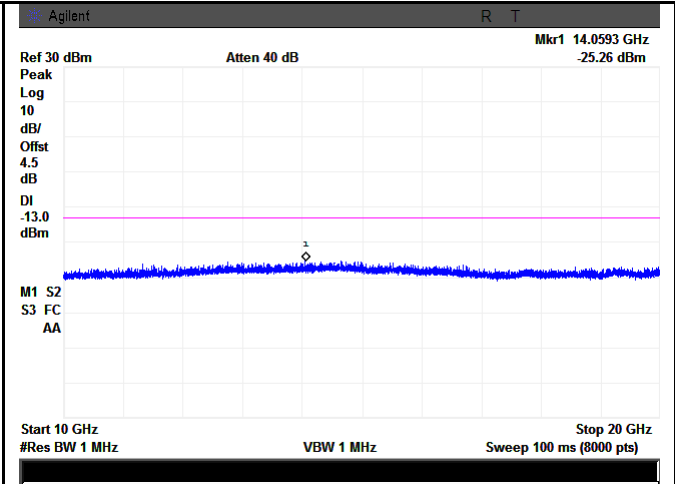

LTE Band 4 - Low Channel-2

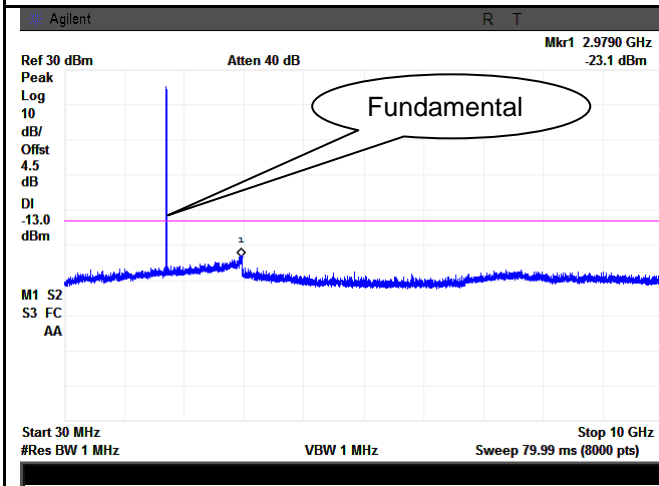

LTE Band 4 - Middle Channel-1

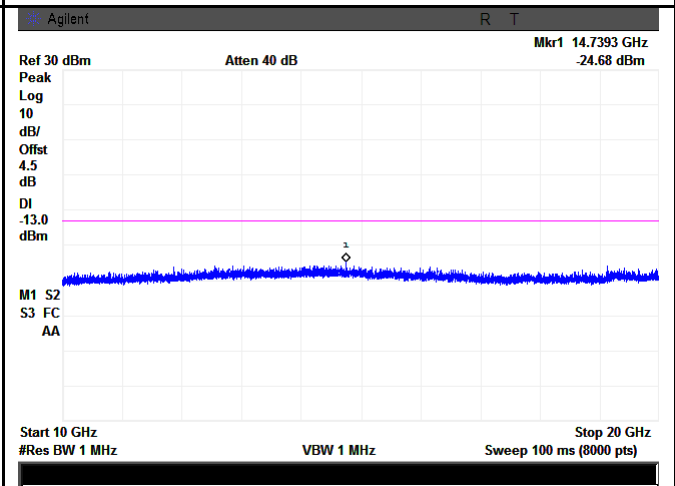

LTE Band 4 - Middle Channel-2

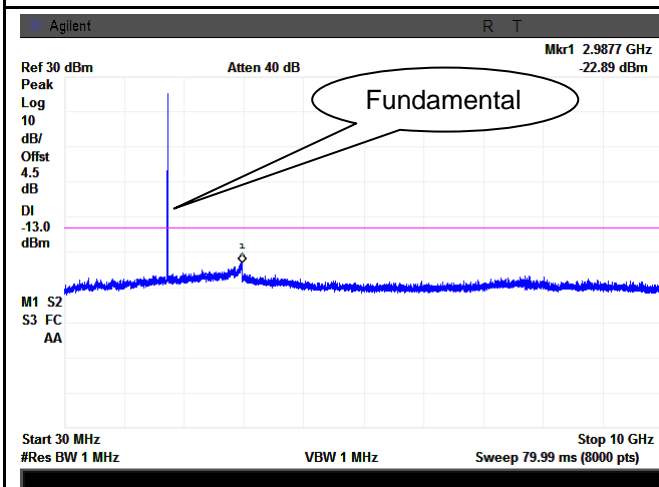

LTE Band 4 - High Channel-1

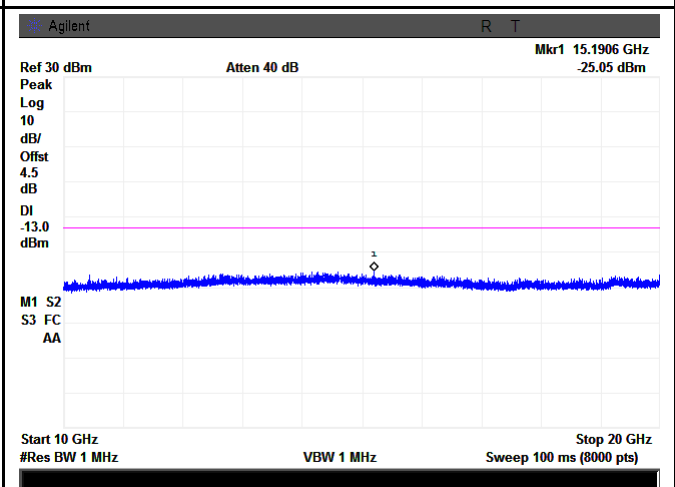

LTE Band 4 - High Channel-2

6.7 Spurious Radiated Emissions

Temperature	18°C
Relative Humidity	59%
Atmospheric Pressure	1011mbar
Test date :	February 05, 2015
Tested By :	Dustin Wang

Requirement(s):

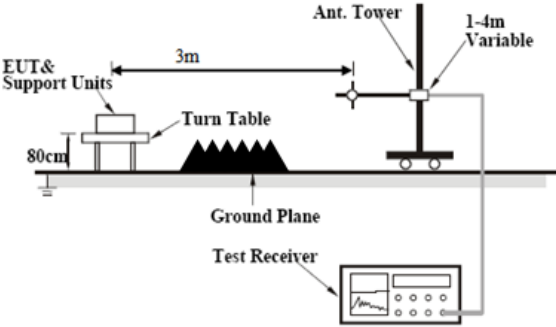
Spec	Item	Requirement	Applicable
§2.1053, § 27.53(h)	a)	The power of any emission outside of the authorized operating frequency ranges must be attenuated below the transmitter power (P) by a factor of at least $43 + 10 \log (P)$ dB. The spectrum is scanned from 30 MHz up to a frequency including its 10th harmonic.	<input checked="" type="checkbox"/>
Test setup			
Test Procedure	<ol style="list-style-type: none"> The transmitter was placed on a wooden turntable, and it was transmitting into a non-radiating load which was also placed on the turntable. The measurement antenna was placed at a distance of 3 meters from the EUT. During the tests, the antenna height and polarization as well as EUT azimuth were varied in order to identify the maximum level of emissions from the EUT. The test was performed by placing the EUT on 3-orthogonal axis. Remove the EUT and replace it with substitution antenna. A signal generator was connected to the substitution antenna by a non-radiating cable. The absolute levels of the spurious emissions were measured by the substitution. <p>Sample Calculation:</p> <p>EUT Field Strength = Raw Amplitude (dBμV/m) – Amplifier Gain (dB) + Antenna Factor (dB) + Cable Loss (dB) + Filter Attenuation (dB, if used)</p>		
Remark			

Result	<input checked="" type="checkbox"/> Pass	<input type="checkbox"/> Fail
--------	--	-------------------------------

Test Data Yes N/A

Test Plot Yes (See below) N/A

LTE Band 4(Part27) result

Low channel

Frequency (MHz)	Substituted level (dBm)	Polarity (H/V)	Antenna Gain Correction (dB)	Cable Loss (dB)	Corrected Reading (dBm)	Limit (dBm)	Margin (dB)
3440	-47.11	V	10.06	2.52	-39.57	-13	-26.57
3440	-48.05	H	10.06	2.52	-40.51	-13	-27.51
572.8	-57.64	V	6.5	0.36	-51.5	-13	-38.5
843.1	-50.52	H	6.8	0.44	-44.16	-13	-31.16

Middle channel

Frequency (MHz)	Substituted level (dBm)	Polarity (H/V)	Antenna Gain Correction (dB)	Cable Loss (dB)	Corrected Reading (dBm)	Limit (dBm)	Margin (dB)
3465	-48.44	V	10.09	2.52	-40.87	-13	-27.87
3465	-48.67	H	10.09	2.52	-41.1	-13	-28.1
570.6	-57.95	V	6.5	0.36	-51.81	-13	-38.81
843.5	-49.82	H	6.8	0.44	-43.46	-13	-30.46

High channel

Frequency (MHz)	Substituted level (dBm)	Polarity (H/V)	Antenna Gain Correction (dB)	Cable Loss (dB)	Corrected Reading (dBm)	Limit (dBm)	Margin (dB)
3490	-47.95	V	10.09	2.52	-40.38	-13	-27.38
3490	-48.34	H	10.09	2.52	-40.77	-13	-27.77
572.2	-58.04	V	6.5	0.36	-51.9	-13	-38.9
843.7	-50.33	H	6.8	0.44	-43.97	-13	-30.97

6.8 Band Edge

Temperature	18°C
Relative Humidity	59%
Atmospheric Pressure	1011mbar
Test date :	February 05, 2015
Tested By :	Dustin Wang

Requirement(s):

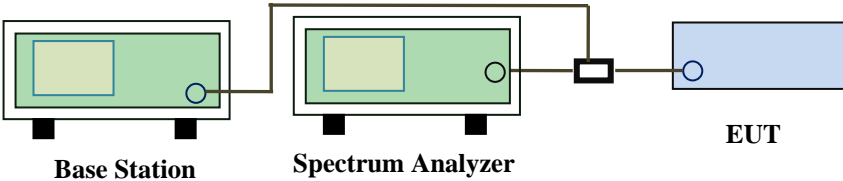
Spec	Item	Requirement	Applicable
§ 27.53(h)	a)	The power of any emission outside of the authorized operating frequency ranges must be lower than the transmitter power (P) by a factor of at least $43 + 10 \log (P)$ dB.	<input checked="" type="checkbox"/>
Test setup	 <p>The diagram shows a Base Station (green box) connected to a Spectrum Analyzer (green box) and an EUT (blue box) via a power divider (black box). The Base Station and Spectrum Analyzer are connected to each other, and the Spectrum Analyzer is connected to the power divider, which then splits the signal to the EUT.</p>		
Procedure	<ul style="list-style-type: none"> - The EUT was connected to Spectrum Analyzer and Base Station via power divider. - The Band Edges of low and high channels for the highest RF powers were measured. Setting RBW as roughly BW/100. 		
Remark			
Result	<input checked="" type="checkbox"/> Pass <input type="checkbox"/> Fail		

Test Data Yes N/A

Test Plot Yes (See below) N/A

LTE Band 4 (Part 27) result

BW(MHz)	Channel	Frequency (MHz)	Mode	Emission (dBm)	Limit (dBm)
1.4	19957	1710.7	QPSK	-18.85	-13
			16QAM	-18.26	-13
1.4	20393	1754.3	QPSK	-23.78	-13
			16QAM	-24.18	-13
3	19965	1711.5	QPSK	-16.32	-13
			16QAM	-16.89	-13
3	20385	1753.5	QPSK	-18.45	-13
			16QAM	-19.95	-13
5	19975	1712.5	QPSK	-17.93	-13
			16QAM	-15.09	-13
5	20375	1752.5	QPSK	-16.87	-13
			16QAM	-15.88	-13
10	20000	1715	QPSK	-16.29	-13
			16QAM	-18.22	-13
10	20350	1750	QPSK	-19.33	-13
			16QAM	-19.55	-13
15	20025	1717.5	QPSK	-14.85	-13
			16QAM	-16.06	-13
15	20325	1747.5	QPSK	-17.95	-13
			16QAM	-18.93	-13
20	20050	1720	QPSK	-19.62	-13
			16QAM	-19.33	-13
20	20300	1745	QPSK	-22.27	-13
			16QAM	-22.16	-13

Test Plots

LTE Band 4 (Part 27)

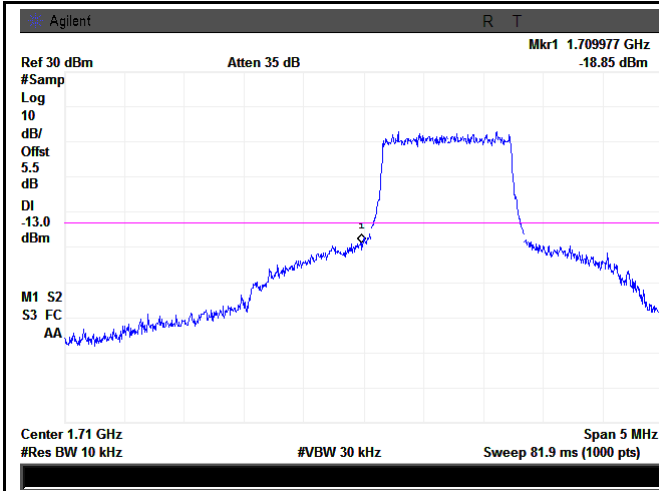

LTE Band 4 - Low Channel QPSK-1.4

Note: Offset=Cable loss (4.5) + 10log
(12.7/10)=4.5+1.1=5.5 dB

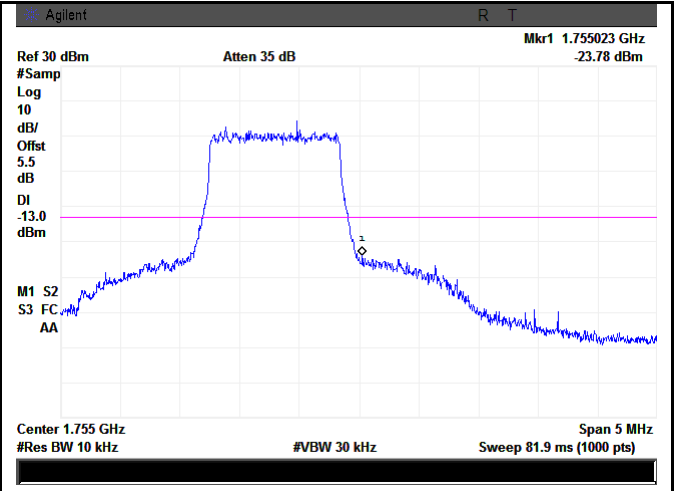

LTE Band 4 - High Channel QPSK-1.4

Note: Offset=Cable loss (4.5) + 10log
(12.7/10)=4.5+1.1=5.5 dB

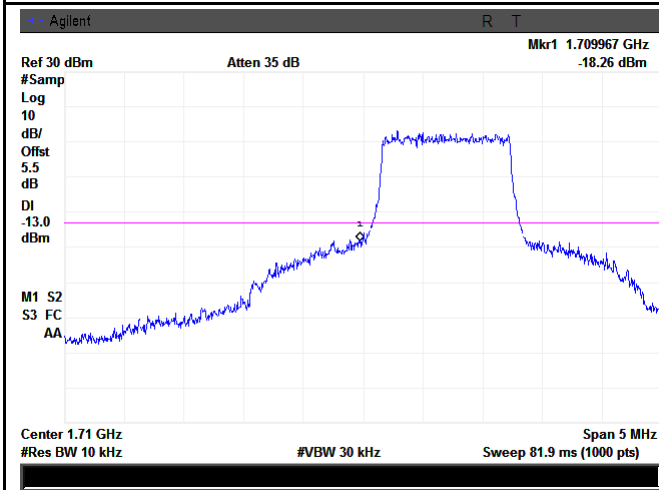

LTE Band 4 - Low Channel 16QAM-1.4

Note: Offset=Cable loss (4.5) + 10log
(12.73/10)=4.5+1.1=5.5 dB

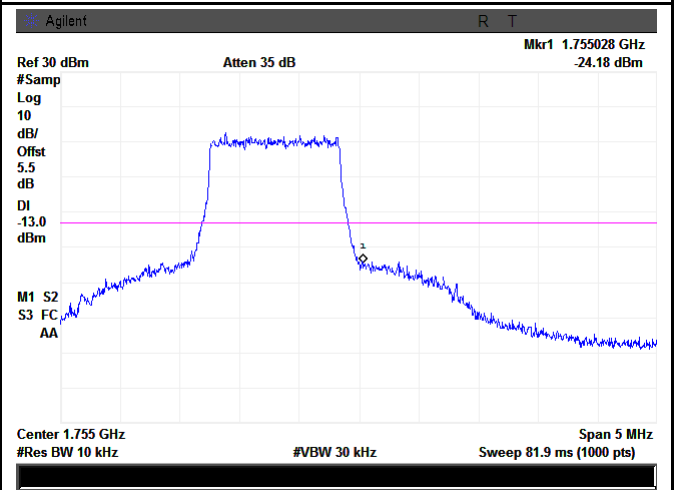

LTE Band 4 - High Channel 16QAM-1.4

Note: Offset=Cable loss (4.5) + 10log
(12.68/10)=4.5+1.1=5.5 dB

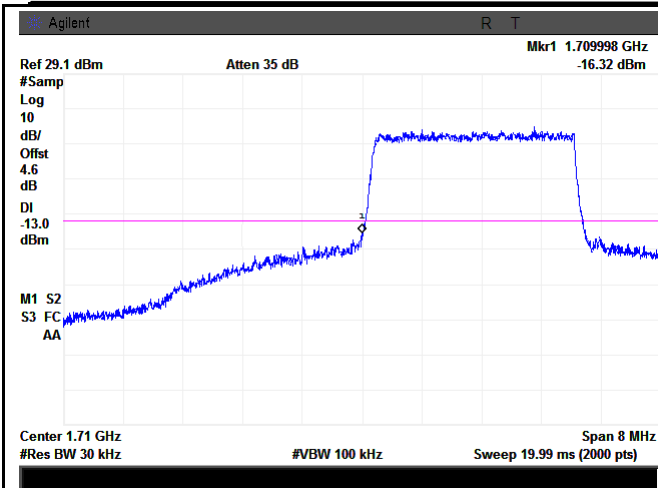

LTE Band 4 - Low Channel QPSK-3

Note: Offset=Cable loss (4.5) + 10log
(30.85/30)=4.5+0.1=4.6 dB

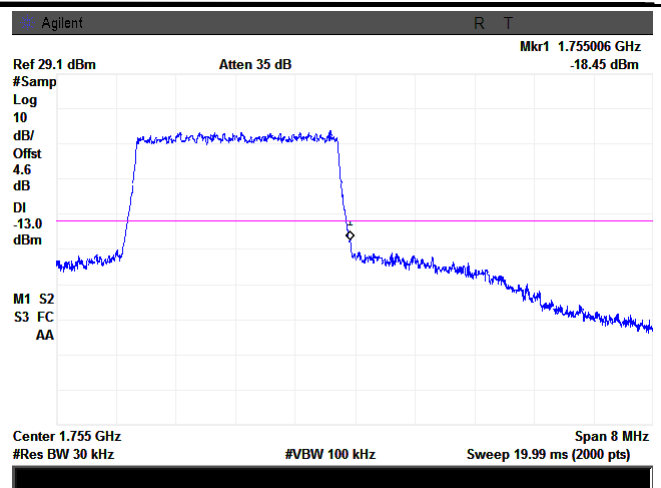

LTE Band 4 - High Channel QPSK-3

Note: Offset=Cable loss (4.5) + 10log
(30.95/30)=4.5+0.1=4.6 dB

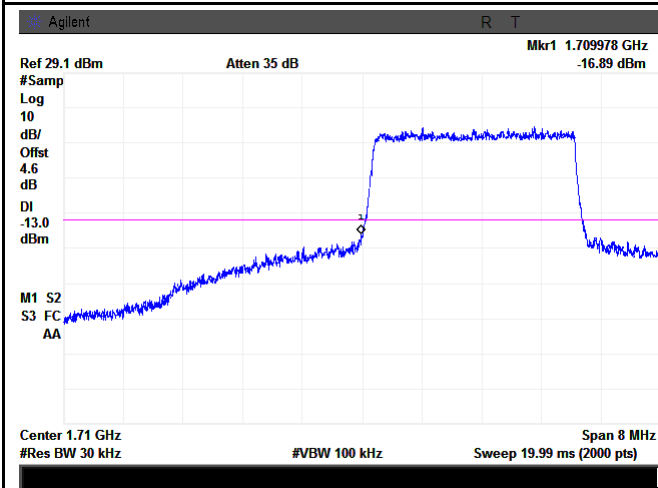

LTE Band 4 - Low Channel 16QAM-3

Note: Offset=Cable loss (4.5) + 10log
(30.92/30)=4.5+0.1=4.6 dB

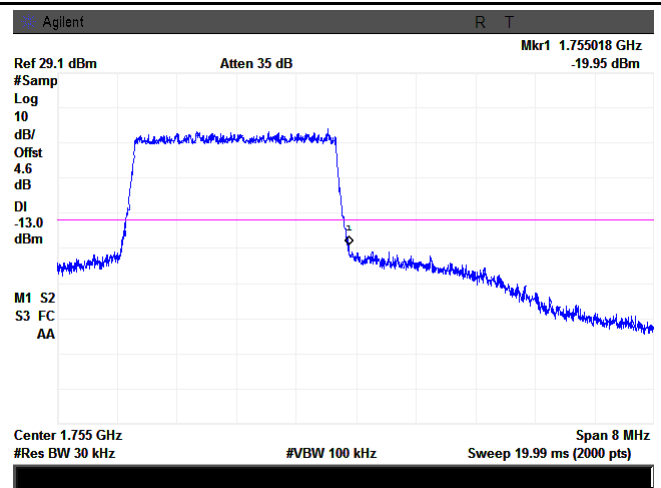

LTE Band 4 - High Channel 16QAM-3

Note: Offset=Cable loss (4.5) + 10log
(30.83/30)=4.5+0.1=4.6 dB

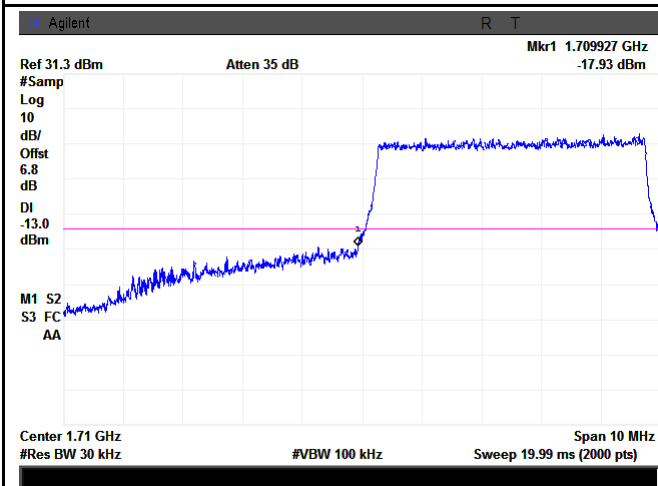

LTE Band 4 - Low Channel QPSK-5

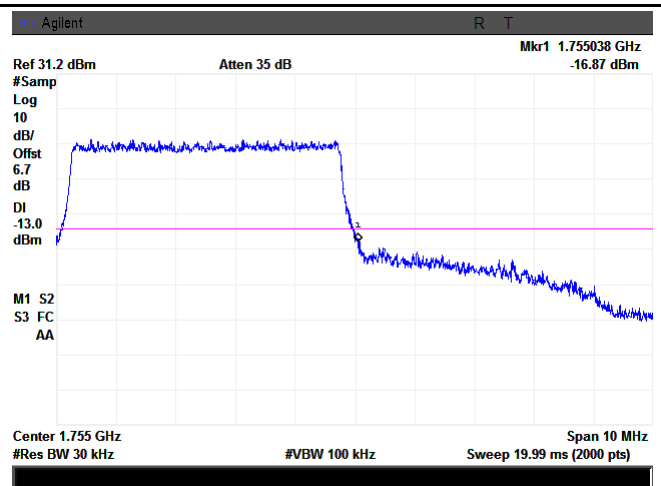

LTE Band 4 - High Channel QPSK-5

Note: Offset=Cable loss (4.5) + 10log
(50.77/30)=4.5+2.3=6.8 dB

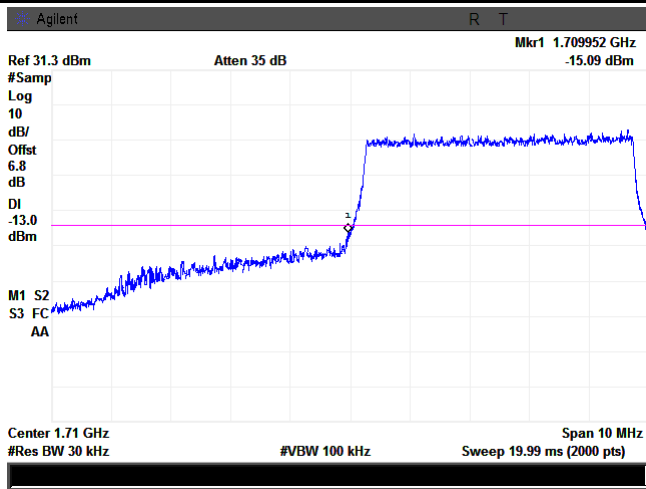

LTE Band 4 - Low Channel 16QAM-5

Note: Offset=Cable loss (4.5) + 10log
(50.09/30)=4.5+2.2=6.7 dB

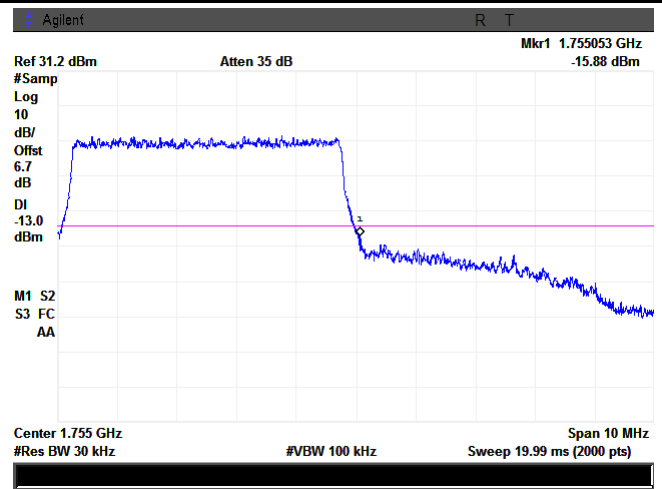

LTE Band 4 - High Channel 16QAM-5

Note: Offset=Cable loss (4.5) + 10log
(50.86/30)=4.5+2.3=6.8 dB

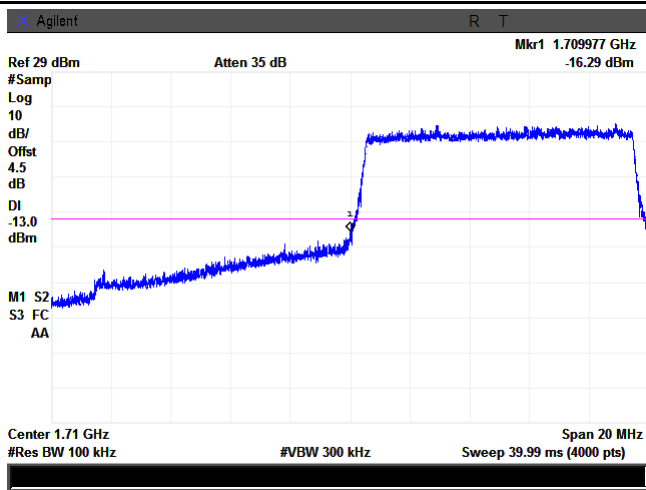

LTE Band 4 - Low Channel QPSK-10

Note: Offset=Cable loss (4.5) + 10log
(50.09/30)=4.5+2.2=6.7 dB

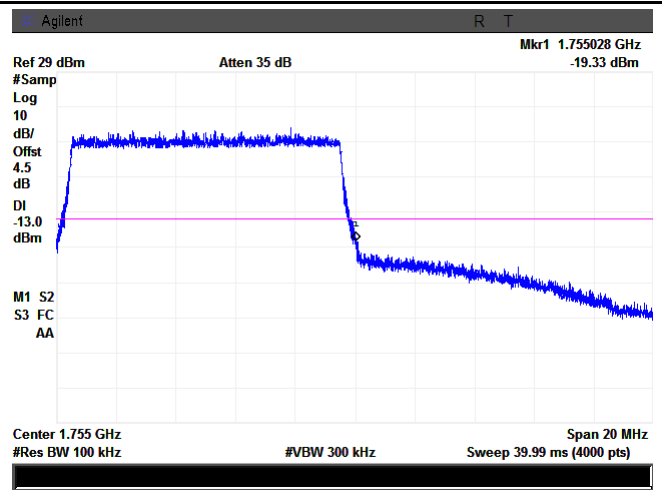

LTE Band 4 - High Channel QPSK-10

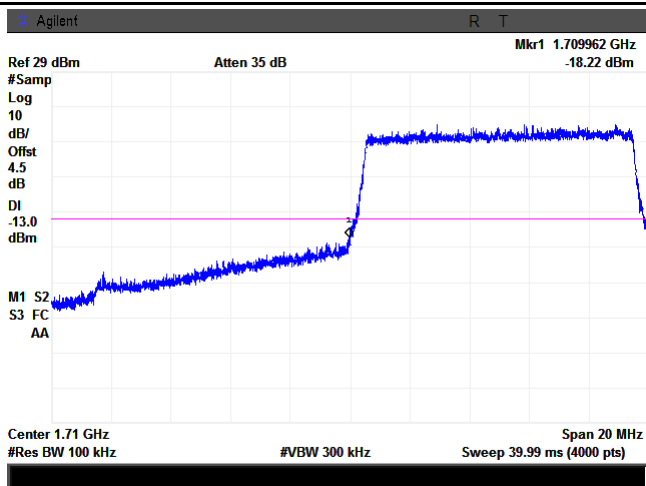

LTE Band 4 - Low Channel 16QAM-10

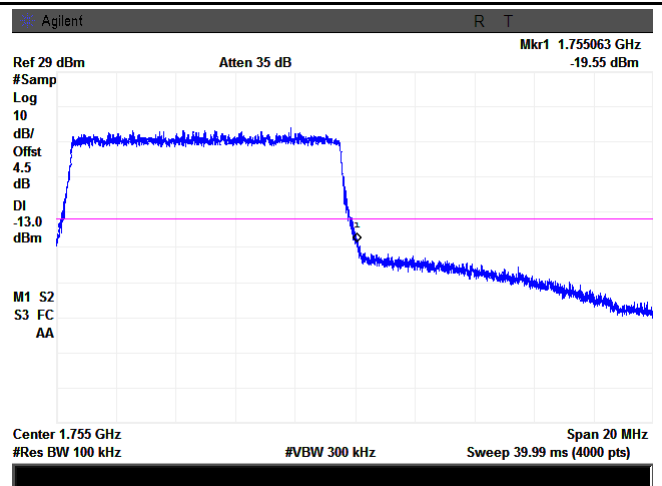

LTE Band 4 - High Channel 16QAM-10

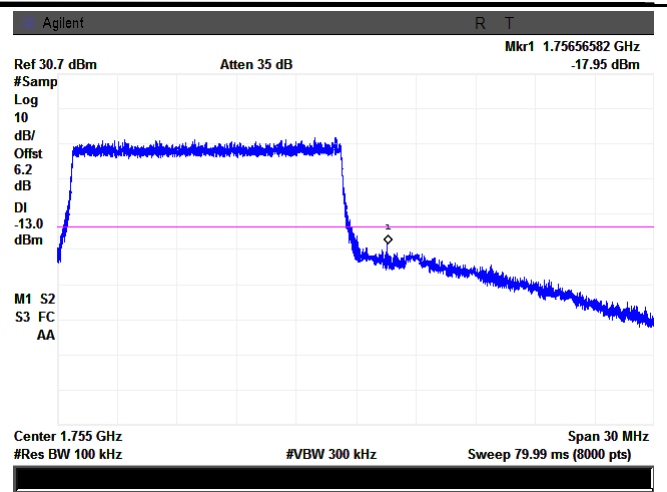
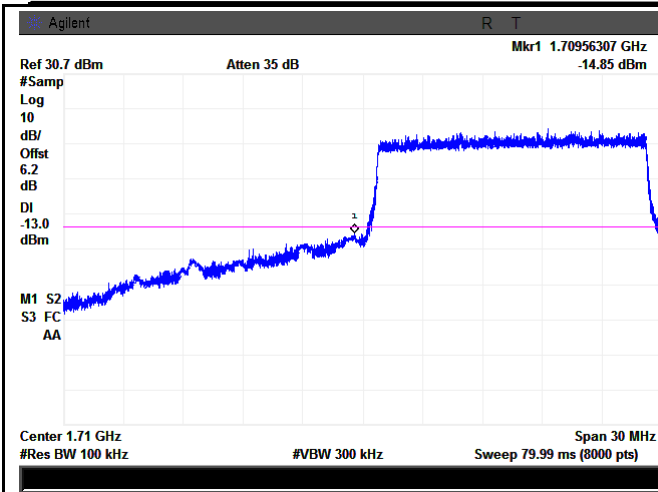

LTE Band 4 - Low Channel QPSK-15

LTE Band 4 - High Channel QPSK-15

Note: Offset=Cable loss (4.5) + 10log
(147.23/100)=4.5+1.7=6.2 dB

Note: Offset=Cable loss (4.5) + 10log
(147.43/100)=4.5+1.7=6.2 dB

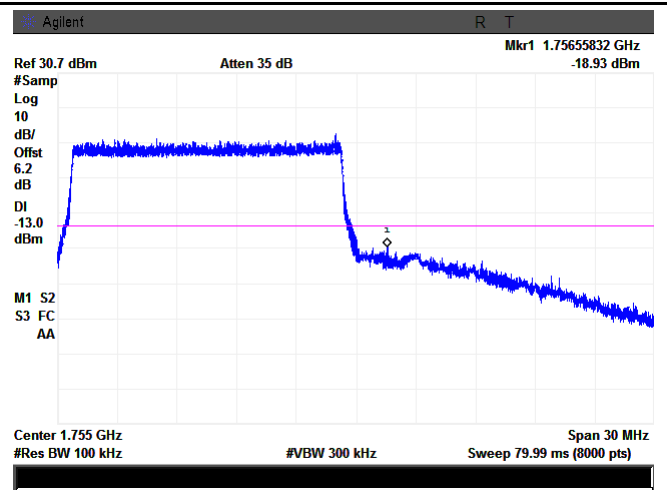
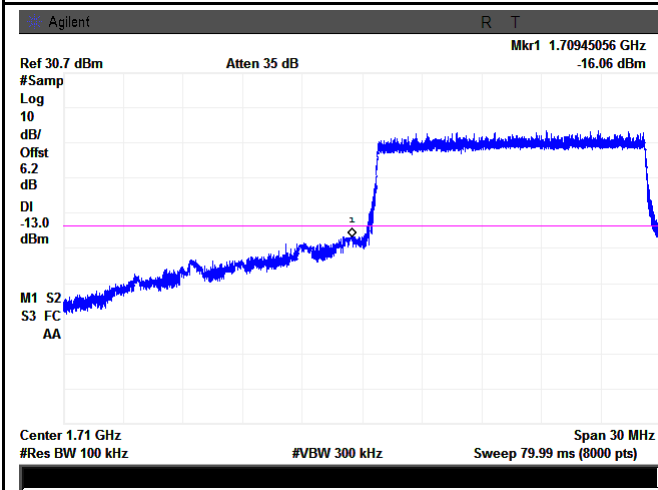

LTE Band 4 - Low Channel 16QAM-15

LTE Band 4 - High Channel 16QAM-15

Note: Offset=Cable loss (4.5) + 10log
(147.28/100)=4.5+1.7=6.2 dB

Note: Offset=Cable loss (4.5) + 10log
(149.37/100)=4.5+1.7=6.2 dB

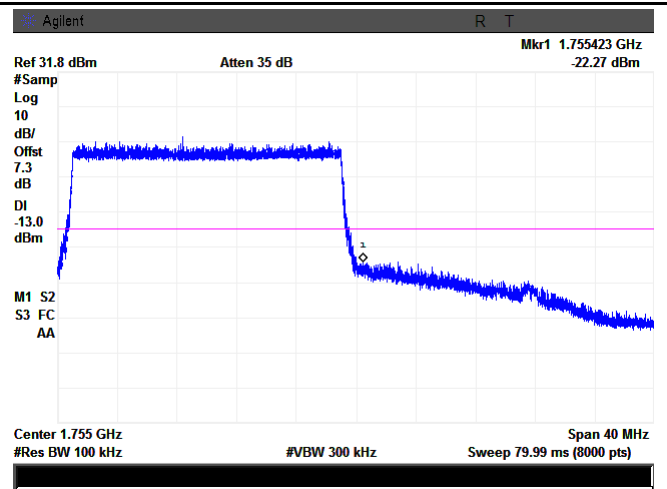
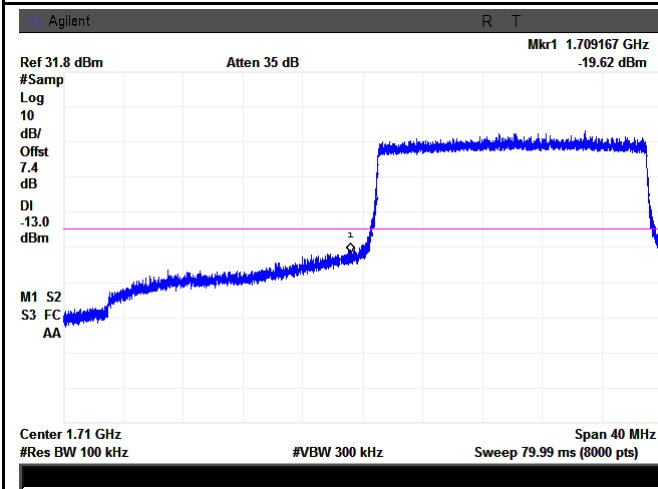

LTE Band 4 - Low Channel QPSK-20

LTE Band 4 - High Channel QPSK-20

Note: Offset=Cable loss (4.5) + 10log
 (194.88/100)=4.5+2.9=7.4 dB

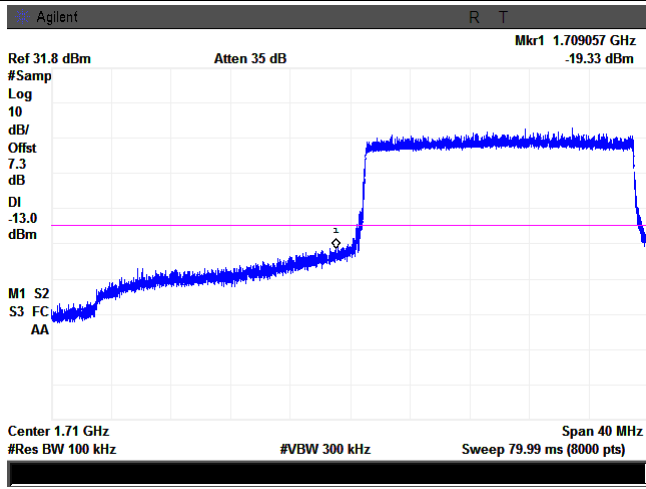

LTE Band 4 - Low Channel 16QAM-20

Note: Offset=Cable loss (4.5) + 10log
 (191.53/100)=4.5+2.8=7.3 dB

Note: Offset=Cable loss (4.5) + 10log
 (192.04/100)=4.5+2.8=7.3 dB

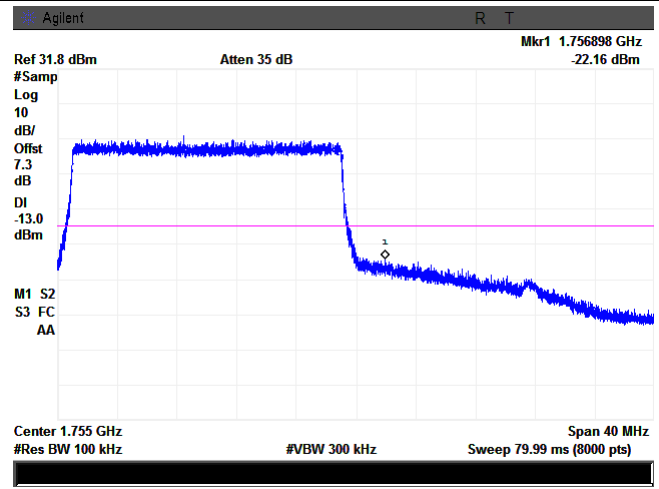

LTE Band 4 - High Channel 16QAM-20

Note: Offset=Cable loss (4.5) + 10log
 (192.47/100)=4.5+2.8=7.3 dB

6.9 Frequency Stability

Temperature	18°C
Relative Humidity	59%
Atmospheric Pressure	1011mbar
Test date :	February 05, 2015
Tested By :	Dustin Wang

Requirement(s):

Spec	Item	Requirement	Applicable																																
§2.1055, § 27.5(h); § 27.54	a)	<p>According to §22.355, the carrier frequency of each transmitter in the Public Mobile Services must be maintained within the tolerances given in Table below:</p> <p>Frequency Tolerance for Transmitters in the Public Mobile Services</p> <table border="1"> <thead> <tr> <th>Frequency Range (MHz)</th> <th>Base, fixed (ppm)</th> <th>Mobile ≤ 3 watts (ppm)</th> <th>Mobile ≤ 3 watts (ppm)</th> </tr> </thead> <tbody> <tr> <td>25 to 50</td> <td>20.0</td> <td>20.0</td> <td>50.0</td> </tr> <tr> <td>50 to 450</td> <td>5.0</td> <td>5.0</td> <td>50.0</td> </tr> <tr> <td>450 to 512</td> <td>2.5</td> <td>5.0</td> <td>5.0</td> </tr> <tr> <td>821 to 896</td> <td>1.5</td> <td>2.5</td> <td>2.5</td> </tr> <tr> <td>928 to 929.</td> <td>5.0</td> <td>N/</td> <td>N/A</td> </tr> <tr> <td>929 to 960.</td> <td>.5</td> <td>N/A</td> <td>N/A</td> </tr> <tr> <td>2110 to 2220</td> <td>10.0</td> <td>N/A</td> <td>N/A</td> </tr> </tbody> </table> <p>According to §24.235, the frequency stability shall be sufficient to ensure that the fundamental emissions stay within the authorized frequency block.</p> <p>According to §27.54, The frequency stability shall be sufficient to ensure that the fundamental emissions stay within the authorized bands of operation.</p>	Frequency Range (MHz)	Base, fixed (ppm)	Mobile ≤ 3 watts (ppm)	Mobile ≤ 3 watts (ppm)	25 to 50	20.0	20.0	50.0	50 to 450	5.0	5.0	50.0	450 to 512	2.5	5.0	5.0	821 to 896	1.5	2.5	2.5	928 to 929.	5.0	N/	N/A	929 to 960.	.5	N/A	N/A	2110 to 2220	10.0	N/A	N/A	<input checked="" type="checkbox"/>
		Frequency Range (MHz)	Base, fixed (ppm)	Mobile ≤ 3 watts (ppm)	Mobile ≤ 3 watts (ppm)																														
		25 to 50	20.0	20.0	50.0																														
		50 to 450	5.0	5.0	50.0																														
		450 to 512	2.5	5.0	5.0																														
		821 to 896	1.5	2.5	2.5																														
		928 to 929.	5.0	N/	N/A																														
		929 to 960.	.5	N/A	N/A																														
2110 to 2220	10.0	N/A	N/A																																

Test setup	<p>The diagram illustrates the test setup. On the left, a green rectangular box represents the 'Base Station'. A line connects it to a blue rectangular box representing the 'EUT' (Equipment Under Test). The EUT is enclosed within a dashed-line box labeled 'Thermal Chamber'.</p>
Procedure	<p>A communication link was established between EUT and base station. The frequency error was monitored and measured by base station under variation of ambient temperature and variation of primary supply voltage.</p> <p>Limit: The frequency stability of the transmitter shall be maintained within $\pm 0.00025\%$ ($\pm 2.5\text{ppm}$) of the center frequency.</p>
Remark	<p>Frequency Stability versus Temperature: The Frequency tolerance of the carrier signal shall be maintained within 2.5ppm of the operating frequency over a temperature variation of -10°C to $+55^{\circ}\text{C}$ at normal supply voltage.</p>
Result	<input checked="" type="checkbox"/> Pass <input type="checkbox"/> Fail

Test Data Yes N/A

Test Plot Yes (See below) N/A

LTE Band 4 (Part 27) result

Middle Channel, $f_0 = 1732.5\text{ MHz}$				
Temperature ($^{\circ}\text{C}$)	Power Supplied (V_{DC})	Frequency Error (Hz)	Frequency Error (ppm)	Limit (ppm)
-10	3.7	14	0.0081	2.5
0		13	0.0075	2.5
10		8	0.0046	2.5
20		5	0.0029	2.5
30		6	0.0035	2.5
40		7	0.0040	2.5
50		9	0.0052	2.5
55		15	0.0087	2.5
25	4.2	12	0.0069	2.5
	3.5	15	0.0087	2.5

Annex A. TEST INSTRUMENT

Instrument	Model	Serial #	Cal Date	Cal Due	In use
RF Conducted Test					
Agilent ESA-E SERIES SPECTRUM ANALYZER	E4407B	MY45108319	09/17/2014	09/16/2015	<input checked="" type="checkbox"/>
Power Splitter	1#	1#	09/02/2014	09/01/2015	<input checked="" type="checkbox"/>
Universal Radio Communication Tester	CMU200	121393	09/26/2014	09/25/2015	<input checked="" type="checkbox"/>
Wideband Radio Communication Tester	CMW500	120906	03/29/2014	03/28/2015	<input checked="" type="checkbox"/>
Temperature/Humidity Chamber	UHL-270	001	10/10/2014	10/09/2015	<input checked="" type="checkbox"/>
DC Power Supply	E3640A	MY40004013	09/18/2014	09/17/2015	<input checked="" type="checkbox"/>
Radiated Emissions					
EMI test receiver	ESL6	100262	09/18/2014	09/17/2015	<input checked="" type="checkbox"/>
OPT 010 AMPLIFIER (0.1-1300MHz)	8447E	2727A02430	09/02/2014	09/01/2015	<input checked="" type="checkbox"/>
Microwave Preamplifier (0.5 ~ 18GHz)	PAM-118	443008	09/02/2014	09/01/2015	<input checked="" type="checkbox"/>
Bilog Antenna (30MHz~6GHz)	JB6	A110712	09/22/2014	09/21/2015	<input checked="" type="checkbox"/>
Bilog Antenna (30MHz~2GHz)	JB1	A112017	09/22/2014	09/21/2015	<input checked="" type="checkbox"/>
Double Ridge Horn Antenna (1 ~18GHz)	AH-118	71259	09/25/2014	09/24/2015	<input checked="" type="checkbox"/>
Double Ridge Horn Antenna (1 ~18GHz)	AH-118	71283	09/25/2014	09/24/2015	<input checked="" type="checkbox"/>
SYNTHESIZED SIGNAL GENERATOR	8665B	3744A01293	09/18/2014	09/17/2015	<input checked="" type="checkbox"/>
Tunable Notch Filter	3NF-800/1000-S	AA4	09/02/2014	09/01/2015	<input checked="" type="checkbox"/>
Tunable Notch Filter	3NF-1000/2000-S	AM 4	09/02/2014	09/01/2015	<input checked="" type="checkbox"/>

Annex B. EUT And Test Setup Photographs

Annex B.i. Photograph: EUT External Photo

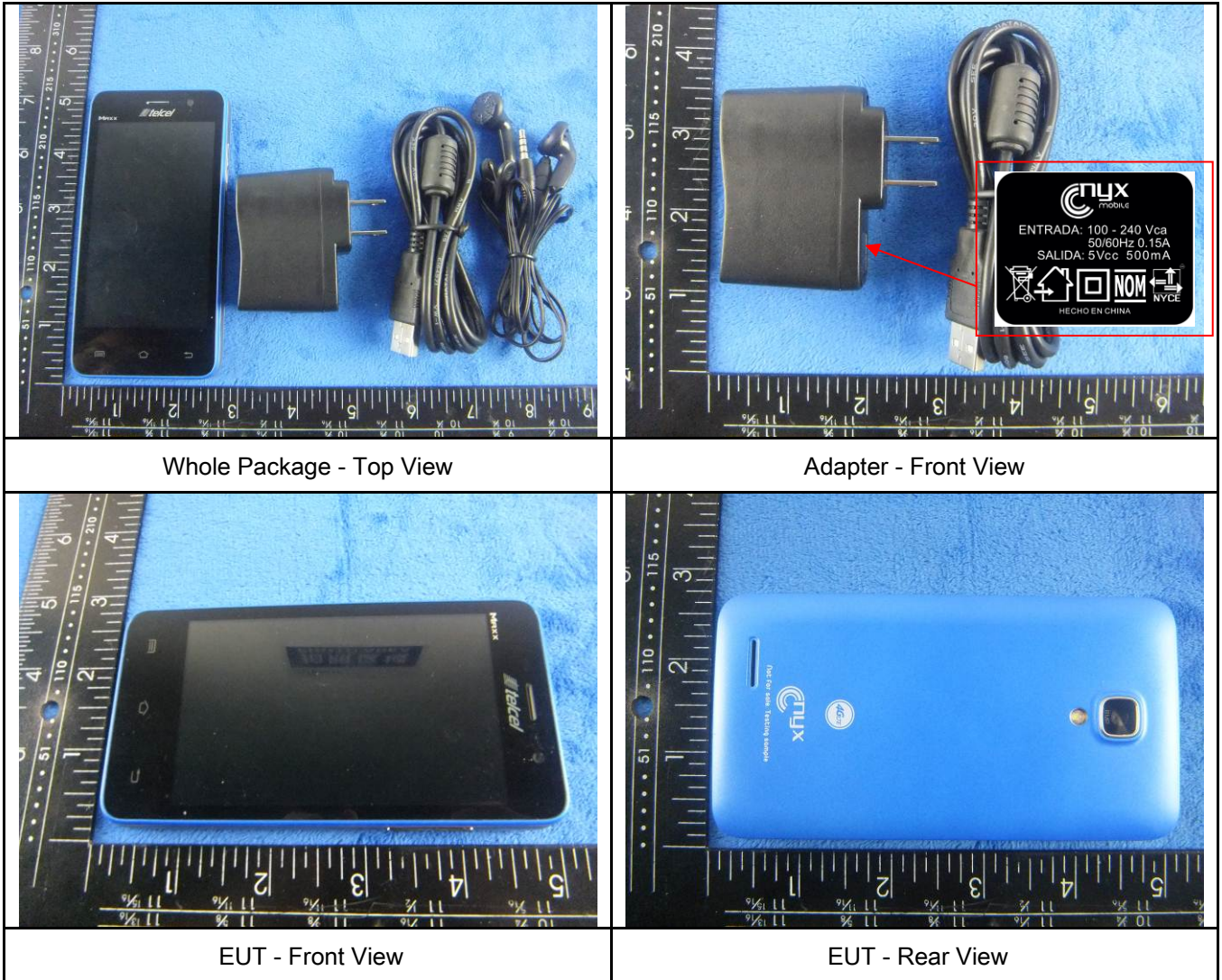



EUT - Top View



EUT - Bottom View



EUT - Left View

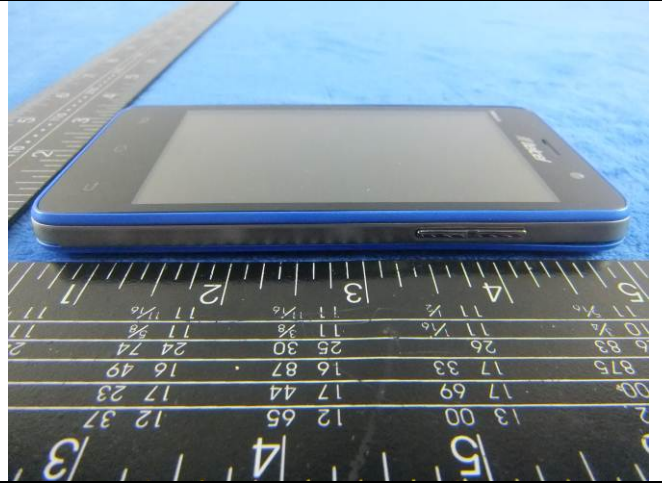

EUT - Right View

Annex B.ii. Photograph: EUT Internal Photo



Cover Off - Top View 1



Cover Off - Top View 2

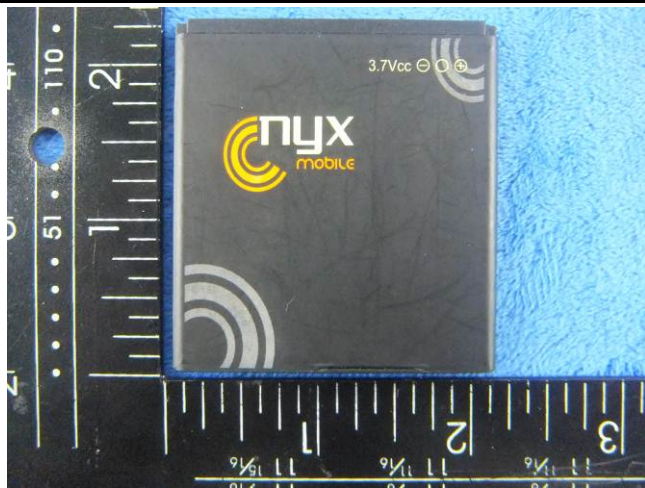

Battery - Top View



Battery - Bottom View



LCD - Front View

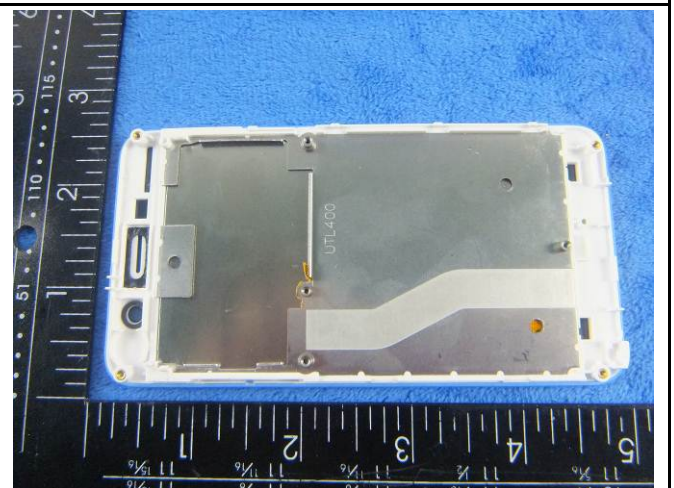

LCD - Rear View

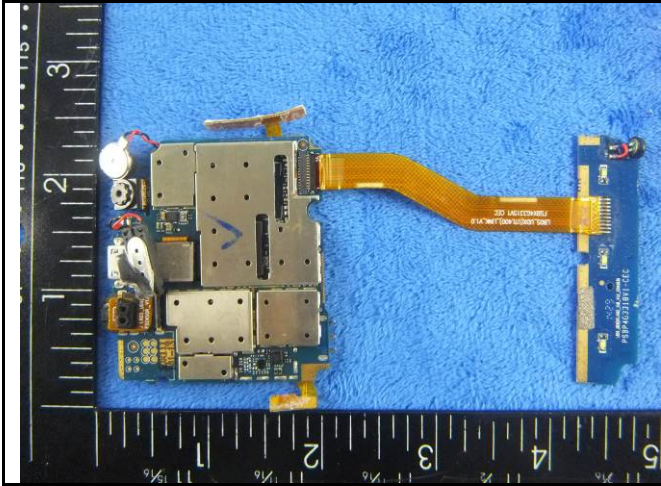

Mainboard With Shielding - Front View

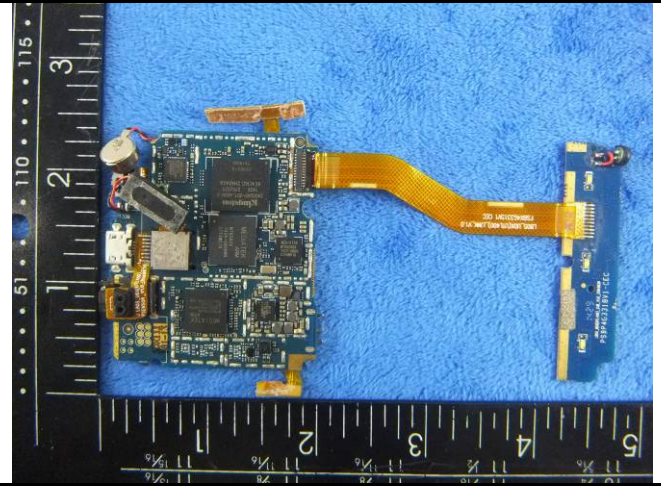

Mainboard Without Shielding - Front View

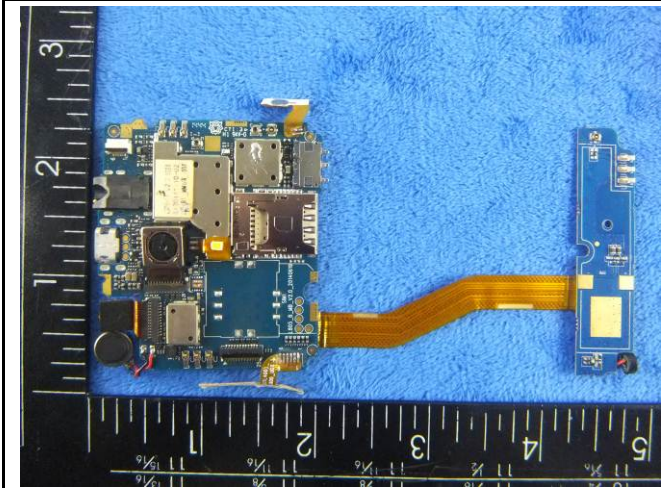

Mainboard With Shielding - Rear View

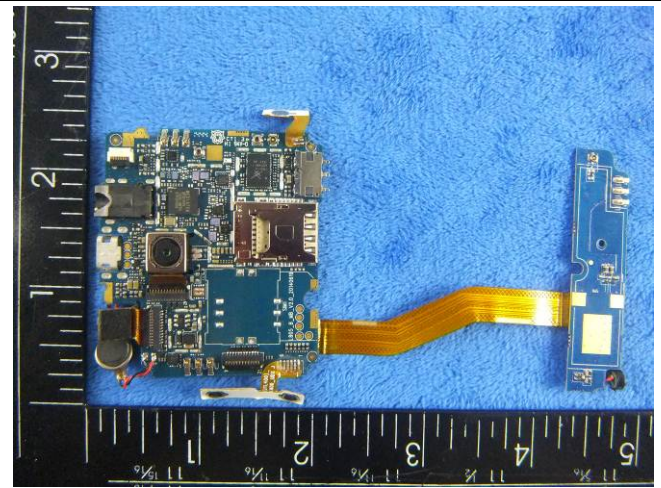

Mainboard Without Shielding - Rear View



LTE Antenna View

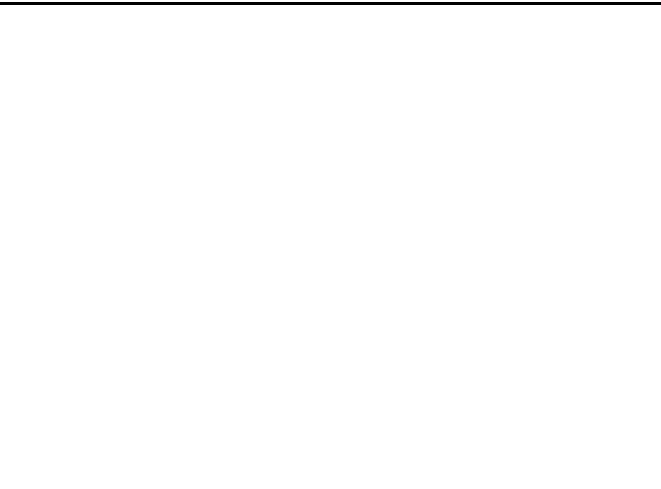

Annex B.iii. Photograph: Test Setup Photo

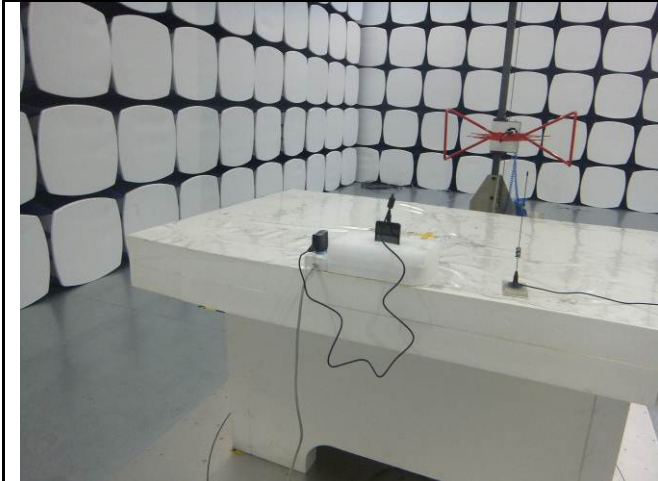

Radiated Spurious Emissions Test Setup Below 1GHz



Radiated Spurious Emissions Test Setup Above
1GHz

Annex C. TEST SETUP AND SUPPORTING EQUIPMENT

Annex C.ii. TEST SET UP BLOCK

Block Configuration Diagram for Radiated Emissions

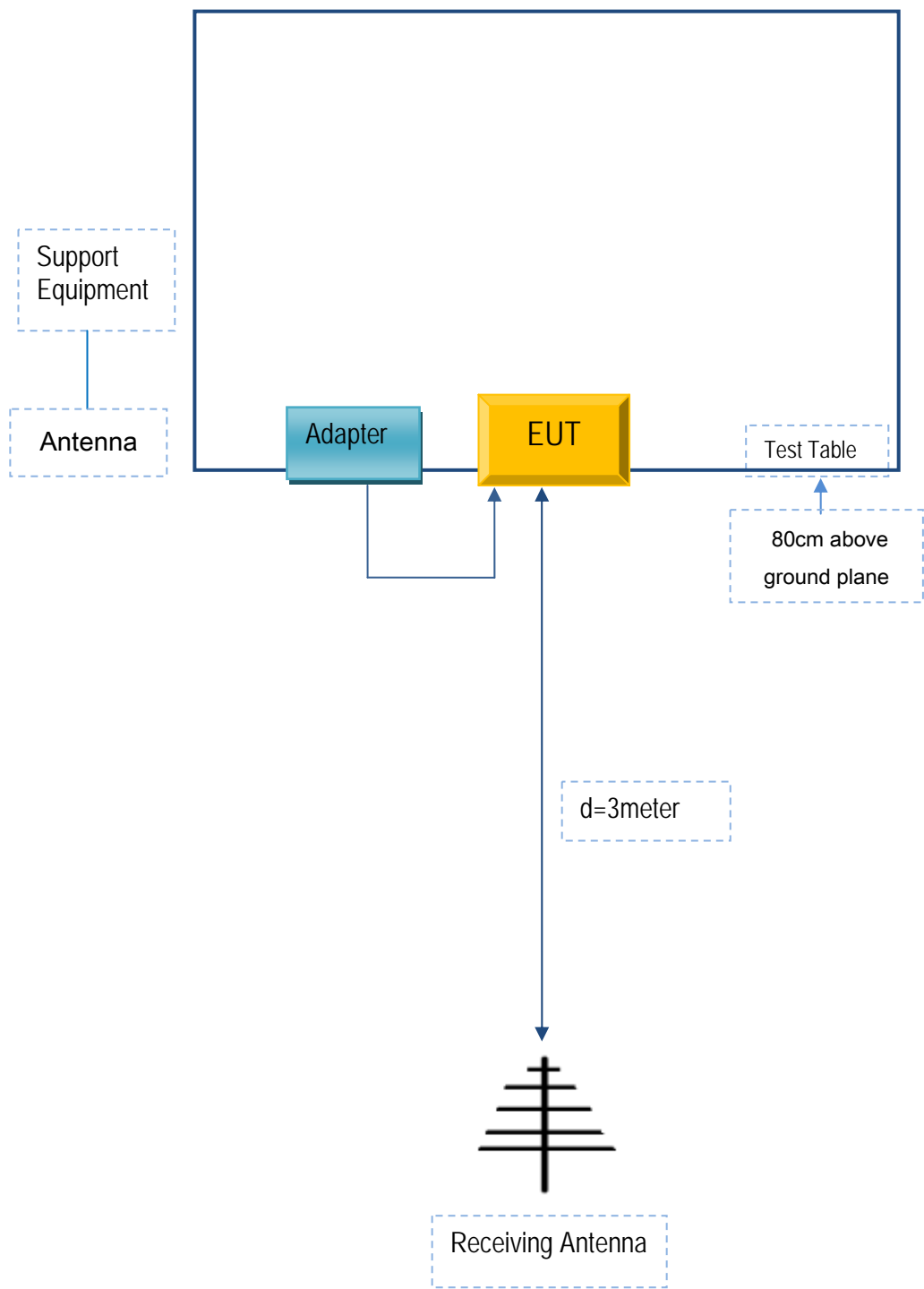

Annex C. ii. SUPPORTING EQUIPMENT DESCRIPTION

The following is a description of supporting equipment and details of cables used with the EUT.

Manufacturer	Equipment Description	Model	Calibration Date	Calibration Due Date
N/A	N/A	N/A	N/A	N/A

Annex C.ii. EUT OPERATING CONKITIONS

The following is the description of how the EUT is exercised during testing.

Test	Description Of Operation
Emissions Testing	The EUT was communicating with base station and set to work at maximum output power.
Others Testing	The EUT was communicating with base station and set to work at maximum output power.

Test Report	14070594-FCC-R
Page	55 of 56

Annex D. User Manual / Block Diagram / Schematics / Partlist

Please see attachment

Test Report	14070594-FCC-R
Page	56 of 56

Annex E. DECLARATION OF SIMILARITY

N/A