



# TEST REPORT

**Report Reference No.**..... : **TRE1512011204** R/C.....: 47400

**FCC ID**..... : **YPVITALCOMLUX**

**Applicant's name**..... : **ITALCOM GROUP**

**Address**..... : 1728 Coral Way, Coral Gables, Miami, Florida, United States

**Manufacturer**..... : UTCOM TECHNOLOGY CO.,LIMITED

**Address**..... : C1105-1107,Tiley Central Plaza,No.3 Haide Road,Nanshan District,Shenzhen,Guangdong,China

**Test item description** ..... : **Smartphone**

**Trade Mark** ..... : NYX

**Model/Type reference**..... : LUX

**Listed Model(s)**..... : -

**Standard** ..... : **FCC CFR Title 47 Part 15 Subpart C Section 15.247**

**Date of receipt of test sample**..... : Dec.21, 2015

**Date of testing**..... : Dec. 22, 2015 ~ Jan. 06, 2016

**Date of issue**..... : Jan. 07, 2016

**Result**..... : **PASS**

Compiled by  
( position+printedname+signature)...: File administrators Candy Liu

*Candy Liu*

Supervised by  
( position+printed name+signature)...: Project Engineer Lion Cai

*Lion Cai*

Approved by  
( position+printed name+signature)...: RF Manager Hans Hu

*Hans Hu*

**Testing Laboratory Name** ..... : **Shenzhen Huatongwei International Inspection Co., Ltd**

**Address**..... : 1/F, Bldg 3, Hongfa Hi-tech Industrial Park, Genyu Road, Tianliao, Gongming, Shenzhen, China

**Shenzhen Huatongwei International Inspection Co., Ltd. All rights reserved.**

This publication may be reproduced in whole or in part for non-commercial purposes as long as the Shenzhen Huatongwei International Inspection Co., Ltd is acknowledged as copyright owner and source of the material. Shenzhen Huatongwei International Inspection Co., Ltd takes no responsibility for and will not assume liability for damages resulting from the reader's interpretation of the reproduced material due to its placement and context.

## Contents

<b><u>1.</u></b>	<b><u>APPLICABLE STANDARDS AND TEST DESCRIPTION</u></b>	<b><u>3</u></b>
1.1.	Applicable Standards	3
1.2.	Test Description	3
<b><u>2.</u></b>	<b><u>SUMMARY</u></b>	<b><u>4</u></b>
2.1.	Client Information	4
2.2.	Product Description	4
2.3.	Operation state	5
2.4.	EUT configuration	5
2.5.	Modifications	5
<b><u>3.</u></b>	<b><u>TEST ENVIRONMENT</u></b>	<b><u>6</u></b>
3.1.	Address of the test laboratory	6
3.2.	Test Facility	6
3.3.	Equipments Used during the Test	7
3.4.	Environmental conditions	8
3.5.	Statement of the measurement uncertainty	8
<b><u>4.</u></b>	<b><u>TEST CONDITIONS AND RESULTS</u></b>	<b><u>9</u></b>
4.1.	Antenna requirement	9
4.2.	Conducted Emission (AC Main)	10
4.3.	Conducted Peak Output Power	13
4.4.	Power Spectral Density	14
4.5.	6dB bandwidth	16
4.6.	Restricted band	18
4.7.	Band edge and Spurious Emission (conducted)	20
4.8.	Spurious Emission (radiated)	24
<b><u>5.</u></b>	<b><u>TEST SETUP PHOTOS OF THE EUT</u></b>	<b><u>29</u></b>
<b><u>6.</u></b>	<b><u>EXTERNAL AND INTERNAL PHOTOS OF THE EUT</u></b>	<b><u>30</u></b>

# **1. APPLICABLE STANDARDS AND TEST DESCRIPTION**

## **1.1. Applicable Standards**

The tests were performed according to following standards:

[FCC Rules Part 15.247](#): Frequency Hopping, Direct Spread Spectrum and Hybrid Systems that are in operation within the bands of 902-928 MHz, 2400-2483.5 MHz, and 5725-5850 MHz.

[ANSI C63.10-2013](#): American National Standard for Testing Unlicensed Wireless Devices

[KDB558074 D01 V03R04](#): Guidance for Performing Compliance Measurements on Digital Transmission Systems (DTS)

## **1.2. Test Description**

ReportSection	Test Item	FCC Rule	Result
4.1	Antenna requirement	15.203/15.247 (c)	Pass
4.2	Line Conducted Emission (AC Main)	15.207	Pass
4.3	Conducted Peak Output Power	15.247 (b)(3)	Pass
4.4	Power Spectral Density	15.247 (e)	Pass
4.5	6dB Bandwidth	15.247 (a)(2)	Pass
4.6	Restricted band	15.247(d)/15.205	Pass
4.7/4.8	Spurious Emission	15.247(d)/15.209	Pass

Remark: The measurement uncertainty is not included in the test result.

## 2. SUMMARY

### 2.1. Client Information

Applicant:	ITALCOM GROUP
Address:	1728 Coral Way, Coral Gables, Miami, Florida, United States
Manufacturer:	UTCOM TECHNOLOGY CO.,LIMITED
Address:	C1105-1107,Tiley Central Plaza,No.3 Haide Road,Nanshan District,Shenzhen,Guangdong,China

### 2.2. Product Description

Name of EUT	Smartphone
Trade Mark:	NYX
Model No.:	LUX
Listed Model(s):	-
IMEI:	351645070001182
Power supply:	DC 3.7V From internal battery
Adapter information:	Input:AC 100-240V 50/60Hz 0.15A Output: 5Vd.c., 500mA
<b>Bluetooth</b>	
Version:	Supported BT4.0+BLE
Modulation:	GFSK
Operation frequency:	2402MHz~2480MHz
Channel number:	40
Channel separation:	2MHz
Antenna type:	Internal Antenna
Antenna gain:	1.0dBi

### 2.3. Operation state

#### ◆ Test frequency list

According to section 15.31(m), regards to the operating frequency range over 10 MHz, must select three channel which were tested. the Lowest frequency, the middle frequency, and the highest frequency of channel were selected to perform the test, please see the above gray bottom.

Channel	Frequency (MHz)
00	2402
02	2404
:	:
19	2440
:	:
38	2478
39	2480

#### ◆ Test mode

For RF test items:

The engineering test program was provided and enabled to make EUT continuous transmit/receive. The EUT was programmed to be in continuously transmitting mode and the transmit duty cycle is not less than 98%.

### 2.4. EUT configuration

**The following peripheral devices and interface cables were connected during the measurement:**

- - supplied by the manufacturer
- - supplied by the lab

	Length (m) :	/
	Shield :	/
	Detachable :	/
	Manufacturer :	/
	Model No. :	/

### 2.5. Modifications

No modifications were implemented to meet testing criteria.

### **3. TEST ENVIRONMENT**

#### **3.1. Address of the test laboratory**

Laboratory: Shenzhen Huatongwei International Inspection Co., Ltd.

Address: 1/F, Bldg 3, Hongfa Hi-tech Industrial Park, Genyu Road, Tianliao, Gongming, Shenzhen, China

Phone: 86-755-26748019 Fax: 86-755-26748089

#### **3.2. Test Facility**

The test facility is recognized, certified, or accredited by the following organizations:

##### **CNAS-Lab Code: L1225**

Shenzhen Huatongwei International Inspection Co., Ltd. has been assessed and proved to be in compliance with CNAS-CL01 Accreditation Criteria for Testing and Calibration Laboratories (identical to ISO/IEC17025: 2005 General Requirements) for the Competence of Testing and Calibration Laboratories, Date of Registration: February 28, 2015. Valid time is until February 27, 2018.

##### **A2LA-Lab Cert. No. 3902.01**

Shenzhen Huatongwei International Inspection Co., Ltd. EMC Laboratory has been accredited by A2LA for technical competence in the field of electrical testing, and proved to be in compliance with ISO/IEC 17025: 2005 General Requirements for the Competence of Testing and Calibration Laboratories and any additional program requirements in the identified field of testing. Valid time is until December 31, 2016.

##### **FCC-Registration No.: 317478**

Shenzhen Huatongwei International Inspection Co., Ltd. EMC Laboratory has been registered and fully described in a report filed with the FCC (Federal Communications Commission). The acceptance letter from the FCC is maintained in our files. Registration 317478, Renewal date Jul. 18, 2014, valid time is until Jul. 18, 2017.

##### **IC-Registration No.: 5377A&5377B**

The 3m Alternate Test Site of Shenzhen Huatongwei International Inspection Co., Ltd. has been registered by Certification and Engineering Bureau of Industry Canada for the performance of radiated measurements with Registration No. 5377A on Dec. 31, 2013, valid time is until Dec. 31, 2016.

Two 3m Alternate Test Site of Shenzhen Huatongwei International Inspection Co., Ltd. has been registered by Certification and Engineering Bureau of Industry Canada for the performance of radiated measurements with Registration No. 5377B on Dec.03, 2014, valid time is until Dec.03, 2017.

##### **ACA**

Shenzhen Huatongwei International Inspection Co., Ltd. EMC Laboratory can also perform testing for the Australian C-Tick mark as a result of our A2LA accreditation.

##### **VCCI**

The 3m Semi-

anechoic chamber (12.2m×7.95m×6.7m) of Shenzhen Huatongwei International Inspection Co., Ltd.

has been registered in accordance with the Regulations for Voluntary Control Measures with Registration No.: R-2484. Date of Registration: Dec. 20, 2012. Valid time is until Dec. 29, 2015.

Radiated disturbance above 1GHz measurement of Shenzhen Huatongwei International Inspection Co., Ltd. has been registered in accordance with the Regulations for Voluntary Control Measures with Registration No.: G-292. Date of Registration: Dec. 24, 2013. Valid time is until Dec. 23, 2016.

Main Ports Conducted Interference Measurement of Shenzhen Huatongwei International Inspection Co., Ltd. has been registered in accordance with the Regulations for Voluntary Control Measures with Registration No.: C-2726. Date of Registration: Dec. 20, 2012. Valid time is until Dec. 19, 2015.

Telecommunication Ports Conducted Interference Measurement of Shenzhen Huatongwei International Inspection Co., Ltd. has been registered in accordance with the Regulations for Voluntary Control Measures with Registration No.: T-1837. Date of Registration: May 07, 2013. Valid time is until May 06, 2016.

##### **DNV**

Shenzhen Huatongwei International Inspection Co., Ltd. has been found to comply with the requirements of DNV towards subcontractor of EMC and safety testing services in conjunction with the EMC and Low voltage Directives and in the voluntary field. The acceptance is based on a formal quality Audit and follow-ups according to relevant parts of ISO/IEC Guide 17025 (2005), in accordance with the requirements of the DNV Laboratory Quality Manual towards subcontractors. Valid time is until Aug. 24, 2016.

### 3.3. Equipments Used during the Test

Conducted Emission (AC Main)					
Item	Test Equipment	Manufacturer	Model No.	Serial No.	Last Cal
1	Artificial Mains	Rohde&Schwarz	ESH2-Z5	100028	2015/11/02
2	EMI Test Receiver	Rohde&Schwarz	ESCI3	100038	2015/11/02
3	Pulse Limiter	Rohde&Schwarz	ESHSZ2	100044	2015/11/02
4	EMI Test Software	Rohde&Schwarz	ES-K1 V1.71	N/A	N/A

Radiated Emission					
Item	Test Equipment	Manufacturer	Model No.	Serial No.	Last Cal
1	Ultra-Broadband Antenna	ShwarzBeck	VULB9163	538	2015/11/02
2	EMI TEST RECEIVER	Rohde&Schwarz	ESI 26	100009	2015/11/02
3	EMI TEST Software	Audix	E3	N/A	N/A
4	TURNTABLE	ETS	2088	2149	N/A
5	ANTENNA MAST	ETS	2075	2346	N/A
6	EMI TEST Software	Rohde&Schwarz	ESK1	N/A	N/A
7	HORNANTENNA	ShwarzBeck	9120D	1011	2015/11/02
8	Amplifer	Sonoma	310N	E009-13	2015/11/02
9	JS amplifer	Rohde&Schwarz	JS4-00101800-28-5A	F201504	2015/11/02
10	High pass filter	Compliance Direction systems	BSU-6	34202	2015/11/02
11	HORNANTENNA	ShwarzBeck	9120D	1012	2015/11/02
12	Amplifer	Compliance Direction systems	PAP1-4060	120	2015/11/02
13	Loop Antenna	Rohde&Schwarz	HFH2-Z2	100020	2015/11/02
14	TURNTABLE	MATURO	TT2.0	----	N/A
15	ANTENNA MAST	MATURO	TAM-4.0-P	----	N/A
16	Horn Antenna	SCHWARZBECK	BBHA9170	25841	2015/11/02
17	ULTRA-BROADBAND ANTENNA	Rohde&Schwarz	HL562	100015	2015/11/02

Maximum Peak Output Power / Power Spectral Density / 6dB Bandwidth / Band Edge Compliance of RF Emission / Spurious RF Conducted Emission					
Item	Test Equipment	Manufacturer	Model No.	Serial No.	Last Cal
1	Spectrum Analyzer	Rohde&Schwarz	FSP	1164.4391.40	2015/11/02
2	Power Meter	Anritsu	ML2480B	100798	2015/11/02
3	Power Sensor	Anritsu	MA2411B	100258	2015/11/02

The Cal.Interval was one year

### 3.4. Environmental conditions

During the measurement the environmental conditions were within the listed ranges:

Temperature:	15~35°C
Relative Humidity:	30~60 %
Air Pressure:	950~1050mba

### 3.5. Statement of the measurement uncertainty

The data and results referenced in this document are true and accurate. The reader is cautioned that there may be errors within the calibration limits of the equipment and facilities. The measurement uncertainty was calculated for all measurements listed in this test report according to TR-100028-01 "Electromagnetic compatibility and Radio spectrum Matters (ERM); Uncertainties in the measurement of mobile radio equipment characteristics; Part 1" and TR-100028-02 "Electromagnetic compatibility and Radio spectrum Matters (ERM); Uncertainties in the measurement of mobile radio equipment characteristics; Part 2" and is documented in the Shenzhen Huatongwei International Inspection Co., Ltd quality system according to DIN EN ISO/IEC 17025. Furthermore, component and process variability of devices similar to that tested may result in additional deviation. The manufacturer has the sole responsibility of continued compliance of the device.

Hereafter the best measurement capability for Shenzhen Huatongwei laboratory is reported:

Test Items	Measurement Uncertainty	Notes
Transmitter power conducted	0.57 dB	(1)
Transmitter power Radiated	2.20 dB	(1)
Conducted spurious emission 9KHz-40 GHz	1.60 dB	(1)
Radiated spurious emission 9KHz-40 GHz	2.20 dB	(1)
Conducted Emission 9KHz-30MHz	3.39 dB	(1)
Radiated Emission 30~1000MHz	4.24 dB	(1)
Radiated Emission 1~18GHz	5.16 dB	(1)
Radiated Emission 18-40GHz	5.54 dB	(1)
Occupied Bandwidth	-----	(1)

(1) This uncertainty represents an expanded uncertainty expressed at approximately the 95% confidence level using a coverage factor of  $k=1.96$ .



## 4. TEST CONDITIONS AND RESULTS

### 4.1. Antenna requirement

#### Requirement

##### **FCC CFR Title 47 Part 15 Subpart C Section 15.203:**

An intentional radiator shall be designed to ensure that no antenna other than that furnished by the responsible party shall be used with the device. The use of a permanently attached antenna or of an antenna that uses a unique coupling to the intentional radiator, the manufacturer may design the unit so that a broken antenna can be replaced by the user, but the use of a standard antenna jack or electrical connector is prohibited.

##### **FCC CFR Title 47 Part 15 Subpart C Section 15.247(c) (1)(i):**

(i) Systems operating in the 2400-2483.5 MHz band that is used exclusively for fixed. Point-to-point operations may employ transmitting antennas with directional gain greater than 6dBi provided the maximum conducted output power of the intentional radiator is reduced by 1 dB for every 3 dB that the directional gain of the antenna exceeds 6dBi.

#### Test Result:

The antenna is integral antenna, the best case gain of the antenna is 1.0dBi



## 4.2. Conducted Emission (AC Main)

### LIMIT

FCC CFR Title 47 Part 15 Subpart C Section 15.207

Frequency range (MHz)	Limit (dBuV)	
	Quasi-peak	Average
0.15-0.5	66 to 56*	56 to 46*
0.5-5	56	46
5-30	60	50

\* Decreases with the logarithm of the frequency.

### TEST CONFIGURATION

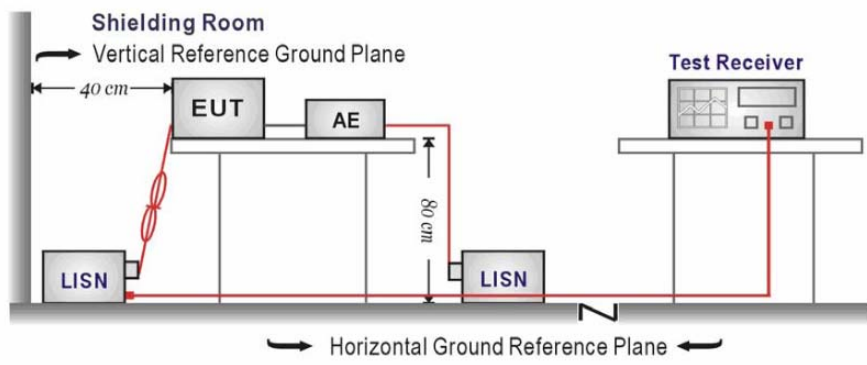

### TEST PROCEDURE

1. The EUT was setup and tested according to ANSI C63.10:2013 for compliance to FCC 47CFR 15.247 requirements.
2. The EUT was placed on a platform of nominal size, 1 m by 1.5 m, raised 80 cm above the conducting ground plane. The vertical conducting plane was located 40 cm to the rear of the EUT. All other surfaces of EUT were at least 80 cm from any other grounded conducting surface.
3. The EUT and simulators are connected to the main power through a line impedance stabilization network (LISN). The LISN provides a 50 ohm /50uH coupling impedance for the measuring equipment.
4. The peripheral devices are also connected to the main power through a LISN. (Please refer to the block diagram of the test setup and photographs)
5. Each current-carrying conductor of the EUT power cord, except the ground (safety) conductor, was individually connected through a LISN to the input power source.
6. The excess length of the power cord between the EUT and the LISN receptacle were folded back and forth at the center of the lead to form a bundle not exceeding 40 cm in length.
7. Conducted emissions were investigated over the frequency range from 0.15MHz to 30MHz using a receiver bandwidth of 9 kHz.

### TEST RESULTS

Test mode:AC 120V	BT	Polarization	L
-------------------	----	--------------	---

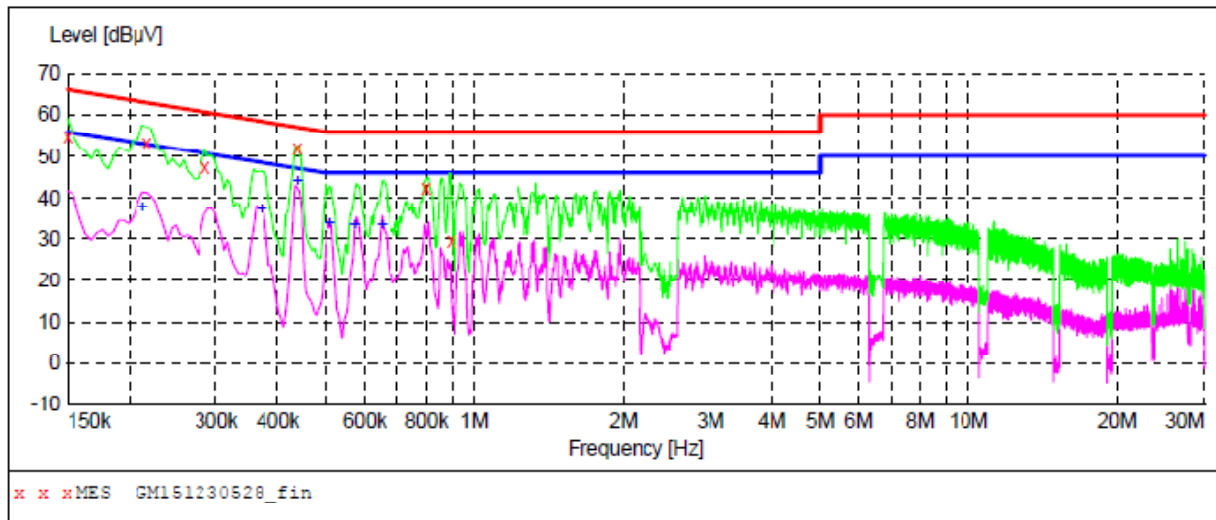

**MEASUREMENT RESULT: "GM151230528\_fin"**

12/30/2015 1:58PM

Frequency MHz	Level dBµV	Transd dB	Limit dBµV	Margin dB	Detector	Line	PE
0.150000	54.60	10.2	66	11.4	QP	L1	GND
0.217500	53.20	10.2	63	9.7	QP	L1	GND
0.285000	47.20	10.2	61	13.5	QP	L1	GND
0.438000	51.70	10.2	57	5.4	QP	L1	GND
0.798000	42.30	10.2	56	13.7	QP	L1	GND
0.897000	29.50	10.2	56	26.5	QP	L1	GND

**MEASUREMENT RESULT: "GM151230528\_fin2"**

12/30/2015 1:58PM

Frequency MHz	Level dBµV	Transd dB	Limit dBµV	Margin dB	Detector	Line	PE
0.213000	37.90	10.2	53	15.2	AV	L1	GND
0.370500	37.20	10.2	49	11.3	AV	L1	GND
0.438000	43.80	10.2	47	3.3	AV	L1	GND
0.510000	33.50	10.2	46	12.5	AV	L1	GND
0.573000	33.20	10.2	46	12.8	AV	L1	GND
0.649500	33.40	10.2	46	12.6	AV	L1	GND

Test mode: AC 120V	BT	Polarization	N
--------------------	----	--------------	---

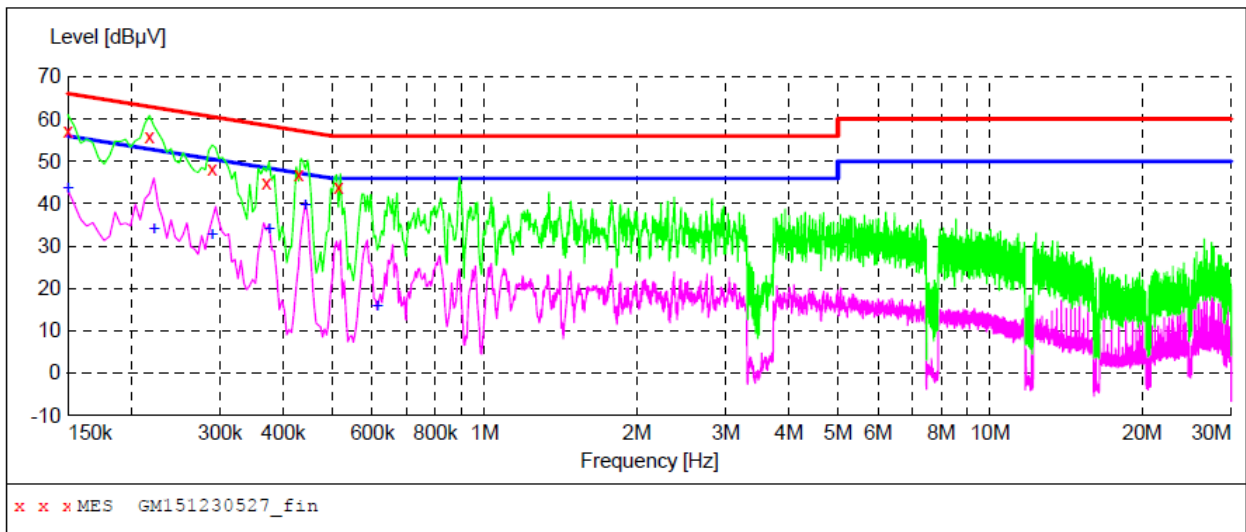

**MEASUREMENT RESULT: "GM151230527\_fin"**

12/30/2015 1:55PM

Frequency MHz	Level dBµV	Transd dB	Limit dBµV	Margin dB	Detector	Line	PE
0.150000	57.10	10.2	66	8.9	QP	N	GND
0.217500	55.90	10.2	63	7.0	QP	N	GND
0.289500	48.20	10.2	61	12.3	QP	N	GND
0.370500	44.90	10.2	59	13.6	QP	N	GND
0.429000	47.00	10.2	57	10.3	QP	N	GND
0.514500	44.00	10.2	56	12.0	QP	N	GND

**MEASUREMENT RESULT: "GM151230527\_fin2"**

12/30/2015 1:55PM

Frequency MHz	Level dBµV	Transd dB	Limit dBµV	Margin dB	Detector	Line	PE
0.150000	43.70	10.2	56	12.3	AV	N	GND
0.222000	33.90	10.2	53	18.8	AV	N	GND
0.289500	32.50	10.2	51	18.0	AV	N	GND
0.375000	34.00	10.2	48	14.4	AV	N	GND
0.442500	39.70	10.2	47	7.3	AV	N	GND
0.613500	15.70	10.2	46	30.3	AV	N	GND

### 4.3. Conducted Peak Output Power

#### LIMIT

FCC CFR Title 47 Part 15 Subpart C Section 15.247 (b)(3): **30dBm**

#### TEST CONFIGURATION

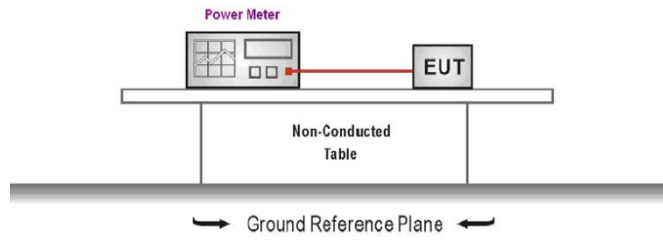

#### TEST PROCEDURE

1. The EUT was tested according to KDB 558074 D01 V03R04 for compliance to FCC 47CFR 15.247 requirements.
2. The maximum peak conducted output power may be measured using a broadband peak RF power meter.
3. The power meter shall have a video bandwidth that is greater than or equal to the DTS bandwidth and shall utilize a fast-responding diode detector
4. Record the measurement data.

#### TEST RESULTS

Type	Channel	Output power (dBm)	Limit (dBm)	Result
BT-BLE	00	-6.47	30.00	Pass
	19	-5.57		
	39	-5.30		

### 4.4. Power Spectral Density

#### LIMIT

FCC CFR Title 47 Part 15 Subpart C Section 15.247 (e): **8dBm/3KHz**

*For digitally modulated systems, the power spectral density conducted from the intentional radiator to the antenna shall not be greater than 8 dBm in any 3 kHz band during any time interval of continuous transmission.*

#### TEST CONFIGURATION

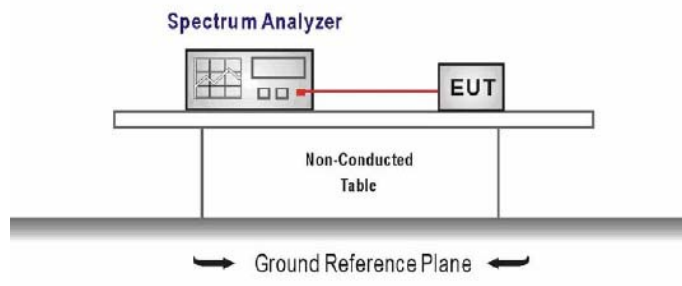

#### TEST PROCEDURE

1. Connect the antenna port(s) to the spectrum analyzer input,
2. Configure the spectrum analyzer as shown below:  
*Center frequency=DTS channel center frequency*  
*Span =1.5 times the DTS bandwidth*  
*RBW = 3 kHz ≤ RBW ≤ 100 kHz, VBW ≥ 3 × RBW*  
*Sweep time = auto couple*  
*Detector = peak*  
*Trace mode = max hold*
3. Place the radio in continuous transmit mode, allow the trace to stabilize, view the transmitter waveform on the spectrum analyzer.
4. Use the peak marker function to determine the maximum amplitude level within the RBW.
5. If measured value exceeds limit, reduce RBW (no less than 3 kHz) and repeat.

#### TEST RESULTS

Type	Channel	Power Spectral Density(dBm/3KHz)	Limit (dBm/3KHz)	Result
BT-BLE	00	-22.45	8.00	Pass
	19	-21.60		
	39	-20.77		

Test plot as follows:

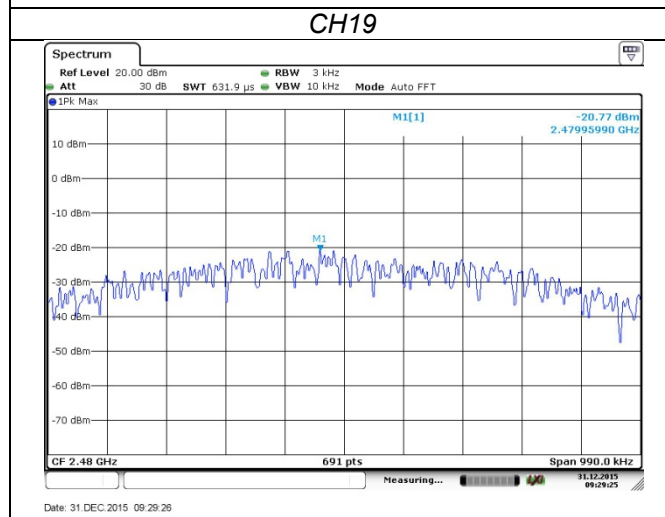
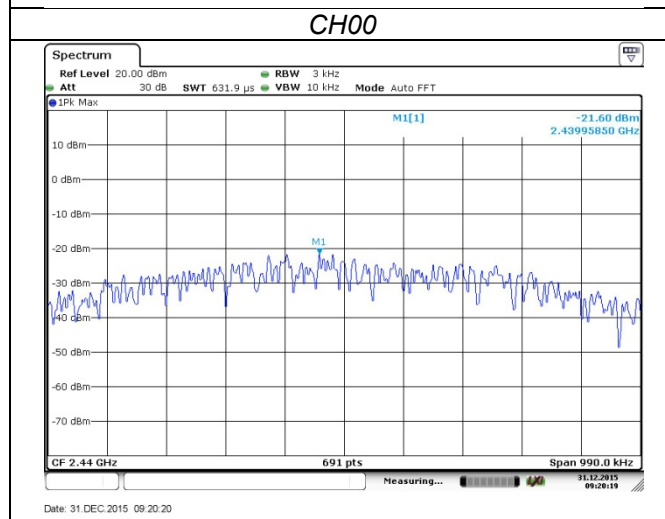
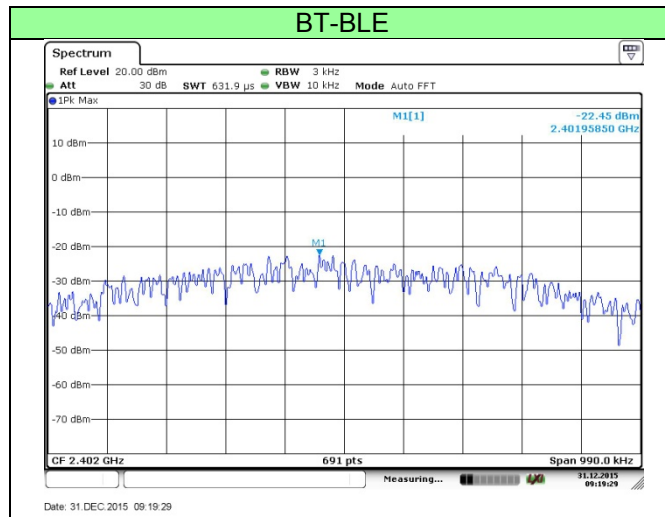

CH39

### 4.5. 6dB bandwidth

#### LIMIT

FCC CFR Title 47 Part 15 Subpart C Section 15.247 (a)(2): **at least 500KHz**

*For digital modulation systems, the minimum 6 dB bandwidth shall be at least 500 kHz.*

#### TEST CONFIGURATION

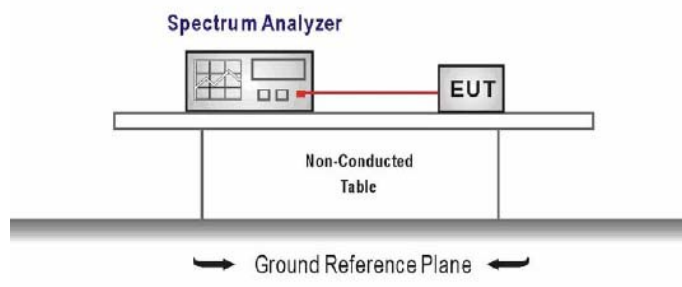

#### TEST PROCEDURE

1. Connect the antenna port(s) to the spectrum analyzer input.
2. Configure the spectrum analyzer as shown below (enter all losses between the transmitter output and the spectrum analyzer).  
*Center Frequency = DTS channel center frequency*  
*Span = 2 x DTS bandwidth*  
*RBW = 100 kHz, VBW ≥ 3 x RBW*  
*Sweep time = auto couple*  
*Detector = Peak*  
*Trace mode = max hold*
3. Place the radio in continuous transmit mode, allow the trace to stabilize, view the transmitter waveform on the spectrum analyzer.
4. Measure the maximum width of the emission that is constrained by the frequencies associated with the two outermost amplitude points (upper and lower frequencies) that are attenuated by 6 dB relative to the maximum level measured in the fundamental emission, and record the pertinent measurements.

#### TEST RESULTS

Type	Channel	6dB Bandwidth(3KHz)	Limit (KHz)	Result
BT-BLE	00	658.50	≥500	Pass
	19	658.50		
	39	665.70		

Test plot as follows:



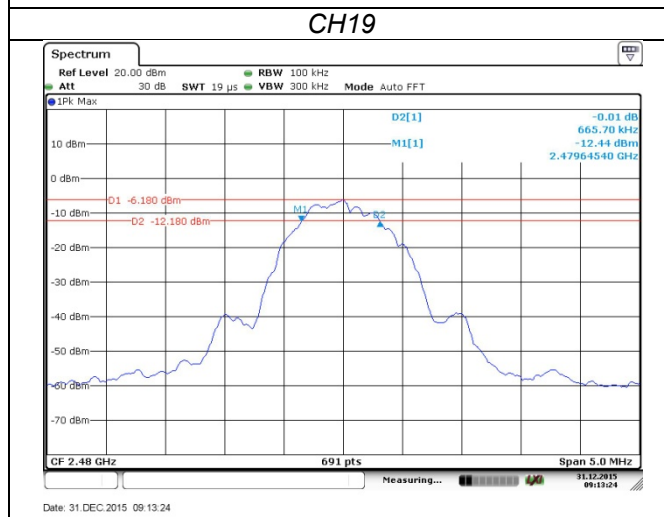
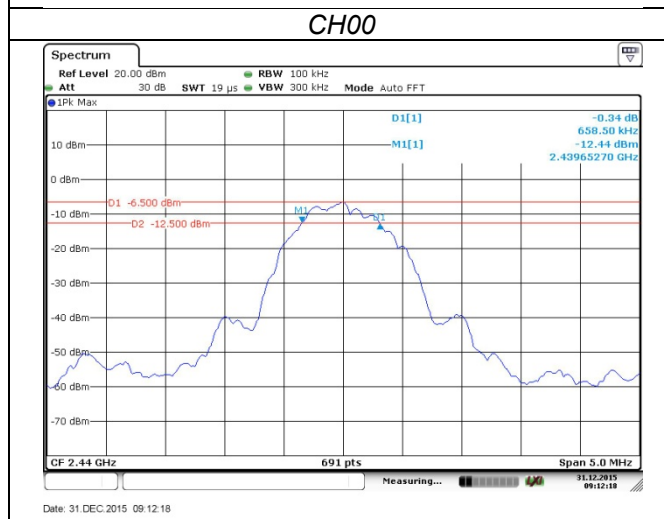
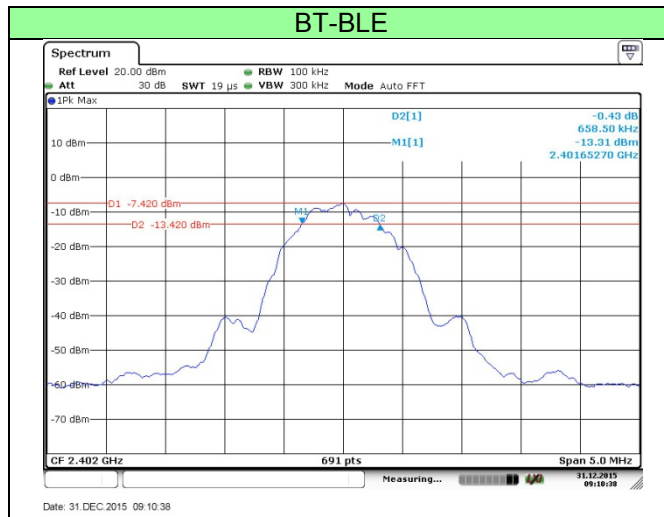

**CH39**

## 4.6. Restricted band

### LIMIT

FCC CFR Title 47 Part 15 Subpart C Section 15.247 (d):

*In any 100 kHz bandwidth outside the frequency band in which the spread spectrum or digitally modulated intentional radiator is operating, radiated emissions which fall in the restricted bands, as defined in §15.205(a), must also comply with the radiated emission limits specified in §15.209(a) (see §15.205(c)).*

### TEST CONFIGURATION

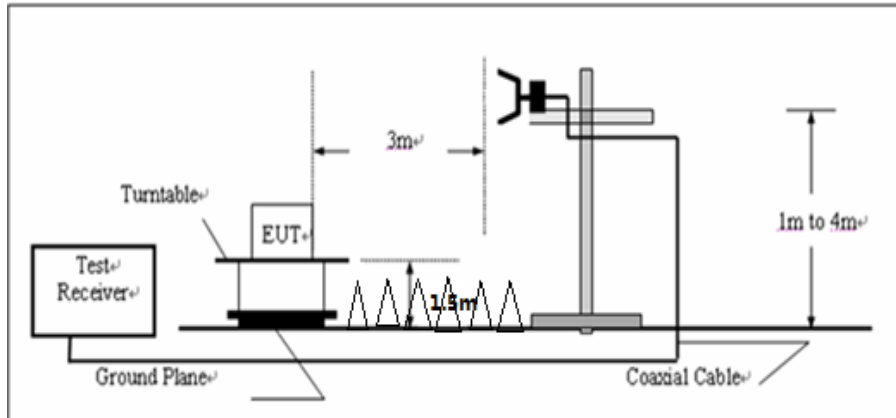

### TEST PROCEDURE

1. The EUT was setup and tested according to ANSI C63.10:2013 for compliance to FCC 47CFR 15.247 requirements.
2. The EUT is placed on a turn table which is 1.5 meter above ground. The turn table is rotated 360 degrees to determine the position of the maximum emission level.
3. The EUT was positioned such that the distance from antenna to the EUT was 3 meters.
4. The antenna is scanned from 1 meter to 4 meters to find out the maximum emission level. This is repeated for both horizontal and vertical polarization of the antenna. In order to find the maximum emission, all of the interface cables were manipulated according to ANSI C63.10:2013 on radiated measurement.
5. The receiver set as follow:  
RBW=1MHz, VBW=3MHz for Peak value  
RBW=1MHz, VBW=10Hz for Average value.

### TEST RESULTS

CH00									
Frequency (MHz)	Read Level (dBuV)	Antenna Factor (dB/m)	Cable Loss (dB)	Preamp Factor (dB)	Level (dBuV/m)	Limit Line (dBuV/m)	Margin Limit (dB)	Polarization	Test value
2385.62	47.42	27.53	6.81	37.24	44.52	74.00	-29.48	Vertical	Peak
2385.49	46.77	27.53	6.81	37.24	43.87	74.00	-30.13	Horizontal	
2385.58	41.64	27.53	6.81	37.24	38.74	54.00	-15.26	Vertical	Average
2385.36	40.42	27.53	6.81	37.24	37.52	54.00	-16.48	Horizontal	

CH39									
Frequency (MHz)	Read Level (dBuV)	Antenna Factor (dB/m)	Cable Loss (dB)	Preamp Factor (dB)	Level (dBuV/m)	Limit Line (dBuV/m)	Margin Limit (dB)	Polarization	Test value
2489.52	49.46	27.85	6.96	37.92	46.35	74.00	-27.65	Vertical	Peak
2489.52	47.98	27.85	6.96	37.92	44.87	74.00	-29.13	Horizontal	
2489.68	42.74	27.85	6.96	37.92	39.63	54.00	-14.37	Vertical	Average
2489.75	41.63	27.85	6.96	37.92	38.52	54.00	-15.48	Horizontal	

Note: Level = Read + Antenna Factor + Cable Loss - Preamp Factor

## 4.7. Band edge and Spurious Emission (conducted)

### LIMIT

FCC CFR Title 47 Part 15 Subpart C Section 15.247 (d):

*In any 100 kHz bandwidth outside the frequency band in which the spread spectrum intentional radiator is operating, the radio frequency power that is produced by the intentional radiator shall be at least 20 dB below that in the 100 kHz bandwidth within the band that contains the highest level of the desired power, based on either an RF conducted or a radiated measurement.*

### TEST CONFIGURATION

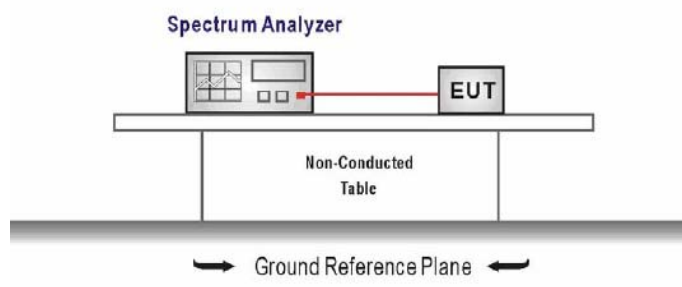

### TEST PROCEDURE

1. Connect the antenna port(s) to the spectrum analyzer input.
2. **Establish a reference level by using the following procedure**  
*Center frequency=DTS channel center frequency*  
*The span = 1.5 times the DTS bandwidth.*  
*RBW = 100 kHz, VBW ≥ 3 x RBW*  
*Detector = peak, Sweep time = auto couple, Trace mode = max hold*  
*Allow trace to fully stabilize*  
*Use the peak marker function to determine the maximum PSD level*

Note that the channel found to contain the maximum PSD level can be used to establish the reference level.

3. **Emission level measurement**  
Set the center frequency and span to encompass frequency range to be measured  
RBW = 100 kHz, VBW ≥ 3 x RBW  
Detector = peak, Sweep time = auto couple, Trace mode = max hold  
Allow trace to fully stabilize  
Use the peak marker function to determine the maximum amplitude level.
4. Place the radio in continuous transmit mode, allow the trace to stabilize, view the transmitter waveform on the spectrum analyzer.
5. Ensure that the amplitude of all unwanted emissions outside of the authorized frequency band excluding restricted frequency bands) are attenuated by at least the minimum requirements specified (at least 20 dB relative to the maximum in-band peak PSD level in 100 kHz). Report the three highest emissions relative to the limit.

### TEST RESULTS

Test plot as follows:

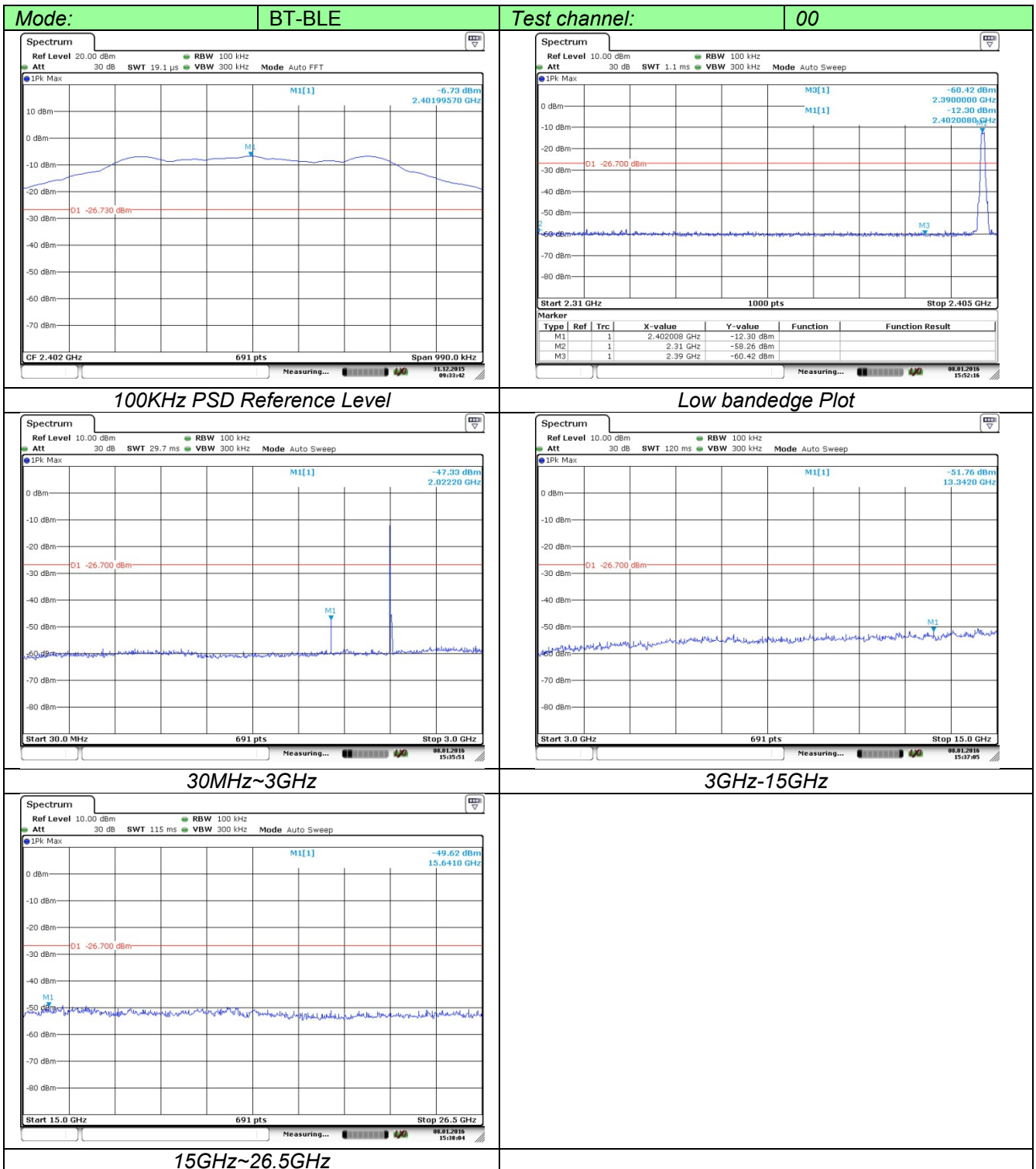

Mode: BT-BLE Test channel: 19

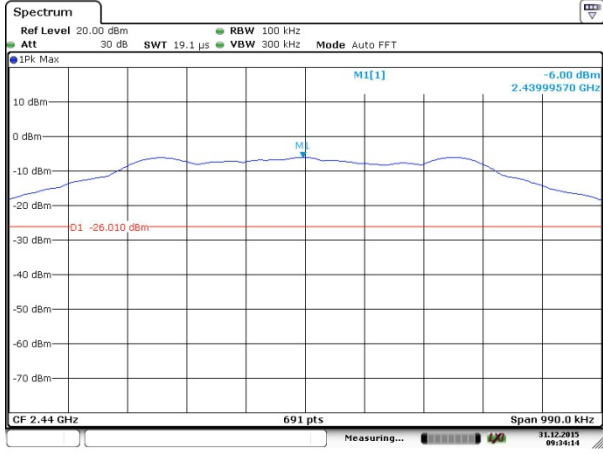

100KHz PSD Reference Level

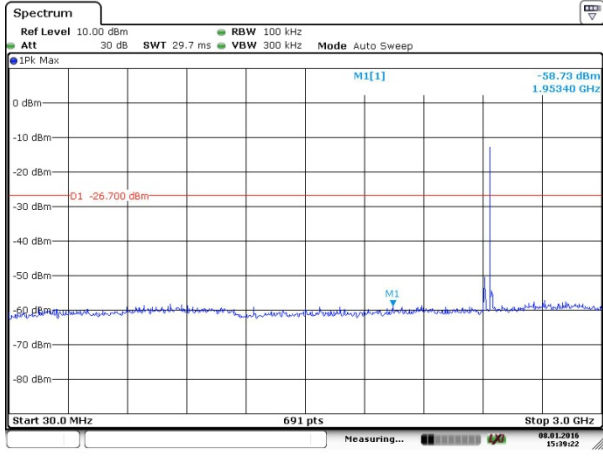

30MHz~3GHz

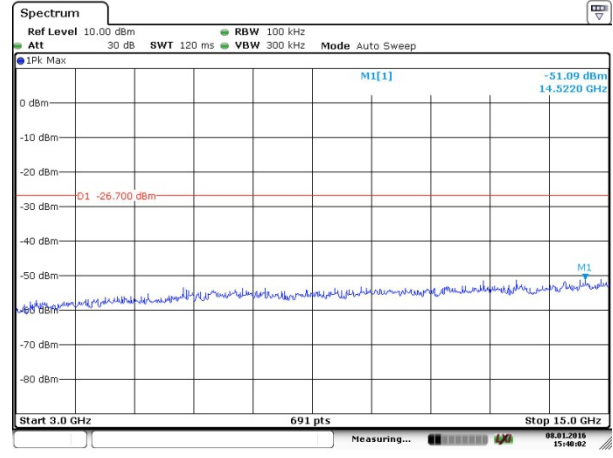

3GHz~15GHz

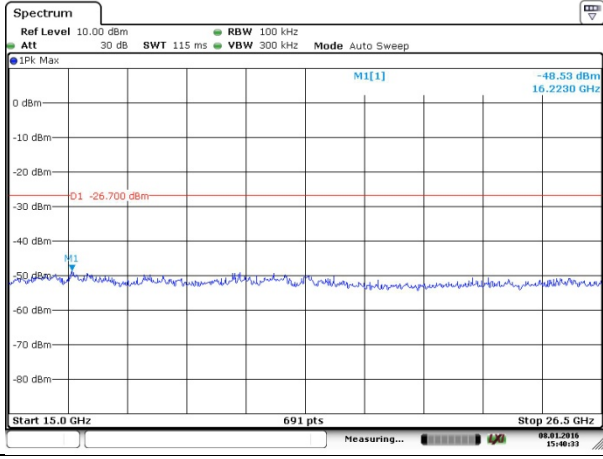

15GHz~26.5GHz

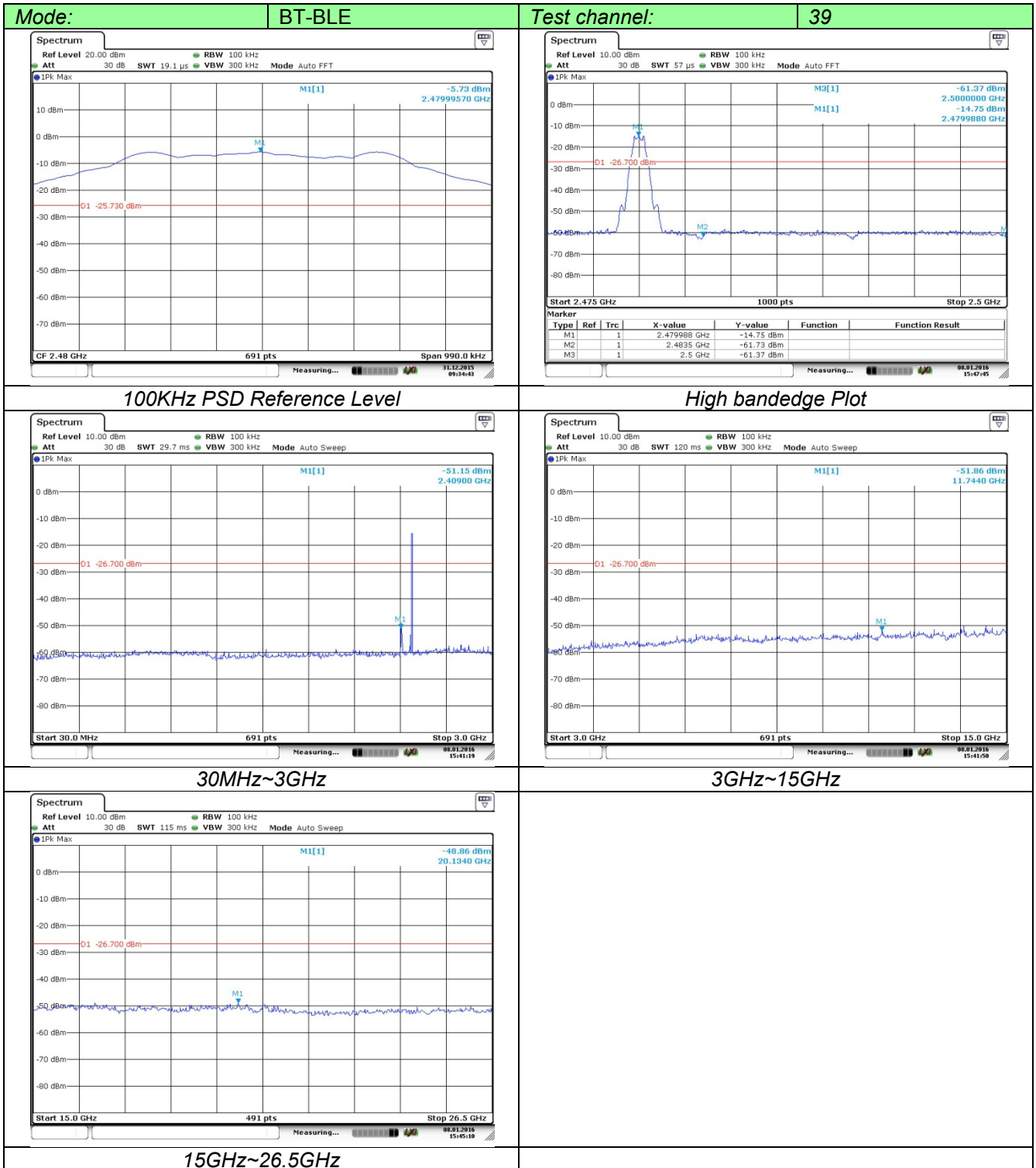

### 4.8. Spurious Emission (radiated)

#### LIMIT

FCC CFR Title 47 Part 15 Subpart C Section 15.209

Frequency	Limit (dBuV/m @3m)	Value
30MHz-88MHz	40.00	Quasi-peak
88MHz-216MHz	43.50	Quasi-peak
216MHz-960MHz	46.00	Quasi-peak
960MHz-1GHz	54.00	Quasi-peak
Above 1GHz	54.00	Average
	74.00	Peak

#### TEST CONFIGURATION

- 9KHz ~30MHz

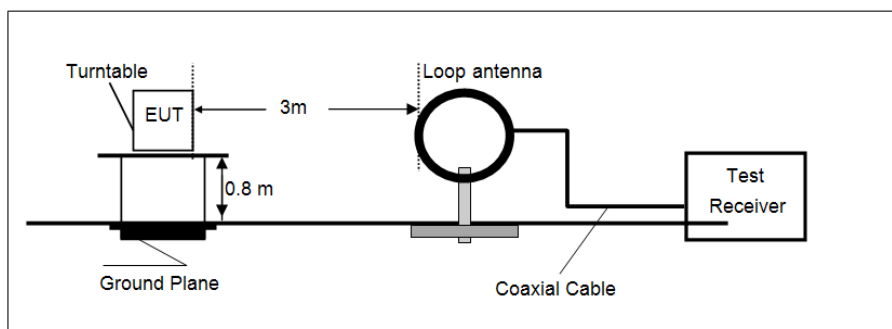

- 30MHz ~ 1GHz

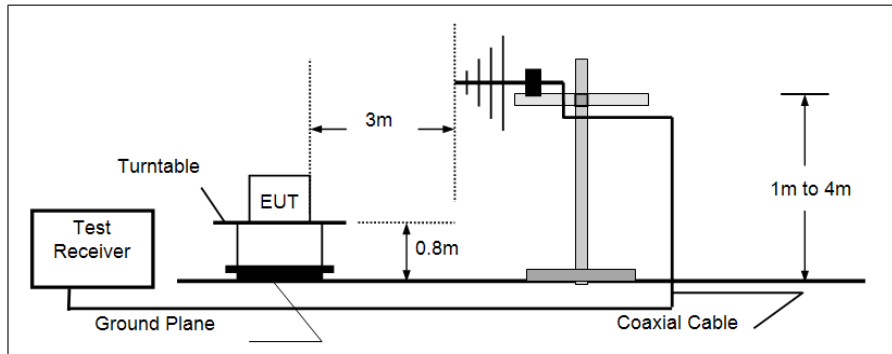

- Above 1GHz

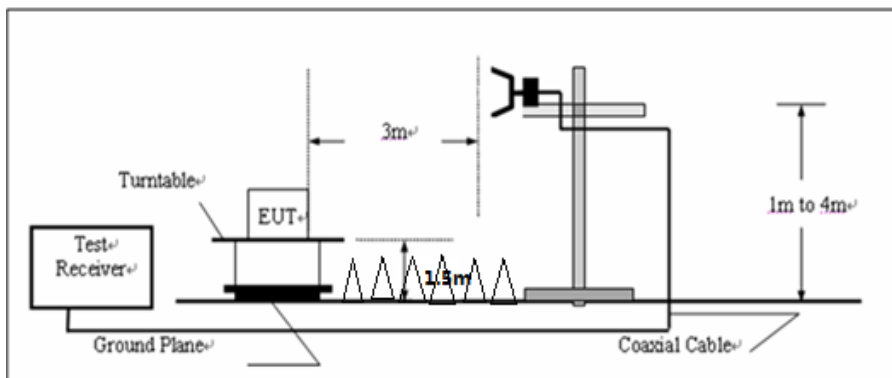



**TEST PROCEDURE**

1. The EUT was setup and tested according to ANSI C63.10:2013 for compliance to FCC 47CFR 15.247 requirements.
2. The EUT is placed on a turn table which is 0.8 meter above ground for below 1GHz, and 1.5m for above 1GHz. The turn table is rotated 360 degrees to determine the position of the maximum emission level.
3. The EUT was positioned such that the distance from antenna to the EUT was 3 meters.
4. The antenna is scanned from 1 meter to 4 meters to find out the maximum emission level. This is repeated for both horizontal and vertical polarization of the antenna. In order to find the maximum emission, all of the interface cables were manipulated according to ANSI C63.10:2013 on radiated measurement.
5. Use the following spectrum analyzer settings
  - (1) Span shall wide enough to fully capture the emission being measured;
  - (2) Below 1GHz, RBW=120KHz, VBW=300KHz, Sweep=auto, Detector function=peak, Trace=max hold;  
*If the emission level of the EUT measured by the peak detector is 3 dB lower than the applicable limit, the peak emission level will be reported. Otherwise, the emission measurement will be repeated using the quasi-peak detector and reported.*
  - (3) Above 1GHz, RBW=1MHz, VBW=3MHz for Peak value  
RBW=1MHz, VBW=10Hz for Average value.

**TEST RESULTS****Measurement data:****■ 9kHz ~ 30MHz**

The low frequency, which started from 9 kHz to 30MHz, was pre-scanned and the result which was 20dB lower than the limit line per 15.31(o) was not reported.

■ 30MHz ~ 1GHz

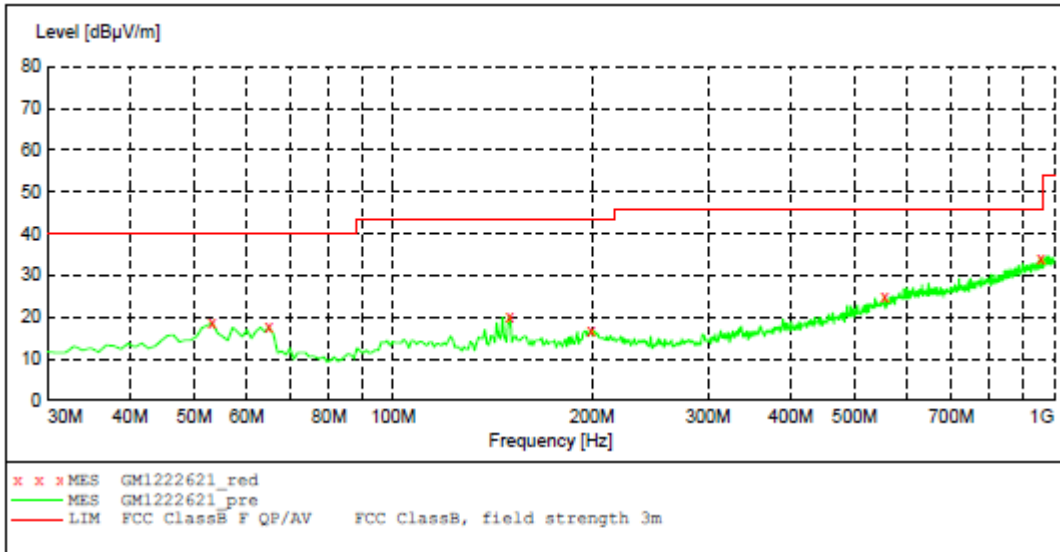

MEASUREMENT RESULT: "GM1222621\_red"

12/22/2015 1:41PM

Frequency MHz	Level dBµV/m	Transd dB	Limit dBµV/m	Margin dB	Det.	Height cm	Azimuth deg	Polarization
53.280000	18.60	-14.6	40.0	21.4	QP	300.0	85.00	HORIZONTAL
64.920000	17.60	-16.2	40.0	22.4	QP	300.0	70.00	HORIZONTAL
150.280000	20.20	-17.8	43.5	23.3	QP	300.0	142.00	HORIZONTAL
199.750000	16.80	-13.6	43.5	26.7	QP	100.0	269.00	HORIZONTAL
554.770000	24.90	-4.7	46.0	21.1	QP	100.0	269.00	HORIZONTAL
955.380000	34.20	3.7	46.0	11.8	QP	300.0	113.00	HORIZONTAL

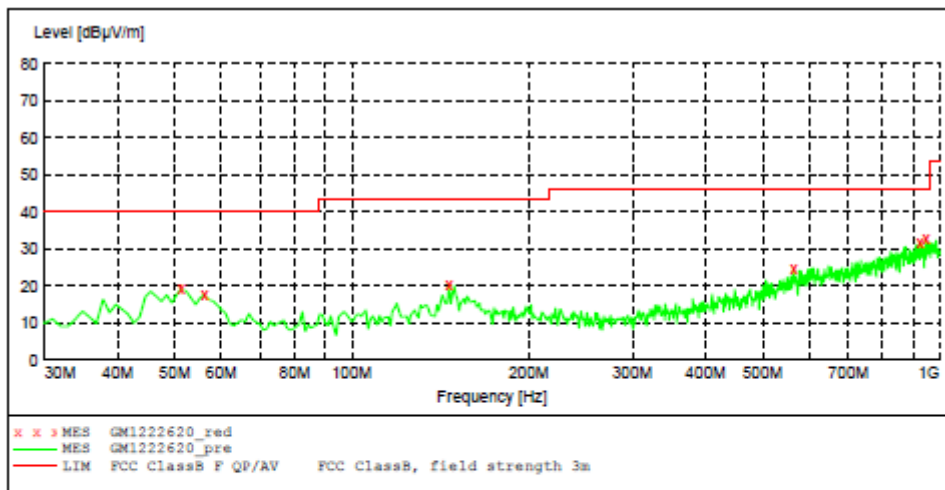

MEASUREMENT RESULT: "GM1222620\_red"

12/22/2015 1:38PM

Frequency MHz	Level dBµV/m	Transd dB	Limit dBµV/m	Margin dB	Det.	Height cm	Azimuth deg	Polarisation
51.340000	19.20	-14.4	40.0	20.8	QP	100.0	0.00	VERTICAL
56.190000	17.60	-14.8	40.0	22.4	QP	100.0	0.00	VERTICAL
146.400000	20.30	-16.0	43.5	23.2	QP	100.0	0.00	VERTICAL
565.440000	24.50	-4.2	46.0	21.5	QP	100.0	0.00	VERTICAL
925.310000	31.70	3.2	46.0	14.3	QP	100.0	0.00	VERTICAL
947.620000	32.60	3.6	46.0	13.4	QP	100.0	0.00	VERTICAL

■ Above 1GHz

CH00 for BT-BLE									
Frequency (MHz)	Read Level (dBuV)	Antenna Factor (dB/m)	Cable Loss (dB)	Preamp Factor (dB)	Level (dBuV/m)	Limit Line (dBuV/m)	Margin Limit (dB)	Polarization	Test value
4804	37.7	31.28	5.66	35.29	39.35	74	-34.65	Vertical	Peak
7206	35.84	36.22	6.87	35.15	43.78	74	-30.22	Vertical	
9608	36.49	37.85	8.8	35.55	47.59	74	-26.41	Vertical	
11265.24	*							Vertical	
4804	37.96	31.28	5.66	35.29	39.61	74	-34.39	Horizontal	
7206	36.38	36.22	6.87	35.15	44.32	74	-29.68	Horizontal	
9608	36.85	37.85	8.8	35.55	47.95	74	-26.05	Horizontal	
11265.24	*							Horizontal	
4804	32.93	31.28	5.66	35.29	34.58	54	-19.42	Vertical	Average
7206	29.69	36.22	6.87	35.15	37.63	54	-16.37	Vertical	
9608	28.38	37.85	8.8	35.55	39.48	54	-14.52	Vertical	
11265.24	*							Vertical	
4804	33.3	31.28	5.66	35.29	34.95	54	-19.05	Horizontal	
7206	29.9	36.22	6.87	35.15	37.84	54	-16.16	Horizontal	
9608	28.42	37.85	8.8	35.55	39.52	54	-14.48	Horizontal	
11265.24	*							Horizontal	
CH19 for BT-BLE									
Frequency (MHz)	Read Level (dBuV)	Antenna Factor (dB/m)	Cable Loss (dB)	Preamp Factor (dB)	Level (dBuV/m)	Limit Line (dBuV/m)	Margin Limit (dB)	Polarization	Test value
4880	38.2	31.26	5.65	35.27	39.84	74	-34.16	Vertical	Peak
7320	35.59	36.2	6.86	35.13	43.52	74	-30.48	Vertical	
9760	36.54	37.83	8.79	35.53	47.63	74	-26.37	Vertical	
12454.36	*							Vertical	
4880	37.83	31.26	5.65	35.27	39.47	74	-34.53	Horizontal	
7320	36.36	36.2	6.86	35.13	44.29	74	-29.71	Horizontal	
9760	36.56	37.83	8.79	35.53	47.65	74	-26.35	Horizontal	
12454.36	*							Horizontal	
4880	33.1	31.26	5.65	35.27	34.74	54	-19.26	Vertical	Average
7320	29.45	36.2	6.86	35.13	37.38	54	-16.62	Vertical	
9760	28.39	37.83	8.79	35.53	39.48	54	-14.52	Vertical	
12454.36	*							Vertical	
4880	32.88	31.26	5.65	35.27	34.52	54	-19.48	Horizontal	
7320	29.42	36.2	6.86	35.13	37.35	54	-16.65	Horizontal	
9760	27.99	37.83	8.79	35.53	39.08	54	-14.92	Horizontal	
12454.36	*							Horizontal	

## Remark:

- Final Level = Receiver Read level + Antenna Factor + Cable Loss – Pre-amplifier Factor
- "\*", means this data is too weak instrument of signal is unable to test.
- The emission levels of other frequencies are very lower than the limit and not show in test report.

CH39 for BT-BLE									
Frequency (MHz)	Read Level (dBuV)	Antenna Factor (dB/m)	Cable Loss (dB)	Preamp Factor (dB)	Level (dBuV/m)	Limit Line (dBuV/m)	Margin Limit (dB)	Polarization	Test value
4960	38.5	31.44	5.87	35.46	40.35	74	-33.65	Vertical	Peak
7440	34.94	36.38	7.08	35.32	43.08	74	-30.92	Vertical	
9920	35.94	38.01	9.01	35.72	47.24	74	-26.76	Vertical	
13452.57	*							Vertical	
4960	37.69	31.44	5.87	35.46	39.54	74	-34.46	Horizontal	
7440	35.51	36.38	7.08	35.32	43.65	74	-30.35	Horizontal	
9920	36.34	38.01	9.01	35.72	47.64	74	-26.36	Horizontal	
13452.57	*							Horizontal	
4960	33.11	31.42	5.87	35.46	34.94	54	-19.06	Vertical	Average
7440	29.4	36.36	7.08	35.32	37.52	54	-16.48	Vertical	
9920	28.58	37.99	9.01	35.72	39.86	54	-14.14	Vertical	
13452.57	*							Vertical	
4960	32.93	31.42	5.87	35.46	34.76	54	-19.24	Horizontal	
7440	29.73	36.36	7.08	35.32	37.85	54	-16.15	Horizontal	
9920	28.38	37.99	9.01	35.72	39.66	54	-14.34	Horizontal	
13452.57	*							Horizontal	

## Remark:

1. Final Level = Receiver Read level + Antenna Factor + Cable Loss – Pre-amplifier Factor
2. “\*”, means this data is too weak instrument of signal is unable to test.
3. The emission levels of other frequencies are very lower than the limit and not show in test report.

## 5. Test Setup Photos of the EUT

### Radiated Emission

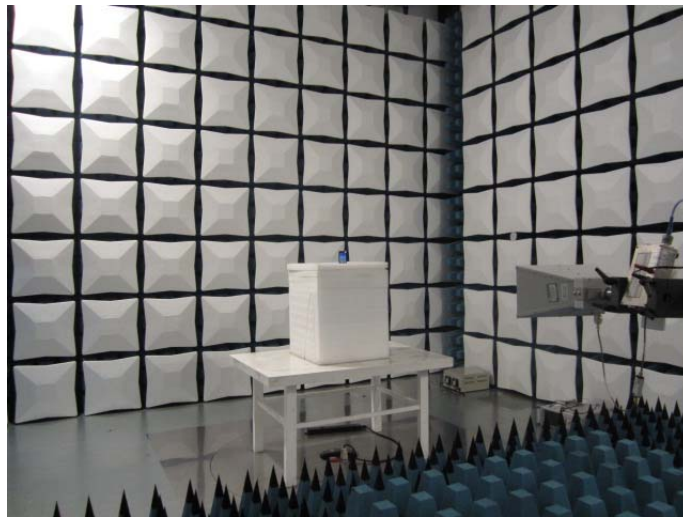
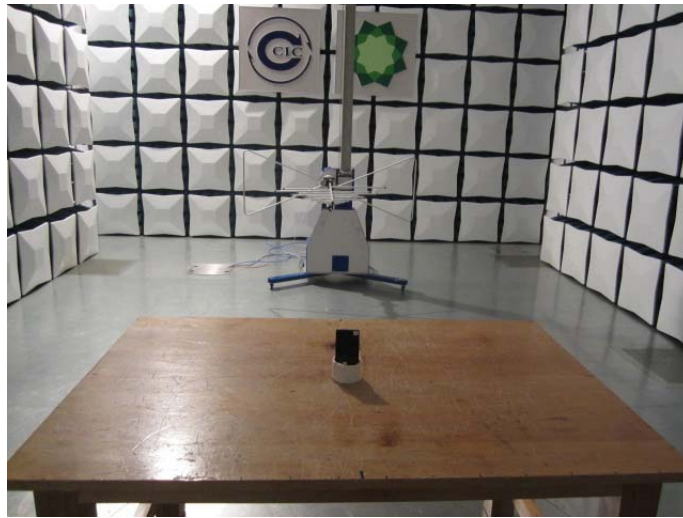

### Conducted Emission (AC Mains)



## **6. External and Internal Photos of the EUT**

*Reference to Test Report TRE1512011201*

.....End of Report.....