

FCC PART 22H, PART 24E

TEST REPORT

For

ITALCOM GROUP

1728 Coral Way, Coral Gables, Miami, Florida 518048, USA

FCC ID: YPVITALCOMKING-TV

| | |
|---|--|
| Report Type: Original Report | Product Type: GSM Mobile Phone |
| Test Engineer: Gardon Zhang | <i>Gardon Zhang</i> |
| Report Number: RSZ120925001-00C | |
| Report Date: 2012-10-18 | |
| Reviewed By: RF Leader | <i>Alvin Huang</i> |
| Test Laboratory: Bay Area Compliance Laboratories Corp. (Shenzhen) 6/F, the 3rd Phase of WanLi Industrial Building ShiHua Road, FuTian Free Trade Zone Shenzhen, Guangdong, China Tel: +86-755-33320018 Fax: +86-755-33320008 www.baclcorp.com.cn | |

Note: This test report is prepared for the customer shown above and for the device described herein. It may not be duplicated or used in part without prior written consent from Bay Area Compliance Laboratories Corp. This report **must not** be used by the customer to claim product certification, approval, or endorsement by NVLAP*, or any agency of the Federal Government.

* This report may contain data that are not covered by the NVLAP accreditation and shall be marked with an asterisk "★"

TABLE OF CONTENTS

GENERAL INFORMATION.....4

 PRODUCT DESCRIPTION FOR EQUIPMENT UNDER TEST (EUT)4

 OBJECTIVE4

 RELATED SUBMITTAL(S)/GRANT(S).....4

 TEST METHODOLOGY4

 TEST FACILITY5

SYSTEM TEST CONFIGURATION.....6

 DESCRIPTION OF TEST CONFIGURATION6

 EQUIPMENT MODIFICATIONS6

 BLOCK DIAGRAM OF TEST SETUP6

SUMMARY OF TEST RESULTS7

FCC §1.1307 & §2.1093 - RF EXPOSURE.....8

 APPLICABLE STANDARD8

 TEST RESULT8

FCC §2.1047 - MODULATION CHARACTERISTIC9

FCC §2.1046, §22.913 (A) & §24.232 (C) - RF OUTPUT POWER.....10

 APPLICABLE STANDARD10

 TEST PROCEDURE10

 TEST EQUIPMENT LIST AND DETAILS.....10

 TEST DATA11

FCC §2.1049, §22.917, §22.905 & §24.238 – EMISSION BANDWIDTH.....13

 APPLICABLE STANDARD13

 TEST PROCEDURE13

 TEST EQUIPMENT LIST AND DETAILS.....13

 TEST DATA13

FCC §2.1051, §22.917(A) & §24.238(A) - SPURIOUS EMISSIONS AT ANTENNA TERMINALS17

 APPLICABLE STANDARD17

 TEST PROCEDURE17

 TEST EQUIPMENT LIST AND DETAILS.....17

 TEST DATA17

FCC §2.1053, §22.917 & §24.238 - SPURIOUS RADIATED EMISSIONS19

 APPLICABLE STANDARD19

 TEST PROCEDURE19

 TEST EQUIPMENT LIST AND DETAILS.....19

 TEST DATA20

FCC §22.917(A) & §24.238(A) - BAND EDGES.....21

 APPLICABLE STANDARD21

 TEST PROCEDURE21

 TEST EQUIPMENT LIST AND DETAILS.....21

 TEST DATA21

FCC §2.1055, §22.355 & §24.235 - FREQUENCY STABILITY.....25

 APPLICABLE STANDARD25

TEST PROCEDURE25
TEST EQUIPMENT LIST AND DETAILS.....26
TEST DATA26

GENERAL INFORMATION

Product Description for Equipment under Test (EUT)

The *ITALCOM GROUP*'s product, model number: *king-tv* (FCC ID: *YPVITALCOMKING-TV*) or the "EUT" in this report was a *Mobile Phone*, which was measured approximately: 10.7 cm (L) x 6.0 cm (W) x 1.4 cm (H), rated input voltage: DC 3.7 V Li-ion battery.

** All measurement and test data in this report was gathered from production sample serial number: 1209116 (Assigned by BACL, Shenzhen). The EUT supplied by the applicant was received on 2012-09-25.*

Objective

This test report is prepared on behalf of *ITALCOM GROUP* in accordance with Part 2-Subpart J, Part 22-Subpart H, and Part 24-Subpart E of the Federal Communication Commissions rules.

The objective is to determine the compliance of the EUT with FCC rules for output power, modulation characteristic, occupied bandwidth, and spurious emission at antenna terminal, spurious radiated emission, frequency stability and band edge.

Related Submittal(s)/Grant(s)

FCC Part 15.247 DSS and Part 15B JBP submissions with FCC ID: *YPVITALCOMKING-TV*.

Test Methodology

All tests and measurements indicated in this document were performed in accordance with the Code of Federal Regulations Title 47 Part 2-Subpart J as well as the following parts:

Part 22 Subpart H - Public Mobile Services
Part 24 Subpart E - Personal Communication Services

Applicable Standards: TIA/EIA 603-D, ANSI C63.4-2009.

All radiated and conducted emissions measurements were performed at Bay Area Compliance Laboratories Corp. The radiated testing was performed at an antenna-to-EUT distance of 3 meters.

Test Facility

The Test site used by Bay Area Compliance Laboratories Corp.(Shenzhen) to collect test data is located on the 6/F, the 3rd Phase of WanLi Industrial Building, ShiHua Road, FuTian Free Trade Zone Shenzhen, Guangdong, China.

Test site at Bay Area Compliance Laboratories Corp. (Shenzhen) has been fully described in reports submitted to the Federal Communication Commission (FCC). The details of these reports have been found to be in compliance with the requirements of Section 2.948 of the FCC Rules on December 06, 2010. The facility also complies with the radiated and AC line conducted test site criteria set forth in ANSI C63.4-2009.

The Federal Communications Commission has the reports on file and is listed under FCC Registration No.: 382179. The test site has been approved by the FCC for public use and is listed in the FCC Public Access Link (PAL) database.

Additionally, Bay Area Compliance Laboratories Corp. (Shenzhen) is an ISO/IEC 17025 accredited laboratory, and is accredited by National Voluntary Laboratory Accredited Program (Lab Code 200707-0).



The current scope of accreditations can be found at <http://ts.nist.gov/Standards/scopes/2007070.htm>

SYSTEM TEST CONFIGURATION

Description of Test Configuration

The EUT was configured for testing according to TIA/EIA-603-D.

The GSM/PCS item test was performed with the EUT operating at normal mode.

Equipment Modifications

No modification was made to the EUT.

Block Diagram of Test Setup

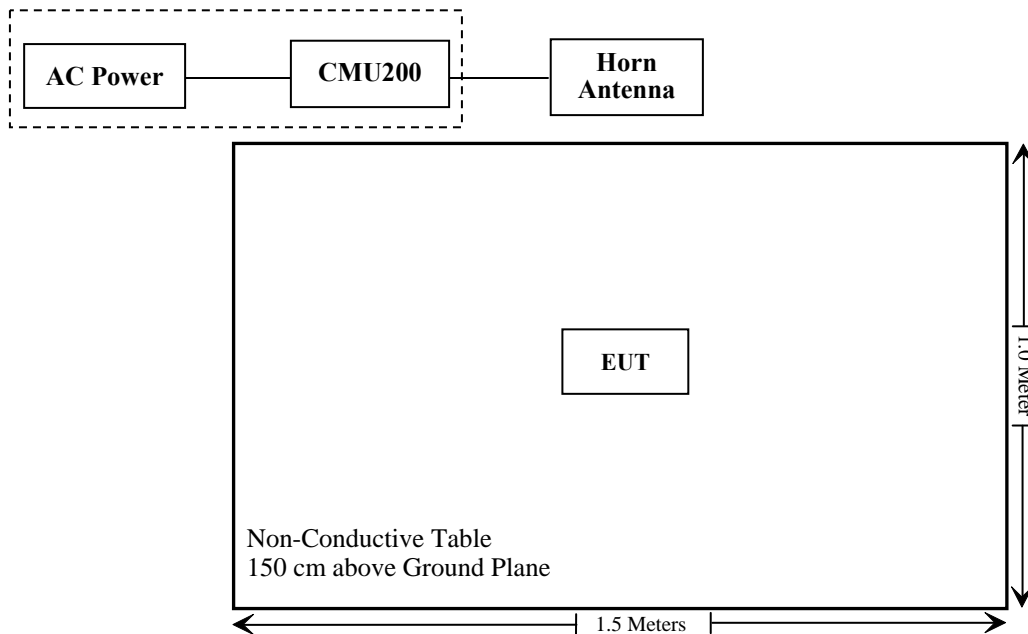

SUMMARY OF TEST RESULTS

| FCC Rules | Description of Test | Result |
|--|--|----------------|
| §1.1307, §2.1093 | RF Exposure (SAR) | Compliance* |
| §2.1046; § 22.913 (a); § 24.232 (c) | RF Output Power | Compliance |
| § 2.1047 | Modulation Characteristics | Not Applicable |
| § 2.1049; § 22.905 § 22.917; § 24.238 | Emission Bandwidth | Compliance |
| § 2.1051, § 22.917 (a); § 24.238 (a) | Spurious Emissions at Antenna Terminal | Compliance |
| § 2.1053 § 22.917 (a); § 24.238 (a) | Field Strength of Spurious Radiation | Compliance |
| § 22.917 (a); § 24.238 (a) | Out of band emission, Band Edge | Compliance |
| § 2.1055 § 22.355; § 24.235 | Frequency stability vs. temperature Frequency stability vs. voltage | Compliance |

Note: * Please refer to SAR report released by BACL, report number: RSZ120925001-20.

FCC §1.1307 & §2.1093 - RF EXPOSURE

Applicable Standard

FCC§1.1307 and §2.1093.

Test Result

Compliance, please refer to the SAR report: RSZ120925001-20.

FCC §2.1047 - MODULATION CHARACTERISTIC

According to FCC §2.1047(d), Part 22H & 24E there is no specific requirement for digital modulation, therefore modulation characteristic is not presented.

FCC §2.1046, §22.913 (a) & §24.232 (c) - RF OUTPUT POWER

Applicable Standard

According to FCC §2.1046 and §22.913 (a), the ERP of mobile transmitters and auxiliary test transmitters must not exceed 7 watts.

According to FCC §2.1046 and §24.232 (C), mobile and portable stations are limited to 2 watts EIRP and the equipment must employ a means for limiting power to the minimum necessary for successful communications..

Test Procedure

Conducted method:

The RF output of the transmitter was connected to the wireless test set and the spectrum analyzer through sufficient attenuation.

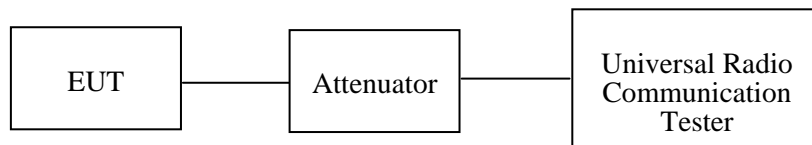

Radiated method:

TIA 603-D section 2.2.17

Test Equipment List and Details

| Manufacturer | Description | Model | Serial Number | Calibration Date | Calibration Due Date |
|-----------------|--------------------------------------|-------------|---------------|------------------|----------------------|
| Sunol Sciences | Horn Antenna | DRH-118 | A052304 | 2011-12-01 | 2012-11-30 |
| Rohde & Schwarz | Signal Analyzer | FSIQ26 | 8386001028 | 2011-11-24 | 2012-11-23 |
| Sunol Sciences | Broadband Antenna | JB1 | A040904-2 | 2011-11-28 | 2012-11-27 |
| HP | Synthesized Sweeper | 8341B | 2624A00116 | 2012-04-11 | 2013-04-10 |
| COM POWER | Dipole Antenna | AD-100 | 041000 | 2012-06-06 | 2013-06-05 |
| A.H. System | Horn Antenna | SAS-200/571 | 135 | 2012-02-11 | 2013-02-10 |
| Rohde & Schwarz | Universal Radio Communication Tester | CMU200 | 109038 | 2012-04-11 | 2013-04-10 |

* **Statement of Traceability:** Bay Area Compliance Laboratories Corp. (Shenzhen) attests that all calibrations have been performed in accordance to NVLAP requirements, traceable to the NIST.

Test Data**Environmental Conditions**

| | |
|---------------------------|-----------|
| Temperature: | 25 °C |
| Relative Humidity: | 56 % |
| ATM Pressure: | 100.0 kPa |

The testing was performed by Gardon Zhang on 2012-09-26..

Conducted Power:

Cellular Band (Part 22H)

| Mode | Channel | Frequency (MHz) | Peak Output Power (dBm) | Limit (dBm) |
|------|---------|-----------------|-------------------------|-------------|
| GSM | 128 | 824.2 | 32.33 | 38.45 |
| | 190 | 836.6 | 32.36 | 38.45 |
| | 251 | 848.8 | 32.52 | 38.45 |

PCS Band (Part 24E)

| Mode | Channel | Frequency (MHz) | Peak Output Power (dBm) | Limit (dBm) |
|------|---------|-----------------|-------------------------|-------------|
| GSM | 512 | 1850.2 | 30.58 | 33 |
| | 661 | 1880.0 | 30.50 | 33 |
| | 810 | 1909.8 | 30.44 | 33 |

Radiated Power:

ERP for Cellular Band (Part 22H)

| Frequency (MHz) | Receiver Reading (dBµV) | Turntable Angle Degree | Rx Antenna | | Substituted | | | Absolute Level (dBm) | Part 22H Limit (dBm) |
|-----------------|-------------------------|------------------------|------------|-------------|----------------|-----------------|-------------------|----------------------|----------------------|
| | | | Height (m) | Polar (H/V) | SG Level (dBm) | Cable Loss (dB) | Antenna Gain (dB) | | |
| High Channel | | | | | | | | | |
| 848.8 | 89.16 | 125 | 1.8 | H | 21.3 | 0.69 | 0.0 | 20.61 | 38.45 |
| 848.8 | 98.23 | 14 | 1.6 | V | 30.9 | 0.69 | 0.0 | 30.21 | 38.45 |

EIRP for PCS Band (Part 24E)

| Frequency (MHz) | Receiver Reading (dBµV) | Turntable Angle Degree | Rx Antenna | | Substituted | | | Absolute Level (dBm) | Part 24E Limit (dBm) |
|-----------------|-------------------------|------------------------|------------|-------------|----------------|-----------------|-------------------|----------------------|----------------------|
| | | | Height (m) | Polar (H/V) | SG Level (dBm) | Cable Loss (dB) | Antenna Gain (dB) | | |
| Low Channel | | | | | | | | | |
| 1850.2 | 82.39 | 69 | 1.8 | H | 8.3 | 1.03 | 9.4 | 16.67 | 33 |
| 1850.2 | 89.25 | 32 | 1.6 | V | 20.3 | 1.03 | 9.4 | 28.67 | 33 |

Note: Absolute Level = SG Level - Cable loss + Antenna Gain
 Margin = Limit-Absolute Level

FCC §2.1049, §22.917, §22.905 & §24.238 – EMISSION BANDWIDTH

Applicable Standard

FCC §2.1049, §22.917, §22.905 and §24.238.

Test Procedure

The RF output of the transmitter was connected to the simulator and the spectrum analyzer through sufficient attenuation.

The resolution bandwidth of the spectrum analyzer was set at 3 kHz (Cellular /PCS) and the 26 dB & 99% bandwidth was recorded.

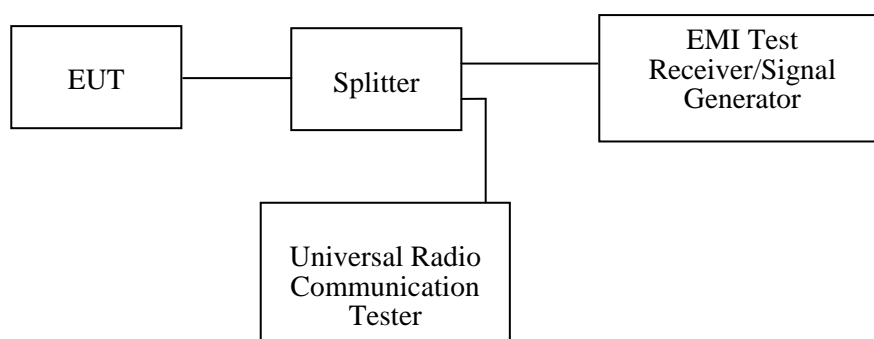

Test Equipment List and Details

| Manufacturer | Description | Model | Serial Number | Calibration Date | Calibration Due Date |
|-----------------|--------------------------------------|--------|---------------|------------------|----------------------|
| Rohde & Schwarz | Signal Analyzer | FSIQ26 | 8386001028 | 2011-11-24 | 2012-11-23 |
| Rohde & Schwarz | Universal Radio Communication Tester | CMU200 | 109038 | 2012-04-11 | 2013-04-10 |

* **Statement of Traceability:** Bay Area Compliance Laboratories Corp. (Shenzhen) attests that all calibrations have been performed in accordance to NVLAP requirements, traceable to the NIST.

Test Data

Environmental Conditions

| | |
|--------------------|-----------|
| Temperature: | 25 °C |
| Relative Humidity: | 56 % |
| ATM Pressure: | 100.0 kPa |

The testing was performed by Gardon Zhang on 2012-09-26.

EUT operation mode: Transmitting

Test Result: Compliance. Please refer to the following tables and plots.

GMSK Modulation:

Cellular Band (Part 22H)

| Channel | Frequency (MHz) | 99% Occupied Bandwidth (kHz) | 26 dB Bandwidth (kHz) |
|---------|-----------------|------------------------------|-----------------------|
| 190 | 836.6 | 246.49 | 320.64 |

PCS Band (Part 24E)

| Channel | Frequency (MHz) | 99% Occupied Bandwidth (kHz) | 26 dB Bandwidth (kHz) |
|---------|-----------------|------------------------------|-----------------------|
| 661 | 1880.0 | 244.49 | 318.64 |

Cellular Band (Part 22H)

99% Occupied Bandwidth

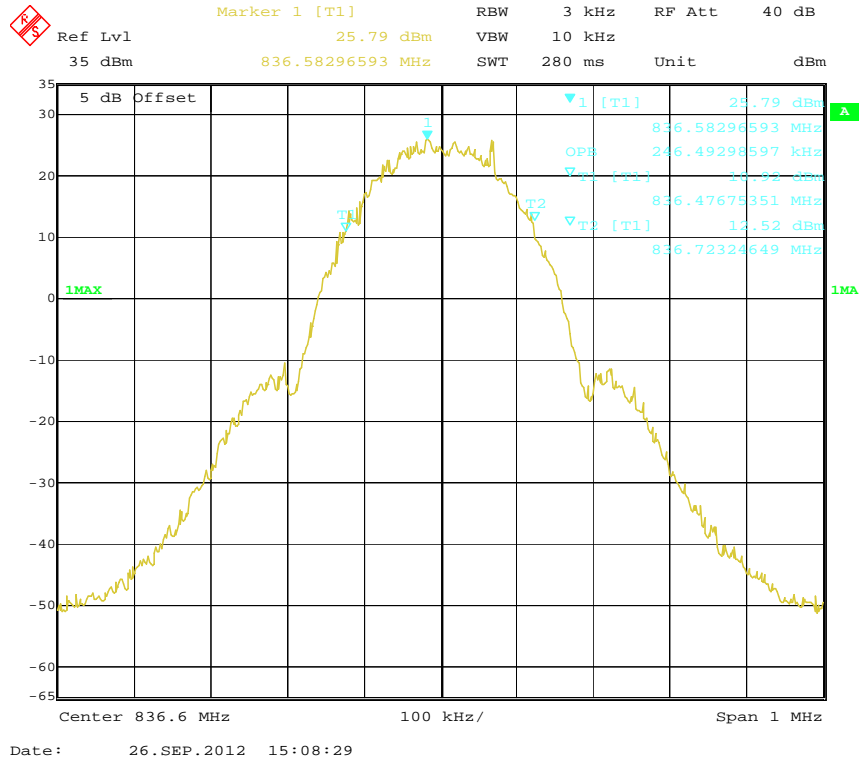

26 dB Bandwidth

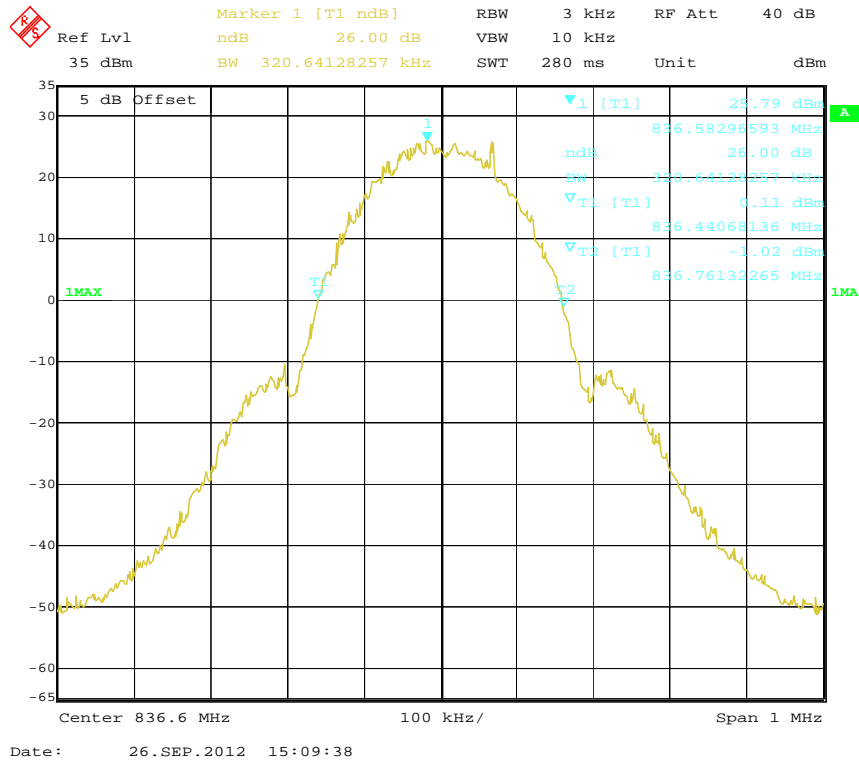

PCS Band (Part 24E)

99% Occupied Bandwidth

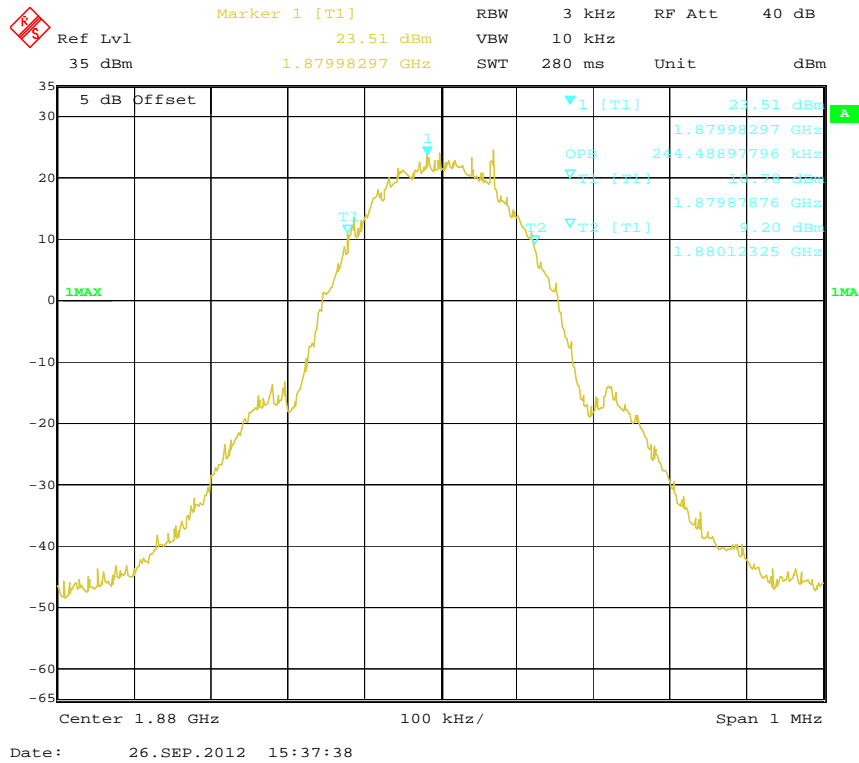

26 dB Bandwidth

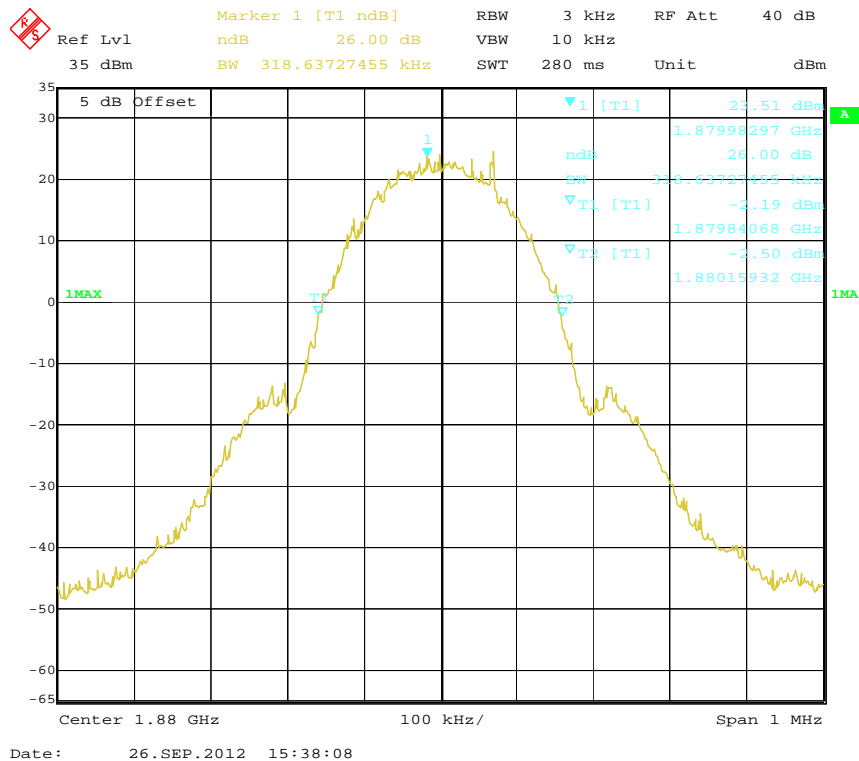

FCC §2.1051, §22.917(a) & §24.238(a) - SPURIOUS EMISSIONS AT ANTENNA TERMINALS

Applicable Standard

FCC §2.1051, §22.917(a) and §24.238(a).

The spectrum was to be investigated to the tenth harmonics of the highest fundamental frequency as specified in § 2.1051.

Test Procedure

The RF output of the transceiver was connected to a spectrum analyzer and simulator through appropriate attenuation. The resolution bandwidth of the spectrum analyzer was set at 1MHz. Sufficient scans were taken to show any out of band emissions up to 10th harmonic.

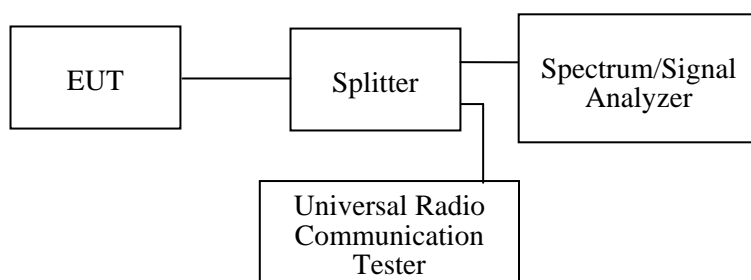

Test Equipment List and Details

| Manufacturer | Description | Model | Serial Number | Calibration Date | Calibration Due Date |
|-----------------|--------------------------------------|--------|---------------|------------------|----------------------|
| Rohde & Schwarz | Universal Radio Communication Tester | CMU200 | 109038 | 2012-04-11 | 2013-04-10 |
| Rohde & Schwarz | Signal Analyzer | FSIQ26 | 8386001028 | 2011-11-24 | 2012-11-23 |

* **Statement of Traceability:** Bay Area Compliance Laboratories Corp. (Shenzhen) attests that all calibrations have been performed in accordance to NVLAP requirements, traceable to the NIST.

Test Data

Environmental Conditions

| | |
|--------------------|-----------|
| Temperature: | 25 °C |
| Relative Humidity: | 55 % |
| ATM Pressure: | 100.0 kPa |

The testing was performed by Gardon Zhang on 2012-09-27.

Please refer to the following plots.

Cellular Band (Part 22H)

30 MHz – 10 GHz - Middle Channel

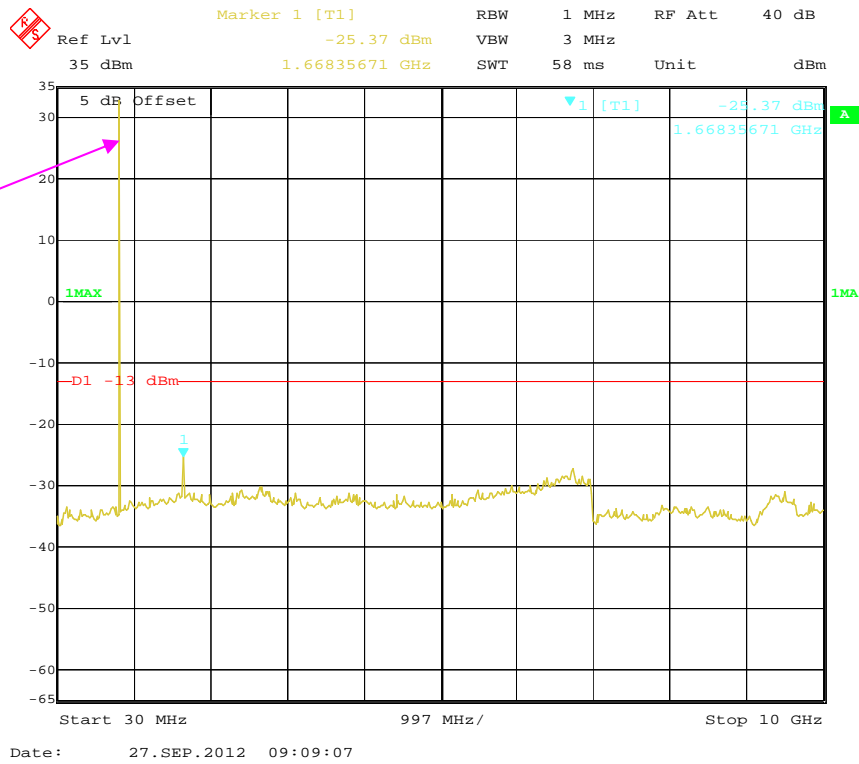

Fundamental

PCS Band (Part 24E)

30 MHz – 20 GHz - Middle Channel

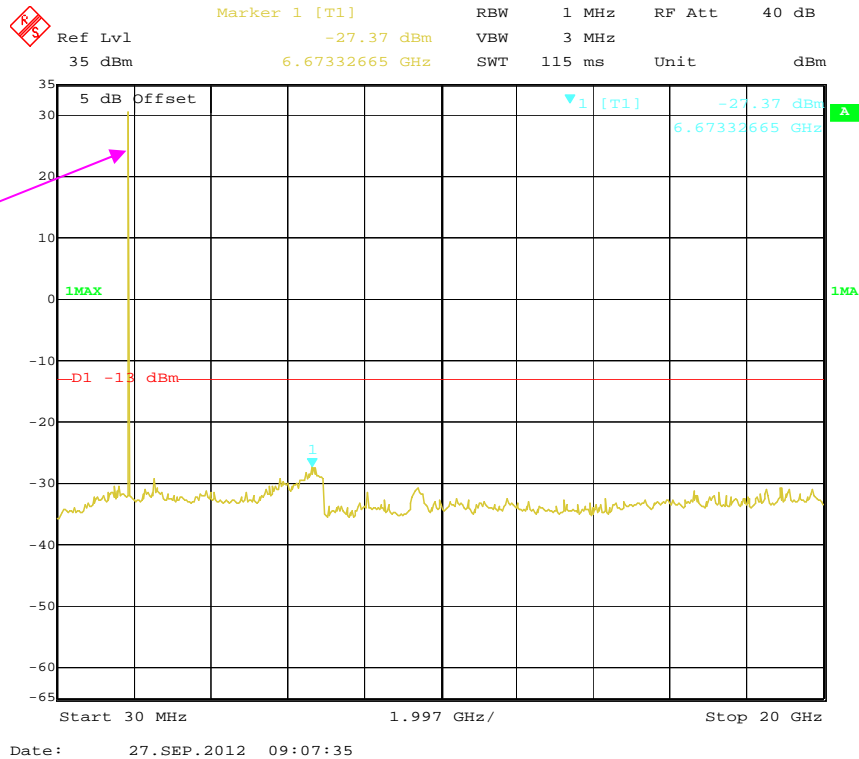

Fundamental

FCC §2.1053, §22.917 & §24.238 - SPURIOUS RADIATED EMISSIONS

Applicable Standard

FCC § 2.1053, §22.917 and § 24.238.

Test Procedure

The transmitter was placed on a wooden turntable, and it was transmitting into a non-radiating load which was also placed on the turntable.

The measurement antenna was placed at a distance of 3 meters from the EUT. During the tests, the receiving antenna height and polarization as well as EUT azimuth were varied in order to identify the maximum level of emissions from the EUT. The test was performed by placing the EUT on 3-orthogonal axis.

The frequency range up to tenth harmonic of the fundamental frequency was investigated.

Remove the EUT and replace it with substitution antenna. A signal generator was connected to the substitution antenna by a non-radiating cable. The absolute levels of the spurious emissions were measured by the substitution.

Spurious emissions in dB = 10 lg (TXpwr in Watts/0.001) – the absolute level

Spurious attenuation limit in dB = 43 + 10 Log₁₀ (power out in Watts)

Test Equipment List and Details

| Manufacturer | Description | Model | Serial Number | Calibration Date | Calibration Due Date |
|-------------------|--------------------------------------|-------------|---------------|------------------|----------------------|
| Sunol Sciences | Horn Antenna | DRH-118 | A052304 | 2011-12-01 | 2012-11-30 |
| Sunol Sciences | Broadband Antenna | JB1 | A040904-2 | 2011-11-28 | 2012-11-27 |
| Rohde & Schwarz | Signal Analyzer | FSIQ26 | 8386001028 | 2011-11-24 | 2012-11-23 |
| SUPER ULTRA | Amplifier | ZVA-213+ | N/A | 2011-11-24 | 2012-11-23 |
| HP | Amplifier | HP8447D | 2944A09795 | 2011-11-24 | 2012-11-23 |
| HP | Synthesized Sweeper | 8341B | 2624A00116 | 2012-04-11 | 2013-04-10 |
| COM POWER | Dipole Antenna | AD-100 | 041000 | 2012-06-06 | 2013-06-05 |
| A.H. System | Horn Antenna | SAS-200/571 | 135 | 2012-02-11 | 2013-02-10 |
| Electro-Mechanics | Horn Antenna | 3116 | 9510-2270 | 2011-10-14 | 2012-10-13 |
| Rohde & Schwarz | Universal Radio Communication Tester | CMU200 | 109038 | 2012-04-11 | 2013-04-10 |

* **Statement of Traceability:** Bay Area Compliance Laboratories Corp. (Shenzhen) attests that all calibrations have been performed in accordance to NVLAP requirements, traceable to the NIST.

Test Data**Environmental Conditions**

| | |
|---------------------------|-----------|
| Temperature: | 25 °C |
| Relative Humidity: | 55 % |
| ATM Pressure: | 100.0 kPa |

The testing was performed by Gardon Zhang on 2012-09-27.

EUT operation mode: Transmitting (worst case)

30 MHz ~ 10 GHz:

Cellular Band (Part 22H)

| Frequency (MHz) | Receiver Reading (dBμV) | Turntable Angle Degree | Rx Antenna | | Substituted | | | Absolute Level (dBm) | FCC Part 22H | |
|----------------------------|-------------------------|------------------------|------------|-------------|----------------|-----------------|-------------------|----------------------|--------------|-------------|
| | | | Height (m) | Polar (H/V) | SG Level (dBm) | Cable Loss (dB) | Antenna Gain (dB) | | Limit (dBm) | Margin (dB) |
| Middle Channel (836.6 MHz) | | | | | | | | | | |
| 515.7 | 41.26 | 87 | 1.6 | V | -56.0 | 0.49 | 0.0 | -56.49 | -13 | 43.49 |
| 1673.2 | 57.56 | 85 | 1.6 | H | -45.5 | 0.97 | 9.4 | -37.07 | -13 | 24.07 |
| 1673.2 | 61.5 | 86 | 1.8 | V | -39.0 | 0.97 | 9.4 | -30.57 | -13 | 17.57 |
| 2509.8 | 61.68 | 235 | 1.6 | H | -39.0 | 1.46 | 10.7 | -29.76 | -13 | 16.76 |
| 2509.8 | 64.79 | 2 | 1.8 | V | -31.6 | 1.46 | 10.7 | -22.36 | -13 | 9.36 |
| 3346.4 | 43.69 | 56 | 1.6 | H | -50.7 | 2.08 | 10.8 | -41.98 | -13 | 28.98 |
| 3346.4 | 47.36 | 95 | 1.9 | V | -46.2 | 2.08 | 10.8 | -37.48 | -13 | 24.48 |

30 MHz ~ 20 GHz:

PCS Band (Part 24E)

| Frequency (MHz) | Receiver Reading (dBμV) | Turntable Angle Degree | Rx Antenna | | Substituted | | | Absolute Level (dBm) | FCC Part 24E | |
|-----------------------------|-------------------------|------------------------|------------|-------------|----------------|-----------------|-------------------|----------------------|--------------|-------------|
| | | | Height (m) | Polar (H/V) | SG Level (dBm) | Cable Loss (dB) | Antenna Gain (dB) | | Limit (dBm) | Margin (dB) |
| Middle Channel (1880.0 MHz) | | | | | | | | | | |
| 518.4 | 39.68 | 44 | 1.8 | V | -57.6 | 0.49 | 0.0 | -58.09 | -13 | 45.09 |
| 3760.0 | 43.69 | 26 | 1.8 | H | -53.3 | 2.96 | 10.4 | -45.86 | -13 | 32.86 |
| 3760.0 | 43.28 | 9 | 1.6 | V | -52.9 | 2.96 | 10.4 | -45.46 | -13 | 32.46 |
| 5640.0 | 53.71 | 4 | 1.8 | H | -38.7 | 3.94 | 11.7 | -30.94 | -13 | 17.94 |
| 5640.0 | 53.75 | 12 | 1.6 | V | -37.4 | 3.94 | 11.7 | -29.64 | -13 | 16.64 |
| 7520.0 | 40.18 | 155 | 1.8 | H | -48.1 | 3.07 | 12.0 | -39.17 | -13 | 26.17 |
| 7520.0 | 40.26 | 236 | 1.6 | V | -49.2 | 3.07 | 12.0 | -40.27 | -13 | 27.27 |

FCC §22.917(a) & §24.238(a) - BAND EDGES

Applicable Standard

According to § 22.917(a), the power of any emissions outside of the authorized operating frequency ranges must be attenuated below the transmitting power (P) by a factor of at least $43 + 10 \log(P)$ dB.

According to §24.238(a), the power of any emissions outside of the authorized operating frequency ranges must be attenuated below the transmitting power (P) by a factor of at least $43 + 10 \log(P)$ dB.

Test Procedure

The RF output of the transmitter was connected to the input of the spectrum analyzer through sufficient attenuation.

The center of the spectrum analyzer was set to block edge frequency, RBW set to 5 kHz.

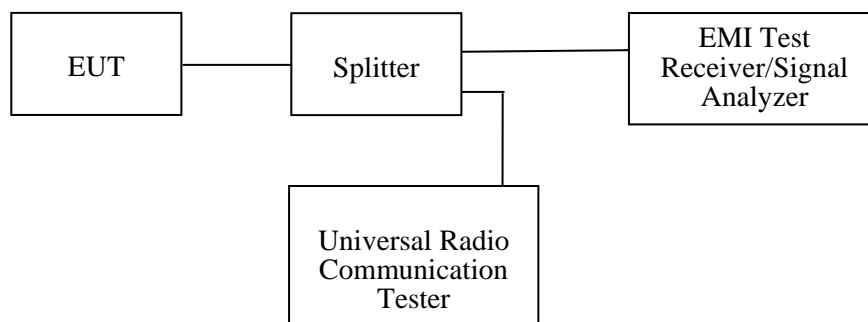

Test Equipment List and Details

| Manufacturer | Description | Model | Serial Number | Calibration Date | Calibration Due Date |
|-----------------|--------------------------------------|--------|---------------|------------------|----------------------|
| Rohde & Schwarz | Signal Analyzer | FSIQ26 | 8386001028 | 2011-11-24 | 2012-11-23 |
| Rohde & Schwarz | Universal Radio Communication Tester | CMU200 | 109038 | 2012-04-11 | 2013-04-10 |

* **Statement of Traceability:** Bay Area Compliance Laboratories Corp. (Shenzhen) attests that all calibrations have been performed in accordance to NVLAP requirements, traceable to the NIST.

Test Data

Environmental Conditions

| | |
|--------------------|-----------|
| Temperature: | 25 °C |
| Relative Humidity: | 56 % |
| ATM Pressure: | 100.0 kPa |

The testing was performed by Gardon Zhang on 2012-09-26.

EUT operation mode: Transmitting

Test Result: Compliance. Please refer to the following tables and plots.

Cellular Band (Part 22H)

| Frequency (MHz) | Emission (dBm) | Limit (dBm) |
|-----------------|----------------|-------------|
| 823.978 | -14.22 | <-13 |
| 849.018 | -13.83 | <-13 |

PCS Band (Part 24E)

| Frequency (MHz) | Emission (dBm) | Limit (dBm) |
|-----------------|----------------|-------------|
| 1849.998 | -14.32 | <-13 |
| 1910.022 | -16.53 | <-13 |

Cellular Band, Left Band Edge

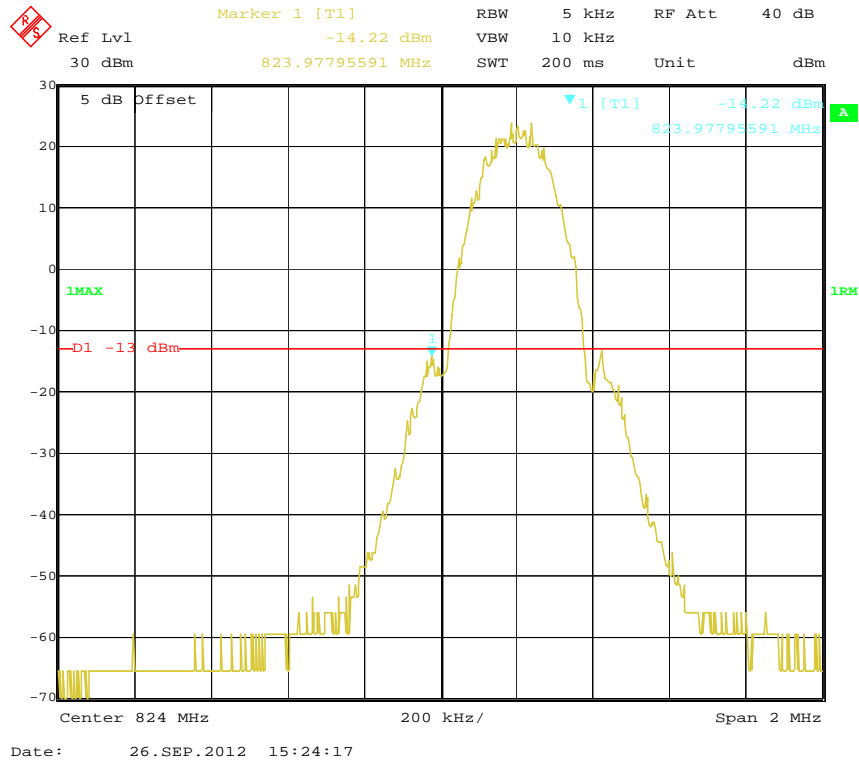

Cellular Band, Right Band Edge

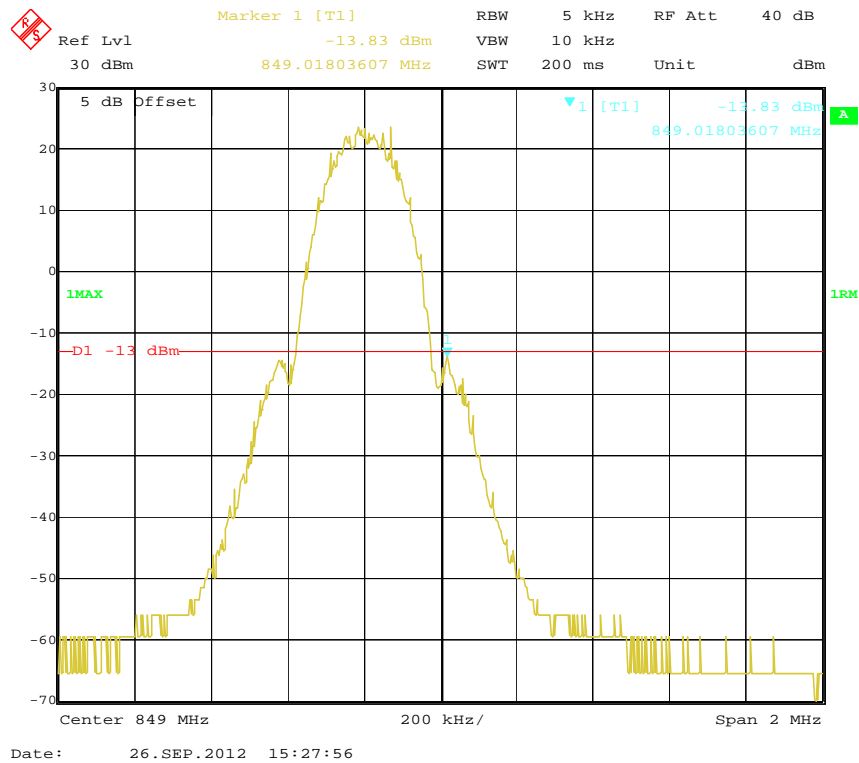

PCS Band, Left Band Edge

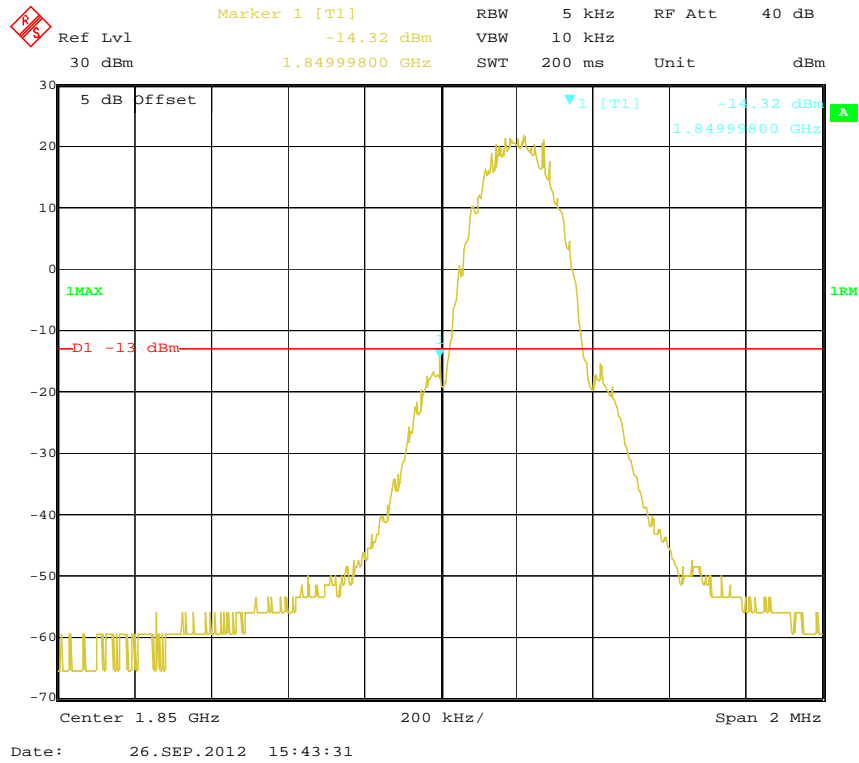

PCS Band, Right Band Edge

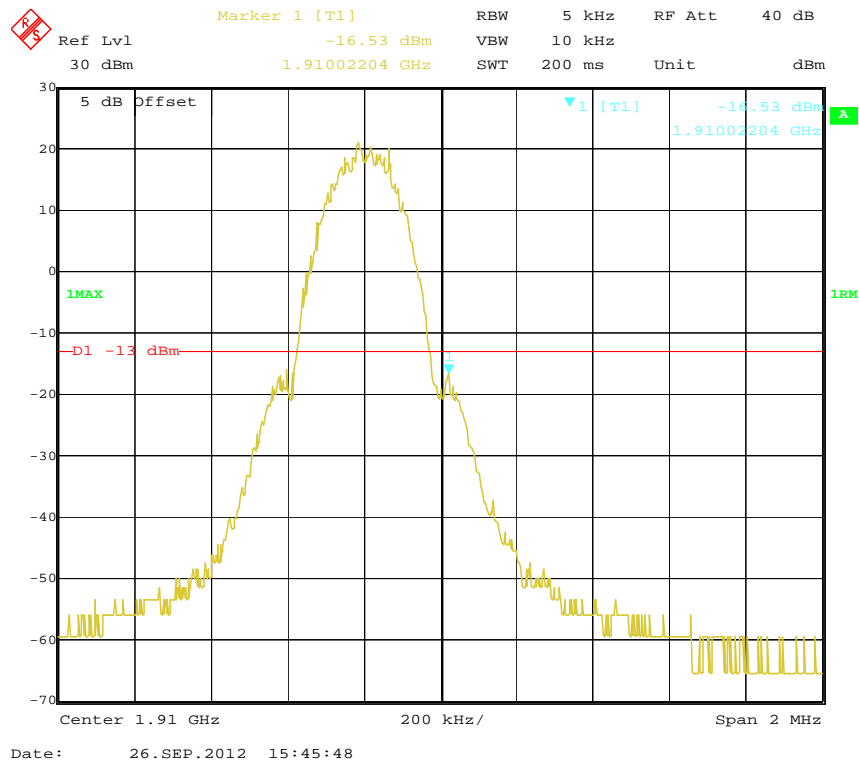

FCC §2.1055, §22.355 & §24.235 - FREQUENCY STABILITY

Applicable Standard

FCC § 2.1055 (a), § 2.1055 (d), §22.355, §24.235

According to §22.355, the carrier frequency of each transmitter in the Public Mobile Services must be maintained within the tolerances given in Table below:

Frequency Tolerance for Transmitters in the Public Mobile Services

| Frequency Range (MHz) | Base, fixed (ppm) | Mobile ≤ 3 watts (ppm) | Mobile ≤ 3 watts (ppm) |
|-----------------------|-------------------|------------------------|------------------------|
| 25 to 50 | 20.0 | 20.0 | 50.0 |
| 50 to 450 | 5.0 | 5.0 | 50.0 |
| 450 to 512 | 2.5 | 5.0 | 5.0 |
| 821 to 896 | 1.5 | 2.5 | 2.5 |
| 928 to 929. | 5.0 | N/A | N/A |
| 929 to 960. | 1.5 | N/A | N/A |
| 2110 to 2220 | 10.0 | N/A | N/A |

According to §24.235, the frequency stability shall be sufficient to ensure that the fundamental emissions stays within the authorized frequency block.

Test Procedure

Frequency Stability vs. Temperature: The equipment under test was connected to an external DC power supply and the RF output was connected to communication test set via feed-through attenuators. The EUT was placed inside the temperature chamber. The DC leads and RF output cable exited the chamber through an opening made for the purpose.

After the temperature stabilized for approximately 20 minutes, the frequency output was recorded from the communication test set.

Frequency Stability vs. Voltage: An external variable DC power supply was connected to the battery terminals of the equipment under test. The voltage was set to 115% of the nominal value and was then decreased until the transmitter light no longer illuminated; i.e., the battery end point. The output frequency was recorded for each battery voltage.

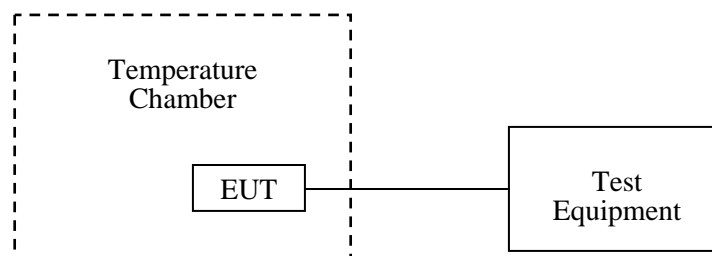

Test Equipment List and Details

| Manufacturer | Description | Model | Serial Number | Calibration Date | Calibration Due Date |
|-----------------|--------------------------------------|---------|---------------|------------------|----------------------|
| ESPEC | Temperature & Humidity Chamber | EL-10KA | 09107726 | 2011-11-24 | 2012-11-23 |
| Rohde & Schwarz | Universal Radio Communication Tester | CMU200 | 109038 | 2012-04-11 | 2013-04-10 |

* **Statement of Traceability:** Bay Area Compliance Laboratories Corp. (Shenzhen) attests that all calibrations have been performed in accordance to NVLAP requirements, traceable to the NIST.

Test Data

Environmental Conditions

| | |
|---------------------------|-----------|
| Temperature: | 25 °C |
| Relative Humidity: | 55 % |
| ATM Pressure: | 100.0 kPa |

The testing was performed by Gardon Zhang on 2012-09-27.

EUT operation mode: Transmitting

Test Result: Compliance. Please refer to the following tables.

Cellular Band (Part 22H)

| Middle Channel, $f_0 = 836.6$ MHz | | | | |
|-----------------------------------|-----------------------------------|-------------------------|-----------------------|-------------|
| Temperature (°C) | Power Supplied (V _{DC}) | Frequency Error (Hz) | Frequency Error (ppm) | Limit (ppm) |
| -30 | 3.7 | 22 | 0.0262969 | 2.5 |
| -20 | | 25 | 0.0298829 | 2.5 |
| -10 | | 24 | 0.0286875 | 2.5 |
| 0 | | 23 | 0.0274922 | 2.5 |
| 10 | | 21 | 0.0251016 | 2.5 |
| 20 | | 22 | 0.0262969 | 2.5 |
| 30 | | 26 | 0.0310782 | 2.5 |
| 40 | | 29 | 0.0346641 | 2.5 |
| 50 | | 27 | 0.0322735 | 2.5 |
| 25 | | V _{min.} = 3.5 | 28 | 0.0334688 |
| 25 | V _{max.} =4.2 | 25 | 0.0298829 | 2.5 |

PCS Band (Part 24E)

| Middle Channel, $f_0 = 1880.0$ MHz | | | | |
|------------------------------------|-----------------------------------|-------------------------|-----------------------|-------------|
| Temperature (°C) | Power Supplied (V _{DC}) | Frequency Error (Hz) | Frequency Error (ppm) | Limit (ppm) |
| -30 | 3.7 | 35 | 0.0186170 | Pass |
| -20 | | 38 | 0.0202128 | Pass |
| -10 | | 35 | 0.0186170 | Pass |
| 0 | | 35 | 0.0186170 | Pass |
| 10 | | 41 | 0.0218085 | Pass |
| 20 | | 39 | 0.0207447 | Pass |
| 30 | | 38 | 0.0202128 | Pass |
| 40 | | 34 | 0.0180851 | Pass |
| 50 | | 35 | 0.0186170 | Pass |
| 25 | | V _{min.} = 3.5 | 33 | 0.0175532 |
| 25 | V _{max.} = 4.2 | 34 | 0.0180851 | Pass |

***** END OF REPORT *****