

**IconX2**

**User Manual**

# Table of Contents

Welcome! .....	6
Use and Care.....	7
Skills Introduction .....	7
Getting started.....	8
Connecting your phone to a computer .....	12
Chapter 1 - Using Phone Features.....	15
1.1 Making Calls .....	15
1.1.1 Calling using the Dialer.....	15
1.1.2 Calling a phone number in a text message.....	15
1.1.3 Calling a phone number in contacts.....	15
1.1.4 Making an emergency call.....	16
1.2 Answering or Rejecting a Call.....	16
1.2.1 Answering an incoming call .....	16
1.2.2 Rejecting an incoming call .....	16
1.2.3 Muting the ringing sound .....	16
1.3 Using In-call Options .....	16
1.3.1 Handling multiple calls.....	16
1.3.2 Setting up a conference call.....	16
1.3.3 Putting a call on hold.....	17
1.3.4 Muting the microphone during a call .....	17
1.3.5 Turning the speakerphone on or off.....	17
1.3.6 Ending a call .....	17
1.4 Using Call History .....	18
1.4.1 Using the Call log tab .....	18
1.4.2 Adding a new phone number to Contacts .....	18
1.4.3 Checking a missed call .....	18
1.4.4 Clearing the Call log list.....	18
1.5 Adjusting Phone Settings .....	19
1.6 Turning the Phone Function On and Off.....	19
1.6.1 Enabling or disabling Airplane mode.....	19
Chapter 2 - Using Contacts .....	19
2.1 About Contacts.....	20
2.2 Contacts List.....	20
2.2.1 Viewing and managing contacts .....	20
2.2.2 To add a new contact.....	20
2.2.3 To search for a contact .....	20
2.2.4 Delete contact .....	20
2.2.5 Display options. ....	20
2.2.6 Import/Export.....	21
2.2.7 Edit contact.....	21
2.2.8 Delete one contact .....	21
2.2.9 Text Contact.....	21
2.2.10 To add a favorite contact .....	21
2.2.11 To remove a favorite contact .....	21
2.2.12 Set default number .....	21
2.2.13 Groups .....	21

Chapter 3 - Messaging.....	22
3.1 Using Message.....	22
3.1.1 Open Messaging.....	22
3.1.2 Creating and sending SMS and MMS messages.....	22
3.1.3 To create and send a text message.....	22
3.1.4 To create and send a multimedia (MMS) message.....	22
3.1.5 To save a message as a draft.....	23
3.1.6 Receiving text and multimedia messages.....	23
3.1.7 To open and read a text message.....	24
3.1.8 To open and view a multimedia message.....	24
3.2 Using Email.....	24
3.2.1 Adding a POP3/IMAP email account.....	24
3.2.2 Composing and sending emails.....	24
3.2.3 Viewing.....	25
3.2.4 Managing emails.....	25
3.2.5 Editing email account settings.....	25
3.2.6 Deleting an email account.....	25
Chapter 4 - Settings.....	25
4.1 Dual-SIM settings.....	26
4.1.1 Select SIM when bootup.....	26
4.1.2 Default SIM card option.....	26
4.1.3 Import SIM contacts when bootup.....	26
4.2 Wireless & networks.....	26
4.2.1 Airplane mode.....	26
4.2.2 Wi-Fi.....	26
4.2.2.1 Turning Wi-Fi on and connecting to a wireless network.....	26
4.2.2.2 Checking the wireless network status.....	26
4.2.2.3 To connect to another Wi-Fi network.....	27
4.2.3 Bluetooth.....	27
4.2.3.1 Turning on Bluetooth and making the phone discoverable.....	27
4.2.4 Tethering.....	28
4.2.5 VPN Settings.....	28
4.2.6 Mobile Networks.....	29
4.2.7 Data Connection SIM.....	29
4.2.8 Traffic Monitoring.....	29
4.2.9 GPRS Transfer Pref.....	29
4.3 Audio effect.....	30
4.4 Audio profiles.....	30
4.5 Display.....	30
4.6 Location & Security.....	30
4.7 Applications.....	30
4.8 Accounts & sync.....	30
4.9 Privacy.....	30
4.10 SD card & phone storage.....	30
4.11 About phone.....	30
Chapter 5 - Camera and Multimedia.....	31
5.1 Using Camera.....	31
5.1.1 Opening Camera.....	31
5.1.2 Closing Camera.....	31

5.1.3 Taking pictures .....	31
5.1.4 Shooting videos.....	31
5.1.5 Review screen.....	31
5.1.6 Camera menu panel .....	31
5.1.7 To open the menu panel .....	32
5.2 Using Gallery.....	32
5.2.1 Opening Gallery .....	32
5.2.2 Working with pictures.....	32
5.2.3 Working with videos .....	33
5.2.4 Adding the Photo album or Photo frame widget.....	33
5.2.5 Closing Albums.....	33
5.3 Using Music .....	34
5.3.1 Copying music into the storage card .....	34
5.3.2 Opening Music.....	34
5.3.3 Library .....	34
5.3.4 Creating playlists.....	34
5.3.5 Managing your playlists .....	35
5.3.6 Setting a song as ringtone .....	35
5.3.7 To check if the song was added as a ringtone .....	35
5.3.8 Adding the Music widget .....	36
Chapter 6 - Google Apps.....	36
6.1 Signing in to your Google Account.....	36
6.1.1 Retrieving your Google Account password .....	36
6.2 Using Gmail/Google Mail.....	36
6.2.1 To open Gmail/Google Mail.....	37
6.2.2 To refresh Gmail/Google Mail .....	37
6.2.3 Creating and sending emails .....	37
6.2.4 Receiving and reading emails.....	38
6.2.5 Replying to or forwarding emails .....	40
6.2.6 Managing conversations and emails.....	40
6.2.7 Setting Gmail/Google Mail settings.....	41
6.3 Using Google Talk.....	41
6.3.1 Sign in and chat online.....	41
6.3.2 Managing your friends.....	43
6.3.3 Mobile indicators .....	44
6.3.4 Adjusting instant messaging settings.....	44
6.3.5 Sign out.....	45
6.4 Using Google Maps .....	45
6.4.1 To enable Location source .....	45
6.4.2 To find your location on the map.....	45
6.4.3 Searching for places of interest .....	45
6.4.4 Viewing maps .....	46
6.4.5 Getting directions .....	46
6.5 Using Google Latitude (Available by Country).....	46
6.5.1 Opening Latitude.....	47
6.5.2 Sharing your locations.....	47
6.5.3 Inviting friends.....	47
6.5.4 Accepting an invitation.....	47
6.5.5 Showing your friends .....	47

6.5.6 Connecting with your friends .....	48
6.5.7 Controlling what you share .....	49
6.6 Using Google Play .....	49
6.6.1 Opening Google Play.....	50
6.6.2 Getting help .....	50
6.6.3 Installing and opening an application.....	50
6.6.4 Managing applications.....	52
6.6.5 Uninstalling an application.....	52
6.7 Synchronizing Google Apps.....	52
6.8 Using Calendar .....	53
6.8.1 Creating events .....	53
6.8.2 Calendar views.....	53
6.8.3 Event reminders.....	55
6.8.4 Adding the Calendar widget.....	55
Chapter 7 - Other Applications.....	55
7.1 Using Clock.....	55
7.1.1 Opening Clock.....	55
7.1.2 Setting an alarm.....	55
7.1.3 Deleting an alarm.....	56
7.1.4 Adding the Clock widget.....	56
7.2 Using Global Time.....	56
7.2.1 Setting the local date, time zone, and time .....	56
7.2.2 Adding cities to the world clock list.....	56
7.2.3 Deleting cities to the world clock list .....	56
7.3 Stop Watch.....	57
7.4 Using Weather.....	57
7.4.1 Opening Weather .....	57
7.4.2 Adding a city.....	57
7.4.3 Deleting a city .....	57
7.5 Using Sound Recorder .....	57
7.6 FM Radio.....	57
7.6.1 Open Radio.....	57
7.6.2 Selectable channel .....	58
7.6.3 Add preset and name the channel .....	58
7.6.4 Adjust the volume.....	58
7.6.5 Scan & Save .....	58

## **Welcome!**

PLEASE READ THIS INFORMATION BEFORE USING THE PHONE TO MAKE A BETTER USE OF IT. WE ARE NOT RESPONSIBLE FOR ANY DAMAGE DUE TO YOUR MISUNDERSTANDING OF THIS INFORMATION AND MISUSE.

We are striving to improve our products and services and we reserve all the rights to revise and change the description of this product and its software as well as this user's manual without obligation to notify any person of such revisions and changes.

This user's manual is for your better use of this phone, not an approval of any accessories. All the pictures in this manual are for reference only. There may be slight differences between the appearance of phone, keys and contents of display used in this manual and those of your phone. Please refer to your phone for current features. Some features introduced in this manual are network or subscription-dependent features. Please contact your service provider.

## **Safety Information**



Read this information before using your mobile device otherwise it may result in personal injury or your device could not comply with local laws.

### **Battery:**

If a conductive material touches an exposed terminal, short circuit may occur resulting in property damage, bodily injury or burn. To avoid risk of leaking or electricity shock, be careful when handling a charged battery particularly when placing it inside your pocket, purse or other container with metal objects.

### **Keep your mobile device away from water:**

Keep your mobile device dry.

### **Use while driving**

Always obey the laws and regulations on the use of mobile devices in the area where you drive. Give full attention to driving and the road; use hand-free operation or earpiece if a call is needed.

### **Aircraft**

Mobile devices may cause harmful interference, so turn off your mobile device before boarding an airplane.

### **Blasting areas**

Always obey the related limits and regulations and do not use your mobile device in blasting areas. Turn off your mobile device in areas posted "turn off electronic devices".

### **Potentially explosive atmospheres**

Turn off your mobile device in gas stations and areas near fuel and chemical containers. Turn off your mobile device in areas posted "turn off electronic devices".

### **Medical devices**

Turn off your mobile device whenever instructed to do so by posted signs near some medical equipment. Mobile devices may interfere with pacemakers, hearing aids and some other medical transplanting equipment. Do not put your mobile device near pacemakers nor carry it in the breast pocket.

### **Accessories and battery**

Use only accessories, batteries and chargers approved by manufacturer. Use of batteries not approved by manufacturer may cause injury.

### **Emergency calls**

Turn on your phone and keep it in service areas, dial emergency phone numbers and then press the send key to make a call.

### **When losing your phone**

To avoid any economy damage, please inform the tele-communication company or agencies to lock your SIM card if you lose your phone.

When you inform the telecom company or agencies to lock your SIM card they need to know your phone's IMEI number, which you can find printed on the label on the back of your phone when taking off the battery. Please backup this number for future need.

For safety consideration, you can take preventive measures such as setting a PIN code for your SIM card to prevent other people from using your SIM card without your permission.

### **Keep away from children**

Keep the phone, battery and charger away from children to avoid any personal injury.

## **Use and Care**

### **To care for this mobile device, keep it away from:**



#### **Any kind of fluid**

Keep the device away from water, rain, humidity, sweat or other moisture.



#### **Extreme heat or cold**

Avoid the temperature below  $-10^{\circ}\text{C}/14^{\circ}\text{F}$  or above  $45^{\circ}\text{C}/113^{\circ}\text{F}$ .



#### **Microwave**

Don't try to dry your phone in a microwave oven.



#### **Dust and dirt**

Don't expose your phone to dust, dirt, sand, food or other inappropriate materials.



#### **Cleaning solutions**

Use only a dry soft cloth to clean your phone. Don't use alcohol or other cleaning solutions.



#### **Ground**

Don't drop your phone.

## **Skills Introduction**

## **Finger gestures**

### **Tap**

When you want to type using the keyboard, select onscreen items such as application and settings icons, or to press onscreen buttons, simply tap them with your finger.

### **Press and hold**

To open the available options for an item (e.g. contact or link in a web page), simply press and hold the item.

### **Swipe or slide**

To swipe or slide means to quickly drag your finger vertically or horizontally across the screen or optical trackball.

### **Drag**

Press and hold your finger with some pressure before you start to drag. While dragging, do not release your finger until you have reached the target position.

### **Flick**

Flicking the screen is similar to swiping, except that you need to swipe your finger in light, quicker strokes. This finger gesture is always in a vertical direction, such as when flicking the contacts or message list.

### **Rotate**

For most screens, you can automatically change the screen orientation from portrait to landscape by turning the phone sideways. When entering text, you can turn the phone sideways to bring up a bigger keyboard. Refer to the Settings chapter for more details.

### **Pinch**

For some applications, like Photos or the web browser, you can “pinch” the screen using 2 fingers (for example, thumb and index fingers) to zoom in or zoom out when viewing a picture or a web page.

## **Getting started**



## Your device



## Insert SIM card

This device supports dual SIM cards. You can insert the SIM cards as shown below.

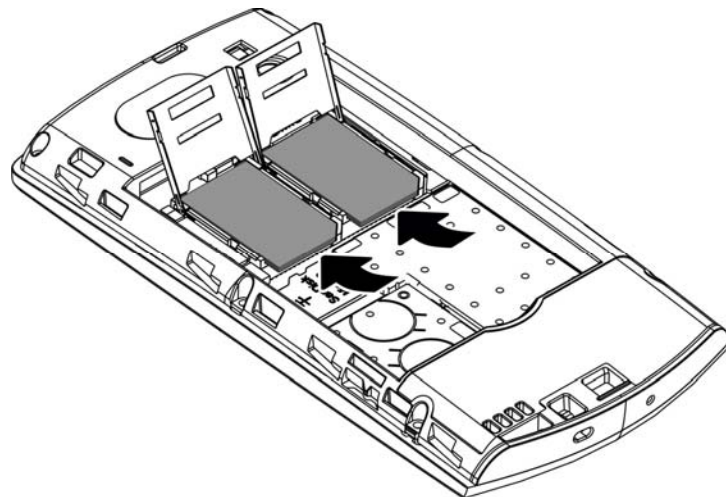

## Insert memory card

You can insert a memory card in the phone in order to extend the memory.

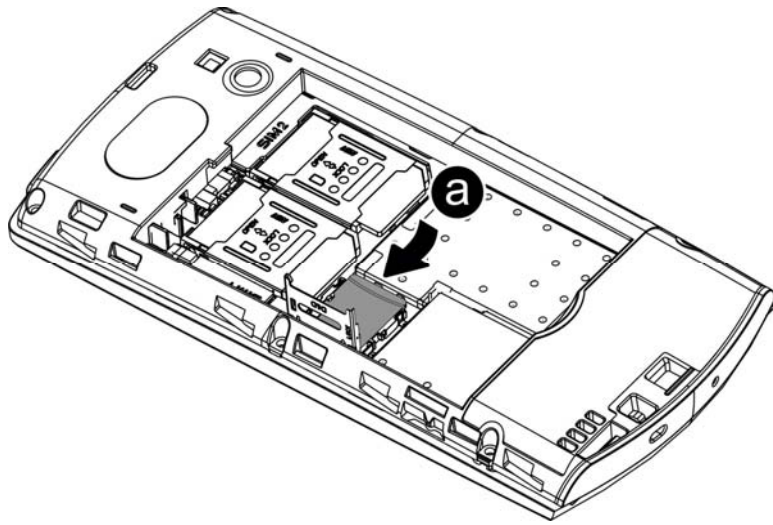

**Insert battery and charging**

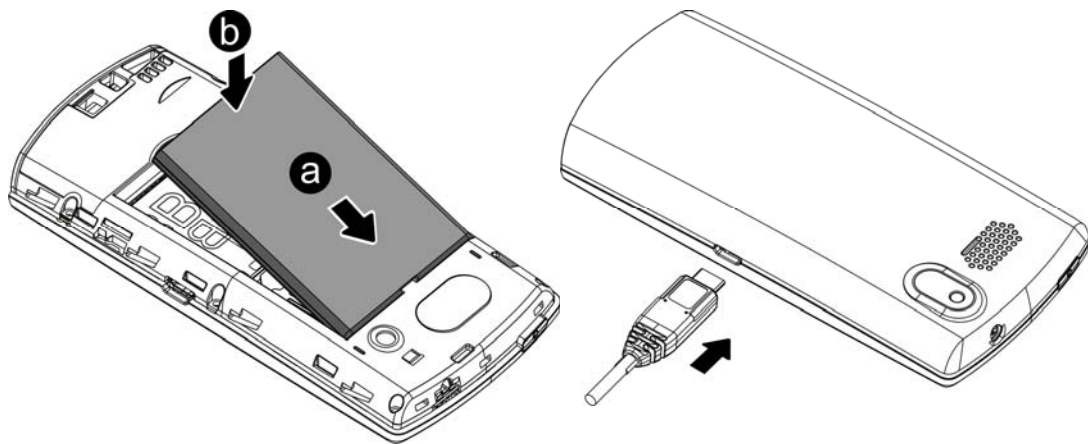

**Entering your PIN**

If your SIM card is preset with a PIN (personal identification number), you will be prompted to enter the PIN to proceed. Enter the SIM's PIN, then tap OK.

Most SIM cards are preset with a PIN (personal identification number) that is provided by your mobile operator. When prompted, enter the preset PIN, then tap Enter. If you enter the wrong PIN three times, the SIM card is blocked. If this happens, you can unblock it with the PUK (PIN Unblocking Key) obtained from your mobile operator.

## **Home Screen**

The Home screen provides you a clock that shows the time. Tap this item to open the associated application. The Home screen also lets you add the items you want and need on the Home screen. Add items like application icons, shortcuts, folders, and widgets to give you instant access to information and applications.

## **Extended Home screen**

The Home screen extends beyond the screen width to provide more space for adding icons, widgets, and more. There are 6 "additional" screens apart from the main Home screen.

## **Navigating the Home screen**

You can go to the extended Home screen by sliding your finger horizontally across the screen to go to the left or right side of the Home screen. While on an extended Home screen, press HOME to return to the main Home screen.

### ***Directly going to a particular screen***

To enter the extension of the Home screen, use your finger on the screen rapid slide, you can skip to the Home screen to the left or right. Press the Home key on the screen to return to the Home screen.

## **Checking notifications**

Notification icons on the status bar report the arrival of new messages, calendar events, alarms set and ongoing settings such as when call forwarding is on or the current call status. You can open the Notifications panel to open the message, reminder, or event notification and see the mobile operator name.

## **Opening the Notifications panel**

When a new notification icon displays in the status bar, press and hold the status bar, then slide your finger downward to open the Notifications panel.

If you have several notifications, you can scroll down the screen to view more notifications. You can also open the Notifications panel on the Home screen by pressing MENU and then tapping Notifications.

## **Closing the Notifications panel**

Press and hold the bottom bar of the Notifications panel, then slide your finger up the screen.

### **Adjusting the ringer volume**

Press the “alt” “i” keys and “alt” “o” keys to decrease and increase volume respectively. The Ringer volume window appears on the screen to display the volume levels.

### **Connecting your phone to a computer**

#### **Charge only**

The default is the charge mode.

#### **Disk drive**

This mode is available only when you have installed a micro SD card on your phone. Select this mode when you want to use your storage card as a USB thumb drive, and copy files between your phone’s storage card and your computer. When the Disk Drive mode is enabled while your phone is connected to the computer, you will not be able to run applications that use the storage card, such as Music or Photos.

#### **Tethering**

Share your phone’s mobile data connection via USB:

#### ***Mobile phone side of the steps:***

1. Open GPRS, USB connected mobile phones and computers;
2. Settings -> Wireless and Network -> binding, check the "binding"

#### ***PC side (windows XP system)***

1. Disable the local existing network connection (XP system);
2. When the mobile phone side of the operation is complete, if PC side of the network connection has no new connection, you need to install active sync. on top of the screen.

#### **Copying files to and from the storage card**

1. Connect the phone to your computer using the supplied USB cable.
2. When the *Connect to PC* dialog box appears, tap Disk drive, and then tap Done.
3. On your computer, the connected phone is recognized as a removable disk. Navigate to this removable disk and open it.
4. Do one of the following: Copy the files from the computer to the phone’s storage card’s root folder. Copy the files from the phone’s storage card to a folder in your computer or computer desktop.
5. After copying the files, eject the removable disk (the connected phone) as required by your computer’s operating system to safely remove your phone.

#### **Disconnect the phone from the computer.**

If you want to keep the phone connected to the computer but you also want the phone to be able to access the storage card, open the Notifications panel, tap Disk drive, select an option except Disk drive, and then tap Done.

### **Changing your wallpaper**

1. Press HOME > MENU, and then tap Wallpaper.
2. Select wallpaper from **Live wallpaper/Pictures/Wallpaper gallery**.
3. Do one of the following:
  - Tap Photos to select a photo that you have taken using the camera or copied to your storage card. Crop the photo and then tap Save.
  - Tap Wallpaper gallery to choose from preset wallpapers and then tap Set wallpaper.

### **Adding a widget to your Home screen**

A wide selection of widgets is available for you to choose from, such as Calendar, Music, Photo Album, Friend Stream, and more.

1. Press HOME. Go to the part of the Home screen where there's space to add a new widget.
2. Press and hold on the Home screen to open the Add to Home options menu.
3. Tap Widget and then select a widget that you want.

You can also add widgets that allow you to quickly switch on or off certain settings of your phone, such as Wi-Fi, Mobile Network, Bluetooth, and more. Scroll down the widgets list, tap Settings, and then tap the widget that you want.

### **Adding application icons and other shortcuts on your Home screen**

Place application icons on your Home screen to open applications quicker. You can also add shortcuts to settings and specific information such as a bookmarked webpage, someone's phone number, a music playlist, route directions, and many other items, to your Home screen. The shortcuts available depend on the applications that are installed on your phone.

1. Press HOME. Go to the part of the Home screen where there's space to add a new shortcut.
2. Press and hold on the Home screen to open the Add to Home options menu.
3. Do one of the following:
  - To add an application icon, tap Program and then select an application.
  - To add a shortcut to a setting or information, tap Shortcut and then select the type of information or setting.

**Tips:** To add an application icon on the Home screen, you can also press HOME, enter All Programs, and then press and hold an application icon. Without lifting your finger, drag the icon to an empty area on the Home screen, and then release it.

### **Adding folders on your Home screen**

Use folders to group related applications and other shortcuts to keep your Home screen tidy and organized.

You can also add information folders that show up-to-date information such as Bluetooth received files, your Facebook phonebook, and more.

### ***Creating a new folder and adding items to it***

1. Press HOME. Go to the part of the Home screen where there's space to add a new folder.
2. Press and hold on the Home screen to open the Add to Home options menu.
3. Tap Folder and then tap New Folder.
4. Press and hold an application icon or a shortcut that you want to move to the folder. The phone then vibrates. Don't lift your finger.
5. Drag the application icon or shortcut and drop it on top of the folder. Simply tap the folder to open it so you can access the applications and shortcuts inside the folder.

### ***Renaming a folder***

1. Tap the folder to open it.
2. Press and hold the folder window's title bar.
3. Enter a new folder name and then tap OK.

Rearranging or removing widgets and icons on your Home screen

Rearrange the widgets and icons on your Home screen to give room for adding more items to the Home screen. You can also remove widgets and icons that you don't frequently use.

### **Moving a widget or icon**

1. Press and hold the widget or icon you want to move. The phone vibrates and you'll see a green box around the widget or icon. Don't release your finger.
2. Drag the widget or icon to a new location on the screen. Pause at the left or right edge of the screen to drag the widget or icon onto another Home screen panel.
3. When the widget or icon is where you want it, release your finger. If you've released your finger but a message shows that there's no space to place the widget or icon, drag it right or left again to another Home screen panel.

### **Removing a widget or icon**

1. Press and hold the widget or icon you want to remove. The phone vibrates and you'll see a green box around the widget or icon. Don't release your finger.
2. Drag the widget or icon to the Phone button. The Phone button then changes into the Remove button and turns red.
3. When the widget or icon also turns red, release your finger.

### **Searching the Web and your phone using the Quick Search Box**

1. Press HOME->MENU-> SEARCH.

- If you are in an application such as Mail, press the SEARCH button to toggle between doing a search in the application only and searching your phone and the Web.
2. Enter the search item in the Quick Search Box. As you type, matching items on your phone and suggestions from Google web search are shown as a list. The suggested items that appear will depend on the options that you have selected in the search settings.
  3. Do one of the following:
    - If what you're searching for is in the list of suggestions, tap it in the list. The item opens in the appropriate application.
    - If what you're searching for is not in the list, tap  to search the Web. The web browser opens, displaying results of a Google search on the Web.

## Chapter 1 - Using Phone Features

### 1.1 Making Calls

There are several convenient methods to make a call from your phone.

#### 1.1.1 Calling using the Dialer

You can tap dialer application or press ALT key & number key at the same time to enter the dialer screen. In **Dialer**, when you input a number, you have two ways to select how to make a call.

1. Directly press **TALK 1** or **TALK 2** on the keyboard.
2. You can chose the contact icon to and click on the contacts.

**Note:** If you only have one SIM card inserted, you can't use another SIM card to make a call. When one SIM card is a call, another is temporarily unavailable.

#### 1.1.2 Calling a phone number in a text message

While viewing a text message, you can place a call to a number that is in the body of the message.

1. Tap the message with the phone number.
2. On the **Select action** screen, tap the number you want to call.
3. The dialer screen then opens, with the phone number automatically filled in and ready to be dialed. To place the call, select **SIM 1** or **SIM 2**.

#### 1.1.3 Calling a phone number in contacts

Enter the contacts list to make a call after you select a contact.

#### ***1.1.4 Making an emergency call***

On the Phone screen, dial the international emergency number for your country (for example, 911), and then tap **Call**.

#### ***1.2 Answering or Rejecting a Call***

When you receive a phone call from a contact, the Incoming call screen appears and displays the caller ID icon, name, and phone number of the calling party. When you receive a phone call from someone who is not stored in Contacts, only the default caller ID icon and phone number appear on the Incoming call screen.

##### ***1.2.1 Answering an incoming call***

Slide to answer SIM 1 or SIM 2 incoming call.

##### ***1.2.2 Rejecting an incoming call***

Slide the end call /POWER key to reject.

##### ***1.2.3 Muting the ringing sound***

To mute the ring without rejecting the call, press the “alt” “i” button.

#### ***1.3 Using In-call Options***

When a call is in progress, you can go through the operation of key options.

Tap the available buttons to put a call on hold, dial another contact for a phone conference, mute the phone microphone, and more.

**Note:** When the phone is dialing, only the **End call** and **Speaker on** buttons are available.

##### ***1.3.1 Handling multiple calls***



Your phone notifies you when you have another incoming call, and gives you the option of rejecting or accepting the call. If you are already on a call and accept the new call, you can choose to switch between the two callers.

1. Slide the TALK button to accept the second call and put the first call on hold.
2. To switch between callers, tap the person you want to talk to on the screen.
3. To end the current call and return to the other call, Slide **End call**.

##### ***1.3.2 Setting up a conference call***

1. Make a call to the first conference call participant.
2. When connected, press MENU and tap **Add call**, and then dial the number of the second participant. The first participant is put on hold when you dial the second participant.



3. When connected to the second participant, Tap  (merge).
4. To add another participant to the conference call, tap  on the conference call screen, and then dial the number of the contact you want to invite to the conference call.

**Note:** The conference call is put on hold when you call another contact. When you are connected to the other contact, you can talk to that party in private.

5. When connected, select other contact to add the participant to the conference call.
6. When finished, tap **End call**.

**Note:** Not all mobile phone networks support conference calling. Contact your wireless service provider for details.

### ***1.3.3 Putting a call on hold***

Tap **Hold** to put the call on hold. When you put a call on hold, the hold call icon  appears in the status bar. Then tap **Unhold** to resume the call.

**Tips** You can also put a call on hold by pressing the CALL button. Press the CALL button again to resume the call.

### ***1.3.4 Muting the microphone during a call***

Tap **Mute/Unmute** to toggle between turning the microphone on or off. When the microphone is turned off, the Mute icon  appears in the status bar.

### ***1.3.5 Turning the speakerphone on or off***

During a call, Tap **Speaker on/Speaker off** to toggle between turning the speakerphone on or off. The speakerphone icon  appears in the status bar when the speakerphone is on.

**Warning!** To avoid damage to your hearing, do not hold your phone against your ear when the speakerphone is turned on.

### ***1.3.6 Ending a call***

Do one of the following to end the call:

- Press END CALL/POWER.
- Tap **End call**.
- If you are using the provided wired headset, press and hold the button to end the call.

## 1.4 Using Call History

When you miss a call, the missed call icon  appears in the title bar.

Use the **Call log** tab of the Contacts screen to check who the caller was or view all your dialed numbers and received calls.

### 1.4.1 Using the Call log tab

1. Press **TALK 1** key, enter the talk 1 call log list;  
Press **TALK 2** key, enter the talk 2 call log list; or enter dialer application to select **Call log**, display all call log.

2. Do one of the following:

- Tap the name or number in the list to call.
- Press and hold a name or number in the list to display the options menu where you can select to view the contact information (if the number is stored in your contacts list), edit number before calling, send SMS message, or remove from call log.

**Note:** Tap SIM All, display SIM1 & SIM2 call history, select SIM1 or SIM2 can separate display.

### 1.4.2 Adding a new phone number to Contacts

If the phone number of a person who called is not in your contacts list, you can choose to save the number after you hang up.

1. Press **TALK** key, or enter dial board to select **Call log**.

2. Press and hold the received call that you want to save to your contacts list, and then tap **Add to contacts**.

3. In the blank contact record that appears, enter the contact name and other information. The phone number is automatically added to the **Mobile** field in the Number section. To store it as another type of number, for example a home number, tap the **Mobile** button.

4. Scroll down the screen and tap **Save**.

### 1.4.3 Checking a missed call

You will see the missed call icon in the status bar when you miss a call. To check who the caller was, Enter Contact and then tap **Call log**. Missed calls are indicated by the missed call icon 

The calls you have answered have the icon 

**Tips** You can also press and hold the status bar, and then slide your finger downward on the screen to open the Notifications panel. The missed call number and/or contact name is displayed.

### 1.4.4 Clearing the Call log list

On the Call log tab, do one of the following:

- To remove one name or number from the list, press and hold the name or number, and then tap **Remove from Call log**.
- To clear the entire list, press MENU and then tap **Clear call log**.

### 1.5 Adjusting Phone Settings

You can adjust the settings of your phone such as your voice mail number, or enable additional call services from your wireless service provider.

To open the phone settings menu, long press BACK (equal to HOME) > MENU, and then tap **Settings > Call settings**, meanwhile you must select SIM 1 or SIM 2 .

Options	Description
<b>Fixed Dialing Numbers</b>	Restrict outgoing calls to a fixed set of numbers. To enable this feature you must know your SIM card's PIN 2 code.
<b>Voicemail</b>	Specify another voicemail number aside from the voice mail number on your SIM card.
<b>Auto answer</b>	1 ring 、 2 rings 、 3 rings 、 Never Answer (default)
<b>Call forwarding</b>	Select how you want your phone to handle busy, unanswered, unreachable. You can also set the call forwarding option for all incoming calls.
<b>Call barring</b>	Choose barring outing or barring incoming, You need apply this function from your network operators.
<b>Additional call settings</b>	Enable or disable operator services such as caller ID and call waiting.

### 1.6 Turning the Phone Function On and Off

#### 1.6.1 Enabling or disabling Airplane mode

1. Press HOME (long press back)> MENU, then tap **Settings /long press Power> Wireless controls**.
2. Select the **Airplane mode** check box to enable or disable Airplane mode. When enabled, the Airplane mode icon  displays in the status bar.

**Tips:** When you disable Airplane Mode, the phone function is turned back on and the previous state of Bluetooth and Wi-Fi is restored.

## Chapter 2 - Using Contacts

## **2.1 About Contacts**

In **Contacts**, you can easily manage your communications with your contacts via phone, messaging, and email.

If you are synchronizing contacts with your Google account or with your PC tools, any contacts stored in those accounts are displayed in contacts.

## **2.2 Contacts List**

### **2.2.1 Viewing and managing contacts**

The Contacts screen shows all your contact lists, including Google account contacts after synchronization, phone contacts you created, and SIM 1 & SIM2 card contacts if it has saved contacts.

### **2.2.2 To add a new contact**

1. On the contacts list screen, press **Menu**, then tap **New contact**.
2. Enter the contact information in the fields provided.
3. Scroll to the bottom of the screen and tap **Save**.

### **2.2.3 To search for a contact**

1. On the contacts list screen, press MENU, and then tap **Search**.
2. In the search bar, enter the first few letters of the first or last name of the contact you are looking for. Matching contacts are displayed.

**Tips:** If the list of matching contacts is long, you can view more results by tapping to hide the onscreen keyboard.

3. Tap the contact you want to open his or her Contact Details screen.

### **2.2.4 Delete contact**

On the contacts list screen, press Menu, and then tap **Delete contact**;  
On the Delete screen, you can operate **Multiple choice**, or **Mark all**.

**Warning:** This operation will delete contact, please be careful.

### **2.2.5 Display options.**

The function help you to display customize options, including default and Gmail account display option.

**Tips:** After synchronizing contacts with your Google account, add the contact to the phone, you must select “All Other Contacts” item in Gmail account display option, the contacts will displayed in the list.

### **2.2.6 Import/Export**

Starting the phone will automatically import SIM and SIM 2 card contacts, you can cancel it in “Settings->Dual-SIM settings->Import SIM Contacts when bootup”.

1. On the contacts list screen, press MENU, and then tap **Import/Export**.
2. You can select the following items: Import from SIM1; Import from SIM2; Import from SD card, Export to SD card; Share visible contacts.

**Note:** If you only insert a SIM card, you can't operate another SIM card.

### **2.2.7 Edit contact**

On the contacts list screen, press and hold the contact, and then tap **Edit contact**.

### **2.2.8 Delete one contact**

On the contacts list screen, press and hold the contact, and then tap **Delete contact**.

### **2.2.9 Text Contact**

On the contacts list screen, press and hold the contact, and then tap **Text Contact**, enter compose message screen

### **2.2.10 To add a favorite contact**

1. On the contacts list screen, press and hold the contact, and then tap the **Add to favorites**.
2. On the contacts details screen, tap 

### **2.2.11 To remove a favorite contact**

1. On the Favorites tab, press and hold the contact, then tap **Remove from favorite**.
2. On the contacts details screen, tap 

### **2.2.12 Set default number**

If the contacts contain more than one number item, you can set any to default number. On the contacts details screen, press and hold the number not default, then tap **Make default number**.

### **2.2.13 Groups**

You can create different groups, add saved in the phone contacts to the group, set personalized items.

Long press the **Groups**, you can operate the **Groups** by the pop-up items.

## Chapter 3 - Messaging

### 3.1 Using Message

Message lets you compose and send text (SMS) and multimedia messages (MMS) to other mobile phones.

#### 3.1.1 Open Messaging

#### 3.1.2 Creating and sending SMS and MMS messages

You can compose text (SMS) messages of up to 160 characters. If you continue to type after the limit is reached, your message will be delivered as one, but count as more than one message. These are called concatenated messages.

Multimedia messages, also known as MMS, can contain text and a picture, a recorded voice, an audio or video file, a picture slideshow.

#### 3.1.3 To create and send a text message

1. On the **All thread** screen, tap **New message**. The compose screen opens.
2. Enter the phone number (the message recipient) in the **To** field. As you enter the phone number, matching contacts will appear on the screen. Tap a recipient or continue entering the recipient's phone number.

**Note:** When the mobile phone number shows, the phone number of the contact have created.

3. Tap the text box that contains the text "Type to compose", and then start composing your message.

**Note:** As you reach the 160-character limit, a counter will appear in the top right corner of the text box to tell you how many characters are left. Once you go over that limit, a new message is created but automatically joined into one when received.

4. When done, tap **Send** to send the text message.

**Note:** To receive delivery reports and know when a text message is received, in the **All threads** screen, press MENU and then tap **Settings**. In the SMS settings section, select the **Delivery reports** check box.

#### 3.1.4 To create and send a multimedia (MMS) message

1. On the **All threads** screen, tap **New message**. The Compose screen opens.
2. Enter the mobile phone number or email address of your message recipients in the **To** field. As you enter the phone number or email address, matching contacts

will appear on the screen. Tap a recipient or continue entering the recipient's phone number or email address.

**Tips:** You can add a subject line by pressing MENU and then tapping **Add subject**.

3. Tap the text box that contains the text "Type to compose", and then start composing your message.

4. Press MENU and then tap **Attach**.

5. On the Attach window, select from the following file attachments:



**Pictures:** Opens the Albums application. Select a picture to attach it to your message.

**Videos:** Opens the Albums application. Select a video to attach it to your message.

**Audio:** Opens the Select music track screen. Tap an audio file to select, and then tap **OK** to attach the file into your message. The music file plays back when you tap it.

**Capture picture:** Opens the Camera application. Take a picture of your subject, and then tap **Done** to attach it to your message.

**Capture video:** Opens the Camcorder application. Shoot a video, and then tap **Done** to attach it to your message.

**Record audio:** Opens Voice Recorder. Tap  to start recording your message, and then tap  to stop.

**Slideshow:** Opens the Edit slideshow screen. Tap **Add slide** to create a new slide. Tap the created slide (for example, Slide 1), tap **Insert picture**, and then select the picture you want to add to the slide. You can also navigate to the text box and enter a caption for the picture. When finished, tap **Done** to attach the slideshow to your message.

**Tips:**

- When editing multiple slides, tap to edit the next slide or tap to return to  the previous slide.
- While editing the slideshow, press MENU to let you preview the slideshow, add music or video to a slide, remove a slide, and more.

6. When you are finished composing the multimedia message, tap **Send**.

### ***3.1.5 To save a message as a draft***

While composing a text or multimedia message, press BACK to automatically save your message as a draft. To resume composing the message, tap the message in the All thread screen. Continue editing the message, and then tap **Send** to send it.

### ***3.1.6 Receiving text and multimedia messages***

Depending on your notification settings, the phone will play a ring tone, vibrate, or display the message briefly in the status bar when you receive a new text or multimedia message.

### ***3.1.7 To open and read a text message***

- Press HOME, then press and hold the status bar, and then slide it down to open the Notifications panel. Tap the new message to open and read it.
- On the All threads screen, tap the text message or message thread to open and read it .

To return to the All threads screen from a text message thread, press MENU and then tap **More -> All threads**.

#### **Notes:**

- To view the details of a particular message, in the message threads, press and hold the message to open the options menu, and then tap **View thread**.
- If a message contains a link to a web page, tap the link to let you open the link in the Browser or add the URL as a bookmark.
- If a message contains a phone number, tap the message to open Dialer so you can call the number.

### ***3.1.8 To open and view a multimedia message***

1. On the All threads screen, tap a multimedia message or message thread to open it.
2. Tap the **Play** button at the top of a multimedia message to view it.

**Tips:** You can save the file attachment on the multimedia message to the SD card. To save, press and hold the file and then tap **Copy attached to SD card** on the options menu.

**Notes:** When **Auto-retrieve** in MMS settings is disabled, only the message header is downloaded. To download the entire message, tap the **Download** button at the right side of the message. Once the message has downloaded, tap the **Play** button to view the message.

- If you are concerned about the size of your data downloads, check the multimedia message size before you download it.

## ***3.2 Using Email***

### ***3.2.1 Adding a POP3/IMAP email account***

If the account type you want to set up is not in the phone database, you will be asked to enter more details. It is recommended that you get all pertinent information for the email account such as incoming/outgoing server settings before you proceed.

### ***3.2.2 Composing and sending emails***

1. On the email account Inbox, press **MENU** and then tap **Compose**.
2. Enter the message recipient's email address in the **To** field. As you enter information, matching contacts will appear on the screen. Tap the recipient or continue entering the email address. If you are sending the email to several recipients, separate the email addresses with a comma.



**Tips** • If you want to send a carbon copy (Cc) or a blind carbon copy (Bcc) of the email to other recipients, press MENU and then tap **Add recipient > Cc** or **Bcc**.

3. Enter the subject, and then compose your message. Tap **Send**.

**Note** Tap **Save as draft** to save the message as a draft, tap **Discard** will not save

### **3.2.3 Viewing**

1. On the email account Inbox, tap the email you want to view.
2. If the email added attachment, you can view all the attachment after downloading it.

### **3.2.4 Managing emails**

1. Press and hold one email, on the popup options screen, you can select **Open /Delete / Forward / Reply all / Reply / Mark as read (unread)**.
2. On the email account Inbox screen, press **Menu -> Refresh**, you can receive new email in time.
3. On the email account Inbox screen, press **Menu -> Accounts**, enter to all accounts screen

### **3.2.5 Editing email account settings**

1. On the email account Inbox screen, press **Menu -> Accounts**.
2. Press and hold the account, on the popup option, select **Account Settings**.

<b>Account settings</b>	Change the email account settings such as General settings, Notification settings and server settings.
<b>General settings</b>	Set the account name, your name, Signature, email check frequency, default email account.
<b>Notification settings</b>	Set the email notification, select ringtone and vibrate.
<b>Server settings</b>	Set incoming settings, outgoing settings.

3. Press BACK to save your changes.

### **3.2.6 Deleting an email account**

1. On the email account Inbox screen, press **Menu -> Accounts**.
2. On the accounts list screen, press and hold the account, on the popup option, select **Remove Account**.

## **Chapter 4 - Settings**

## **4.1 Dual-SIM settings**

You can choose the SIM1 or SIM2, or both of them. If you insert one SIM card, just one would be available to select.

### **4.1.1 Select SIM when bootup**

If you choose the select SIM when you reboot the phone, interface will pop up a selection box, you could choose use SIM1 or SIM2

### **4.1.2 Default SIM card option**

This option is for SIM card, it will default to use this GPRS card.

### **4.1.3 Import SIM contacts when bootup**

When you hook on this option, when booting SIM card contacts will automatically be imported, otherwise, they will not be imported.

## **4.2 Wireless & networks**

Your phone's networking capabilities allow you to access the Internet through GPRS or Wi-Fi.

### **4.2.1 Airplane mode**

In places where you can not use a wireless signal, such as aircrafts, turn off or turn on the airplane Mode. When flight mode is on, the title bar would have the icon 

### **4.2.2 Wi-Fi**

Wi-Fi provides wireless Internet access over distances of up to 100 feet (100 meters). To use Wi-Fi on your phone, you need access to a wireless access point or "hotspot".

**Note:** The availability and range of the Wi-Fi signal depends on the number, infrastructure, and other objects through which the signal passes.

#### **4.2.2.1 Turning Wi-Fi on and connecting to a wireless network**

1. Tap **Settings > Wireless controls**.
2. Select the **Wi-Fi** check box to turn Wi-Fi on. The phone will scan for available wireless networks.
3. Tap **Wi-Fi settings**. The network names and security settings (Open network or Secured with WEP) of detected Wi-Fi networks are displayed in the Wi-Fi networks section.
4. Tap a Wi-Fi network to connect. If you selected an open network, you will be automatically connected to the network. If you selected a network that is secured with WEP, enter the key and then tap **Connect**.

#### **4.2.2.2 Checking the wireless network status**

You can check the current wireless connection status from the following:

- **Status bar**

When your phone is connected to a wireless network, the Wi-Fi  icon appears in the status bar and tells you the approximate signal strength (number of bands that light up). If **Network notification** in Wi-Fi settings is enabled,

this icon  will show when an available wireless network is within range. appears in the status bar whenever the phone detects

- **Wi-Fi networks**

On the Wireless controls screen, tap **Wi-Fi settings**, then tap the wireless network that the phone is currently connected to. A message box will be displayed showing the Wi-Fi network name, status, speed, signal strength, and more.

**Note:** If you want to remove the wireless network settings on your phone, tap **Forget** on this window. You need to enter the settings again if you want to connect to this wireless network.

#### **4.2.2.3 To connect to another Wi-Fi network**

1. On the Wireless controls screen, tap **Wi-Fi settings**. Detected Wi-Fi networks are displayed in the Wi-Fi networks section.

**Tips:** To manually scan for available Wi-Fi networks, on the Wi-Fi settings screen, press MENU and then tap **Scan**.

2. Tap another Wi-Fi network to connect to it.

**Note:** If the wireless network you want to connect to is not in the list of detected networks, scroll down the screen, then tap **Add Wi-Fi network**. Enter the wireless network settings, then tap **Save**.

#### **4.2.3 Bluetooth**

The Bluetooth on your phone operates in three different modes:

- **On.** Bluetooth is turned on. Your phone can detect other Bluetooth-enabled devices, but not vice versa.
- **Discoverable.** Bluetooth is turned on, and all other Bluetooth-enabled devices can detect your phone.
- **Off.** Bluetooth is turned off. In this mode, you can neither send nor receive information using Bluetooth.

**Notes:**

- By default, Bluetooth is turned off. If you turn it on, then turn off your phone, Bluetooth also turns off. When you turn on your phone again, you should turn on Bluetooth again.
- Turn off Bluetooth when not in use to preserve battery power, or in places where using a wireless device is prohibited, such as on board an aircraft and in hospitals.

##### **4.2.3.1 Turning on Bluetooth and making the phone discoverable**

1. Tap Bluetooth **Settings**.

2. Select the **Bluetooth** check box to turn on Bluetooth. When on, the Bluetooth icon  appears in the status bar.

3. Tap **Bluetooth settings**, and then select the **Discoverable** check box to make the phone discoverable to other Bluetooth devices that are within range.

**Important** Your phone will always be discoverable after you turn it on.

#### **4.2.4 Tethering**

##### **Share your phone's mobile data connection via USB**

###### **Mobile phone side of the steps:**

- Open GPRS, USB connected mobile phones and computers;
- Settings -> Wireless and Network -> binding, check the "binding."

###### **PC side (windows XP system)**

- Disable the local existing network connection (XP system);
- When the mobile phone side of the operation is complete, if no new connection occurs on the PC side of the network connection, you need to install active sync. on top of the screen.

#### **4.2.5 VPN Settings**

From your phone, you can add, set up, and manage virtual private networks (VPNs) that allow you to connect and access resources inside a secured local network, such as your corporate network.

##### **Preparing your phone for VPN connection**

Depending on the type of VPN you are using at work, you may be required to enter your login credentials and/or install security certificates before you can connect to your company's local network. You can get this information from your network administrator.

Also, your phone must first establish a Wi-Fi or data connection before you can initiate a VPN connection.

##### **Setting up secure credential storage**

If your network administrator instructs you to download and install security certificates, you must first set up the phone's secure credential storage.

1. Press HOME > MENU, tap Settings > Security, and then tap Set password.
2. Enter a new password (at least 8 characters without any spaces) for the credential storage, scroll down and confirm the password, and then tap OK.
3. Select the Use secure credentials check box.

You can then download and install the certificates needed to access your local network, your network administrator can tell you how to do this.

##### **Adding a VPN connection**

1. Press HOME > MENU, and then tap Settings > Wireless & networks > VPN settings.

2. Tap Add VPN, and then tap the type of VPN you want to add.
3. Tap the VPN settings and set them up according to the security details you have obtained from your network administrator.
4. When finished, press MENU, and then tap Save.

The VPN is then added to the VPNs section of the VPN settings screen.

### **Connecting to a VPN**

1. Press HOME > MENU, and then tap Settings > Wireless & networks > VPN settings.

2. In the VPNs section, tap the VPN that you want to connect to.

3. When prompted, enter your log in credentials, and then tap Connect.

When you are connected, the VPN connected icon appears in the notification area of the title bar.

4. Open the web browser to access resources such as intranet sites on your corporate network.

### **Disconnecting from a VPN**

1. Press and hold the title bar, and then slide down your finger to open the Notifications panel.

2. Tap the VPN connection to return to the VPN settings screen, and then tap the VPN connection to disconnect from it.

When your phone has disconnected from the VPN, the VPN disconnected icon is displayed in the notification area of the title bar.

### **4.2.6 Mobile Networks**

Tap the Data Connection SIM, you can choose according to your needs SIM1 or SIM2 card open roaming.

### **4.2.7 Data Connection SIM**

When you tap the options you will see the option box below, now you can choose.

### **4.2.8 Traffic Monitoring**

This is for your use of the GPRS traffic monitoring, you can also set it up to your own needs.

### **4.2.9 GPRS Transfer Pref.**

When you hook on the option box, the description of Call preferences web traffic appears, you can answer calls; if the option box indicating data preference is removed, you can not accept incoming calls.

### **4.3 Audio effect**

You can choose according to audio effect preferences.

### **4.4 Audio profiles**

There are four modes to choose from, including General, Silent, Meeting, Outdoor.

### **4.5 Display**

You can select the screen brightness and standby time to your own needs and place, also if you want to switch screens.

### **4.6 Location & Security**

When the use wireless networks has been checked, the mobile network /Wi-Fi will determine the location.

Use of GPS satellites to determine your location

In accordance with the options to lock screen with a pattern, PIN, or password.

### **4.7 Applications**

Here you can choose to install non-market applications and view the application procedure and if it has been downloaded.

### **4.8 Accounts & sync**

You can add corporate and Google account to synchronize.

### **4.9 Privacy**

When main application is loaded back up, to reinstall an application, restore backed up settings or other data.

Factory data reset

**Note:** When you do a factory data reset, all data on phone would be erased, so please do not try to restore factory settings.

### **4.10 SD card & phone storage**

Here you can view the total capacity of the SD card and the phone, and it can be inserted on the installation and format the SD card.

### **4.11 About phone**

Here you can view the phone status and the use of mobile phone batteries and IMEI number, Bluetooth address, Wi-Fi address.

## Chapter 5 - Camera and Multimedia

### 5.1 Using Camera

You must install a storage card before you use the Camera. All pictures or videos that you capture on your phone are stored on the card.

#### 5.1.1 Opening Camera

When you open Camera, the preview screen orientation will depend on how you are holding the phone.

**Tips** You can easily switch to the other capture mode when you take pictures or video.

#### 5.1.2 Closing Camera

On the Camera screen, press HOME or BACK.

#### 5.1.3 Taking pictures

1. Place **Photo** capture mode.
2. Frame your subject on the screen.
3. Touch 

#### **Tips:**

Hold the phone upright when taking portrait shots or hold the phone horizontally when taking landscape shots. By doing this, you do not need to rotate the photo after capturing it.

#### 5.1.4 Shooting videos

1. Place on the **Video** capture mode.
2. Frame your subject on the screen.
3. Press the  to start capturing video.

#### 5.1.5 Review screen

After capturing a photo, the review screen lets you view, send, or delete the picture by tapping a button at the bottom of the screen.

#### 5.1.6 Camera menu panel

The Camera menu panel lets you adjust basic camera settings and see the **Gallery**.

### **5.1.7 To open the menu panel**

While on the Camera screen, tap parameter icon, select the appropriate parameters, as shown below.

## **5.2 Using Gallery**

**Albums** lets you view photos and play back videos. For photos, you can also do basic editing tasks, set them as your wallpaper or contact picture, and share to your friends.

### **5.2.1 Opening Gallery**

If you stored your files in folders (directories) on the storage card, Albums will display these folders as separate albums.

**All pictures** contain all the pictures inside all the albums. The album name and number of files are inside. Tap to view pictures in Albums or pictures in your Picasa or Flickr account.

**All videos** contain all the videos inside all the albums. Tap to view the files inside the album.

**Note** Depending on the number of pictures stored on the storage card, it may take a while for Albums to load all your photos on the screen.

### **5.2.2 Working with pictures**

Once you have taken a picture, you can view it or share it with friends.

#### **To view pictures in Gallery**

1. Go to the Gallery screen, and then tap an album to view the pictures inside the album.
2. Tap the thumbnail to view it in full screen.

When viewing pictures in full screen, you can:

- Roll it left to view the previous picture, or roll it right to view the next picture in the album or in the pictures list.
- Press MENU to let you view the pictures as a slideshow, share, delete, or rotate the picture, and more.

#### **To zoom in or out on a picture**

1. "Pinch" the screen using 2 fingers (for example, thumb and index fingers) to zoom in or zoom out.
2. Double-click to zoom in or out when viewing a picture.

#### **To rotate and save the rotated state**

1. View the picture you want to rotate in full screen.
2. Press MENU, then tap **Rotate**, and then select either **Rotate left** or **Rotate right**.



**Note:** The Picture rotates 90 degrees counter-clockwise (Rotate left) or 90 degrees clockwise (Rotate right) each time you tap one of the Rotate options.

### **To crop a picture**

1. While viewing a picture in full screen, press MENU and then tap **More > Crop**. The crop tool appears.
2. Do one of the following:
  - To adjust the crop size, press and hold the edge of the crop tool. When the crop arrows appear, drag your finger inward to or outward from the center of the crop to resize it.
  - To move the crop to another area on the picture, press and hold inside the crop, then drag it with your finger to the desired position.
3. Tap **Save** to apply the changes to the picture.

**Note:** The cropped picture is saved in the storage card as a copy. The original picture remains unedited.

### **To share a picture on Picasa**

You need to be signed in to a Google Account to be able to upload pictures to the Picasa™ photo organizing service.

1. In the Albums screen, open the album where the pictures you want to share are in.
2. Tap the picture you want to share.
3. Tap MENU and then on the **Share** options menu, tap **Picasa**.
4. Enter a **Caption** for the picture and select the **Album** where you want to upload the picture.

### **5.2.3 Working with videos**

Once you have taken a video, you can view it or share it with friends.

#### **To watch videos**

1. On the main Albums screen, tap a video album and then tap the video you want to watch to start playing back the video.
2. Select the videos. Tap the thumbnail to view it in full screen. The screen automatically switches to landscape mode when you play back a video.

### **5.2.4 Adding the Photo album or Photo frame widget**

Add the Photo frame or Photo album widget to let you view a single photo or a whole album on the Home screen.

### **5.2.5 Closing Albums**

While in the Albums screen, press HOME or BACK to close the application.

## **5.3 Using Music**

### **5.3.1 Copying music into the storage card**

- Set the phone's storage card as a USB drive.
- On the computer, navigate to the USB drive and open it.
- Create a folder on the root folder of the storage card (for example, Music).

**Tips** You can also create and use folders to organize your music inside the Music folder you have created.

- Copy the music into the folder you have created.
- After copying music, eject the drive as required by your computer's operating system to safely remove the phone.
- Disconnect the phone from the computer.

### **5.3.2 Opening Music**

#### **Notes:**

- Press the "alt" "i" keys or "alt" "o" keys to adjust the playback volume.
- If you are using the wired headset to listen to music, press the center button to toggle between playing and pausing playback. Press the previous or next buttons to go to the previous or next song.

### **5.3.3 Library**

Your music is organized into different categories such as Albums, Artists, Genre, Composers, and more. Select a category by tapping one of the category tabs at the bottom of the screen. Tap a song in the category to play it back.

To go to the Library, tap MENU and select **Library**.

### **5.3.4 Creating playlists**

Use playlists to organize your music files. You can create as many playlists as you want on your phone.

1. In the Library, select and hold a song.
2. Tap **add to playlist**, select **New**.
3. Enter the **Playlist name** and then tap **Save**.
4. Select a category to add songs from to the playlist.

**Tips:** Go to the **Select music track** category to show all the available songs.

5. Select the songs you want to add to the playlist and then tap **Add**.

### 5.3.5 Managing your playlists

#### To play the songs in a playlist

In the Playlists screen, tap the playlist name and then tap a song.

#### To add songs to a playlist

1. In the Playlists screen, tap the playlist where you want to add songs.

2. Press MENU and then tap **Add songs**.

3. Select a category to add songs from to the playlist.

**Tips:** Go to the **Select music track** category to show all the available songs.

4. Select the songs you want to add to the playlist and then tap **Add**.

**Tips:** While playing back a song, press MENU and then tap **Add to playlist** to add the current song to a playlist.

#### To rearrange the songs in a playlist

1. In the Playlists screen, tap the playlist you want to edit.

2. Press MENU and then tap **Change order**.

3. Press and hold  at the end of the song title you want to move. When the row is highlighted in green, drag it to its new position, then release.

4. Tap **OK**.

#### To delete a song in a playlist

1. In the Playlists screen, tap the playlist you want to edit.

2. Press MENU and then tap **Delete songs**.



3. Select the songs you want to delete and then tap **Delete**.

#### To delete a playlist

1. In the Playlists screen, press MENU and then tap **Delete playlists**.

2. Select the playlists to delete and then tap **Delete**.

#### To change the music to the next/last one

In music playing screen, double tap  to the last one, or double tap the icon  to the next one

### 5.3.6 Setting a song as ringtone

You can use songs as your phone ringtone.

1. In the Library, select the song that you want to use as ringtone and then play it back.

2. In the Playback screen, press MENU and then tap **Set as ringtone**.

3. To set as ringtone, go to options menu, tap **Phone ringtone** or **Contact ringtone**.

**Note:** If you select **Contact ringtone**, you need to select the contacts you want to associate the song with in the next screen.

### 5.3.7 To check if the song was added as a ringtone

1. On the Home screen, press MENU and then tap **Settings**.

2. On the Settings screen, tap **Sound & display > Phone ringtone**. The song should be listed as an option.

### **5.3.8 Adding the Music widget**

Add the Music widget to control music playback on the Home screen.

## **Chapter 6 - Google Apps**

### **6.1 Signing in to your Google Account**

Signing in to your Google Account lets you synchronize Gmail/Google Mail, Calendar, and Contacts between your phone and the web. You also need to sign into a Google Account to use Google Apps such as Google Talk™ and Google Play. When you turn on the phone for the first time, you are given the option to sign in to your Google Account.

1. In the Setup accounts screen, tap Google account > Yes > Next.
2. Tap Sign in. Enter your user name and password, and then tap Sign in. After signing in, all emails, contacts, and calendar events on your Google Account will automatically synchronize with your phone.

**Note:** Tap Create if you do not have a Google Account yet.

#### **6.1.1 Retrieving your Google Account password**

If you forgot your Google Account password, you can retrieve it by doing the following:

1. On your computer, open your browser and go to <http://google.com/accounts>.
2. On the right side of the page, click **I cannot access my account**.
3. In the **Please select your issue** section, select **I forgot my password**.
4. Click **Reset your password now**, and then follow the procedure on how to recover your password.

### **6.2 Using Gmail/Google Mail**

Gmail/Google Mail is Google's web-based email service. Gmail/Google Mail is configured when you first set up your phone. Depending on your synchronization settings, Gmail/Google Mail on your phone is automatically synchronized with your Gmail/Google Mail account on the web.

### 6.2.1 To open Gmail/Google Mail

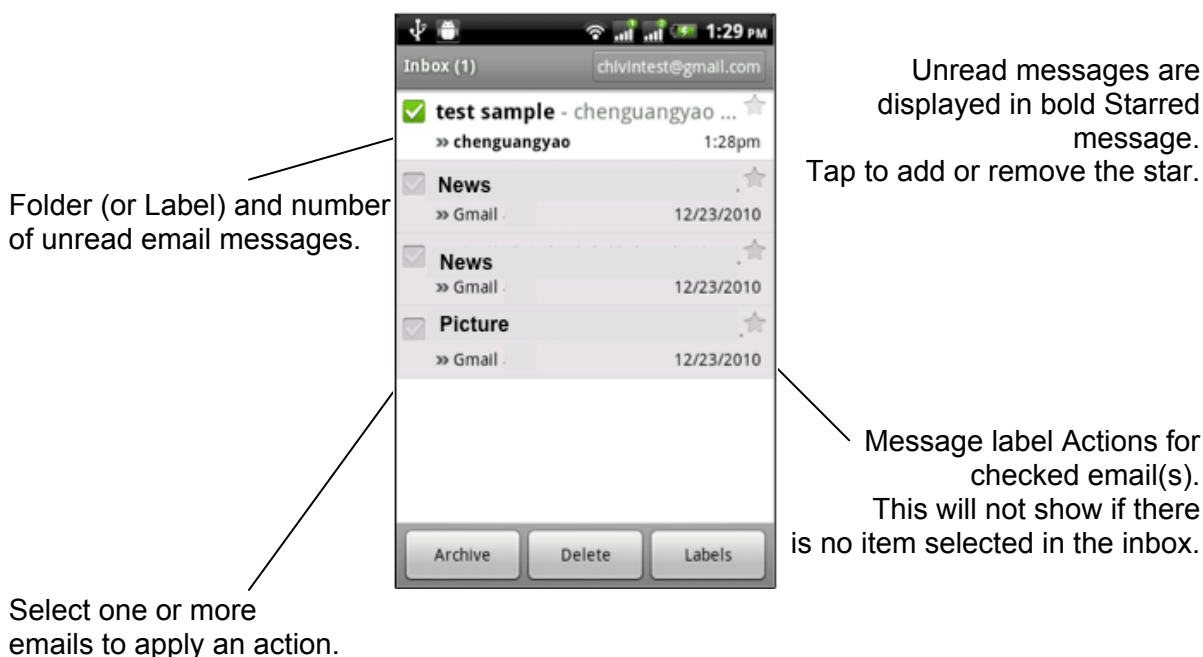

The Inbox conversations list (here in after referred to as Inbox) is your default Gmail/Google Mail view. All your received emails are delivered to your Inbox.

### 6.2.2 To refresh Gmail/Google Mail

Press MENU and then tap Refresh to send or receive new emails and to synchronize your emails with your Gmail/Google Mail account on the web.

### 6.2.3 Creating and sending emails

#### To create and send an email

1. In the Inbox, press MENU and then tap Compose.
2. Enter the message recipient's email address in the **To** field. If you are sending the email to several recipients, separate the email addresses with a comma. You can add as many recipients as you want.

**Note:** If you want to send a carbon copy (Cc) or a blind carbon copy (Bcc) of the email to other recipients, press MENU and then tap Add Cc/Bcc.

3. Enter the email subject, and then compose your email.

**Tips:** If you want to add a picture attachment, press MENU and then tap Attach. Select the picture you want to attach, and then tap OK.

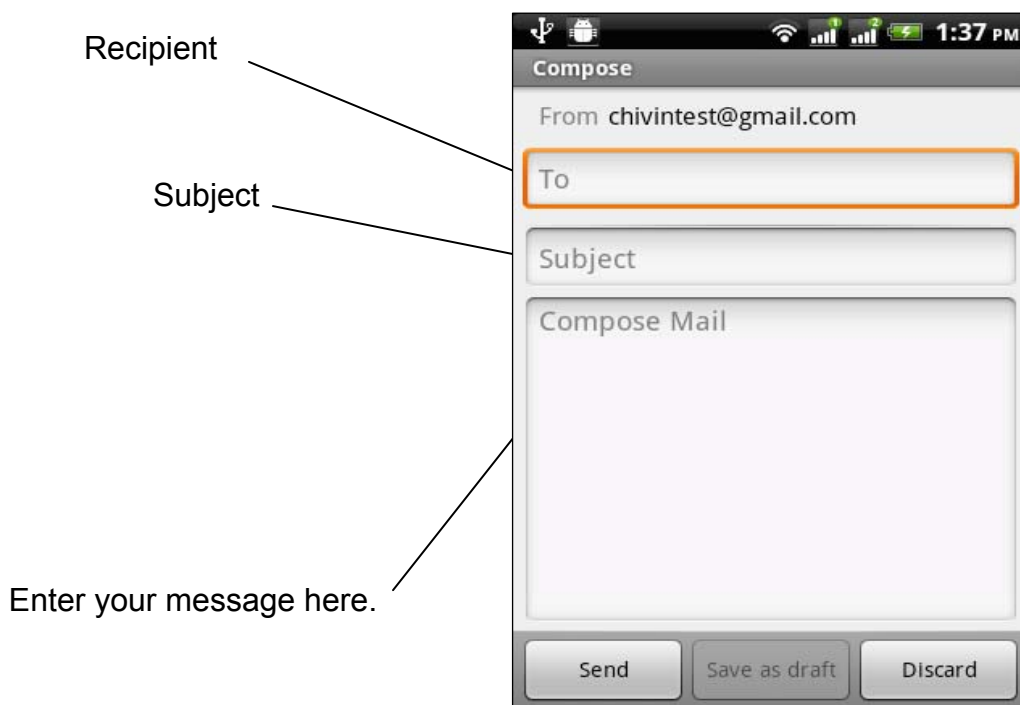

4. After composing your email, tap Send.

**Note:** While composing the message, tap Save as draft or press the BACK button to save it as a draft. To view your draft email messages, in the Inbox, press MENU and then tap View labels > Drafts.

### **To add a signature to emails**

You can add a signature to email messages that you send.

1. In the Inbox, press MENU and then tap Settings > Signature.
2. Enter your signature in the text box, and then tap OK.

**Tips** You can create a signature consisting of multiple lines of text. At the end of each line of text, tap ENTER on the onscreen keyboard to create another line.

### **To view your sent messages**

In the Inbox, press MENU and then tap View labels > Sent.

### **6.2.4 Receiving and reading emails**

Depending on your notification settings, the phone plays a ring tone, vibrates, or displays the email message briefly in the status bar when you receive a new email. A new email message (  ) icon also appears on the notifications area of the status bar to notify you of a new email.

Gmail/Google Mail groups each message you send with all the responses you receive. This conversation list continues to grow as new replies arrive, so you can always see your messages in context. Conversations are also referred to as message threads. A new message or a change to the subject of a current message will begin a new thread.

### To view emails

Do one of the following:

- Press HOME, then press and hold the status bar, and then slide down your finger on the screen to open the Notifications panel. Tap the new email to view it.
- While in the Inbox, tap the unread email or the conversation with the unread email to view it.

Message subject

Message label

Online status.

Appears when the contact is a Google Talk friend and you are signed in to Google Talk.

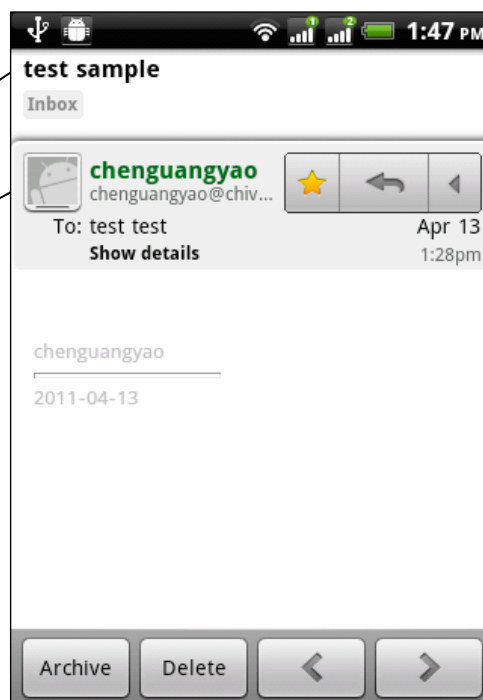

### To search for email messages

You can search for a specific email message by sender, word in a subject, or label.

1. In the Inbox, press MENU and then tap Search.
2. Enter the search keyword in the box, and then tap Search.

## 6.2.5 Replying to or forwarding emails

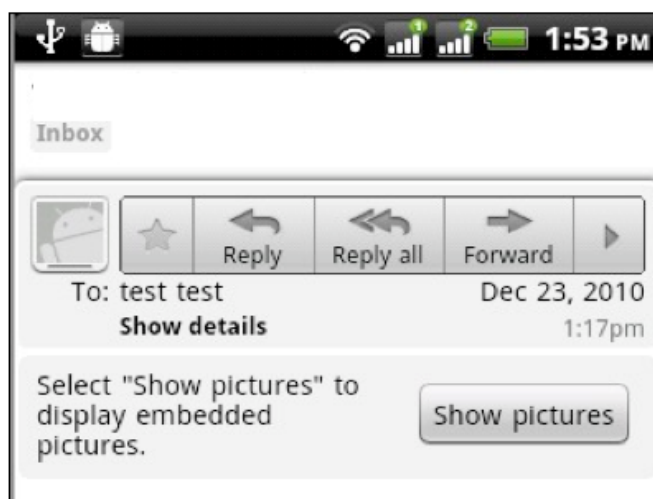

## 6.2.6 Managing conversations and emails

### Conversations

- **Read** to open the email.
- **Archive** to archive the conversation.

**Tips** :To display your archived messages, in the Inbox, press MENU and then tap

### View labels > All Mail.

- **Mute** to mute the entire conversation.
- Tips**: If you're part of a long message conversation that isn't relevant, you can 'mute' the conversation to keep all future additions out of your Inbox.
- **Mark read or Mark unread** as desired. Unread messages are displayed in bold in the Inbox.
  - **Delete** to delete the conversation.
  - **Add star or Remove star** to assign a star or remove the star on the conversation
  - **Change labels** to add or change the label of the conversation.
- Note**: You cannot use the phone to create labels; do that on the Gmail/Google Mail web site.
- **Report spam** to report the conversation as spam.

### Email messages

- **Archive** to archive the email message.
- Tips**: To display your archived messages, in the Inbox, press MENU, and then tap View labels > All Mails.
- **Add star or Remove star** to assign a star or remove the star on the conversation.
  - **Mark read or Mark unread** as desired. Unread messages or threads with unread messages display in bold in the Inbox.
  - **Change labels** to add or change the label of the conversation.
- Note**: You cannot use the phone to create labels; do that on the Gmail/Google Mail web site.



- **Delete** to delete the email message.
- **More >**
- **Back to Inbox** to return to your Inbox.
- **Mute** to mute the entire conversation.

**Tips:** If you're part of a long message conversation that isn't relevant, you can 'mute' the email to keep all future additions out of your Inbox.

- **Report spam** to report the email message as spam.

### 6.2.7 Setting Gmail/Google Mail settings

1. In the Inbox, press MENU and then tap **Settings**.

2. Set the following options:

- **Signature** Tap to enter a signature that is appended at the end of your emails.
- **Confirm delete** Select the check box to show a confirmation box when you delete a conversation.
- **Batch operations** Select the check box to show the batch operations feature. The Batch operations feature lets you archive, delete, or apply a label to multiple emails at once.
- **Labels** Tap to select which Gmail/Google Mail labels to synchronize.
- **Email notifications** Select the check box to show a notification icon on the status bar when you receive a new email.
- Tap **Select ringtone** if you want your phone to ring when a new email message arrives. On the ring tone menu, select a ring tone specific to new email messages. The ring tone plays briefly when selected. If you don't want a ring tone to play when you receive a new email message, tap **Silent**. Then tap **OK** to confirm your ringtone selection.
- Select **Vibrate** if you want your phone to vibrate when you receive a new email message

## 6.3 Using Google Talk

Google Talk is Google's instant messaging program. It lets you communicate with other people that also use Google Talk .

**Note:** The Google Talk account that is set up is based on the Google Account that you used when you set up the phone

### 6.3.1 Sign in and chat online

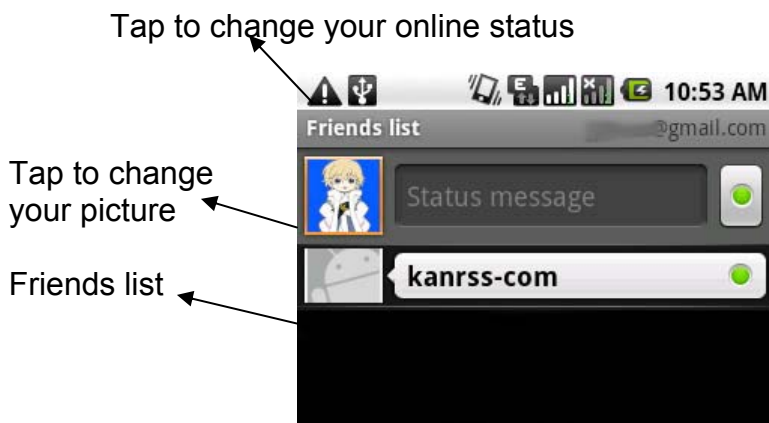

### To add a new friend

You can only add people who have a Google Account.

1. In the Friends list, press MENU and then tap **Add friend**.
2. Enter the Google Talk instant messaging ID or Google email address of the friend you want to add.

**Note:** When you add a friend with an instant messaging ID and has been saved in your contacts list, matching contacts will display on the screen as you enter information. You can tap the contact or continue entering the IM information.

3. Tap **Send invitation**.

### To view and accept an invitation

1. In the Friends list, press MENU and then tap **Invites**. All chat invitations you have sent or received are listed on the pending invitations screen.

2. Tap a pending invitation, and then tap **Accept** or **Decline**.

**Note:** When someone you invite to chat accepts your invitation, the pending invitation disappears from the list.

### To change your online status and message

1. Tap the online status icon beside your name, and then select the status you want on the menu.
2. Tap the text box on the left of your online status icon and then enter your status message using the keyboard.
3. Tap ENTER.

### To start a chat

1. Start a chat

Timestamp appears after every minute of inactivity.

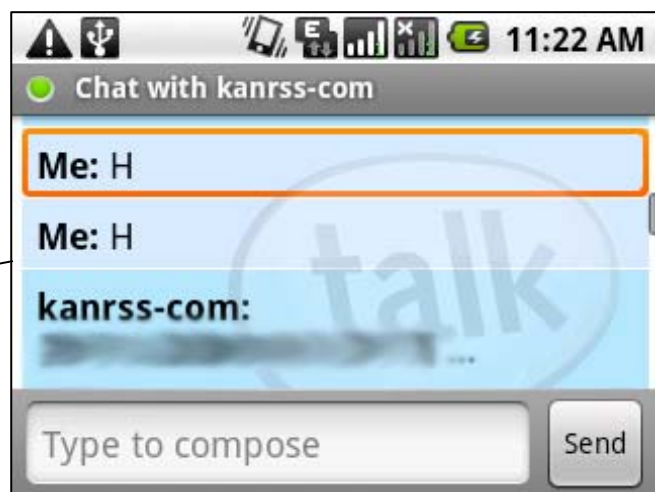

2. Chat with your friend by entering text using the onscreen keyboard.

**Note:** To insert a smiley, press MENU and then tap **Insert smiley**. Tap a smiley to insert it into your message.

3. After entering your message, tap **Send**.

## To switch between active chats

You can switch between chats if you have more than one chat going.

1. While on a chat screen or in the friends list, press MENU and then tap **Switch chats**.
2. On the panel that opens, tap the friend you want to chat with.

Tap to switch chat with this friend

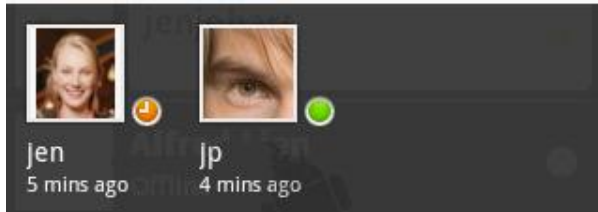

## To close a chat

Do one of the following:

- In your Friends list, press and hold a friend with an active chat and then tap **End chat** on the menu.
- While on a chat screen, press MENU and then tap **End chat**.

## 6.3.2 Managing your friends

Friends in your friends list is sorted by their online status — active chats, online, busy, and offline. Within the status groupings, friends are listed alphabetically.

By default, only the friends that you frequently communicate with — the most popular — are in the Friends list. If you want to display all your friends, press MENU and then tap **All friends**.

**Tips** To switch back to displaying only your most popular friends, press MENU and then tap **Most popular**.

## To block a friend

You can block a friend from sending you messages. When blocked, your friend is also removed from your Friends list.

1. In the Friends list, locate the friend you want to block.

**Note:** If you cannot see the friend, Press MENU and then tap **All friends**.

2. Press and hold the friend's name, and then tap **Block friend**.

Your friend is removed from your friends list and is added to the blocked friends list.

**Note:** To unblock a friend, in the Friends list, press MENU and then tap **Blocked**. In the Blocked friends list, tap the name of the friend you want to unblock, and then tap **OK** when prompted.

## To pin a friend

You can pin a friend to make sure that friend always appears in your **Most popular** friends list.

1. In the Friends list, press and hold the friend's name to open the options menu.

**Note:** If you cannot see the friend, Press MENU and then tap **All friends**.

2. Tap **Pin friend**.

**Note:** To unpin a friend, in the Friends list, press and hold the friend you want to unpin and then tap **Unpin friend** on the options menu.

#### **To show a friend in the Most popular list**

1. In the Friends list, press and hold the friend's name to open the options menu.

**Note:** If you cannot see the friend, Press MENU and then tap **All friends**.

2. Tap **Show friend**.

**Note:** To keep a friend from appearing in the most popular list, press and hold the friend's name, and then tap **Hide friend** on the menu. If you pinned the friend, the pin will be removed when you hide the friend.

### **6.3.3 Mobile indicators**

You can check what type of device your friend is using to chat in Google Talk. In the friends list, check the image that appears to the right of your friend's name.

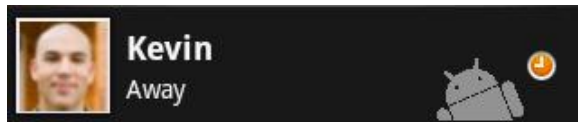

Indicates that the friend is using an Android phone

When you do not see an image, it indicates that your friend signed in last from a computer.

You can also choose to show a mobile indicator. To show:

1. In the Friends list, press MENU and then tap **More > Settings**.

2. Select the **Mobile indicator** option, and then press BACK. The mobile indicator icon will display along with your name in other people's Friends list and will let your friends know what type of mobile device you are using.

### **6.3.4 Adjusting instant messaging settings**

#### **To set notifications for new instant messages**

You can set the phone to play a sound, vibrate, or display a notification icon in the status bar each time you receive a new instant message.

1. In the Friends list, press MENU and then tap **More > Settings**.

2. Do one or all of the following:

- Select the **IM notifications** check box to receive a notification  in the status bar when a new instant message arrives.
- Tap **Select ringtone** to select the ring tone to use when a new instant message arrives. The ring tone briefly plays when selected. If you don't want a ring tone to play when you receive a new instant message, select **Silent**.
- Select the **Vibrate** check box to vibrate your phone when you receive a new instant message.

### **To sign in automatically**

You can sign in to your Google Talk account automatically every time you turn on your phone.

1. In the Friends list, press MENU and tap **More > Settings**.
2. Select the **Automatically sign in** check box.
3. Press BACK to save your setting.

### **6.3.5 Sign out**

In the friends list, press MENU and then tap **Sign out** when you want to sign out from Google Talk.

## **6.4 Using Google Maps**

**Google Maps** lets you track your current location, view real-time traffic situations, and receive detailed directions to your destination. It also provides a search tool where you can locate places of interest or an address on a vector or aerial map, or view locations in street level.

### **Notes**

- You need an active data (GPRS) or Wi-Fi connection to use Google Maps.
- The Google Maps application does not cover every country or city.

### **6.4.1 To enable Location source**

Before you open Google Maps and find your location or search for places of interest, you must enable **My location sources**.

1. Press HOME > MENU and then tap **Settings > Location & Security**.
2. Select **Use wireless networks** .

### **6.4.2 To find your location on the map**

Open the map, automatically locate your location.

### **6.4.3 Searching for places of interest**

1. On the Google Maps screen, press **Search**.
2. Enter the place you want to search in the search box. You can enter an address, a city, or type of business or establishment (for example, museums in London).



**Tips:** As you enter information, a list of all the places which you have searched or visited before appears on the screen. You can also tap an address on the menu to show its location on the map.

3. Tap SEARCH. The search results are displayed on the map.
4. Tap the callout to show the **Address**, **Details** (if available), and **Reviews** (if available) for the search item.

#### 6.4.4 Viewing maps

While viewing a map, take advantage of the following zoom and navigation techniques.

##### To zoom in or out on a map

Tap  to zoom in; tap  to zoom out.

##### To change map modes

When viewing a map you can switch to another map mode.

Tap **Layers** icon (  ). Select from **Traffic**、**Satellite**、**Terrain**、**Latitude**.

#### 6.4.5 Getting directions

Use Google Maps to get detailed directions to your destination.

1. While viewing a map in any mode, press MENU and then tap **Directions**.
2. Enter the starting point in the first text box, then enter your destination in the second text box. By default, your current location is entered in the **Starting point** box.



You can also tap  to open the location source menu and select a starting point and destination address.

3. Choose how you want to get to your destination: **Driving**, **Public transit**, or **Walking**.

4. Tap **Go**. The directions to your destination appears in a list. Tap a direction instruction on the list to show the map.

When you are finished viewing or following the directions, press MENU and then tap **More > Clear map** to reset the map. Your destination is automatically saved in the Google Maps history.

#### 6.5 Using Google Latitude (Available by Country)

**Google Latitude**™ user location service lets you and your friends share locations and status messages with each other. It also lets you send instant messages and emails, make phone calls, and get directions to your friends' locations.

Your location is not shared automatically. You must join Latitude, and then invite your friends to view your location or accept their invitations.

### ***6.5.1 Opening Latitude***

While viewing a map in any mode, press MENU and then tap **Latitude**.

### ***6.5.2 Sharing your locations***

After you join Latitude, you can start sharing your locations with your friends. Only friends that you have explicitly invited or accepted can see your location.

### ***6.5.3 Inviting friends***

**To share your location with friends and request to see their locations**

1. In Latitude, press MENU and then tap **Add friends**.
2. Choose how to add friends:
  - **Select from Contacts**. Select any number of friends from your Contacts. Friends who already use Latitude have a  icon next to their names.
  - **Add via email address**. Enter an email address.
3. Tap **Add friends**.
4. Tap **OK**.

If your friends already use Latitude, they receive an email request and a notification on Latitude. If they have not yet joined Latitude, they receive an email request that tells them to sign in to Latitude with their Google Account.

### ***6.5.4 Accepting an invitation***

When you get a sharing request from a friend, you can:

- **Accept and share back**. You can see your friend's location, and your friend can see yours.
- **Accept, but hide my location**. You can see your friend's location, but they can't see yours.
- **Don't accept**. No location information is shared between you and your friend. You can change how your location is shared with each friend at any time.

### ***6.5.5 Showing your friends***

You can show your friends using the map view or the list view.

#### **Map view**

When you open Google Maps, it shows your friends' locations. Each friend is represented by a photo icon with an arrow pointing at his or her approximate location. If a friend has opted to enable city-level sharing, his or her icon will not have an arrow and it appears in the middle of the city.

To see your friend's profile and connect with him or her, tap the photo.

This will display your friend's name, then tap the balloon right above his or her icon.

To see other friends, tap either one of the arrow buttons next to the balloon.

### List view

To show a list of your friends, in Google Maps, press MENU and then tap **Latitude**. To see a friend's profile and connect with him or her, select your friend's name from the list.

### 6.5.6 Connecting with your friends

Tap a friend's contact details balloon in map view or tap a friend in list view to open the friend's profile. In the profile screen, you can communicate with your friend and set privacy options.

Options	Description
<b>Show on map</b>	Find a friend's location on the map.
<b>Chat using Google Talk</b>	Send an instant message. Google Talk opens a chat window with that friend.
<b>Send email</b>	Send an email. Gmail/Google Mail opens an email addressed to that friend.
<b>Directions</b>	Get directions to the friend's location.
<b>Hide from this friend</b>	Stop sharing your location with this friend. Your friend cannot see your photo icon on the map. To share your location with this friend again, tap <b>Unhide</b> from this friend.
<b>Share only city level location</b>	Share only the city you are in, not the street-level location. Your friend can see your photo icon in the middle of the city you are in. To share more precise location again, tap <b>Best available location</b> .
<b>Remove</b>	Remove the friend from your list and stop sharing locations with him or her altogether.



### 6.5.7 Controlling what you share

#### To change your public profile

1. In Google Maps, press MENU, tap **Latitude**, and then tap your contact details balloon.
2. Set the following options to your preferences.

Options	Description
<b>Show on map</b>	See your location on a map.
<b>Send location to others</b>	You can select Messaging, Bluetooth, Email, or Gmail to share you location.
<b>Change your photo</b>	Change the picture, which is also shared across other Google products and features. After you tap <b>Change your photo</b> , you can either take a picture of yourself with the phone or select a picture from Albums.
<b>Edit privacy setting</b>	Manage how your location is shared with all your friends. Select one of the following options: <b>Detect your location.</b> Let Latitude automatically detect and update your location as you move around. The update frequency is determined by several factors, such as your phone's battery charge level and how recently your location has changed. <b>Note</b> You must have My location sources enabled. To learn how to enable My location sources, refer to "Using Google Maps" in this chapter. <b>Set your location.</b> Manually select a location on the map. <b>Hide your location.</b> Hide your location from all your friends. They will not be able to see your location on their maps. You can also hide your location only to certain individuals. <b>Sign out of Latitude.</b> Disable Latitude and stop sharing. Your friends cannot see your location. You can always join Latitude again.

### 6.6 Using Google Play

**Google Play** provides direct access to useful applications and fun games which you can download and install on your phone. Google Play also allows you to send feedback and comments about an application, or flag an application that you find objectionable or incompatible with your phone.

### 6.6.1 Opening Google Play

When you open Google Play for the first time, the Terms of Service window will appear. Tap **Accept** to continue.

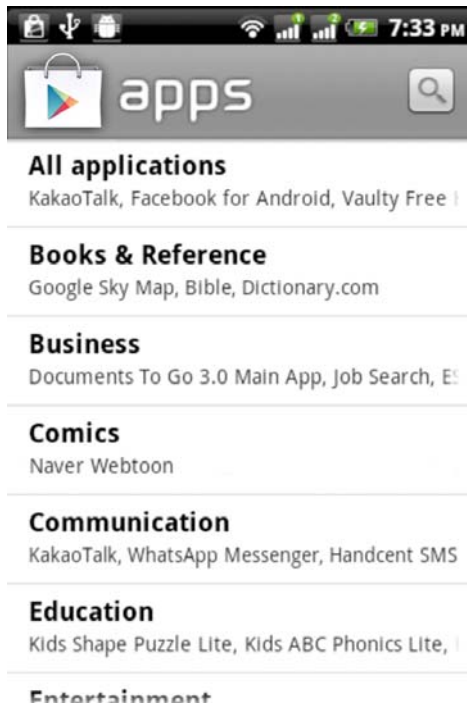

Press Menu

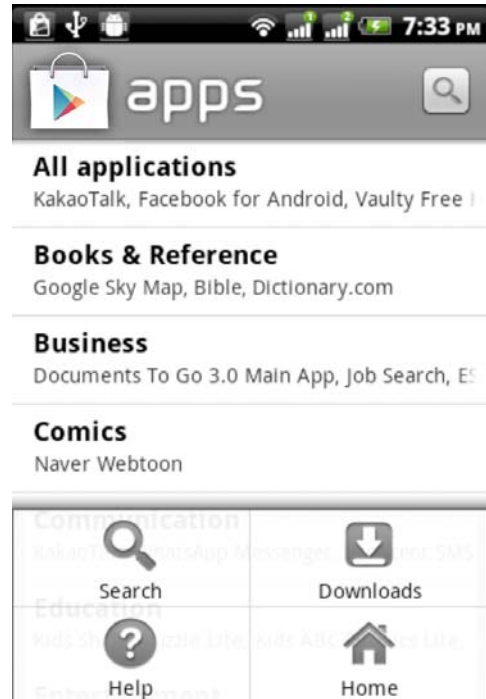

### 6.6.2 Getting help

If you ever need help or have questions about Google Play, press MENU and tap **Help**. The Browser will take you to the Google Play Help webpage.

### 6.6.3 Installing and opening an application

1. Navigate to the item you want to download, and select it.
2. In the item details screen, read more about the application, including its overall rating, and comments by users.

If you scroll down to the About the developer section, you can view more applications by this developer, visit the developer's website, and send the developer an email message.

**Important:** Press MENU and select **Security** to view the functions and data this item can access on your phone.

Scroll down to view more of this developer's applications or to email the developer.

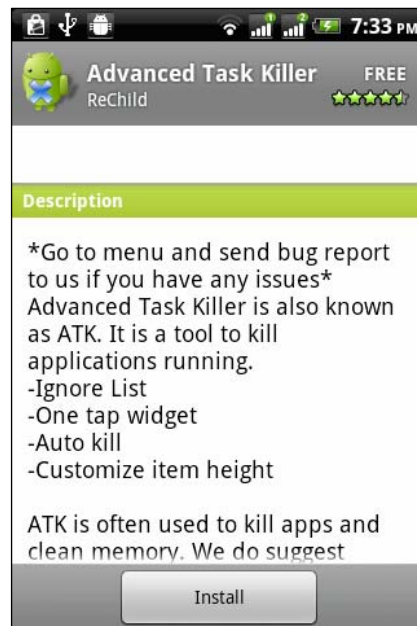

3. On any application details screen, tap **Install**.

**Important:** If the application requires either access to any of your data or control of any functions on your phone, Market tells you what the application can access.

**Read it carefully!** Be especially cautious with applications that have access to many functions or a significant amount of your data. Once you tap **OK** on this screen, you are responsible for the results of using this item on your phone. Tap **OK** if you agree to the conditions of the application.

4. To check the progress of the download, open the Notifications panel. Most applications are installed within seconds. If you want to stop downloading the item, tap **Cancel download**.

Download progress appears in the **On going** section of the notifications window.

Once downloaded and installed, a notification appears.



5. After the item is downloaded and installed on your phone, the content download icon (  ) appears in the notification area of the status bar.

6. On the Google Play screen, tap **My downloads**.

7. Tap the installed application in the list, then tap **Open**.

**Tips:** You can also find the icon of the installed application on the All programs screen.

### 6.6.4 Managing applications

From the Google Play Home, tap My downloads to view your downloaded items. From any of the Google Play screens, press MENU and tap **My downloads** to go to the screen.

### 6.6.5 Uninstalling an application

You can uninstall any application that you have downloaded and installed from Google Play.

1. On the My downloads screen, tap the application you want to uninstall, then tap **Uninstall**.

2. When prompted, tap **OK** to remove the application on your phone.

3. Choose the reason for removing the application, then tap **OK**.

### 6.7 Synchronizing Google Apps

Google Apps on your phone, such as Gmail/Google Mail, Calendar, and Contacts, give you access to the same personal information (emails, events, and contacts) that you add, view, and edit on your computer using Gmail/Google Mail or Calendar. Synchronize the Google Apps you want to keep information up-to-date.

#### To select which application to synchronize

1. Press HOME > MENU.

2. Tap **Settings > Accounts & sync**.

**Note:** By default, all personal information in Gmail/Google Mail, Calendar, and Contacts will sync whenever you make a change or receive a new message.

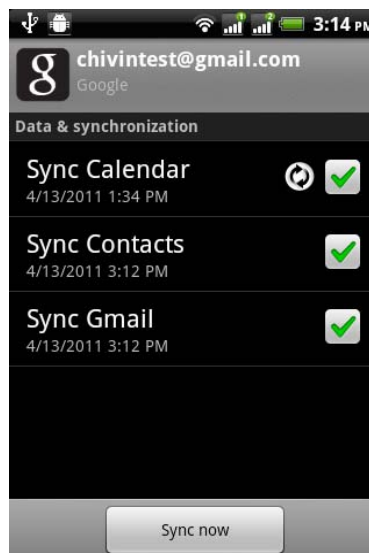
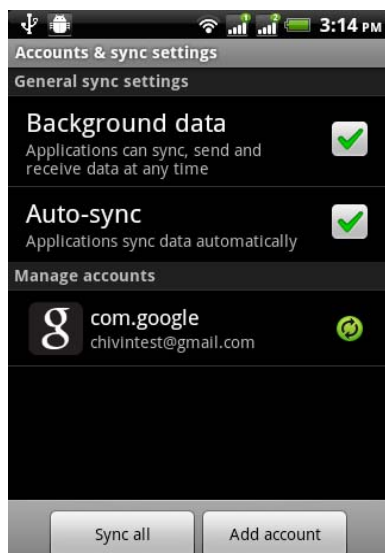

3. Select the Google Apps you want to synchronize.

**Tips:** Select **Auto-sync** to automatically synchronize all applications. When **Auto-sync** is disabled, you can synchronize individual applications manually by selecting their respective check boxes

### To stop synchronization

During synchronization, press MENU, then tap **Cancel sync** to stop synchronization.

## 6.8 Using Calendar

Use **Calendar** to create and manage events, meetings, and appointments.

Depending on your synchronization settings, the Calendar on your phone stays in sync with your Calendar on the web, and Outlook calendar.

### 6.8.1 Creating events

1. On any Calendar view, press MENU and then tap **New** to open the Event details screen.

2. Enter the event name using the keyboard.

3. Do one of the following:

- If there is a time frame for the event, tap the **From** and **To** date and time to set them. If it is a special occasion such as a birthday or a whole-day event, set the **From** and **To** date, then select the **All Day** check box.

4. Enter the event location and description.

5. If you have more than one calendar, select the **Calendar** where you want to save the event.

6. Set the event reminder time in **Reminders**, then select whether the event is recurring in **Repeat**.

**Note** Press MENU and then tap **Add reminder** to add another reminder.

7. When finished, tap **Add**.

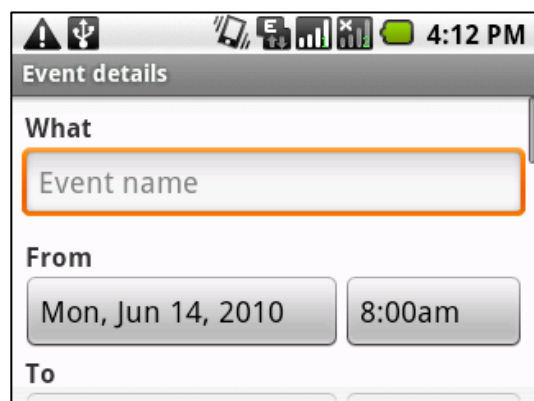

### 6.8.2 Calendar views

You can display the Calendar in daily, weekly, monthly, or agenda view. To change the Calendar view, press MENU, then tap **Day**, **Agenda**, or **Month**.

#### Day view

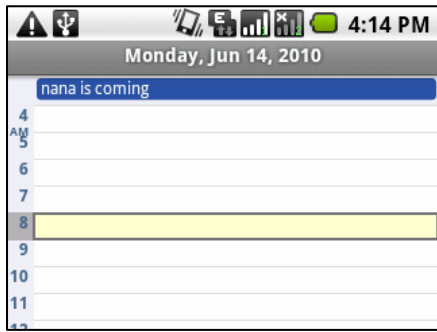

Tap to open event details.

Colored bars indicate which calendar the event was created in.

### Agenda and Month views

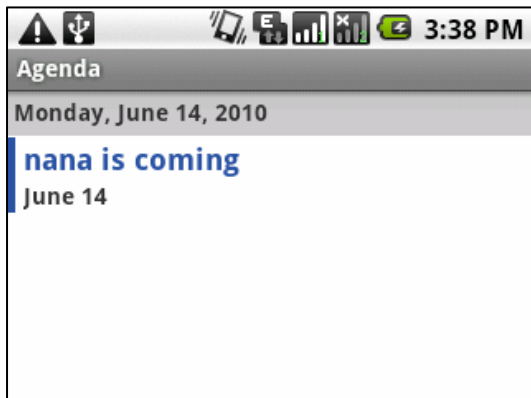

Tap to open event details.

Colored bars indicate which calendar the event was created in.



Indicates there are events for that day.  
Tap to view events for that day.

- Swipe your finger up or down to view more events in Agenda view or to go to the previous or next month in Month view.
- In Month view, press and hold a day to open a menu to let you quickly create an event, show the day's events, or switch to Agenda view.

### 6.8.3 Event reminders

If you have set at least one reminder for an event, the upcoming event icon (  ) will appear in the notifications area of the status bar to remind you of the upcoming event.

#### To view, dismiss, or snooze the reminder

1. Tap the status bar, then slide your finger down the screen to open the Notifications panel.

2. Tap the upcoming event name to display the event.

**Note:** If you have other pending event reminders, these events will also appear on the screen.

3. Do one of the following:

- Tap **Snooze all** to snooze all event reminders for five minutes.
- Tap **Dismiss all** to dismiss all event reminders.
- Press BACK to keep the reminders pending in the notifications area of the status bar.

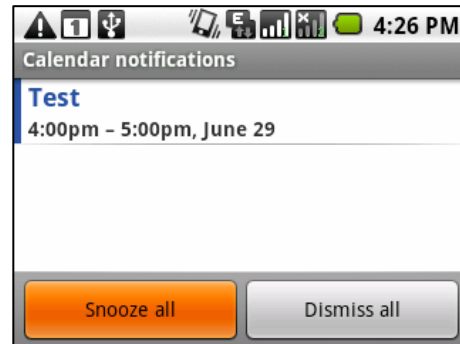

### 6.8.4 Adding the Calendar widget

Add the Calendar widget to let you view your calendar and access your appointments on the Home screen.

## Chapter 7 - Other Applications

### 7.1 Using Clock

**Clock** lets you view the date and time of cities around the world. You can also set alarms and use the stopwatch and timer.

#### 7.1.1 Opening Clock

Tap the clock on the Home screen.

#### 7.1.2 Setting an alarm

1. Tap one of the default alarms on the screen.

2. In the Set alarm screen, set the alarm time by sliding your finger up or down on the numbers and AM/PM.

3. Enter the alarm **Description**, set the **Alarm sound** and **Repeat**, and select the **Vibrate** checkbox if you want the phone to also vibrate when the alarm goes off.

**Note:** Scroll up the screen to see all the Alarm options.

4. Tap **Done**.

**Note:** If you need to set more than an alarm, you can add more alarms by tapping **Add alarm**.

### **7.1.3 Deleting an alarm**

1. On the **Alarms**, select the alarm you want to delete. tap **Delete**.

2. Tap **MENU**, and then tap **Delete**.

**Note:** Or press and hold the alarm, and tap **Delete alarm**

### **7.1.4 Adding the Clock widget**

Add another clock with the time of another city in the world on the Home screen.

## **7.2 Using Global Time**

### **7.2.1 Setting the local date, time zone, and time**

By default, your phone automatically uses the network-provided date, time zone, and time. You can set the date, time zone, and time manually.

1. In **Global Time**, go to the **World Clock** tab, press **MENU**, and then tap **Local time settings**.

**Tips:** You can also press **HOME > MENU**, and then tap **Settings > Date & time**.

2. Tap **Set date**. On the Change date window, adjust the date by scrolling the date wheel. Tap **Done** when finished.

3. Tap **Select time zone**, then select the time zone in the list. Scroll down the list to view more time zones.

4. Tap **Set time**. On the time window, adjust the time by scrolling the time wheel. Tap **Done** when finished.

5. Select the **Use 24-hour format** check box to toggle between using a 12-hour or a 24-hour format.

6. Tap **Select date format** then select how you want dates to display on your phone. The selected date format also applies to the date displayed in the Alarm Clock.

### **7.2.2 Adding cities to the world clock list**

Keep track of the date and time of cities around the world.

1. In **Global Time**, go to the **World Clock** tab, and then tap **Add city**.

2. Enter the city name you want to add. As you enter letters, the list is filtered to show matching cities and countries.

3. Tap the city when it appears on the list.

### **7.2.3 Deleting cities to the world clock list**

1. In **Global Time**, go to the **World Clock** tab, and then tap **MENU**, and select **Delete**.

2. Select the cities you want to delete.

3. Then press the **Delete**



### 7.3 Stop Watch

1. Press **Start /Stop** to measures time.
2. Press **Reset** to clean the time

### 7.4 Using Weather

**Weather** lets you view the current weather as well as the weather forecast for the next four days of the week. You can display the weather conditions in your current location and the weather in up to sixteen cities.

#### 7.4.1 Opening Weather

If you enabled location service when you are setting the phone for the first time, the weather in your current location displays the first time you open Weather.

#### 7.4.2 Adding a city

1. On the **Weather** screen, tap 
2. Enter the location you want to add on the text field. As you enter text.
3. Tap the desired city to select it.

#### 7.4.3 Deleting a city





1. On the **Weather** screen, swipe your finger up or down to select the city you want to delete.
2. Press  and then tap **Delete**. On the confirmation box, tap **Delete**.

### 7.5 Using Sound Recorder

**Voice Recorder** is useful for quickly recording thoughts. You can also record your voice and set it as a ringtone.



**Note:** You need to have a micro SD card installed on your phone to use Voice Recorder.

#### Recording your voice

1. Press HOME, then tap , and then tap **Sound Recorder**.
2. Hold the device's microphone near your mouth.
3. Tap  to start recording a voice clip. Tap  to stop recording.
4. Enter a name for the voice clip and then tap **Save**.
5. Tap  to play back the voice recording.

### 7.6 FM Radio

#### 7.6.1 Open Radio

When you listen to the radio, please inset the headset and tap  when you plug in the headset, the idle will display this icon 

### **7.6.2 Selectable channel**

Select the icon  or  by pressing ok keys, you can fine-tune on the radio.

### **7.6.3 Add preset and name the channel**

Press , Choose to increase the presets, the current channel will be added to the default, the same can be re-named. Press , also the channel can be named.

### **7.6.4 Adjust the volume**

Press the menu key, select mute, the radio will be muted.

Press the menu key, select speaker, the radio will play through the external.

### **7.6.5 Scan & Save**

Press the menu key, select scan & save, if you select ok button, all the presets will be remove, then scan available channels.

**Operation of this equipment is subjected to the following two conditions: (1) It is possible this equipment or device may not cause harmful interference and (2) This equipment or device must accept any interference, including interference that may cause undesired operation.**

### **FCC Caution**

Any Changes or modifications not expressly approved by the party responsible for compliance could void the user's authority to operate the equipment.

This device complies with part 15 of the FCC Rules. Operation is subject to the following two conditions: (1) This device may not cause harmful interference, and (2) this device must accept any interference received, including interference that may cause undesired operation.

Note: This equipment has been tested and found to comply with the limits for a Class B digital device, pursuant to part 15 of the FCC Rules. These limits are designed to provide reasonable protection against harmful interference in a residential installation. This equipment generates uses and can radiate radio frequency energy and, if not installed and used in accordance with the instructions, may cause harmful interference to radio communications. However, there is no guarantee that interference will not occur in a particular installation. If this equipment

does cause harmful interference to radio or television reception, which can be determined by turning the equipment off and on, the user is encouraged to try to

correct the interference by one or more of the following measures:

- Reorient or relocate the receiving antenna.
- Increase the separation between the equipment and receiver.
- Connect the equipment into an outlet on a circuit different from that to which the receiver is connected.
- Consult the dealer or an experienced radio/TV technician for help.

SAR tests are conducted using standard operating positions accepted by the FCC with the phone transmitting at its highest certified power level in all tested frequency bands, although the SAR is determined at the highest certified power level, the actual SAR level of the phone while operating can be well below the maximum value, in general, the closer you are to a wireless base station antenna, the lower the power output.

Before a new model phone is available for sale to the public, it must be tested and certified to the FCC that it does not exceed the exposure limit established by the FCC, Tests for each phone are performed in positions and locations (e.g. at the ear and worn on the body) as required by the FCC.

For body worn operation, this model phone has been tested and meets the FCC RF exposure guidelines when used with an accessory designated for this product or when used with an accessory that

Contains no metal and that positions the handset a minimum of 1.5 cm from the body.

Non-compliance with the above restrictions may result in violation of RF exposure guidelines.