



FCC PART 15.247

TEST REPORT

For

ITALCOM GROUP

1728 Coral Way, Coral Gables, Miami, Florida, United States

FCC ID: YPVITALCOMFLY

Report Type: Original Report	Product Type: Mobile Phone
Test Engineer: <u>Gardon Zhang</u>	<i>Gardon Zhang</i>
Report Number: <u>RSZ130131001-00D</u>	
Report Date: <u>2013-03-05</u>	
Reviewed By: <u>Alvin Huang</u> RF Leader	<i>Alvin Huang</i>
Prepared By:	Bay Area Compliance Laboratories Corp. (Shenzhen) 6/F, the 3rd Phase of WanLi Industrial Building ShiHua Road, FuTian Free Trade Zone Shenzhen, Guangdong, China Tel: +86-755-33320018 Fax: +86-755-33320008 www.baclcorp.com.cn

Note: This test report is prepared for the customer shown above and for the equipment described herein. It may not be duplicated or used in part without prior written consent from Bay Area Compliance Laboratories Corp. This report must not be used by the customer to claim product certification, approval, or endorsement by NVLAP*, or any agency of the Federal Government.

* This report may contain data that are not covered by the NVLAP accreditation and shall be marked with an asterisk "★"

TABLE OF CONTENTS

GENERAL INFORMATION.....	4
PRODUCT DESCRIPTION FOR EQUIPMENT UNDER TEST (EUT).....	4
OBJECTIVE	4
RELATED SUBMITTAL(S)/GRANT(S).....	4
TEST METHODOLOGY	4
TEST FACILITY	5
SYSTEM TEST CONFIGURATION.....	6
DESCRIPTION OF TEST CONFIGURATION	6
EUT EXERCISE SOFTWARE	6
EQUIPMENT MODIFICATIONS	6
EXTERNAL I/O CABLE.....	6
BLOCK DIAGRAM OF TEST SETUP	7
SUMMARY OF TEST RESULTS	8
FCC§15.247 (i), §1.1307 (b) (1) & §2.1093 – RF EXPOSURE	9
STANDARD APPLICABLE	9
FCC §15.203 - ANTENNA REQUIREMENT.....	10
APPLICABLE STANDARD	10
ANTENNA CONNECTOR CONSTRUCTION	10
FCC §15.207 (a) – AC LINE CONDUCTED EMISSIONS	11
APPLICABLE STANDARD	11
EUT SETUP	11
EMI TEST RECEIVER SETUP.....	11
TEST PROCEDURE	12
TEST EQUIPMENT LIST AND DETAILS.....	12
TEST RESULTS SUMMARY	12
TEST DATA	12
FCC §15.209, §15.205 & §15.247(d) - SPURIOUS EMISSIONS.....	15
APPLICABLE STANDARD	15
EUT SETUP	15
EMI TEST RECEIVER & SPECTRUM ANALYZER SETUP	16
TEST PROCEDURE	16
CORRECTED AMPLITUDE & MARGIN CALCULATION	16
TEST EQUIPMENT LIST AND DETAILS.....	17
TEST RESULTS SUMMARY	17
TEST DATA	17
FCC §15.247(a) (2) – 6 dB EMISSION BANDWIDTH.....	28
APPLICABLE STANDARD	28
TEST PROCEDURE	28
TEST EQUIPMENT LIST AND DETAILS.....	28
TEST DATA	28
FCC §15.247(b) (3) - MAXIMUM PEAK OUTPUT POWER	36
APPLICABLE STANDARD	36
TEST PROCEDURE	36
TEST EQUIPMENT LIST AND DETAILS.....	36
TEST DATA	36

FCC §15.247(d) – 100 kHz BANDWIDTH OF FREQUENCY BAND EDGE.....44
 APPLICABLE STANDARD 44
 TEST PROCEDURE 44
 TEST EQUIPMENT LIST AND DETAILS..... 44
 TEST DATA 44

FCC §15.247(e) - POWER SPECTRAL DENSITY50
 APPLICABLE STANDARD 50
 TEST PROCEDURE 50
 TEST EQUIPMENT LIST AND DETAILS..... 50
 TEST DATA 50

GENERAL INFORMATION

Product Description for Equipment under Test (EUT)

The *ITALCOM GROUP*'s product, model number: *fly* (FCC ID: *YPVITALCOMFLY*) or the "EUT" in this report was a *Mobile Phone*, which was measured approximately: 15.1 cm (L) x 8.2 cm (W) x 1.2 cm (H), rated input voltage: DC 3.7 V Li-ion battery or DC 5V charging from adapter.

Adapter Information:

Model : fly

Input: 100-240 V, 50/60Hz, 0.15A

Output: DC 5.0V, 0.5A

** All measurement and test data in this report was gathered from production sample serial number: 123456789 (Assigned by the applicant). The EUT supplied by the applicant was received on 2013-01-31.*

Objective

This report is prepared on behalf of *ITALCOM GROUP* in accordance with Part 2-Subpart J, Part 15-Subparts A, B and C of the Federal Communication Commissions rules.

The tests were performed in order to determine compliance with FCC Part 15, Subpart C, and section 15.203, 15.205, 15.207, 15.209 and 15.247 rules.

Related Submittal(s)/Grant(s)

FCC Part 15B JBP, Part 15.247 DSS and Part 22H/24E PCE submissions with FCC ID: YPVITALCOMFLY.

Test Methodology

All measurements contained in this report were conducted with ANSI C63.4-2003, American National Standard for Methods of Measurement of Radio-Noise Emissions from Low-Voltage Electrical and Electronic Equipment in the range of 9 kHz to 40 GHz.

All emissions measurement was performed and Bay Area Compliance Laboratories Corp. (Shenzhen). The radiated testing was performed at an antenna-to-EUT distance of 3 meters.

The uncertainty of any RF tests which use conducted method measurement is ± 0.96 dB, the uncertainty of any radiation on emissions measurement is ± 4.0 dB

Test Facility

The Test site used by Bay Area Compliance Laboratories Corp. (Shenzhen) to collect test data is located on the 6/F, the 3rd Phase of WanLi Industrial Building, ShiHua Road, FuTian Free Trade Zone Shenzhen, Guangdong, China.

Test site at Bay Area Compliance Laboratories Corp. (Shenzhen) has been fully described in reports submitted to the Federal Communication Commission (FCC). The details of these reports have been found to be in compliance with the requirements of Section 2.948 of the FCC Rules on December 06, 2010. The facility also complies with the radiated and AC line conducted test site criteria set forth in ANSI C63.4-2003.

The Federal Communications Commission has the reports on file and is listed under FCC Registration No.: 382179. The test site has been approved by the FCC for public use and is listed in the FCC Public Access Link (PAL) database.

Additionally, Bay Area Compliance Laboratories Corp. (Shenzhen) is an ISO/IEC 17025 accredited laboratory, and is accredited by National Voluntary Laboratory Accredited Program (Lab Code 200707-0).



The current scope of accreditations can be found at <http://ts.nist.gov/Standards/scopes/2007070.htm>

SYSTEM TEST CONFIGURATION

Description of Test Configuration

For 802.11b, 802.11g, 802.11n-HT20 and 802.11n-HT40 mode, 11 channels are provided to testing:

Channel	Frequency (MHz)	Channel	Frequency (MHz)
1	2412	7	2442
2	2417	8	2447
3	2422	9	2452
4	2427	10	2457
5	2432	11	2462
6	2437	/	/

For 802.11b, 802.11g, 802.11n-HT20 mode, EUT was tested with Channel 1, 6 and 11.

For 802.11n40 mode, 7 channels are provided to testing:

Channel	Frequency (MHz)	Channel	Frequency (MHz)
1	2422	6	2447
2	2427	7	2452
3	2432	/	/
4	2437	/	/
5	2442	/	/

EUT was tested with Channel 1, 4 and 7.

EUT Exercise Software

The test software was provided by client, which was embedded in the product.

Equipment Modifications

No modification was made to the EUT tested.

External I/O Cable

Cable Description	Length (m)	From Port	To
Shielding Detachable USB Cable	1.0	EUT	Adapter

Block Diagram of Test Setup

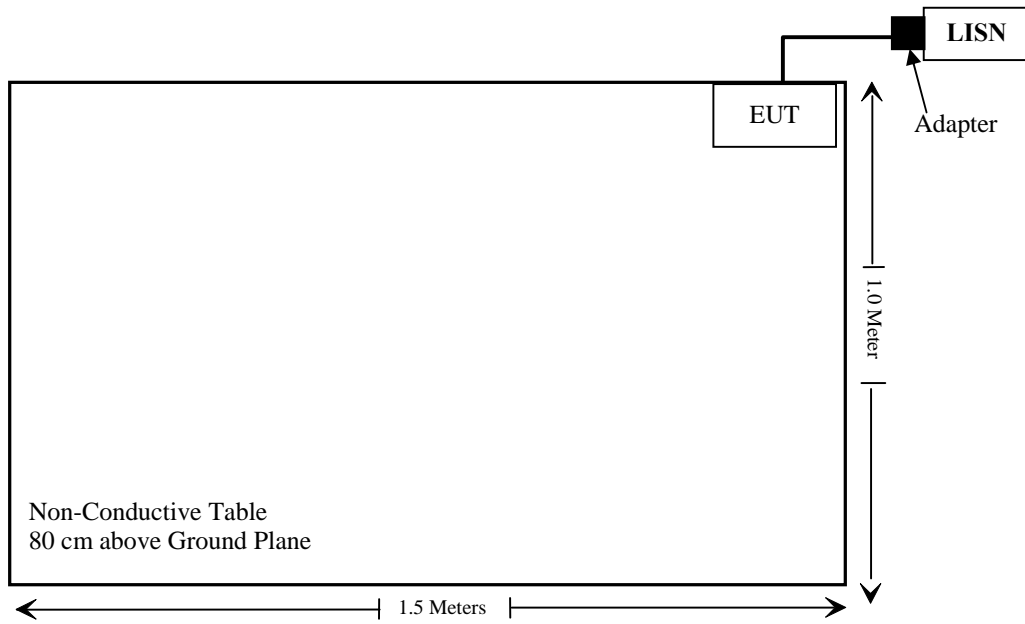

SUMMARY OF TEST RESULTS

FCC Rules	Description of Test	Result
§15.247 (i), §1.1307 (b) (1)& §2.1093	RF Exposure	Compliance
§15.203	Antenna Requirement	Compliance
§15.207 (a)	AC Line Conducted Emissions	Compliance
§15.247(d)	Spurious Emissions at Antenna Port	Compliance
§15.205, §15.209, §15.247(d)	Spurious Emissions	Compliance
§15.247 (a)(2)	6 dB Emission Bandwidth	Compliance
§15.247(b)(3)	Maximum Peak Output Power	Compliance
§15.247(d)	100 kHz Bandwidth of Frequency Band Edge	Compliance
§15.247(e)	Power Spectral Density	Compliance

FCC§15.247 (i), §1.1307 (b) (1) & §2.1093 – RF EXPOSURE

Standard Applicable

According to §15.247 (i) and §1.1307(b)(1), systems operating under the provisions of this section shall be operated in a manner that ensures that the public is not exposed to radio frequency energy level in excess of the Commission's guidelines.

Limits for General Population/Uncontrolled Exposure

Result: Compliant

Please refer to the SAR report, report No.: RSZ130131001-20.

FCC §15.203 - ANTENNA REQUIREMENT

Applicable Standard

According to § 15.203, an intentional radiator shall be designed to ensure that no antenna other than that furnished by the responsible party shall be used with the device. The use of a permanently attached antenna or of an antenna that uses a unique coupling to the intentional radiator shall be considered sufficient to comply with the provisions of this section. The manufacturer may design the unit so that a broken antenna can be replaced by the user, but the user of a standard antenna jack or electrical connector is prohibited. The structure and application of the EUT were analyzed to determine compliance with section §15.203 of the rules. §15.203 state that the subject device must meet the following criteria:

- a. Antenna must be permanently attached to the unit.
- b. Antenna must use a unique type of connector to attach to the EUT.

Unit must be professionally installed, and installer shall be responsible for verifying that the correct antenna is employed with the unit.

And according to FCC 47 CFR section 15.247 (b), if the transmitting antennas of directional gain greater than 6dBi are used, the power shall be reduced by the amount in dB that the directional gain of the antenna exceeds 6 dBi.

Antenna Connector Construction

The EUT has an integral antenna arrangement for Wi-Fi, which was permanently attached, the antenna gain is -10dBi (maximum), fulfill the requirement of this section. Please refer to the internal photos.

Result: Compliance.

FCC §15.207 (a) – AC LINE CONDUCTED EMISSIONS

Applicable Standard

FCC§15.207

EUT Setup

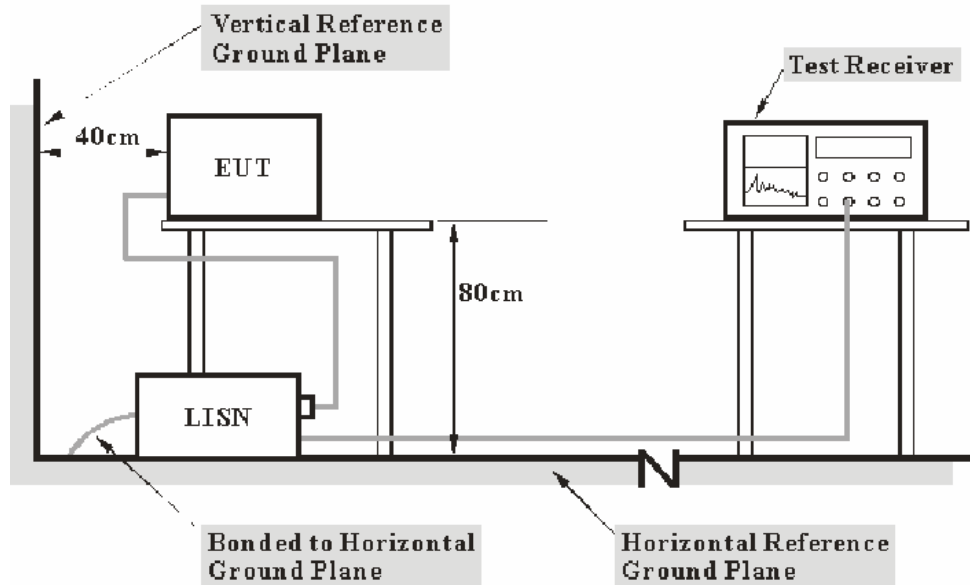

- Note: 1. Support units were connected to second LISN.
 2. Both of LISNs (AMN) 80 cm from EUT and at the least 80 cm from other units and other metal planes support units.

The setup of EUT is according with per ANSI C63.4-2003 measurement procedure. The specification used was with the FCC Part 15.207 limits.

The adapter was connected to a 120 VAC/60 Hz power source.

EMI Test Receiver Setup

The EMI test receiver was set to investigate the spectrum from 150 kHz to 30 MHz.

During the conducted emission test, the EMI test receiver was set with the following configurations:

Frequency Range	IF B/W
150 kHz – 30 MHz	9 kHz

Test Procedure

During the conducted emission test, the adapter was connected to the LISN.

Maximizing procedure was performed on the six (6) highest emissions of the EUT.

All data was recorded in the Quasi-peak and average detection mode.

Test Equipment List and Details

Manufacturer	Description	Model	Serial Number	Calibration Date	Calibration Due Date
Rohde & Schwarz	EMI Test Receiver	ESCS30	100176	2012-11-24	2013-11-23
Rohde & Schwarz	L.I.S.N.	ESH2-Z5	892107/021	2012-08-22	2013-08-21
Rohde & Schwarz	Pulse limiter	ESH3Z2	DE25985	2012-07-08	2013-07-07
BACL	CE Test software	BACL-CE	V1.0	-	-

* **Statement of Traceability:** Bay Area Compliance Laboratories Corp. (Shenzhen) attests that all calibrations have been performed in accordance to NVLAP requirements, traceable to National Primary Standards and International System of Units (SI).

Test Results Summary

According to the recorded data in following table, the EUT complied with the FCC Part 15.207, with the worst margin reading of:

19.80 dB at 0.165 MHz in the **Line** conducted mode

Test Data

Environmental Conditions

Temperature:	25 °C
Relative Humidity:	56 %
ATM Pressure:	100.0 kPa

The testing was performed by Gardon Zhang on 2013-02-22.

EUT operation mode: Transmitting

120 V, 60 Hz, Line:

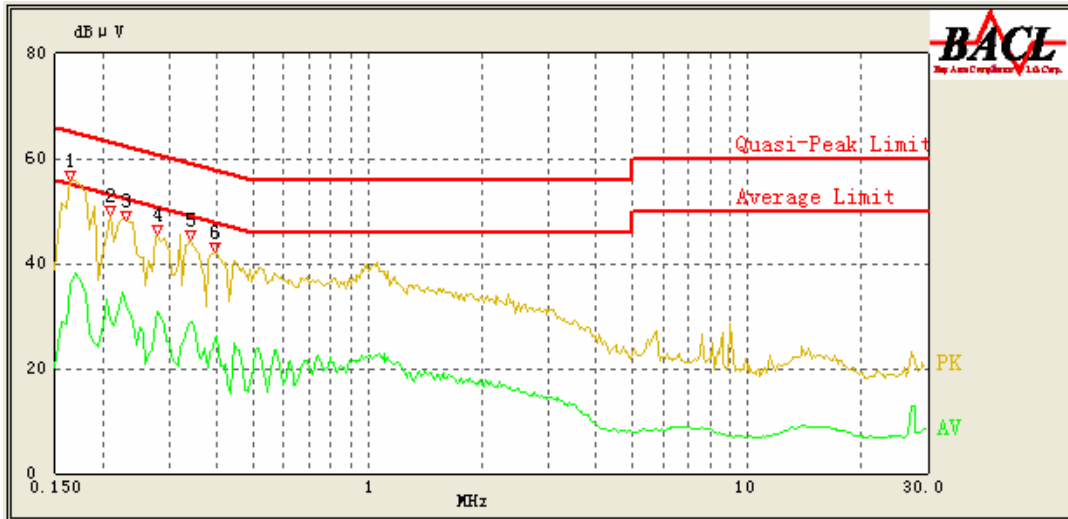

Frequency (MHz)	Corrected Amplitude (dBμV)	Correction Factor (dB)	Limit (dBμV)	Margin (dB)	Detector (PK/Ave./QP)
0.165	35.77	10.10	55.57	19.80	Ave.
0.230	32.09	10.10	53.71	21.62	Ave.
0.280	30.67	10.10	52.29	21.62	Ave.
0.340	28.87	10.10	50.57	21.70	Ave.
0.395	25.90	10.10	49.00	23.10	Ave.
0.230	39.98	10.10	63.71	23.73	QP
0.210	29.24	10.10	54.29	25.05	Ave.
0.395	32.10	10.10	59.00	26.90	QP
0.210	34.36	10.10	64.29	29.93	QP
0.165	40.04	10.10	65.57	25.53	QP
0.340	30.42	10.10	60.57	30.15	QP
0.280	34.84	10.10	62.29	27.45	QP

120V, 60 Hz, Neutral:

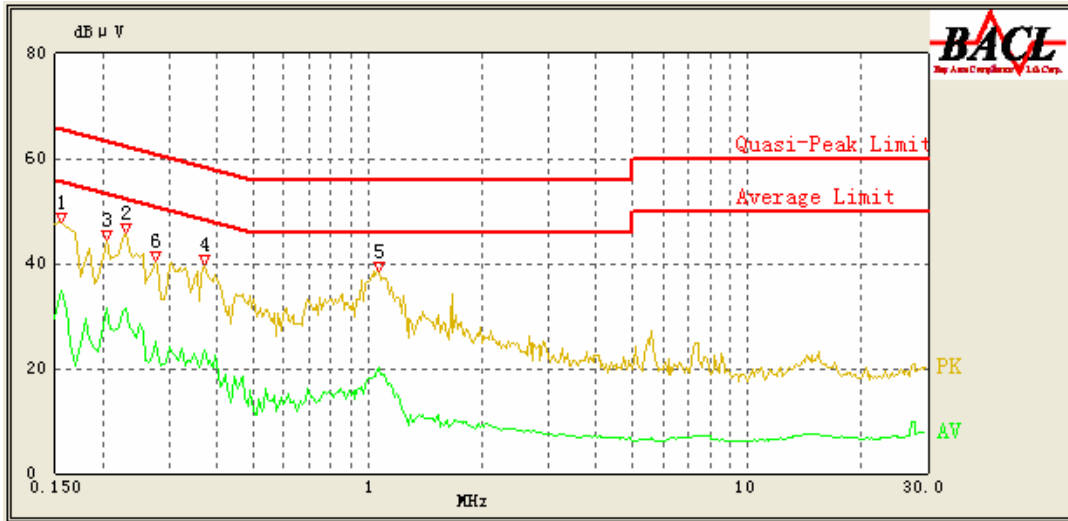

Frequency (MHz)	Corrected Amplitude (dBµV)	Correction Factor (dB)	Limit (dBµV)	Margin (dB)	Detector (PK/Ave./QP)
0.155	34.89	10.10	55.86	20.97	Ave.
0.230	31.62	10.10	53.71	22.09	Ave.
0.205	31.53	10.10	54.43	22.90	Ave.
1.075	31.73	10.20	56.00	24.27	QP
1.075	20.22	10.20	46.00	25.78	Ave.
0.370	23.38	10.10	49.71	26.33	Ave.
0.275	25.11	10.10	52.43	27.32	Ave.
0.230	35.81	10.10	63.71	27.90	QP
0.275	33.97	10.10	62.43	28.46	QP
0.205	35.84	10.10	64.43	28.59	QP
0.370	30.14	10.10	59.71	29.57	QP
0.155	35.53	10.10	65.86	30.33	QP

Note:

- 1) Correction Factor = LISN/ISN VDF (Voltage Division Factor) + Cable Loss + Pulse Limiter Attenuation
The corrected factor has been input into the transducer of the test software.
- 2) Corrected Amplitude = Reading + Correction Factor
- 3) Margin = Limit - Corrected Amplitude

FCC §15.209, §15.205 & §15.247(d) - SPURIOUS EMISSIONS

Applicable Standard

FCC §15.247 (d); §15.209; §15.205;

EUT Setup

Below 1 GHz:

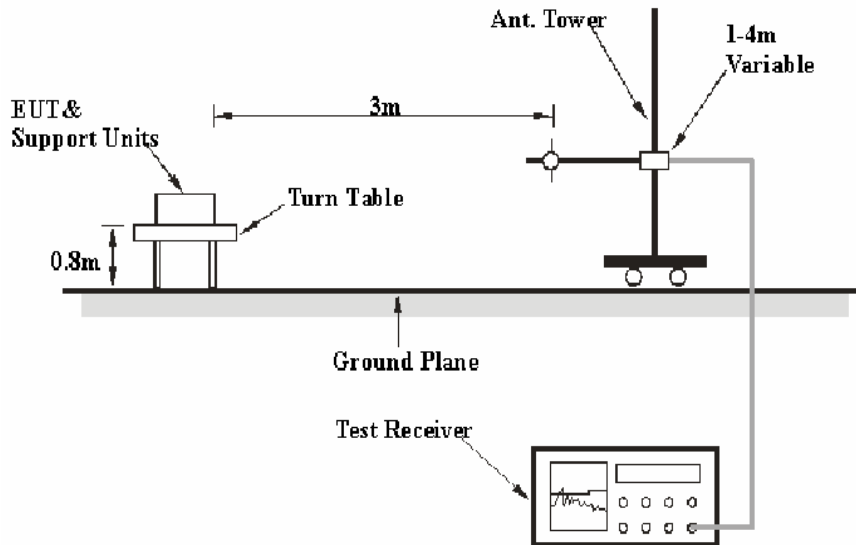

Above 1 GHz:

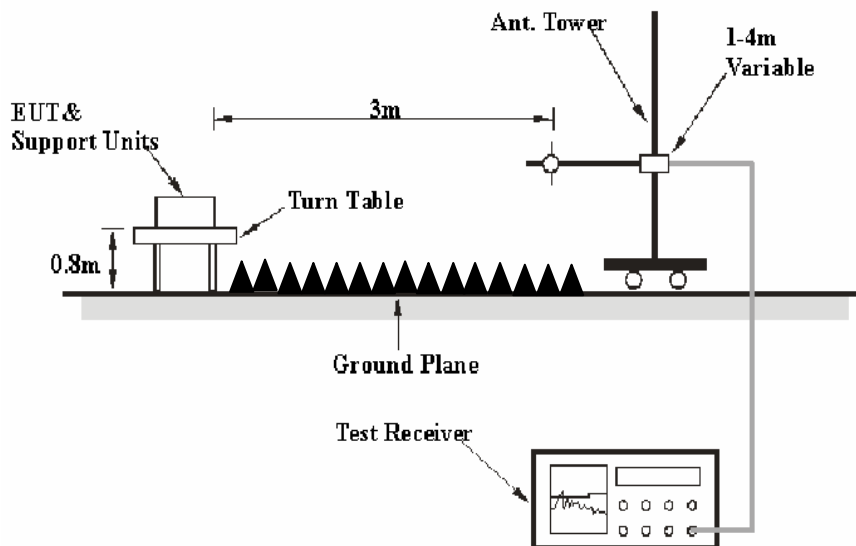

The radiated emission tests were performed in the 3 meters test site, using the setup accordance with the ANSI C63.4-2003. The specification used was the FCC 15.209, and FCC 15.247 limits.

EMI Test Receiver & Spectrum Analyzer Setup

The system was investigated from 30 MHz to 25 GHz.

During the radiated emission test, the EMI test receiver & Spectrum Analyzer Setup were set with the following configurations:

Frequency Range	RBW	Video B/W	IF B/W	Detector
30MHz – 1000 MHz	100 kHz	300 kHz	120kHz	QP
Above 1 GHz	1MHz	3 MHz	/	PK
	1MHz	10 Hz	/	Ave.

Test Procedure

Maximizing procedure was performed on the highest emissions to ensure that the EUT complied with all installation combinations.

Data was recorded in Quasi-peak detection mode for frequency range of 30 MHz-1 GHz, peak and Average detection modes for frequencies above 1 GHz.

Corrected Amplitude & Margin Calculation

The Corrected Amplitude is calculated by adding the Antenna Factor and Cable Loss, and subtracting the Amplifier Gain from the Meter Reading. The basic equation is as follows:

$$\text{Corrected Amplitude} = \text{Meter Reading} + \text{Antenna Factor} + \text{Cable Loss} - \text{Amplifier Gain}$$

The “**Margin**” column of the following data tables indicates the degree of compliance with the applicable limit. For example, a margin of 7dB means the emission is 7dB below the limit. The equation for margin calculation is as follows:

$$\text{Margin} = \text{Limit} - \text{Corrected Amplitude}$$

Test Equipment List and Details

Manufacturer	Description	Model	Serial Number	Calibration Date	Calibration Due Date
HP	Amplifier	8447E	1937A01046	2012-11-24	2013-11-23
Rohde & Schwarz	EMI Test Receiver	ESCI	101122	2012-08-08	2013-08-07
Sunol Sciences	Broadband Antenna	JB1	A040904-2	2011-11-28	2014-11-27
SUPER ULTRA	Amplifier	ZVA-213+	N/A	2012-11-24	2013-11-23
Sunol Sciences	Horn Antenna	DRH-118	A052304	2011-12-01	2014-11-30
Rohde & Schwarz	Signal Analyzer	FSIQ26	8386001028	2012-11-24	2013-11-23
Agilent	Spectrum Analyzer	8564E	3943A01781	2012-05-17	2013-05-16
the electro-Mechanics Co.	Horn Antenna	3116	9510-2270	2010-10-14	2013-10-13

* **Statement of Traceability:** Bay Area Compliance Laboratories Corp. (Shenzhen) attests that all calibrations have been performed in accordance to NVLAP requirements, traceable to National Primary Standards and International System of Units (SI).

Test Results Summary

According to the recorded data in following table, the EUT complied with the FCC Title 47, Part 15, Subpart C, section 15.205, 15.209 and 15.247, with the worst margin reading of:

11.78 dB at 7311 MHz in the Horizontal polarization

Test Data**Environmental Conditions**

Temperature:	25 °C
Relative Humidity:	55 %
ATM Pressure:	101.0 kPa

The testing was performed by Gardon Zhang on 2013-02-17.

30 MHz-25 GHz:

802.11b Mode:

Frequency (MHz)	Receiver		Turntable Degree	Rx Antenna		Corrected Factor (dB)	Corrected Amplitude (dBuV/m)	FCC Part 15.247/205/209	
	Reading (dBuV)	Detector (PK/QP/Ave.)		Height (m)	Polar (H/V)			Limit (dBuV/m)	Margin (dB)
Low Channel (2412 MHz)									
2412.0	80.06	PK	32	1.2	H	6.13	86.19	/	/
2412.0	74.98	Ave.	32	1.2	H	6.13	81.11	/	/
2412.0	78.37	PK	115	1.1	V	6.13	84.50	/	/
2412.0	73.34	Ave.	115	1.1	V	6.13	79.47	/	/
9648.0	32.15	PK	96	1.4	H	19.29	51.44	74	22.56
7236.0	33.44	PK	83	1.3	H	16.62	50.06	74	23.94
4824.0	35.63	PK	225	1.2	H	12.40	48.03	74	25.97
2491.3	35.72	PK	32	1.1	H	7.21	42.93	74	31.07
2383.2	34.93	PK	71	1.0	H	6.13	41.06	74	32.94
2344.5	35.22	PK	86	1.3	V	5.48	40.70	74	33.30
Middle Channel (2437 MHz)									
2437.0	80.53	PK	43	1.2	H	7.21	87.74	/	/
2437.0	75.11	Ave.	43	1.2	H	7.21	82.32	/	/
2437.0	78.66	PK	111	1.1	V	7.21	85.87	/	/
2437.0	73.59	Ave.	111	1.1	V	7.21	80.80	/	/
9748.0	34.24	PK	89	1.3	H	19.40	53.64	74	20.36
7311.0	35.43	PK	36	1.1	H	16.49	51.92	74	22.08
4874.0	36.11	PK	84	1.2	H	12.46	48.57	74	25.43
2487.3	35.33	PK	133	1.0	H	7.21	42.54	74	31.46
2387.1	35.76	PK	26	1.1	H	6.13	41.89	74	32.11
2316.1	34.77	PK	84	1.3	H	5.48	40.25	74	33.75
High Channel (2462 MHz)									
2462.0	81.32	PK	133	1.2	H	7.21	88.53	/	/
2462.0	75.63	Ave.	133	1.2	H	7.21	82.84	/	/
2462.0	78.37	PK	85	1.1	V	7.21	85.58	/	/
2462.0	74.25	Ave.	85	1.1	V	7.21	81.46	/	/
9848.0	36.74	PK	227	1.1	V	19.39	56.13	74	17.87
7386.0	35.01	PK	96	1.2	H	15.91	50.92	74	23.08
9848.0	19.83	Ave.	227	1.1	V	19.39	39.22	54	14.78
4924.0	32.21	PK	102	1.3	H	12.50	44.71	74	29.29
2491.2	36.71	PK	96	1.2	H	7.21	43.92	74	30.08
2483.6	35.77	PK	33	1.1	V	6.13	41.90	74	32.10
2322.5	35.21	PK	71	1.3	H	5.48	40.69	74	33.31

802.11g Mode:

Frequency (MHz)	Receiver		Turntable Degree	Rx Antenna		Corrected Factor (dB)	Corrected Amplitude (dBuV/m)	FCC Part 15.247/205/209	
	Reading (dBuV)	Detector (PK/QP/Ave.)		Height (m)	Polar (H/V)			Limit (dBuV/m)	Margin (dB)
Low Channel (2412 MHz)									
2412.0	82.15	PK	76	1.1	H	6.13	88.28	/	/
2412.0	68.31	Ave.	76	1.1	H	6.13	74.44	/	/
2412.0	78.05	PK	115	1.3	V	6.13	84.18	/	/
2412.0	63.73	Ave.	115	1.3	V	6.13	69.86	/	/
9648.0	34.62	PK	15	1.0	H	19.29	53.91	74	21.09
7236.0	34.86	PK	93	1.4	H	16.62	51.48	74	22.52
4824.0	36.13	PK	26	1.1	H	12.40	48.53	74	25.47
2492.1	35.11	PK	73	1.3	V	7.21	42.32	74	31.68
2386.2	35.71	PK	88	1.1	H	6.13	41.84	74	32.16
2355.7	34.11	PK	32	1.2	H	5.48	39.59	74	34.41
Middle Channel (2437 MHz)									
2437.0	83.44	PK	135	1.1	H	7.21	90.65	/	/
2437.0	68.51	Ave.	135	1.1	H	7.21	75.72	/	/
2437.0	78.93	PK	38	1.3	V	7.21	86.14	/	/
2437.0	64.62	Ave.	38	1.3	V	7.21	71.83	/	/
9748.0	36.25	PK	93	1.0	H	19.40	55.65	74	18.35
9748.0	19.73	Ave.	93	1.0	H	19.40	39.13	54	14.87
7311.0	36.45	PK	167	1.1	H	16.49	52.94	74	21.06
4874.0	37.25	PK	35	1.2	H	12.46	49.71	74	24.29
2491.2	34.87	PK	82	1.3	H	7.21	42.08	74	31.92
2356.8	35.76	PK	116	1.1	V	5.48	41.24	74	32.76
2316.5	35.63	PK	72	1.2	H	5.48	41.11	74	32.89
High Channel (2462 MHz)									
2462.0	82.61	PK	11	1.2	H	7.21	89.82	/	/
2462.0	69.03	Ave.	11	1.2	H	7.21	76.24	/	/
2462.0	78.88	PK	73	1.1	V	7.21	86.09	/	/
2462.0	64.27	Ave.	73	1.1	V	7.21	71.48	/	/
9848.0	31.22	PK	124	1.3	V	19.39	50.61	74	23.39
4924.0	41.02	PK	223	1.5	V	12.50	53.52	74	20.48
7386.0	32.09	PK	315	1.1	V	15.91	48.00	74	26.00
2486.5	37.93	PK	115	1.3	V	7.21	45.14	74	28.86
2493.1	36.91	PK	32	1.4	H	7.21	44.12	74	29.88
2318.6	36.25	PK	81	1.2	H	5.48	41.73	74	32.27

802.11n-HT20 Mode:

Frequency (MHz)	Receiver		Turntable Degree	Rx Antenna		Corrected Factor (dB)	Corrected Amplitude (dBuV/m)	FCC Part 15.247/205/209	
	Reading (dBuV)	Detector (PK/QP/Ave.)		Height (m)	Polar (H/V)			Limit (dBuV/m)	Margin (dB)
Low Channel (2412 MHz)									
2412.0	82.20	PK	32	1.1	H	6.13	88.33	/	/
2412.0	66.93	Ave.	32	1.1	H	6.13	73.06	/	/
2412.0	78.69	PK	100	1.3	V	6.13	84.82	/	/
2412.0	64.58	Ave.	100	1.3	V	6.13	70.71	/	/
7236.0	38.66	PK	93	1.3	H	16.62	55.28	74	18.72
7236.0	22.51	Ave.	93	1.3	H	16.62	39.13	54	14.87
9648.0	32.44	PK	107	1.2	V	19.29	51.73	74	22.27
4824.0	38.71	PK	38	1.1	H	12.40	51.11	74	22.89
2493.6	35.71	PK	26	1.0	H	7.21	42.92	74	31.08
2386.8	35.93	PK	71	1.1	H	6.13	42.06	74	31.94
2335.7	32.81	PK	13	1.2	V	5.48	38.29	74	35.71
Middle Channel(2437 MHz)									
2437.0	82.56	PK	55	1.2	H	7.21	89.77	/	/
2437.0	67.39	Ave.	55	1.2	H	7.21	74.60	/	/
2437.0	78.88	PK	32	1.1	V	7.21	86.09	/	/
2437.0	65.93	Ave.	32	1.1	V	7.21	73.14	/	/
7311.0	25.73	Ave.	31	1.1	H	16.49	42.22	54	11.78
9748.0	38.32	PK	108	1.0	H	19.40	57.72	74	16.28
9748.0	19.73	Ave.	108	1.0	H	19.40	39.13	54	14.87
7311.0	38.65	PK	31	1.1	H	16.49	55.14	74	18.86
4874.0	38.95	PK	85	1.5	H	12.46	51.41	74	22.59
2317.8	38.16	PK	19	1.2	H	5.48	43.64	74	30.36
2487.6	35.71	PK	223	1.3	H	7.21	42.92	74	31.08
2364.1	37.11	PK	32	1.1	V	5.48	42.59	74	31.41
High Channel (2462 MHz)									
2462.0	81.11	PK	68	1.1	H	7.21	88.32	/	/
2462.0	66.17	Ave.	68	1.1	H	7.21	73.38	/	/
2462.0	77.82	PK	115	1.3	V	7.21	85.03	/	/
2462.0	63.45	Ave.	115	1.3	V	7.21	70.66	/	/
9848.0	36.59	PK	82	1.3	H	19.39	55.98	74	18.02
9848.0	20.73	Ave.	82	1.3	H	19.39	40.12	54	13.88
7386.0	36.71	PK	137	1.1	H	15.91	52.62	74	21.38
4924.0	33.71	PK	96	1.5	H	12.50	46.21	74	27.79
2482.2	35.77	PK	117	1.0	H	7.21	42.98	74	31.02
2486.6	34.93	PK	26	1.1	V	7.21	42.14	74	31.86
2344.6	32.83	PK	32	1.2	H	5.48	38.31	74	35.69

802.11n-HT40 Mode:

Frequency (MHz)	Receiver		Turntable Degree	Rx Antenna		Corrected Factor (dB)	Corrected Amplitude (dBuV/m)	FCC Part 15.247/205/209	
	Reading (dBuV)	Detector (PK/QP/Ave.)		Height (m)	Polar (H/V)			Limit (dBuV/m)	Margin (dB)
Low Channel (2422 MHz)									
2422.0	74.39	PK	36	1.2	H	6.13	80.52	/	/
2422.0	57.56	Ave.	36	1.2	H	6.13	63.69	/	/
2422.0	72.72	PK	71	1.1	V	6.13	78.85	/	/
2422.0	56.22	Ave.	71	1.1	V	6.13	62.35	/	/
9688.0	20.96	Ave.	11	1.0	V	19.29	40.25	54	13.75
7266.0	23.06	Ave.	108	1.5	V	16.62	39.68	54	14.32
9688.0	36.11	PK	11	1.0	V	19.29	55.40	74	18.60
7266.0	38.11	PK	108	1.5	V	16.62	54.73	74	19.27
4844.0	36.72	PK	12	1.1	H	12.46	49.18	74	24.82
2492.5	39.12	PK	83	1.2	H	7.21	46.33	74	27.67
2336.5	35.71	PK	68	1.4	H	5.48	41.19	74	32.81
2353.7	33.72	PK	116	1.3	V	5.48	39.20	74	34.80
Middle Channel (2437 MHz)									
2437.0	75.02	PK	32	1.5	H	7.21	82.23	/	/
2437.0	58.11	Ave.	32	1.5	H	7.21	65.32	/	/
2437.0	73.86	PK	101	1.1	V	7.21	81.07	/	/
2437.0	57.36	Ave.	101	1.1	V	7.21	64.57	/	/
9748.0	38.25	PK	96	1.1	H	19.40	57.65	74	16.35
9748.0	19.06	Ave.	96	1.1	H	19.40	38.46	54	15.54
7311.0	21.06	Ave.	164	1.5	H	16.49	37.55	54	16.45
7311.0	39.22	PK	164	1.5	H	16.49	55.71	74	18.29
4874.0	36.55	PK	68	1.1	H	12.46	49.01	74	24.99
2492.2	36.87	PK	115	1.0	H	7.21	44.08	74	29.92
2485.6	36.25	PK	72	1.2	H	7.21	43.46	74	30.54
2351.2	36.72	PK	36	1.3	H	5.48	42.20	74	31.80
High Channel (2452 MHz)									
2452.0	75.63	PK	15	1.1	H	7.21	82.84	/	/
2452.0	58.02	Ave.	15	1.1	H	7.21	65.23	/	/
2452.0	72.93	PK	83	1.2	V	7.21	80.14	/	/
2452.0	56.46	Ave.	83	1.2	V	7.21	63.67	/	/
9808.0	19.72	Ave.	58	1.3	V	19.29	39.01	54	14.99
9808.0	36.84	PK	58	1.3	V	19.29	56.13	74	17.87
7356.0	37.11	PK	93	1.1	H	15.91	53.02	74	20.98
4904.0	38.67	PK	32	1.4	V	12.46	51.13	74	22.87
2316.5	38.66	PK	25	1.3	H	5.48	44.14	74	29.86
2485.7	36.16	PK	116	1.2	H	7.21	43.37	74	30.63
2495.7	36.13	PK	71	1.1	V	7.21	43.34	74	30.66

Note: For spurious emission, average measurement was not performed, because peak level went lower than the average limit.

Conducted Spurious Emissions at Antenna Port:

802.11b Low Channel

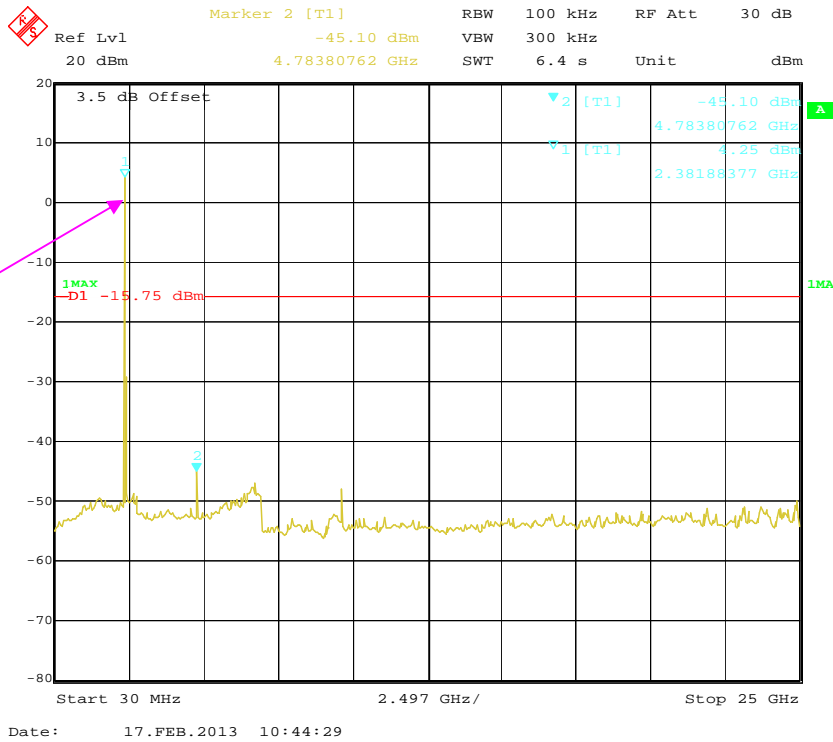

Fundamental

802.11b Middle Channel

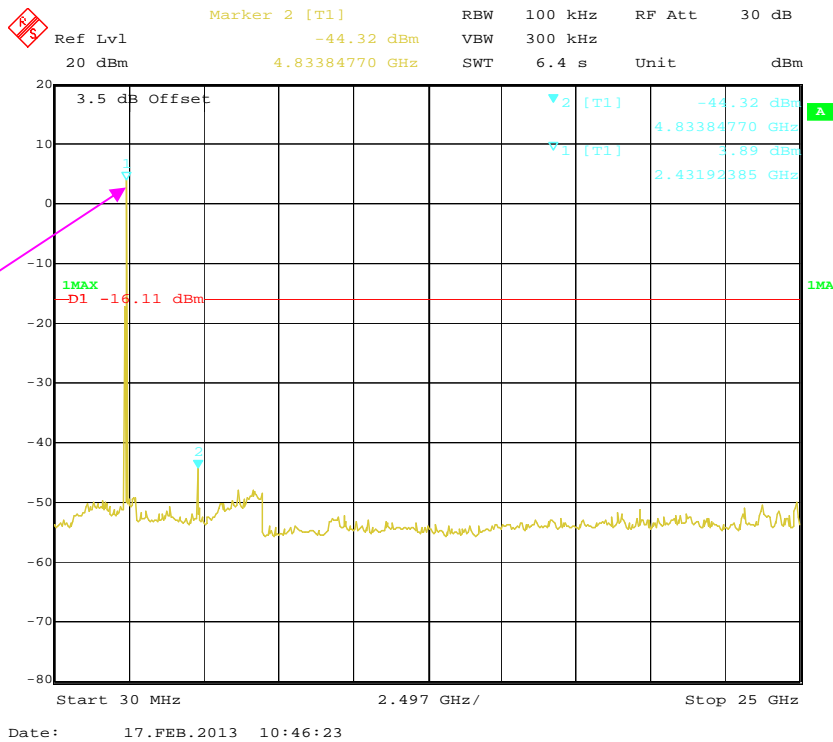

Fundamental

802.11b High Channel

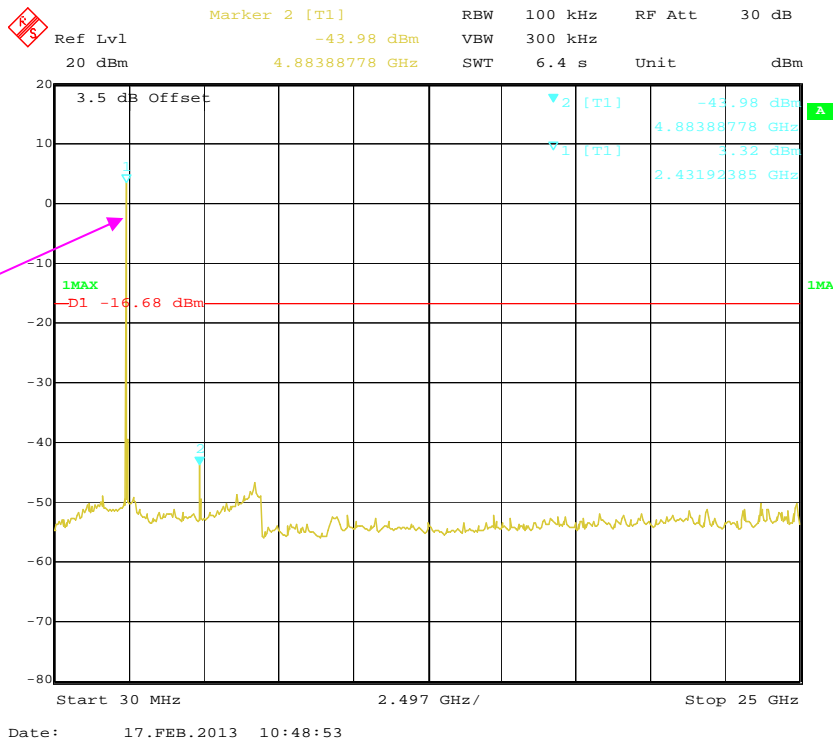

Fundamental

802.11g Low Channel

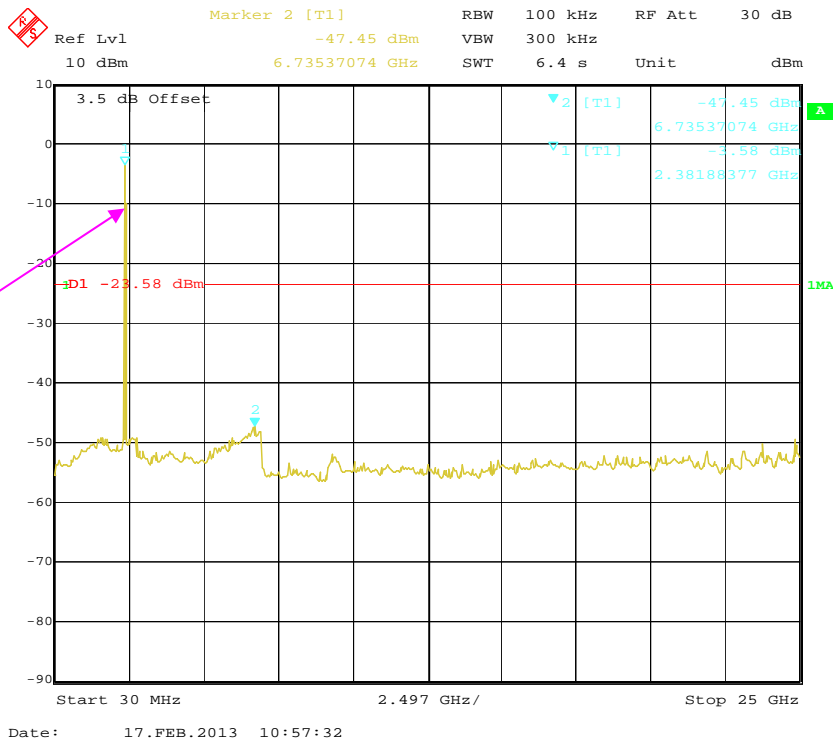

Fundamental

802.11g Middle Channel

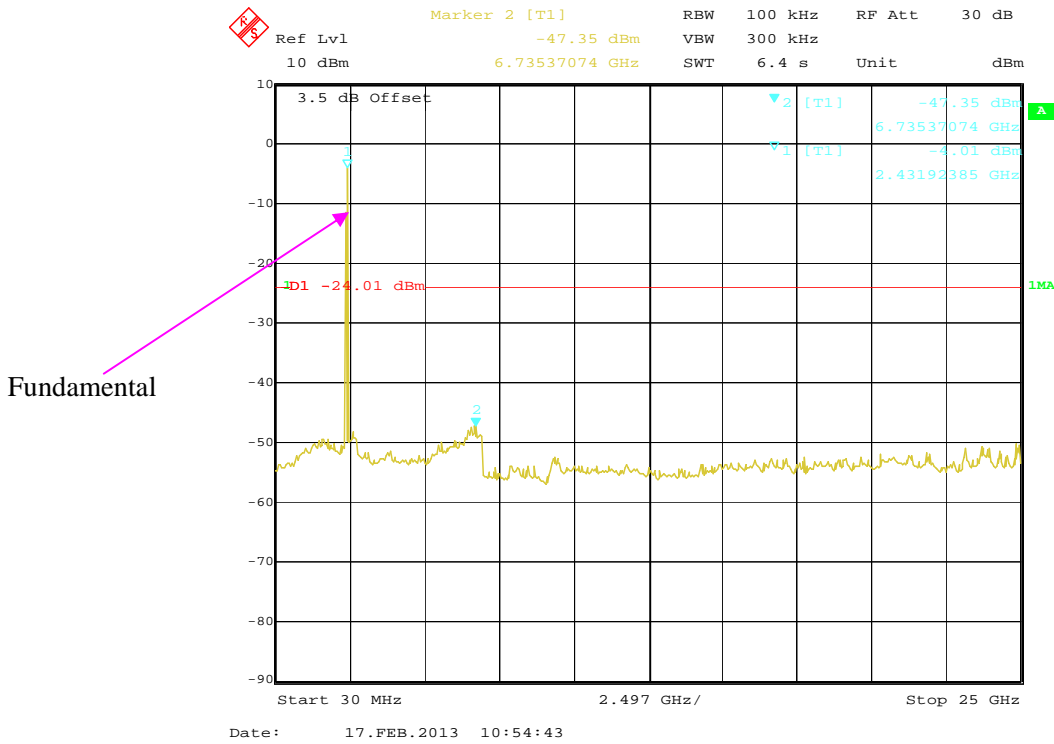

802.11g High Channel

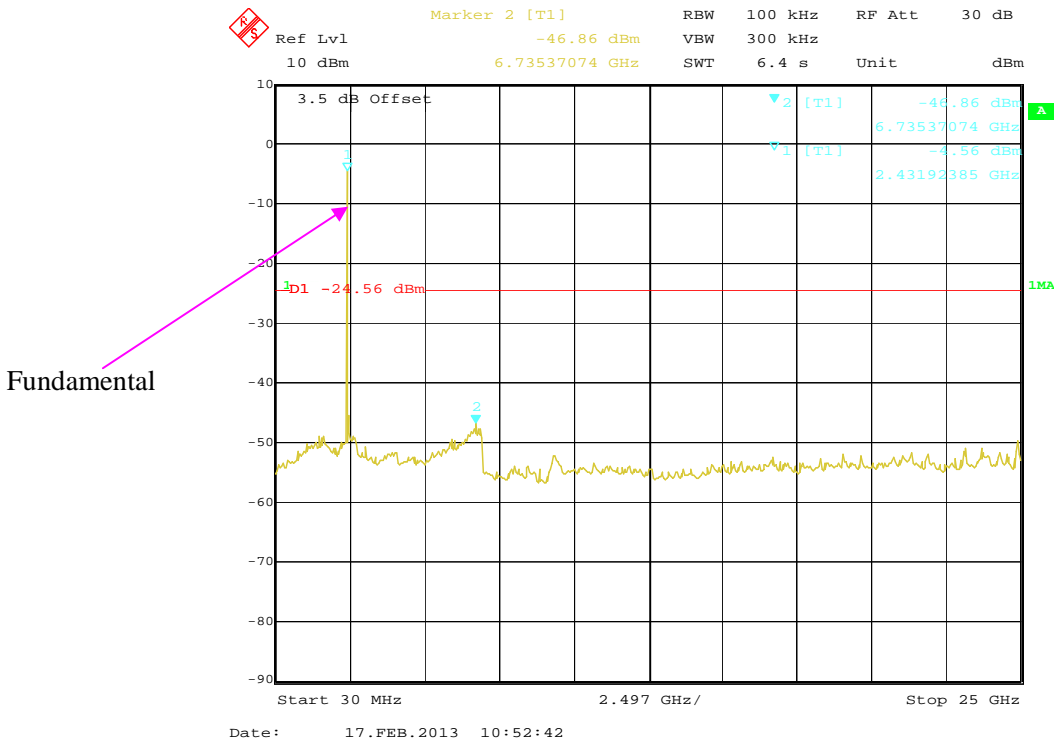

802.11n-HT20 Low Channel

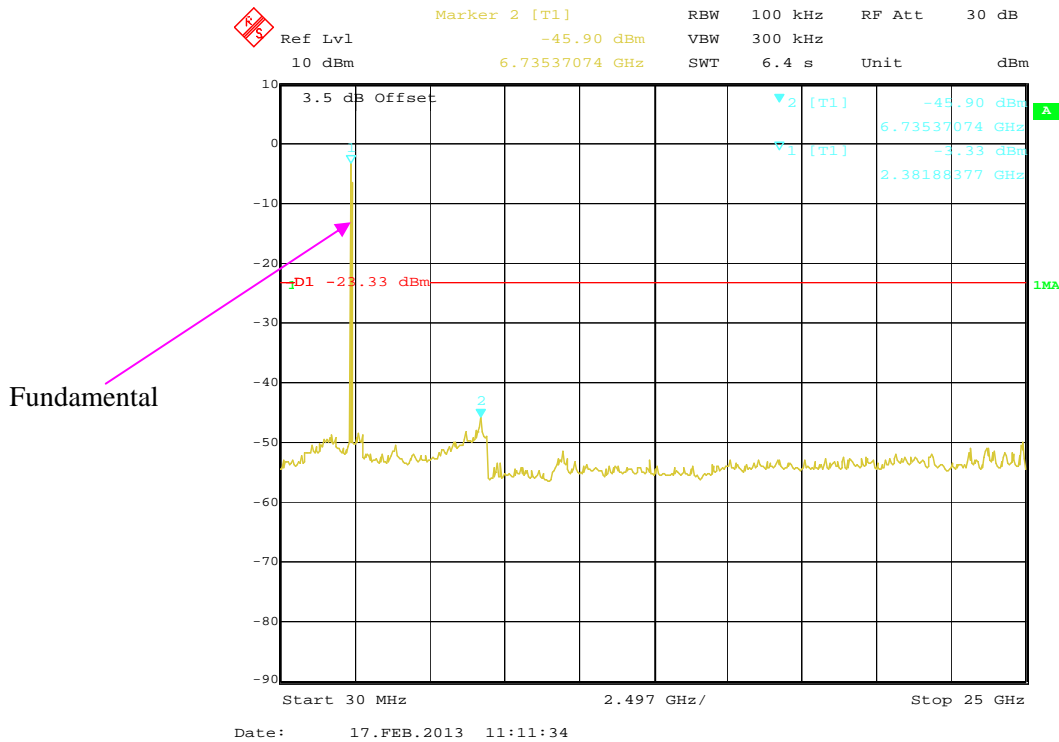

802.11n-HT20 Middle Channel

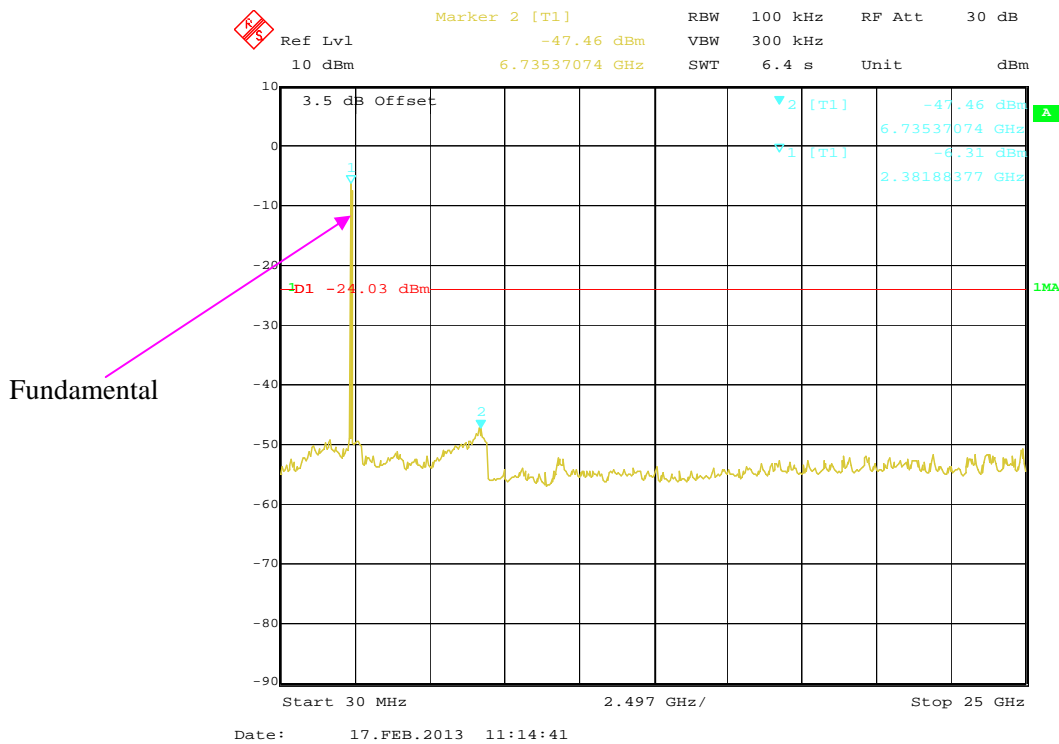

802.11n-HT20 High Channel

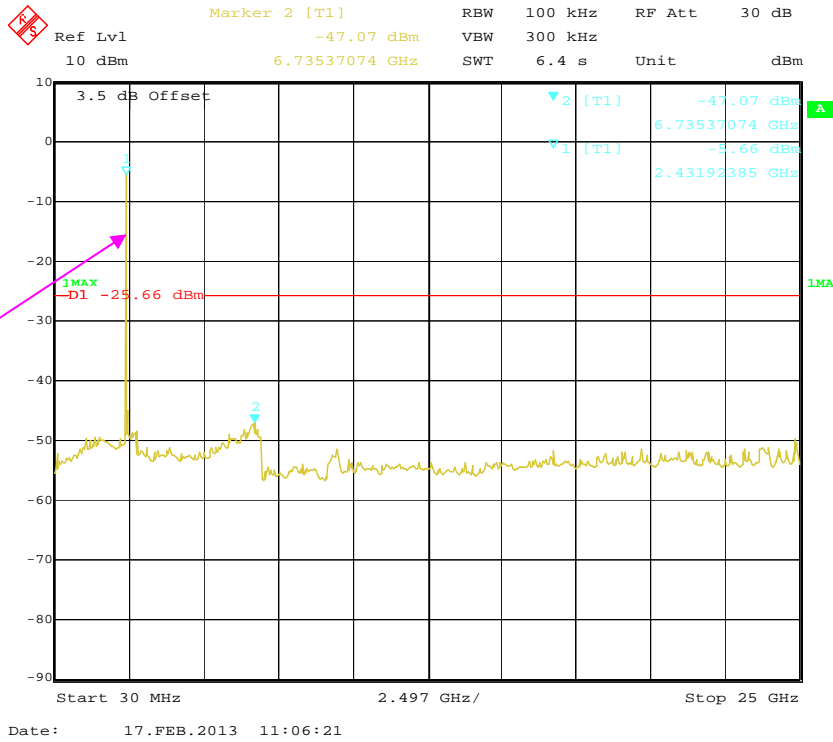

Fundamental

802.11n-HT40 Low Channel

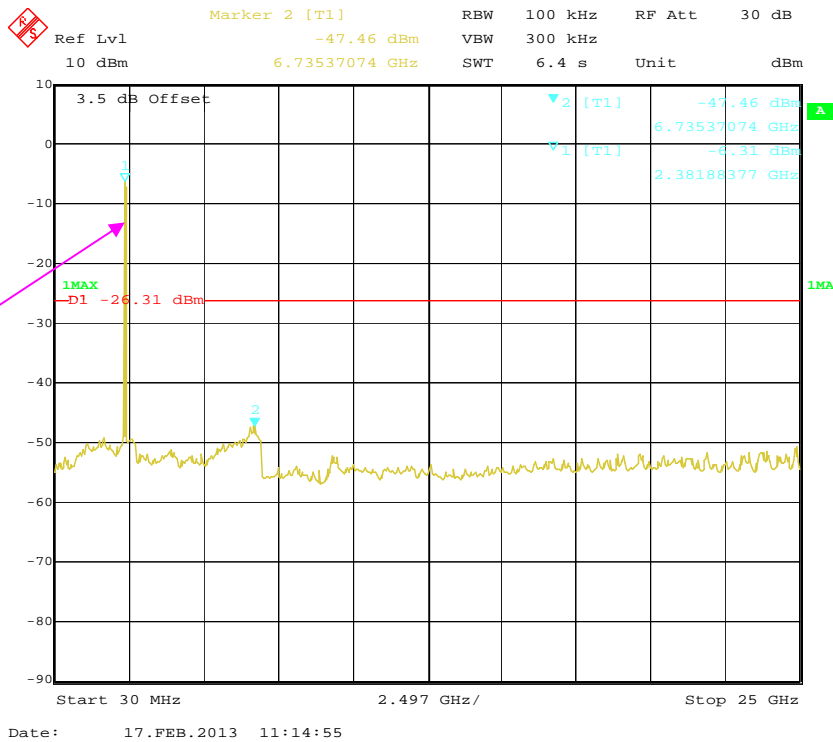

Fundamental

802.11n-HT40 Middle Channel

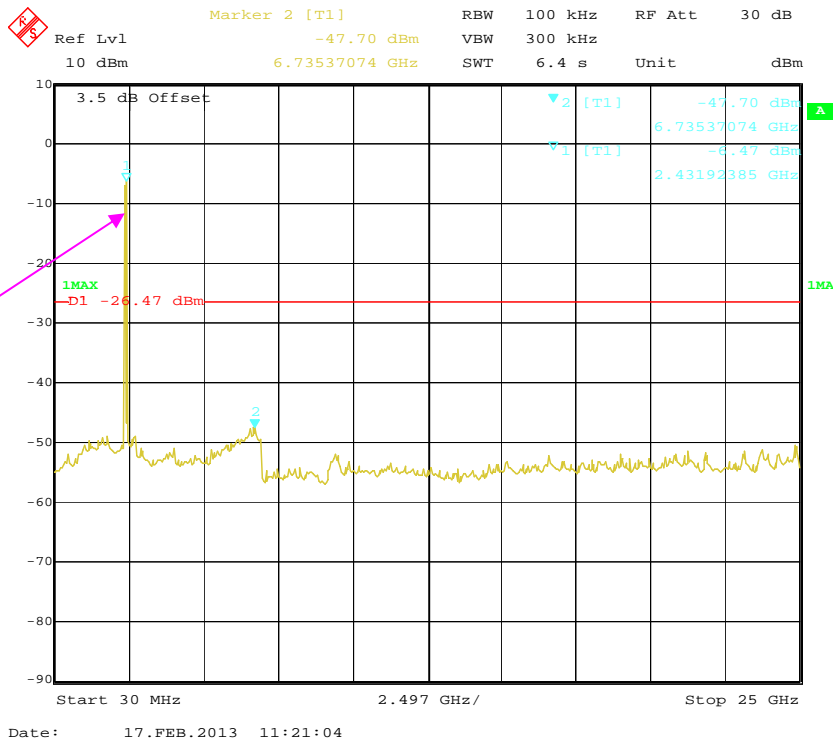

Fundamental

802.11n-HT40 High Channel

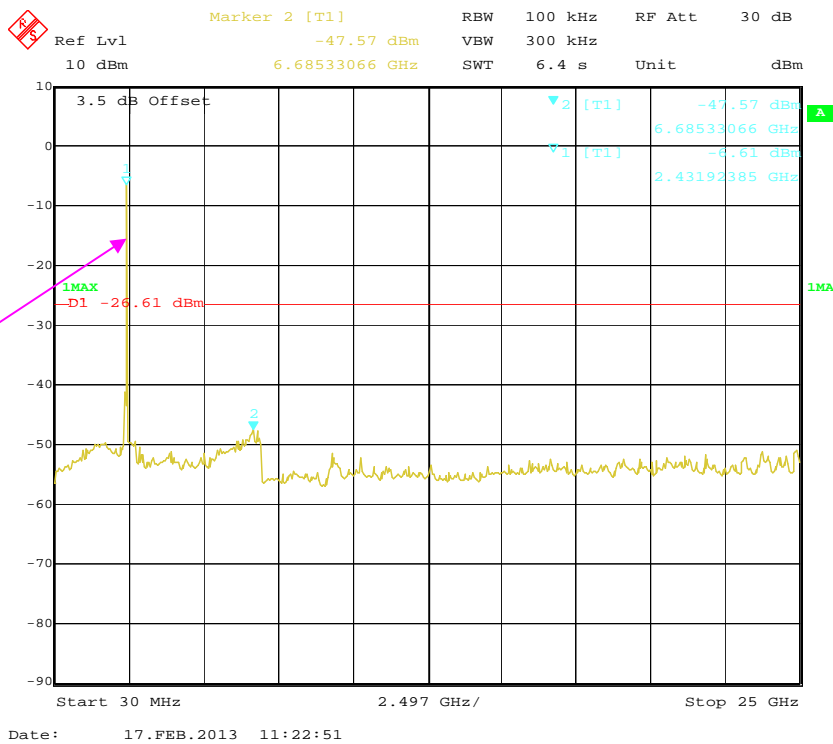

Fundamental

FCC §15.247(a) (2) – 6 dB EMISSION BANDWIDTH

Applicable Standard

Systems using digital modulation techniques may operate in the 902–928 MHz, 2400–2483.5 MHz, and 5725–5850 MHz bands. The minimum 6 dB bandwidth shall be at least 500 kHz.

Test Procedure

1. Check the calibration of the measuring instrument using either an internal calibrator or a known signal from an external generator.
2. Position the EUT without connection to measurement instrument. Turn on the EUT and connect it to measurement instrument. Then set it to any one convenient frequency within its operating range. Set a reference level on the measuring instrument equal to the highest peak value.
3. Measure the frequency difference of two frequencies that were attenuated 6 dB from the reference level. Record the frequency difference as the emission bandwidth.
4. Repeat above procedures until all frequencies measured were complete.

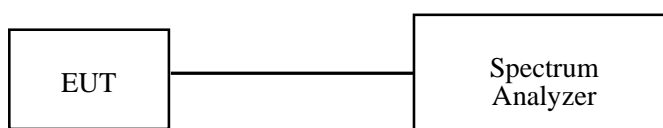

Test Equipment List and Details

Manufacturer	Description	Model	Serial Number	Calibration Date	Calibration Due Date
Rohde & Schwarz	EMI Test Receiver	ESCI	101122	2012-08-08	2013-08-07

* **Statement of Traceability:** Bay Area Compliance Laboratories Corp. (Shenzhen) attests that all calibrations have been performed in accordance to NVLAP requirements, traceable to National Primary Standards and International System of Units (SI).

Test Data

Environmental Conditions

Temperature:	23 °C
Relative Humidity:	56 %
ATM Pressure:	100.0kPa

The testing was performed by Gardon Zhang on 2013-02-21.

Test Result: Pass.

Please refer to the following tables and plots.

EUT operation mode: Transmitting

Channel	Channel Frequency (MHz)	Data Rate (Mbps)	6dB Bandwidth (MHz)	FCC Part 15.247 Limit (kHz)
802.11b mode				
Low	2412	1	9.24	>500
Middle	2437	1	9.24	>500
High	2462	1	9.24	>500
802.11g mode				
Low	2412	6	16.56	>500
Middle	2437	6	16.56	>500
High	2462	6	16.56	>500
802.11n-HT20 mode				
Low	2412	MCS 0	17.76	>500
Middle	2437	MCS 0	17.76	>500
High	2462	MCS 0	17.76	>500
802.11n-HT40 mode				
Low	2422	MCS 0	35.70	>1000
Middle	2437	MCS 0	35.70	>1000
High	2452	MCS 0	35.70	>1000

802.11b Low Channel

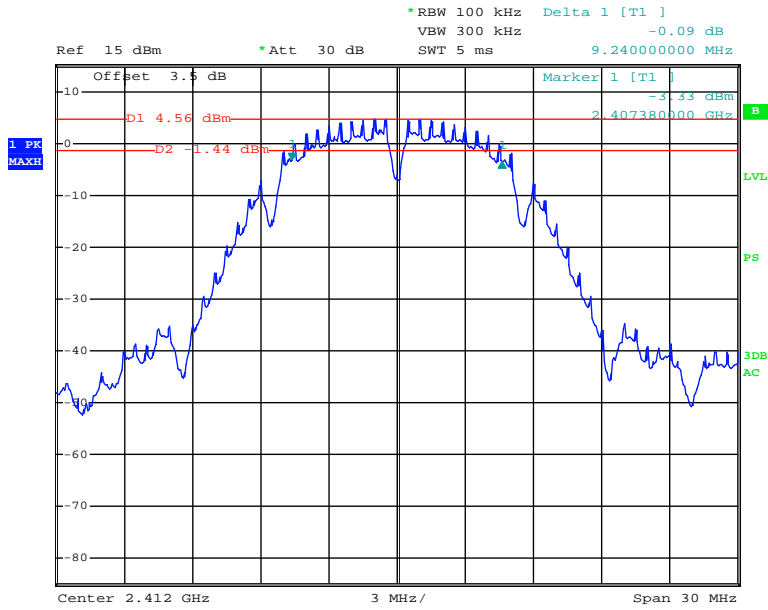

Date: 21.FEB.2013 16:10:33

802.11b Middle Channel

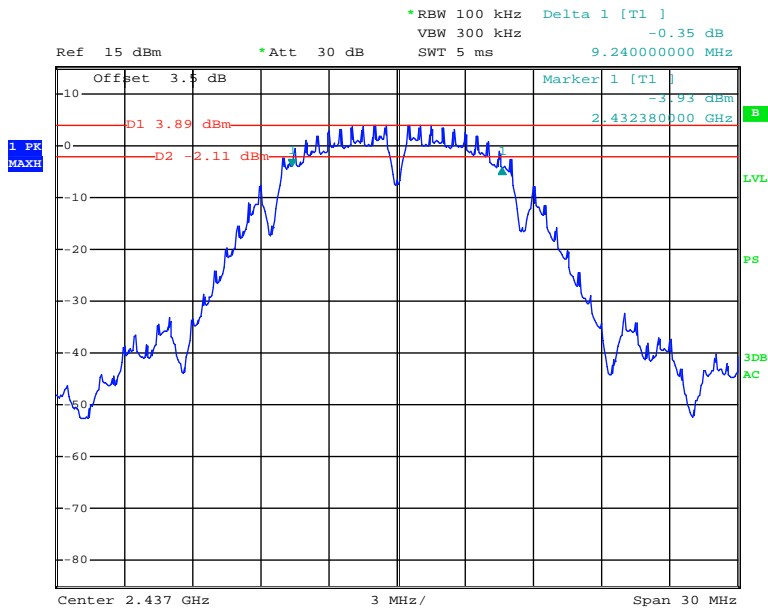

Date: 21.FEB.2013 16:15:00

802.11b High Channel

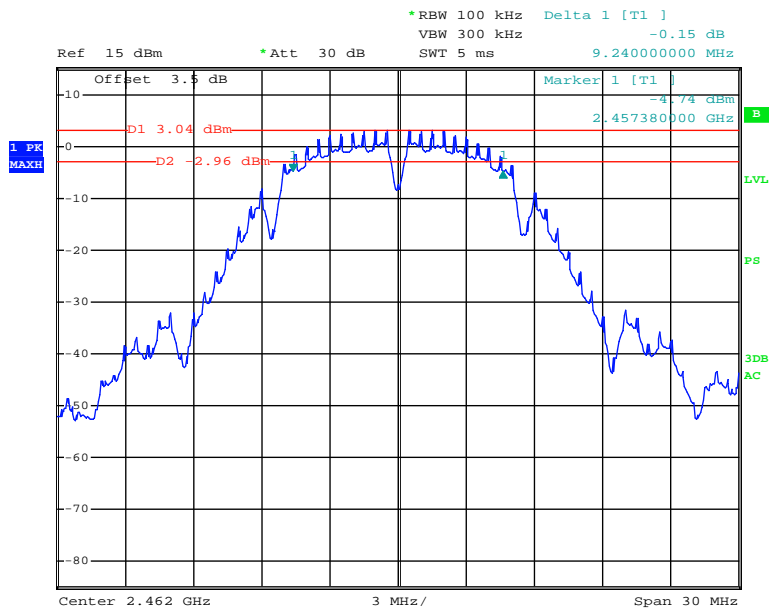

Date: 21.FEB.2013 16:16:05

802.11g Low Channel

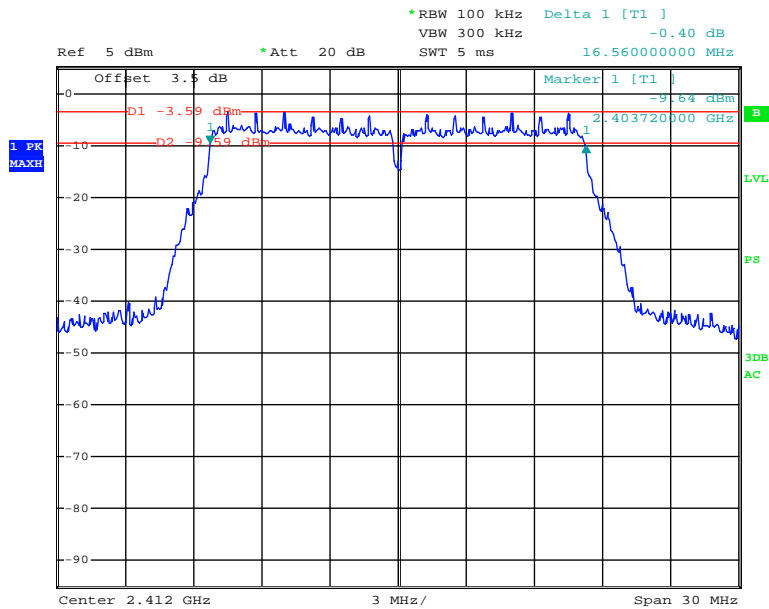

Date: 21.FEB.2013 16:38:26

802.11g Middle Channel

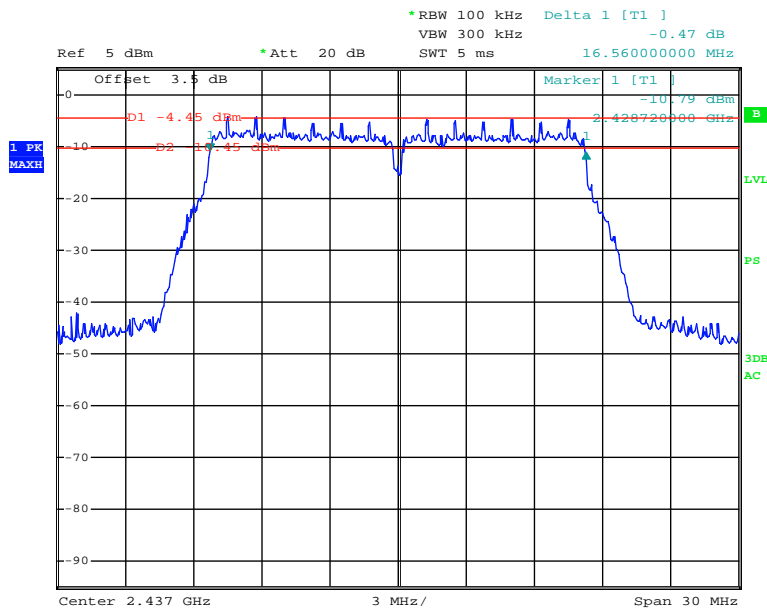

Date: 21.FEB.2013 16:39:55

802.11g High Channel

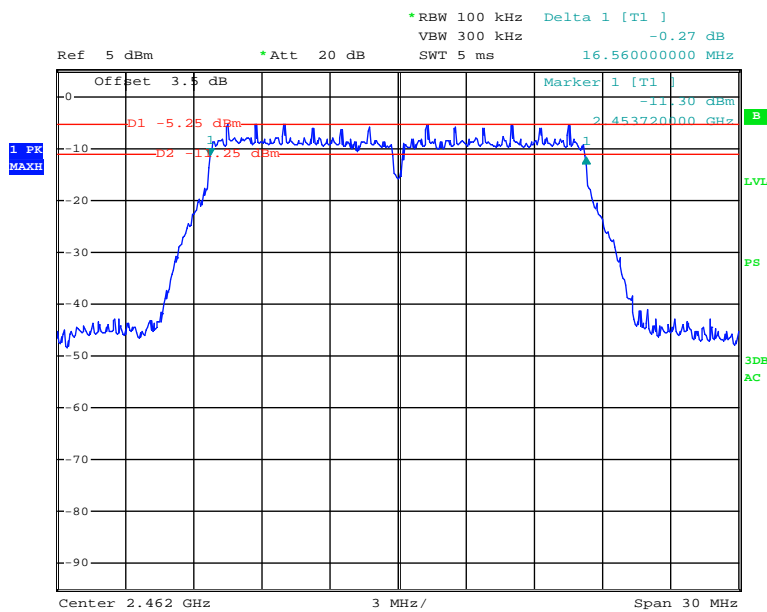

Date: 21.FEB.2013 16:45:23

802.11n-HT20 Low Channel

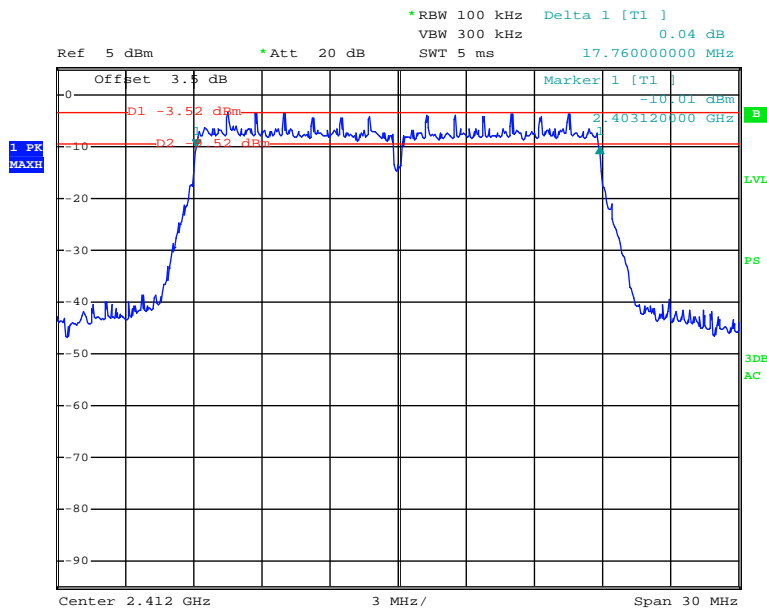

Date: 21.FEB.2013 16:51:19

802.11n-HT20 Middle Channel

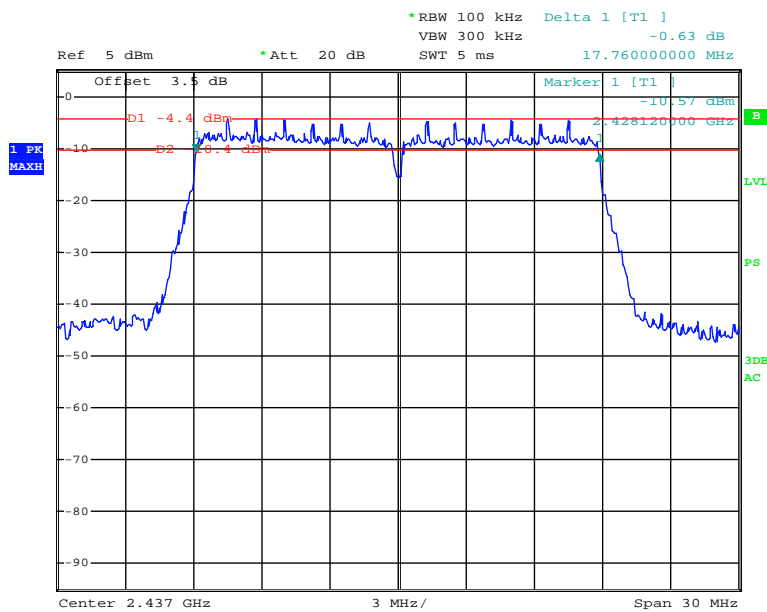

Date: 21.FEB.2013 16:49:28

802.11n-HT20 High Channel

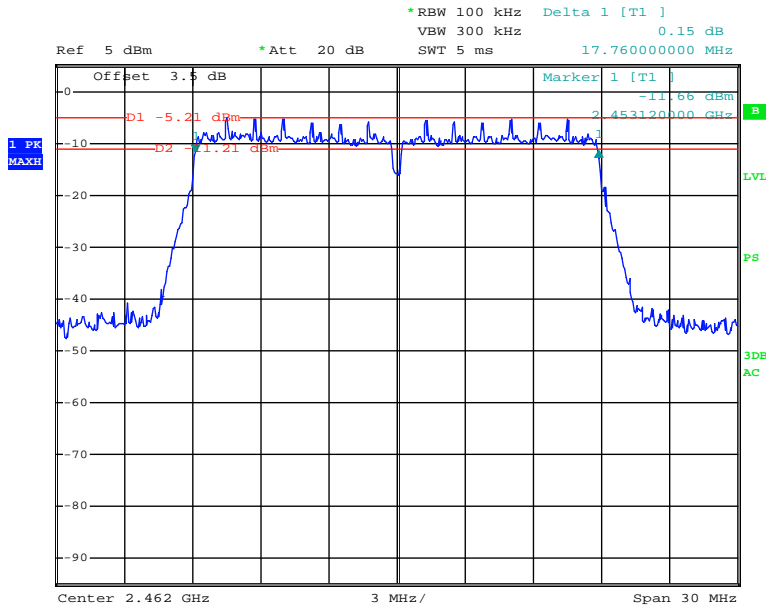

Date: 21.FEB.2013 16:47:48

802.11n-HT40 Low Channel

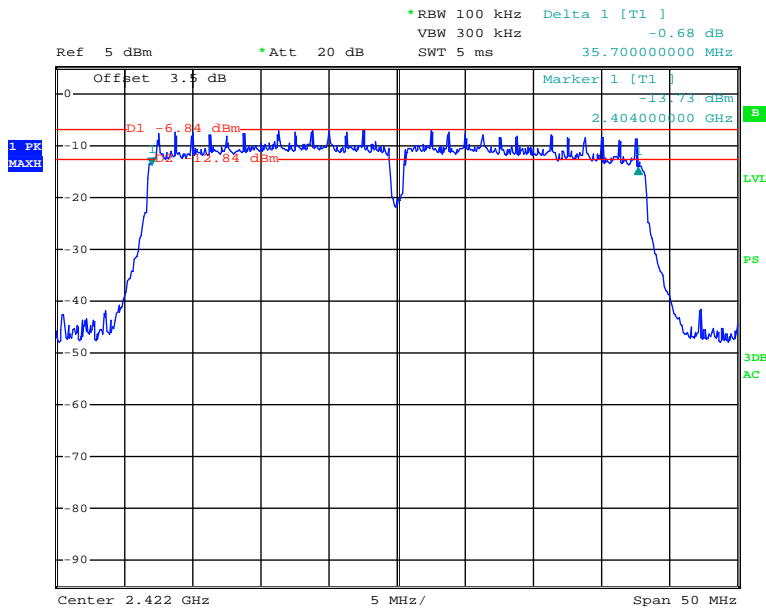

Date: 21.FEB.2013 16:53:20

802.11n-HT40 Middle Channel

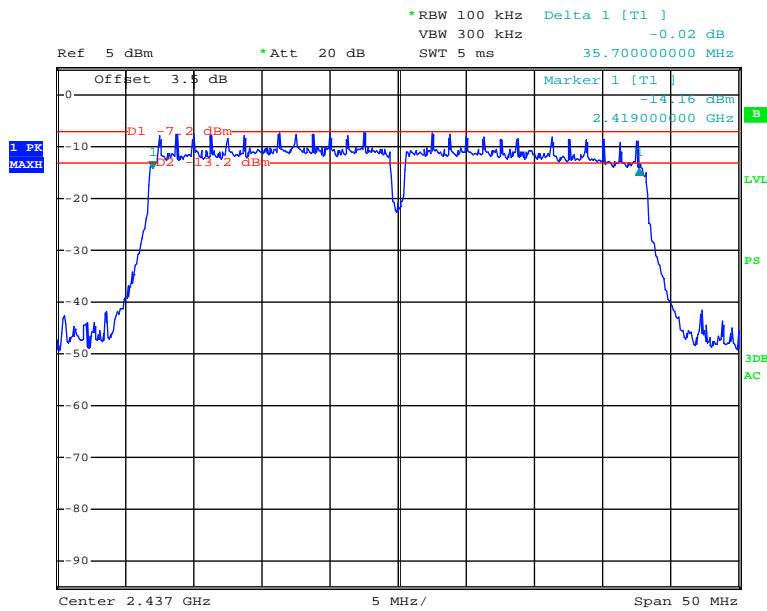

Date: 21.FEB.2013 16:54:50

802.11n-HT40 High Channel

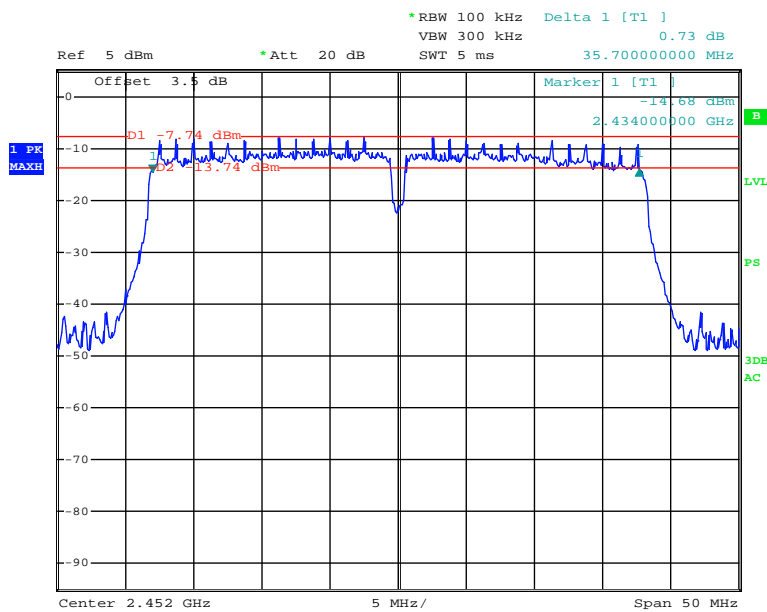

Date: 21.FEB.2013 16:56:29

FCC §15.247(b) (3) - MAXIMUM PEAK OUTPUT POWER

Applicable Standard

According to FCC §15.247(b) (3), for systems using digital modulation in the 902-928 MHz, 2400-2483.5 MHz, and 5725-5850 MHz bands: 1 Watt. As an alternative to a peak power measurement, compliance with the one Watt limit can be based on a measurement of the maximum conducted output power. Maximum Conducted Output Power is defined as the total transmit power delivered to all antennas and antenna elements averaged across all symbols in the signaling alphabet when the transmitter is operating at its maximum power control level. Power must be summed across all antennas and antenna elements. The average must not include any time intervals during which the transmitter is off or is transmitting at a reduced power level. If multiple modes of operation are possible (e.g., alternative modulation methods), the maximum conducted output power is the highest total transmit power occurring in any mode.

Test Procedure

1. Place the EUT on a bench and set it in transmitting mode.
2. Remove the antenna from the EUT and then connect a low loss RF cable from the antenna port to an EMI Test Receiver.
3. Add a correction factor to the display.

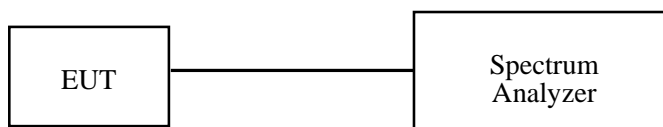

Test Equipment List and Details

Manufacturer	Description	Model	Serial Number	Calibration Date	Calibration Due Date
Rohde & Schwarz	EMI Test Receiver	ESCI	101122	2012-08-08	2013-08-07

* **Statement of Traceability:** Bay Area Compliance Laboratories Corp. (Shenzhen) attests that all calibrations have been performed in accordance to NVLAP requirements, traceable to National Primary Standards and International System of Units (SI).

Test Data

Environmental Conditions

Temperature:	23 °C
Relative Humidity:	56 %
ATM Pressure:	100.0 kPa

The testing was performed by Gardon Zhang on 2013-02-21.

EUT operation mode: Transmitting

Channel	Frequency (MHz)	Data Rate (Mbps)	Reading Power (dBm)	Limit (dBm)	Result
802.11b mode					
Low	2412	1	16.37	30	Pass
Middle	2437	1	15.41	30	Pass
High	2462	1	14.77	30	Pass
802.11g mode					
Low	2412	6	16.16	30	Pass
Middle	2437	6	15.31	30	Pass
High	2462	6	14.62	30	Pass
802.11n-HT20 mode					
Low	2412	MCS 0	16.10	30	Pass
Middle	2437	MCS 0	15.24	30	Pass
High	2462	MCS 0	14.54	30	Pass
802.11n-HT40 mode					
Low	2422	MCS 0	15.62	30	Pass
Middle	2437	MCS 0	15.18	30	Pass
High	2452	MCS 0	14.51	30	Pass

802.11b RF Output Power, Low Channel

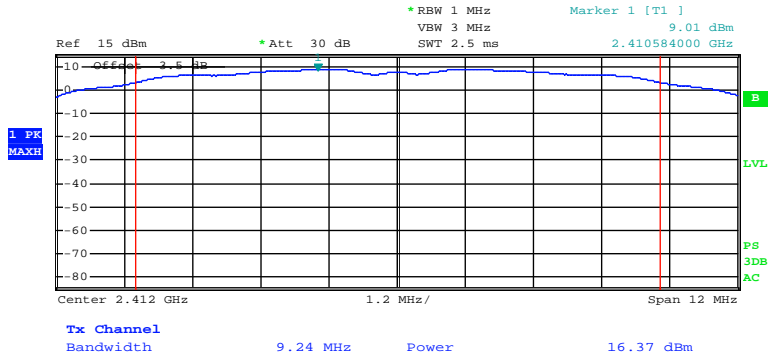

Date: 21.FEB.2013 17:03:28

802.11b RF Output Power, Middle Channel

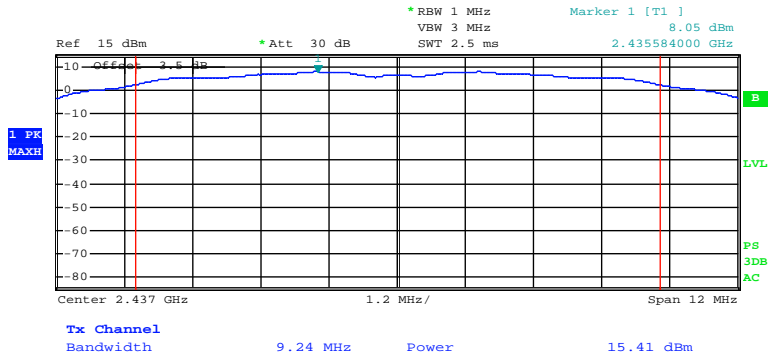

Date: 21.FEB.2013 17:02:04

802.11b RF Output Power, High Channel

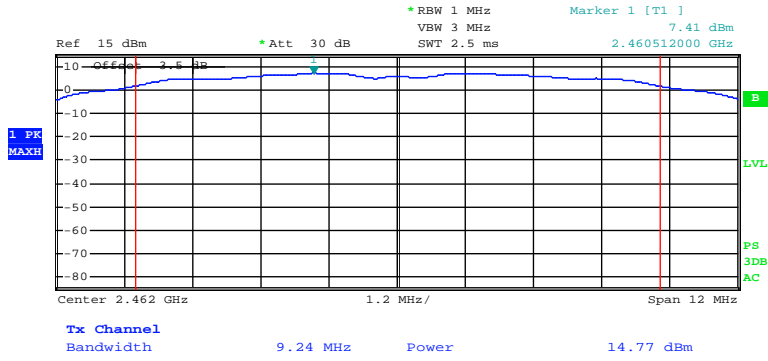

Date: 21.FEB.2013 17:02:47

802.11g RF Output Power, Low Channel

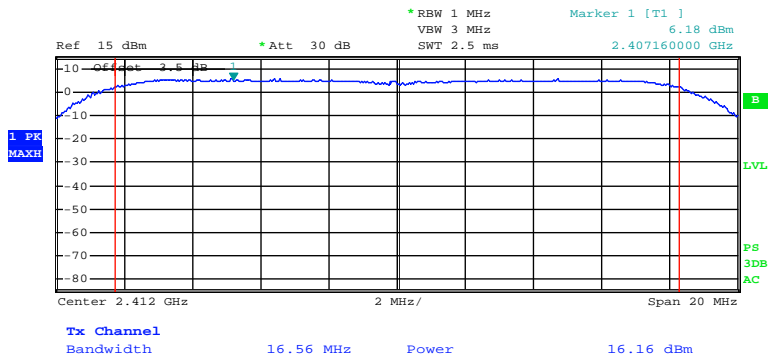

Date: 21.FEB.2013 17:06:23

802.11g RF Output Power, Middle Channel

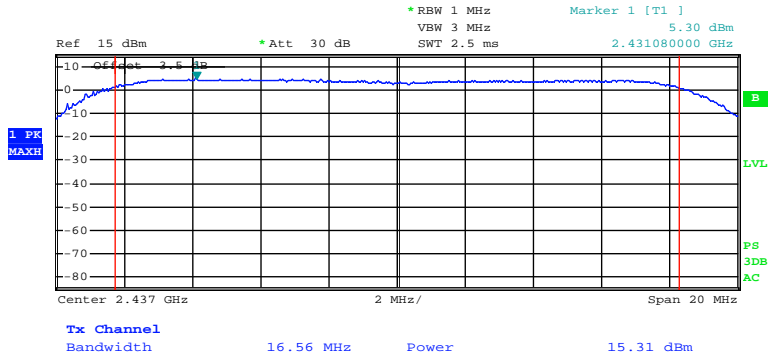

Date: 21.FEB.2013 17:08:31

802.11g RF Output Power, High Channel

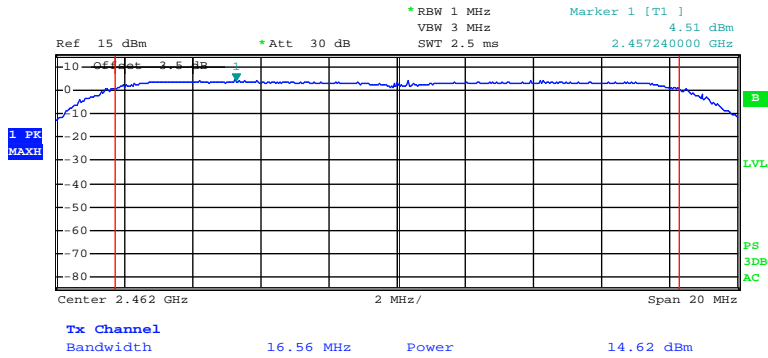

Date: 21.FEB.2013 17:10:50

802.11n-HT20 RF Output Power, Low Channel

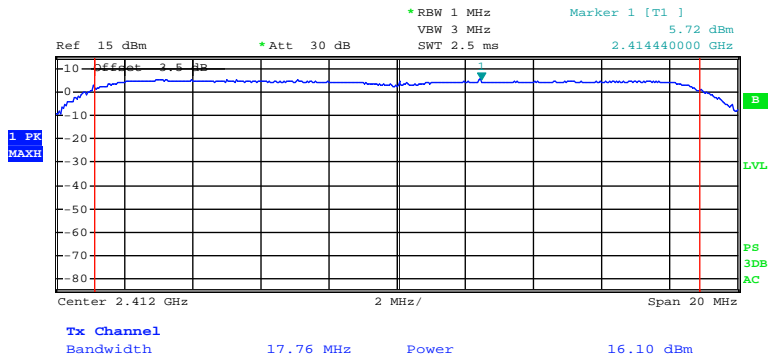

Date: 21.FEB.2013 17:15:02

802.11 n-HT20 RF Output Power, Middle Channel

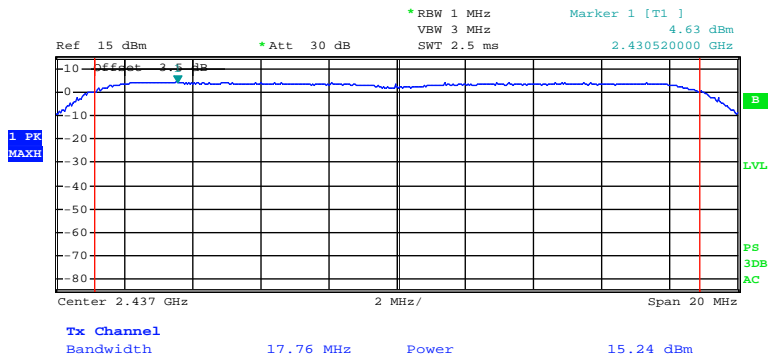

Date: 21.FEB.2013 17:13:44

802.11 n-HT20 RF Output Power, High Channel

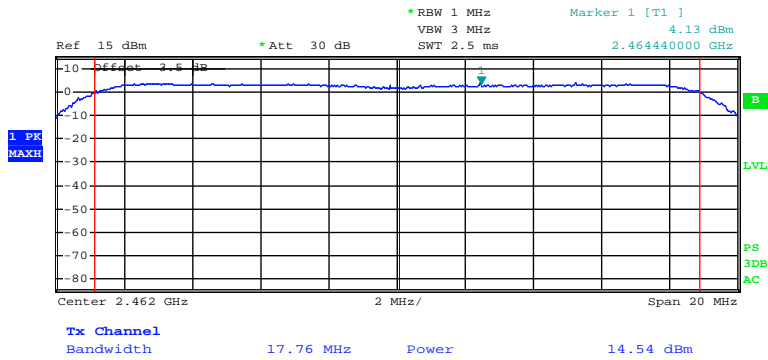

Date: 21.FEB.2013 17:12:41

802.11n-HT40 RF Output Power, Low Channel

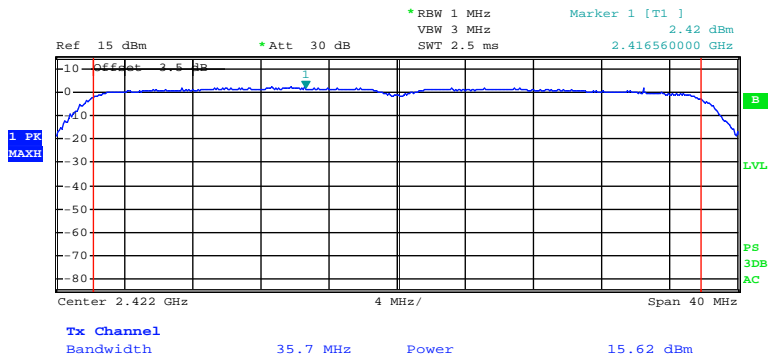

Date: 21.FEB.2013 17:17:03

802.11 n-HT40 RF Output Power, Middle Channel

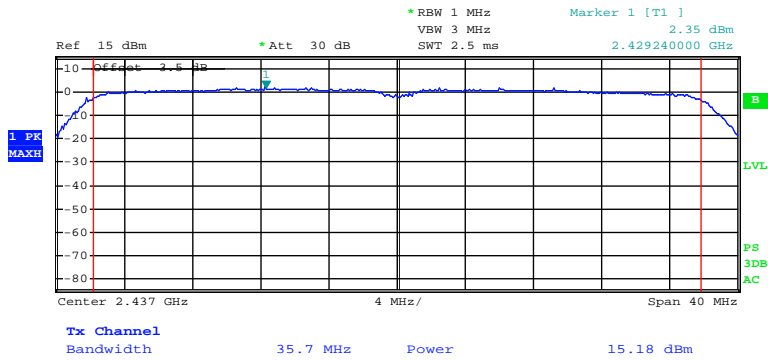

Date: 21.FEB.2013 17:17:49

802.11 n-HT40 RF Output Power, High Channel

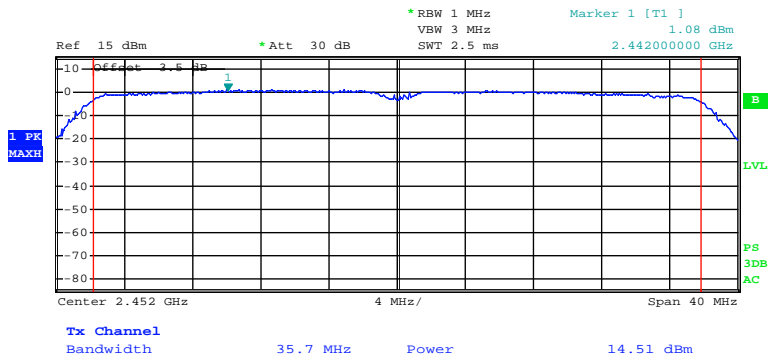

Date: 21.FEB.2013 17:18:31

FCC §15.247(d) – 100 kHz BANDWIDTH OF FREQUENCY BAND EDGE

Applicable Standard

In any 100 kHz bandwidth outside the frequency band in which the spread spectrum or digitally modulated intentional radiator is operating, the radio frequency power that is produced by the intentional radiator shall be at least 20 dB below that in the 100 kHz bandwidth within the band that contains the highest level of the desired power, based on either an RF conducted or a radiated measurement, provided the transmitter demonstrates compliance with the peak conducted power limits. If the transmitter complies with the conducted power limits based on the use of RMS averaging over a time interval, as permitted under paragraph (b)(3) of this section, the attenuation required under this paragraph shall be 30 dB instead of 20 dB. Attenuation below the general limits specified in §15.209(a) is not required. In addition, radiated emissions which fall in the restricted bands, as defined in §15.205(a), must also comply with the radiated emission limits specified in §15.209(a) (see §15.205(c)).

Test Procedure

1. Check the calibration of the measuring instrument using either an internal calibrator or a known signal from an external generator.
2. Position the EUT without connection to measurement instrument. Turn on the EUT and connect its antenna terminal to measurement instrument via a low loss cable. Then set it to any one measured frequency within its operating range, and make sure the instrument is operated in its linear range.
3. Set RBW to 100 kHz and VBW of spectrum analyzer to 300 kHz with a convenient frequency span including 100 kHz bandwidth from band edge.
4. Measure the highest amplitude appearing on spectral display and set it as a reference level. Plot the graph with marking the highest point and edge frequency.
5. Repeat above procedures until all measured frequencies were complete.

Test Equipment List and Details

Manufacturer	Description	Model	Serial Number	Calibration Date	Calibration Due Date
Rohde & Schwarz	EMI Test Receiver	ESCI	101122	2012-08-08	2013-08-07

* **Statement of Traceability:** Bay Area Compliance Laboratories Corp. (Shenzhen) attests that all calibrations have been performed in accordance to NVLAP requirements, traceable to National Primary Standards and International System of Units (SI).

Test Data

Environmental Conditions

Temperature:	25°C
Relative Humidity:	55 %
ATM Pressure:	101.0 kPa

The testing was performed by Gardon Zhang on 2013-02-17.

Test Result: Compliance

Channel	Delta Peak to Band Emission (dBc)	\geq Limit (dBc)	Result
802.11b mode			
Left-band	43.48	20	Pass
Right-band	47.02	20	Pass
802.11g mode			
Left-band	39.20	20	Pass
Right-band	41.66	20	Pass
802.11n-HT20 mode			
Left-band	38.24	20	Pass
Right-band	39.10	20	Pass
802.11n-HT40 mode			
Left-band	36.32	20	Pass
Right-band	36.11	20	Pass

Please refer to following plots.

802.11b: Band Edge, Left Side

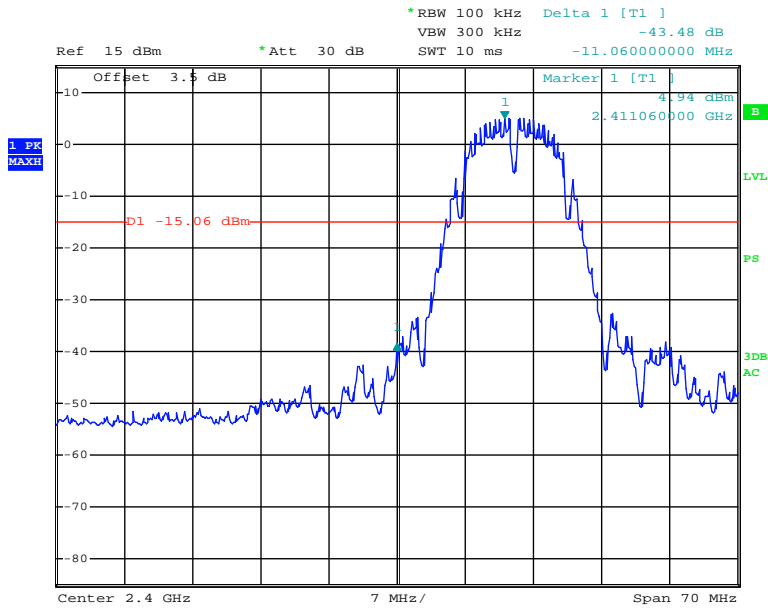

Date: 17.FEB.2013 09:02:11

802.11b: Band Edge, Right Side

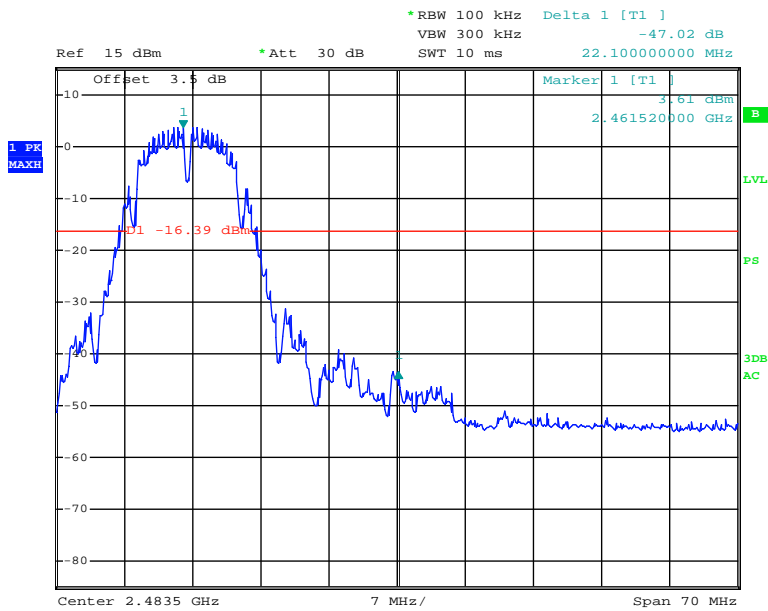

Date: 17.FEB.2013 08:57:20

802.11g: Band Edge, Left Side

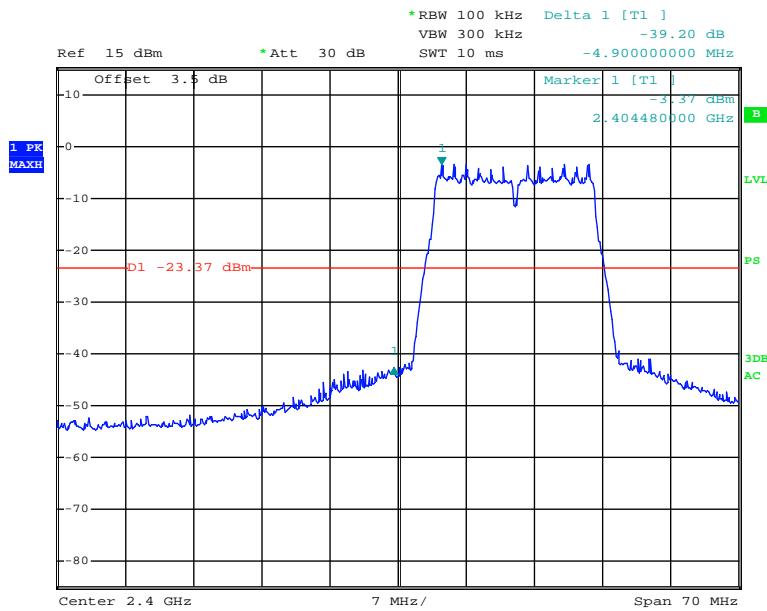

Date: 17.FEB.2013 09:41:19

802.11g: Band Edge, Right Side

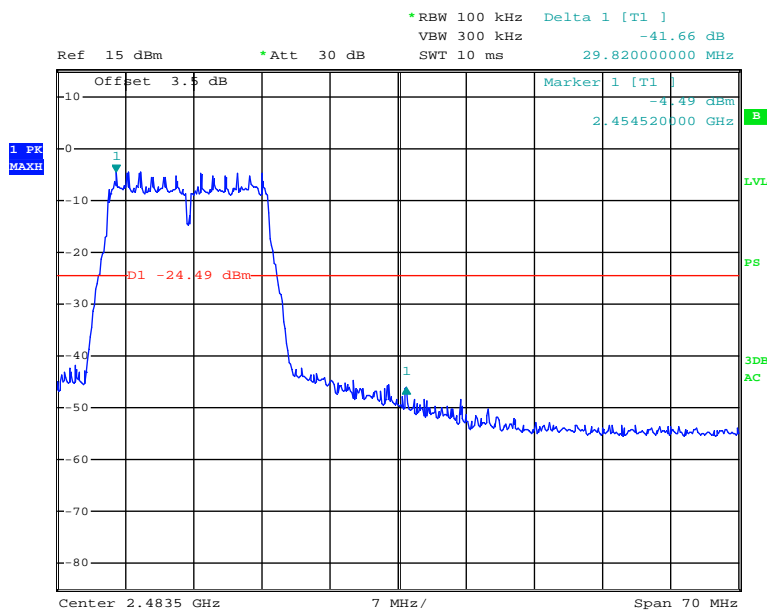

Date: 17.FEB.2013 09:43:35

802.11n-HT20: Band Edge, Left Side

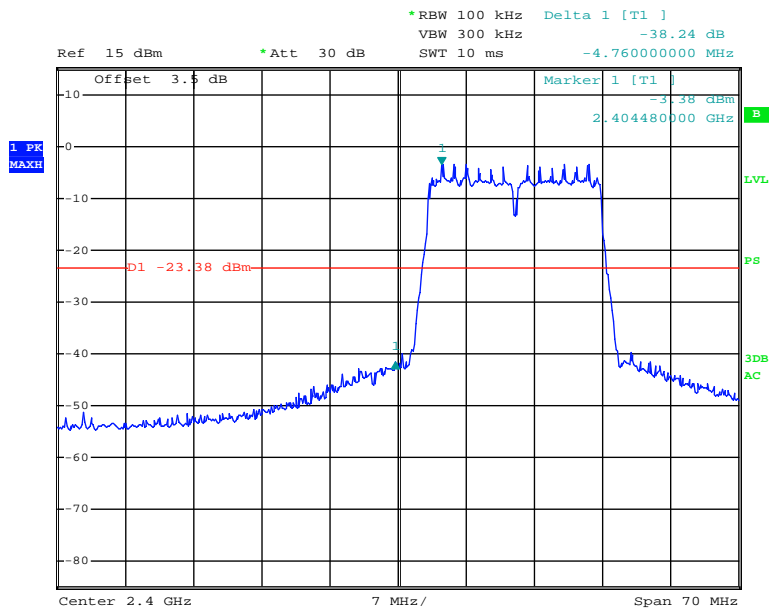

Date: 17.FEB.2013 10:09:52

802.11n-HT20: Band Edge, Right Side

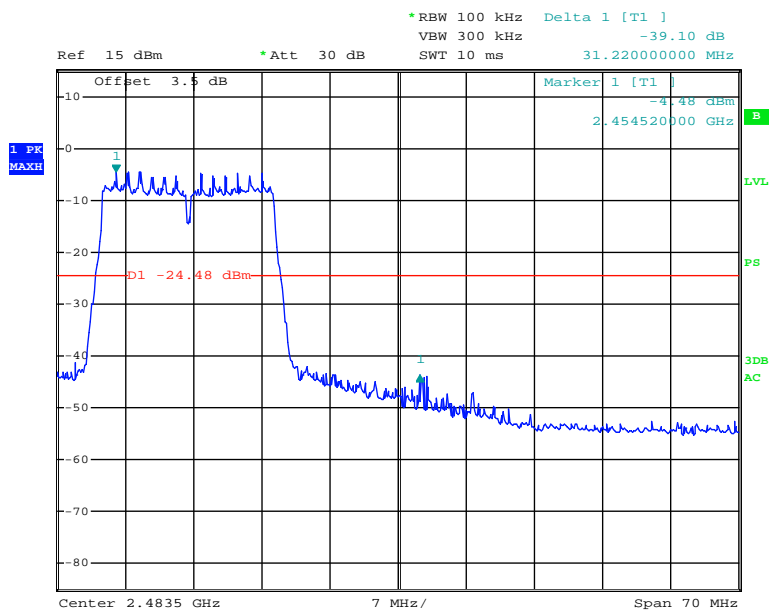

Date: 17.FEB.2013 10:12:32

802.11n-HT40: Band Edge, Left Side

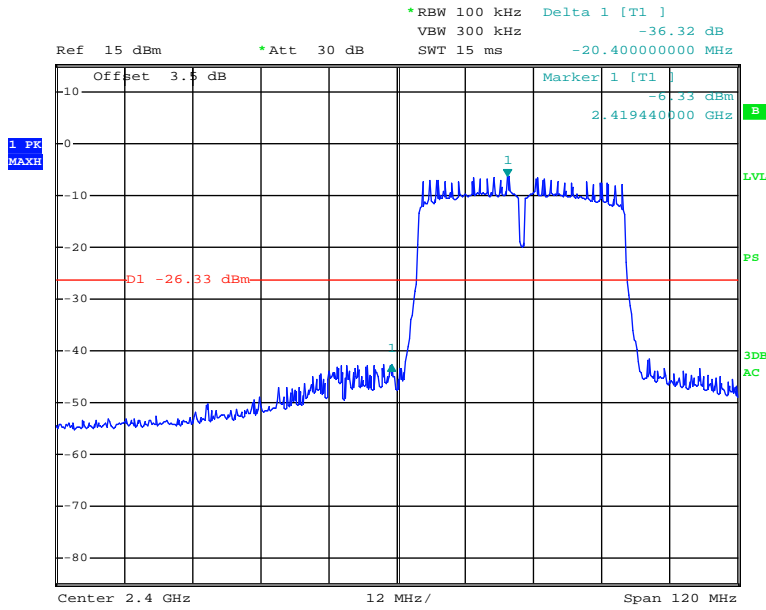

Date: 17.FEB.2013 10:37:50

802.11n-HT40: Band Edge, Right Side

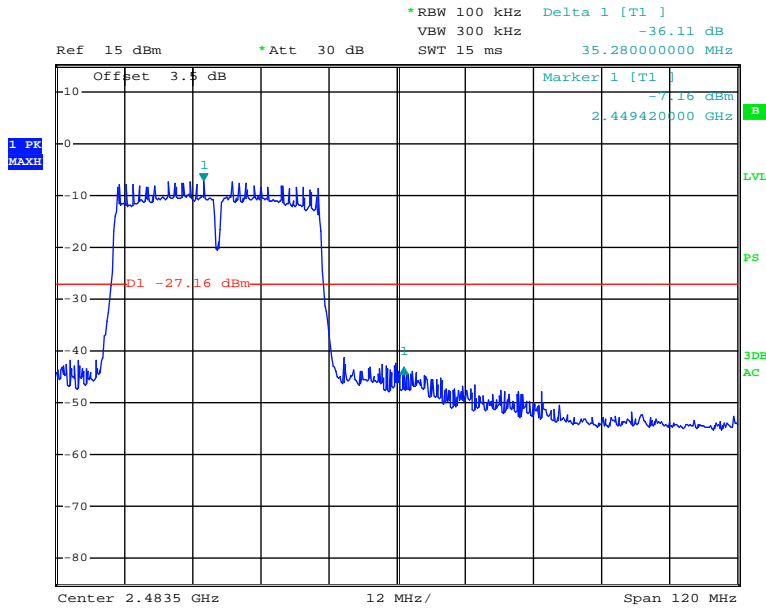

Date: 17.FEB.2013 10:36:08

FCC §15.247(e) - POWER SPECTRAL DENSITY

Applicable Standard

For digitally modulated systems, the power spectral density conducted from the intentional radiator to the antenna shall not be greater than 8 dBm in any 3 kHz band during any time interval of continuous transmission. This power spectral density shall be determined in accordance with the provisions of paragraph (b) of this section. The same method of determining the conducted output power shall be used to determine the power spectral density.

Test Procedure

1. Check the calibration of the measuring instrument using either an internal calibrator or a known signal from an external generator.
2. Position the EUT was set without connection to measurement instrument. Turn on the EUT and connect its antenna terminal to measurement instrument via a low loss cable. Then set it to any one measured frequency within its operating range, and make sure the instrument is operated in its linear range.
3. Adjust the center frequency of SA on any frequency be measured and set SA to 1.5MHz span mode. And then, set RBW and VBW of spectrum analyzer to proper value. (DTS)
4. Repeat above procedures until all frequencies measured were complete.

Test Equipment List and Details

Manufacturer	Description	Model	Serial Number	Calibration Date	Calibration Due Date
Rohde & Schwarz	EMI Test Receiver	ESCI	101122	2012-08-08	2013-08-07

* **Statement of Traceability:** Bay Area Compliance Laboratories Corp. (Shenzhen) attests that all calibrations have been performed in accordance to NVLAP requirements, traceable to National Primary Standards and International System of Units (SI).

Test Data

Environmental Conditions

Temperature:	23 °C
Relative Humidity:	56 %
ATM Pressure:	100.0 kPa

The testing was performed by Gardon Zhang on 2013-02-21.

EUT operation mode: Transmitting

Test Result: Pass

Channel	Frequency (MHz)	Data Rate (Mbps)	Correct Power spectral density (dBm)	Limit (dBm)	Result
802.11b mode					
Low	2412	1	-9.04	8	Pass
Middle	2437	1	-9.90	8	Pass
High	2462	1	-10.49	8	Pass
802.11g mode					
Low	2412	6	-17.68	8	Pass
Middle	2437	6	-17.89	8	Pass
High	2462	6	-19.19	8	Pass
802.11n-HT20 mode					
Low	2412	MCS 0	-18.01	8	Pass
Middle	2437	MCS 0	-18.39	8	Pass
High	2462	MCS 0	-19.15	8	Pass
802.11n-HT40 mode					
Low	2422	MCS 0	-20.61	8	Pass
Middle	2437	MCS 0	-21.30	8	Pass
High	2452	MCS 0	-22.45	8	Pass

Power Spectral Density, 802.11b Low Channel

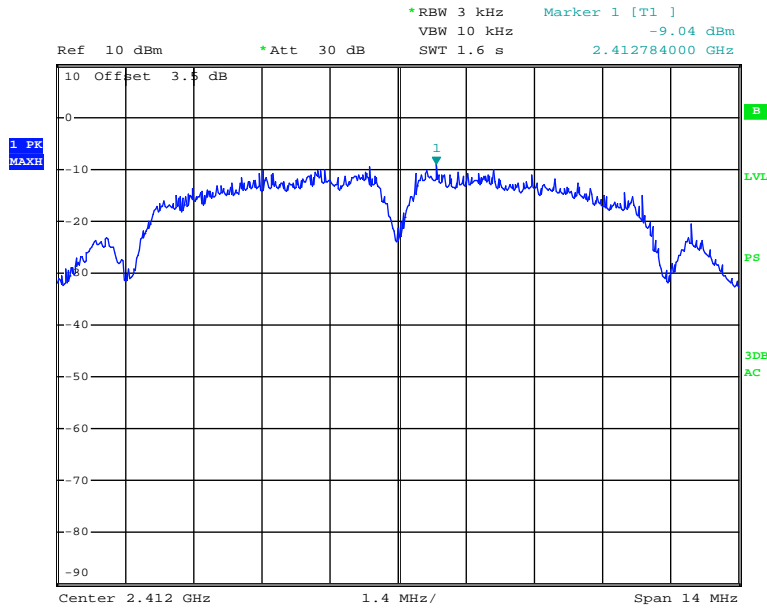

Date: 21.FEB.2013 17:41:55

Power Spectral Density, 802.11b Middle Channel

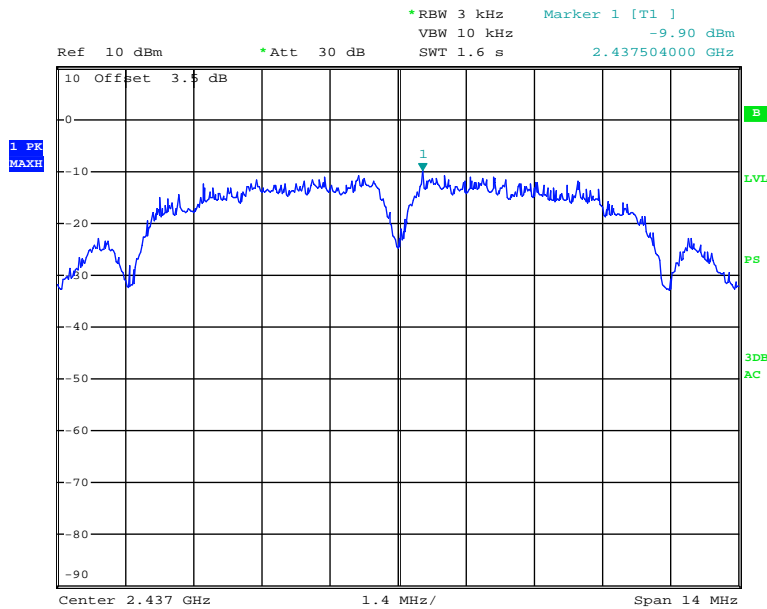

Date: 21.FEB.2013 17:42:41

Power Spectral Density, 802.11b High Channel

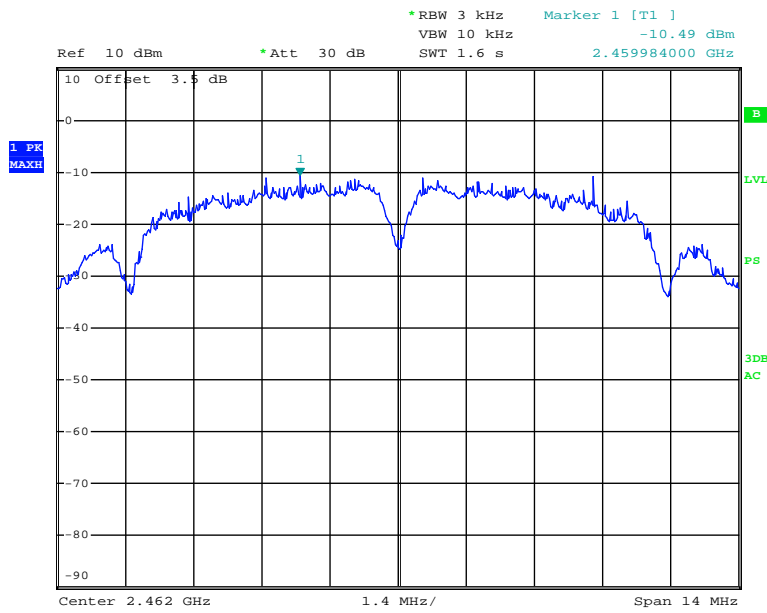

Date: 21.FEB.2013 17:43:22

Power Spectral Density, 802.11g Low Channel

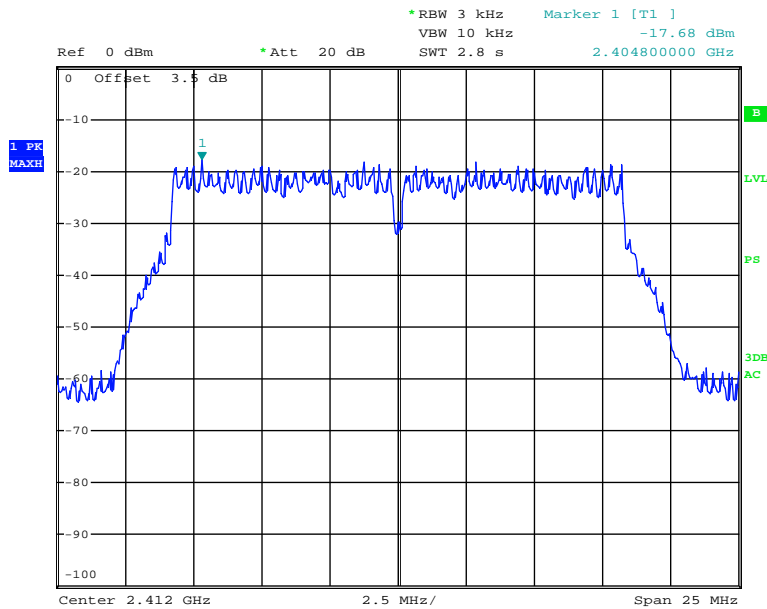

Date: 21.FEB.2013 17:37:10

Power Spectral Density, 802.11g Middle Channel

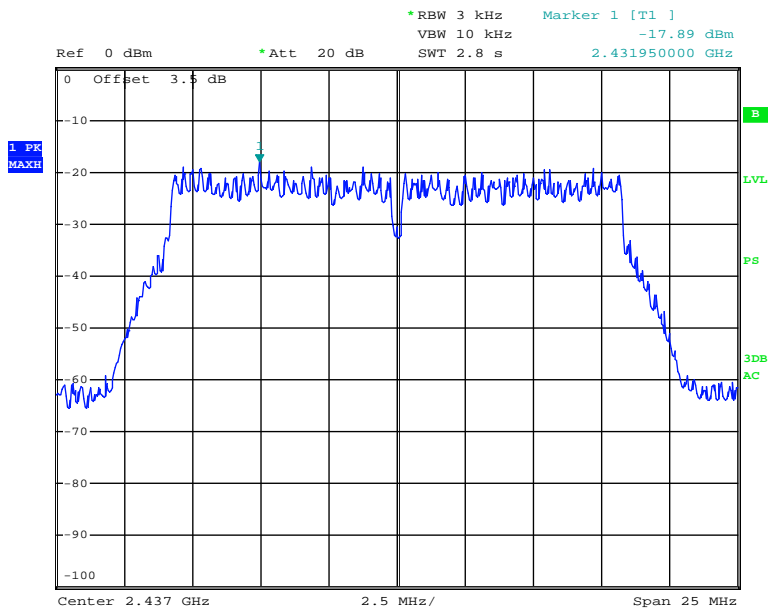

Date: 21.FEB.2013 17:37:52

Power Spectral Density, 802.11g High Channel

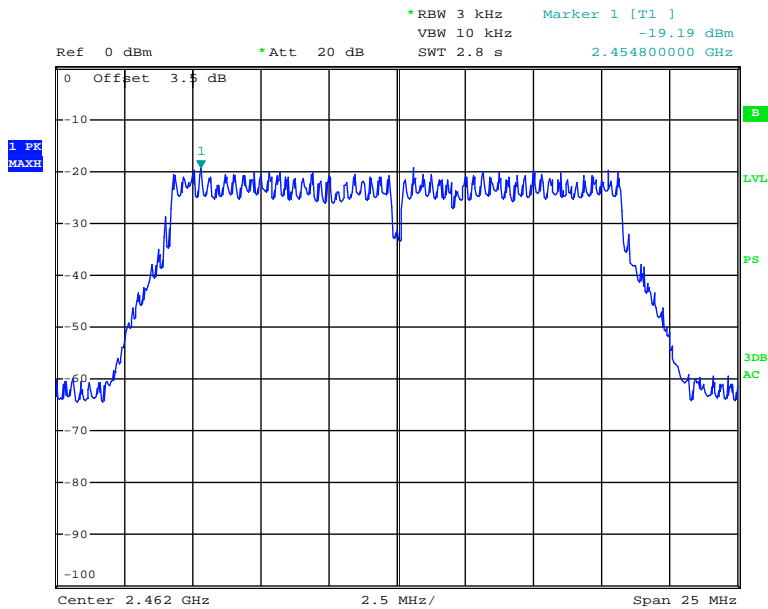

Date: 21.FEB.2013 17:38:48

Power Spectral Density, 802.11n-HT20 Low Channel

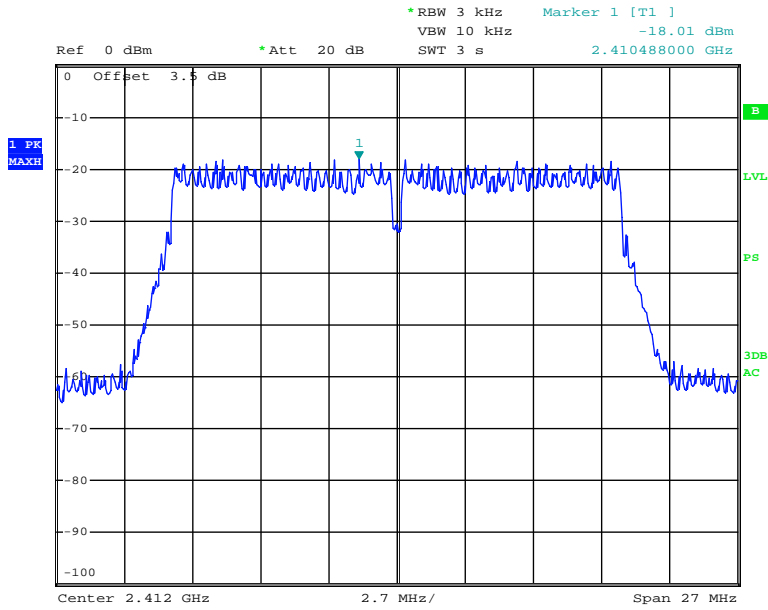

Date: 21.FEB.2013 17:31:18

Power Spectral Density, 802.11n-HT20 Middle Channel

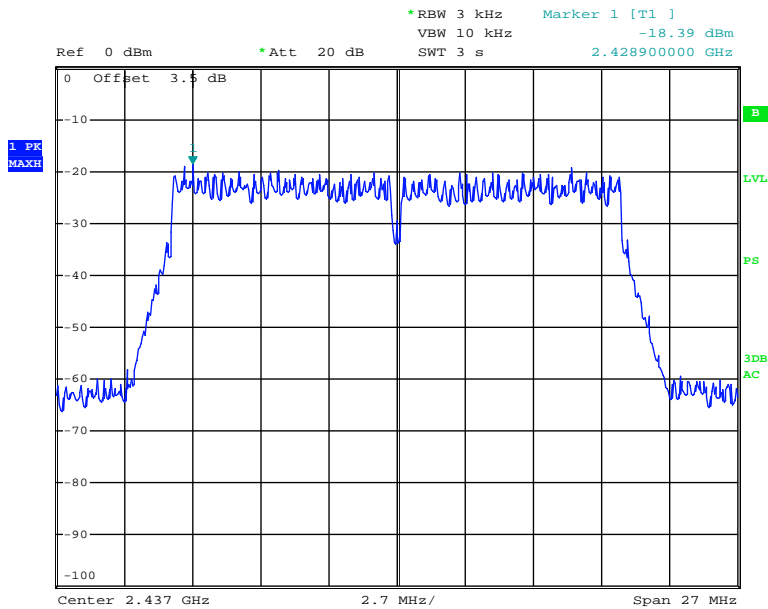

Date: 21.FEB.2013 17:32:26

Power Spectral Density, 802.11n-HT20 High Channel

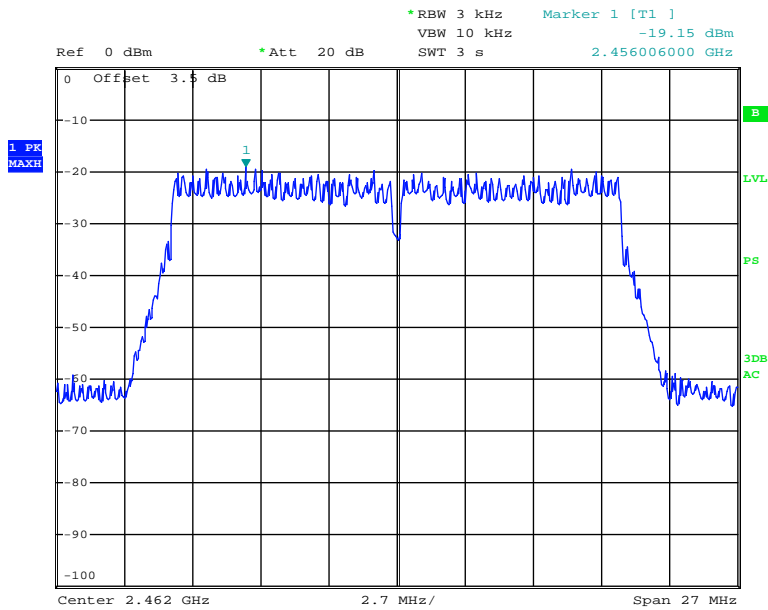

Date: 21.FEB.2013 17:33:28

Power Spectral Density, 802.11n-HT40 Low Channel

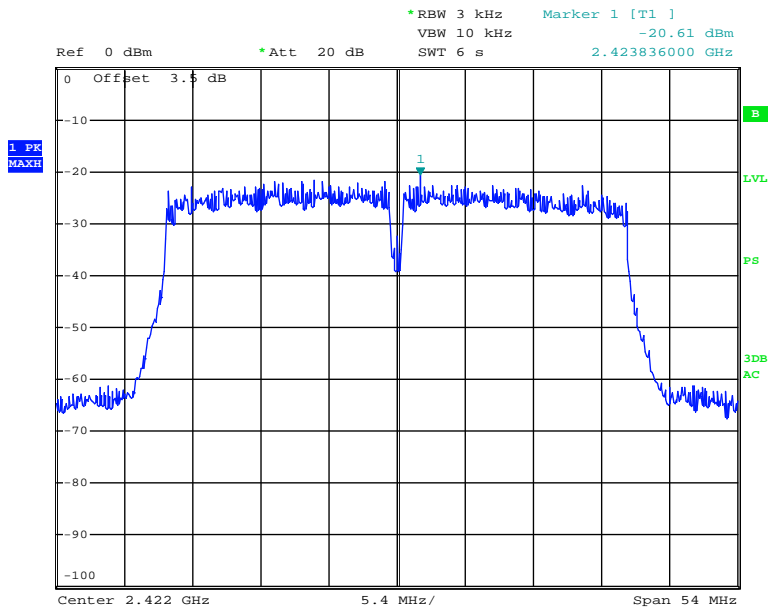

Date: 21.FEB.2013 17:25:59

Power Spectral Density, 802.11n-HT40 Middle Channel

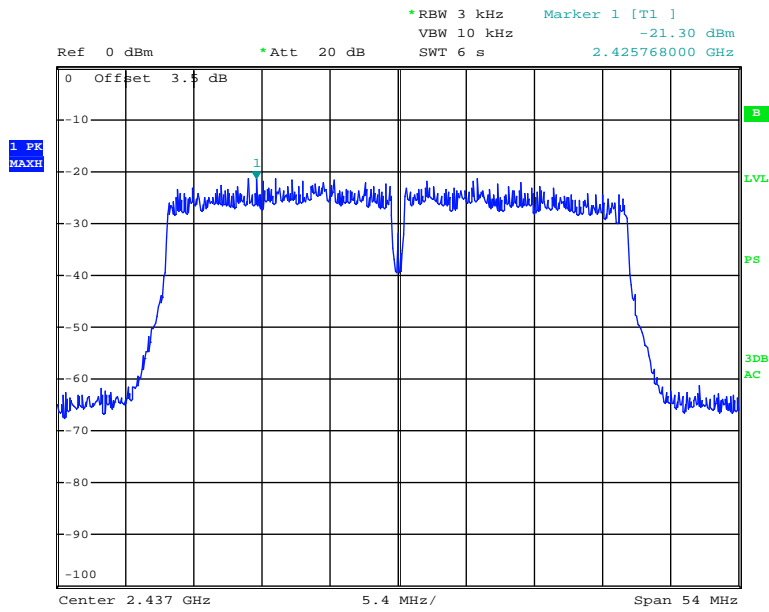

Date: 21.FEB.2013 17:27:39

Power Spectral Density, 802.11n-HT40 High Channel

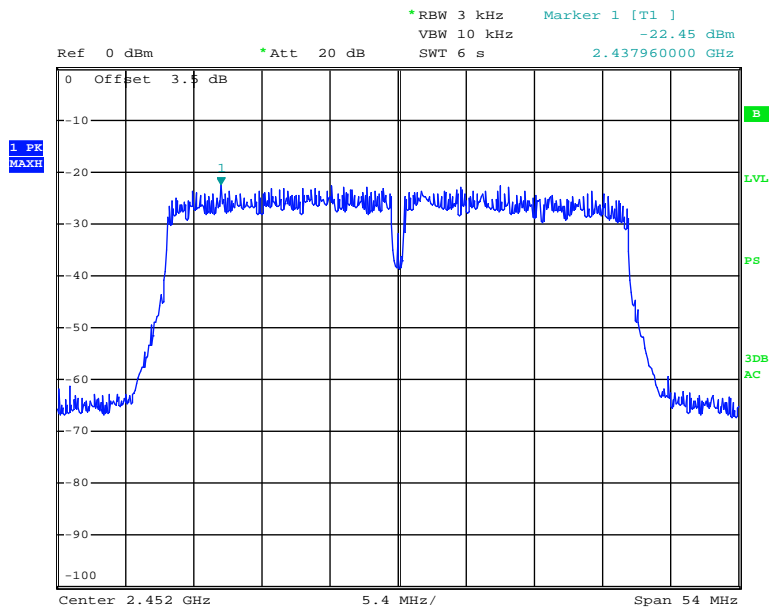

Date: 21.FEB.2013 17:29:19

***** END OF REPORT *****