



FCC REPORT

Report Reference No...... : **CHTEW19080056** Report verification: 

Project No...... : **SHT1906076103EW**

FCC ID..... : **YPVITALCOMFIXX**

Applicant's name..... : **ITALCOM GROUP**

Address..... : 1728 Coral Way,Coral Gables,Miami,Florida,United States

Manufacturer..... : Emocom Technology Co., Limited

Address..... : Unit 17,9/F., Tower A, New Mandarin Plaza, No.14 Science Museum Road, Tsimshatsui, Kowloon, Hong Kong.

Test item description : **4G telephone**

Trade Mark : NYX Mobile

Model/Type reference..... : FIXX

Listed Model(s) : -

Standard : **FCC CFR Title 47 Part 2**
FCC CFR Title 47 Part 22
FCC CFR Title 47 Part 24

Date of receipt of test sample..... : Jun 28, 2019

Date of testing..... : Jun 29, 2019- Aug 13, 2019

Date of issue..... : Aug 14, 2019

Result..... : **Pass**

Compiled by
 (position+printedname+signature).... : File administrators Silvia Li

Supervised by
 (position+printedname+signature).... : Project Engineer Aaron Fang

Approved by
 (position+printedname+signature).... : Manager Hans Hu

Silvia Li

Aaron.Fang

Hans Hu

Testing Laboratory Name : **Shenzhen Huatongwei International Inspection Co., Ltd.**

Address..... : 1/F, Bldg 3, Hongfa Hi-tech Industrial Park, Genyu Road, Tianliao, Gongming, Shenzhen, China

Shenzhen Huatongwei International Inspection Co., Ltd. All rights reserved.

This publication may be reproduced in whole or in part for non-commercial purposes as long as the Shenzhen Huatongwei International Inspection Co., Ltd. is acknowledged as copyright owner and source of the material. Shenzhen Huatongwei International Inspection Co., Ltd. takes no responsibility for and will not assume liability for damages resulting from the reader's interpretation of the reproduced material due to its placement and context.

The test report merely correspond to the test sample.

Contents

1.	<u>TEST STANDARDS AND REPORT VERSION</u>	3
1.1.	Applicable Standards	3
1.2.	Report version information	3
2.	<u>TEST DESCRIPTION</u>	4
3.	<u>SUMMARY</u>	5
3.1.	Client Information	5
3.2.	Product Description	5
3.3.	Operation state	6
3.4.	EUT configuration	6
3.5.	Modifications	6
4.	<u>TEST ENVIRONMENT</u>	7
4.1.	Address of the test laboratory	7
4.2.	Test Facility	7
4.3.	Equipments Used during the Test	8
4.4.	Environmental conditions	9
4.5.	Statement of the measurement uncertainty	9
5.	<u>TEST CONDITIONS AND RESULTS</u>	10
5.1.	Conducted Output Power	10
5.2.	Peak-Average Ratio	11
5.3.	99% Occupied Bandwidth & 26 dB Bandwidth	12
5.4.	Band Edge	13
5.5.	Conducted Spurious Emissions	14
5.6.	Frequency stability VS Temperature measurement	15
5.7.	Frequency stability VS Voltage measurement	16
5.8.	ERP and EIRP	17
5.9.	Radiated Spurious Emission	20
6.	<u>TEST SETUP PHOTOS OF THE EUT</u>	24
7.	<u>EXTERNAL AND INTERNAL PHOTOS OF THE EUT</u>	24
8.	<u>APPENDIX REPORT</u>	24

1. TEST STANDARDS AND REPORT VERSION

1.1. Applicable Standards

The tests were performed according to following standards:

[FCC Rules Part 2](#): FREQUENCY ALLOCATIONS AND RADIO TREATY MATTERS; GENERAL RULES AND REGULATIONS

[FCC Rules Part 22](#): PUBLIC MOBILE SERVICES

[FCC Rules Part 24](#): PERSONAL COMMUNICATIONS SERVICES

[TIA/EIA 603 E March 2016](#): Land Mobile FM or PM Communications Equipment Measurement and Performance Standards.

[ANSI C63.26: 2015](#): American National Standard for Compliance Testing of Transmitters Used in Licensed Radio Services

[KDB 971168 D01 Power Meas License Digital Systems v03](#): MEASUREMENT GUIDANCE FOR CERTIFICATION OF LICENSED DIGITAL TRANSMITTERS

1.2. Report version information

Revision No.	Date of issue	Description
N/A	2019-08-13	Original

2. Test Description

Test Item	Section in CFR 47	Result	Test Engineer
Conducted Output Power	Part 2.1046 Part 22.913(a) Part 24.232(c)	Pass	Jiongsheng Feng
Peak-to-Average Ratio	Part 24.232	Pass	Jiongsheng Feng
99% Occupied Bandwidth & 26 dB Bandwidth	Part 2.1049 Part 22.917(b) Part 24.238(b)	Pass	Jiongsheng Feng
Band Edge	Part 2.1051 Part 22.917 Part 24.238	Pass	Jiongsheng Feng
Conducted Spurious Emissions	Part 2.1051 Part 22.917 Part 24.238	Pass	Jiongsheng Feng
Frequency stability vs temperature	Part 2.1055(a)(1)(b) Part 22.355 Part 24.235	Pass	Jiongsheng Feng
Frequency stability vs voltage	Part 2.1055(d)(1)(2) Part 22.355 Part 24.235	Pass	Jiongsheng Feng
ERP and EIRP	Part 22.913(a) Part 24.232(b)	Pass	Shower Dai
Radiated Spurious Emissions	Part 2.1053 Part 22.917 Part 24.238	Pass	Shower Dai

Note: The measurement uncertainty is not included in the test result.

3. SUMMARY

3.1. Client Information

Applicant:	ITALCOM GROUP
Address:	1728 Coral Way,Coral Gables,Miami,Florida,United States
Manufacturer:	Emocom Technology Co., Limited
Address:	Unit 17,9/F., Tower A, New Mandarin Plaza, No.14 Science Museum Road, Tsimshatsui, Kowloon, Hong Kong.

3.2. Product Description

Name of EUT:	4G telephone
Trade Mark:	NYX Mobile
Model No.:	FIXX
Listed Model(s):	-
IMEI Code:	Conducted: 865757040000589 Radiated: 865757040000513
SIM Information:	Support One SIM Card
Power supply:	DC 3.7V
Adapter information:	Input:100-240Va.c., 50/60Hz, 150mA Max Output:5.0Vd.c., 1.0A
Hardware version:	NYX_FIXX_001
Software version:	FIXX_AMXNYX_V001R
3G:	
Operation Band:	FDD Band II, FDD Band V
Power Class:	Class 3
Modulation Type:	QPSK
Transmit frequency:	FDD Band II: 1852.40MHz~1907.60MHz FDD Band V: 826.40MHz~846.60MHz
Receive frequency:	FDD Band II: 1932.40MHz~1987.60MHz FDD Band V: 871.40MHz~891.60MHz
DC-HSUPA Release Version:	Not Supported
Antenna type:	Dipole Antenna
Antenna gain:	Band II: 3.0dBi, Band V: 1.5dBi

3.3. Operation state

➤ Test frequency list

FDD Band II		FDD Band V	
Channel	Frequency (MHz)	Channel	Frequency (MHz)
9262	1852.40	4132	826.40
9400	1880.00	4183	836.60
9538	1907.60	4233	846.60

➤ Test mode

Antenna port conducted and radiated test items were performed according to KDB 971168 D01 Power Meas. License Digital Systems v03 and ANSI C63.26-2015 with maximum output power.

Radiated measurements were performed with rotating EUT in different three orthogonal test planes to find the maximum emission.

Radiated emissions were investigated as following frequency range:

30 MHz to 10th harmonic for FDD Band II, Band V.

All modes and data rates and positions were investigated.

Test modes are chosen to be reported as the worst case configuration below:

Test modes		
Band	Radiated	Conducted
WCDMA Band V	■ RMC 12.2Kbps Link	■ RMC 12.2Kbps Link
WCDMA Band II	■ RMC 12.2Kbps Link	■ RMC 12.2Kbps Link

3.4. EUT configuration

The following peripheral devices and interface cables were connected during the measurement:

- - supplied by the manufacturer
- - supplied by the lab

○	/	Manufacturer:	/
		Model No.:	/
○	/	Manufacturer:	/
		Model No.:	/

3.5. Modifications

No modifications were implemented to meet testing criteria.

4. TEST ENVIRONMENT

4.1. Address of the test laboratory

Laboratory: Shenzhen Huatongwei International Inspection Co., Ltd.

Address: 1/F, Bldg 3, Hongfa Hi-tech Industrial Park, Genyu Road, Tianliao, Gongming, Shenzhen, China.

4.2. Test Facility

CNAS-Lab Code: L1225

Shenzhen Huatongwei International Inspection Co., Ltd. has been assessed and proved to be in compliance with CNAS-CL01 Accreditation Criteria for Testing and Calibration Laboratories (identical to ISO/IEC17025: 2005 General Requirements) for the Competence of Testing and Calibration Laboratories.

A2LA-Lab Cert. No.: 3902.01

Shenzhen Huatongwei International Inspection Co., Ltd. EMC Laboratory has been accredited by A2LA for technical competence in the field of electrical testing, and proved to be in compliance with ISO/IEC 17025: 2005 General Requirements for the Competence of Testing and Calibration Laboratories and any additional program requirements in the identified field of testing.

FCC-Registration No.: 762235

Shenzhen Huatongwei International Inspection Co., Ltd. EMC Laboratory has been registered and fully described in a report filed with the FCC (Federal Communications Commission). The acceptance letter from the FCC is maintained in our files.

IC-Registration No.:5377A

Two 3m Alternate Test Site of Shenzhen Huatongwei International Inspection Co., Ltd. has been registered by Certification and Engineering Bureau of Industry Canada for the performance of radiated measurements with Registration No.: 5377A.

ACA

Shenzhen Huatongwei International Inspection Co., Ltd. EMC Laboratory can also perform testing for the Australian C-Tick mark as a result of our A2LA accreditation.

4.3. Equipments Used during the Test

Used	Test Equipment	Manufacturer	Model No.	Serial No.	Last Cal. Date (YY-MM-DD)	Next Cal. Date (YY-MM-DD)
●	Signal and spectrum Analyzer	R&S	FSV40	100048	2018/10/28	2019/10/27
●	Spectrum Analyzer	Agilent	N9020A	MY50510187	2018/09/29	2019/09/28
●	Radio communication tester	R&S	CMW500	137688-Lv	2018/09/29	2019/09/28
●	Test software	Tonscend	JS1120-1(LTE)	N/A	N/A	N/A
●	Test software	Tonscend	JS1120-2(WIFI)	N/A	N/A	N/A
●	Test software	Tonscend	JS1120-3(WCDMA)	N/A	N/A	N/A
●	Test software	Tonscend	JS1120-4(GSM)	N/A	N/A	N/A

● Radiated Spurious Emission

Used	Test Equipment	Manufacturer	Model No.	Serial No.	Last Cal. Date (YY-MM-DD)	Next Cal. Date (YY-MM-DD)
●	Semi-Anechoic Chamber	Albatross projects	SAC-3m-01	N/A	2018/09/30	2021/09/29
●	Spectrum Analyzer	R&S	FSP40	100597	2018/10/27	2019/10/26
●	Loop Antenna	R&S	HFH2-Z2	100020	2017/11/20	2020/11/19
●	Ultra-Broadband Antenna	SCHWARZBECK	VULB9163	538	2017/04/05	2020/04/04
●	Horn Antenna	SCHWARZBECK	9120D	1011	2017/04/01	2020/03/31
○	Horn Antenna	SCHWARZBECK	BBHA9170	25841	2017/03/27	2020/03/26
○	Pre-amplifier	BONN	BLWA0160-2M	1811887	2018/11/14	2019/11/13
●	Pre-amplifier	CD	PAP-0102	12004	2018/11/14	2019/11/13
●	Broadband Preamplifier	SCHWARZBECK	BBV 9718	9718-248	2019/04/26	2020/04/25
●	RF Connection Cable	HUBER+SUHNER	RE-7-FH	N/A	2018/11/15	2019/11/14
●	RF Connection Cable	HUBER+SUHNER	RE-7-FL	N/A	2018/11/15	2019/11/14
●	EMI Test Software	Audix	E3	N/A	N/A	N/A
●	Turntable	MATURO	TT2.0	N/A	N/A	N/A
●	Antenna Mast	MATURO	TAM-4.0-P	N/A	N/A	N/A

4.4. Environmental conditions

During the measurement the environmental conditions were within the listed ranges:

Voltage	VN=Nominal Voltage	DC 3.70V
	VL=Lower Voltage	DC 3.60V
	VH=Higher Voltage	DC 4.20V
Temperature	TN=Normal Temperature	25 °C
	Extreme Temperature	From -30° to + 50° centigrade
Humidity	30~60 %	
Air Pressure	950-1050 hPa	

4.5. Statement of the measurement uncertainty

The data and results referenced in this document are true and accurate. The reader is cautioned that there may be errors within the calibration limits of the equipment and facilities. The measurement uncertainty was calculated for all measurements listed in this test report acc. to TR-100028-01 "Electromagnetic compatibility and Radio spectrum Matters (ERM); Uncertainties in the measurement of mobile radio equipment characteristics; Part 1" and TR-100028-02 "Electromagnetic compatibility and Radio spectrum Matters (ERM); Uncertainties in the measurement of mobile radio equipment characteristics; Part 2" and is documented in the Shenzhen Huatongwei International Inspection Co., Ltd quality system acc. to DIN EN ISO/IEC 17025. Furthermore, component and process variability of devices similar to that tested may result in additional deviation. The manufacturer has the sole responsibility of continued compliance of the device.

Hereafter the best measurement capability for Shenzhen Huatongwei laboratory is reported:

Test Items	Measurement Uncertainty	Notes
Transmitter power conducted	0.51 dB	(1)
Transmitter power Radiated	2.66dB for <1GHz 3.44dB for >1GHz	(1)
Conducted spurious emissions 9kHz~40GHz	0.51 dB	(1)
Radiated spurious emissions	2.66dB for <1GHz 3.44dB for >1GHz	(1)
Occupied Bandwidth	15Hz for <1GHz 70Hz for >1GHz	(1)
Frequency error	15Hz for <1GHz 70Hz for >1GHz	(1)

(1) This uncertainty represents an expanded uncertainty expressed at approximately the 95% confidence level using a coverage factor of $k=1.96$.

5. TEST CONDITIONS AND RESULTS

5.1. Conducted Output Power

LIMIT

N/A

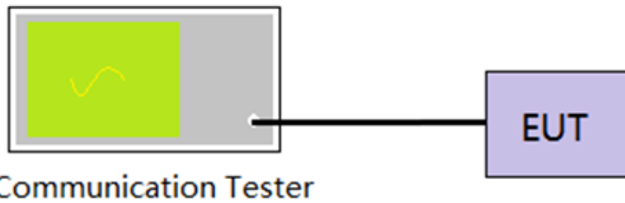
TEST CONFIGURATION**TEST PROCEDURE**

1. The EUT output port was connected to communication tester.
2. Set EUT at maximum power through communication tester.
3. Select lowest, middle, and highest channels for each band and different modulation.
4. Measure the maximum burst average power.

TEST MODE:

Please refer to the clause 3.3

TEST RESULTS **Passed** **Not Applicable**

Refer to appendix A on the section 8 appendix report

5.2. Peak-Average Ratio

LIMIT

13dB

TEST CONFIGURATION



TEST PROCEDURE

1. The EUT was connected to the spectrum analyzer and communication tester via a power splitter
2. Set EUT in maximum power output.
3. Center Frequency = Carrier frequency, RBW > Emission bandwidth of signal
4. The signal analyzer was set to collect one million samples to generate the CCDF curve
5. The measurement interval was set depending on the type of signal analyzed.
 - i. For continuous signals (>98% duty cycle), the measurement interval was set to 1ms.
 - ii. For burst transmissions, the spectrum analyzer is set to use an internal "RF Burst" trigger that is synced with an incoming pulse and the measurement interval is set to less than the duration of the "on time" of one burst to ensure that energy is only captured during a time in which the transmitter is operating at maximum power
6. Record the maximum PAPR level associated with a probability of 0.1%.

TEST MODE:

Please refer to the clause 3.3

TEST RESULTS

Passed Not Applicable

Refer to appendix B on the section 8 appendix report

5.3. 99% Occupied Bandwidth & 26 dB Bandwidth

LIMIT

N/A

TEST CONFIGURATION**TEST PROCEDURE**

1. The EUT was connected to the spectrum analyzer and communication tester via a power splitter
2. Set EUT in maximum power output.
3. Spectrum analyzer setting as follow:
Center Frequency= Carrier frequency, RBW=1% to 5% of anticipated OBW, VBW= 3 * RBW,
Detector=Peak,
Trace maximum hold.
4. Record the value of 99% Occupied bandwidth and -26dB bandwidth.

TEST MODE:

Please refer to the clause 3.3

TEST RESULTS **Passed** **Not Applicable**

Refer to appendix C on the section 8 appendix report

5.4. Band Edge

LIMIT

Part 24.238 and Part 22.917 specify that the power of any emission outside of the authorized operating frequency ranges must be attenuated below the transmitting power (P) by a factor of at least $43 + 10 \log(P)$ dB.

The specification that emissions shall be attenuated below the transmitter power (P) by at least $43 + 10 \log(P)$ dB, translates in the relevant power range (1 to 0.001 W) to -13 dBm. At 1 W the specified minimum attenuation becomes 43 dB and relative to a 30 dBm (1 W) carrier becomes a limit of -13 dBm. At 0.001 W (0 dBm) the minimum attenuation is 13 dB, which again yields a limit of -13 dBm. In this way a translation of the specification from relative to absolute terms is carried out.

TEST CONFIGURATION

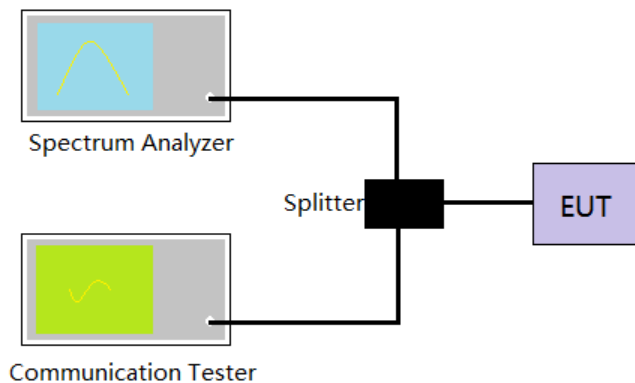

TEST PROCEDURE

1. The EUT was connected to the spectrum analyzer and communication tester via a power splitter
2. Set EUT in maximum power output.
3. The band edges of low and high channels were measured.
4. Spectrum analyzer setting as follow:
RBW=100KHz, VBW = 300KHz, Sweep time= Auto
5. Record the test plot.

TEST MODE:

Please refer to the clause 3.3

TEST RESULTS

Passed Not Applicable

Refer to appendix D on the section 8 appendix report

5.5. Conducted Spurious Emissions

LIMIT

Part 24.238 and Part 22.917 specify that the power of any emission outside of the authorized operating frequency ranges must be attenuated below the transmitting power (P) by a factor of at least $43 + 10 \log(P)$ dB.

The specification that emissions shall be attenuated below the transmitter power (P) by at least $43 + 10 \log(P)$ dB, translates in the relevant power range (1 to 0.001 W) to -13 dBm. At 1 W the specified minimum attenuation becomes 43 dB and relative to a 30 dBm (1 W) carrier becomes a limit of -13 dBm. At 0.001 W (0 dBm) the minimum attenuation is 13 dB, which again yields a limit of -13 dBm. In this way a translation of the specification from relative to absolute terms is carried out.

TEST CONFIGURATION



TEST PROCEDURE

1. The EUT was connected to the spectrum analyzer and communication tester via a power splitter
2. Set EUT in maximum power output.
3. Spectrum analyzer setting as follow:
Below 1GHz, RBW=100KHz, VBW = 300KHz, Detector=Peak, Sweep time= Auto
Above 1GHz, RBW=1MHz, VBW=3MHz, Detector=Peak, Sweep time= Auto
Scan frequency range up to 10th harmonic.
4. Record the test plot.

TEST MODE:

Please refer to the clause 3.3

TEST RESULTS

Passed Not Applicable

Refer to appendix E on the section 8 appendix report

5.6. Frequency stability VS Temperature measurement

LIMIT

2.5ppm

TEST CONFIGURATION



TEST PROCEDURE

1. The equipment under test was connected to an external DC power supply and input rated voltage.
2. The EUT output port was connected to communication tester.
3. The EUT was placed inside the temperature chamber.
4. Turn EUT off and set the chamber temperature to -30°C . After the temperature stabilized for approximately 30 minutes recorded the frequency.
5. Repeat step 4 measure with 10°C increased per stage until the highest temperature of $+50^{\circ}\text{C}$ reached.

TEST MODE:

Please refer to the clause 3.3

TEST RESULTS

Passed Not Applicable

Refer to appendix F on the section 8 appendix report

5.7. Frequency stability VS Voltage measurement

LIMIT

2.5ppm

TEST CONFIGURATION



TEST PROCEDURE

1. The equipment under test was connected to an external DC power supply and input rated voltage.
2. The EUT output port was connected to communication tester.
3. The EUT was placed inside the temperature chamber at 25°C
4. The power supply voltage to the EUT was varied $\pm 15\%$ of the nominal value measured at the input to the EUT
5. Record the maximum frequency change.

TEST MODE:

Please refer to the clause 3.3

TEST RESULTS

Passed Not Applicable

Refer to appendix F on the section 8 appendix report

5.8. ERP and EIRP

LIMIT

WCDMA Band V: 7W (38.45dBm) ERP

WCDMA Band II: 2W (33dBm) EIRP

TEST CONFIGURATION

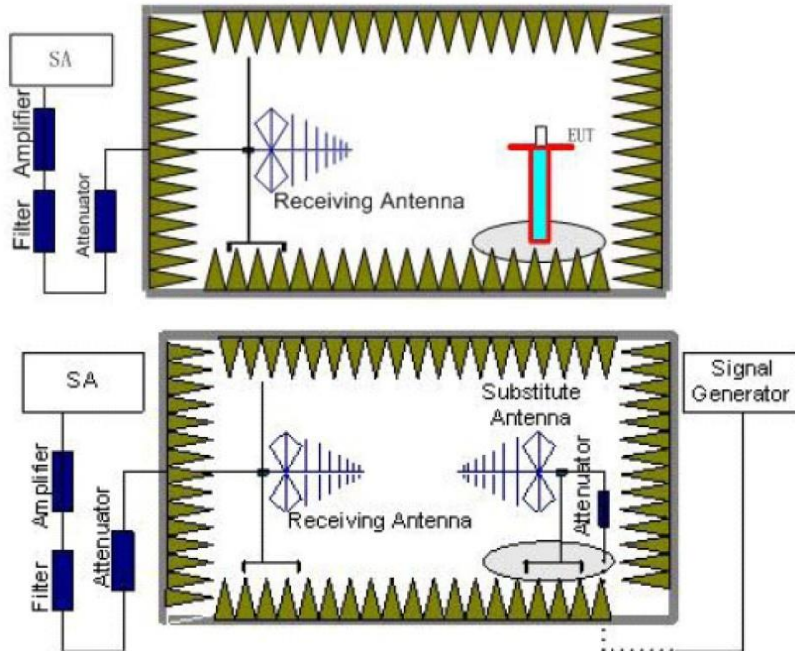

TEST PROCEDURE

1. Place the EUT in the center of the turntable.
 - a) For radiated emissions measurements performed at frequencies less than or equal to 1 GHz, the EUT shall be placed on a RF-transparent table at a nominal height of 80 cm above the reference ground plane
 - b) For radiated measurements performed at frequencies above 1 GHz, the EUT shall be placed on an RF transparent table at a nominal height of 1.5 m above the ground plane.
2. Unless the EUT uses an integral antenna, the EUT shall be terminated with a non-radiating transmitter load. In cases where the EUT uses an adjustable antenna, the antenna shall be adjusted through typical positions and lengths to maximize emissions levels.
3. The EUT shall be tested while operating on the frequency per manufacturer specification. Set the transmitter to operate in continuous transmit mode.
4. Receiver or Spectrum set as follow:
Below 1GHz, RBW=100kHz, VBW=300kHz, Detector=Peak, Sweep time=Auto
Above 1GHz, RBW=1MHz, VBW=3MHz, Detector=Peck, Sweep time=Auto
5. Each emission under consideration shall be evaluated:
 - a) Raise and lower the measurement antenna from 1 m to 4 m, as necessary to enable detection of the maximum emission amplitude relative to measurement antenna height.
 - b) Rotate the EUT through 360° to determine the maximum emission level relative to the axial position.
 - c) Return the turntable to the azimuth where the highest emission amplitude level was observed.
 - d) Vary the measurement antenna height again through 1 m to 4 m again to find the height associated with the maximum emission amplitude.
 - e) Record the measured emission amplitude level and frequency
6. Repeat step 5 for each emission frequency with the measurement antenna oriented in both the horizontal and vertical polarizations to determine the orientation that gives the maximum emissions amplitude.
7. Set-up the substitution measurement with the reference point of the substitution antenna located as near as possible to where the center of the EUT radiating element was located during the initial EUT measurement.
8. Maintain the previous measurement instrument settings and test set-up, with the exception that the EUT is removed and replaced by the substitution antenna.
9. Connect a signal generator to the substitution antenna; locate the signal generator so as to minimize any

- potential influences on the measurement results. Set the signal generator to the frequency where emissions are detected, and set an output power level such that the radiated signal can be detected by the measurement instrument, with sufficient dynamic range relative to the noise floor.
10. For each emission that was detected and measured in the initial test
 - a) Vary the measurement antenna height between 1 m to 4 m to maximize the received (measured) signal amplitude.
 - b) Adjust the signal generator output power level until the amplitude detected by the measurement instrument equals the amplitude level of the emission previously measured directly in step 5 and step 6.
 - c) Record the output power level of the signal generator when equivalence is achieved in step b).
 11. Repeat step 8 through step 10 with the measurement antenna oriented in the opposite polarization.
 12. Calculate the emission power in dBm referenced to a half-wave dipole using the following equation:
$$P_e = P_s(\text{dBm}) - \text{cable loss (dB)} + \text{antenna gain (dBd)}$$
where
 P_e = equivalent emission power in dBm
 P_s = source (signal generator) power in dBm
NOTE—dBd refers to the measured antenna gain in decibels relative to a half-wave dipole.
 13. Correct the antenna gain of the substitution antenna if necessary to reference the emission power to a half-wave dipole. When using measurement antennas with the gain specified in dBi, the equivalent dipole-referenced gain can be determined from:
$$\text{gain (dBd)} = \text{gain (dBi)} - 2.15 \text{ dB.}$$
If necessary, the antenna gain can be calculated from calibrated antenna factor information
 14. Provide the complete measurement results as a part of the test report.

TEST MODE:

Please refer to the clause 3.3

TEST RESULTS

Passed **Not Applicable**

Mode	Channel	Antenna Pol.	EIRP	Limit (dBm)	Result
WCDMA Band II	9262	V	20.17	<33.00	Pass
		H	14.66		
	9400	V	19.93		
		H	15.22		
	9538	V	21.41		
		H	17.00		

Mode	Channel	Antenna Pol.	ERP	Limit (dBm)	Result
WCDMA Band V	4132	V	22.46	<38.45	Pass
		H	22.48		
	4183	V	23.59		
		H	23.65		
	4233	V	23.76		
		H	21.29		

5.9. Radiated Spurious Emission

LIMIT

-13dBm

TEST CONFIGURATION

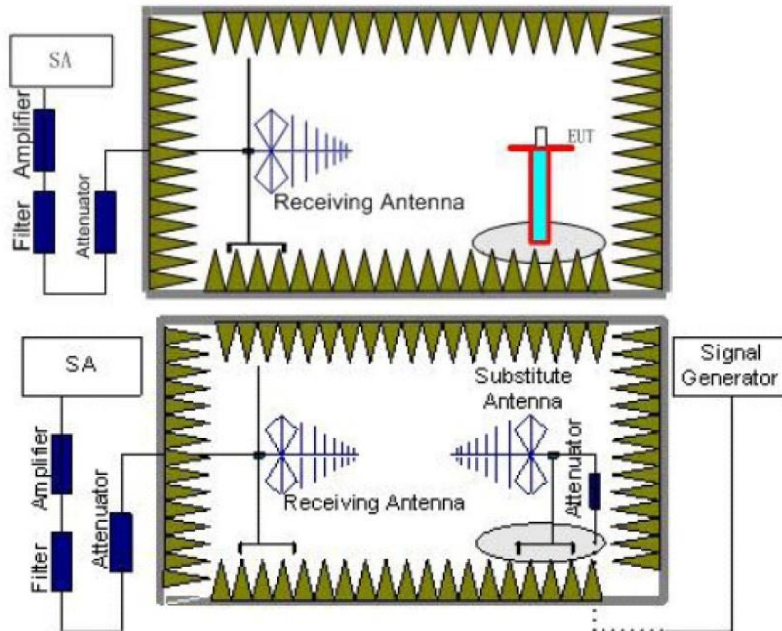

TEST PROCEDURE

1. Place the EUT in the center of the turntable.
 - a) For radiated emissions measurements performed at frequencies less than or equal to 1 GHz, the EUT shall be placed on a RF-transparent table at a nominal height of 80 cm above the reference ground plane
 - b) For radiated measurements performed at frequencies above 1 GHz, the EUT shall be placed on an RF transparent table at a nominal height of 1.5 m above the ground plane.
2. Unless the EUT uses an integral antenna, the EUT shall be terminated with a non-radiating transmitter load. In cases where the EUT uses an adjustable antenna, the antenna shall be adjusted through typical positions and lengths to maximize emissions levels.
3. The EUT shall be tested while operating on the frequency per manufacturer specification. Set the transmitter to operate in continuous transmit mode.
4. Receiver or Spectrum set as follow:
Below 1GHz, RBW=100kHz, VBW=300kHz, Detector=Peak, Sweep time=Auto
Above 1GHz, RBW=1MHz, VBW=3MHz, Detector=Peck, Sweep time=Auto
5. Each emission under consideration shall be evaluated:
 - a) Raise and lower the measurement antenna from 1 m to 4 m, as necessary to enable detection of the maximum emission amplitude relative to measurement antenna height.
 - b) Rotate the EUT through 360° to determine the maximum emission level relative to the axial position.
 - c) Return the turntable to the azimuth where the highest emission amplitude level was observed.
 - d) Vary the measurement antenna height again through 1 m to 4 m again to find the height associated with the maximum emission amplitude.
 - e) Record the measured emission amplitude level and frequency
6. Repeat step 5 for each emission frequency with the measurement antenna oriented in both the horizontal and vertical polarizations to determine the orientation that gives the maximum emissions amplitude.
7. Set-up the substitution measurement with the reference point of the substitution antenna located as near as possible to where the center of the EUT radiating element was located during the initial EUT measurement.
8. Maintain the previous measurement instrument settings and test set-up, with the exception that the EUT is removed and replaced by the substitution antenna.
9. Connect a signal generator to the substitution antenna; locate the signal generator so as to minimize any

- potential influences on the measurement results. Set the signal generator to the frequency where emissions are detected, and set an output power level such that the radiated signal can be detected by the measurement instrument, with sufficient dynamic range relative to the noise floor.
10. For each emission that was detected and measured in the initial test
 - a) Vary the measurement antenna height between 1 m to 4 m to maximize the received (measured) signal amplitude.
 - b) Adjust the signal generator output power level until the amplitude detected by the measurement instrument equals the amplitude level of the emission previously measured directly in step 5 and step 6.
 - c) Record the output power level of the signal generator when equivalence is achieved in step b).
 11. Repeat step 8 through step 10 with the measurement antenna oriented in the opposite polarization.
 12. Calculate the emission power in dBm referenced to a half-wave dipole using the following equation:
$$P_e = P_s(\text{dBm}) - \text{cable loss (dB)} + \text{antenna gain (dBd)}$$
where
 P_e = equivalent emission power in dBm
 P_s = source (signal generator) power in dBm
NOTE—dBd refers to the measured antenna gain in decibels relative to a half-wave dipole.
 13. Correct the antenna gain of the substitution antenna if necessary to reference the emission power to a half-wave dipole. When using measurement antennas with the gain specified in dBi, the equivalent dipole-referenced gain can be determined from:
$$\text{gain (dBd)} = \text{gain (dBi)} - 2.15 \text{ dB.}$$
If necessary, the antenna gain can be calculated from calibrated antenna factor information
 14. Provide the complete measurement results as a part of the test report.

TEST MODE:

Please refer to the clause 3.3

TEST RESULTS

Passed **Not Applicable**

Note: Worst case at WCDMA Band II/ WCDMA Band V

WCDMA Band II					
Channel	Frequency (MHz)	Spurious Emission		Limit (dBm)	Result
		Polarization	Level (dBm)		
9262	38.7300	Vertical	-67.06	<-13.00	Pass
	89.8975	V	-68.01		
	173.4388	V	-70.63		
	1374.7500	V	-48.82		
	2746.5000	V	-44.62		
	7248.5625	V	-49.26		
	38.3663	Horizontal	-67.83	<-13.00	Pass
	171.9838	H	-72.34		
	364.0438	H	-67.35		
	1764.2500	H	-44.76		
	3705.6563	H	-49.05		
	7308.2813	H	-47.62		
9400	38.3663	Vertical	-67.08	<-13.00	Pass
	174.0450	V	-71.31		
	364.0438	V	-72.93		
	1375.2500	V	-48.78		
	3762.9375	V	-55.39		
	7399.6875	V	-47.79		
	39.5788	Horizontal	-68.07	<-13.00	Pass
	173.4388	H	-70.37		
	364.0438	H	-67.62		
	1367.0000	H	-51.43		
	3760.5000	H	-51.61		
	7377.7500	H	-47.24		
9538	39.3363	Vertical	-65.69	<-13.00	Pass
	158.8888	V	-70.93		
	364.0438	V	-72.16		
	1500.0000	V	-48.96		
	3816.5625	V	-53.49		
	6840.2813	V	-49.57		
	39.5788	Horizontal	-67.33	<-13.00	Pass
	173.3175	H	-70.96		
	364.0438	H	-67.45		
	1731.5000	H	-41.48		
	3812.9063	H	-45.64		
	7126.6875	H	-48.14		

Remark:

1. The emission behaviour belongs to narrowband spurious emission.
2. The emission levels of not record in the report are very lower than the limit and not show in test report.

WCDMA Band V					
Channel	Frequency (MHz)	Spurious Emission		Limit (dBm)	Result
		Polarization	Level (dBm)		
4132	61.8888	Vertical	-49.23	<-13.00	Pass
	90.7463	V	-39.39		
	364.0438	V	-70.72		
	1249.7500	V	-50.40		
	1905.5000	V	-39.12		
	7499.6250	V	-45.71		
	90.9888	Horizontal	-36.11	<-13.00	Pass
	248.8563	H	-70.70		
	1651.7500	H	-45.46		
	2491.5000	H	-44.60		
	3301.0313	H	-56.90		
	6250.4063	H	-52.41		
4183	91.4738	Vertical	-29.81	<-13.00	Pass
	363.9225	V	-69.51		
	1670.7500	V	-46.33		
	2165.5000	V	-43.38		
	4224.8438	V	-58.34		
	6132.1875	V	-53.19		
	91.3525	Horizontal	-37.44	<-13.00	Pass
	364.0438	H	-69.21		
	1674.2500	H	-45.40		
	1908.0000	H	-42.71		
	3349.7813	H	-56.21		
	5024.3438	H	-49.07		
4233	91.4738	Vertical	-29.48	<-13.00	Pass
	180.2288	V	-73.91		
	1695.2500	V	-42.71		
	2764.2500	V	-42.81		
	4516.1250	V	-58.12		
	6651.3750	V	-49.35		
	83.5925	Horizontal	-48.69	<-13.00	Pass
	160.7075	H	-68.68		
	1691.7500	H	-43.66		
	2474.5000	H	-44.79		
	5085.2813	H	-53.57		
	9888.3750	H	-45.63		

Remark:

1. The emission behaviour belongs to narrowband spurious emission.
2. The emission levels of not record in the report are very lower than the limit and not show in test report.

6. TEST SETUP PHOTOS OF THE EUT

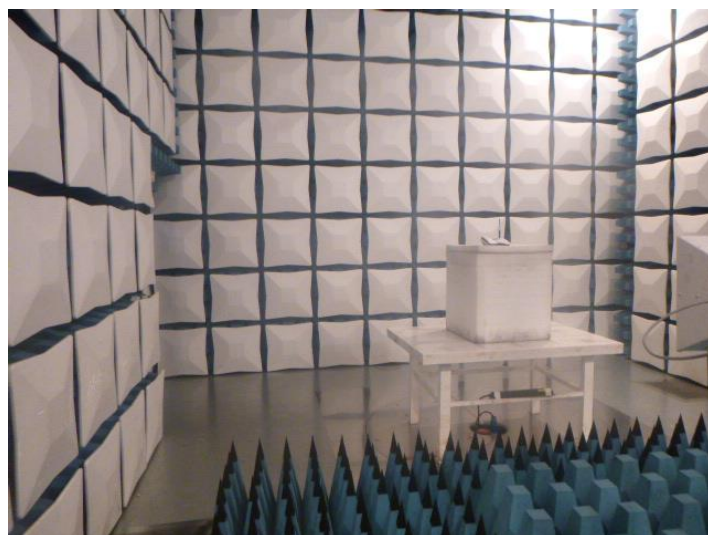
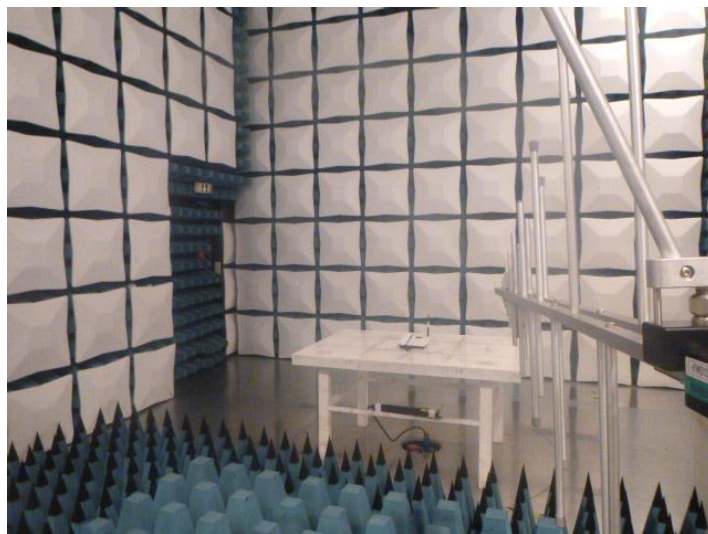

7. EXTERNAL AND INTERNAL PHOTOS OF THE EUT

Refere to the test report No.: CHTEW19080055

8. APPENDIX REPORT