



# RADIO TEST REPORT

Report No: STS1906218W02

Issued for

ITALCOM GROUP

1728Coral Way, Coral Gables, Miami, Florida, United States  
33145(Zip code : 518048)

|                       |                   |
|-----------------------|-------------------|
| <b>Product Name:</b>  | 4G LTE            |
| <b>Brand Name:</b>    | NYX               |
| <b>Model Name:</b>    | ARGON             |
| <b>Series Model:</b>  | N/A               |
| <b>FCC ID:</b>        | YPVITALCOMARGON   |
| <b>Test Standard:</b> | 47 CFR Part 2, 27 |



Any reproduction of this document must be done in full. No single part of this document may be reproduced without permission from STS, All Test Data Presented in this report is only applicable to presented Test sample.





TEST RESULT CERTIFICATION

**Applicant's Name**.....: ITALCOM GROUP  
 Address.....: 1728Coral Way, Coral Gables, Miami, Florida, United States  
 33145(Zip code : 518048)  
**Manufacture's Name** .....: Shenzhen Tianruixiang Communication Equipment LIMITED  
 Address.....: Rm810, Block E, Taojindi Building, Tenglong Road, Longhua  
 District, Shenzhen, China  
**Product description**  
 Product Name .....: 4G LTE  
 Brand Name .....: NYX  
 Model Name.....: ARGON  
 Series Model .....: N/A  
**Test Standards**.....: 47 CFR Part 2, 27  
 Test Procedure.....: KDB 971168 D01 v03r01, ANSI C63.26 2015

This device described above has been tested by STS, the test results show that the equipment under test (EUT) is in compliance with the FCC requirements. And it is applicable only to the tested sample identified in the report.  
 This report shall not be reproduced except in full, without the written approval of STS, this document may be altered or revised by STS, personal only, and shall be noted in the revision of the document.

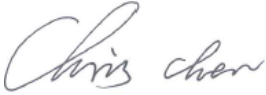
**Date of Test**.....:  
 Date (s) of performance of tests : 21 June 2019 ~ 27 June 2019  
 Date of Issue .....: 28 June 2019  
 Test Result .....: Pass

Testing Engineer :   
 \_\_\_\_\_  
 (Chris Chen)

Technical Manager :   
 \_\_\_\_\_  
 (Sunday Hu)

Authorized Signatory :   
 \_\_\_\_\_  
 (Vita Li)





| <b>Table of Contents</b>  | <b>Page</b> |
|---|-------------|
| <b>1. TEST FACTORY &amp; MEASUREMENT UNCERTAINTY</b>            | <b>5</b>    |
| <b>2. GENERAL INFORMATION</b>                                   | <b>6</b>    |
| <b>3. CONDUCTED OUTPUT POWER</b>                                | <b>14</b>   |
| <b>4. PEAK-TO-AVERAGE RATIO</b>                                 | <b>18</b>   |
| <b>5. RADIATED POWER AND EFFECTIVE ISOTROPIC RADIATED POWER</b> | <b>20</b>   |
| <b>6. OCCUPIED BANDWIDTH</b>                                    | <b>26</b>   |
| <b>7. CONDUCTED BAND EDGE</b>                                   | <b>28</b>   |
| <b>8. CONDUCTED SPURIOUS EMISSION</b>                           | <b>30</b>   |
| <b>9. RADIATED SPURIOUS EMISSION</b>                            | <b>31</b>   |
| <b>10. FREQUENCY STABILITY</b>                                  | <b>39</b>   |
| <b>APPENDIX-PHOTOS OF TEST SETUP</b>                            | <b>41</b>   |

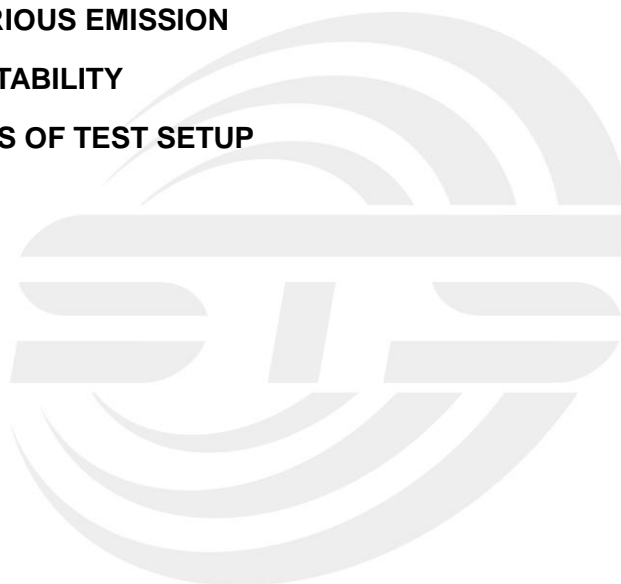



**Revision History**

| Rev. | Issue Date   | Report NO.    | Effect Page | Contents      |
|------|--------------|---------------|-------------|---------------|
| 00   | 28 June 2019 | STS1906218W02 | ALL         | Initial Issue |
|      |              |               |             |               |





## 1. TEST FACTORY & MEASUREMENT UNCERTAINTY

### 1.1 TEST FACTORY

Shenzhen STS Test Services Co., Ltd.

Add.: 1/F., Building B, Zhuoke Science Park, No.190, Chongqing Road,  
Fuyong Street, Bao'an District, Shenzhen, Guangdong, China

FCC test Firm Registration Number: 625569

A2LA Certificate No.: 4338.01

### 1.2 MEASUREMENT UNCERTAINTY

The reported uncertainty of measurement  $y \pm U$ , where expanded uncertainty  $U$  is based on a standard uncertainty multiplied by a coverage factor of  $k=2$ , providing a level of confidence of approximately 95 %.

| No. | Item                                | Uncertainty   |
|-----|-------------------------------------|---------------|
| 1   | RF output power, conducted          | $\pm 0.71$ dB |
| 2   | Unwanted Emissions, conducted       | $\pm 0.63$ dB |
| 3   | All emissions, radiated 30-200MHz   | $\pm 3.43$ dB |
| 4   | All emissions, radiated 200MHz-1GHz | $\pm 3.57$ dB |
| 5   | All emissions, radiated >1G         | $\pm 4.13$ dB |
| 6   | Conducted Emission (9KHz-150KHz)    | $\pm 3.18$ dB |
| 7   | Conducted Emission (150KHz-30MHz)   | $\pm 2.70$ dB |



## 2. GENERAL INFORMATION

### 2.1 TECHNICAL SPECIFICATIONS AND REGULATIONS

#### 2.1.1 PRODUCT DESCRIPTION

A major technical description of EUT is described as following:

|                          |  |
|--------------------------|--|
| Product Name:            | 4G LTE   |
| Trade Name               | NYX  |
| Model Name               | ARGON  |
| Series Model             | N/A  |
| Model Difference         | N/A  |
| Frequency Bands:         | U.S. Bands:<br><input type="checkbox"/> LTE FDD Band 2 <input checked="" type="checkbox"/> LTE FDD Band 4<br><input type="checkbox"/> LTE FDD Band 5: <input type="checkbox"/> LTE FDD Band 7:<br><input type="checkbox"/> LTE FDD Band 12: <input type="checkbox"/> LTE FDD Band 13:<br><input type="checkbox"/> LTE FDD Band 17: |
| SIM CARD:                | Only support single SIM Card.  |
| Antenna:                 | PIFA Antenna   |
| Antenna gain:            | LTE Band 4: -1dBi  |
| Battery parameter:       | Rated Voltage: 3.8V<br>Charge Limit: 4.35V<br>Capacity: 2700mA   |
| Adapter:                 | Input: AC100-240V, 0.2A,50/60Hz<br>Output: DC5V, 1000mA  |
| Extreme Vol. Limits:     | DC 3.5 V to 4.35 V (Nominal DC3.8V)  |
| Extreme Temp. Tolerance: | -30°C to +50°C   |
| Hardware version number: | NYX_ARGON_001  |
| Software version number: | ARGON_AMXNYX_V001R   |



2.1.2 PRODUCT SPECIFICATION SUBJECTIVE TO THIS STANDARD

| Product Specification Subjective To This Standard |   |
|---|---|
| Tx Frequency                                      | LTE Band 4:1710~1755MHz                                 |
| Rx Frequency                                      | LTE Band 4:2110~2155MHz                                 |
| Bandwidth   | LTE Band 4: 1.4MHz / 3MHz / 5MHz / 10MHz / 15MHz /20MHz |
| Maximum Output Power Limit                        | LTE Band 4: 22.05 dBm                                   |
| Type of Modulation                                | QPSK /16QAM   |





## 2.1.3 EMISSION DESIGNATOR

| LTE Band 4<br>BW(MHz) | Emission Designator<br>(26dBc)QPSK | Emission Designator<br>(26dBc)16QAM |
|-----------------------|------------------------------------|-------------------------------------|
| 1.4                   | 1M33G7D                            | 1M29W7D                             |
| 3                     | 3M00G7D                            | 3M03W7D                             |
| 5                     | 5M37G7D                            | 5M43W7D                             |
| 10                    | 9M89G7D                            | 10M1W7D                             |
| 15                    | 15M9G7D                            | 15M2W7D                             |
| 20                    | 20M0G7D                            | 20M0W7D                             |







2.1.4 TEST CONFIGURATION OF EQUIPMENT UNDER TEST

Antenna port conducted and radiated test items listed below are performed according to KDB 971168 D01 v03r01 and ANSI C63.26 2015 Power Meas. License Digital Systems with maximum output power. Radiated measurements are performed by rotating the EUT in three different orthogonal test planes to find the maximum emission.

Remark:

1. The mark 'v' means that this configuration is chosen for testing
2. The mark '-' means that this bandwidth is not supported.
3. The device is investigated from 30MHz to 10 times of fundamental signal for radiated

| ITEMS                       | Band | Bandwidth (MHz) |   |   |    |    |    | Modulation |       | RB # |      |      | Test Channel |   |   |
|-----------------------------|------|-----------------|---|---|----|----|----|------------|-------|------|------|------|--------------|---|---|
|                             |      | 1.4             | 3 | 5 | 10 | 15 | 20 | QPSK       | 16QAM | 1    | Half | Full | L            | M | H |
| Max. Output Power           | 4    | v               | v | v | v  | v  | v  | v          | v     | v    | v    | v    | v            | v | v |
| Peak&Avera Ratio            | 4    |                 |   |   |    |    | v  | v          | v     | v    |      | v    | v            | v |   |
| 26dB&99% Bandwidth          | 4    | v               | v | v | v  | v  | v  | v          | v     |      |      | v    | v            | v |   |
| Conducted Band Edge         | 4    | v               | v | v | v  | v  | v  | v          | v     | v    |      | v    | v            | v |   |
| Conducted Spurious Emission | 4    | v               | v | v | v  | v  | v  | v          | v     | v    |      |      | v            | v |   |
| Frequency Stability         | 4    |                 |   |   | v  |    |    | v          |       |      |      | v    |              | v |   |
| E.R.P.& E.I.R.P.            | 4    | v               | v | v | v  | v  | v  | v          | v     | v    |      |      | v            | v |   |
| Radiated Spurious Emission  | 4    | v               | v | v | v  | v  | v  | v          |       | v    |      |      | v            | v |   |



#### 2.1.5 RELATED SUBMITTAL(S) / GRANT (S)

This submittal(s) (test report) is intended for filing to comply with the 47 CFR Part 2, 24(E), 27

#### 2.1.6 SPECIAL ACCESSORIES

The battery and the charger, earphone supplied by the applicant were used as accessories and being tested with eut intended for fcc grant together.

#### 2.1.7 EUT CONFIGURATION

The EUT configuration for testing is installed on RF field strength measurement to meet the Commission's requirement and operating in a manner which intends to maximize its emission characteristics in a continuous normal application.

#### 2.1.8 EUT EXERCISE

The Transmitter was operated in the maximum output power mode through Communication Tester. The TX frequency was fixed which was for the purpose of the measurements.

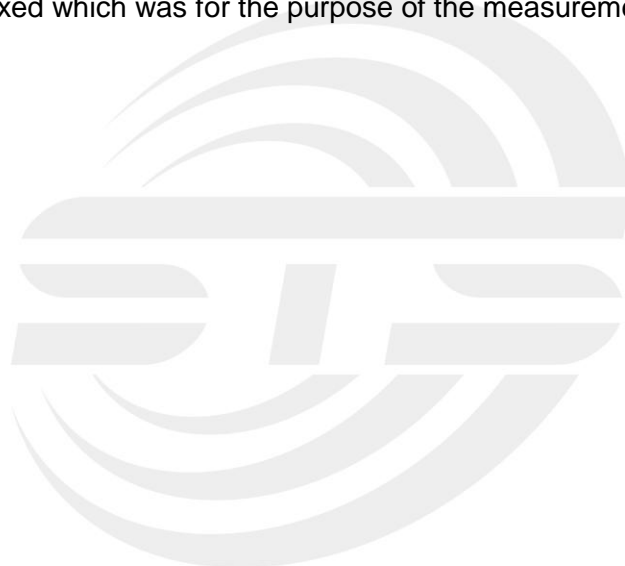



### 2.1.9 CONFIGURATION OF EUT SYSTEM

The EUT configuration for testing is installed on RF field strength measurement to meet the Commission's requirement and operating in a manner which intends to maximize its emission characteristics in a continuous normal application.

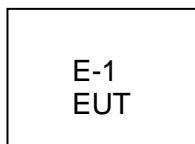

Table 2-1 Equipment Used in EUT System

| Item | Equipment | Model No. | Serial No. | Note |
|------|-----------|-----------|------------|------|
| N/A  | N/A       | N/A       | N/A        | N/A  |
|      |           |           |            |      |
|      |           |           |            |      |
|      |           |           |            |      |

Note:

- (1) The support equipment was authorized by Declaration of Confirmation.
- (2) For detachable type I/O cable should be specified the length in cm in 『Length』 column.



2.1.10 MEASUREMENT INSTRUMENTS

The radiated emission testing was performed according to the procedures of ANSI C63.26 2015 and FCC CFR 47 rules of 2.1046, 2.1047, 2.1049, 2.1051, 2.1053, 2.1055, 2.1057.

Radiation Test equipment

| Kind of Equipment                | Manufacturer | Type No.         | Serial No.   | Last calibration | Calibrated until |
|----------------------------------|--------------|------------------|--------------|------------------|------------------|
| Test Receiver                    | R&S          | ESCI             | 101427       | 2018.10.13       | 2019.10.12       |
| Signal Analyzer                  | Agilent      | N9020A           | MY51110105   | 2019.03.02       | 2020.03.01       |
| Wireless Communications Test Set | R&S          | CMW 500          | 133884       | 2019.03.02       | 2020.03.01       |
| Bilog Antenna                    | TESEQ        | CBL6111D         | 34678        | 2017.11.02       | 2020.11.1        |
| Horn Antenna                     | SCHWARZBECK  | BBHA 9120D(1201) | 9120D-1343   | 2018.10.19       | 2021.10.18       |
| SHF-EHF Horn Antenna (18G-40GHz) | A-INFO       | LB-180400-KF     | J211020657   | 2018.03.11       | 2021.03.10       |
| Pre-Amplifier(0.1M-3GHz)         | EM           | EM330            | 060665       | 2018.10.13       | 2019.10.12       |
| Pre-Amplifier (1G-18GHz)         | SKET         | LNPA-01018G-45   | SK2018080901 | 2018.10.13       | 2019.10.12       |
| turn table                       | EM           | SC100_1          | 60531        | N/A              | N/A              |
| Antenna mast                     | EM           | SC100            | N/A          | N/A              | N/A              |
| Temperature & Humidity           | HH660        | Mieo             | N/A          | 2018.10.11       | 2019.10.10       |
| Test SW                          | BULUN        | BL410-E/18.905   |              |                  |                  |

RF Connected Test

| Kind of Equipment                    | Manufacturer | Type No.        | Serial No. | Last calibration | Calibrated until |
|--------------------------------------|--------------|-----------------|------------|------------------|------------------|
| Universal Radio communication tester | R&S          | CMU200          | 11764      | 2018.10.13       | 2019.10.12       |
| Wireless Communications Test Set     | R&S          | CMW 500         | 133884     | 2019.03.02       | 2020.03.01       |
| Signal Analyzer                      | Agilent      | N9020A          | MY49100060 | 2018.10.13       | 2019.10.12       |
| Temperature & Humidity               | HH660        | Mieo            | N/A        | 2018.10.11       | 2019.10.10       |
| Test SW                              | FARAD        | LZ-RF /LzRf-3A3 |            |                  |                  |



### 2.1.11 MEASUREMENT RESULTS EXPLANATION EXAMPLE

For all conducted test items:

The offset level is set in the spectrum analyzer to compensate the RF cable loss and attenuator factor between EUT conducted output port and spectrum analyzer. With the offset compensation, the spectrum analyzer reading level is exactly the EUT RF output level.

The spectrum analyzer offset is derived from RF cable loss and attenuator factor.

*Offset = RF Cable Loss + Attenuator Factor.*



### 3. CONDUCTED OUTPUT POWER

#### 3.1 DESCRIPTION OF THE CONDUCTED OUTPUT POWER MEASUREMENT

##### 3.1.1 MEASUREMENT METHOD

A system simulator was used to establish communication with the eut. Its parameters were set to force the eut transmitting at maximum output power. The measured power in the radio frequency on the transmitter output terminals shall be reported. Configuration follows KDB 971168 D01 v03r01.

##### 3.1.2 TEST SETUP

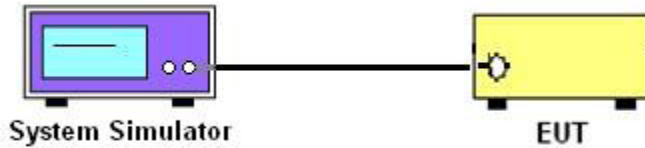

##### 3.1.3 TEST PROCEDURES

1. The transmitter output port was connected to system simulator.
2. Set EUT at maximum power through the system simulator.
3. Select lowest/middle/highest channels for each band and different modulation.
4. Measure and record the power level from the system simulator.



3.1.4 TEST RESULTS

| LTE Band 4 Maximum Average Power [dBm] |         |           |        |        |        |         |
|--|---------|-----------|--------|--------|--------|---------|
| BW [MHz]                               | RB Size | RB Offset | Mod    | Lowest | Middle | Highest |
| 1.4                                    | 1       | 0         | QPSK   | 21.76  | 21.81  | 21.85   |
| 1.4                                    | 1       | 2         |        | 21.51  | 21.53  | 21.56   |
| 1.4                                    | 1       | 5         |        | 21.24  | 21.3   | 21.28   |
| 1.4                                    | 3       | 0         |        | 20.98  | 21.08  | 21.01   |
| 1.4                                    | 3       | 1         |        | 20.72  | 20.82  | 20.77   |
| 1.4                                    | 3       | 2         |        | 20.5   | 20.6   | 20.48   |
| 1.4                                    | 6       | 0         |        | 20.26  | 20.32  | 20.26   |
| 1.4                                    | 1       | 0         | 16-QAM | 21.53  | 21.6   | 21.56   |
| 1.4                                    | 1       | 2         |        | 21.25  | 21.33  | 21.29   |
| 1.4                                    | 1       | 5         |        | 21.02  | 21.05  | 20.99   |
| 1.4                                    | 3       | 0         |        | 20.74  | 20.83  | 20.7    |
| 1.4                                    | 3       | 1         |        | 20.52  | 20.59  | 20.41   |
| 1.4                                    | 3       | 2         |        | 20.22  | 20.36  | 20.17   |
| 1.4                                    | 6       | 0         |        | 19.93  | 20.15  | 19.94   |
| 3                                      | 1       | 0         | QPSK   | 21.89  | 21.92  | 21.87   |
| 3                                      | 1       | 7         |        | 21.63  | 21.63  | 21.57   |
| 3                                      | 1       | 14        |        | 21.37  | 21.35  | 21.36   |
| 3                                      | 8       | 0         |        | 21.1   | 21.09  | 21.11   |
| 3                                      | 8       | 4         |        | 20.87  | 20.86  | 20.82   |
| 3                                      | 8       | 7         |        | 20.62  | 20.57  | 20.53   |
| 3                                      | 15      | 0         |        | 20.34  | 20.3   | 20.32   |
| 3                                      | 1       | 0         | 16-QAM | 21.63  | 21.66  | 21.64   |
| 3                                      | 1       | 7         |        | 21.34  | 21.41  | 21.42   |
| 3                                      | 1       | 14        |        | 21.13  | 21.19  | 21.22   |
| 3                                      | 8       | 0         |        | 20.86  | 20.9   | 20.93   |
| 3                                      | 8       | 4         |        | 20.6   | 20.68  | 20.68   |
| 3                                      | 8       | 7         |        | 20.39  | 20.42  | 20.45   |
| 3                                      | 15      | 0         |        | 20.16  | 20.2   | 20.19   |



| LTE Band 4 Maximum Average Power [dBm] |         |           |        |        |        |         |
|--|---------|-----------|--------|--------|--------|---------|
| BW [MHz]                               | RB Size | RB Offset | Mod    | Lowest | Middle | Highest |
| 5                                      | 1       | 0         | QPSK   | 21.95  | 21.9   | 21.79   |
| 5                                      | 1       | 12        |        | 21.74  | 21.69  | 21.58   |
| 5                                      | 1       | 24        |        | 21.54  | 21.48  | 21.38   |
| 5                                      | 12      | 0         |        | 21.3   | 21.19  | 21.1    |
| 5                                      | 12      | 6         |        | 21.06  | 20.93  | 20.84   |
| 5                                      | 12      | 11        |        | 20.8   | 20.72  | 20.56   |
| 5                                      | 25      | 0         |        | 20.54  | 20.5   | 20.35   |
| 5                                      | 1       | 0         | 16-QAM | 21.73  | 21.7   | 21.51   |
| 5                                      | 1       | 12        |        | 21.52  | 21.42  | 21.23   |
| 5                                      | 1       | 24        |        | 21.22  | 21.21  | 21.01   |
| 5                                      | 12      | 0         |        | 20.93  | 20.94  | 20.79   |
| 5                                      | 12      | 6         |        | 20.64  | 20.73  | 20.52   |
| 5                                      | 12      | 11        |        | 20.38  | 20.5   | 20.29   |
| 5                                      | 25      | 0         |        | 20.11  | 20.21  | 20      |
| 10                                     | 1       | 0         | QPSK   | 21.83  | 21.89  | 21.92   |
| 10                                     | 1       | 24        |        | 21.61  | 21.65  | 21.69   |
| 10                                     | 1       | 49        |        | 21.38  | 21.4   | 21.43   |
| 10                                     | 25      | 0         |        | 21.12  | 21.1   | 21.19   |
| 10                                     | 25      | 12        |        | 20.85  | 20.87  | 20.9    |
| 10                                     | 25      | 24        |        | 20.64  | 20.61  | 20.65   |
| 10                                     | 50      | 0         |        | 20.37  | 20.33  | 20.35   |
| 10                                     | 1       | 0         | 16-QAM | 21.58  | 21.65  | 21.63   |
| 10                                     | 1       | 24        |        | 21.31  | 21.44  | 21.43   |
| 10                                     | 1       | 49        |        | 21.11  | 21.15  | 21.2    |
| 10                                     | 25      | 0         |        | 20.81  | 20.93  | 21      |
| 10                                     | 25      | 12        |        | 20.55  | 20.73  | 20.72   |
| 10                                     | 25      | 24        |        | 20.28  | 20.44  | 20.51   |
| 10                                     | 50      | 0         |        | 20     | 20.23  | 20.29   |





| LTE Band 4 Maximum Average Power [dBm] |         |           |        |        |        |         |
|--|---------|-----------|--------|--------|--------|---------|
| BW [MHz]                               | RB Size | RB Offset | Mod    | Lowest | Middle | Highest |
| 15                                     | 1       | 0         | QPSK   | 21.86  | 21.94  | 21.91   |
| 15                                     | 1       | 37        |        | 21.6   | 21.66  | 21.66   |
| 15                                     | 1       | 74        |        | 21.37  | 21.38  | 21.44   |
| 15                                     | 36      | 0         |        | 21.13  | 21.1   | 21.17   |
| 15                                     | 36      | 18        |        | 20.84  | 20.87  | 20.88   |
| 15                                     | 36      | 39        |        | 20.56  | 20.58  | 20.63   |
| 15                                     | 75      | 0         |        | 20.28  | 20.34  | 20.42   |
| 15                                     | 1       | 0         | 16-QAM | 21.64  | 21.66  | 21.64   |
| 15                                     | 1       | 38        |        | 21.41  | 21.4   | 21.41   |
| 15                                     | 1       | 75        |        | 21.2   | 21.15  | 21.15   |
| 15                                     | 36      | 0         |        | 20.97  | 20.91  | 20.85   |
| 15                                     | 36      | 18        |        | 20.7   | 20.69  | 20.64   |
| 15                                     | 36      | 39        |        | 20.49  | 20.46  | 20.38   |
| 15                                     | 75      | 0         |        | 20.25  | 20.24  | 20.13   |
| 20                                     | 1       | 0         | QPSK   | 22.03  | 21.97  | 22.05   |
| 20                                     | 1       | 49        |        | 21.8   | 21.71  | 21.84   |
| 20                                     | 1       | 99        |        | 21.57  | 21.45  | 21.6    |
| 20                                     | 50      | 0         |        | 21.3   | 21.2   | 21.39   |
| 20                                     | 50      | 24        |        | 21.02  | 20.93  | 21.15   |
| 20                                     | 50      | 49        |        | 20.81  | 20.65  | 20.86   |
| 20                                     | 100     | 0         |        | 20.57  | 20.39  | 20.61   |
| 20                                     | 1       | 0         | 16-QAM | 21.82  | 21.72  | 21.77   |
| 20                                     | 1       | 49        |        | 21.54  | 21.43  | 21.55   |
| 20                                     | 1       | 99        |        | 21.32  | 21.19  | 21.31   |
| 20                                     | 50      | 0         |        | 21.06  | 20.92  | 21.04   |
| 20                                     | 50      | 24        |        | 20.79  | 20.72  | 20.83   |
| 20                                     | 50      | 49        |        | 20.53  | 20.43  | 20.55   |
| 20                                     | 100     | 0         |        | 20.31  | 20.2   | 20.34   |

#### 4. PEAK-TO-AVERAGE RATIO

##### 4.1 DESCRIPTION OF THE CONDUCTED OUTPUT POWER MEASUREMENT

###### 4.1.1 MEASUREMENT METHOD

Use one of the procedures presented in 4.1 to measure the total peak power and record as PPk. Use one of the applicable procedures presented 4.2 to measure the total average power and record as PAVg. Both the peak and average power levels must be expressed in the same logarithmic units (e.g., dBm). Determine the PAPR from:  
 $PAPR (dB) = PPk (dBm) - PAVg (dBm)$ .

###### 4.1.2 TEST SETUP

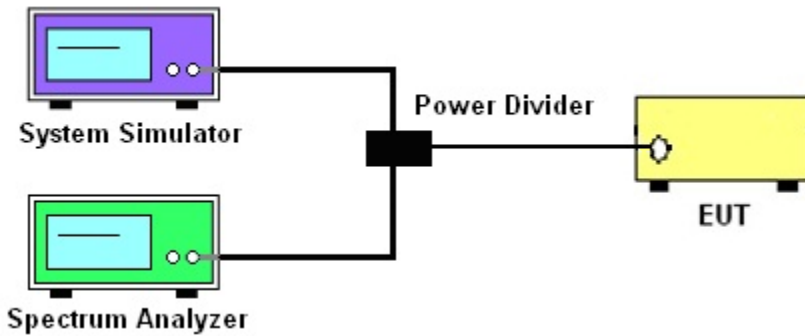

###### 4.1.3 TEST PROCEDURES

1. The testing follows FCC KDB 971168 D01 v03r01 Section 5.7.2 and ANSI C63.26 2015 Section 5.2.3.4
2. The EUT was connected to spectrum and system simulator via a power divider
3. Select lowest, middle, and highest channels for each band and different modulation.
4. Set the test probe and measure the peak and average power of the spectrum analyzer
5. Record the deviation as Peak to Average Ratio.

|             | LTE    |        |        |        |         |         |
|-------------|--------|--------|--------|--------|---------|---------|
| LTE BW      | 1.4M   | 3M     | 5M     | 10M    | 15M     | 20M     |
| Span        | 3MHz   | 6MHz   | 10MHz  | 20MHz  | 30MHz   | 40MHz   |
| RBW         | 30kHz  | 30kHz  | 100kHz | 100kHz | 300kHz  | 300kHz  |
| VBW         | 100kHz | 100kHz | 300kHz | 300kHz | 1000kHz | 1000kHz |
| Detector    | PK/AVG | PK/AVG | PK/AVG | PK/AVG | PK/AVG  | PK/AVG  |
| Trace       | Max    | Max    | Max    | Max    | Max     | Max     |
| Sweep Count | Auto   | Auto   | Auto   | Auto   | Auto    | Auto    |



## 4.1.4 TEST RESULTS

| LTE Band 4 PAR [dBm] |         |            |        |        |         |
|----------------------|---------|------------|--------|--------|---------|
| BW [MHz]             | RB Size | Modulation | Lowest | Middle | Highest |
| N/A                  | N/A     | N/A        | P-A    | P-A    | P-A     |
| 20                   | 1       | QPSK       | 4.64   | 4.35   | 4.74    |
| 20                   | 100     | N/A        | 5.22   | 5.21   | 5.24    |
| 20                   | 1       | 16-QAM     | 5.11   | 5.35   | 5.49    |
| 20                   | 100     | N/A        | 5.97   | 5.98   | 6.08    |
| Limit                |         |            | ≤13dBm |        |         |

Note: Test chart See Appendix D



## 5. RADIATED POWER AND EFFECTIVE ISOTROPIC RADIATED POWER

### 5.1 DESCRIPTION OF THE ERP/EIRP MEASUREMENT

#### 5.1.1 MEASUREMENT METHOD

Effective radiated power output measurements by substitution method according to ANSI C63.26 2015, and the spectrum analyzer configuration follows KDB 971168 D01 Power Meas. License Digital Systems. Mobile and portable (hand-held) stations operating are limited to average ERP, Equivalent isotropic radiated power output measurements by substitution method according to ANSI C63.26 2015, and the spectrum analyzer configuration follows KDB 971168 D01 Power Meas, Mobile and portable (hand-held) stations operating are limited to average EIRP.

#### 5.1.2 TEST SETUP

The procedure of radiated spurious emissions is as follows:

a) Pre-calibration With pre-calibration method, the Radiated Spurious Emissions(RSE) is calculated as,  $RSE = R_x (dBuV) + CL (dB) + SA (dB) + Gain (dBi) - 107 (dBuV \text{ to } dBm)$  The SA is calibrated using following setup.

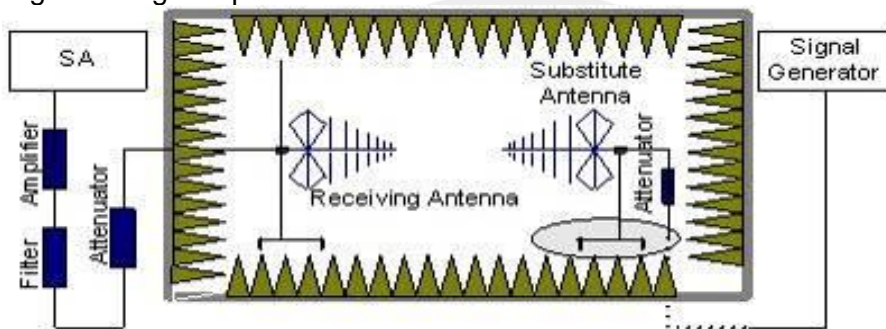

b) EUT was placed on a 1.5m non-conductive stand at a 3 m test distance from the receive antenna. A receiving antenna was placed on the antenna mast 3 m from the test item for emission measurements. The height of receiving antenna is 0.8m. The test setup refers to figure below. Detected emissions were maximized at each frequency by rotating the test item and adjusting the receiving antenna polarization. The radiated emission measurements of all non-harmonic and harmonics of the transmit frequency through the 10th harmonic measured with peak detector and 1MHz bandwidth.

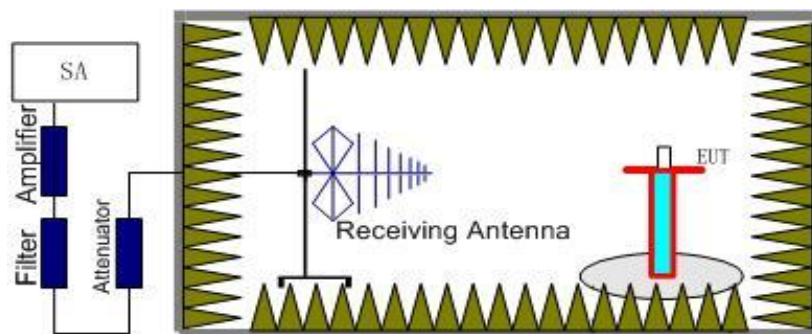

Radiated emissions measurements were made only at the upper, middle, and lower carrier frequencies It was decided that measurements at these three carrier frequencies would be sufficient to demonstrate compliance with emissions limits because it was seen that all the significant spurs occur well outside the band and no radiation was seen from a carrier in one block of any band into any of the other blocks.

The substitution method is used. Substitution values at each frequency are measured before and saved to the test software. A "reference path loss" is established and the ARpl is the attenuation of "reference path loss", and including the gain of receive antenna, the gain of the preamplifier, the cable loss and the air loss. The measurement results are obtained as described below:

Power=PMea+ARpl



### 5.1.3 TEST PROCEDURES

1. The testing follows FCC KDB 971168 D01v03r01 Section 5.6 and ANSI C63.26 2015 Section 5.2.
2. The EUT was placed on a non-conductive rotating platform 1.5 meters high in a semi-anechoic chamber. The radiated emission at the fundamental frequency was measured at 3 m with a test antenna and a spectrum analyzer with Peak detector.
3. During the measurement, the system simulator parameters were set to force the EUT transmitting at maximum output power. The maximum emission was recorded from analyzer power level (LVL) from the 360 degrees rotation of the turntable and the test antenna raised and lowered over a range from 1 to 4 m in both horizontally and vertically polarized orientations.
4. Effective Isotropic Radiated Power (EIRP) was measured by substitution method according to ANSI C63.26 2015. The EUT was replaced by dipole antenna (substitution antenna) at same location and then a known power from S.G. was applied into the dipole antenna through a Tx cable, and then recorded the maximum Analyzer reading through raised and lowered the test antenna. The correction factor (in dB) = S.G. - Tx Cable loss + Substitution antenna gain - Analyzer reading. Then the EUT's EIRP was calculated with the correction factor,  $EIRP/ERP = LVL + \text{Correction factor}$
5. RB Set greater than bandwidth, VB Set spectrum analyzer Maximum support.





5.1.4 TEST RESULTS

Note: Test is divided into three directions, X/Y/Z. X pattern for the worst.

| Radiated Power (EIRP) for LTE Band 4 / 1.4M |               |        |         |                 |            |            |                  |                          |            |
|---|---------------|--------|---------|-----------------|------------|------------|------------------|--------------------------|------------|
| Modulation                                  | RB            |        | Channel | Result          |            |            |                  |                          | Conclusion |
|   | Size          | Offset |         | S G.Level (dBm) | Cable loss | Gain (dBi) | PMeas E.R.P(dBm) | Polarization Of Max. ERP |            |
| QPSK  | 1             | 0      | Lowest  | 11.38           | 2.35       | 10.13      | 19.16            | Horizontal               | Pass       |
|   | 1             | 0      | Middle  | 11.21           | 2.36       | 10.16      | 19.01            | Horizontal               | Pass       |
|   | 1             | 0      | Highest | 11.29           | 2.37       | 10.22      | 19.14            | Horizontal               | Pass       |
|   | 1             | 0      | Lowest  | 12.75           | 2.35       | 10.13      | 20.53            | Vertical                 | Pass       |
|   | 1             | 0      | Middle  | 12.61           | 2.36       | 10.16      | 20.41            | Vertical                 | Pass       |
|   | 1             | 0      | Highest | 12.68           | 2.37       | 10.22      | 20.53            | Vertical                 | Pass       |
| 16QAM                                       | 1             | 0      | Lowest  | 11.02           | 2.35       | 10.13      | 18.80            | Horizontal               | Pass       |
|   | 1             | 0      | Middle  | 11.2            | 2.36       | 10.16      | 19.00            | Horizontal               | Pass       |
|   | 1             | 0      | Highest | 11.09           | 2.37       | 10.22      | 18.94            | Horizontal               | Pass       |
|   | 1             | 0      | Lowest  | 12.39           | 2.35       | 10.13      | 20.17            | Vertical                 | Pass       |
|   | 1             | 0      | Middle  | 12.55           | 2.36       | 10.16      | 20.35            | Vertical                 | Pass       |
|   | 1             | 0      | Highest | 12.49           | 2.37       | 10.22      | 20.34            | Vertical                 | Pass       |
| Limit                                       | EIRP<1W=30dBm |        |         |                 |            |            |                  |                          |            |



| Radiated Power (EIRP) for LTE Band 4 / 3M |               |        |         |                       |               |               |                     |                                |            |
|---|---------------|--------|---------|-----------------------|---------------|---------------|---------------------|--------------------------------|------------|
| Modulation                                | RB            |        | Channel | Result                |               |               |                     |                                | Conclusion |
|   | Size          | Offset |         | S<br>G.Level<br>(dBm) | Cable<br>loss | Gain<br>(dBi) | PMeas<br>E.R.P(dBm) | Polarization<br>Of Max.<br>ERP |            |
| QPSK                                      | 1             | 0      | Lowest  | 11.43                 | 2.35          | 10.13         | 19.21               | Horizontal                     | Pass       |
|   | 1             | 0      | Middle  | 11.41                 | 2.36          | 10.16         | 19.21               | Horizontal                     | Pass       |
|   | 1             | 0      | Highest | 11.33                 | 2.37          | 10.22         | 19.18               | Horizontal                     | Pass       |
|   | 1             | 0      | Lowest  | 12.76                 | 2.35          | 10.13         | 20.54               | Vertical                       | Pass       |
|   | 1             | 0      | Middle  | 12.75                 | 2.36          | 10.16         | 20.55               | Vertical                       | Pass       |
|   | 1             | 0      | Highest | 12.73                 | 2.37          | 10.22         | 20.58               | Vertical                       | Pass       |
| 16QAM                                     | 1             | 0      | Lowest  | 11.17                 | 2.35          | 10.13         | 18.95               | Horizontal                     | Pass       |
|   | 1             | 0      | Middle  | 11.24                 | 2.36          | 10.16         | 19.04               | Horizontal                     | Pass       |
|   | 1             | 0      | Highest | 11.23                 | 2.37          | 10.22         | 19.08               | Horizontal                     | Pass       |
|   | 1             | 0      | Lowest  | 12.62                 | 2.35          | 10.13         | 20.40               | Vertical                       | Pass       |
|   | 1             | 0      | Middle  | 12.65                 | 2.36          | 10.16         | 20.45               | Vertical                       | Pass       |
|   | 1             | 0      | Highest | 12.54                 | 2.37          | 10.22         | 20.39               | Vertical                       | Pass       |
| Limit                                     | EIRP<1W=30dBm |        |         |                       |               |               |                     |                                |            |

| Radiated Power (EIRP) for LTE Band 4 / 5M |               |        |         |                       |               |               |                     |                                |            |
|---|---------------|--------|---------|-----------------------|---------------|---------------|---------------------|--------------------------------|------------|
| Modulation                                | RB            |        | Channel | Result                |               |               |                     |                                | Conclusion |
|   | Size          | Offset |         | S<br>G.Level<br>(dBm) | Cable<br>loss | Gain<br>(dBi) | PMeas<br>E.R.P(dBm) | Polarization<br>Of Max.<br>ERP |            |
| QPSK                                      | 1             | 0      | Lowest  | 11.57                 | 2.35          | 10.13         | 19.35               | Horizontal                     | Pass       |
|   | 1             | 0      | Middle  | 11.32                 | 2.36          | 10.16         | 19.12               | Horizontal                     | Pass       |
|   | 1             | 0      | Highest | 11.22                 | 2.37          | 10.22         | 19.07               | Horizontal                     | Pass       |
|   | 1             | 0      | Lowest  | 12.88                 | 2.35          | 10.13         | 20.66               | Vertical                       | Pass       |
|   | 1             | 0      | Middle  | 12.74                 | 2.36          | 10.16         | 20.54               | Vertical                       | Pass       |
|   | 1             | 0      | Highest | 12.68                 | 2.37          | 10.22         | 20.53               | Vertical                       | Pass       |
| 16QAM                                     | 1             | 0      | Lowest  | 11.11                 | 2.35          | 10.13         | 18.89               | Horizontal                     | Pass       |
|   | 1             | 0      | Middle  | 11.26                 | 2.36          | 10.16         | 19.06               | Horizontal                     | Pass       |
|   | 1             | 0      | Highest | 10.98                 | 2.37          | 10.22         | 18.83               | Horizontal                     | Pass       |
|   | 1             | 0      | Lowest  | 12.59                 | 2.35          | 10.13         | 20.37               | Vertical                       | Pass       |
|   | 1             | 0      | Middle  | 12.7                  | 2.36          | 10.16         | 20.50               | Vertical                       | Pass       |
|   | 1             | 0      | Highest | 12.34                 | 2.37          | 10.22         | 20.19               | Vertical                       | Pass       |
| Limit                                     | EIRP<1W=30dBm |        |         |                       |               |               |                     |                                |            |



| Radiated Power (EIRP) for LTE Band 4 / 10M |               |        |         |                       |               |               |                     |                                |            |
|--|---------------|--------|---------|-----------------------|---------------|---------------|---------------------|--------------------------------|------------|
| Modulation                                 | RB            |        | Channel | Result                |               |               |                     |                                | Conclusion |
|  | Size          | Offset |         | S<br>G.Level<br>(dBm) | Cable<br>loss | Gain<br>(dBi) | PMeas<br>E.R.P(dBm) | Polarization<br>Of Max.<br>ERP |            |
| QPSK                                       | 1             | 0      | Lowest  | 11.34                 | 2.35          | 10.13         | 19.12               | Horizontal                     | Pass       |
|  | 1             | 0      | Middle  | 11.31                 | 2.36          | 10.16         | 19.11               | Horizontal                     | Pass       |
|  | 1             | 0      | Highest | 11.45                 | 2.37          | 10.22         | 19.30               | Horizontal                     | Pass       |
|  | 1             | 0      | Lowest  | 12.71                 | 2.35          | 10.13         | 20.49               | Vertical                       | Pass       |
|  | 1             | 0      | Middle  | 12.71                 | 2.36          | 10.16         | 20.51               | Vertical                       | Pass       |
|  | 1             | 0      | Highest | 12.85                 | 2.37          | 10.22         | 20.70               | Vertical                       | Pass       |
| 16QAM                                      | 1             | 0      | Lowest  | 11.07                 | 2.35          | 10.13         | 18.85               | Horizontal                     | Pass       |
|  | 1             | 0      | Middle  | 11.25                 | 2.36          | 10.16         | 19.05               | Horizontal                     | Pass       |
|  | 1             | 0      | Highest | 11.11                 | 2.37          | 10.22         | 18.96               | Horizontal                     | Pass       |
|  | 1             | 0      | Lowest  | 12.44                 | 2.35          | 10.13         | 20.22               | Vertical                       | Pass       |
|  | 1             | 0      | Middle  | 12.6                  | 2.36          | 10.16         | 20.40               | Vertical                       | Pass       |
|  | 1             | 0      | Highest | 12.45                 | 2.37          | 10.22         | 20.30               | Vertical                       | Pass       |
| Limit                                      | EIRP<1W=30dBm |        |         |                       |               |               |                     |                                |            |

| Radiated Power (EIRP) for LTE Band 4 / 15M |               |        |         |                       |               |               |                     |                                |            |
|--|---------------|--------|---------|-----------------------|---------------|---------------|---------------------|--------------------------------|------------|
| Modulation                                 | RB            |        | Channel | Result                |               |               |                     |                                | Conclusion |
|  | Size          | Offset |         | S<br>G.Level<br>(dBm) | Cable<br>loss | Gain<br>(dBi) | PMeas<br>E.R.P(dBm) | Polarization<br>Of Max.<br>ERP |            |
| QPSK                                       | 1             | 0      | Lowest  | 11.38                 | 2.35          | 10.13         | 19.16               | Horizontal                     | Pass       |
|  | 1             | 0      | Middle  | 11.46                 | 2.36          | 10.16         | 19.26               | Horizontal                     | Pass       |
|  | 1             | 0      | Highest | 11.22                 | 2.37          | 10.22         | 19.07               | Horizontal                     | Pass       |
|  | 1             | 0      | Lowest  | 12.74                 | 2.35          | 10.13         | 20.52               | Vertical                       | Pass       |
|  | 1             | 0      | Middle  | 12.9                  | 2.36          | 10.16         | 20.70               | Vertical                       | Pass       |
|  | 1             | 0      | Highest | 12.71                 | 2.37          | 10.22         | 20.56               | Vertical                       | Pass       |
| 16QAM                                      | 1             | 0      | Lowest  | 11.14                 | 2.35          | 10.13         | 18.92               | Horizontal                     | Pass       |
|  | 1             | 0      | Middle  | 11.13                 | 2.36          | 10.16         | 18.93               | Horizontal                     | Pass       |
|  | 1             | 0      | Highest | 11.06                 | 2.37          | 10.22         | 18.91               | Horizontal                     | Pass       |
|  | 1             | 0      | Lowest  | 12.48                 | 2.35          | 10.13         | 20.26               | Vertical                       | Pass       |
|  | 1             | 0      | Middle  | 12.58                 | 2.36          | 10.16         | 20.38               | Vertical                       | Pass       |
|  | 1             | 0      | Highest | 12.5                  | 2.37          | 10.22         | 20.35               | Vertical                       | Pass       |
| Limit                                      | EIRP<1W=30dBm |        |         |                       |               |               |                     |                                |            |





| Radiated Power (EIRP) for LTE Band 4 / 20M |               |        |         |                       |               |               |                     |                                |            |
|--|---------------|--------|---------|-----------------------|---------------|---------------|---------------------|--------------------------------|------------|
| Modulation                                 | RB            |        | Channel | Result                |               |               |                     |                                | Conclusion |
|  | Size          | Offset |         | S<br>G.Level<br>(dBm) | Cable<br>loss | Gain<br>(dBi) | PMeas<br>E.R.P(dBm) | Polarization<br>Of Max.<br>ERP |            |
| QPSK                                       | 1             | 0      | Lowest  | 11.64                 | 2.35          | 10.13         | 19.42               | Horizontal                     | Pass       |
|  | 1             | 0      | Middle  | 11.57                 | 2.36          | 10.16         | 19.37               | Horizontal                     | Pass       |
|  | 1             | 0      | Highest | 11.42                 | 2.37          | 10.22         | 19.27               | Horizontal                     | Pass       |
|  | 1             | 0      | Lowest  | 13.03                 | 2.35          | 10.13         | 20.81               | Vertical                       | Pass       |
|  | 1             | 0      | Middle  | 12.88                 | 2.36          | 10.16         | 20.68               | Vertical                       | Pass       |
|  | 1             | 0      | Highest | 12.85                 | 2.37          | 10.22         | 20.70               | Vertical                       | Pass       |
| 16QAM                                      | 1             | 0      | Lowest  | 11.32                 | 2.35          | 10.13         | 19.10               | Horizontal                     | Pass       |
|  | 1             | 0      | Middle  | 11.2                  | 2.36          | 10.16         | 19.00               | Horizontal                     | Pass       |
|  | 1             | 0      | Highest | 11.2                  | 2.37          | 10.22         | 19.05               | Horizontal                     | Pass       |
|  | 1             | 0      | Lowest  | 12.7                  | 2.35          | 10.13         | 20.48               | Vertical                       | Pass       |
|  | 1             | 0      | Middle  | 12.62                 | 2.36          | 10.16         | 20.42               | Vertical                       | Pass       |
|  | 1             | 0      | Highest | 12.55                 | 2.37          | 10.22         | 20.40               | Vertical                       | Pass       |
| Limit                                      | EIRP<1W=30dBm |        |         |                       |               |               |                     |                                |            |



## 6. OCCUPIED BANDWIDTH

### 6.1 DESCRIPTION OF OCCUPIED BANDWIDTH MEASUREMENT

#### 6.1.1 MEASUREMENT METHOD

1.The occupied bandwidth is the width of a frequency band such that, below the lower and above the upper frequency limits, the mean powers emitted are each equal to a specified percentage 0.5% of the total mean transmitted power.

2.The 26 db emission bandwidth is defined as the frequency range between two points, one above and one below the carrier frequency, at which the spectral density of the emission is attenuated 26 db below the maximum in-band spectral density of the modulated signal. spectral density (power per unit bandwidth) is to be measured with a detector of resolution bandwidth equal to approximately 1.0% of the emission bandwidth.

#### 6.1.2 TEST SETUP

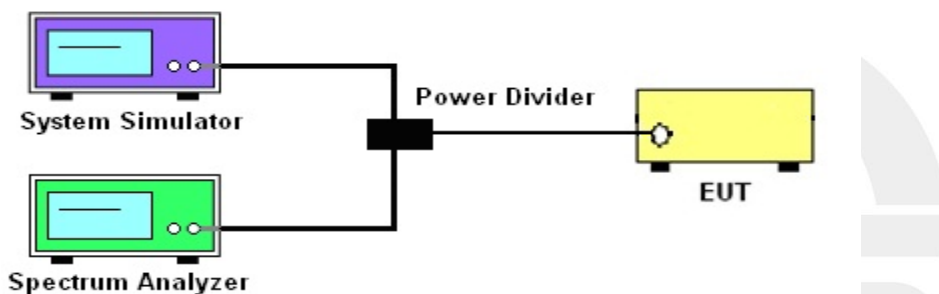

#### 6.1.3 TEST PROCEDURES

1. The testing follows FCC KDB 971168 D01 v03r01 Section 4.1.and 4.2
2. The EUT was connected to spectrum and system simulator via a power divider
3. Select lowest, middle, and highest channels for each band and different modulation.
4. Set the test probe and measure the Occupied Bandwidth of the spectrum analyzer
5. Measure and record the Occupied Bandwidth from the Spectrum Analyzer.

|             | LTE    |        |        |        |         |         |
|-------------|--------|--------|--------|--------|---------|---------|
| LTE BW      | 1.4M   | 3M     | 5M     | 10M    | 15M     | 20M     |
| Span        | 3MHz   | 6MHz   | 10MHz  | 20MHz  | 30MHz   | 40MHz   |
| RBW         | 30kHz  | 30kHz  | 100kHz | 100kHz | 300kHz  | 300kHz  |
| VBW         | 100kHz | 100kHz | 300kHz | 300kHz | 1000kHz | 1000kHz |
| Detector    | PK     | PK     | PK     | PK     | PK      | PK      |
| Trace       | Max    | Max    | Max    | Max    | Max     | Max     |
| Sweep Count | Auto   | Auto   | Auto   | Auto   | Auto    | Auto    |



## 6.1.4 MEASUREMENT RESULT

## LTE BAND 4

| LTE Band 4 Bandwidth [MHz] |        |         |        |         |        |         |        |
|----------------------------|--------|---------|--------|---------|--------|---------|--------|
| BW [MHz]                   | Mod    | Lowest  |        | Middle  |        | Highest |        |
|                            |        | 26dB BW | 99% BW | 26dB BW | 99% BW | 26dB BW | 99% BW |
| 1.4                        | QPSK   | 1.262   | 1.0981 | 1.327   | 1.0985 | 1.328   | 1.1045 |
| 1.4                        | 16-QAM | 1.285   | 1.0936 | 1.284   | 1.1014 | 1.273   | 1.1047 |
| 3                          | QPSK   | 2.999   | 2.6902 | 2.994   | 2.6865 | 2.983   | 2.6893 |
| 3                          | 16-QAM | 2.994   | 2.6853 | 3.028   | 2.6859 | 3.029   | 2.6888 |
| 5                          | QPSK   | 5.199   | 4.5180 | 5.372   | 4.5053 | 5.340   | 4.5397 |
| 5                          | 16-QAM | 5.315   | 4.5299 | 5.429   | 4.5466 | 5.410   | 4.5473 |
| 10                         | QPSK   | 9.787   | 8.9335 | 9.888   | 8.9426 | 9.725   | 8.9512 |
| 10                         | 16-QAM | 9.740   | 8.9342 | 9.853   | 8.9521 | 10.07   | 8.9523 |
| 15                         | QPSK   | 15.15   | 13.454 | 15.87   | 13.516 | 15.37   | 13.504 |
| 15                         | 16-QAM | 14.99   | 13.497 | 15.19   | 13.526 | 15.00   | 13.514 |
| 20                         | QPSK   | 19.56   | 17.904 | 19.95   | 17.973 | 19.73   | 17.971 |
| 20                         | 16-QAM | 19.86   | 17.975 | 19.68   | 17.949 | 19.99   | 17.982 |

Note: Test chart See Appendix A



## 7. CONDUCTED BAND EDGE

### 7.1 DESCRIPTION OF CONDUCTED BAND EDGE MEASUREMENT

#### 7.1.1 MEASUREMENT METHOD

##### 1. §22.917(a)

For operations in the 824 – 849 MHz band, the FCC limit is  $43 + 10\log_{10}(P[\text{Watts}])$  dB below the transmitter power  $P(\text{Watts})$  in a 100kHz bandwidth. However, in the 1MHz bands immediately outside and adjacent to the licensee's frequency block, a resolution bandwidth of at least one percent of the emission bandwidth of the fundamental emission of the transmitter may be employed.

##### 2. §24.238 (a)

For operations in the 1850-1910 and 1930-1990 MHz band, the FCC limit is  $43 + 10\log_{10}(P[\text{Watts}])$  dB below the transmitter power  $P(\text{Watts})$  in a 1MHz bandwidth. However, in the 1 MHz bands immediately outside and adjacent to the frequency block a resolution bandwidth of at least one percent of the emission bandwidth of the fundamental emission of the transmitter may be employed

##### 3. §27.53 (h)

For operations in the 1710 – 1755 MHz band, the FCC limit is  $43 + 10\log_{10}(P[\text{Watts}])$  dB below the transmitter power  $P(\text{Watts})$  in a 1 MHz bandwidth. However, in the 1MHz bands immediately outside and adjacent to the licensee's frequency block, a resolution bandwidth of at least one percent of the emission bandwidth of the fundamental emission of the transmitter may be employed.

##### 4. §27.53(m)(4)

For operations in the 2500 MHz ~ 2570 MHz band this section, the attenuation factor shall be not less than  $40 + 10 \log (P)$  dB on all frequencies between the channel edge and 5 megahertz from the channel edge,  $43 + 10 \log (P)$  dB on all frequencies between 5 megahertz and X megahertz from the channel edge, and  $55 + 10 \log (P)$  dB on all frequencies more than X megahertz from the channel edge, where X is the greater of 6 megahertz or the actual emission bandwidth as defined in paragraph (m)(6) of this section. In addition, the attenuation factor shall not be less that  $43 + 10 \log (P)$  dB on all frequencies between 2490.5 MHz and 2496 MHz and  $55 + 10 \log (P)$  dB at or below 2490.5 MHz. Mobile Satellite Service licensees operating on frequencies below 2495 MHz may also submit a documented interference complaint against BRS licensees operating on channel BRS Channel 1 on the same terms and conditions as adjacent channel BRS or EBS licensees.

##### 5. §27.53 (g)

For operations in the 698 -746 MHz band, the FCC limit is  $43 + 10\log_{10}(P[\text{Watts}])$  dB below the transmitter power  $P(\text{Watts})$  in a 100 kHz bandwidth. However, in the 100 kilohertz bands immediately outside and adjacent to a licensee's frequency block, a resolution bandwidth of at least 30 kHz may be employed.

### 7.1.2 TEST SETUP

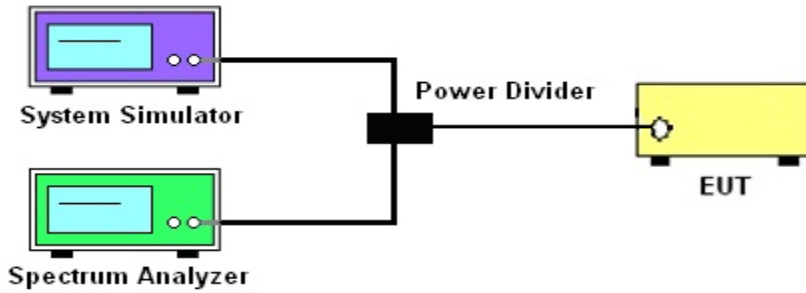

### 7.1.3 TEST PROCEDURES

1. The testing FCC KDB 971168 D01 v03r01 Section 6.0. and ANSI C63.26 2015 Section 5.7.
2. The EUT was connected to spectrum analyzer and system simulator via a power divider.
3. The band edges of low and high channels for the highest RF powers were measured. Set RBW  $\geq 1\%$  EBW in the 1MHz band immediately outside and adjacent to the band edge.
4. Set spectrum analyzer with RMS/AVG detector.
5. The RF fundamental frequency should be excluded against the limit line in the operating frequency band.
6. The limit line is derived from  $43 + 10\log(P)$  dB below the transmitter power P(Watts)  
 $= P(W) - [43 + 10\log(P)]$  (dB)  
 $= [30 + 10\log(P)]$  (dBm) -  $[43 + 10\log(P)]$  (dB)  
 $= -13$  dBm.

Band 7:  
 $= P(W) - [55 + 10\log(P)]$  (dB)  
 $= [30 + 10\log(P)]$  (dBm) -  $[55 + 10\log(P)]$  (dB)  
 $= -25$  dBm.

|             | LTE    |        |        |        |         |         |
|-------------|--------|--------|--------|--------|---------|---------|
| LTE BW      | 1.4M   | 3M     | 5M     | 10M    | 15M     | 20M     |
| Span        | 12MHz  | 13MHz  | 15MHz  | 20MHz  | 25MHz   | 30MHz   |
| RBW         | 30kHz  | 30kHz  | 100kHz | 100kHz | 300kHz  | 300kHz  |
| VBW         | 100kHz | 100kHz | 300kHz | 300kHz | 1000kHz | 1000kHz |
| Detector    | RMS    | RMS    | RMS    | RMS    | RMS     | RMS     |
| Trace       | Max    | Max    | Max    | Max    | Max     | Max     |
| Sweep Count | Auto   | Auto   | Auto   | Auto   | Auto    | Auto    |

### 7.1.4 MEASUREMENT RESULT

Note: Test chart See Appendix B

## 8. CONDUCTED SPURIOUS EMISSION

### 8.1 DESCRIPTION OF CONDUCTED SPURIOUS EMISSION MEASUREMENT

#### 8.1.1 MEASUREMENT METHOD

The power of any emission outside of the authorized operating frequency ranges must be lower than the transmitter power (P) by a factor of at least 43 + 10 log (P) dB.

For Band 7:

The power of any emission outside of the authorized operating frequency ranges must be lower than the transmitter power (P) by a factor of at least 55 + 10 log (P) dB.

It is measured by means of a calibrated spectrum analyzer and scanned from 30 MHz up to a frequency including its 10th harmonic.

#### 8.1.2 TEST SETUP

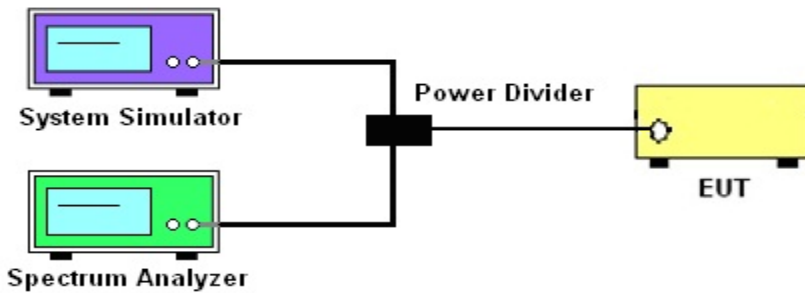

#### 8.1.3 TEST PROCEDURES

1. The testing FCC KDB 971168 D01 v03r01 Section 6.0. and ANSI C63.26 2015 Section 5.7.
2. The EUT was connected to spectrum analyzer and system simulator via a power divider.
3. The RF output of EUT was connected to the spectrum analyzer by RF cable and attenuator. The path loss was compensated to the results for each measurement
4. Make the measurement with the spectrum analyzer's RBW = 1MHz, VBW = 3MHz, taking the record of maximum spurious emission.
5. The RF fundamental frequency should be excluded against the limit line in the operating frequency band.
6. The limit line is derived from  $43 + 10\log(P)$  dB below the transmitter power P(Watts)  
 $= P(W) - [43 + 10\log(P)] \text{ (dB)} = [30 + 10\log(P)] \text{ (dBm)} - [43 + 10\log(P)] \text{ (dB)}$   
 $= -13\text{dBm}$ .  
 For Band 7:  $P(W) - [43 + 10\log(P)] \text{ (dB)} = -25\text{dBm}$

|          | LTE     |         |         |         |         |         |
|----------|---------|---------|---------|---------|---------|---------|
| LTE BW   | 1.4M    | 3M      | 5M      | 10M     | 15M     | 20M     |
| Span     | Auto    | Auto    | Auto    | Auto    | Auto    | Auto    |
| RBW      | 1000kHz | 1000kHz | 1000kHz | 1000kHz | 1000kHz | 1000kHz |
| VBW      | 3000kHz | 3000kHz | 3000kHz | 3000kHz | 3000kHz | 3000kHz |
| Detector | PK      | PK      | PK      | PK      | PK      | PK      |
| Trace    | Max     | Max     | Max     | Max     | Max     | Max     |

#### 8.1.4 TEST RESULTS

Note: Test chart See Appendix C

## 9. RADIATED SPURIOUS EMISSION

### 9.1 DESCRIPTION OF RADIATED SPURIOUS EMISSION

#### 9.1.1 MEASUREMENT METHOD

The radiated spurious emission was measured by substitution method according to ANSI C63.26 2015. The power of any emission outside of the authorized operating frequency ranges must be attenuated below the transmitter power (P) by a factor of at least  $43 + 10 \log (P)$  dB. For Band 7 The power of any emission outside of the authorized operating frequency ranges must be attenuated below the transmitter power (P) by a factor of at least  $55 + 10 \log (P)$  dB. The spectrum is scanned from 30 MHz up to a frequency including its 10th harmonic.

#### 9.1.2 TEST SETUP

The procedure of radiated spurious emissions is as follows:

a) Pre-calibration With pre-calibration method, the Radiated Spurious Emissions(RSE) is calculated as,  $RSE = Rx (dBuV) + CL (dB) + SA (dB) + Gain (dBi) - 107 (dBuV \text{ to } dBm)$  The SA is calibrated using following setup.

b) EUT was placed on 1.5 m non-conductive stand at a 3 m test distance from the receive antenna. A receiving antenna was placed on the antenna mast 3 m from the test item for emission measurements. The height of receiving antenna is 0.8m. The test setup refers to figure below. Detected emissions were maximized at each frequency by rotating the test item and adjusting the receiving antenna polarization. The radiated emission measurements of all non-harmonic and harmonics of the transmit frequency through the 10th harmonic measured with peak detector and 1MHz bandwidth.

Radiated emissions measurements were made only at the upper, middle, and lower carrier frequencies It was decided that measurements at these three carrier frequencies would be sufficient to demonstrate compliance with emissions limits because it was seen that all the significant spurs occur well outside the band and no radiation was seen from a carrier in one block of any band into any of the other blocks.

The substitution method is used. Substitution values at each frequency are measured before and saved to the test software. A "reference path loss" is established and the ARpl is the attenuation of "reference path loss", and including the gain of receive antenna, the gain of the preamplifier, the cable loss and the air loss. The measurement results are obtained as described below:

$$\text{Power} = \text{PMea} + \text{ARpl}$$

For radiated test from 30MHz to 1GHz

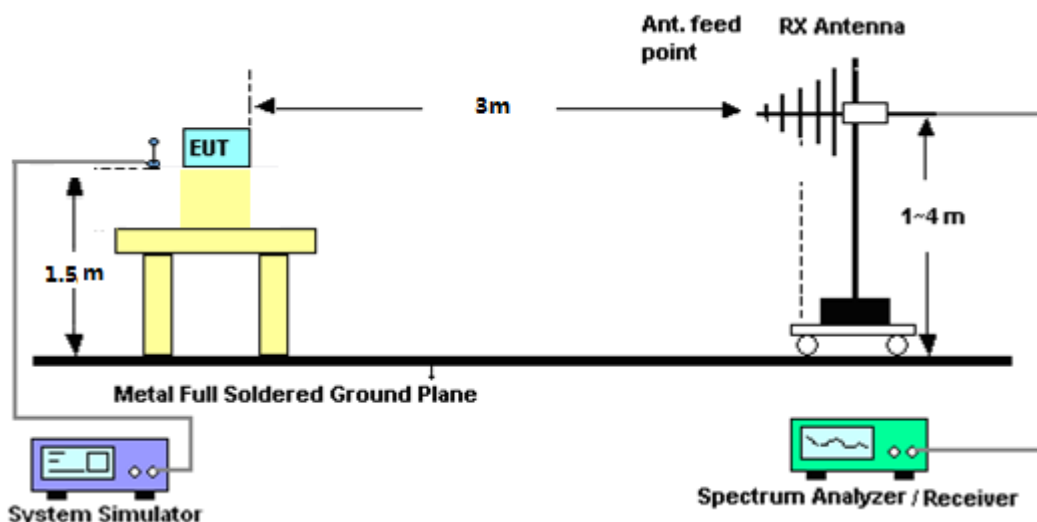

For radiated test from above 1GHz

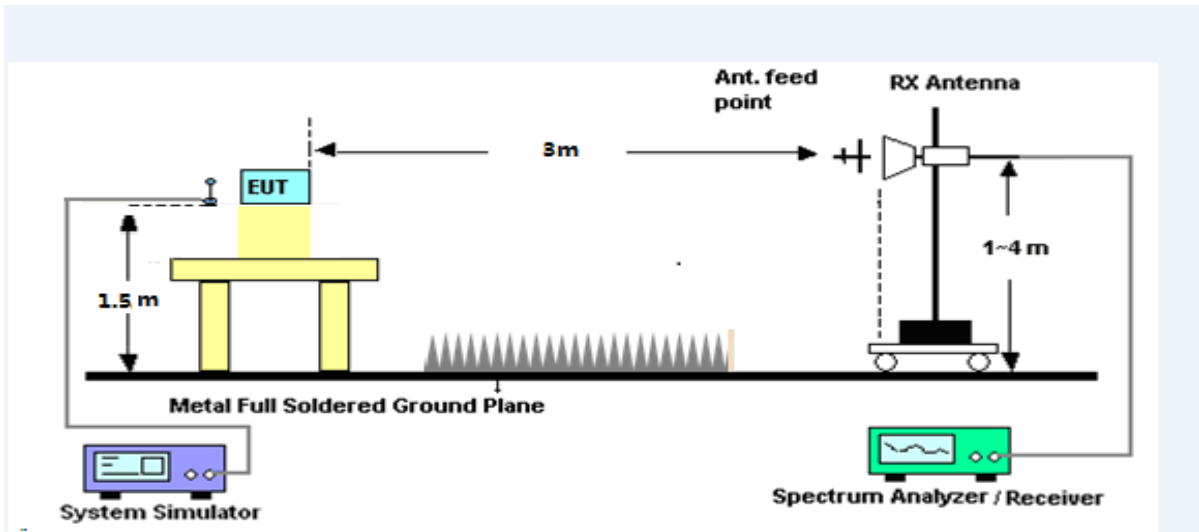

### 9.1.3 TEST PROCEDURES

1. The testing FCC KDB 971168 D01 Section 5.8 and ANSI C63.26 2015 Section 5.5.
2. The EUT was placed on a rotatable wooden table with 1.5 meter above ground.
3. The EUT was set 3 meters from the receiving antenna, which was mounted on the antenna tower.
4. The table was rotated 360 degrees to determine the position of the highest spurious emission.
5. The height of the receiving antenna is varied between one meter and four meters to search the maximum spurious emission for both horizontal and vertical polarizations
6. Make the measurement with the spectrum analyzer's RBW = 1MHz, VBW = 3MHz, taking the record of maximum spurious emission.
7. A horn antenna was substituted in place of the EUT and was driven by a signal generator.
8. Tune the output power of signal generator to the same emission level with EUT maximum spurious emission.
9. Taking the record of output power at antenna port.
10. Repeat step 7 to step 8 for another polarization.
11. The RF fundamental frequency should be excluded against the limit line in the operating frequency band.

The limit line is derived from  $43 + 10\log(P)$ dB below the transmitter power P(Watts)  
 $= P(W) - [43 + 10\log(P)]$  (dB)  
 $= [30 + 10\log(P)]$  (dBm) -  $[43 + 10\log(P)]$  (dB)  
 $= -13$ dBm

For Band 7:

The limit line is derived from  $55 + 10\log(P)$ dB below the transmitter power P(Watts)  
 $= [30 + 10\log(P)]$  (dBm) -  $[55 + 10\log(P)]$  (dB)  
 $= -25$ dBm

EIRP (dBm) = S.G. Power – Tx Cable Loss + Tx Antenna Gain

ERP (dBm) = EIRP - 2.15





9.1.4 TEST RESULTS

| LTE Band 4 / 1.4MHz / QPSK / RB Size 1 Offset 0/ The Worst Test Results for Lowest  |               |          |       |               |        |        |          |
|---|---------------|----------|-------|---------------|--------|--------|----------|
| Frequency(MHz)  | S G.Lev (dBm) | Ant(dBi) | Loss  | PMea          | Limit  | Margin | Polarity |
|   |               |          |       | (dBm)         | (dBm)  | (dBm)  |          |
| 3421.25   | -34.25        | 12.90    | 12.56 | -33.91        | -13.00 | -20.91 | H        |
| 5131.70   | -34.17        | 13.10    | 12.46 | <b>-33.53</b> | -13.00 | -20.53 | H        |
| 6842.65   | -32.65        | 12.33    | 21.13 | -41.45        | -13.00 | -28.45 | H        |
| 3421.25   | -35.49        | 12.90    | 12.76 | -35.35        | -13.00 | -22.35 | V        |
| 5131.70   | -35.10        | 13.10    | 16.32 | -38.32        | -13.00 | -25.32 | V        |
| 6842.65   | -31.76        | 12.33    | 21.13 | -40.56        | -13.00 | -27.56 | V        |
| LTE Band 4 / 1.4MHz / QPSK / RB Size 1 Offset 0/ The Worst Test Results for Middle  |               |          |       |               |        |        |          |
| Frequency(MHz)  | S G.Lev (dBm) | Ant(dBi) | Loss  | PMea          | Limit  | Margin | Polarity |
|   |               |          |       | (dBm)         | (dBm)  | (dBm)  |          |
| 3465.13   | -33.86        | 12.80    | 12.56 | -33.62        | -13.00 | -20.62 | H        |
| 5197.27   | -34.08        | 13.10    | 12.46 | <b>-33.44</b> | -13.00 | -20.44 | H        |
| 6930.09   | -33.57        | 12.33    | 21.13 | -42.37        | -13.00 | -29.37 | H        |
| 3465.13   | -35.06        | 12.80    | 12.76 | -35.02        | -13.00 | -22.02 | V        |
| 5197.27   | -34.88        | 13.10    | 16.32 | -38.10        | -13.00 | -25.10 | V        |
| 6930.09   | -32.25        | 12.33    | 21.13 | -41.05        | -13.00 | -28.05 | V        |
| LTE Band 4 / 1.4MHz / QPSK / RB Size 1 Offset 0/ The Worst Test Results for Highest |               |          |       |               |        |        |          |
| Frequency(MHz)  | S G.Lev (dBm) | Ant(dBi) | Loss  | PMea          | Limit  | Margin | Polarity |
|   |               |          |       | (dBm)         | (dBm)  | (dBm)  |          |
| 3508.62   | -33.96        | 12.61    | 12.56 | <b>-33.91</b> | -13.00 | -20.91 | H        |
| 5262.54   | -35.37        | 13.12    | 12.46 | -34.71        | -13.00 | -21.71 | H        |
| 7015.93   | -33.59        | 12.32    | 21.13 | -42.40        | -13.00 | -29.40 | H        |
| 3508.62   | -34.99        | 12.61    | 12.76 | -35.14        | -13.00 | -22.14 | V        |
| 5262.54   | -35.20        | 13.12    | 16.32 | -38.40        | -13.00 | -25.40 | V        |
| 7015.93   | -33.14        | 12.32    | 21.13 | -41.95        | -13.00 | -28.95 | V        |



| LTE Band 4 / 3MHz / QPSK / RB Size 1 Offset 0/ The Worst Test Results for Lowest  |               |          |       |        |        |        |          |
|---|---------------|----------|-------|--------|--------|--------|----------|
| Frequency(MHz)  | S G.Lev (dBm) | Ant(dBi) | Loss  | PMea   | Limit  | Margin | Polarity |
|   |               |          |       | (dBm)  | (dBm)  | (dBm)  |          |
| 3424.01   | -34.09        | 12.90    | 12.56 | -33.75 | -13.00 | -20.75 | H        |
| 5136.33   | -35.03        | 13.10    | 12.46 | -34.39 | -13.00 | -21.39 | H        |
| 6848.71   | -32.76        | 12.33    | 21.13 | -41.56 | -13.00 | -28.56 | H        |
| 3424.01   | -34.63        | 12.90    | 12.76 | -34.49 | -13.00 | -21.49 | V        |
| 5136.33   | -34.42        | 13.10    | 16.32 | -37.64 | -13.00 | -24.64 | V        |
| 6848.71   | -31.76        | 12.33    | 21.13 | -40.56 | -13.00 | -27.56 | V        |
| LTE Band 4 / 3MHz / QPSK / RB Size 1 Offset 0/ The Worst Test Results for Middle  |               |          |       |        |        |        |          |
| Frequency(MHz)  | S G.Lev (dBm) | Ant(dBi) | Loss  | PMea   | Limit  | Margin | Polarity |
|   |               |          |       | (dBm)  | (dBm)  | (dBm)  |          |
| 3465.15   | -34.37        | 12.80    | 12.56 | -34.13 | -13.00 | -21.13 | H        |
| 5197.16   | -34.64        | 13.10    | 12.46 | -34.00 | -13.00 | -21.00 | H        |
| 6930.02   | -33.57        | 12.33    | 21.13 | -42.37 | -13.00 | -29.37 | H        |
| 3465.15   | -35.20        | 12.80    | 12.76 | -35.16 | -13.00 | -22.16 | V        |
| 5197.16   | -35.08        | 13.10    | 16.32 | -38.30 | -13.00 | -25.30 | V        |
| 6930.02   | -31.89        | 12.33    | 21.13 | -40.69 | -13.00 | -27.69 | V        |
| LTE Band 4 / 3MHz / QPSK / RB Size 1 Offset 0/ The Worst Test Results for Highest |               |          |       |        |        |        |          |
| Frequency(MHz)  | S G.Lev (dBm) | Ant(dBi) | Loss  | PMea   | Limit  | Margin | Polarity |
|   |               |          |       | (dBm)  | (dBm)  | (dBm)  |          |
| 3506.70   | -34.86        | 12.61    | 12.56 | -34.81 | -13.00 | -21.81 | H        |
| 5262.11   | -35.32        | 13.12    | 12.46 | -34.66 | -13.00 | -21.66 | H        |
| 7012.91   | -32.76        | 12.32    | 21.13 | -41.57 | -13.00 | -28.57 | H        |
| 3506.70   | -35.76        | 12.61    | 12.76 | -35.91 | -13.00 | -22.91 | V        |
| 5262.11   | -34.25        | 13.12    | 16.32 | -37.45 | -13.00 | -24.45 | V        |
| 7012.91   | -31.74        | 12.32    | 21.13 | -40.55 | -13.00 | -27.55 | V        |



| LTE Band 4 / 5MHz / QPSK / RB Size 1 Offset 0/ The Worst Test Results for Lowest  |               |          |       |               |        |        |          |
|---|---------------|----------|-------|---------------|--------|--------|----------|
| Frequency(MHz)  | S G.Lev (dBm) | Ant(dBi) | Loss  | PMea          | Limit  | Margin | Polarity |
|   |               |          |       | (dBm)         | (dBm)  | (dBm)  |          |
| 3425.24   | -34.48        | 12.90    | 12.56 | -34.14        | -13.00 | -21.14 | H        |
| 5137.22   | -34.30        | 13.10    | 12.46 | <b>-33.66</b> | -13.00 | -20.66 | H        |
| 6850.24   | -33.36        | 12.33    | 21.13 | -42.16        | -13.00 | -29.16 | H        |
| 3425.24   | -35.06        | 12.90    | 12.76 | -34.92        | -13.00 | -21.92 | V        |
| 5137.22   | -34.48        | 13.10    | 16.32 | -37.70        | -13.00 | -24.70 | V        |
| 6850.24   | -31.72        | 12.33    | 21.13 | -40.52        | -13.00 | -27.52 | V        |
| LTE Band 4 / 5MHz / QPSK / RB Size 1 Offset 0/ The Worst Test Results for Middle  |               |          |       |               |        |        |          |
| Frequency(MHz)  | S G.Lev (dBm) | Ant(dBi) | Loss  | PMea          | Limit  | Margin | Polarity |
|   |               |          |       | (dBm)         | (dBm)  | (dBm)  |          |
| 3465.03   | -34.06        | 12.80    | 12.56 | <b>-33.82</b> | -13.00 | -20.82 | H        |
| 5196.83   | -34.75        | 13.10    | 12.46 | -34.11        | -13.00 | -21.11 | H        |
| 6929.99   | -33.36        | 12.33    | 21.13 | -42.16        | -13.00 | -29.16 | H        |
| 3465.03   | -35.46        | 12.80    | 12.76 | -35.42        | -13.00 | -22.42 | V        |
| 5196.83   | -34.04        | 13.10    | 16.32 | -37.26        | -13.00 | -24.26 | V        |
| 6929.99   | -31.84        | 12.33    | 21.13 | -40.64        | -13.00 | -27.64 | V        |
| LTE Band 4 / 5MHz / QPSK / RB Size 1 Offset 0/ The Worst Test Results for Highest |               |          |       |               |        |        |          |
| Frequency(MHz)  | S G.Lev (dBm) | Ant(dBi) | Loss  | PMea          | Limit  | Margin | Polarity |
|   |               |          |       | (dBm)         | (dBm)  | (dBm)  |          |
| 3505.46   | -34.38        | 12.61    | 12.56 | <b>-34.33</b> | -13.00 | -21.33 | H        |
| 5257.14   | -35.42        | 13.12    | 12.46 | -34.76        | -13.00 | -21.76 | H        |
| 7009.96   | -32.17        | 12.32    | 21.13 | -40.98        | -13.00 | -27.98 | H        |
| 3505.46   | -34.60        | 12.61    | 12.76 | -34.75        | -13.00 | -21.75 | V        |
| 5257.14   | -34.89        | 13.12    | 16.32 | -38.09        | -13.00 | -25.09 | V        |
| 7009.96   | -31.78        | 12.32    | 21.13 | -40.59        | -13.00 | -27.59 | V        |



| LTE Band 4 / 10MHz / QPSK / RB Size 1 Offset 0/ The Worst Test Results for Lowest  |               |          |       |        |        |        |          |
|--|---------------|----------|-------|--------|--------|--------|----------|
| Frequency(MHz)   | S G.Lev (dBm) | Ant(dBi) | Loss  | PMea   | Limit  | Margin | Polarity |
|  |               |          |       | (dBm)  | (dBm)  | (dBm)  |          |
| 3430.14  | -33.84        | 12.90    | 12.56 | -33.50 | -13.00 | -20.50 | H        |
| 5145.23  | -35.09        | 13.10    | 12.46 | -34.45 | -13.00 | -21.45 | H        |
| 6860.51  | -33.63        | 12.33    | 21.13 | -42.43 | -13.00 | -29.43 | H        |
| 3430.14  | -35.19        | 12.90    | 12.76 | -35.05 | -13.00 | -22.05 | V        |
| 5145.23  | -34.47        | 13.10    | 16.32 | -37.69 | -13.00 | -24.69 | V        |
| 6860.51  | -32.29        | 12.33    | 21.13 | -41.09 | -13.00 | -28.09 | V        |
| LTE Band 4 / 10MHz / QPSK / RB Size 1 Offset 0/ The Worst Test Results for Middle  |               |          |       |        |        |        |          |
| Frequency(MHz)   | S G.Lev (dBm) | Ant(dBi) | Loss  | PMea   | Limit  | Margin | Polarity |
|  |               |          |       | (dBm)  | (dBm)  | (dBm)  |          |
| 3464.98  | -34.35        | 12.80    | 12.56 | -34.11 | -13.00 | -21.11 | H        |
| 5197.27  | -34.98        | 13.10    | 12.46 | -34.34 | -13.00 | -21.34 | H        |
| 6929.94  | -32.73        | 12.33    | 21.13 | -41.53 | -13.00 | -28.53 | H        |
| 3464.98  | -34.62        | 12.80    | 12.76 | -34.58 | -13.00 | -21.58 | V        |
| 5197.27  | -34.64        | 13.10    | 16.32 | -37.86 | -13.00 | -24.86 | V        |
| 6929.94  | -33.08        | 12.33    | 21.13 | -41.88 | -13.00 | -28.88 | V        |
| LTE Band 4 / 10MHz / QPSK / RB Size 1 Offset 0/ The Worst Test Results for Highest |               |          |       |        |        |        |          |
| Frequency(MHz)   | S G.Lev (dBm) | Ant(dBi) | Loss  | PMea   | Limit  | Margin | Polarity |
|  |               |          |       | (dBm)  | (dBm)  | (dBm)  |          |
| 3500.82  | -34.81        | 12.61    | 12.56 | -34.76 | -13.00 | -21.76 | H        |
| 5250.39  | -35.23        | 13.12    | 12.46 | -34.57 | -13.00 | -21.57 | H        |
| 7000.23  | -33.64        | 12.32    | 21.13 | -42.45 | -13.00 | -29.45 | H        |
| 3500.82  | -35.76        | 12.61    | 12.76 | -35.91 | -13.00 | -22.91 | V        |
| 5250.39  | -35.03        | 13.12    | 16.32 | -38.23 | -13.00 | -25.23 | V        |
| 7000.23  | -32.25        | 12.32    | 21.13 | -41.06 | -13.00 | -28.06 | V        |



| LTE Band 4 / 15MHz / QPSK / RB Size 1 Offset 0/ The Worst Test Results for Lowest  |               |          |       |        |        |        |          |
|--|---------------|----------|-------|--------|--------|--------|----------|
| Frequency(MHz)   | S G.Lev (dBm) | Ant(dBi) | Loss  | PMea   | Limit  | Margin | Polarity |
|  |               |          |       | (dBm)  | (dBm)  | (dBm)  |          |
| 3435.20  | -34.58        | 12.90    | 12.56 | -34.24 | -13.00 | -21.24 | H        |
| 5152.24  | -35.46        | 13.10    | 12.46 | -34.82 | -13.00 | -21.82 | H        |
| 6870.71  | -32.91        | 12.33    | 21.13 | -41.71 | -13.00 | -28.71 | H        |
| 3435.20  | -35.50        | 12.90    | 12.76 | -35.36 | -13.00 | -22.36 | V        |
| 5152.24  | -35.06        | 13.10    | 16.32 | -38.28 | -13.00 | -25.28 | V        |
| 6870.71  | -32.58        | 12.33    | 21.13 | -41.38 | -13.00 | -28.38 | V        |
| LTE Band 4 / 15MHz / QPSK / RB Size 1 Offset 0/ The Worst Test Results for Middle  |               |          |       |        |        |        |          |
| Frequency(MHz)   | S G.Lev (dBm) | Ant(dBi) | Loss  | PMea   | Limit  | Margin | Polarity |
|  |               |          |       | (dBm)  | (dBm)  | (dBm)  |          |
| 3464.86  | -33.74        | 12.80    | 12.56 | -33.50 | -13.00 | -20.50 | H        |
| 5197.16  | -35.27        | 13.10    | 12.46 | -34.63 | -13.00 | -21.63 | H        |
| 6929.82  | -32.58        | 12.33    | 21.13 | -41.38 | -13.00 | -28.38 | H        |
| 3464.86  | -34.53        | 12.80    | 12.76 | -34.49 | -13.00 | -21.49 | V        |
| 5197.16  | -35.23        | 13.10    | 16.32 | -38.45 | -13.00 | -25.45 | V        |
| 6929.82  | -31.86        | 12.33    | 21.13 | -40.66 | -13.00 | -27.66 | V        |
| LTE Band 4 / 15MHz / QPSK / RB Size 1 Offset 0/ The Worst Test Results for Highest |               |          |       |        |        |        |          |
| Frequency(MHz)   | S G.Lev (dBm) | Ant(dBi) | Loss  | PMea   | Limit  | Margin | Polarity |
|  |               |          |       | (dBm)  | (dBm)  | (dBm)  |          |
| 3495.73  | -34.93        | 12.61    | 12.56 | -34.88 | -13.00 | -21.88 | H        |
| 5242.17  | -34.04        | 13.12    | 12.46 | -33.38 | -13.00 | -20.38 | H        |
| 6990.58  | -33.59        | 12.32    | 21.13 | -42.40 | -13.00 | -29.40 | H        |
| 3495.73  | -35.74        | 12.61    | 12.76 | -35.89 | -13.00 | -22.89 | V        |
| 5242.17  | -34.40        | 13.12    | 16.32 | -37.60 | -13.00 | -24.60 | V        |
| 6990.58  | -32.12        | 12.32    | 21.13 | -40.93 | -13.00 | -27.93 | V        |



| LTE Band 4 / 20MHz / QPSK / RB Size 1 Offset 0/ The Worst Test Results for Lowest  |                     |          |       |        |        |        |          |
|--|---------------------|----------|-------|--------|--------|--------|----------|
| Frequency(MHz)   | S<br>G.Lev<br>(dBm) | Ant(dBi) | Loss  | PMea   | Limit  | Margin | Polarity |
|  |                     |          |       | (dBm)  | (dBm)  | (dBm)  |          |
| 3440.14  | -33.57              | 12.90    | 12.56 | -33.23 | -13.00 | -20.23 | H        |
| 5160.58  | -34.32              | 13.10    | 12.46 | -33.68 | -13.00 | -20.68 | H        |
| 6880.72  | -32.76              | 12.33    | 21.13 | -41.56 | -13.00 | -28.56 | H        |
| 3440.14  | -34.98              | 12.90    | 12.76 | -34.84 | -13.00 | -21.84 | V        |
| 5160.58  | -33.86              | 13.10    | 16.32 | -37.08 | -13.00 | -24.08 | V        |
| 6880.72  | -32.70              | 12.33    | 21.13 | -41.50 | -13.00 | -28.50 | V        |
| LTE Band 4 / 20MHz / QPSK / RB Size 1 Offset 0/ The Worst Test Results for Middle  |                     |          |       |        |        |        |          |
| Frequency(MHz)   | S<br>G.Lev<br>(dBm) | Ant(dBi) | Loss  | PMea   | Limit  | Margin | Polarity |
|  |                     |          |       | (dBm)  | (dBm)  | (dBm)  |          |
| 3465.06  | -33.91              | 12.80    | 12.56 | -33.67 | -13.00 | -20.67 | H        |
| 5197.21  | -34.97              | 13.10    | 12.46 | -34.33 | -13.00 | -21.33 | H        |
| 6930.09  | -33.05              | 12.33    | 21.13 | -41.85 | -13.00 | -28.85 | H        |
| 3465.06  | -35.98              | 12.80    | 12.76 | -35.94 | -13.00 | -22.94 | V        |
| 5197.21  | -34.26              | 13.10    | 16.32 | -37.48 | -13.00 | -24.48 | V        |
| 6930.09  | -32.08              | 12.33    | 21.13 | -40.88 | -13.00 | -27.88 | V        |
| LTE Band 4 / 20MHz / QPSK / RB Size 1 Offset 0/ The Worst Test Results for Highest |                     |          |       |        |        |        |          |
| Frequency(MHz)   | S<br>G.Lev<br>(dBm) | Ant(dBi) | Loss  | PMea   | Limit  | Margin | Polarity |
|  |                     |          |       | (dBm)  | (dBm)  | (dBm)  |          |
| 3490.55  | -34.85              | 12.61    | 12.56 | -34.80 | -13.00 | -21.80 | H        |
| 5235.30  | -34.12              | 13.12    | 12.46 | -33.46 | -13.00 | -20.46 | H        |
| 6979.92  | -33.45              | 12.32    | 21.13 | -42.26 | -13.00 | -29.26 | H        |
| 3490.55  | -35.55              | 12.61    | 12.76 | -35.70 | -13.00 | -22.70 | V        |
| 5235.30  | -34.18              | 13.12    | 16.32 | -37.38 | -13.00 | -24.38 | V        |
| 6979.92  | -32.77              | 12.32    | 21.13 | -41.58 | -13.00 | -28.58 | V        |

## 10. FREQUENCY STABILITY

### 10.1 DESCRIPTION OF FREQUENCY STABILITY MEASUREMENT

#### 10.1.1 MEASUREMENT METHOD

The frequency stability shall be measured by variation of ambient temperature and variation of primary supply voltage to ensure that the fundamental emission stays within the authorized frequency block. The frequency stability of the transmitter shall be maintained within  $\pm 0.00025\%$  ( $\pm 2.5\text{ppm}$ ) of the center frequency.

#### 10.1.2 TEST SETUP

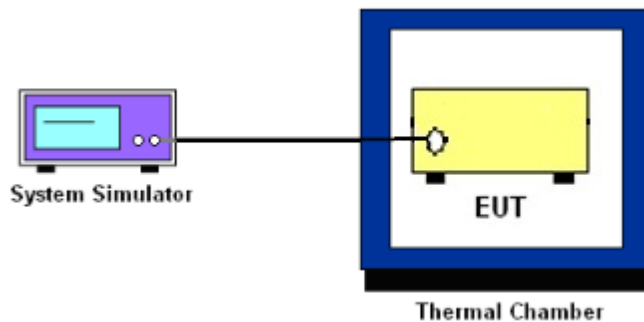

#### 10.1.3 TEST PROCEDURES FOR TEMPERATURE VARIATION

1. The EUT was set up in the thermal chamber and connected with the system simulator.
2. With power OFF, the temperature was decreased to  $-30^{\circ}\text{C}$  and the EUT was stabilized before testing. Power was applied and the maximum change in frequency was recorded within one minute.
3. With power OFF, the temperature was raised in  $10^{\circ}\text{C}$  step up to  $50^{\circ}\text{C}$ . The EUT was stabilized at each step for at least half an hour. Power was applied and the maximum frequency change was recorded within one minute.

#### 10.1.4 TEST PROCEDURES FOR VOLTAGE VARIATION

1. The testing follows FCC KDB 971168 D01v01r03 Section 9.0.
2. The EUT was placed in a temperature chamber at  $25\pm 5^{\circ}\text{C}$  and connected with the system simulator.
3. The power supply voltage to the EUT was varied from 85% to 115% of the nominal value measured at the input to the EUT.
4. The variation in frequency was measured for the worst case.



10.1.5 TEST RESULTS

| LTE Band 4 (QPSK) / 1733MHz / BW10M |                |                 |            |        |        |
|-------------------------------------|----------------|-----------------|------------|--------|--------|
| Temperature (°C)                    | Voltage        | Freq. Dev.      | Freq. Dev. | Limit  | Result |
|                                     | (Volt)         | (Hz)            | (ppm)      |        |        |
| 50                                  | Normal Voltage | 31.64           | 0.018      | 2.5ppm | PASS   |
| 40                                  |                | 24.42           | 0.014      |        |        |
| 30                                  |                | 20.34           | 0.012      |        |        |
| 20                                  |                | 34.04           | 0.020      |        |        |
| 10                                  |                | 21.63           | 0.012      |        |        |
| 0                                   |                | 30.78           | 0.018      |        |        |
| -10                                 |                | 30.34           | 0.018      |        |        |
| -20                                 |                | 33.37           | 0.019      |        |        |
| -30                                 |                | 16.50           | 0.010      |        |        |
| 25                                  |                | Maximum Voltage | 19.80      |        |        |
| 25                                  | BEP            | 18.18           | 0.010      |        |        |

| LTE Band 4 (QPSK) / 1733MHz / BW20M |                |                 |            |        |        |
|-------------------------------------|----------------|-----------------|------------|--------|--------|
| Temperature (°C)                    | Voltage        | Freq. Dev.      | Freq. Dev. | Limit  | Result |
|                                     | (Volt)         | (Hz)            | (ppm)      |        |        |
| 50                                  | Normal Voltage | 25.39           | 0.015      | 2.5ppm | PASS   |
| 40                                  |                | 18.04           | 0.010      |        |        |
| 30                                  |                | 27.52           | 0.016      |        |        |
| 20                                  |                | 28.73           | 0.017      |        |        |
| 10                                  |                | 29.45           | 0.017      |        |        |
| 0                                   |                | 29.72           | 0.017      |        |        |
| -10                                 |                | 29.27           | 0.017      |        |        |
| -20                                 |                | 31.58           | 0.018      |        |        |
| -30                                 |                | 23.21           | 0.013      |        |        |
| 25                                  |                | Maximum Voltage | 11.86      |        |        |
| 25                                  | BEP            | 26.08           | 0.015      |        |        |





## APPENDIX-PHOTOS OF TEST SETUP

Note: See test photos in setup photo document for the actual connections between Product and support equipment.

\*\*\*\*\*END OF THE REPORT\*\*\*\*\*

