

## RF Test Report

Applicant : Synology Inc.

Product Name : Wi-Fi camera

Trade Name : Synology

Model Number : CC400W

Applicable Standard : FCC 47 CFR PART 15 SUBPART E  
ANSI C63.10:2013

Received Date : Nov. 21, 2023

Test Period : Dec. 12, 2023 ~ Jan. 15, 2024

Issued Date : Mar. 04, 2024

### Issued by

Eurofins E&E Wireless Taiwan Co., Ltd.  
No. 140-1, Changan Street, Bade District,  
Taoyuan City 334025, Taiwan (R.O.C.)  
Tel : +886-3-2710188 / Fax : +886-3-2710190



Taiwan Accreditation Foundation accreditation number: 1330  
Frequency Range: 9 kHz to 325 GHz  
Bade test site :  
Test Firm Registration Number: 226252  
Test Firm Designation Number: TW0010  
Wugu test site :  
Test Firm Registration Number: 191812  
Test Firm Designation Number: TW0034

#### Note:

1. The test results are valid only for samples provided by customers and under the test conditions described in this report.
2. This report shall not be reproduced except in full, without the written approval of Eurofins E&E Wireless Taiwan Co., Ltd.
3. The relevant information is provided by customers in this test report. According to the correctness, appropriateness or completeness of the information provided by the customer, if there is any doubt or error in the information which affects the validity of the test results, the laboratory does not take the responsibility.

### Revision History

Rev.	Issued Date	Description	Revised By
00	Mar. 04, 2024	Initial Issue	Abby Huang

## Verification of Compliance

Applicant : Synology Inc.

Product Name : Wi-Fi camera

Trade Name : Synology

Model Number : CC400W

FCC ID : YOR-CC400W

Applicable Standard : FCC 47 CFR PART 15 SUBPART E  
ANSI C63.10:2013

Test Result : Complied

Performing Lab. : Eurofins E&E Wireless Taiwan Co., Ltd.  
No. 140-1, Changan Street, Bade District,  
Taoyuan City 334025, Taiwan (R.O.C.)  
Tel : +886-3-2710188 / Fax : +886-3-2710190  
Taiwan Accreditation Foundation accreditation number: 1330



Eurofins E&E Wireless Taiwan Co., Ltd. tested the above equipment in accordance with the requirements set forth in the above standards. All indications of Pass/Fail in this report are opinions expressed by Eurofins E&E Wireless Taiwan Co., Ltd. based on interpretations and/or observations of test results. The test results show that the equipment tested is capable of demonstrating compliance with the requirements as documented in this report.

Approved By : \_\_\_\_\_

## TABLE OF CONTENTS

<b>1</b>	<b>General Information.....</b>	<b>5</b>
1.1.	Summary of Test Result .....	5
1.2.	Testing Location .....	6
1.3.	Measurement Uncertainty .....	6
1.4.	Test Site Environment .....	6
<b>2</b>	<b>EUT Description.....</b>	<b>7</b>
<b>3</b>	<b>Test Methodology .....</b>	<b>11</b>
3.1.	Mode of Operation.....	11
3.2.	EUT Test Step .....	13
3.3.	Configuration of Test System Details.....	14
3.4.	Test Instruments .....	15
<b>4</b>	<b>Measurement Procedure .....</b>	<b>17</b>
4.1.	AC Power Conducted Emission Measurement .....	17
4.2.	Transmitter Radiated Emissions Measurement.....	19
4.3.	Maximum Conducted Output Power Measurement .....	24
4.4.	26 dB RF Bandwidth Measurement .....	26
4.5.	6 dB RF Bandwidth Measurement .....	27
4.6.	Maximum Power Spectral Density Measurement .....	28
4.7.	Automatically discontinue transmission.....	30
4.8.	Antenna Requirement .....	31
<b>5</b>	<b>Test Results .....</b>	<b>32</b>
5.1.	Conducted Emission .....	32
5.2.	Radiated Emission Measurement .....	34

**Appendix A. Test Data**

**Appendix B. Test Plots**

**Appendix C. Test Setup Photographs**

# 1 General Information

## 1.1. Summary of Test Result

Standard	Item	Result	Remark
15.407(b)(9) 15.207	AC Power Conducted Emission	PASS	---
15.407(b) 15.205 / 15.209	Transmitter Radiated Emissions	PASS	---
15.407(a)	Maximum Conducted Output Power	PASS	---
15.407(a)	26 dB RF Bandwidth	Reference	---
15.407(e)	6 dB RF Bandwidth	PASS	---
15.407(a)	Maximum Power Spectral Density	PASS	---
15.407(c)	Automatically discontinue transmission	PASS	---
15.407(a) 15.203	Antenna Requirement	PASS	---

### Decision Rule

- Uncertainty is not included.
- Uncertainty is included.

Standard	Description
CFR47, Part 15, Subpart C	Intentional Radiators
CFR47, Part 15, Subpart E	Unlicensed National Information Infrastructure Devices
ANSI C63. 10: 2013	American National Standard of Procedures for Compliance Testing of Unlicensed Wireless Devices
KDB789033: D02	Guidelines for Compliance Testing of Unlicensed National Information Infrastructure (U-NII) Devices Part 15, Subpart E
KDB 662911 D01 v02r01	Emissions Testing of Transmitters with Multiple Outputs in the Same Band (e.g., MIMO, Smart Antenna, etc)

## 1.2. Testing Location

Lab Name: Eurofins E&E Wireless Taiwan Co., Ltd.  
 Site Address:  No. 140-1, Changan Street, Bade District, Taoyuan City 334025, Taiwan (R.O.C.)  
 Site Address:  No. 2, Wuquan 5th Rd. Wugu Dist., New Taipei City, Taiwan (R.O.C.)

## 1.3. Measurement Uncertainty

Test Item	Frequency	Uncertainty			
		BD	WG		
Conducted Emission	150 kHz ~ 30 MHz	2.7 dB	2.6 dB		
Conducted Output Power		1.1 dB	1.1 dB		
RF Bandwidth		4.5 %	4.5 %		
Power Spectral Density		1.1 dB	1.1 dB		
Duty Cycle		1.1 %	1.0 %		
Time Occupancy		1.5 %	1.2 %		
Test Item	Frequency	Uncertainty			
		96601-BD	96603-BD	96602-WG	96603-WG
Radiated Emission	9 kHz ~ 30 MHz	1.9 dB	1.9 dB	1.6 dB	1.6 dB
	30 MHz ~ 1000 MHz	4.9 dB	4.9 dB	4.8 dB	4.8 dB
	1000 MHz ~ 18000 MHz	4.9 dB	5.0 dB	5.0 dB	5.2 dB
	18000 MHz ~ 26500 MHz	4.3 dB	4.4 dB	4.4 dB	4.5 dB
	26500 MHz ~ 40000 MHz	4.5 dB	4.5 dB	4.6 dB	4.5 dB

## 1.4. Test Site Environment

Items	Required (IEC 60068-1)	Interval(*)
Temperature (°C)	15-35	20-30
Humidity (%RH)	25-75	45-75

(\*)The measurement ambient temperature is within this range.

## 2 EUT Description

The product specifications of the EUT presented in the report are declared by the manufacturer who shall take full responsibility for the authenticity(except Max. RF Output Power).

Applicant	Synology Inc. 9F., No.1, Yuandong Rd., Banqiao Dist., New Taipei City 220632		
Product Name	Wi-Fi camera		
Trade Name	Synology		
Model Number	CC400W		
FCC ID	YOR-CC400W		
Operate Frequency	Frequency Band		Frequency Range (MHz)
	802.11a	U-NII Band 1	5180 – 5240
		U-NII Band 2-A	5260 – 5320
		U-NII Band 2-C	5500 – 5700
		U-NII Band 3	5745 – 5825
	802.11n HT20 / 802.11ac VHT20	U-NII Band 1	5180 – 5240
		U-NII Band 2-A	5260 – 5320
		U-NII Band 2-C	5500 – 5700
		U-NII Band 3	5745 – 5825
	802.11n HT40 / 802.11ac VHT40	U-NII Band 1	5190 – 5230
		U-NII Band 2-A	5270 – 5310
		U-NII Band 2-C	5510 – 5670
		U-NII Band 3	5755 – 5795
	802.11ac VHT80	U-NII Band 1	5210
		U-NII Band 2-A	5290
		U-NII Band 2-C	5530
U-NII Band 3		5775	
Modulation Type	OFDM		

Antenna information	Antenna	Model	Type	Max. Gain (dBi)	
	ANT-0	ALX23F-221AA0-00	Dipole Antenna	U-NII Band 1	5.50
				U-NII Band 2-A	5.50
				U-NII Band 2-C	5.50
				U-NII Band 3	5.50
Antenna Delivery	Reference section 3.1				
Operate Temp. Range	-20 ~ 40 °C				
EUT Power Rating	DC 5 V, 1.0 A (USB Type C)				



Frequency Band		Max. RF Output Power (W)
802.11a	U-NII Band 1	0.050
	U-NII Band 2-A	0.049
	U-NII Band 2-C	0.047
	U-NII Band 3	0.050
802.11n HT20	U-NII Band 1	0.049
	U-NII Band 2-A	0.049
	U-NII Band 2-C	0.048
	U-NII Band 3	0.049
802.11n HT40	U-NII Band 1	0.039
	U-NII Band 2-A	0.037
	U-NII Band 2-C	0.038
	U-NII Band 3	0.037
802.11ac VHT20	U-NII Band 1	0.050
	U-NII Band 2-A	0.050
	U-NII Band 2-C	0.048
	U-NII Band 3	0.050
802.11ac VHT40	U-NII Band 1	0.040
	U-NII Band 2-A	0.038
	U-NII Band 2-C	0.039
	U-NII Band 3	0.038
802.11ac VHT80	U-NII Band 1	0.019
	U-NII Band 2-A	0.019
	U-NII Band 2-C	0.031
	U-NII Band 3	0.032

Equipment Type		
Outdoor access point	point-to-point	---
	point-to-multipoint	---
Indoor access point		---
Fixed point-to-point access points		---
Client devices		V

## WIFI 5G

5150 MHz ~5250 MHz(UNII-1):

BW 20M	CH	36	40	44	48
	Freq. (MHz)	5180	5200	5220	5240
BW 40M	CH	38		46	
	Freq. (MHz)	5190		5230	
BW 80M	CH	42			
	Freq. (MHz)	5210			

5250 MHz ~5350 MHz(UNII-2A):

BW 20M	CH	52	56	60	64
	Freq. (MHz)	5260	5280	5300	5320
BW 40M	CH	54		62	
	Freq. (MHz)	5270		5310	
BW 80M	CH	58			
	Freq. (MHz)	5290			

5470 MHz ~5725 MHz(UNII-2C):

BW 20M	CH	100	104	108	112	116	120	124	128	132	136	140	144
	Freq. (MHz)	5500	5520	5540	5560	5580	5600	5620	5640	5660	5680	5700	---
BW 40M	CH	102		110		118		126		134		142	
	Freq. (MHz)	5510		5550		5590		5630		5670		---	
BW 80M	CH	106				122				138			
	Freq. (MHz)	5530				5610				---			

5725 MHz ~5850 MHz(UNII-3):

BW 20M	CH	149	153	157	161	165	
	Freq. (MHz)	5745	5765	5785	5805	5825	
BW 40M	CH	151			159		
	Freq. (MHz)	5755			5795		
BW 80M	CH	155					
	Freq. (MHz)	5775					

### 3 Test Methodology

#### 3.1. Mode of Operation

Decision of Test Eurofins has verified the construction and function in typical operation. All the test modes were carried out with the EUT in normal operation, which was shown in this test report and defined as:

Pre-Test Mode	Final-Test Mode
Transmit Mode	V
802.11a	V
802.11n HT20	
802.11n HT40	
802.11ac VHT20	V
802.11ac VHT40	V
802.11ac VHT80	V

Software used to control the EUT for staying in continuous transmitting mode was programmed.

After verification, all tests were carried out with the worst case test modes.

By preliminary testing and verifying three axis (X, Y and Z) position of EUT transmitted status, it was found that “Z axis” position was the worst, then the final test was executed the worst condition and test data were recorded in this report.

Note 1: Investigation has been done on all the possible configurations for searching the worst cases (5GHz VHT covers HT). The table is a list of the test modes show in this test report.

Test Mode	ANT-0
802.11a	V
802.11n HT20	V
802.11n HT40	V
802.11ac VHT20	V
802.11ac VHT40	V
802.11ac VHT80	V

Test Mode	Antenna Delivery	Data Rate (Mbps)	Band	Test Channel
802.11a	1TX	6	U-NII Band 1	36, 40, 48
			U-NII Band 2-A	52, 56, 64
			U-NII Band 2-C	100, 112, 140
			U-NII Band 3	149, 157, 165
802.11n HT20	1TX	6.5	U-NII Band 1	36, 40, 48
			U-NII Band 2-A	52, 56, 64
			U-NII Band 2-C	100, 112, 140
			U-NII Band 3	149, 157, 165
802.11n HT40	1TX	13.5	U-NII Band 1	38, 46
			U-NII Band 2-A	54, 62
			U-NII Band 2-C	102, 110, 134
			U-NII Band 3	151,159
802.11ac VHT20	1TX	MCS0	U-NII Band 1	36, 40, 48
			U-NII Band 2-A	52, 56, 64
			U-NII Band 2-C	100, 112, 140
			U-NII Band 3	149, 157, 165
802.11ac VHT40	1TX	MCS0	U-NII Band 1	38, 46
			U-NII Band 2-A	54, 62
			U-NII Band 2-C	102, 110, 134
			U-NII Band 3	151,159
802.11ac VHT80	1TX	MCS0	U-NII Band 1	42
			U-NII Band 2-A	58
			U-NII Band 2-C	106, 122
			U-NII Band 3	155

### 3.2. EUT Test Step

The EUT is operated in the engineering mode to fix the TX frequency for the purposes of measurement. According to its specifications, the EUT must comply with the requirements of Section 15.407 under the FCC Rules Part 15 Subpart E.

1.	Setup the EUT shown on "Configuration of Test System Details".
2.	Turn on the power of all equipment.
3.	Turn on TX function.
4.	EUT run test program.

### 3.3. Configuration of Test System Details

#### Conducted Emissions

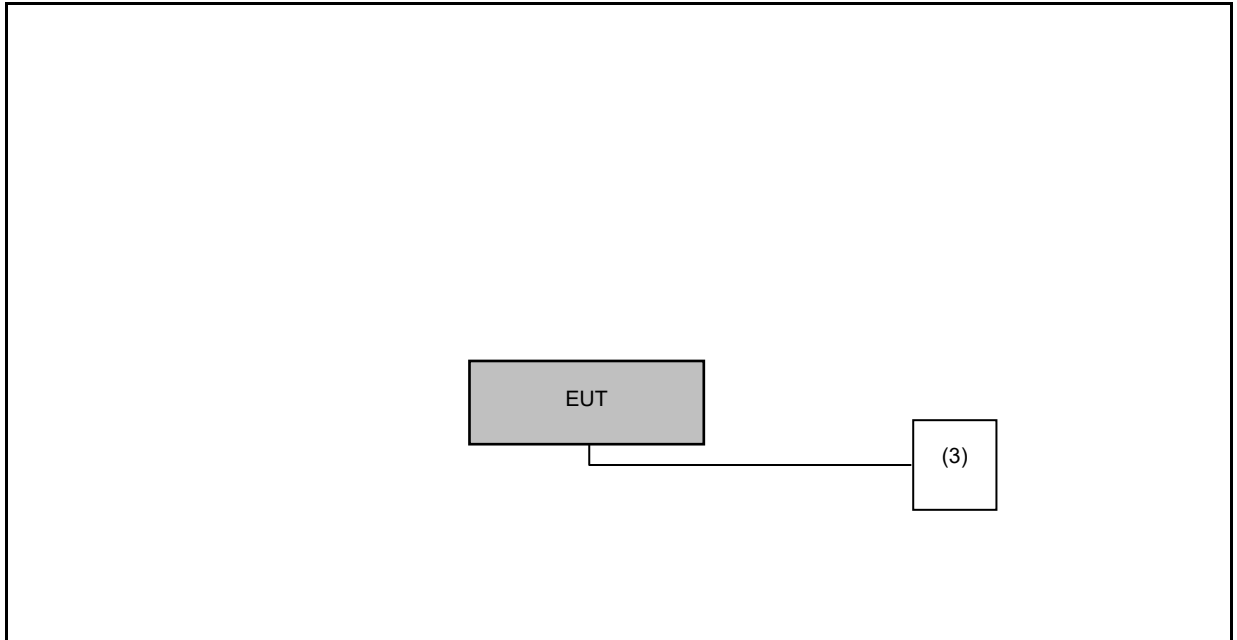

#### Radiated Emission

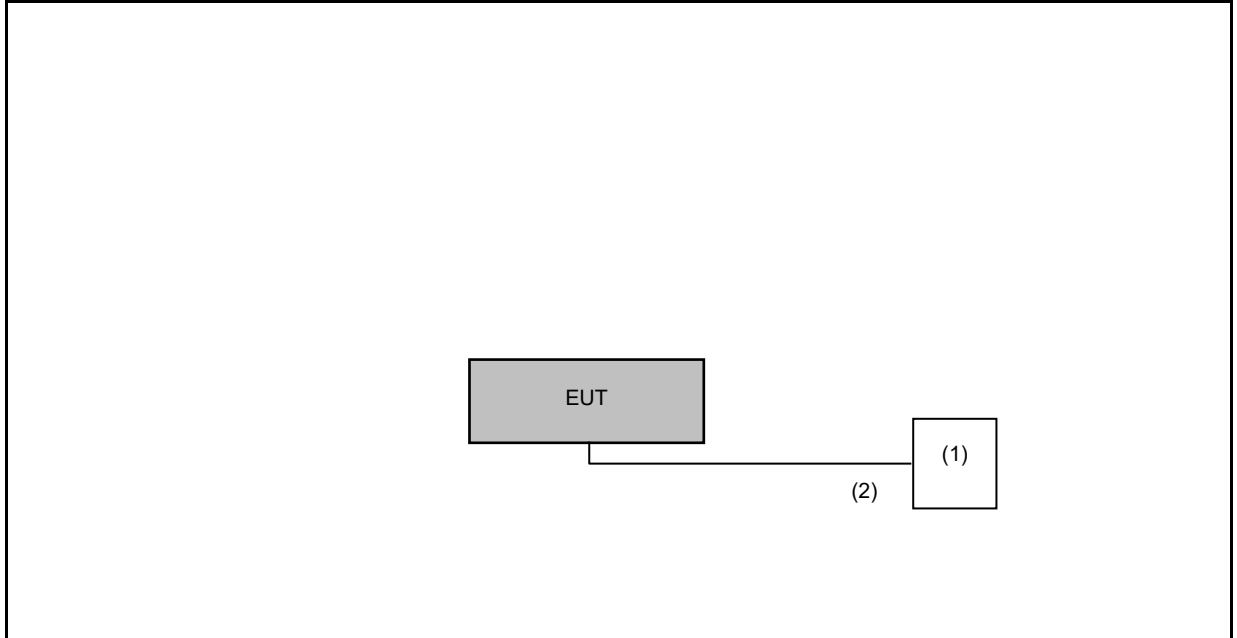

	Product	Manufacturer	Model Number	Note
(1)	Notebook	ASUS	X542U	---
(2)	Console cable	Synology	CC400W console cable	---
(3)	Adapter	CHANNEL WELL	2AFG005BC	---

### 3.4. Test Instruments

For Conducted

Test Period: Dec. 13, 2023 ~ Jan. 15, 2024

Testing Engineer: Sandy Yang

Test Site		RF03-WG				
Use	Equipment	Manufacturer	Model Number	Serial Number	Cal. Date	Cal. Period
<input checked="" type="checkbox"/>	Power Sensor	Anritsu	MA24408A	11998	Feb. 07, 2023	1 year
<input checked="" type="checkbox"/>	Spectrum Analyzer (10 Hz~26.5 GHz)	Keysight	N9010B	MY63460164	Mar. 07, 2023	1 year

For Conduction Emissions

Test Period: Jan. 08, 2024

Testing Engineer: Jason Yeh

Radiation test sites		Conducted Emission Measurement Conduction01-WG				
Use	Equipment	Manufacturer	Model Number	Serial Number	Cal. Date	Cal. Period
<input checked="" type="checkbox"/>	Test Receiver	R&S	ESR3	102919	Nov 30, 2023	1 year
<input checked="" type="checkbox"/>	LISN	R&S	ENV216	101041	Apr 12, 2023	1 year
<input checked="" type="checkbox"/>	Current Probe	R&S	EZ-17	101687	Jun 15, 2023	1 year
<input checked="" type="checkbox"/>	Cable	EMCI	EMCCFD300-BM-NM-4000	220402	Jun 08, 2023	1 year
<input checked="" type="checkbox"/>	Software	ELEKTRA	94.50.4	N.A.	N.C.R.	N.C.R.

Note: N.C.R. = No Calibration Request

For Radiated Emissions

Test Period: Dec. 12, 2023 ~ Jan. 11, 2024

Testing Engineer: Jason Yeh

Radiation test sites		Semi Anechoic Room 96603-WG				
Use	Equipment	Manufacturer	Model Number	Serial Number	Cal. Date	Cal. Perio
<input checked="" type="checkbox"/>	LOOP Antenna (9 kHz~30 MHz)	Schwarzbeck Mess-Elektronik	FMZB 1513-60	00031	Feb. 21, 2023	1 year
<input checked="" type="checkbox"/>	Trilog Broadband Antenna (30 kHz~1 GHz)	Schwarzbeck Mess-Elektronik	VULB9168	1276	Feb. 09, 2023	1 year
<input checked="" type="checkbox"/>	Broadband Horn Antenna (1 GHz~18 GHz)	RF SPIN	DRH18-E	210307A18ES	Dec. 15, 2023	1 year
<input checked="" type="checkbox"/>	Broadband Horn Antenna (15 GHz~40 GHz)	Schwarzbeck Mess-Elektronik	BBHA9170	1133	Feb. 13, 2023	1 year
<input checked="" type="checkbox"/>	Spectrum Analyzer (2 Hz~50 GHz)	KEYSIGHT	N9030B	MY57153537	Apr. 18, 2023	1 year
<input checked="" type="checkbox"/>	Pre-Amplifier	EMCI	EMC001330	980859	Nov. 29, 2023	1 year
<input checked="" type="checkbox"/>	Pre-Amplifier	EMCI	EMC118A45SE	980822	Nov. 29, 2023	1 year
<input checked="" type="checkbox"/>	Pre-Amplifier	EMCI	EMC184045SE	980861	Dec. 21, 2023	1 year
<input checked="" type="checkbox"/>	Coaxial Cable (10 kHz~3000 MHz)	EMCI	EMCCFD400-NM-NM-2000	211009	Dec. 28, 2023	1 year
<input checked="" type="checkbox"/>	Coaxial Cable (10 kHz~3000 MHz)	EMCI	EMCCFD400-NM-NM-2000	211010	Dec. 28, 2023	1 year
<input checked="" type="checkbox"/>	Coaxial Cable (10 kHz~3000 MHz)	EMCI	EMCCFD400-NM-NM-6000	211018	Dec. 28, 2023	1 year
<input checked="" type="checkbox"/>	Coaxial Cable (1 GHz~18 GHz)	EMCI	EMC104-SM-SM-1000	211029	Dec. 28, 2023	1 year
<input checked="" type="checkbox"/>	Coaxial Cable (1 GHz~18 GHz)	EMCI	EMC104-SM-SM-2000	211033	Dec. 28, 2023	1 year
<input checked="" type="checkbox"/>	Coaxial Cable (1 GHz~18 GHz)	EMCI	EMC104-SM-SM-8000	211038	Dec. 28, 2023	1 year
<input checked="" type="checkbox"/>	Coaxial Cable (18 GHz~40 GHz)	EMCI	EMC101G-KM-KM-600	211211	Dec. 28, 2023	1 year
<input checked="" type="checkbox"/>	Coaxial Cable (18 GHz~40 GHz)	EMCI	EMC101G-KM-KM-2000	211210	Dec. 28, 2023	1 year
<input checked="" type="checkbox"/>	Coaxial Cable (18 GHz~40 GHz)	EMCI	EMC101G-KM-KM-6000	211209	Dec. 28, 2023	1 year
<input checked="" type="checkbox"/>	Highpass Filter	Warison	WFIL-H3000-20000F	WR4BBFWC2B1	Nov. 13, 2023	1 year
<input checked="" type="checkbox"/>	Highpass Filter	Warison	WFIL-H8000-26000F	001	Nov. 13, 2023	1 year
<input checked="" type="checkbox"/>	Software	R_RAM	V1.3	N/A	N.C.R.	---

Note: N.C.R. = No Calibration Request



## 4 Measurement Procedure

### 4.1. AC Power Conducted Emission Measurement

■ **Limit**

Frequency (MHz)	Quasi-peak	Average
0.15 - 0.5	66 to 56	56 to 46
0.50 - 5.0	56	46
5.0 - 30.0	60	50

■ **Test Setup**

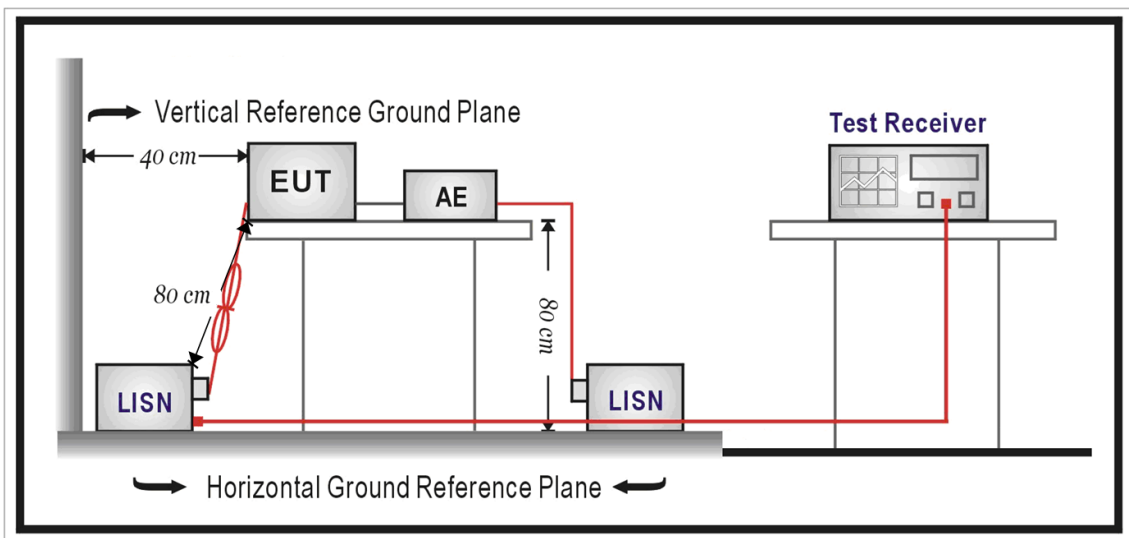

### ■ Test Procedure

The EUT and simulators are connected to the main power through a line impedance stabilization network (L.I.S.N.). This provides a  $50 \Omega // 50 \mu\text{H}$  coupling impedance for the measuring equipment. The peripheral devices are also connected to the main power through a LISN that provides a  $50 \Omega // 50 \mu\text{H}$  coupling impedance with 50 ohm termination.

Tabletop device shall be placed on a non-conducting platform, of nominal size 1 m by 1.5 m, raised 80 cm above the reference ground plane. The wall of screened room shall be located 40 cm to the rear of the EUT. Other surfaces of tabletop or floor standing EUT shall be at least 80 cm from any other ground conducting surface including one or more LISNs. For floor-standing device shall be placed under the EUT with a 12 mm insulating material.

Conducted emissions were investigated over the frequency range from 0.15 MHz to 30 MHz using a resolution bandwidth of 9 kHz. The equipment under test (EUT) shall be meet the limits in section 4.1, as applicable, including the average limit and the quasi-peak limit when using respectively, an average detector and quasi-peak detector measured in accordance with the methods described of related standard. When all of peak value were complied with quasi-peak and average limit from 150 kHz to 30 MHz then quasi-peak and average measurement was unnecessary.

The AMN shall be placed 0.8 m from the boundary of the unit under test and bonded to a ground reference plane for AMNs mounted on top of the ground reference plane. This distance is between the closest points of the AMN and the EUT. All other units of the EUT and associated equipment shall be at least 0.8 m from the AMN. If the mains power cable is longer than 1 m then the cable shall be folded back and forth at the centre of the lead to form a bundle no longer than 0.4 m. All of interconnecting cables that hang closer than 40 cm to the ground plane shall be folded back and forth in the center forming a bundle 30 cm to 40 cm long. All of EUT and AE shall be separate place more than 0.1 m. All  $50 \Omega$  ports of the LISN shall be resistively terminated into  $50 \Omega$  loads when not connected to the measuring instrument.

If the reading of the measuring receiver shows fluctuations close to the limit, the reading shall be observed for at least 15 s at each measurement frequency; the higher reading shall be recorded with the exception of any brief isolated high reading which shall be ignored

## 4.2. Transmitter Radiated Emissions Measurement

■ **Limit**

(1) Undesirable emission limits. Except as shown in paragraph (b)(9) of this section, the maximum emissions outside of the frequency bands of operation shall be attenuated in accordance with the following limits:

- (a) For transmitters operating in the 5.15-5.25 GHz band: All emissions outside of the 5.15-5.35 GHz band shall not exceed an e.i.r.p. of -27 dBm/MHz.
- (b) For transmitters operating in the 5.25-5.35 GHz band: All emissions outside of the 5.15-5.35 GHz band shall not exceed an e.i.r.p. of -27 dBm/MHz.
- (c) For transmitters operating in the 5.47-5.725 GHz band: All emissions outside of the 5.47-5.725 GHz band shall not exceed an e.i.r.p. of -27 dBm/MHz.
- (d) For transmitters operating in the 5.725-5.85 GHz band:
  - (i) All emissions shall be limited to a level of -27 dBm/MHz at 75 MHz or more above or below the band edge increasing linearly to 10 dBm/MHz at 25 MHz above or below the band edge, and from 25 MHz above or below the band edge increasing linearly to a level of 15.6 dBm/MHz at 5 MHz above or below the band edge, and from 5 MHz above or below the band edge increasing linearly to a level of 27 dBm/MHz at the band edge.

EIRP (dBm)	Field Strength at 3 m(dBuV/m)
-27	68.3

(2) Limits of Radiated Emission Measurement

Emissions radiated outside of the specified bands, shall be according to the general radiated limits in 15.209 as following:

Frequency Range (MHz)	Field Strength (microvolts/meter)	Measurement Distance (meters)
0.009 ~ 0.490	2400/F(kHz)	300
0.490 ~ 1.705	24000/F(kHz)	30
1.705 ~ 30.0	30	30
30 ~ 88	10	3
88 ~ 216	150	3
216 ~ 960	200	3
Above 960	500	3

- Note:
1. The lower limit shall apply at the transition frequencies.
  2. Emission level (dBuV/m) = 20 log Emission level (uV/m).
  3. As shown in 15.35(b), for frequencies above 1000 MHz, the field strength limits are based on average detector, however, the peak field strength of any emission shall not exceed the maximum permitted average limits, specified above by more than 20 dB under any condition of modulation.

■ Setup

9 kHz ~ 30 MHz

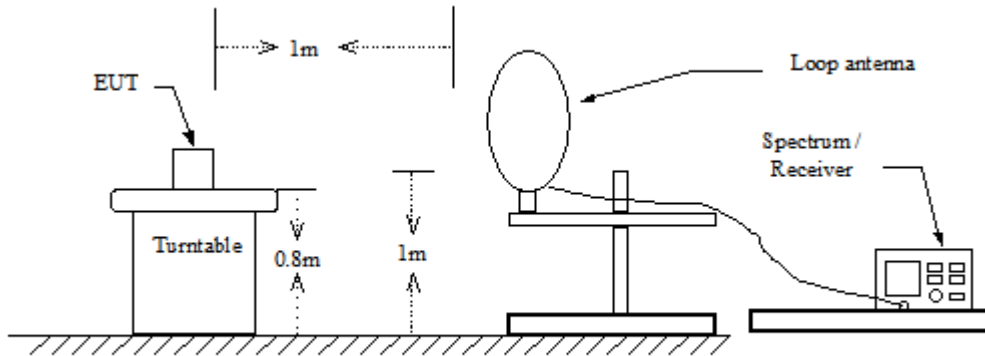

30 MHz ~ 1 GHz

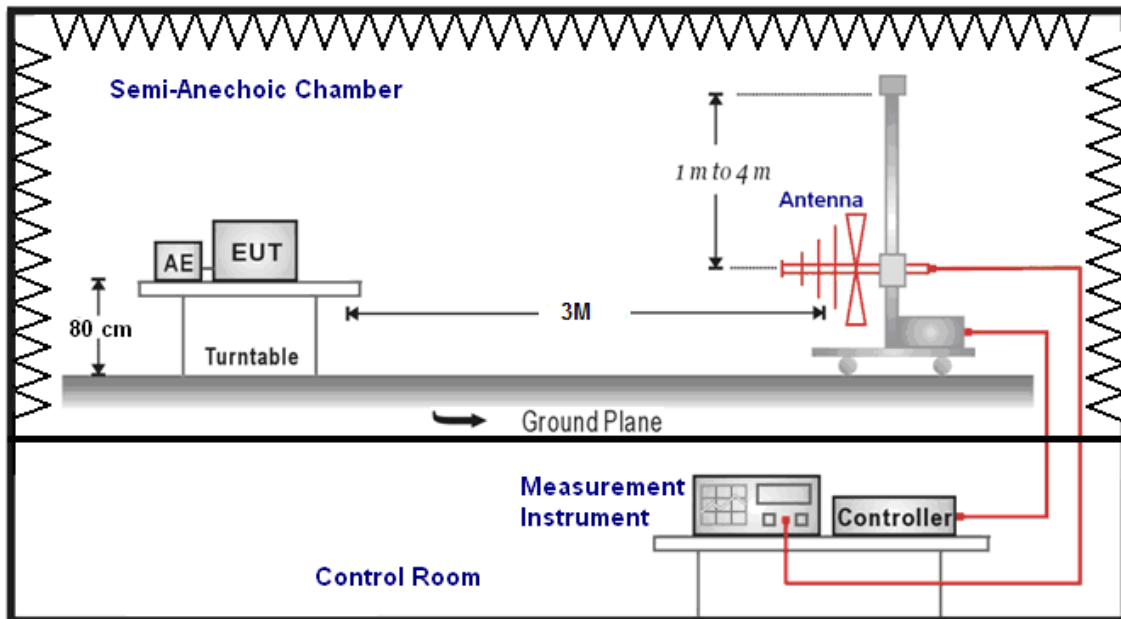

Above 1 GHz

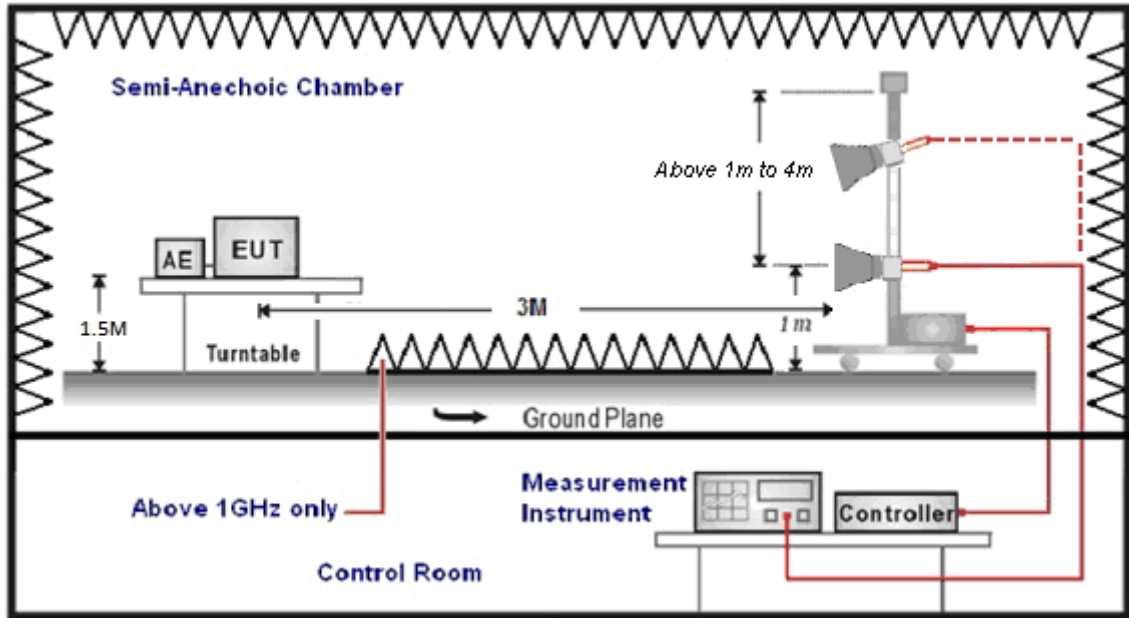

## ■ Test Procedure

Final radiation measurements were made on a three-meter, Semi Anechoic Chamber. The EUT system was placed on a nonconductive turntable which is 0.8 or 1.5 meters height (below 1 GHz use 0.8 m turntable / above 1 GHz use 1.5 m turntable), top surface 1.0 x 1.5 meter. The spectrum was examined from 250 MHz to 2.5 GHz in order to cover the whole spectrum below 10th harmonic which could generate from the EUT. During the test, EUT was set to transmit continuously & Measurements spectrum range from 9 kHz to 40 GHz is investigated.

For measurements below 30 MHz the resolution bandwidth is set to 10 kHz for peak detection measurements or 9 kHz for quasi-peak detection measurements. The video bandwidth is 3 times of the resolution bandwidth.

For measurements below 1 GHz the resolution bandwidth is set to 100 kHz for peak detection measurements or 120 kHz for quasi-peak detection measurements. Peak detection is used unless otherwise noted as quasi-peak.

For restricted measurements above 1 GHz the resolution bandwidth is set to 1 MHz, and then the video bandwidth is set to 3 MHz for peak measurements and 10 Hz for average measurements when Duty cycle > 0.98 / 1/T for average measurements when Duty cycle < 0.98.

For out of band measurements above 1 GHz the resolution bandwidth is set to 1 MHz, and then the video bandwidth is set to 3 MHz for peak measurements.

A nonconductive material surrounded the EUT to supporting the EUT for standing on three orthogonal planes. At each condition, the EUT was rotated 360 degrees, and the antenna was raised and lowered from one to four meters to find the maximum emission levels. Measurements were taken using both horizontal and vertical antenna polarization.

SCHWARZBECK MESS-ELEKTRONIK Trilog-Broadband Antenna at 3 Meter and the ETS-Lindgren Double-Ridged Waveguide Horn antenna Schwarzbeck Mess-Elektronik Broadband Horn Antenna was used in frequencies 1 – 40 GHz at a distance of 3 meter. The antenna at an angle toward the source of the emission. All test results were extrapolated to equivalent signal at 3 meters utilizing an inverse linear distance extrapolation Factor (20 dB/decade).

For testing above 1 GHz, the emission level of the EUT in peak mode was 20 dB lower than average limit (that means the emission level in peak mode also complies with the limit in average mode), then testing will be stopped and peak values of EUT will be reported, otherwise, the emissions will be measured in average mode again and reported.

Appropriate preamplifiers were used for improving sensitivity and precautions were taken to avoid overloading or desensitizing the spectrum analyzer. No post – detector video filters were used in the test.

The spectrum analyzer's 6 dB bandwidth was set to 1 MHz, and the analyzer was operated in the peak detection mode, for frequencies both below and up 1 GHz. The average levels were obtained by subtracting the duty cycle correction factor from the peak readings.

The following procedures were used to convert the emission levels measured in decibels referenced to 1 microvolt (dBuV) into field intensity in micro volts per meter (uV/m).

The actual field intensity in decibels referenced to 1 microvolt in to field intensity in micro volts per meter (dBuV/m).

Data of measurement within this frequency range without mark in the table above means the reading of emissions are attenuated more than 20 dB below the permissible limits or the field strength is too small to be measured.

The actual field intensity in referenced to 1 microvolt per meter (dBuV/m) is determined by algebraically adding the measured reading in dBuV, the antenna factor (dB), and cable loss (dB) and Subtracting the gain of preamplifier (dB) is auto calculate in spectrum analyzer.

(1)  $\text{Amplitude (dBuV/m)} = \text{FI (dBuV)} + \text{AF (dBuV)} + \text{CL (dBuV)} - \text{Gain (dB)}$

FI= Reading of the field intensity.

AF= Antenna factor.

CL= Cable loss.

P.S Amplitude is auto calculate in spectrum analyzer.

(2)  $\text{Actual Amplitude (dBuV/m)} = \text{Amplitude (dBuV)} - \text{Dis(dB)}$

The FCC specified emission limits were calculated according the EUT operating frequency and by following linear interpolation equations:

(a) For fundamental frequency : Transmitter Output < +30 dBm

(b) For spurious frequency : Spurious emission limits = fundamental emission limit /10

### Measuring Instruments and setting

The following table is the setting of spectrum analyzer and receiver.

Spectrum Parameter	Setting
Attenuation	Auto
Start Frequency	1000 MHz
Stop Frequency	40 GHz
RBW/VBW(Emission in restricted band)	1 MHz / 3 MHz for Peak 1 MHz / (1/T) for Average
RBW/VBW(Emission in non-restricted band)	1 MHz / 3 MHz for Peak

### 4.3. Maximum Conducted Output Power Measurement

■ Limit

Frequency Range (MHz)	FCC Maximum Conducted Output Power Limit
	Client
5.150 ~ 5.250 GHz	The lesser of 250 mW (24 dBm)
5.250 ~ 5.350 GHz	The lesser of 250 mW (24 dBm) or 11 dBm + 10 log (B)
5.470 ~ 5.725 GHz	The lesser of 250 mW (24 dBm) or 11 dBm + 10 log (B)
5.725 ~ 5.850 GHz	The lesser of 1 W (30 dBm)

According FCC KDB 662911 D01 v02r01 – for power measurements on IEEE802.11 devices,



### ■ Test Setup

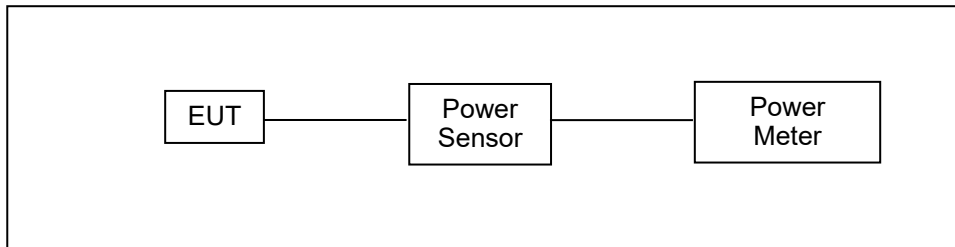

### ■ Test Procedure

The test is performed in accordance with ANSI C63.10:2013 section 12.3.3.2, Guidelines for Compliance Testing of Unlicensed National Information Infrastructure (U-NII) Devices

Section (E) Maximum Conducted Output Power

3. Measurement using a Power Meter (PM)

b) Method PM-G (Measurement using a gated RF average power meter)

#### 4.4. 26 dB RF Bandwidth Measurement

■ **Limit**

N/A

■ **Test Setup**

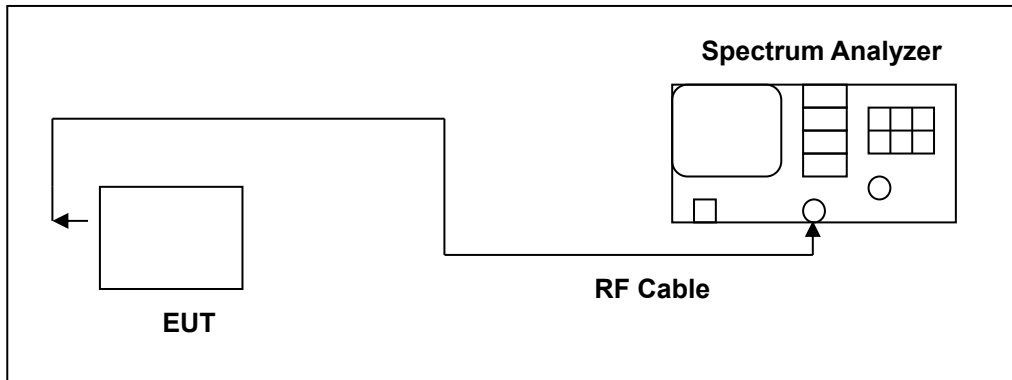

■ **Test Procedure**

The test is performed in accordance with ANSI C63.10:2013 section 12.4.1, Guidelines for Compliance Testing of Unlicensed National Information Infrastructure (U-NII) Devices - Part 15, Subpart E.

Spectrum Parameter	Setting
Attenuation	Auto
Span Frequency	>26 dB Bandwidth
RBW	Approximately 1 % of the emission bandwidth
VBW	VBW > RBW
Detector	Peak
Trace	Max Hold
Sweep Time	Auto

## 4.5. 6 dB RF Bandwidth Measurement

- **Limit**

- **6 dB RF Bandwidth**

Systems using digital modulation techniques may operate in the 5725~5825 MHz bands. The minimum 6 dB bandwidth shall be at least 500 kHz.

- **Test Setup**

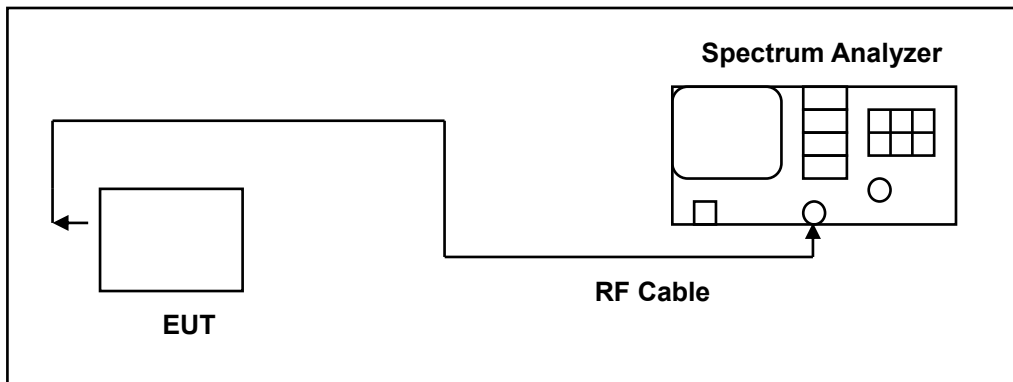

- **Test Procedure**

- **6 dB RF Bandwidth**

The EUT tested to UNII test procedure of ANSI C63.10:2013 section 6.9.2 for compliance to FCC 47CFR 15.407 requirements.

The antenna port of the EUT was connected to the input of a spectrum analyzer. Analyzer RES BW was set to 100 kHz. For each RF output channel investigated, the spectrum analyzer center frequency was set to the channel carrier. A peak output reading was taken, a DISPLAY line was drawn 6 dB lower than peak level. The 6 dB bandwidth was determined from where the channel output spectrum intersected the display line.

The test was performed at 3 channels.

## 4.6. Maximum Power Spectral Density Measurement

■ Limit

Frequency Range (MHz)	FCC Limit
	Client
5.150 ~ 5.250 GHz	11 dBm/MHz
5.250 ~ 5.350 GHz	11 dBm/MHz
5.470 ~ 5.725 GHz	11 dBm/MHz
5.725 ~ 5.850 GHz	30 dBm/500 kHz

According FCC KDB 662911 D01 v02r01 – for power spectral density measurements on IEEE802.11 devices,

■ Test Setup

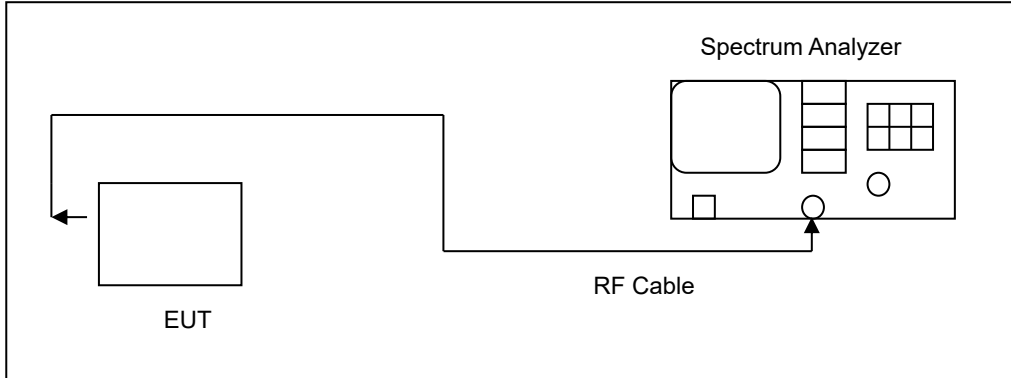

■ Test Procedure

The test is performed in accordance with ANSI C63.10:2013 section 12.5, Guidelines for Compliance Testing of Unlicensed National Information Infrastructure (U-NII) Devices - Part 15, Subpart E.

Spectrum Parameter	Setting
Attenuation	Auto
Span Frequency	Encompass the entire emissions bandwidth (EBW) of the signal
RBW	1 MHz (5725 ~ 5850 MHz use 100 kHz)
VBW	3 MHz (5725 ~ 5850 MHz use 300 kHz)
Detector	RMS
Trace	AVERAGE
Sweep Time	Auto
Trace Average	100 times
Note: If measurement bandwidth of Maximum PSD is specified in 500 kHz, add $10 \log(500 \text{ kHz}/100 \text{ kHz})$ to the measured result.	

#### 4.7. Automatically discontinue transmission

The device shall automatically discontinue transmission in case of either absence of information to transmit or operational failure. These provisions are not intended to preclude the transmission of control or signalling information or the use of repetitive codes used by certain digital technologies to complete frame or burst intervals. Applicants shall include in their application for equipment authorization a description of how this requirement is met.

- **Declare**

While the EUT is not transmitting any information, the EUT can automatically discontinue transmission and become standby mode for power saving.

The EUT can detect the controlling signal of ACK message transmitting from remote device and verify whether it shall resend or discontinue transmission.

## 4.8. Antenna Requirement

### ■ Requirement

For intentional device, according to 15.203, an intentional radiator shall be designed to ensure that no antenna other than that furnished by the responsible party shall be used with the device.

And According to 15.407 (a), if transmitting antennas of directional gain greater than 6 dBi are used, the power shall be reduced by the amount in dB that the directional gain of the antenna exceeds 6 dBi.

### ■ Antenna Connector Construction

See section 2 – antenna information.

### ■ Directional Gain Calculated

Test mode	Band	Transmission Type	Antenna				Directional Gain For Power (dBi)	Directional Gain For PSD (dBi)	Power Limit Reduction (dB)	PSD Limit Reduction (dB)
			ANT-0 (dBi)	ANT-1 (dBi)	ANT-2 (dBi)	ANT-3 (dBi)				
802.11a	Band 1	Ant-0	5.50	-	-	-	5.50	5.50	0.00	0.00
	Band 2-A		5.50	-	-	-	5.50	5.50	0.00	0.00
	Band 2-C		5.50	-	-	-	5.50	5.50	0.00	0.00
	Band 3		5.50	-	-	-	5.50	5.50	0.00	0.00
802.11n HT20 802.11n HT40 802.11ac VHT20 802.11ac VHT40 802.11ac VHT80	Band 1	Ant-0	5.50	-	-	-	5.50	5.50	0.00	0.00
	Band 2-A		5.50	-	-	-	5.50	5.50	0.00	0.00
	Band 2-C		5.50	-	-	-	5.50	5.50	0.00	0.00
	Band 3		5.50	-	-	-	5.50	5.50	0.00	0.00

## 5 Test Results

### 5.1. Conducted Emission

Standard:	FCC Part 15.407	Line:	L1
Test item:	Conducted Emission	Power:	AC 120 V/60 Hz
Test Mode:	Transmit mode		
Description:			



Rg	Frequency [MHz]	QP Result [dBµV]	QP Limit [dBµV]	QP Margin [dB]	AV Result [dBµV]	AV Limit [dBµV]	AV Margin [dB]	Correction factor [dB]	Line
1	0.420	45.35	57.45	12.09	39.58	47.45	7.87	9.65	L1
1	0.749	38.00	56.00	18.00	30.33	46.00	15.67	9.67	L1
1	0.753	37.84	56.00	18.16	29.63	46.00	16.37	9.67	L1
1	1.770	31.76	56.00	24.24	21.49	46.00	24.51	9.71	L1
1	7.143	34.68	60.00	25.32	23.29	50.00	26.71	9.86	L1
1	23.924	43.84	60.00	16.16	34.58	50.00	15.42	10.14	L1

Note: 1. Result (dBuV) = Correction factor (dB) + Reading(dBuV).

2. Correction factor (dB) = Cable loss (dB) + L.I.S.N. factor (dB).



Standard:	FCC Part 15.407	Line:	N
Test item:	Conducted Emission	Power:	AC 120 V/60 Hz
Test Mode:	Transmit mode		
Description:			

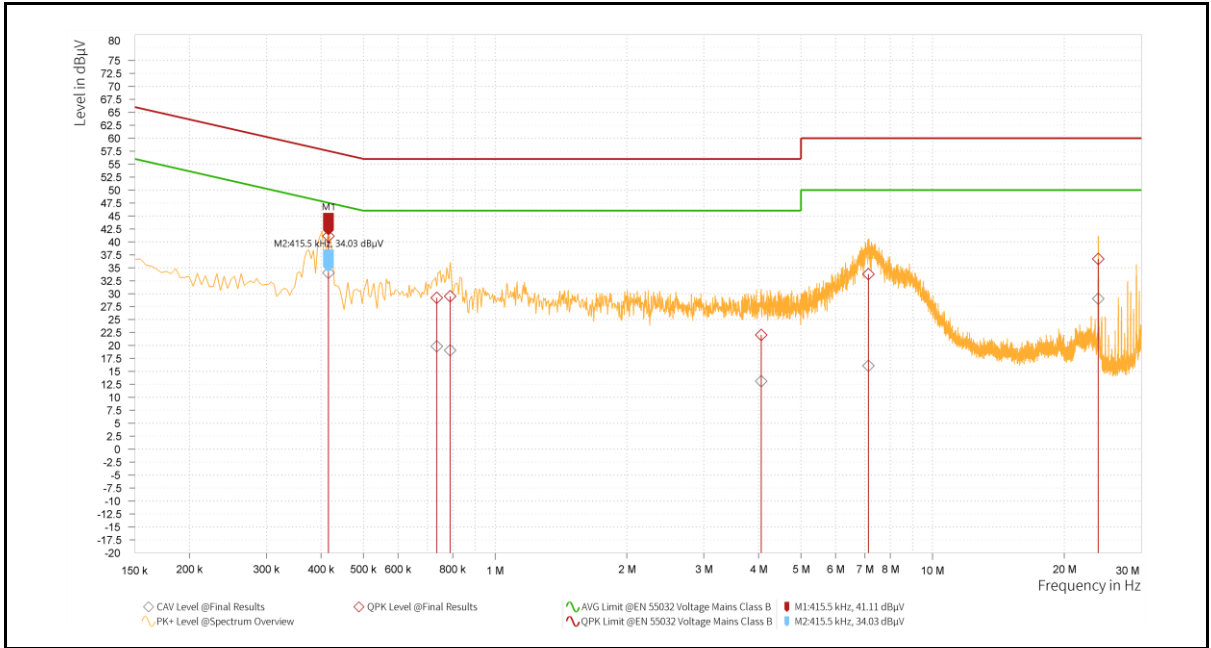

Rg	Frequency [MHz]	QP Result [dBµV]	QP Limit [dBµV]	QP Margin [dB]	AV Result [dBµV]	AV Limit [dBµV]	AV Margin [dB]	Correction factor [dB]	Line
1	0.416	41.11	57.54	16.42	34.03	47.54	13.51	9.65	N
1	0.735	29.18	56.00	26.82	19.84	46.00	26.16	9.67	N
1	0.789	29.51	56.00	26.49	19.06	46.00	26.94	9.67	N
1	4.056	22.06	56.00	33.94	13.12	46.00	32.88	9.79	N
1	7.130	33.78	60.00	26.22	16.11	50.00	33.89	9.88	N
1	23.924	36.71	60.00	23.29	29.03	50.00	20.97	10.27	N

Note: 1. Result (dBuV) = Correction factor (dB) + Reading(dBuV).

2. Correction factor (dB) = Cable loss (dB) + L.I.S.N. factor (dB).

## 5.2. Radiated Emission Measurement

Below 1 GHz

Test Site:	96603-WG	Standard:	Part 15.407
Test Mode:	Transmit mode		
Polarization:	Horizontal		
Remark:			

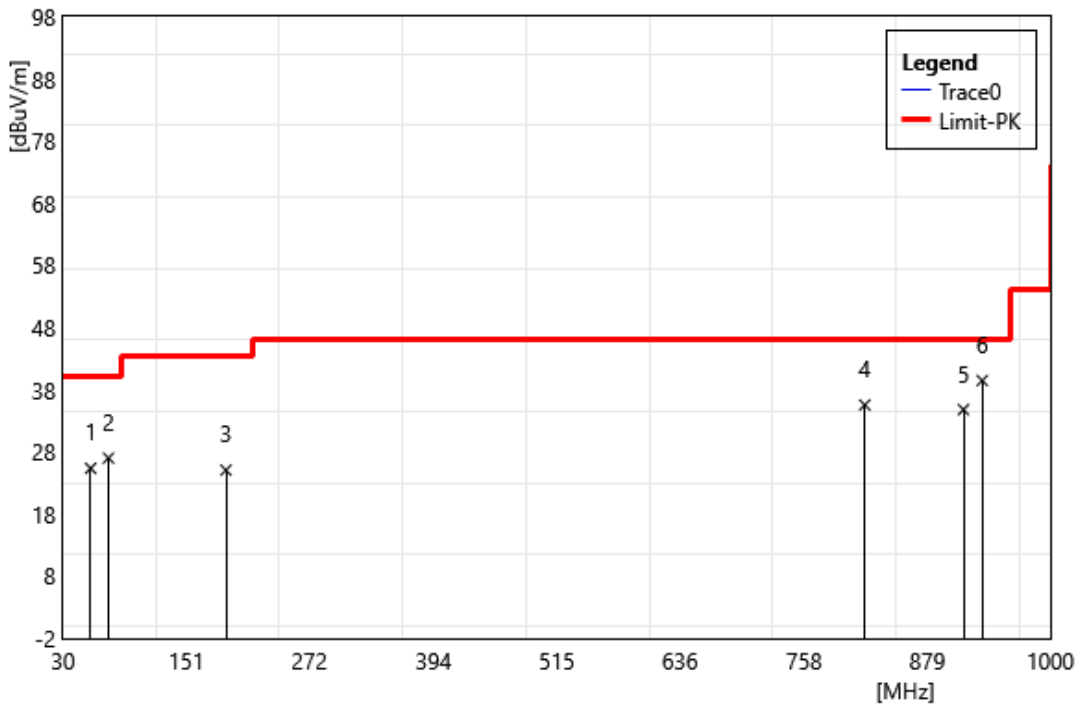

ID	Frequency MHz	Reading dBuV	Correct Factor dB/m	Result dBuV/m	Limit dBuV/m	Margin dB	Remark
1	57.16	37.67	-12.31	25.36	40.00	-14.64	QP
2	74.62	42.40	-15.39	27.01	40.00	-12.99	QP
3	190.05	39.81	-14.73	25.08	43.50	-18.42	QP
4	817.64	37.62	-2.07	35.55	46.00	-10.45	QP
5	914.64	35.24	-0.44	34.80	46.00	-11.20	QP
6	933.07	39.49	0.00	39.49	46.00	-6.51	QP

Test Site:	96603-WG	Standard:	Part 15.407
Test Mode:	Transmit mode		
Polarization:	Vertical		
Remark:			

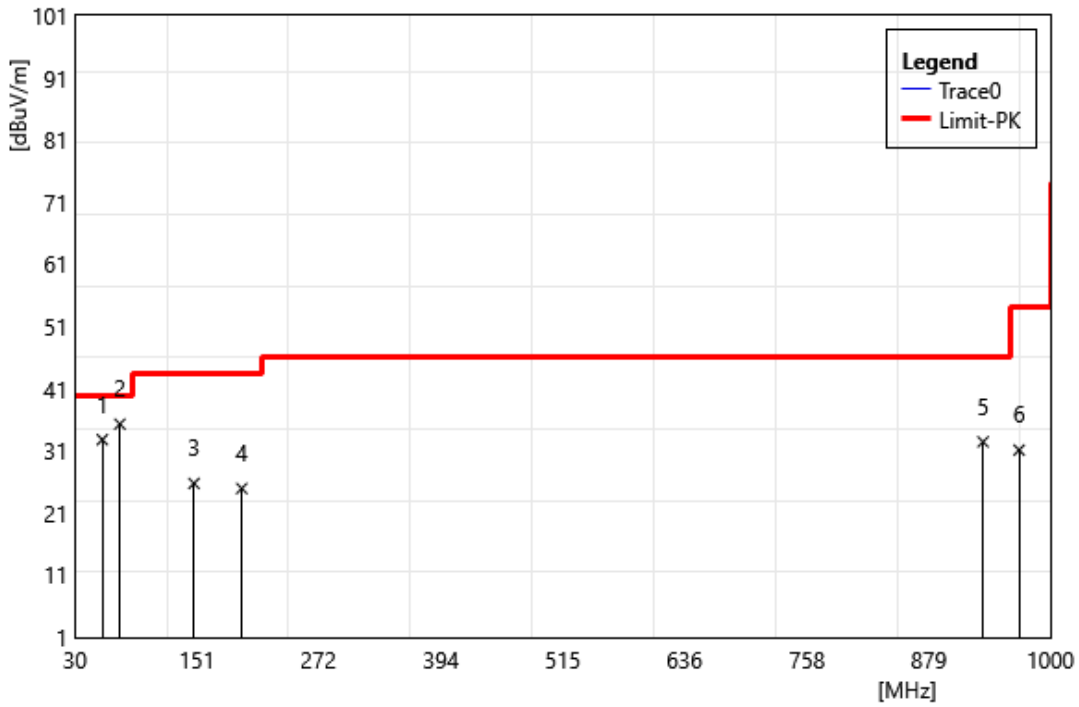

ID	Frequency MHz	Reading dBuV	Correct Factor dB/m	Result dBuV/m	Limit dBuV/m	Margin dB	Remark
1	57.16	45.11	-12.31	32.80	40.00	-7.20	QP
2	74.62	50.70	-15.39	35.31	40.00	-4.69	QP
3	148.34	37.99	-12.22	25.77	43.50	-17.73	QP
4	195.87	40.07	-15.12	24.95	43.50	-18.55	QP
5	933.07	32.46	0.00	32.46	46.00	-13.54	QP
6	968.96	31.20	-0.07	31.13	54.00	-22.87	QP

Harmonic

Above 1 GHz

Test Site:	96603-WG	Standard:	Part 15.407
Test Mode:	802.11a 5180 MHz		
Polarization:	Horizontal		
Remark:			

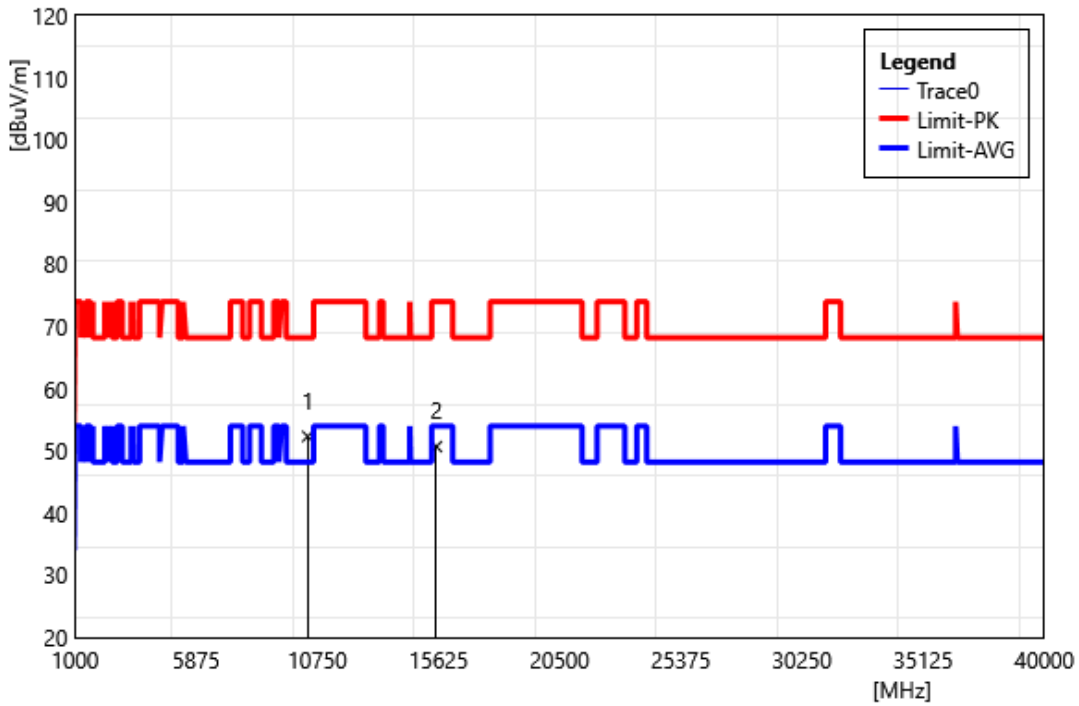

ID	Frequency MHz	Reading dBuV	Correct Factor dB/m	Result dBuV/m	Limit dBuV/m	Margin dB	Remark
1	10360.00	44.95	7.37	52.32	68.20	-15.88	PEAK
2	15540.00	41.19	9.50	50.69	74.00	-23.31	PEAK

Test Site:	96603-WG	Standard:	Part 15.407
Test Mode:	802.11a 5180 MHz		
Polarization:	Vertical		
Remark:			

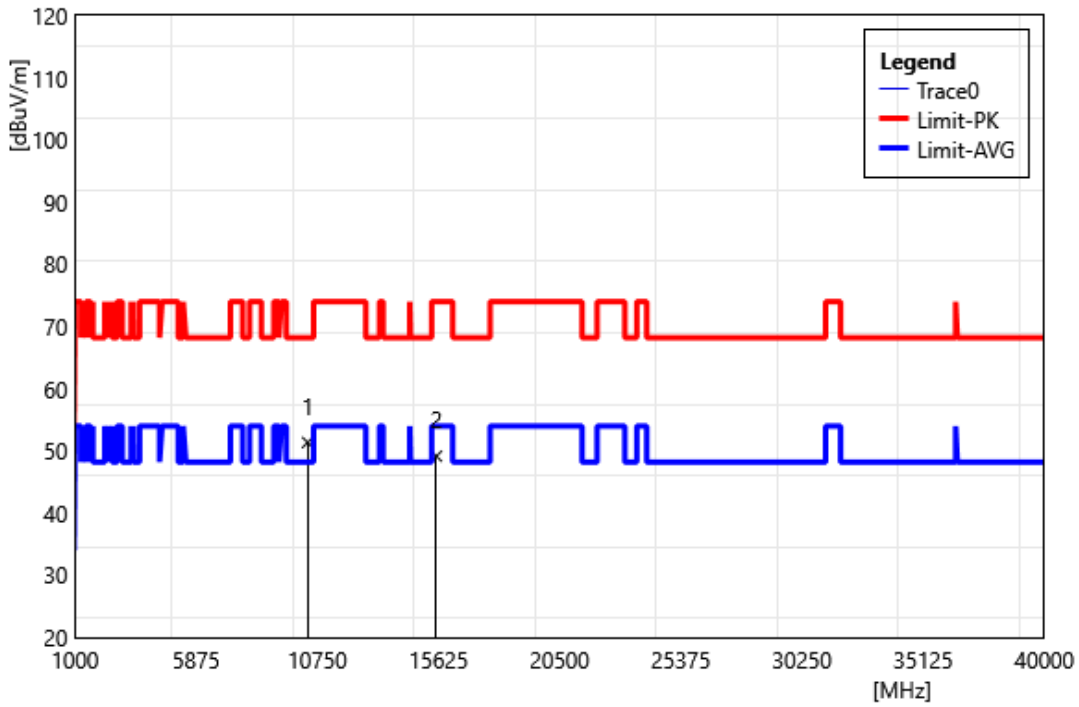

ID	Frequency MHz	Reading dBuV	Correct Factor dB/m	Result dBuV/m	Limit dBuV/m	Margin dB	Remark
1	10360.00	43.98	7.37	51.35	68.20	-16.85	PEAK
2	15540.00	39.65	9.50	49.15	74.00	-24.85	PEAK

Test Site:	96603-WG	Standard:	Part 15.407
Test Mode:	802.11a 5200 MHz		
Polarization:	Horizontal		
Remark:			

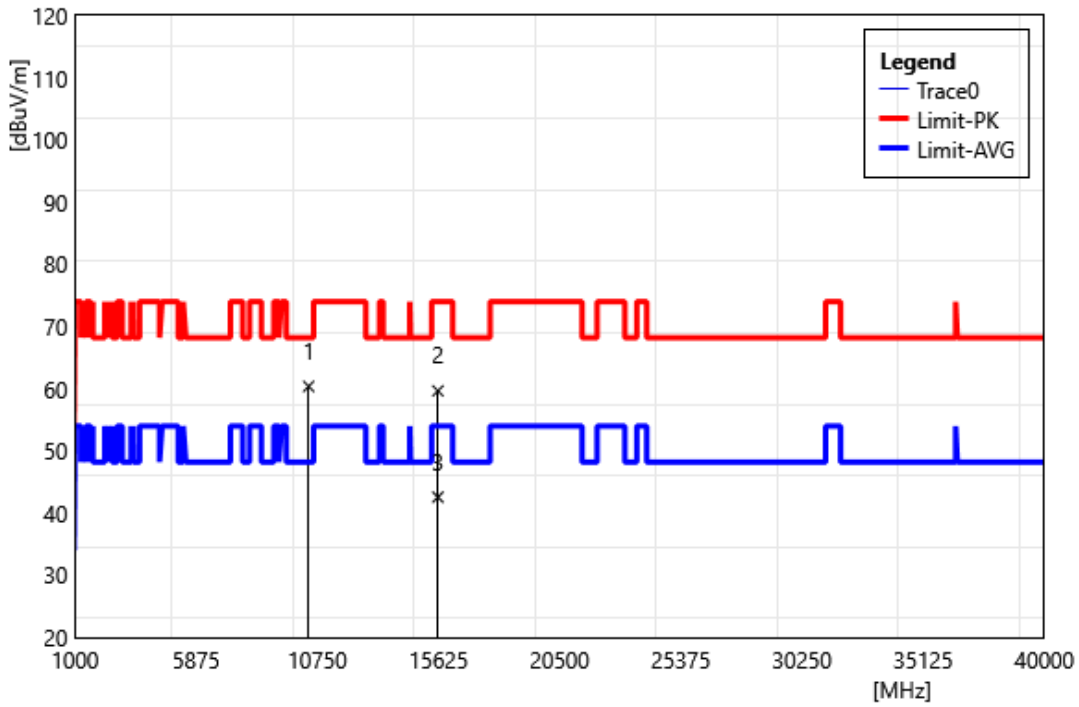

ID	Frequency MHz	Reading dBuV	Correct Factor dB/m	Result dBuV/m	Limit dBuV/m	Margin dB	Remark
1	10400.00	52.90	7.47	60.37	68.20	-7.83	PEAK
2	15600.00	50.34	9.33	59.67	74.00	-14.33	PEAK
3	15600.00	33.23	9.33	42.56	54.00	-11.44	AVG

Test Site:	96603-WG	Standard:	Part 15.407
Test Mode:	802.11a 5200 MHz		
Polarization:	Vertical		
Remark:			

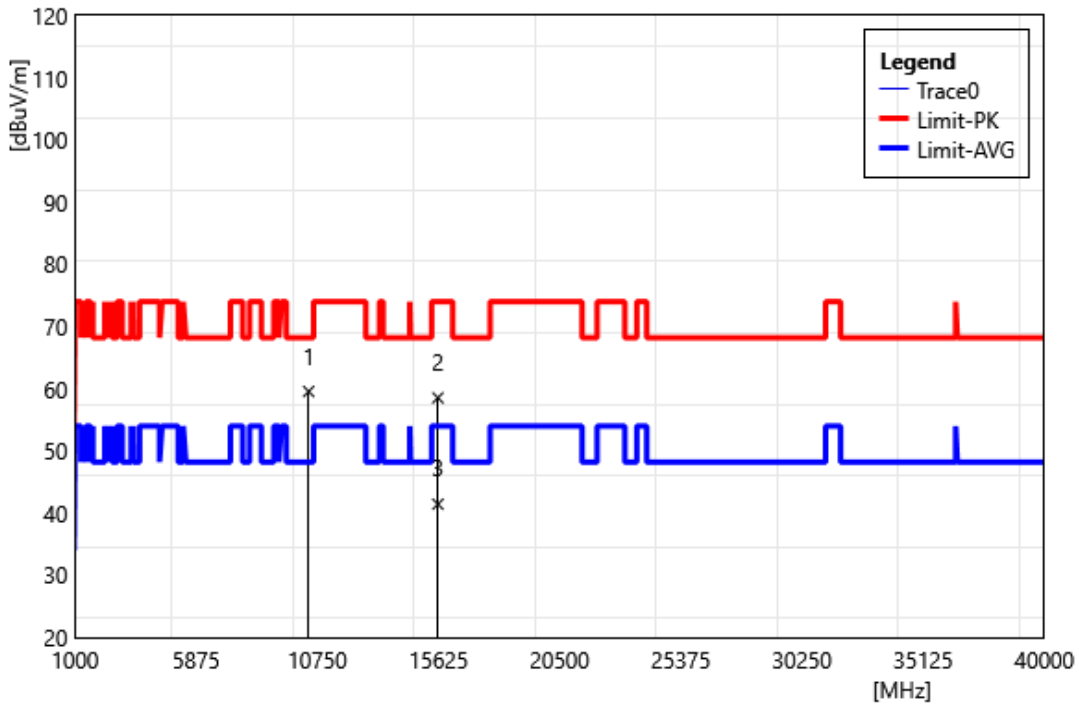

ID	Frequency MHz	Reading dBuV	Correct Factor dB/m	Result dBuV/m	Limit dBuV/m	Margin dB	Remark
1	10400.00	52.08	7.47	59.55	68.20	-8.65	PEAK
2	15600.00	49.19	9.33	58.52	74.00	-15.48	PEAK
3	15600.00	32.11	9.33	41.44	54.00	-12.56	AVG

Test Site:	96603-WG	Standard:	Part 15.407
Test Mode:	802.11a 5240 MHz		
Polarization:	Horizontal		
Remark:			

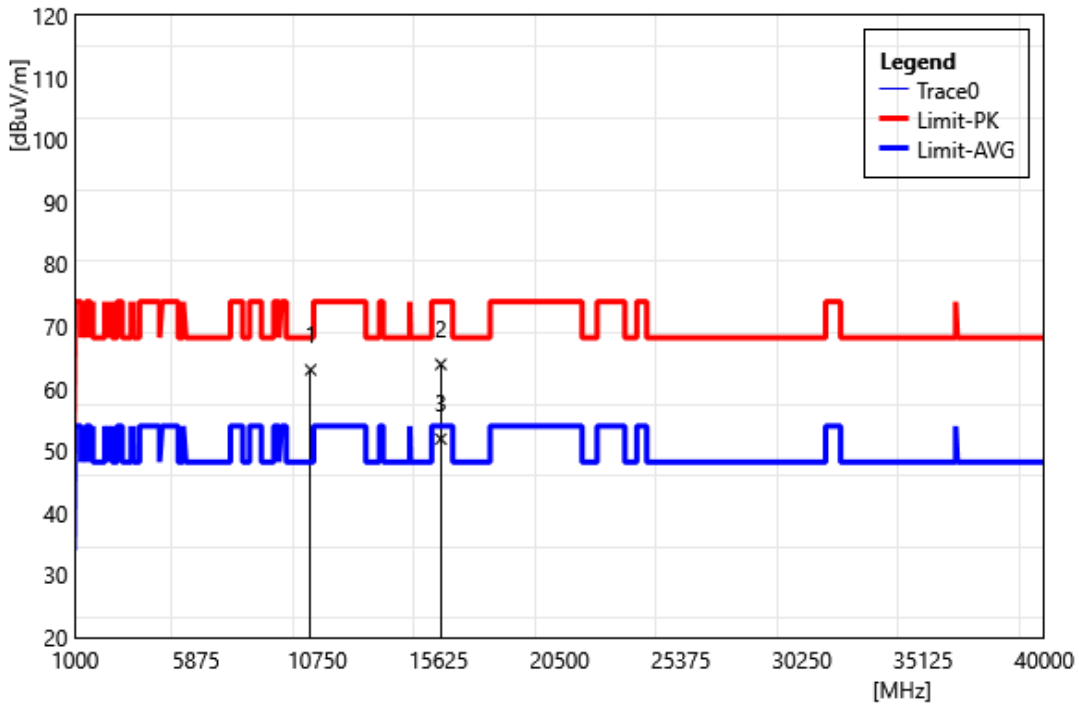

ID	Frequency MHz	Reading dBuV	Correct Factor dB/m	Result dBuV/m	Limit dBuV/m	Margin dB	Remark
1	10480.00	55.49	7.54	63.03	68.20	-5.17	PEAK
2	15720.00	54.21	9.71	63.92	74.00	-10.08	PEAK
3	15720.00	42.19	9.71	51.90	54.00	-2.10	AVG



Test Site:	96603-WG	Standard:	Part 15.407
Test Mode:	802.11a 5240 MHz		
Polarization:	Vertical		
Remark:			

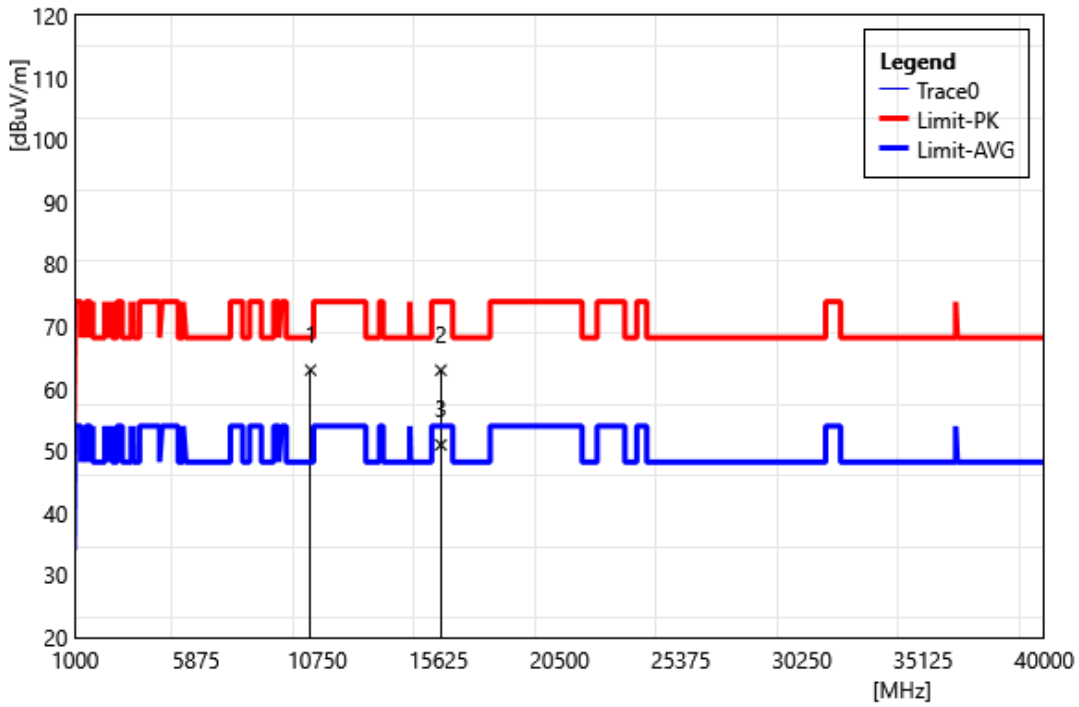

ID	Frequency MHz	Reading dBuV	Correct Factor dB/m	Result dBuV/m	Limit dBuV/m	Margin dB	Remark
1	10480.00	55.45	7.54	62.99	68.20	-5.21	PEAK
2	15720.00	53.26	9.71	62.97	74.00	-11.03	PEAK
3	15720.00	41.26	9.71	50.97	54.00	-3.03	AVG

Test Site:	96603-WG	Standard:	Part 15.407
Test Mode:	802.11a 5260 MHz		
Polarization:	Horizontal		
Remark:			

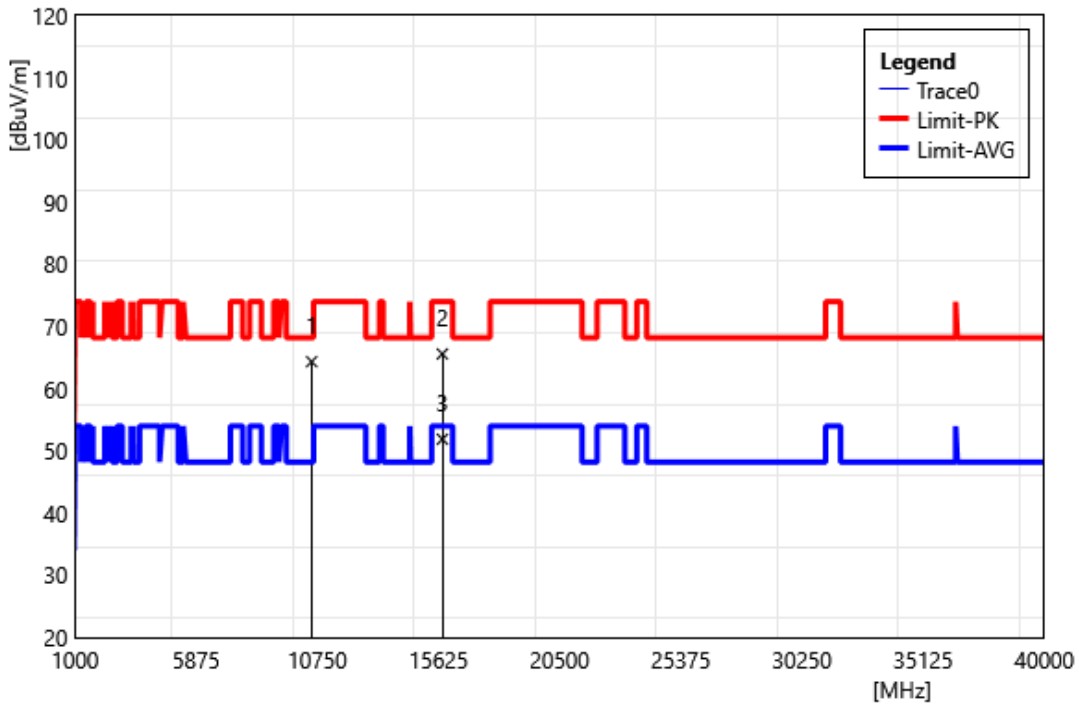

ID	Frequency MHz	Reading dBuV	Correct Factor dB/m	Result dBuV/m	Limit dBuV/m	Margin dB	Remark
1	10520.00	56.84	7.50	64.34	68.20	-3.86	PEAK
2	15780.00	55.73	9.86	65.59	74.00	-8.41	PEAK
3	15780.00	42.02	9.86	51.88	54.00	-2.12	AVG

Test Site:	96603-WG	Standard:	Part 15.407
Test Mode:	802.11a 5260 MHz		
Polarization:	Vertical		
Remark:			

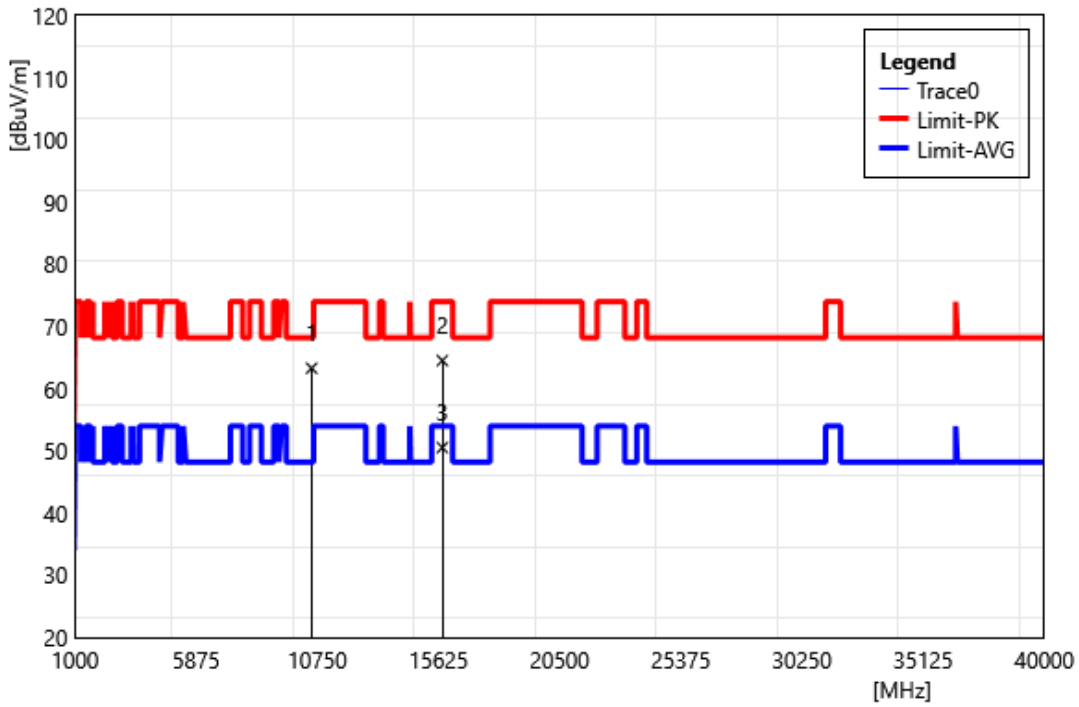

ID	Frequency MHz	Reading dBuV	Correct Factor dB/m	Result dBuV/m	Limit dBuV/m	Margin dB	Remark
1	10520.00	55.79	7.50	63.29	68.20	-4.91	PEAK
2	15780.00	54.67	9.86	64.53	74.00	-9.47	PEAK
3	15780.00	40.67	9.86	50.53	54.00	-3.47	AVG

Test Site:	96603-WG	Standard:	Part 15.407
Test Mode:	802.11a 5280 MHz		
Polarization:	Horizontal		
Remark:			

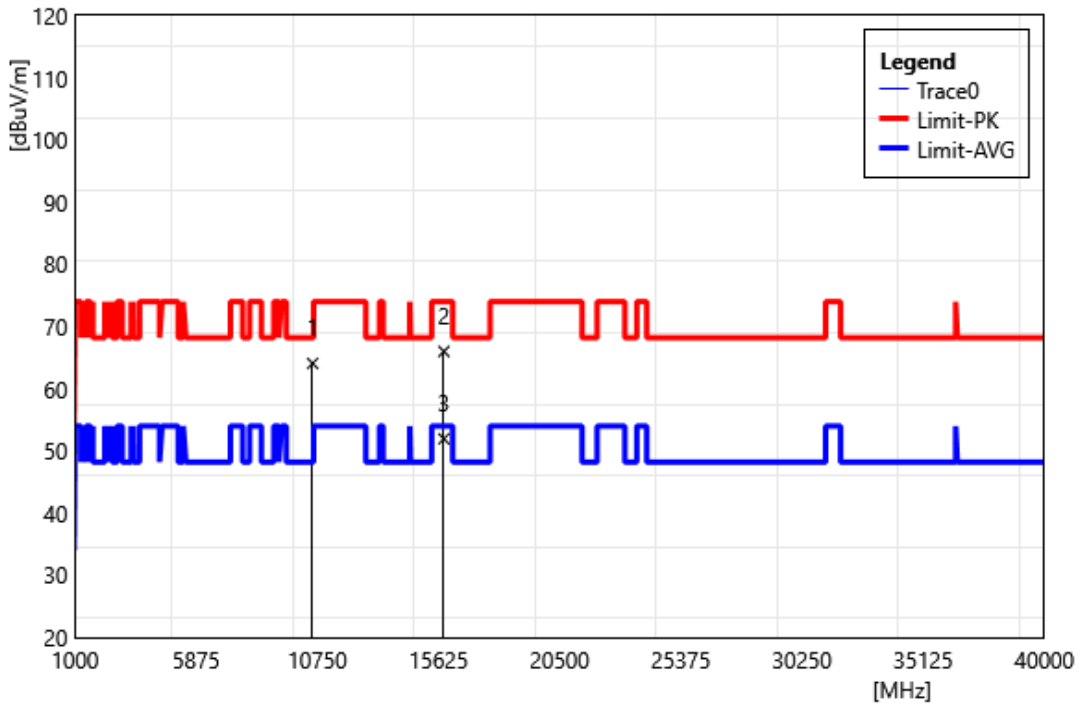

ID	Frequency MHz	Reading dBuV	Correct Factor dB/m	Result dBuV/m	Limit dBuV/m	Margin dB	Remark
1	10560.00	56.61	7.45	64.06	68.20	-4.14	PEAK
2	15840.00	56.12	9.87	65.99	74.00	-8.01	PEAK
3	15840.00	42.07	9.87	51.94	54.00	-2.06	AVG

Test Site:	96603-WG	Standard:	Part 15.407
Test Mode:	802.11a 5280 MHz		
Polarization:	Vertical		
Remark:			

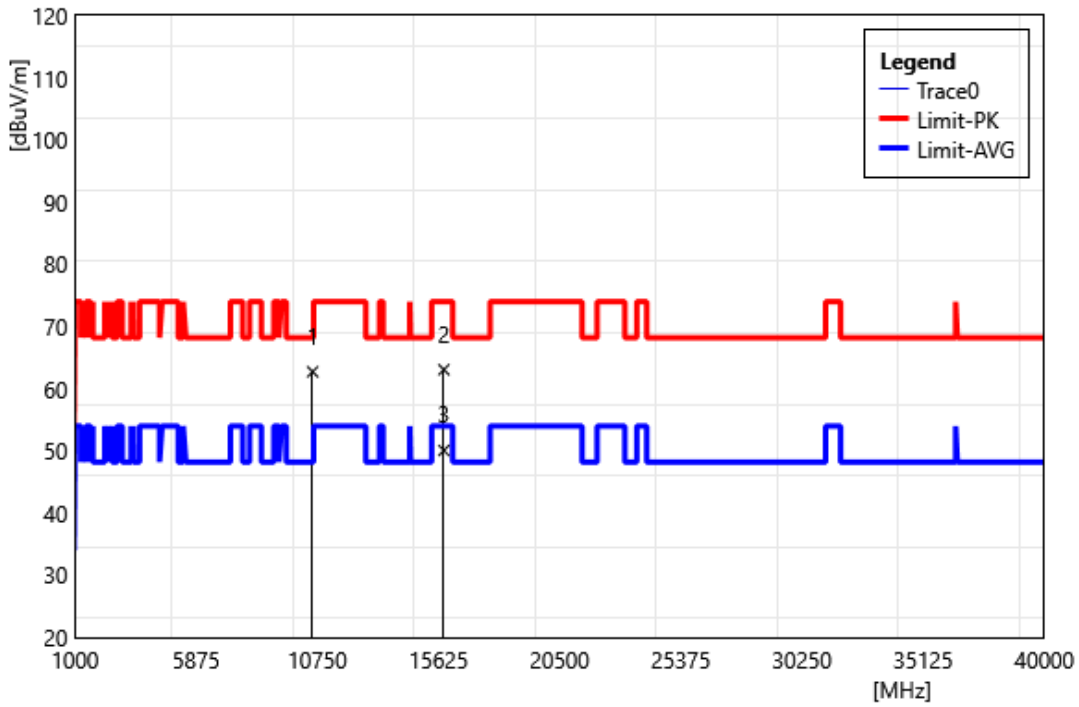

ID	Frequency MHz	Reading dBuV	Correct Factor dB/m	Result dBuV/m	Limit dBuV/m	Margin dB	Remark
1	10560.00	55.28	7.45	62.73	68.20	-5.47	PEAK
2	15840.00	53.20	9.87	63.07	74.00	-10.93	PEAK
3	15840.00	40.20	9.87	50.07	54.00	-3.93	AVG

Test Site:	96603-WG	Standard:	Part 15.407
Test Mode:	802.11a 5320 MHz		
Polarization:	Horizontal		
Remark:			

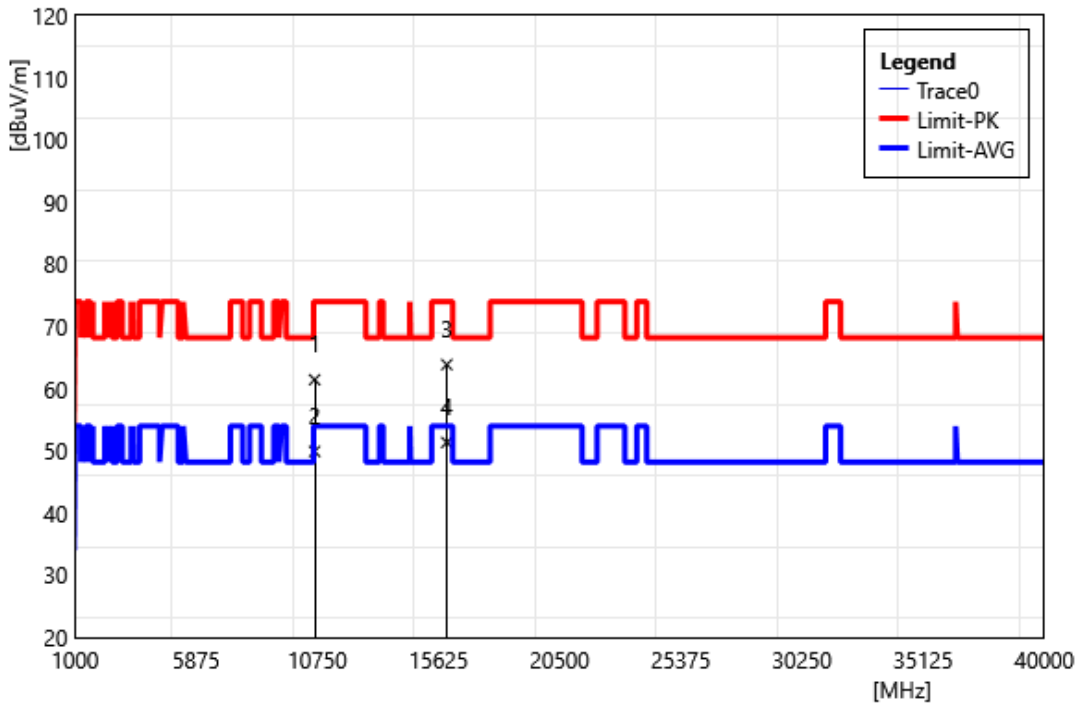

ID	Frequency MHz	Reading dBuV	Correct Factor dB/m	Result dBuV/m	Limit dBuV/m	Margin dB	Remark
1	10640.00	54.05	7.39	61.44	74.00	-12.56	PEAK
2	10640.00	42.53	7.39	49.92	54.00	-4.08	AVG
3	15960.00	53.90	9.98	63.88	74.00	-10.12	PEAK
4	15960.00	41.38	9.98	51.36	54.00	-2.64	AVG

Test Site:	96603-WG	Standard:	Part 15.407
Test Mode:	802.11a 5320 MHz		
Polarization:	Vertical		
Remark:			

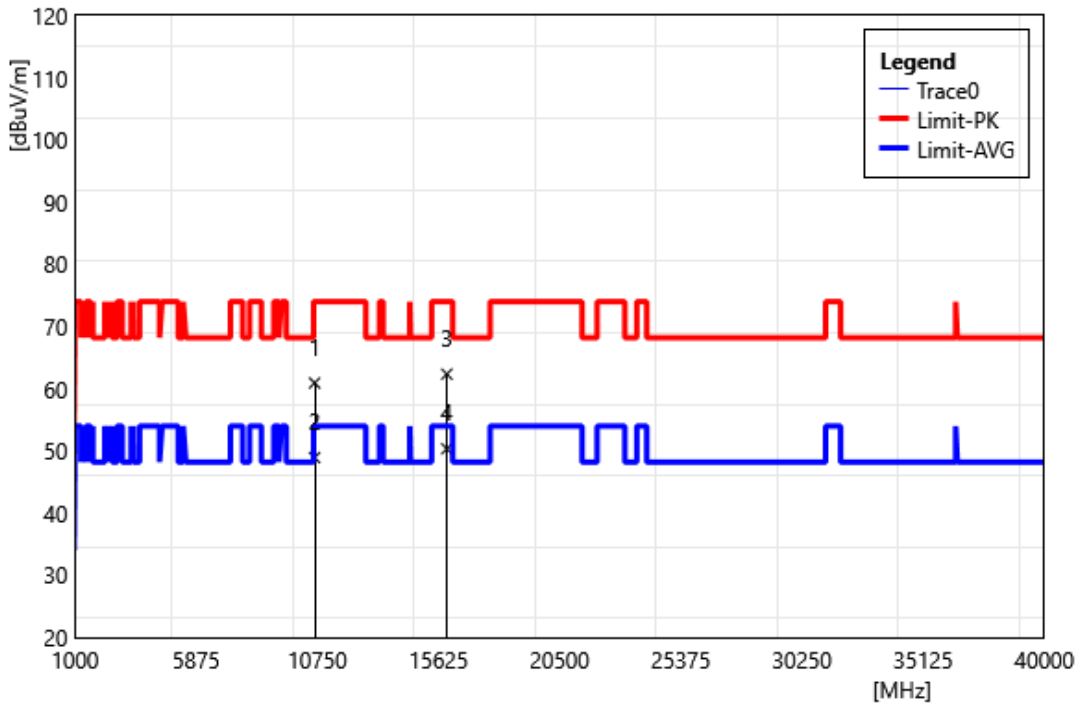

ID	Frequency MHz	Reading dBuV	Correct Factor dB/m	Result dBuV/m	Limit dBuV/m	Margin dB	Remark
1	10640.00	53.53	7.39	60.92	74.00	-13.08	PEAK
2	10640.00	41.53	7.39	48.92	54.00	-5.08	AVG
3	15960.00	52.37	9.98	62.35	74.00	-11.65	PEAK
4	15960.00	40.37	9.98	50.35	54.00	-3.65	AVG

Test Site:	96603-WG	Standard:	Part 15.407
Test Mode:	802.11a 5500 MHz		
Polarization:	Horizontal		
Remark:			

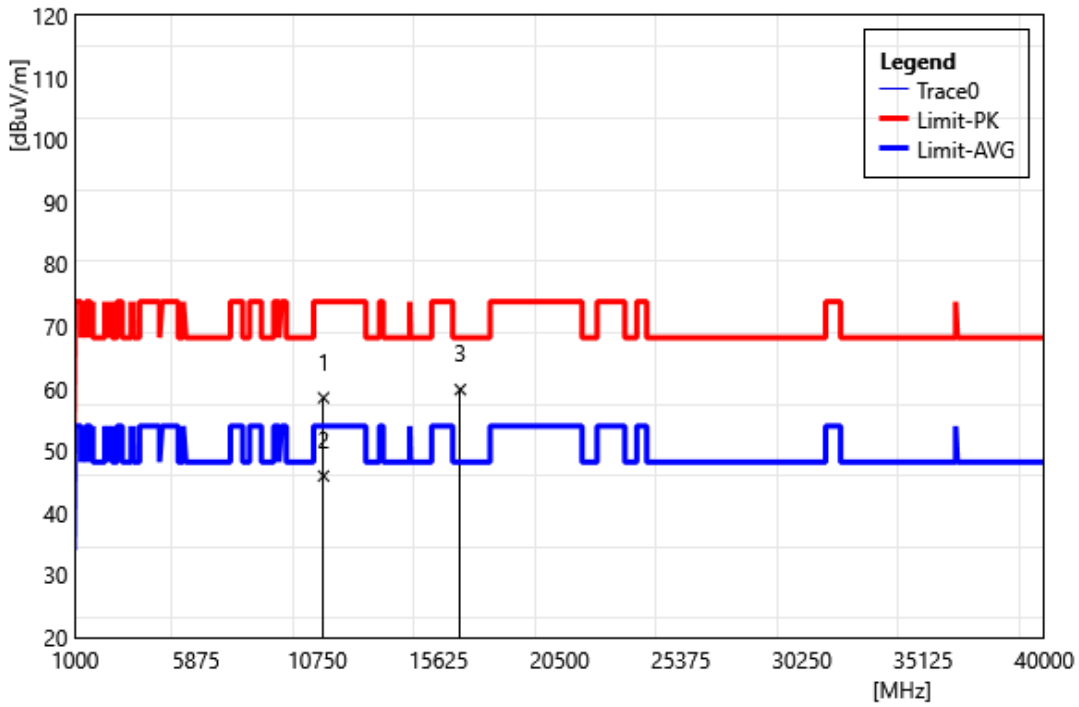

ID	Frequency MHz	Reading dBuV	Correct Factor dB/m	Result dBuV/m	Limit dBuV/m	Margin dB	Remark
1	11000.00	51.20	7.35	58.55	74.00	-15.45	PEAK
2	11000.00	38.61	7.35	45.96	54.00	-8.04	AVG
3	16500.00	50.34	9.51	59.85	68.20	-8.35	PEAK



Test Site:	96603-WG	Standard:	Part 15.407
Test Mode:	802.11a 5500 MHz		
Polarization:	Vertical		
Remark:			

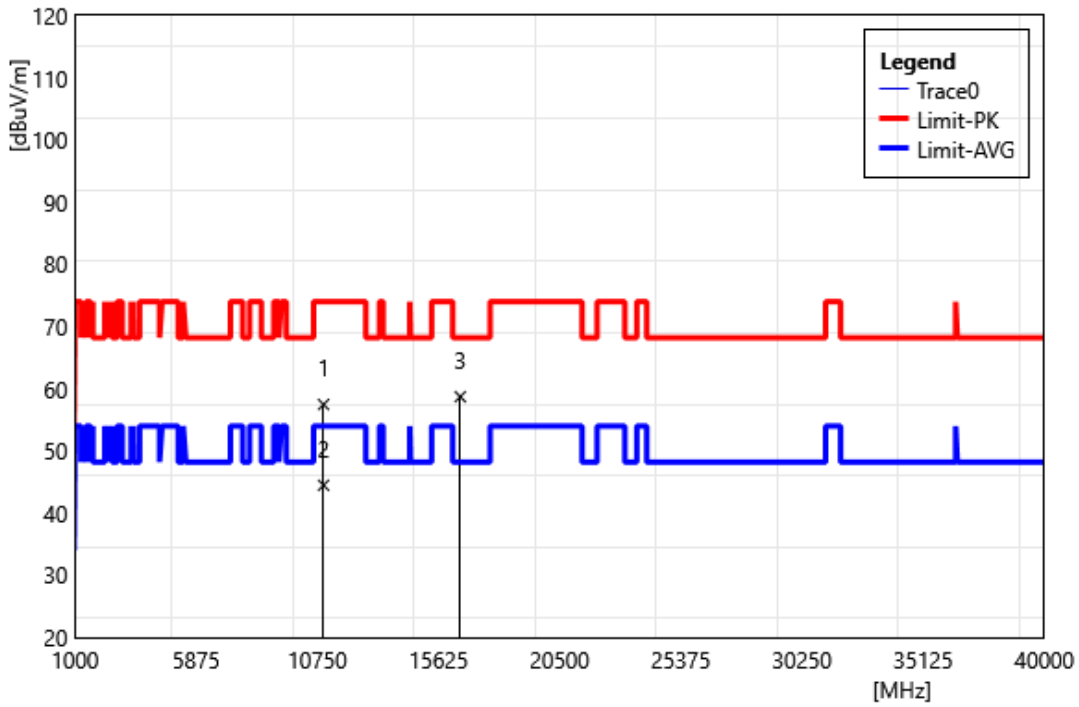

ID	Frequency MHz	Reading dBuV	Correct Factor dB/m	Result dBuV/m	Limit dBuV/m	Margin dB	Remark
1	11000.00	50.12	7.35	57.47	74.00	-16.53	PEAK
2	11000.00	37.12	7.35	44.47	54.00	-9.53	AVG
3	16500.00	49.20	9.51	58.71	68.20	-9.49	PEAK

Test Site:	96603-WG	Standard:	Part 15.407
Test Mode:	802.11a 5560 MHz		
Polarization:	Horizontal		
Remark:			

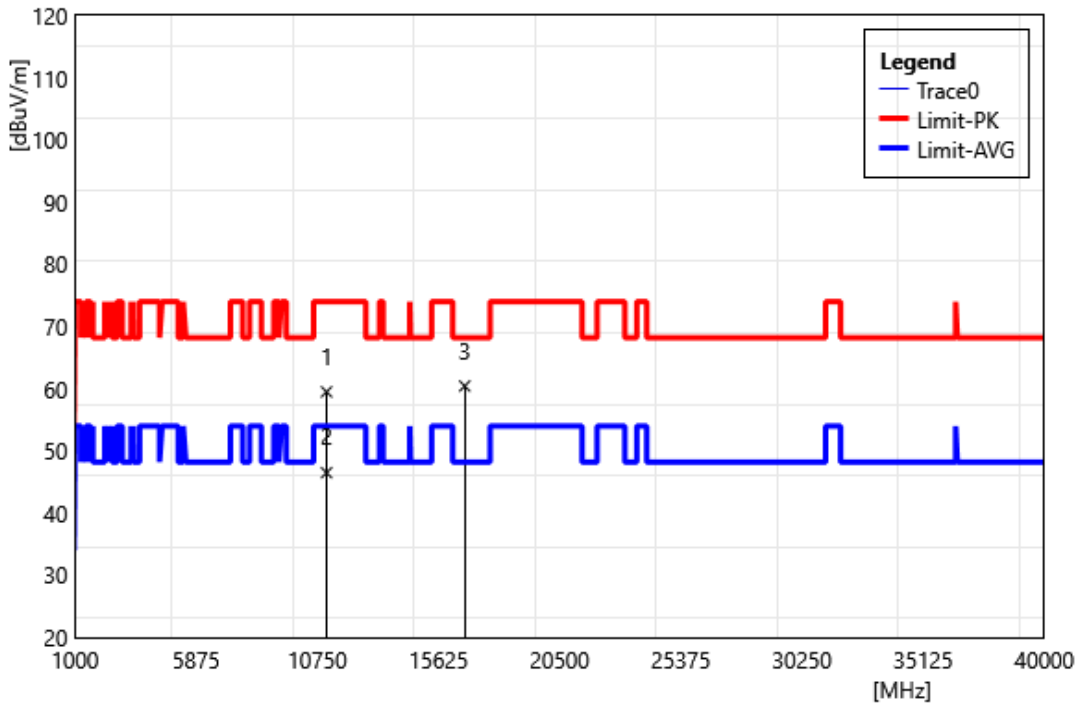

ID	Frequency MHz	Reading dBuV	Correct Factor dB/m	Result dBuV/m	Limit dBuV/m	Margin dB	Remark
1	11120.00	51.69	7.81	59.50	74.00	-14.50	PEAK
2	11120.00	38.69	7.81	46.50	54.00	-7.50	AVG
3	16680.00	51.55	8.88	60.43	68.20	-7.77	PEAK

Test Site:	96603-WG	Standard:	Part 15.407
Test Mode:	802.11a 5560 MHz		
Polarization:	Vertical		
Remark:			

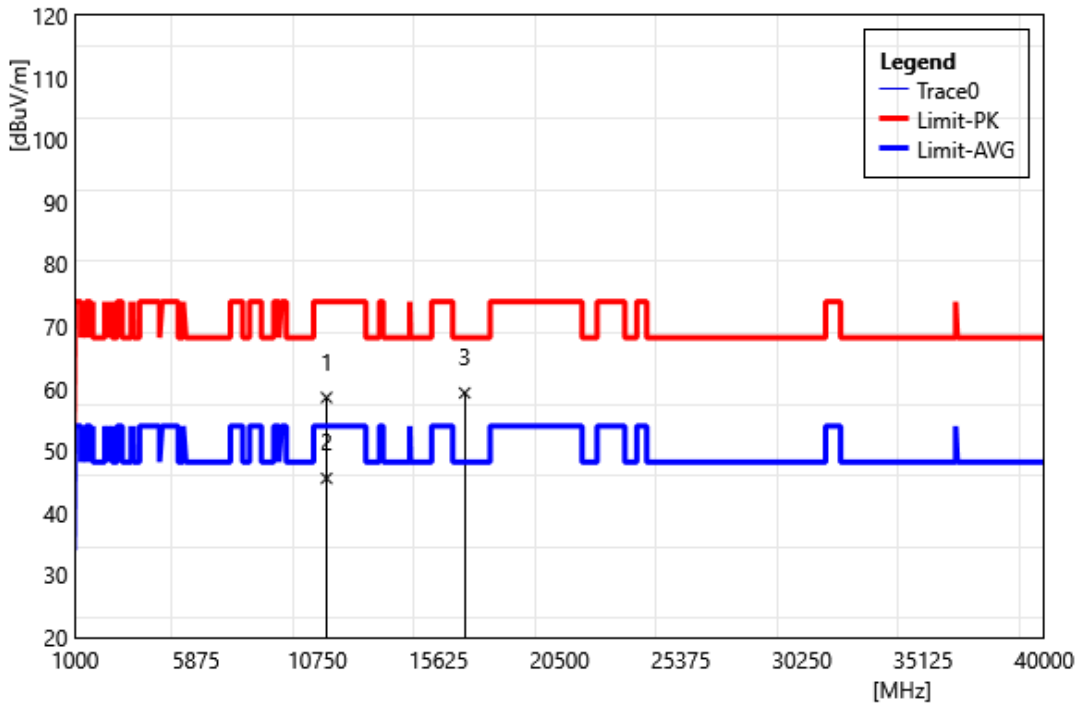

ID	Frequency MHz	Reading dBuV	Correct Factor dB/m	Result dBuV/m	Limit dBuV/m	Margin dB	Remark
1	11120.00	50.77	7.81	58.58	74.00	-15.42	PEAK
2	11120.00	37.77	7.81	45.58	54.00	-8.42	AVG
3	16680.00	50.44	8.88	59.32	68.20	-8.88	PEAK

Test Site:	96603-WG	Standard:	Part 15.407
Test Mode:	802.11a 5700 MHz		
Polarization:	Horizontal		
Remark:			

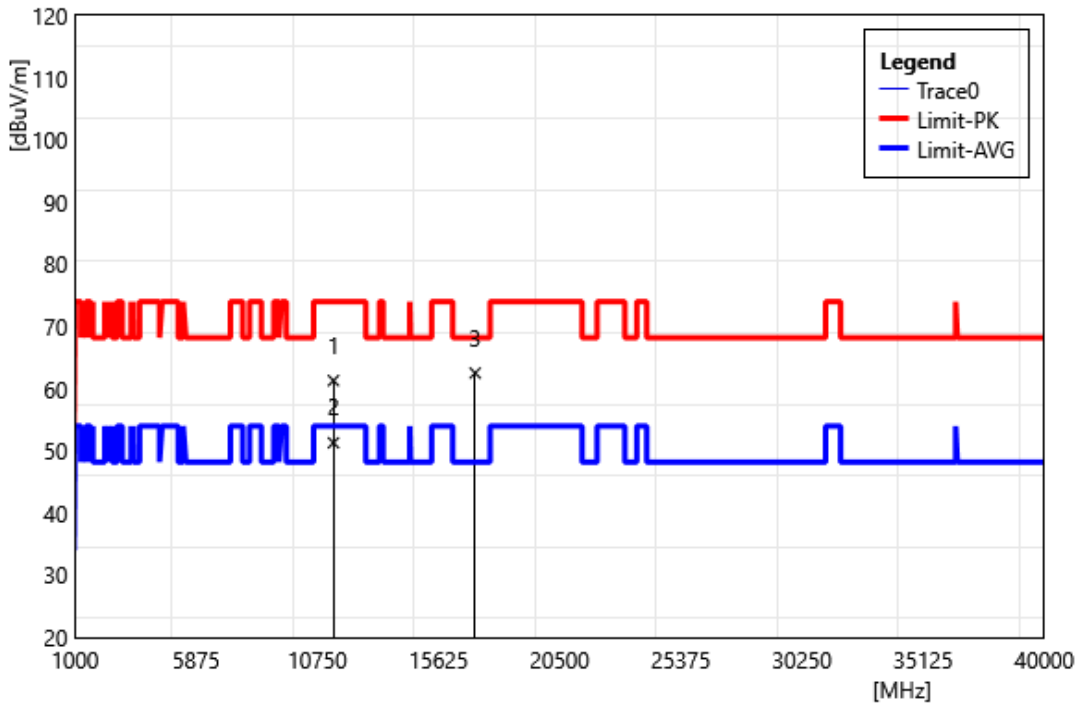

ID	Frequency MHz	Reading dBuV	Correct Factor dB/m	Result dBuV/m	Limit dBuV/m	Margin dB	Remark
1	11400.00	53.30	8.00	61.30	74.00	-12.70	PEAK
2	11400.00	43.30	8.00	51.30	54.00	-2.70	AVG
3	17100.00	55.20	7.32	62.52	68.20	-5.68	PEAK

Test Site:	96603-WG	Standard:	Part 15.407
Test Mode:	802.11a 5700 MHz		
Polarization:	Vertical		
Remark:			

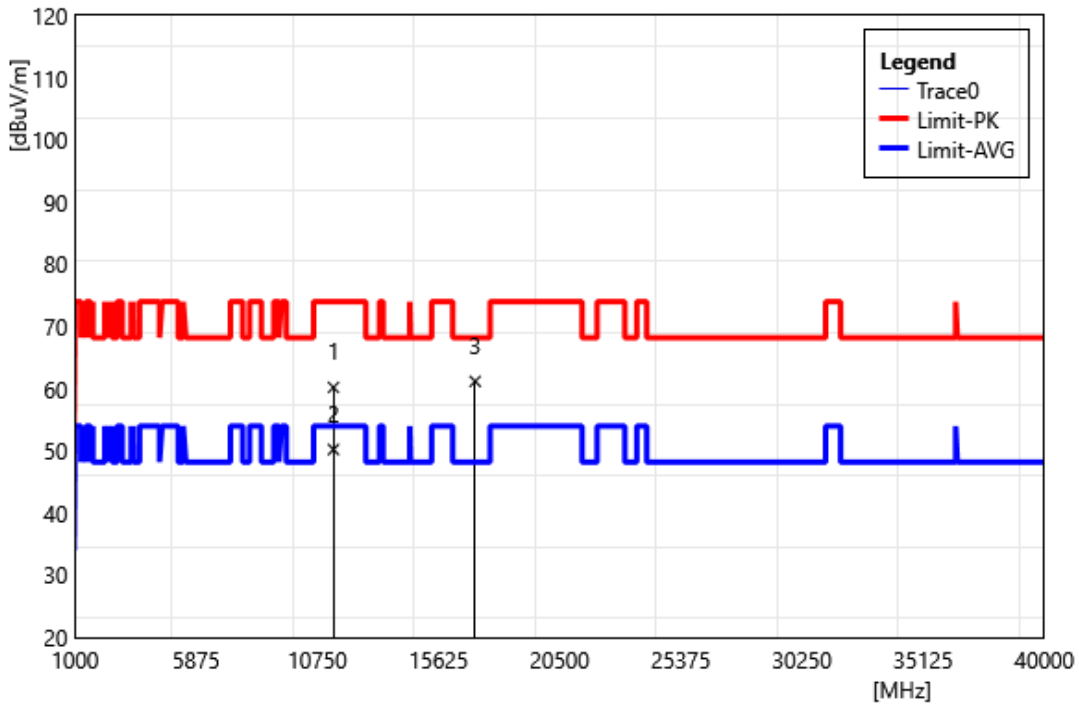

ID	Frequency MHz	Reading dBuV	Correct Factor dB/m	Result dBuV/m	Limit dBuV/m	Margin dB	Remark
1	11400.00	52.22	8.00	60.22	74.00	-13.78	PEAK
2	11400.00	42.22	8.00	50.22	54.00	-3.78	AVG
3	17100.00	53.86	7.32	61.18	68.20	-7.02	PEAK

Test Site:	96603-WG	Standard:	Part 15.407
Test Mode:	802.11a 5745 MHz		
Polarization:	Horizontal		
Remark:			

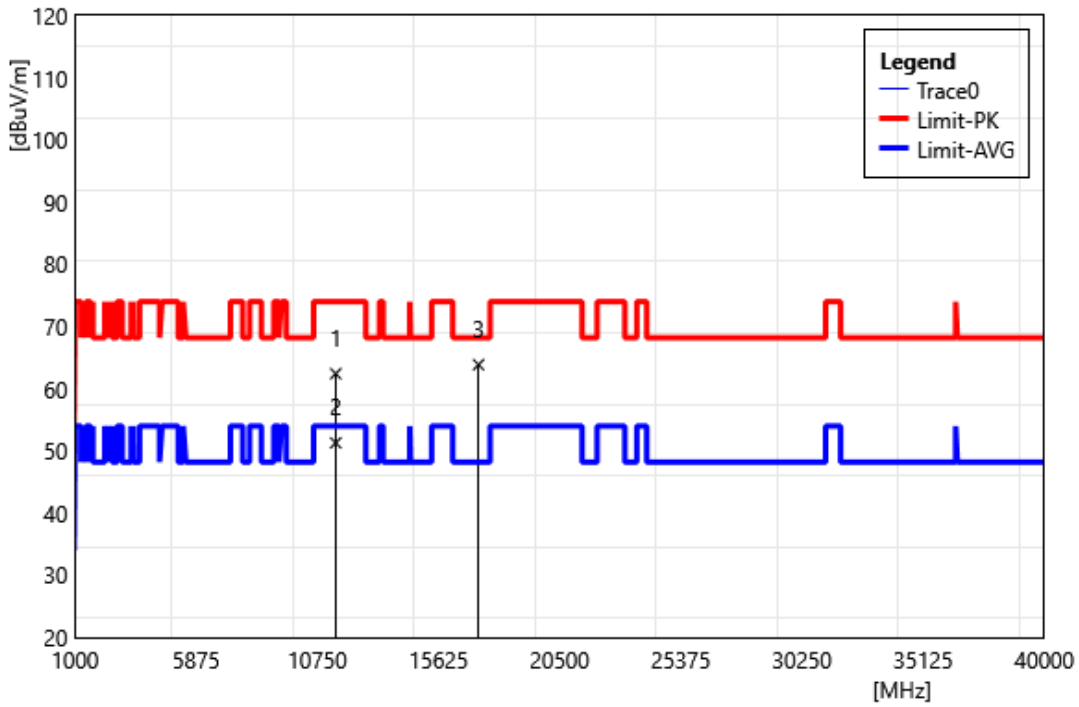

ID	Frequency MHz	Reading dBuV	Correct Factor dB/m	Result dBuV/m	Limit dBuV/m	Margin dB	Remark
1	11490.00	54.35	8.06	62.41	74.00	-11.59	PEAK
2	11490.00	43.23	8.06	51.29	54.00	-2.71	AVG
3	17235.00	56.45	7.41	63.86	68.20	-4.34	PEAK

Test Site:	96603-WG	Standard:	Part 15.407
Test Mode:	802.11a 5745 MHz		
Polarization:	Vertical		
Remark:			

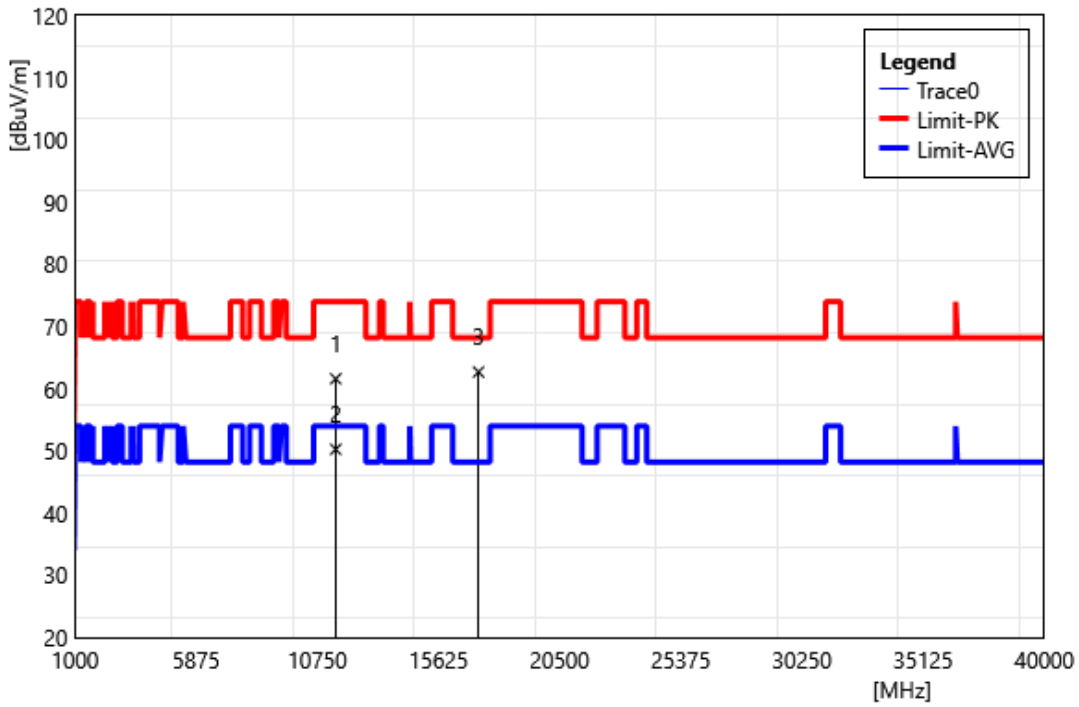

ID	Frequency MHz	Reading dBuV	Correct Factor dB/m	Result dBuV/m	Limit dBuV/m	Margin dB	Remark
1	11490.00	53.54	8.06	61.60	74.00	-12.40	PEAK
2	11490.00	42.20	8.06	50.26	54.00	-3.74	AVG
3	17235.00	55.28	7.41	62.69	68.20	-5.51	PEAK

Test Site:	96603-WG	Standard:	Part 15.407
Test Mode:	802.11a 5785 MHz		
Polarization:	Horizontal		
Remark:			

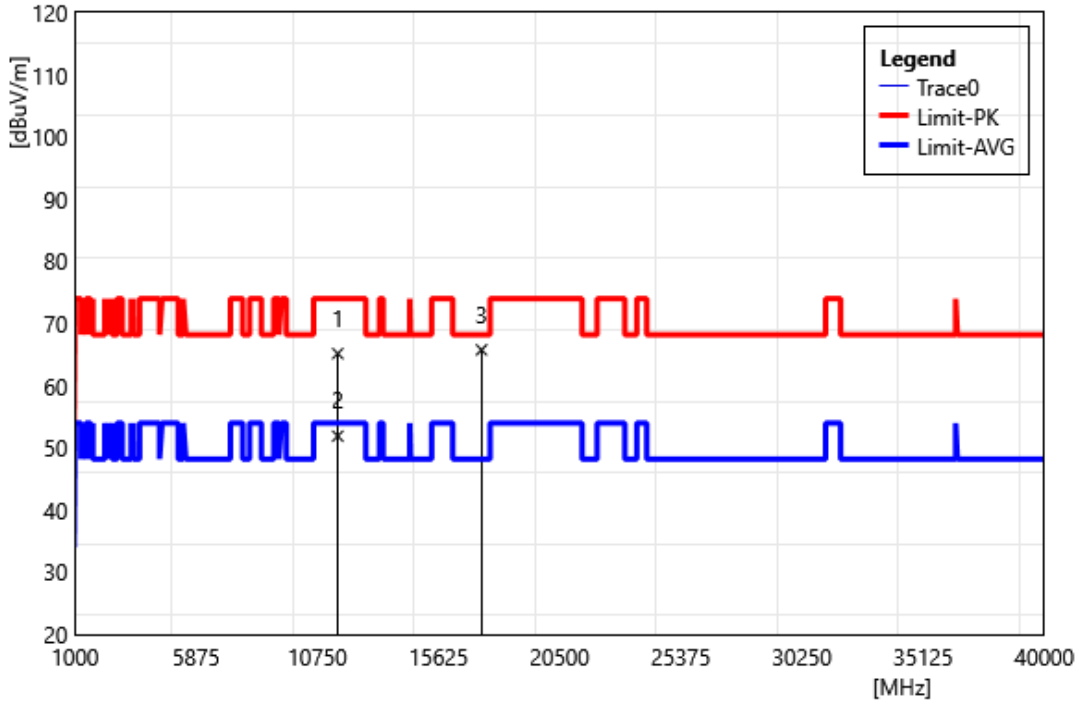

ID	Frequency MHz	Reading dBuV	Correct Factor dB/m	Result dBuV/m	Limit dBuV/m	Margin dB	Remark
1	11570.00	56.91	8.25	65.16	74.00	-8.84	PEAK
2	11570.00	43.64	8.25	51.89	54.00	-2.11	AVG
3	17355.00	58.63	7.13	65.76	68.20	-2.44	PEAK



Test Site:	96603-WG	Standard:	Part 15.407
Test Mode:	802.11a 5785 MHz		
Polarization:	Vertical		
Remark:			

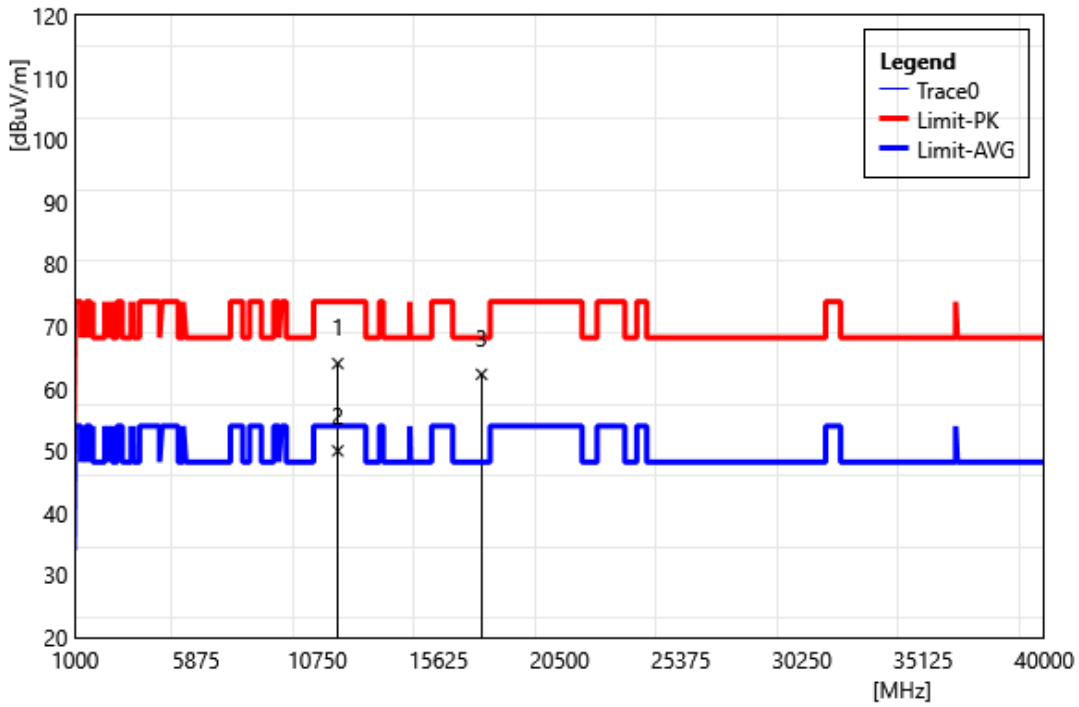

ID	Frequency MHz	Reading dBuV	Correct Factor dB/m	Result dBuV/m	Limit dBuV/m	Margin dB	Remark
1	11570.00	55.80	8.25	64.05	74.00	-9.95	PEAK
2	11570.00	41.76	8.25	50.01	54.00	-3.99	AVG
3	17355.00	55.19	7.13	62.32	68.20	-5.88	PEAK

Test Site:	96603-WG	Standard:	Part 15.407
Test Mode:	802.11a 5825 MHz		
Polarization:	Horizontal		
Remark:			

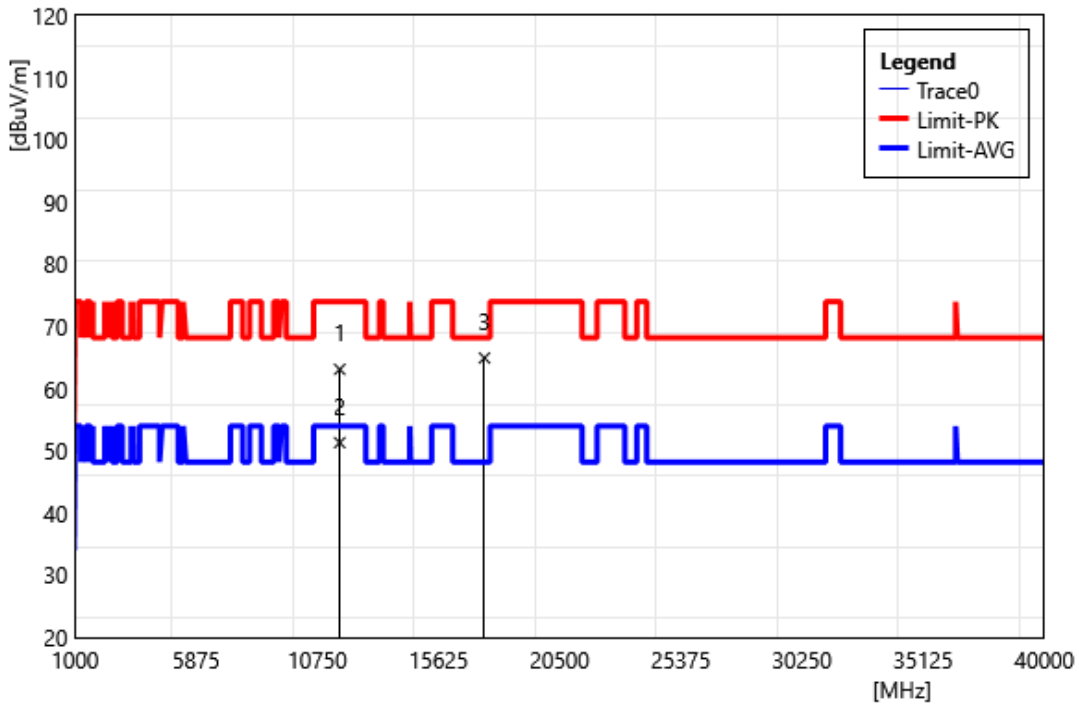

ID	Frequency MHz	Reading dBuV	Correct Factor dB/m	Result dBuV/m	Limit dBuV/m	Margin dB	Remark
1	11650.00	54.98	8.14	63.12	74.00	-10.88	PEAK
2	11650.00	43.18	8.14	51.32	54.00	-2.68	AVG
3	17475.00	57.80	7.15	64.95	68.20	-3.25	PEAK

Test Site:	96603-WG	Standard:	Part 15.407
Test Mode:	802.11a 5825 MHz		
Polarization:	Vertical		
Remark:			

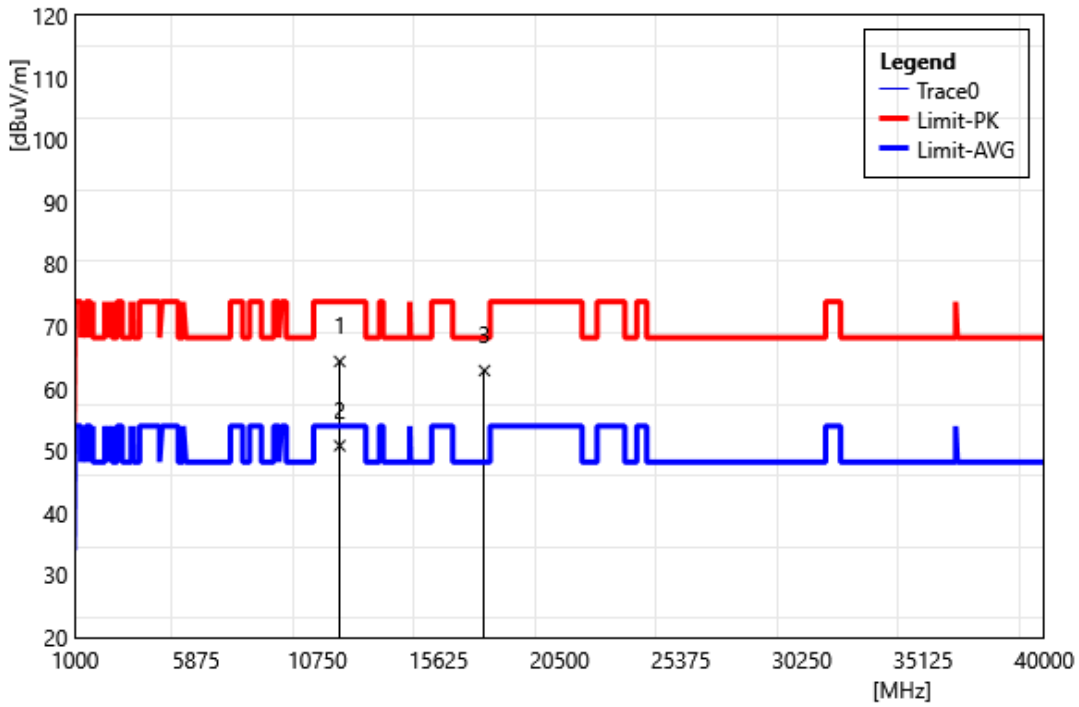

ID	Frequency MHz	Reading dBuV	Correct Factor dB/m	Result dBuV/m	Limit dBuV/m	Margin dB	Remark
1	11650.00	56.24	8.14	64.38	74.00	-9.62	PEAK
2	11650.00	42.70	8.14	50.84	54.00	-3.16	AVG
3	17475.00	55.77	7.15	62.92	68.20	-5.28	PEAK

Test Site:	96603-WG	Standard:	Part 15.407
Test Mode:	802.11ac VHT20 5180 MHz		
Polarization:	Horizontal		
Remark:			

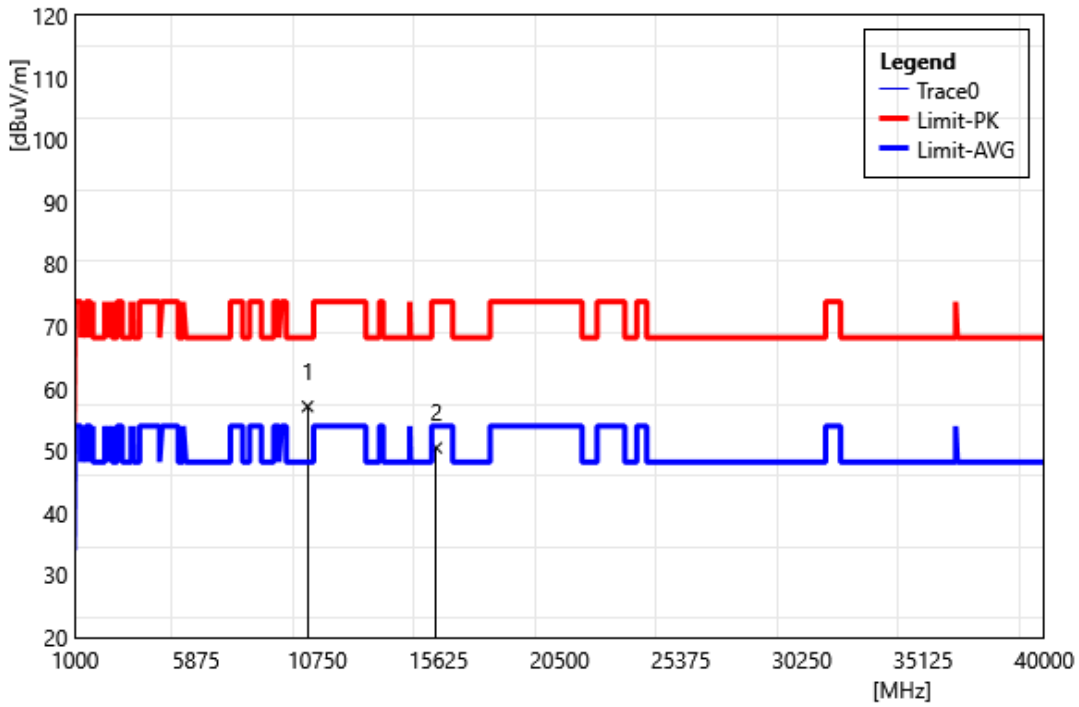

ID	Frequency MHz	Reading dBuV	Correct Factor dB/m	Result dBuV/m	Limit dBuV/m	Margin dB	Remark
1	10360.00	50.00	7.14	57.14	68.20	-11.06	PEAK
2	15540.00	40.99	9.51	50.50	74.00	-23.50	PEAK

Test Site:	96603-WG	Standard:	Part 15.407
Test Mode:	802.11ac VHT20 5180 MHz		
Polarization:	Vertical		
Remark:			

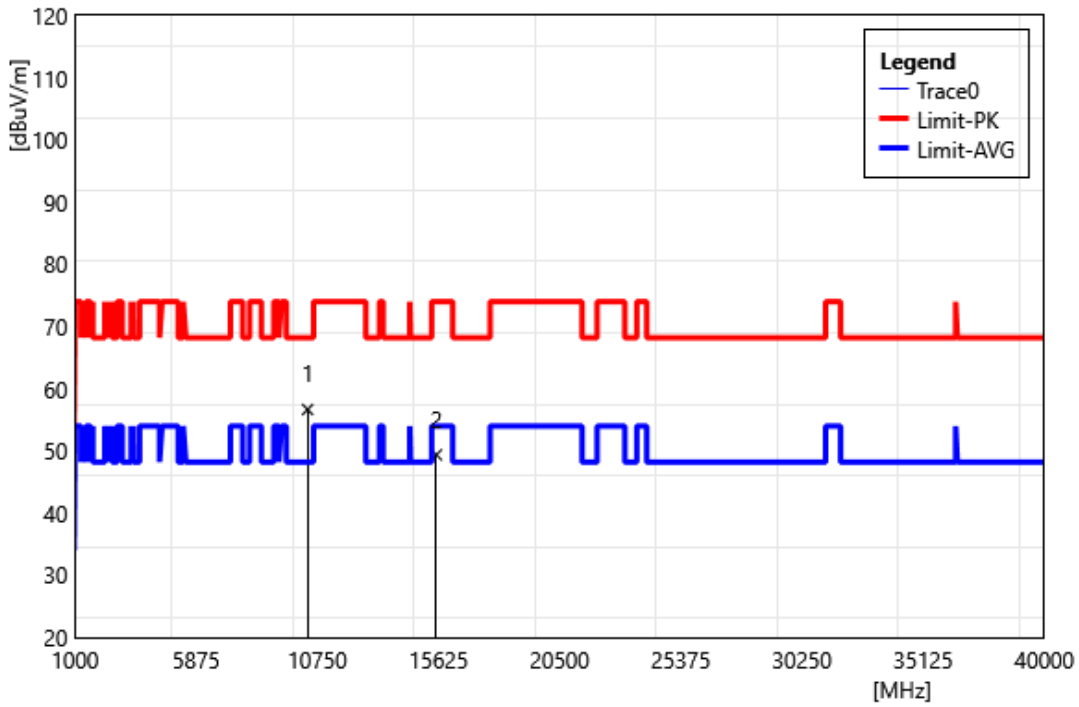

ID	Frequency MHz	Reading dBuV	Correct Factor dB/m	Result dBuV/m	Limit dBuV/m	Margin dB	Remark
1	10360.00	49.52	7.14	56.66	68.20	-11.54	PEAK
2	15540.00	39.86	9.51	49.37	74.00	-24.63	PEAK

Test Site:	96603-WG	Standard:	Part 15.407
Test Mode:	802.11ac VHT20 5200 MHz		
Polarization:	Horizontal		
Remark:			

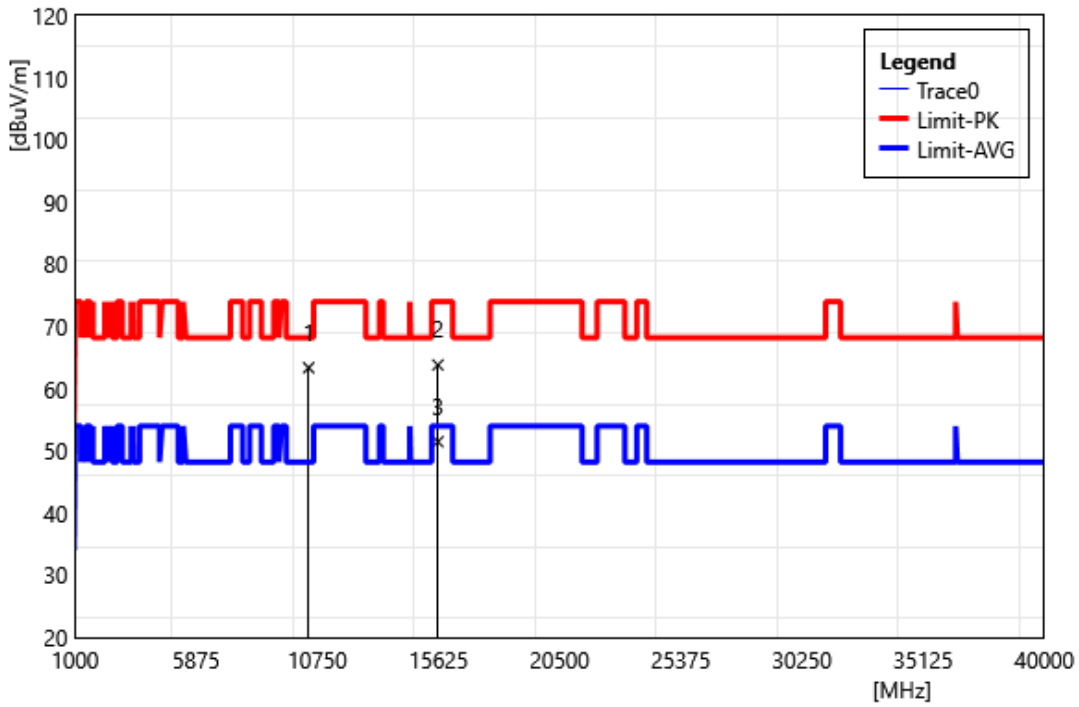

ID	Frequency MHz	Reading dBuV	Correct Factor dB/m	Result dBuV/m	Limit dBuV/m	Margin dB	Remark
1	10400.00	56.10	7.27	63.37	68.20	-4.83	PEAK
2	15600.00	54.29	9.54	63.83	74.00	-10.17	PEAK
3	15600.00	41.94	9.54	51.48	54.00	-2.52	AVG

Test Site:	96603-WG	Standard:	Part 15.407
Test Mode:	802.11ac VHT20 5200 MHz		
Polarization:	Vertical		
Remark:			

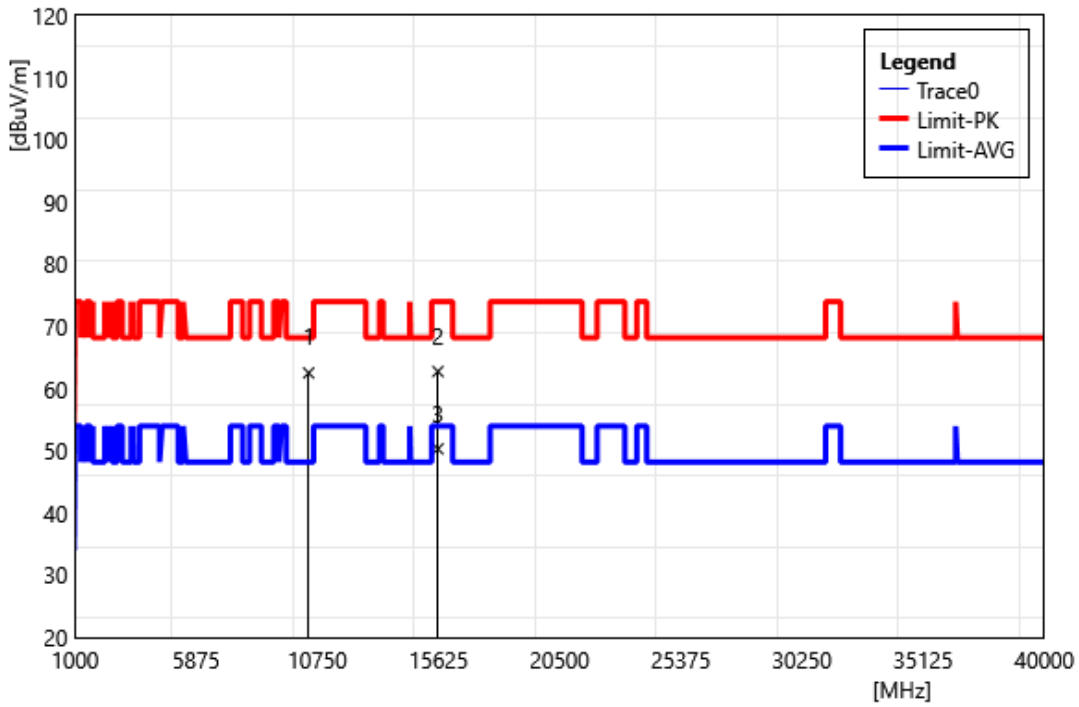

ID	Frequency MHz	Reading dBuV	Correct Factor dB/m	Result dBuV/m	Limit dBuV/m	Margin dB	Remark
1	10400.00	55.28	7.27	62.55	68.20	-5.65	PEAK
2	15600.00	53.23	9.54	62.77	74.00	-11.23	PEAK
3	15600.00	40.78	9.54	50.32	54.00	-3.68	AVG

Test Site:	96603-WG	Standard:	Part 15.407
Test Mode:	802.11ac VHT20 5240 MHz		
Polarization:	Horizontal		
Remark:			

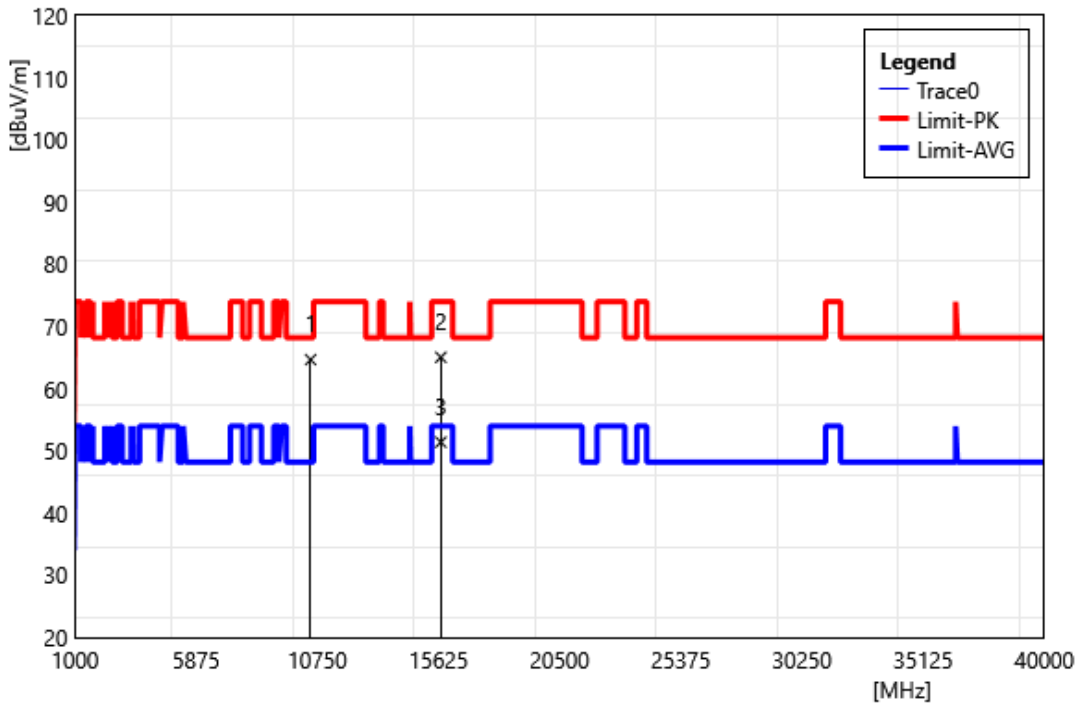

ID	Frequency MHz	Reading dBuV	Correct Factor dB/m	Result dBuV/m	Limit dBuV/m	Margin dB	Remark
1	10480.00	57.28	7.40	64.68	68.20	-3.52	PEAK
2	15720.00	55.32	9.73	65.05	74.00	-8.95	PEAK
3	15720.00	41.68	9.73	51.41	54.00	-2.59	AVG



Test Site:	96603-WG	Standard:	Part 15.407
Test Mode:	802.11ac VHT20 5240 MHz		
Polarization:	Vertical		
Remark:			

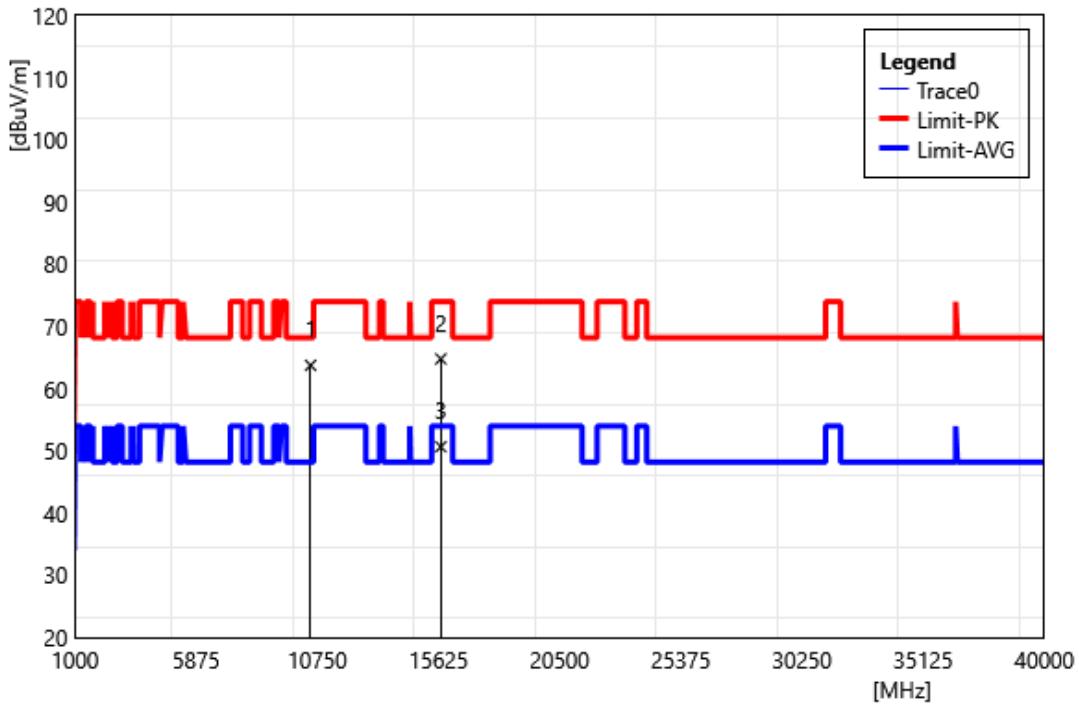

ID	Frequency MHz	Reading dBuV	Correct Factor dB/m	Result dBuV/m	Limit dBuV/m	Margin dB	Remark
1	10480.00	56.36	7.40	63.76	68.20	-4.44	PEAK
2	15720.00	55.07	9.73	64.80	74.00	-9.20	PEAK
3	15720.00	40.93	9.73	50.66	54.00	-3.34	AVG

Test Site:	96603-WG	Standard:	Part 15.407
Test Mode:	802.11ac VHT20 5260 MHz		
Polarization:	Horizontal		
Remark:			

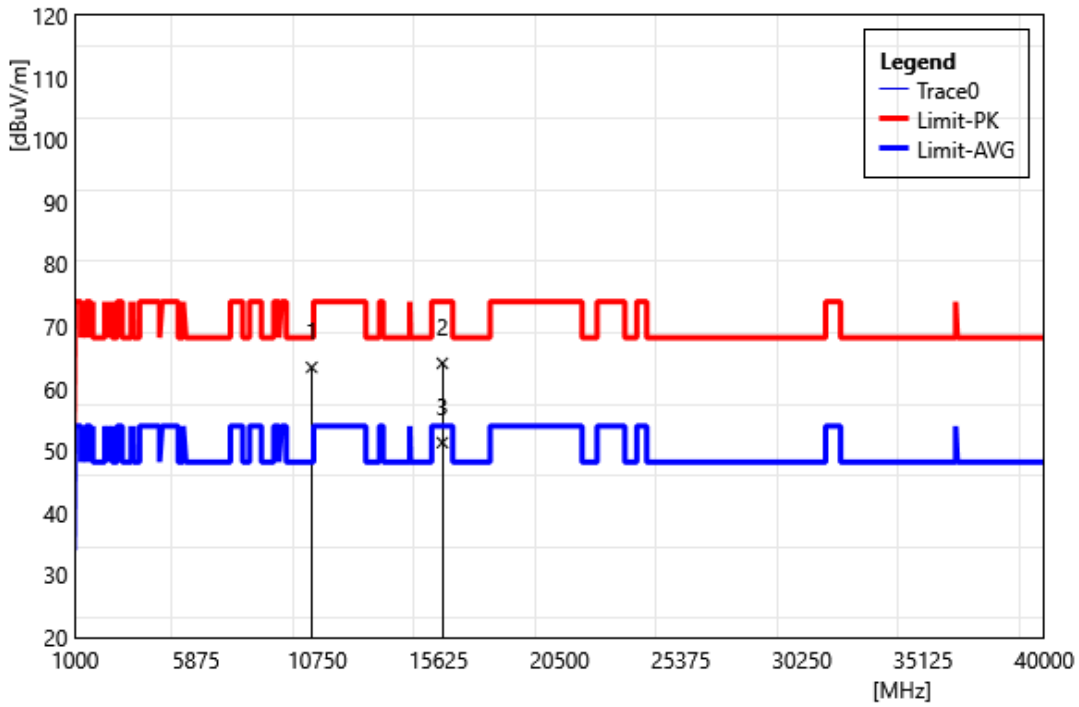

ID	Frequency MHz	Reading dBuV	Correct Factor dB/m	Result dBuV/m	Limit dBuV/m	Margin dB	Remark
1	10520.00	56.12	7.32	63.44	68.20	-4.76	PEAK
2	15780.00	54.24	9.84	64.08	74.00	-9.92	PEAK
3	15780.00	41.49	9.84	51.33	54.00	-2.67	AVG

Test Site:	96603-WG	Standard:	Part 15.407
Test Mode:	802.11ac VHT20 5260 MHz		
Polarization:	Vertical		
Remark:			

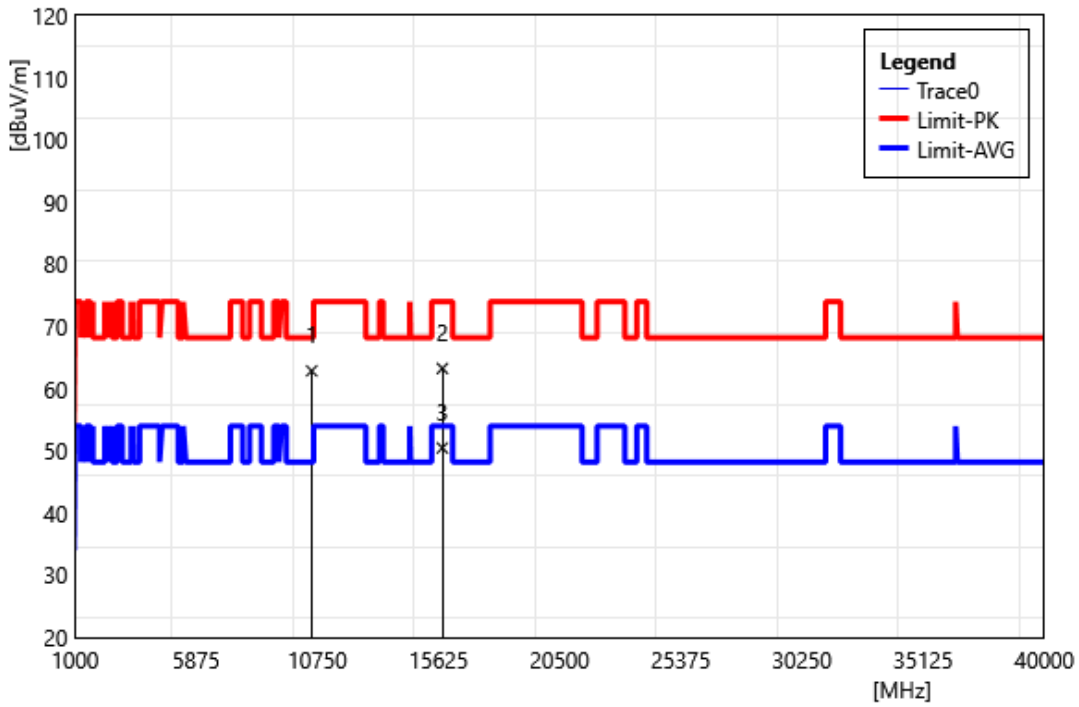

ID	Frequency MHz	Reading dBuV	Correct Factor dB/m	Result dBuV/m	Limit dBuV/m	Margin dB	Remark
1	10520.00	55.55	7.32	62.87	68.20	-5.33	PEAK
2	15780.00	53.42	9.84	63.26	74.00	-10.74	PEAK
3	15780.00	40.64	9.84	50.48	54.00	-3.52	AVG

Test Site:	96603-WG	Standard:	Part 15.407
Test Mode:	802.11ac VHT20 5280 MHz		
Polarization:	Horizontal		
Remark:			

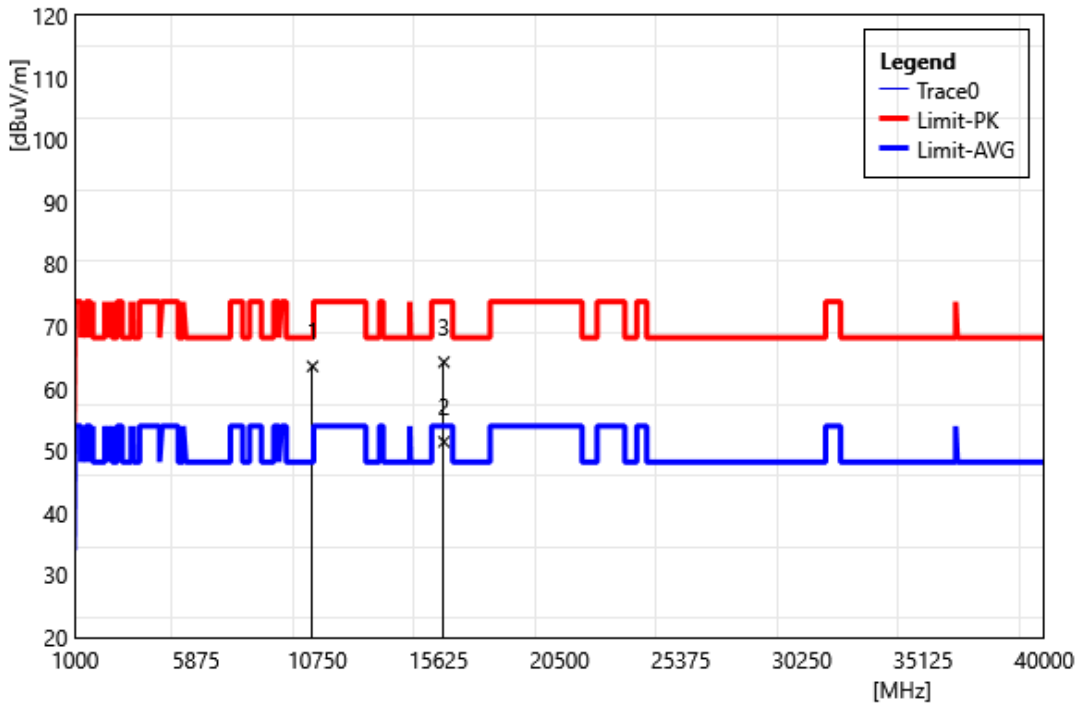

ID	Frequency MHz	Reading dBuV	Correct Factor dB/m	Result dBuV/m	Limit dBuV/m	Margin dB	Remark
1	10560.00	56.27	7.32	63.59	68.20	-4.61	PEAK
2	15840.00	41.61	9.85	51.46	54.00	-2.54	AVG
3	15840.00	54.43	9.85	64.28	74.00	-9.72	PEAK

Test Site:	96603-WG	Standard:	Part 15.407
Test Mode:	802.11ac VHT20 5280 MHz		
Polarization:	Vertical		
Remark:			

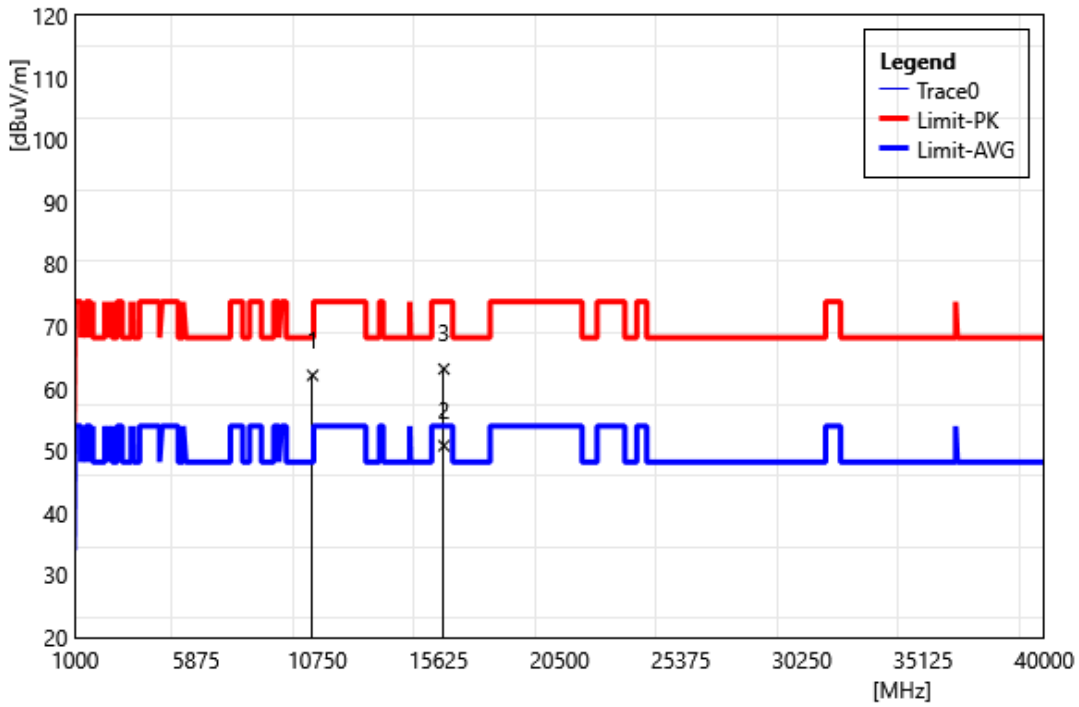

ID	Frequency MHz	Reading dBuV	Correct Factor dB/m	Result dBuV/m	Limit dBuV/m	Margin dB	Remark
1	10560.00	54.83	7.32	62.15	68.20	-6.05	PEAK
2	15840.00	40.98	9.85	50.83	54.00	-3.17	AVG
3	15840.00	53.32	9.85	63.17	74.00	-10.83	PEAK

Test Site:	96603-WG	Standard:	Part 15.407
Test Mode:	802.11ac VHT20 5320 MHz		
Polarization:	Horizontal		
Remark:			

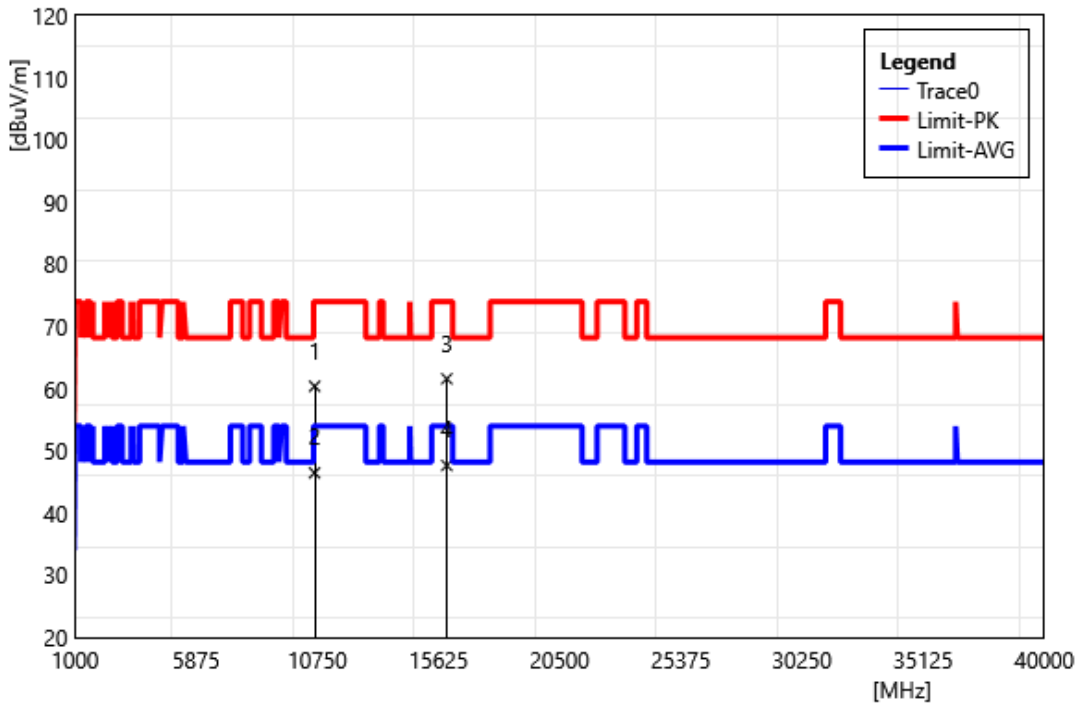

ID	Frequency MHz	Reading dBuV	Correct Factor dB/m	Result dBuV/m	Limit dBuV/m	Margin dB	Remark
1	10640.00	53.07	7.33	60.40	74.00	-13.60	PEAK
2	10640.00	39.13	7.33	46.46	54.00	-7.54	AVG
3	15960.00	51.58	10.01	61.59	74.00	-12.41	PEAK
4	15960.00	37.64	10.01	47.65	54.00	-6.35	AVG

Test Site:	96603-WG	Standard:	Part 15.407
Test Mode:	802.11ac VHT20 5320 MHz		
Polarization:	Vertical		
Remark:			

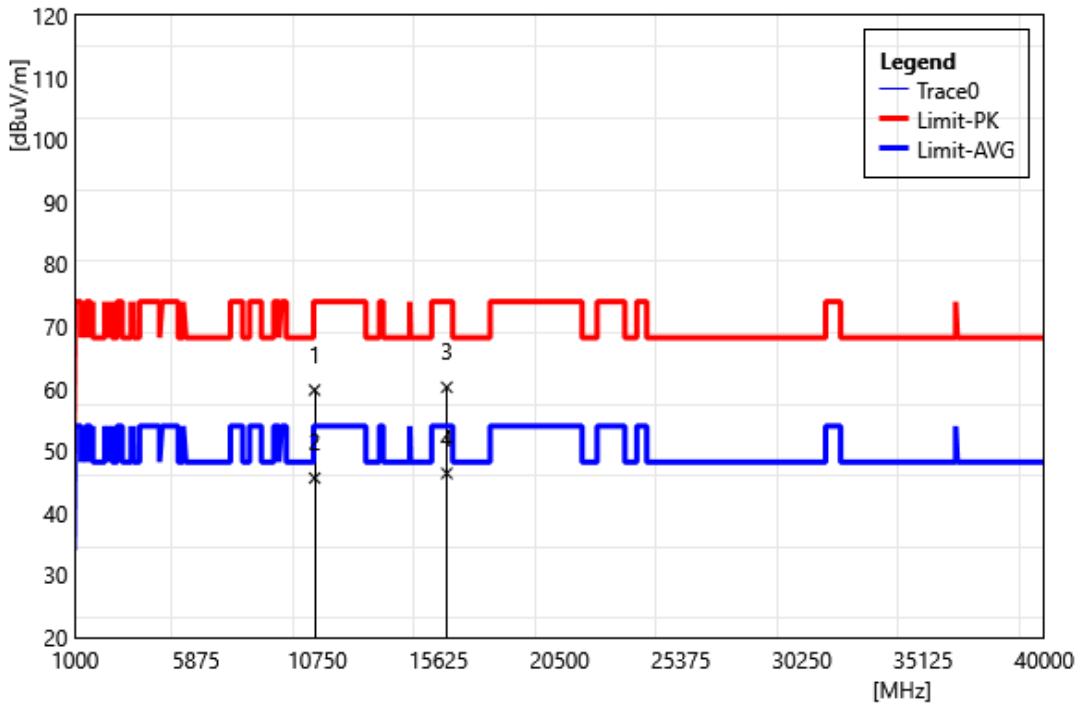

ID	Frequency MHz	Reading dBuV	Correct Factor dB/m	Result dBuV/m	Limit dBuV/m	Margin dB	Remark
1	10640.00	52.45	7.33	59.78	74.00	-14.22	PEAK
2	10640.00	38.30	7.33	45.63	54.00	-8.37	AVG
3	15960.00	50.23	10.01	60.24	74.00	-13.76	PEAK
4	15960.00	36.37	10.01	46.38	54.00	-7.62	AVG

Test Site:	96603-WG	Standard:	Part 15.407
Test Mode:	802.11ac VHT20 5500 MHz		
Polarization:	Horizontal		
Remark:			

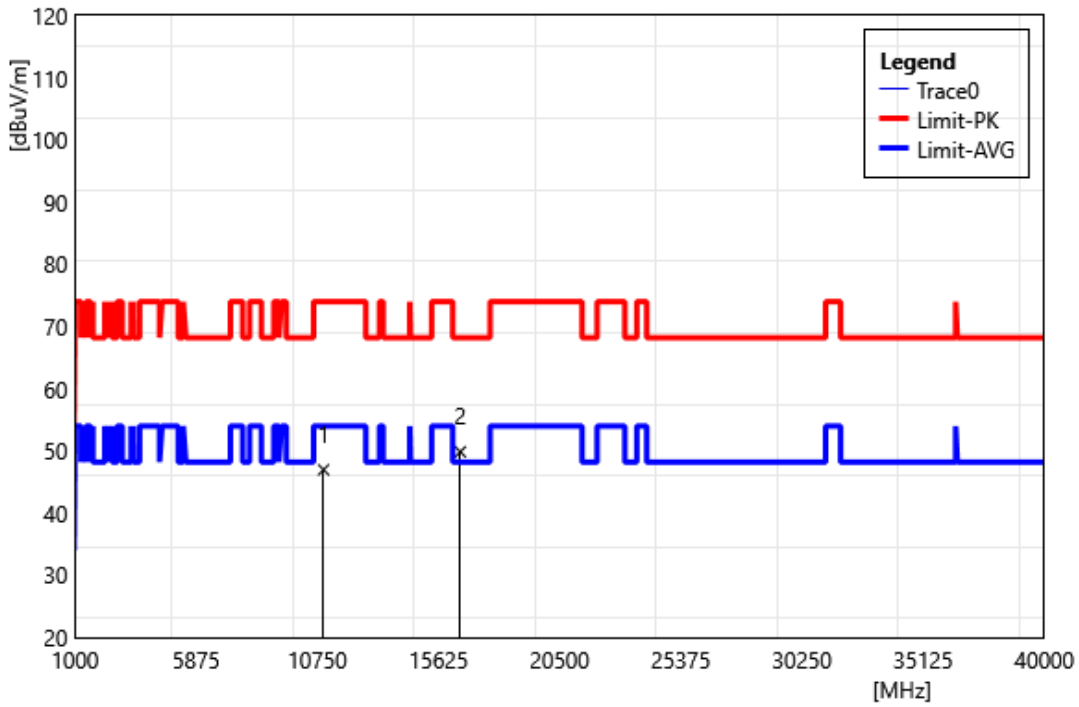

ID	Frequency MHz	Reading dBuV	Correct Factor dB/m	Result dBuV/m	Limit dBuV/m	Margin dB	Remark
1	11000.00	39.77	7.19	46.96	74.00	-27.04	PEAK
2	16500.00	39.98	9.87	49.85	68.20	-18.35	PEAK



Test Site:	96603-WG	Standard:	Part 15.407
Test Mode:	802.11ac VHT20 5500 MHz		
Polarization:	Vertical		
Remark:			

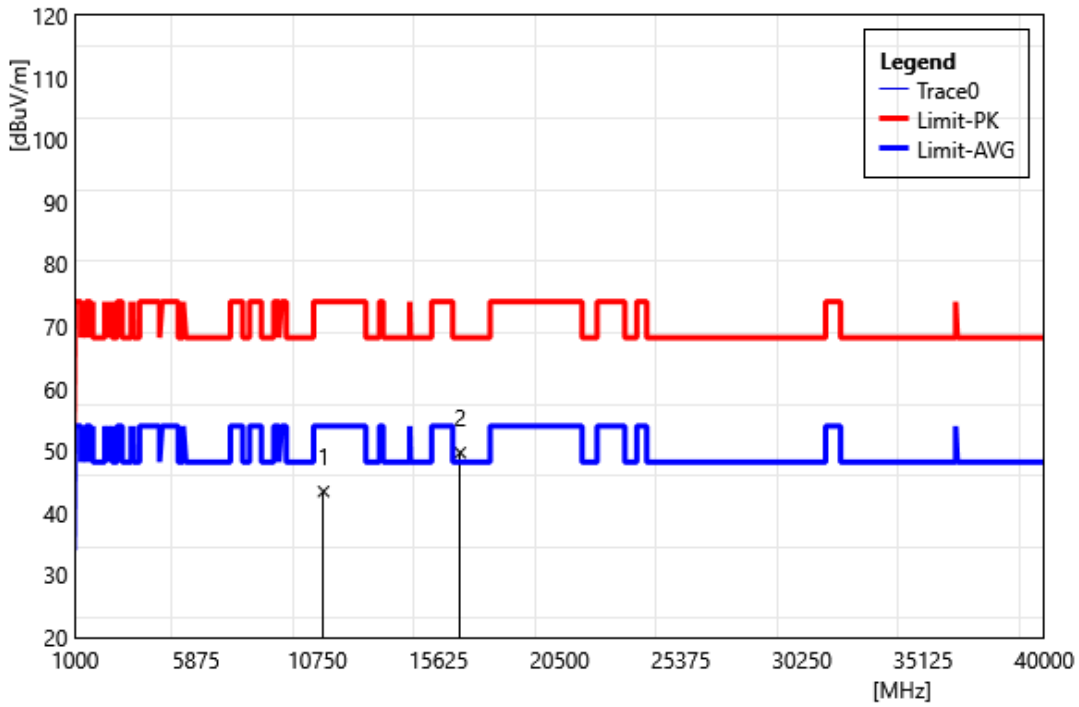

ID	Frequency MHz	Reading dBuV	Correct Factor dB/m	Result dBuV/m	Limit dBuV/m	Margin dB	Remark
1	11000.00	36.28	7.19	43.47	74.00	-30.53	PEAK
2	16500.00	39.84	9.87	49.71	68.20	-18.49	PEAK

Test Site:	96603-WG	Standard:	Part 15.407
Test Mode:	802.11ac VHT20 5560 MHz		
Polarization:	Horizontal		
Remark:			

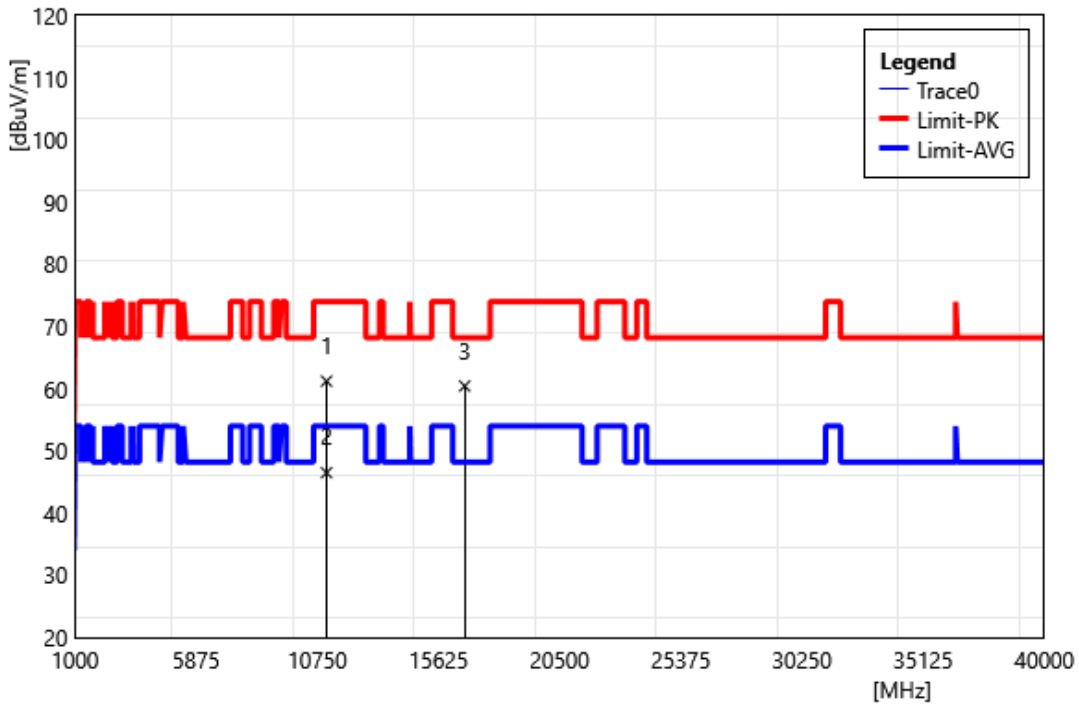

ID	Frequency MHz	Reading dBuV	Correct Factor dB/m	Result dBuV/m	Limit dBuV/m	Margin dB	Remark
1	11120.00	53.50	7.72	61.22	74.00	-12.78	PEAK
2	11120.00	38.78	7.72	46.50	54.00	-7.50	AVG
3	16680.00	50.97	9.46	60.43	68.20	-7.77	PEAK

Test Site:	96603-WG	Standard:	Part 15.407
Test Mode:	802.11ac VHT20 5560 MHz		
Polarization:	Vertical		
Remark:			

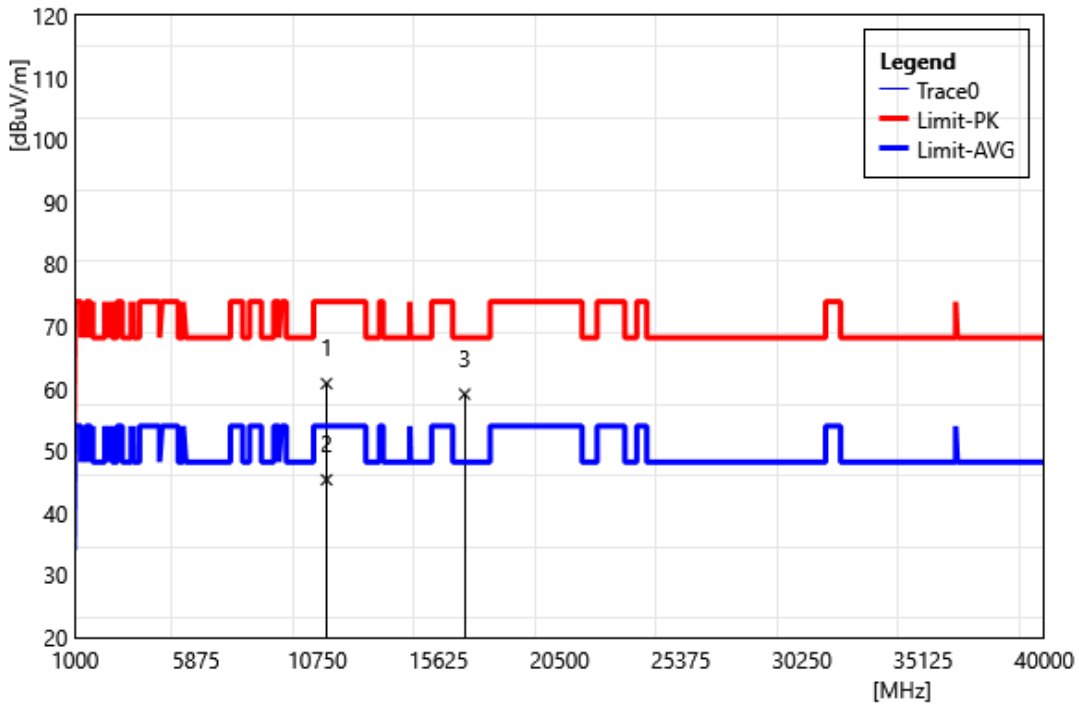

ID	Frequency MHz	Reading dBuV	Correct Factor dB/m	Result dBuV/m	Limit dBuV/m	Margin dB	Remark
1	11120.00	53.11	7.72	60.83	74.00	-13.17	PEAK
2	11120.00	37.63	7.72	45.35	54.00	-8.65	AVG
3	16680.00	49.68	9.46	59.14	68.20	-9.06	PEAK

Test Site:	96603-WG	Standard:	Part 15.407
Test Mode:	802.11ac VHT20 5700 MHz		
Polarization:	Horizontal		
Remark:			

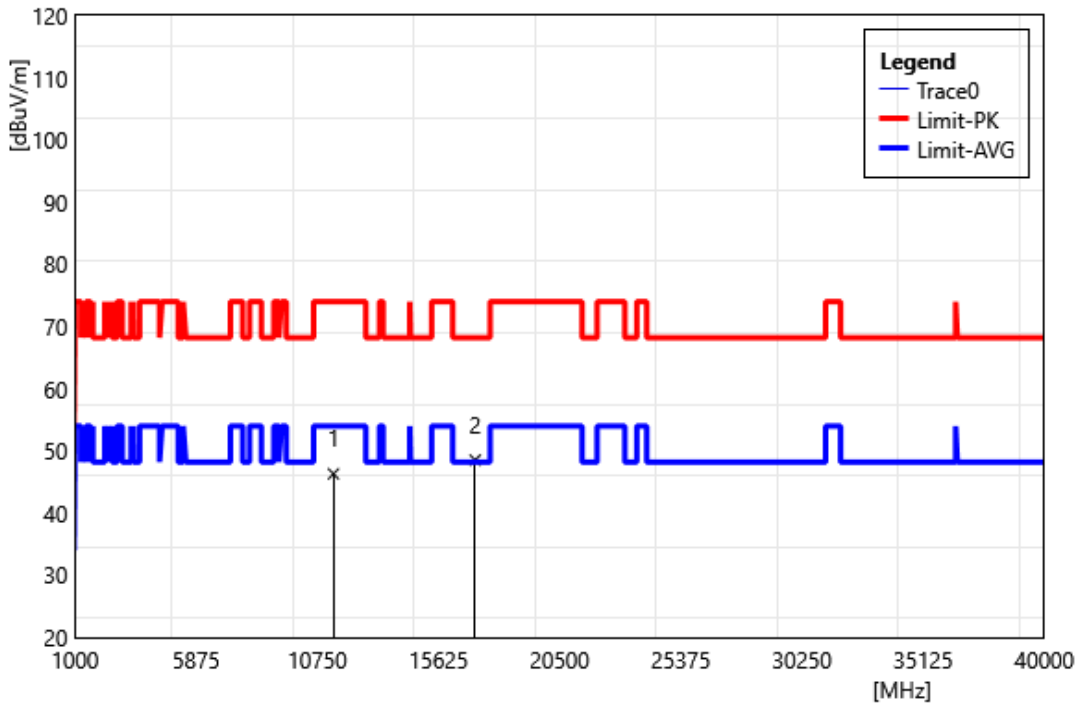

ID	Frequency MHz	Reading dBuV	Correct Factor dB/m	Result dBuV/m	Limit dBuV/m	Margin dB	Remark
1	11400.00	38.58	7.72	46.30	74.00	-27.70	PEAK
2	17100.00	40.69	7.83	48.52	68.20	-19.68	PEAK

Test Site:	96603-WG	Standard:	Part 15.407
Test Mode:	802.11ac VHT20 5700 MHz		
Polarization:	Vertical		
Remark:			

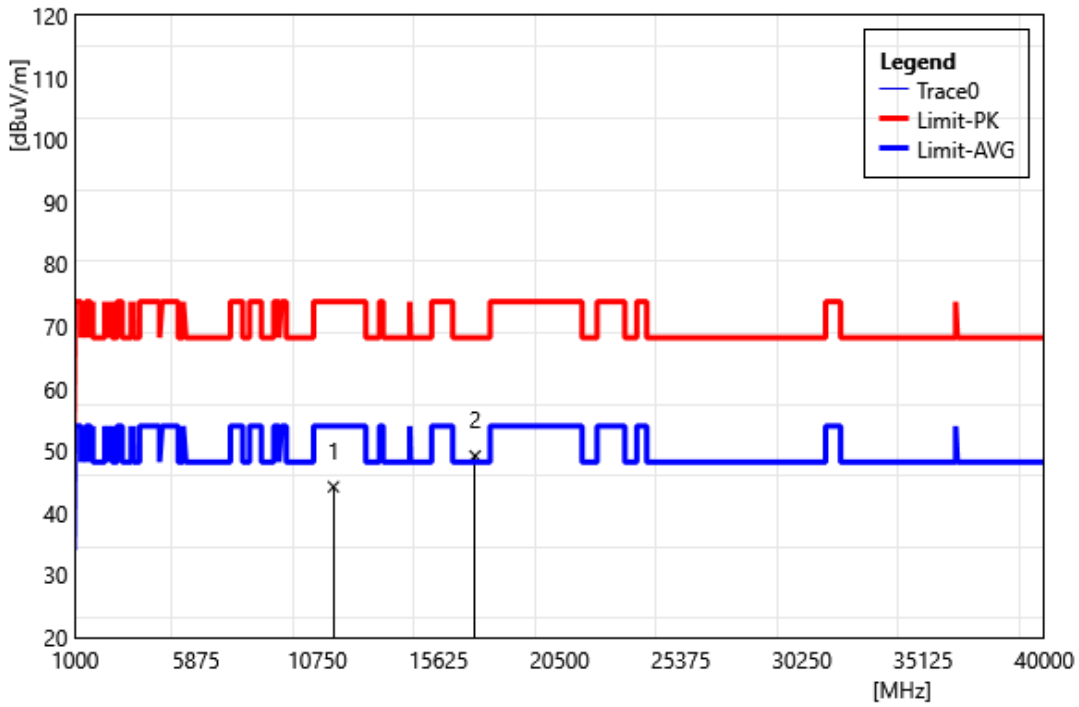

ID	Frequency MHz	Reading dBuV	Correct Factor dB/m	Result dBuV/m	Limit dBuV/m	Margin dB	Remark
1	11400.00	36.50	7.72	44.22	74.00	-29.78	PEAK
2	17100.00	41.35	7.83	49.18	68.20	-19.02	PEAK

Test Site:	96603-WG	Standard:	Part 15.407
Test Mode:	802.11ac VHT20 5745 MHz		
Polarization:	Horizontal		
Remark:			

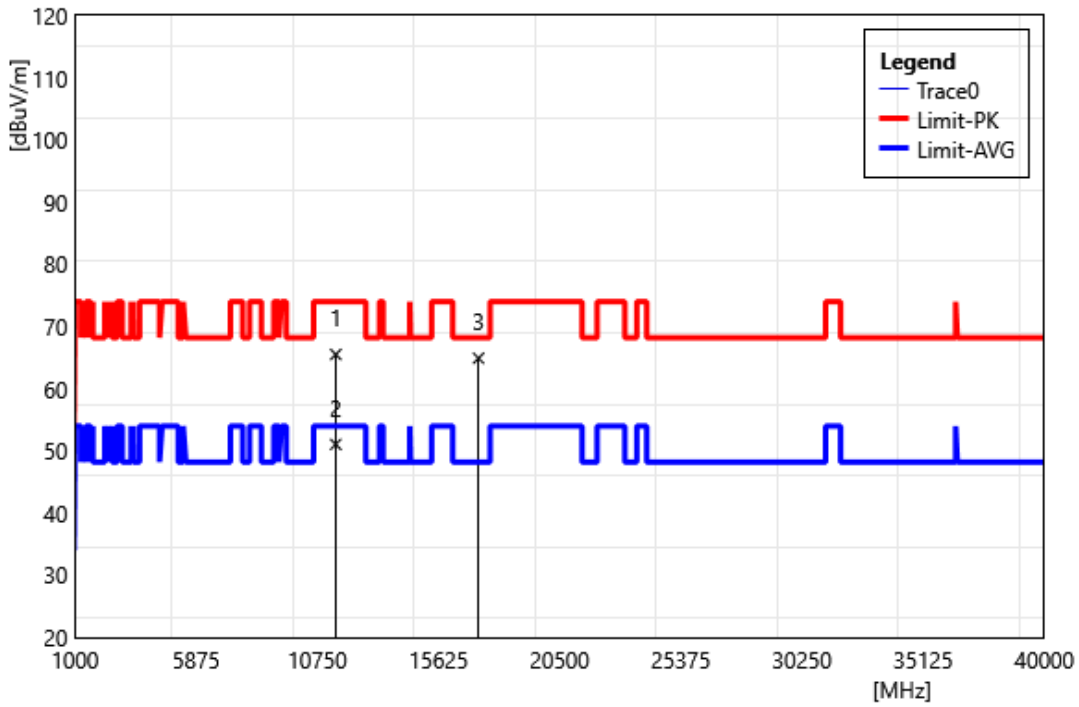

ID	Frequency MHz	Reading dBuV	Correct Factor dB/m	Result dBuV/m	Limit dBuV/m	Margin dB	Remark
1	11490.00	57.62	7.89	65.51	74.00	-8.49	PEAK
2	11490.00	43.16	7.89	51.05	54.00	-2.95	AVG
3	17235.00	57.26	7.65	64.91	68.20	-3.29	PEAK

Test Site:	96603-WG	Standard:	Part 15.407
Test Mode:	802.11ac VHT20 5745 MHz		
Polarization:	Vertical		
Remark:			

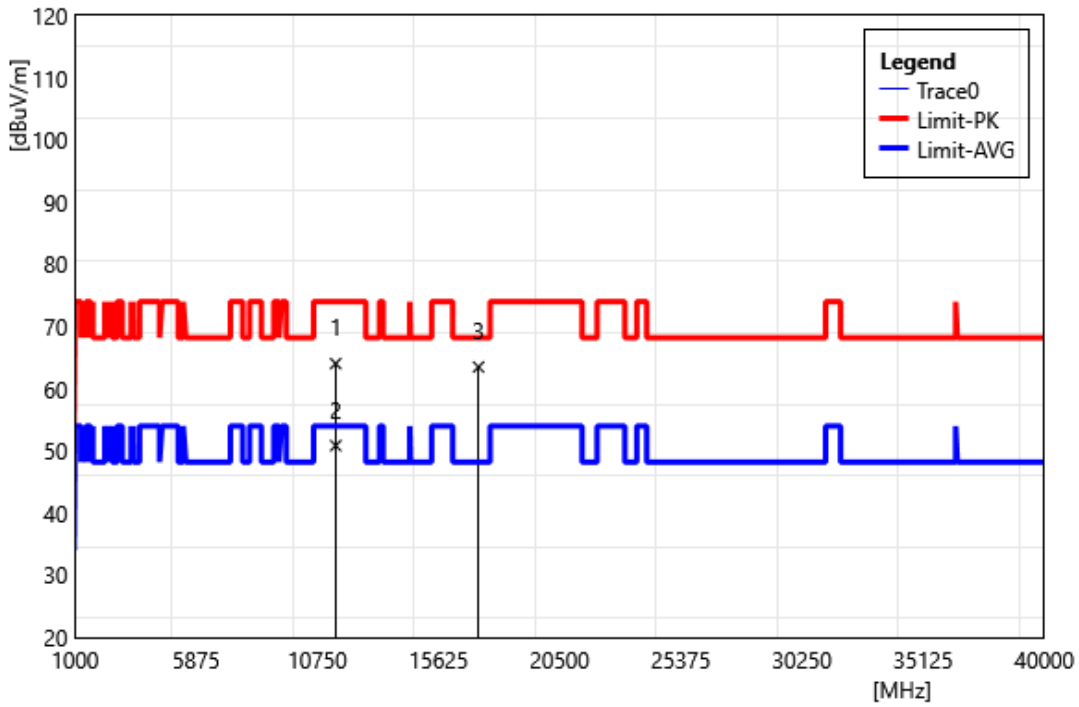

ID	Frequency MHz	Reading dBuV	Correct Factor dB/m	Result dBuV/m	Limit dBuV/m	Margin dB	Remark
1	11490.00	56.15	7.89	64.04	74.00	-9.96	PEAK
2	11490.00	42.96	7.89	50.85	54.00	-3.15	AVG
3	17235.00	55.84	7.65	63.49	68.20	-4.71	PEAK

Test Site:	96603-WG	Standard:	Part 15.407
Test Mode:	802.11ac VHT20 5785 MHz		
Polarization:	Horizontal		
Remark:			

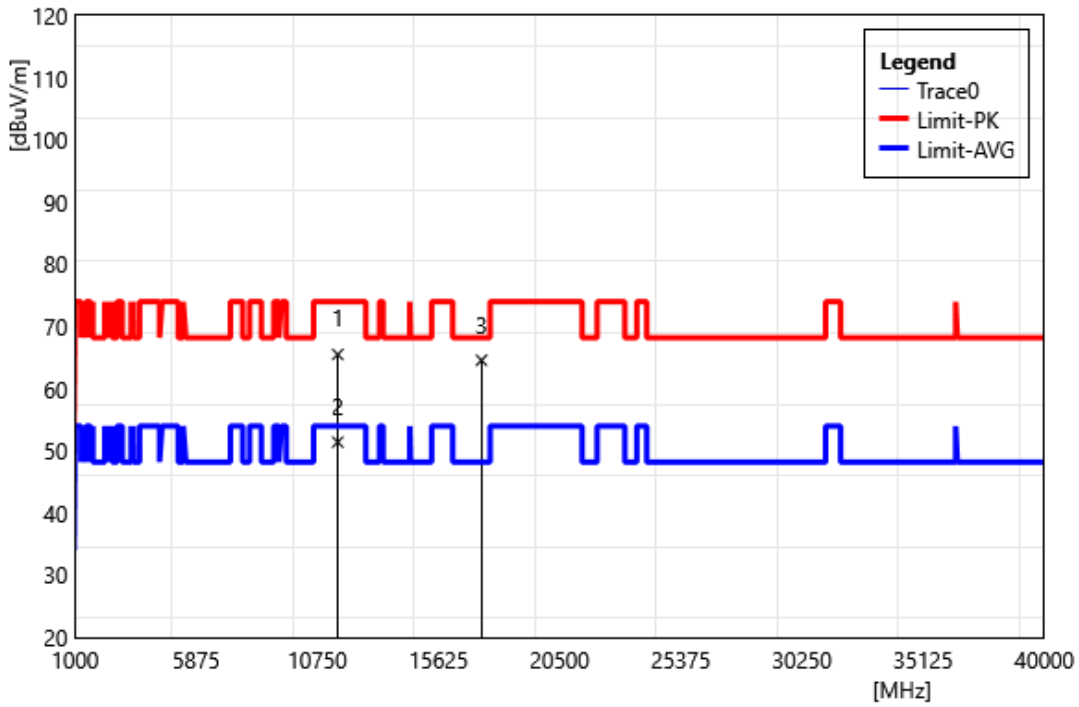

ID	Frequency MHz	Reading dBuV	Correct Factor dB/m	Result dBuV/m	Limit dBuV/m	Margin dB	Remark
1	11570.00	57.60	7.91	65.51	74.00	-8.49	PEAK
2	11570.00	43.50	7.91	51.41	54.00	-2.59	AVG
3	17355.00	57.11	7.47	64.58	68.20	-3.62	PEAK



Test Site:	96603-WG	Standard:	Part 15.407
Test Mode:	802.11ac VHT20 5785 MHz		
Polarization:	Vertical		
Remark:			

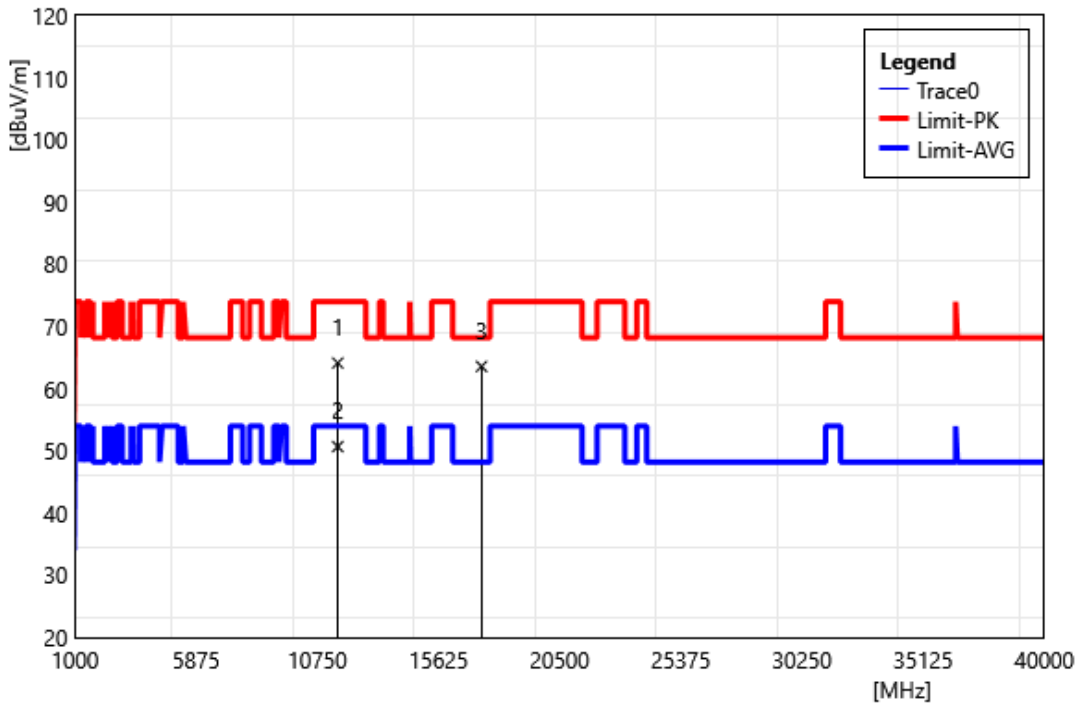

ID	Frequency MHz	Reading dBuV	Correct Factor dB/m	Result dBuV/m	Limit dBuV/m	Margin dB	Remark
1	11570.00	56.23	7.91	64.14	74.00	-9.86	PEAK
2	11570.00	42.78	7.91	50.69	54.00	-3.31	AVG
3	17355.00	56.11	7.47	63.58	68.20	-4.62	PEAK

Test Site:	96603-WG	Standard:	Part 15.407
Test Mode:	802.11ac VHT20 5825 MHz		
Polarization:	Horizontal		
Remark:			

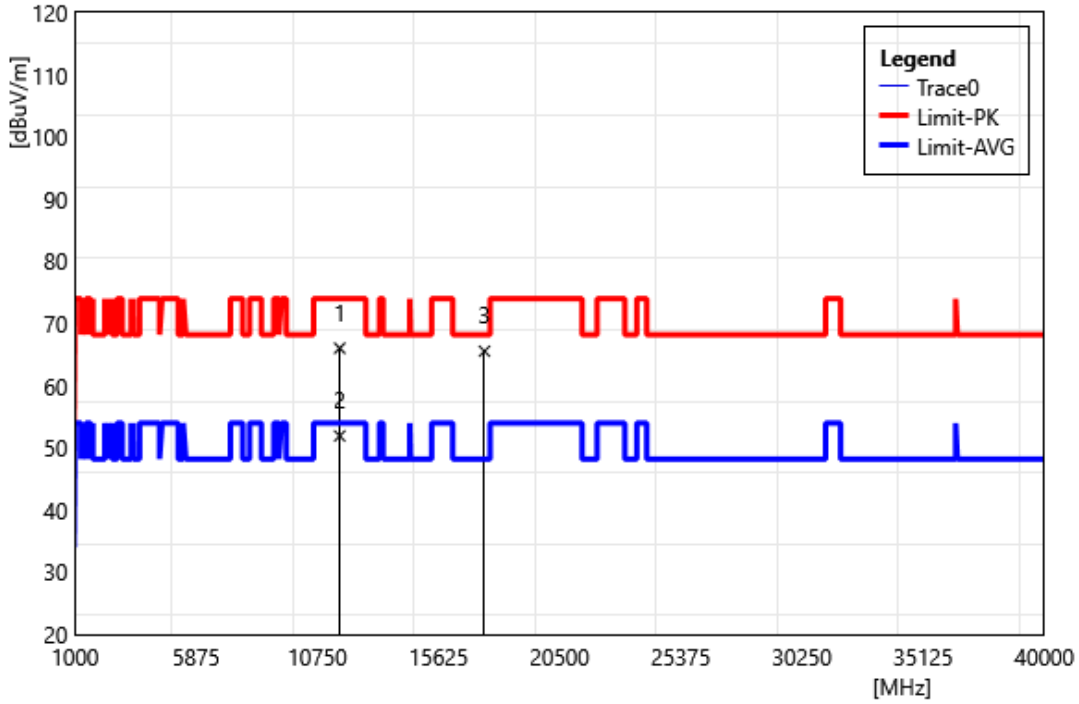

ID	Frequency MHz	Reading dBuV	Correct Factor dB/m	Result dBuV/m	Limit dBuV/m	Margin dB	Remark
1	11650.00	58.10	7.93	66.03	74.00	-7.97	PEAK
2	11650.00	43.99	7.93	51.92	54.00	-2.08	AVG
3	17475.00	58.33	7.22	65.55	68.20	-2.65	PEAK

Test Site:	96603-WG	Standard:	Part 15.407
Test Mode:	802.11ac VHT20 5825 MHz		
Polarization:	Vertical		
Remark:			

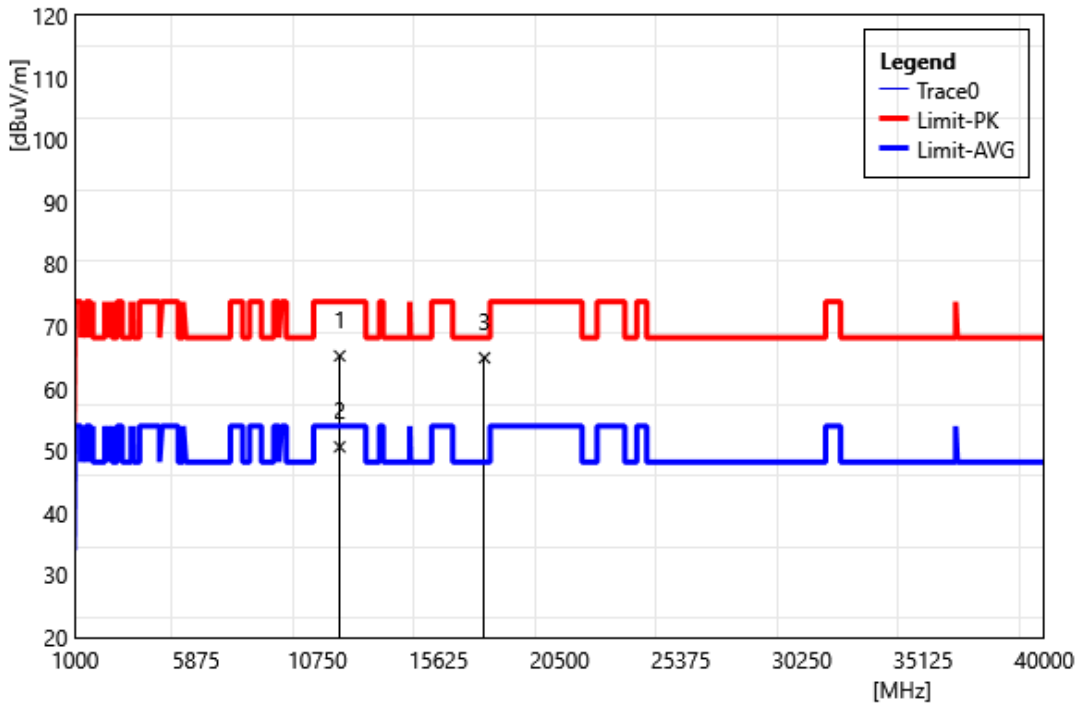

ID	Frequency MHz	Reading dBuV	Correct Factor dB/m	Result dBuV/m	Limit dBuV/m	Margin dB	Remark
1	11650.00	57.35	7.93	65.28	74.00	-8.72	PEAK
2	11650.00	42.71	7.93	50.64	54.00	-3.36	AVG
3	17475.00	57.75	7.22	64.97	68.20	-3.23	PEAK

Test Site:	96603-WG	Standard:	Part 15.407
Test Mode:	802.11n HT40 5190 MHz		
Polarization:	Horizontal		
Remark:			

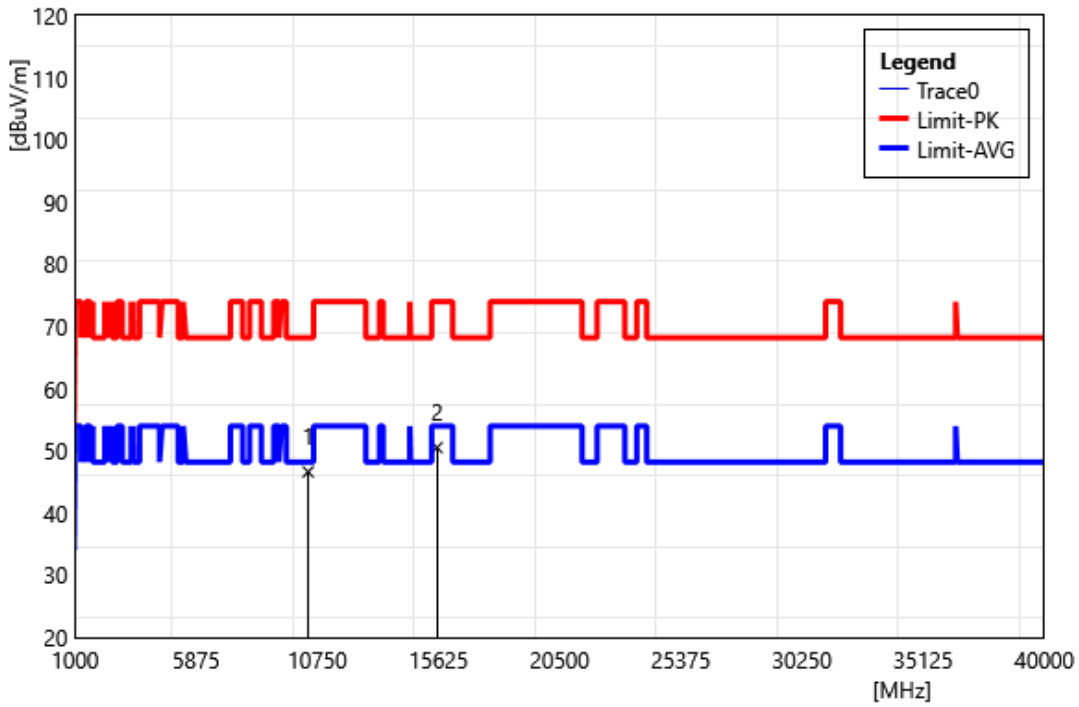

ID	Frequency MHz	Reading dBuV	Correct Factor dB/m	Result dBuV/m	Limit dBuV/m	Margin dB	Remark
1	10380.00	39.47	7.16	46.63	68.20	-21.57	PEAK
2	15570.00	41.35	9.18	50.53	74.00	-23.47	PEAK

Test Site:	96603-WG	Standard:	Part 15.407
Test Mode:	802.11n VHT40 5190 MHz		
Polarization:	Vertical		
Remark:			

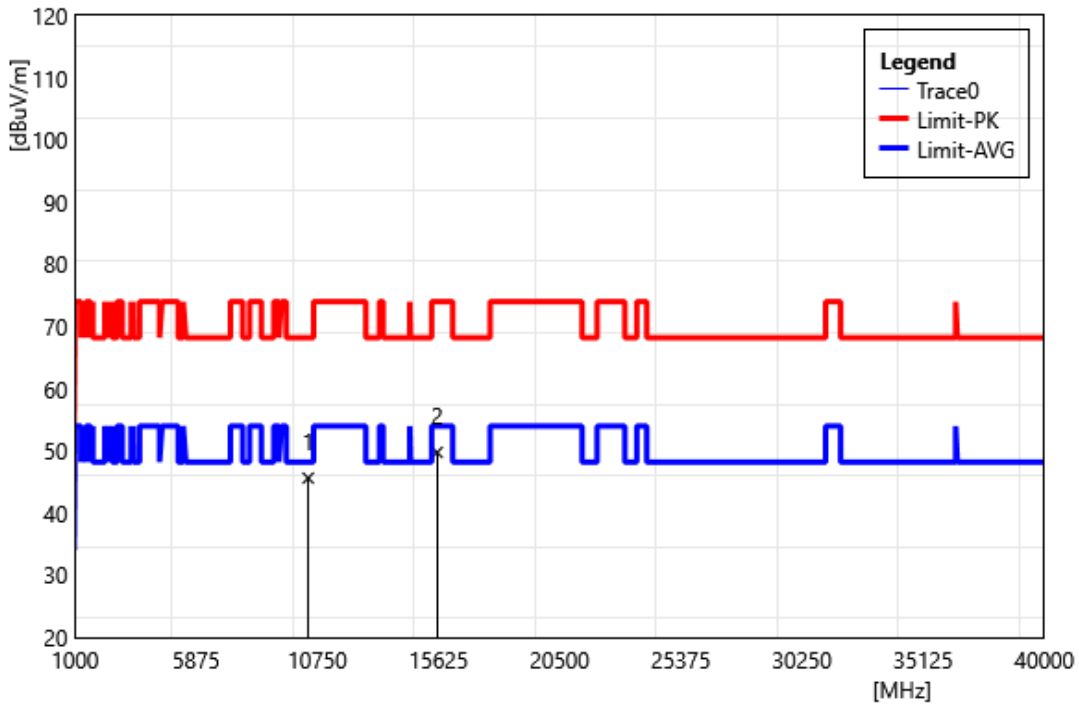

ID	Frequency MHz	Reading dBuV	Correct Factor dB/m	Result dBuV/m	Limit dBuV/m	Margin dB	Remark
1	10380.00	38.02	7.61	45.63	68.20	-22.57	PEAK
2	15570.00	40.43	9.33	49.76	74.00	-24.24	PEAK

Test Site:	96603-WG	Standard:	Part 15.407
Test Mode:	802.11n VHT40 5230 MHz		
Polarization:	Horizontal		
Remark:			

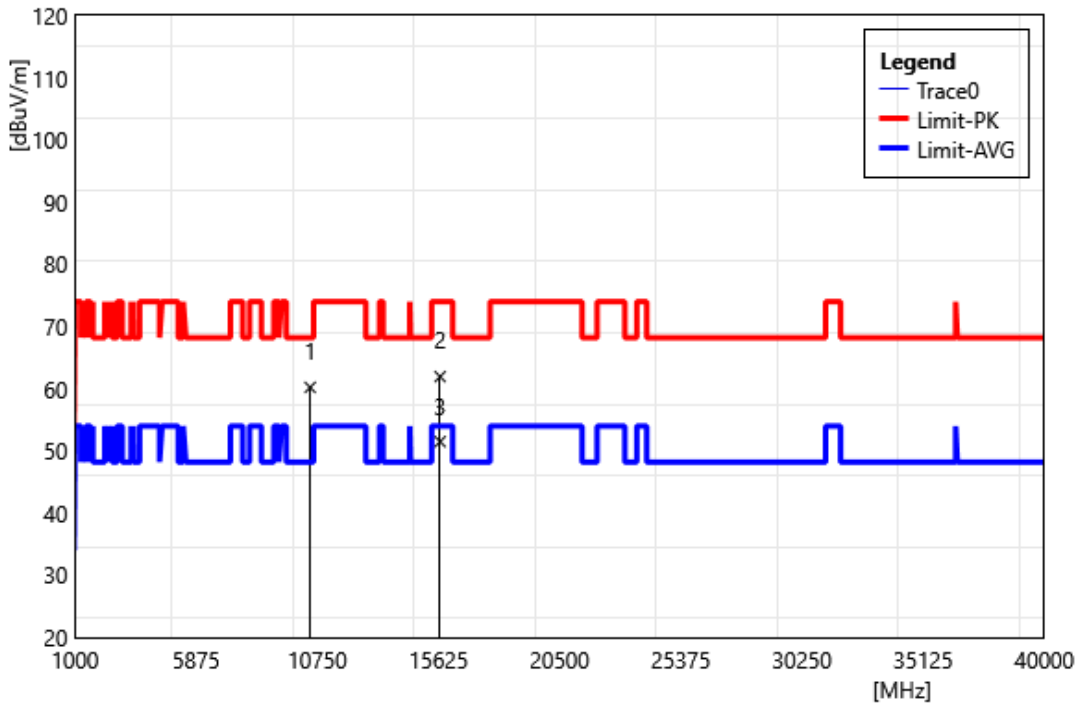

ID	Frequency MHz	Reading dBuV	Correct Factor dB/m	Result dBuV/m	Limit dBuV/m	Margin dB	Remark
1	10460.00	52.97	7.25	60.22	68.20	-7.98	PEAK
2	15690.00	52.66	9.29	61.95	74.00	-12.05	PEAK
3	15690.00	42.20	9.29	51.49	54.00	-2.51	AVG

Test Site:	96603-WG	Standard:	Part 15.407
Test Mode:	802.11n VHT40 5230 MHz		
Polarization:	Vertical		
Remark:			

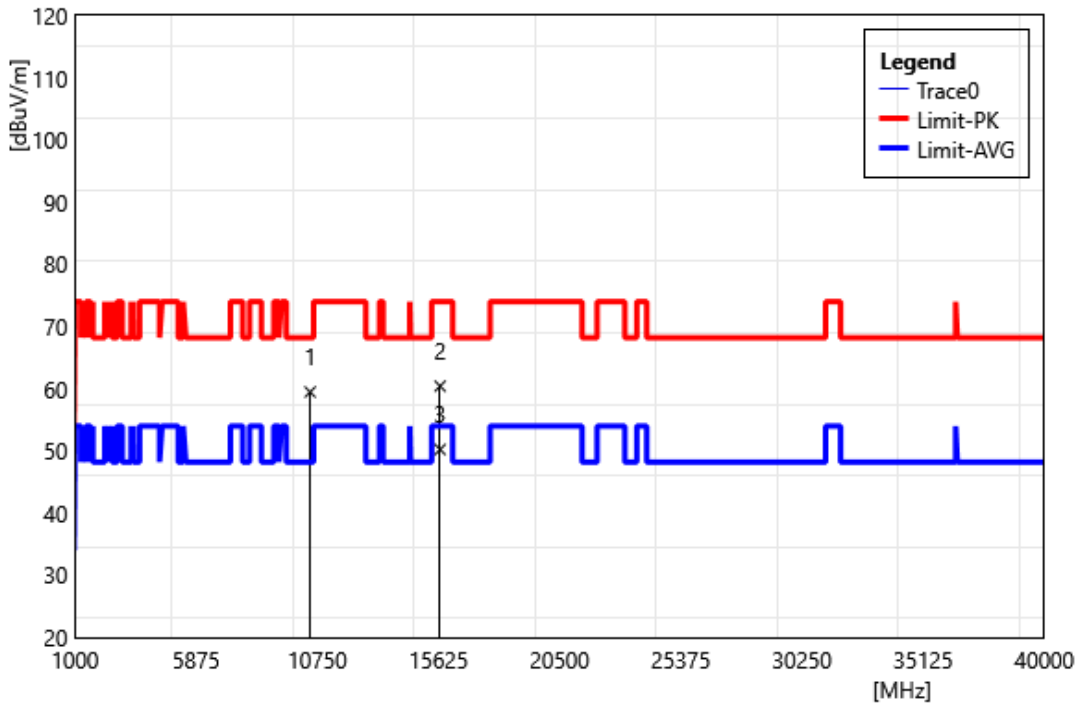

ID	Frequency MHz	Reading dBuV	Correct Factor dB/m	Result dBuV/m	Limit dBuV/m	Margin dB	Remark
1	10460.00	51.93	7.55	59.48	68.20	-8.72	PEAK
2	15690.00	50.91	9.50	60.41	74.00	-13.59	PEAK
3	15690.00	40.73	9.50	50.23	54.00	-3.77	AVG

Test Site:	96603-WG	Standard:	Part 15.407
Test Mode:	802.11n VHT40 5270 MHz		
Polarization:	Horizontal		
Remark:			

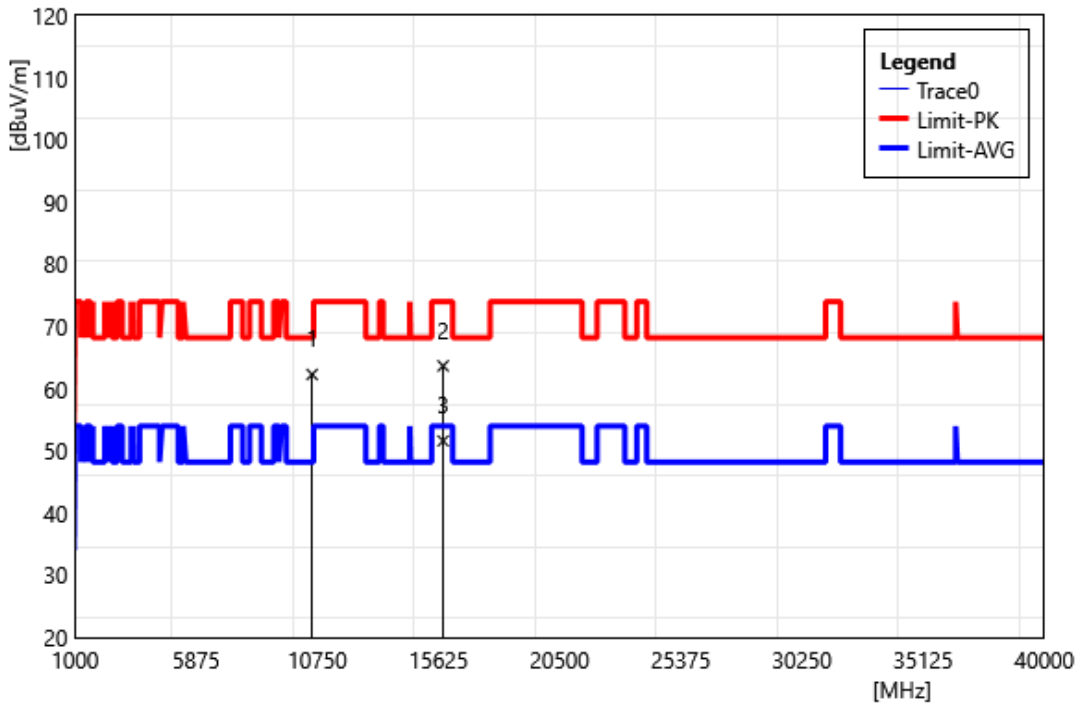

ID	Frequency MHz	Reading dBuV	Correct Factor dB/m	Result dBuV/m	Limit dBuV/m	Margin dB	Remark
1	10540.00	55.07	7.22	62.29	68.20	-5.91	PEAK
2	15810.00	53.98	9.69	63.67	74.00	-10.33	PEAK
3	15810.00	41.92	9.69	51.61	54.00	-2.39	AVG



Test Site:	96603-WG	Standard:	Part 15.407
Test Mode:	802.11n VHT40 5270 MHz		
Polarization:	Vertical		
Remark:			

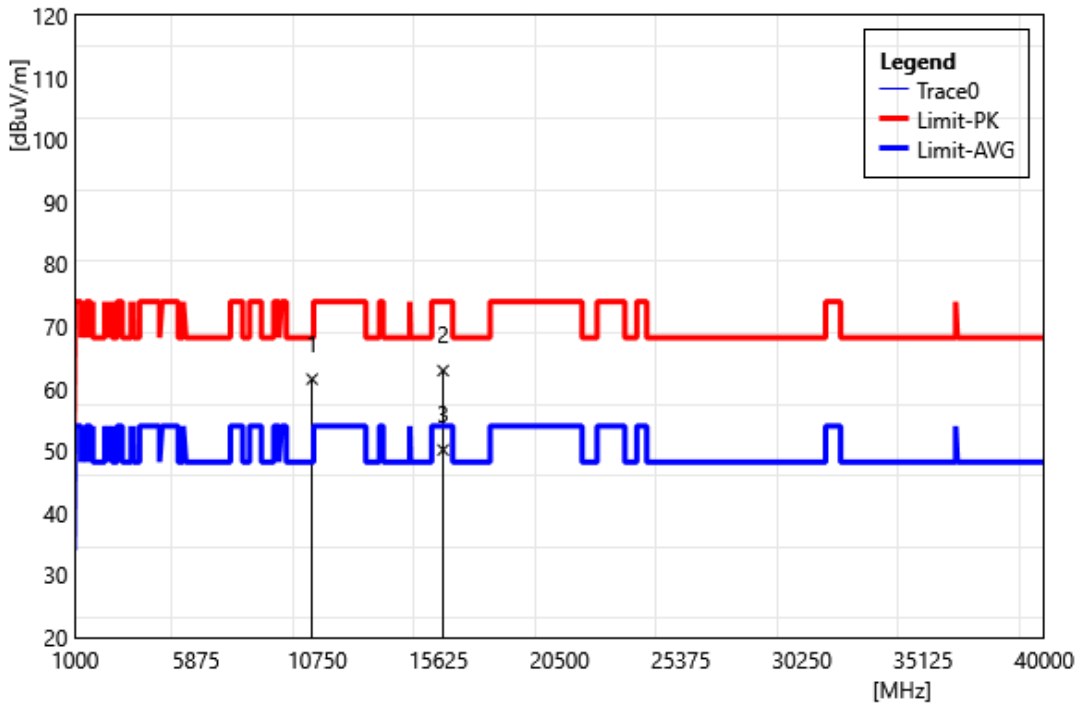

ID	Frequency MHz	Reading dBuV	Correct Factor dB/m	Result dBuV/m	Limit dBuV/m	Margin dB	Remark
1	10540.00	54.12	7.42	61.54	68.20	-6.66	PEAK
2	15810.00	53.03	9.88	62.91	74.00	-11.09	PEAK
3	15810.00	40.28	9.88	50.16	54.00	-3.84	AVG

Test Site:	96603-WG	Standard:	Part 15.407
Test Mode:	802.11n VHT40 5310 MHz		
Polarization:	Horizontal		
Remark:			

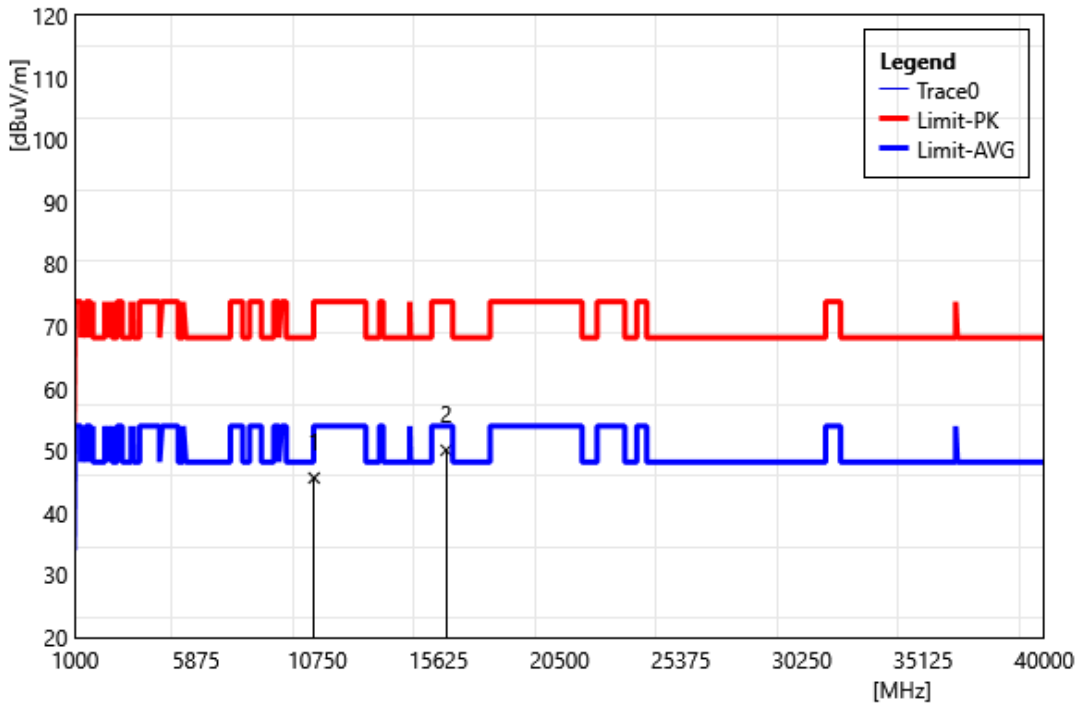

ID	Frequency MHz	Reading dBuV	Correct Factor dB/m	Result dBuV/m	Limit dBuV/m	Margin dB	Remark
1	10620.00	38.49	7.16	45.65	74.00	-28.35	PEAK
2	15930.00	40.49	9.61	50.10	74.00	-23.90	PEAK

Test Site:	96603-WG	Standard:	Part 15.407
Test Mode:	802.11n VHT40 5310 MHz		
Polarization:	Vertical		
Remark:			

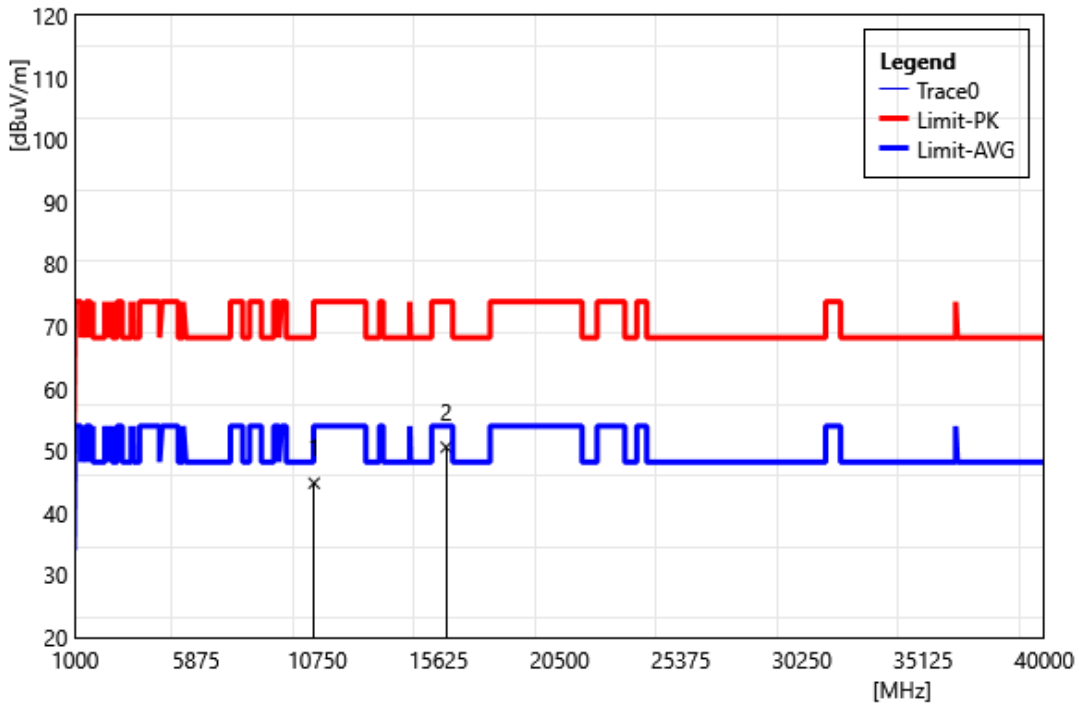

ID	Frequency MHz	Reading dBuV	Correct Factor dB/m	Result dBuV/m	Limit dBuV/m	Margin dB	Remark
1	10620.00	37.51	7.30	44.81	74.00	-29.19	PEAK
2	15930.00	40.82	9.77	50.59	74.00	-23.41	PEAK

Test Site:	96603-WG	Standard:	Part 15.407
Test Mode:	802.11n VHT40 5510 MHz		
Polarization:	Horizontal		
Remark:			

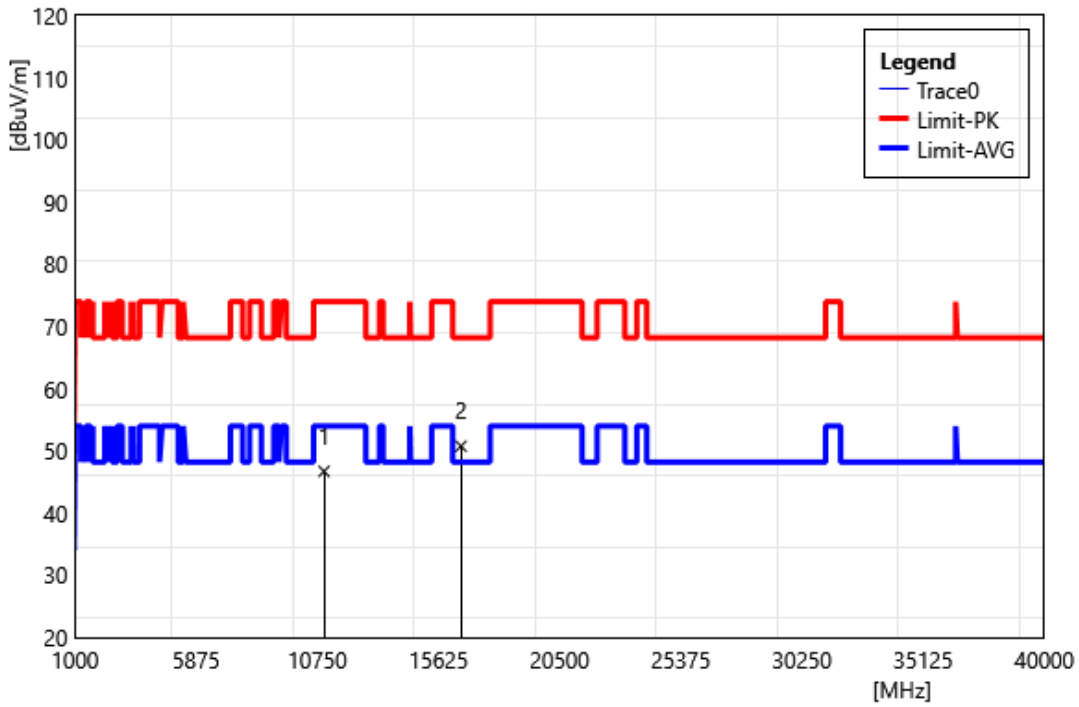

ID	Frequency MHz	Reading dBuV	Correct Factor dB/m	Result dBuV/m	Limit dBuV/m	Margin dB	Remark
1	11020.00	39.51	7.20	46.71	74.00	-27.29	PEAK
2	16530.00	41.60	9.16	50.76	68.20	-17.44	PEAK

Test Site:	96603-WG	Standard:	Part 15.407
Test Mode:	802.11n VHT40 5510 MHz		
Polarization:	Vertical		
Remark:			

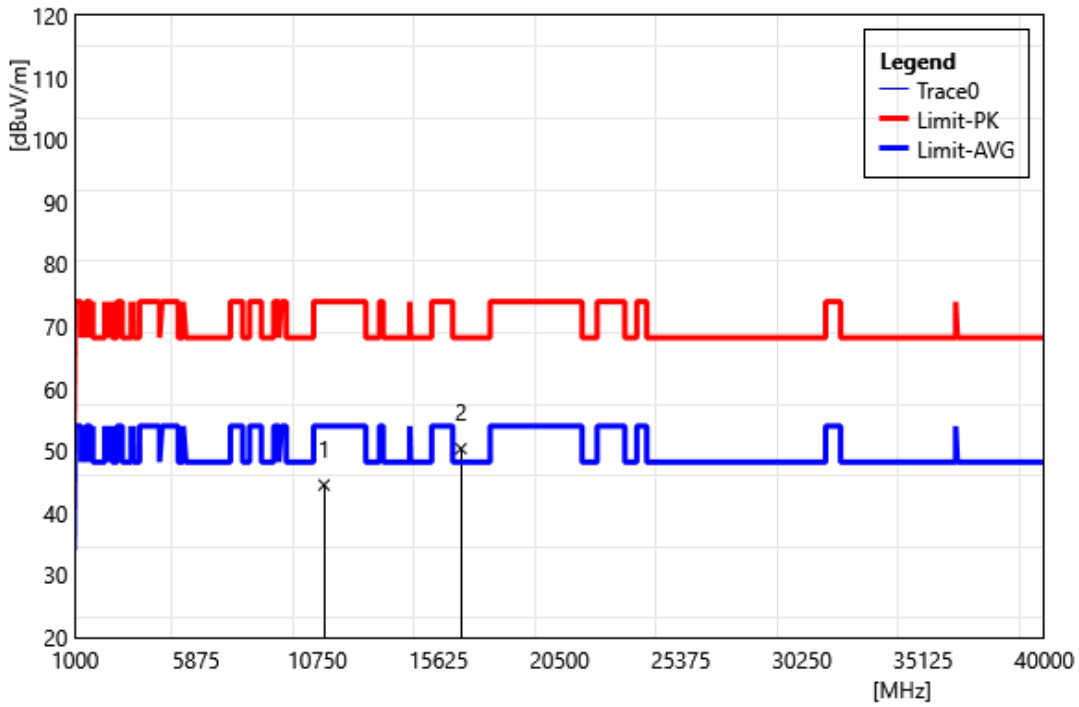

ID	Frequency MHz	Reading dBuV	Correct Factor dB/m	Result dBuV/m	Limit dBuV/m	Margin dB	Remark
1	11020.00	37.16	7.35	44.51	74.00	-29.49	PEAK
2	16530.00	40.95	9.40	50.35	68.20	-17.85	PEAK

Test Site:	96603-WG	Standard:	Part 15.407
Test Mode:	802.11n VHT40 5550 MHz		
Polarization:	Horizontal		
Remark:			

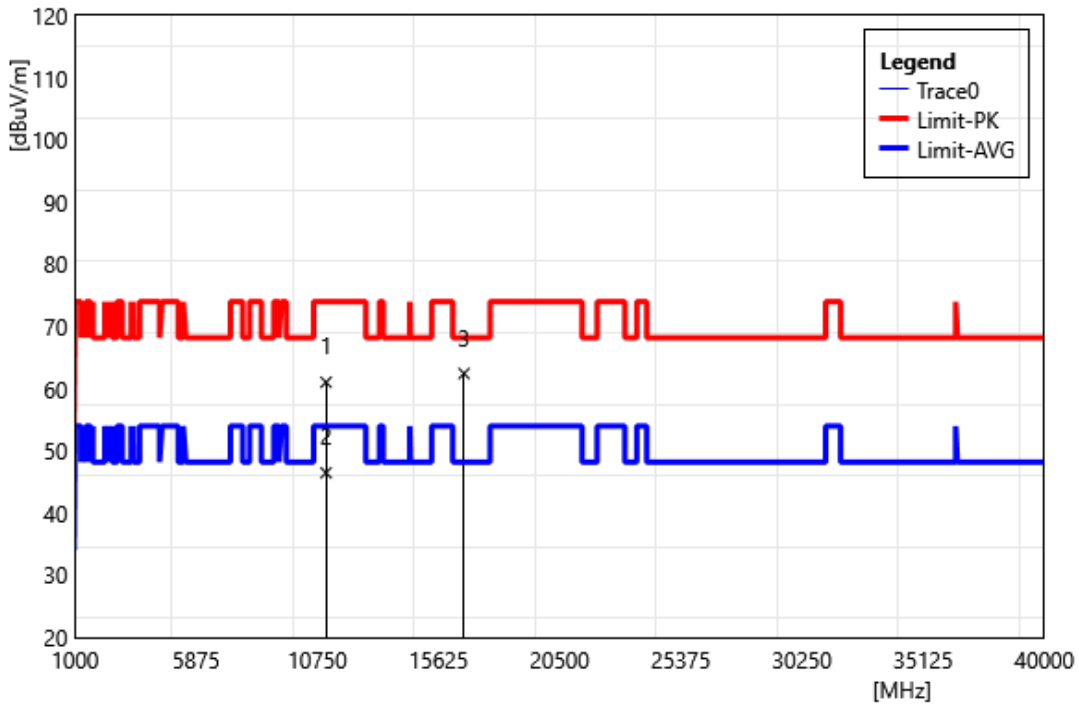

ID	Frequency MHz	Reading dBuV	Correct Factor dB/m	Result dBuV/m	Limit dBuV/m	Margin dB	Remark
1	11100.00	53.49	7.55	61.04	74.00	-12.96	PEAK
2	11100.00	38.92	7.55	46.47	54.00	-7.53	AVG
3	16650.00	53.68	8.77	62.45	68.20	-5.75	PEAK

Test Site:	96603-WG	Standard:	Part 15.407
Test Mode:	802.11n VHT40 5550 MHz		
Polarization:	Vertical		
Remark:			

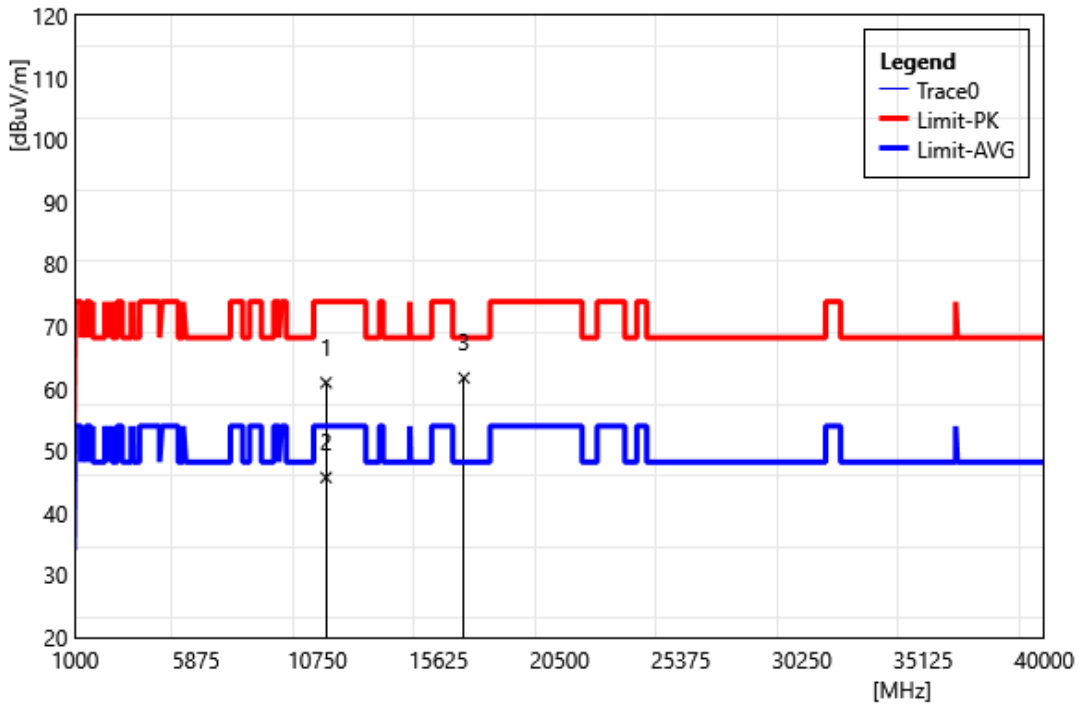

ID	Frequency MHz	Reading dBuV	Correct Factor dB/m	Result dBuV/m	Limit dBuV/m	Margin dB	Remark
1	11100.00	53.32	7.66	60.98	74.00	-13.02	PEAK
2	11100.00	38.05	7.66	45.71	54.00	-8.29	AVG
3	16650.00	52.73	9.01	61.74	68.20	-6.46	PEAK

Test Site:	96603-WG	Standard:	Part 15.407
Test Mode:	802.11n VHT40 5670 MHz		
Polarization:	Horizontal		
Remark:			

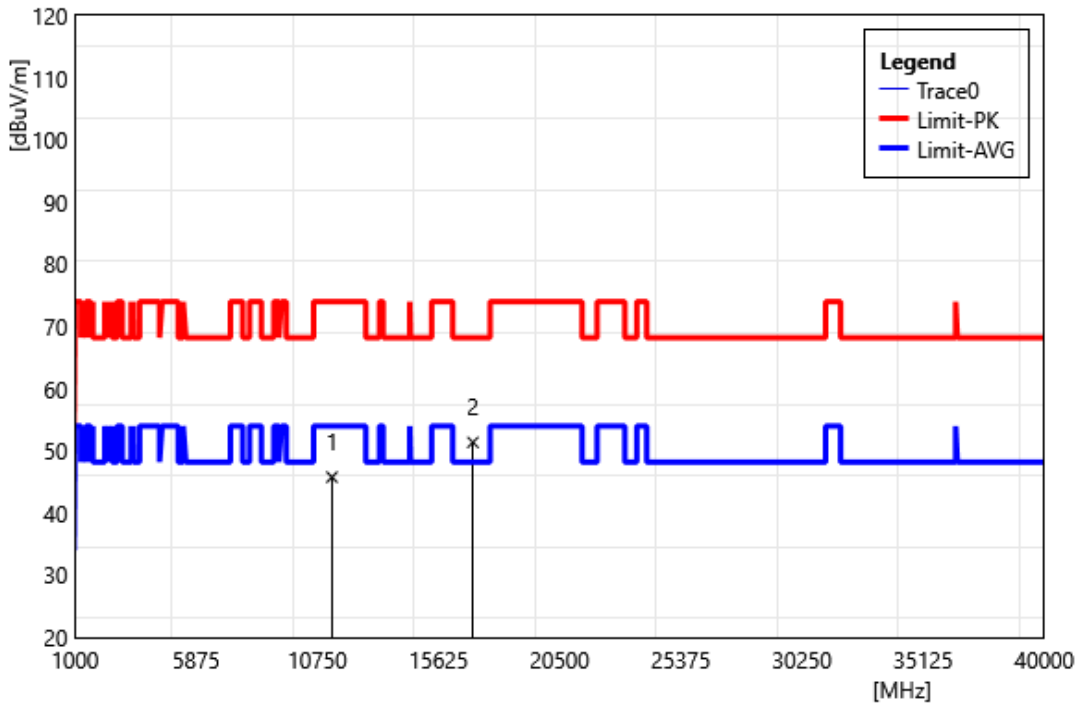

ID	Frequency MHz	Reading dBuV	Correct Factor dB/m	Result dBuV/m	Limit dBuV/m	Margin dB	Remark
1	11340.00	38.04	7.74	45.78	74.00	-28.22	PEAK
2	17010.00	44.26	7.11	51.37	68.20	-16.83	PEAK



Test Site:	96603-WG	Standard:	Part 15.407
Test Mode:	802.11n VHT40 5670 MHz		
Polarization:	Vertical		
Remark:			

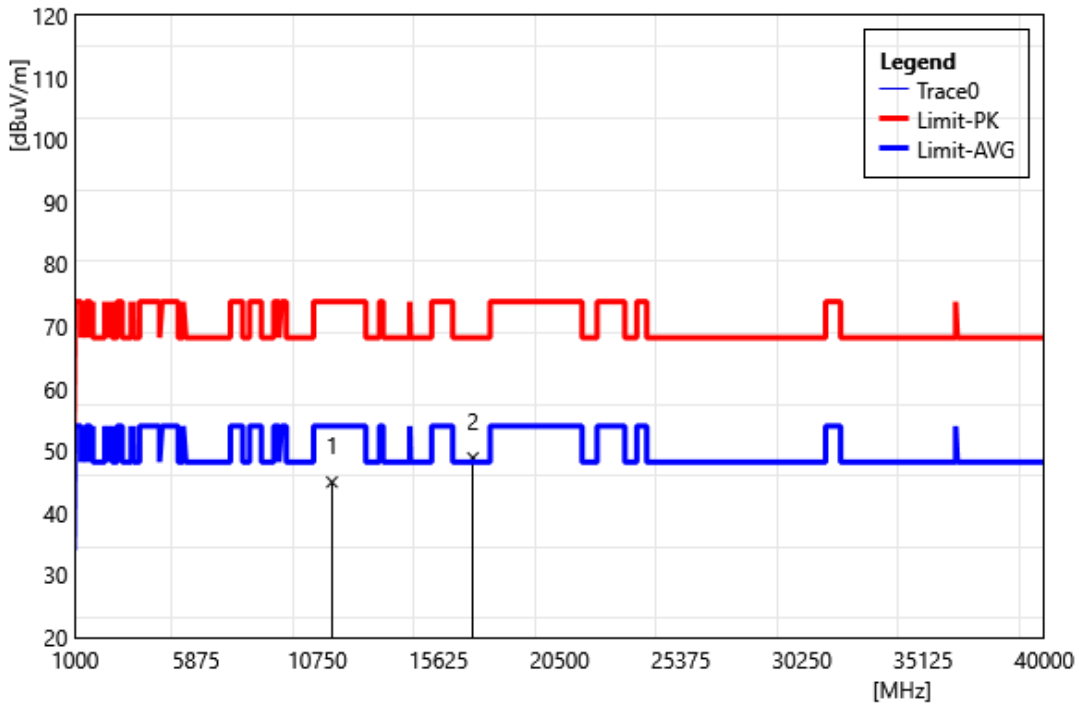

ID	Frequency MHz	Reading dBuV	Correct Factor dB/m	Result dBuV/m	Limit dBuV/m	Margin dB	Remark
1	11340.00	37.08	7.91	44.99	74.00	-29.01	PEAK
2	17010.00	41.52	7.37	48.89	68.20	-19.31	PEAK

Test Site:	96603-WG	Standard:	Part 15.407
Test Mode:	802.11n VHT40 5755 MHz		
Polarization:	Horizontal		
Remark:			

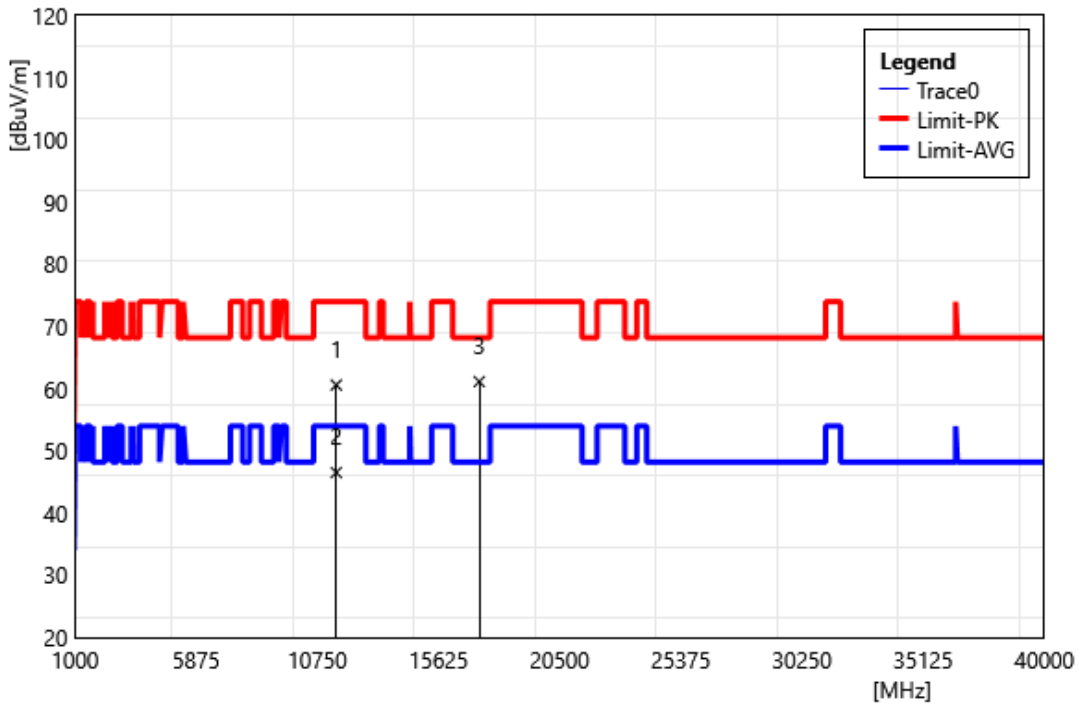

ID	Frequency MHz	Reading dBuV	Correct Factor dB/m	Result dBuV/m	Limit dBuV/m	Margin dB	Remark
1	11510.00	52.78	7.82	60.60	74.00	-13.40	PEAK
2	11510.00	38.69	7.82	46.51	54.00	-7.49	AVG
3	17265.00	53.92	7.23	61.15	68.20	-7.05	PEAK

Test Site:	96603-WG	Standard:	Part 15.407
Test Mode:	802.11n VHT40 5755 MHz		
Polarization:	Vertical		
Remark:			

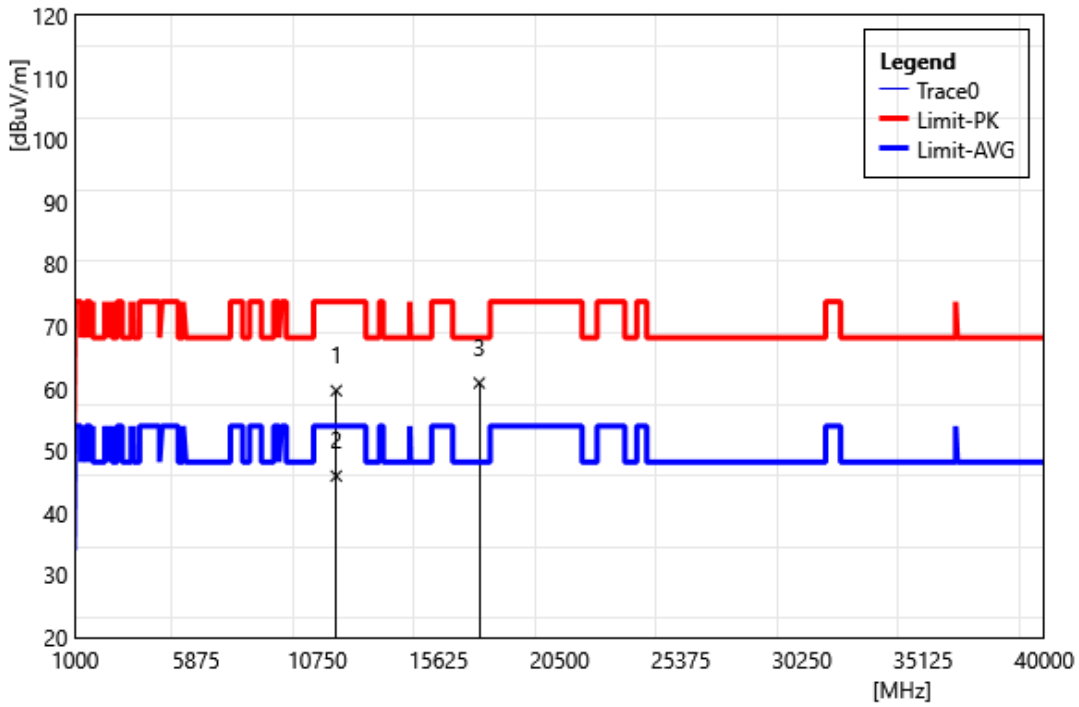

ID	Frequency MHz	Reading dBuV	Correct Factor dB/m	Result dBuV/m	Limit dBuV/m	Margin dB	Remark
1	11510.00	51.78	7.91	59.69	74.00	-14.31	PEAK
2	11510.00	38.05	7.91	45.96	54.00	-8.04	AVG
3	17265.00	53.40	7.53	60.93	68.20	-7.27	PEAK

Test Site:	96603-WG	Standard:	Part 15.407
Test Mode:	802.11n VHT40 5795 MHz		
Polarization:	Horizontal		
Remark:			

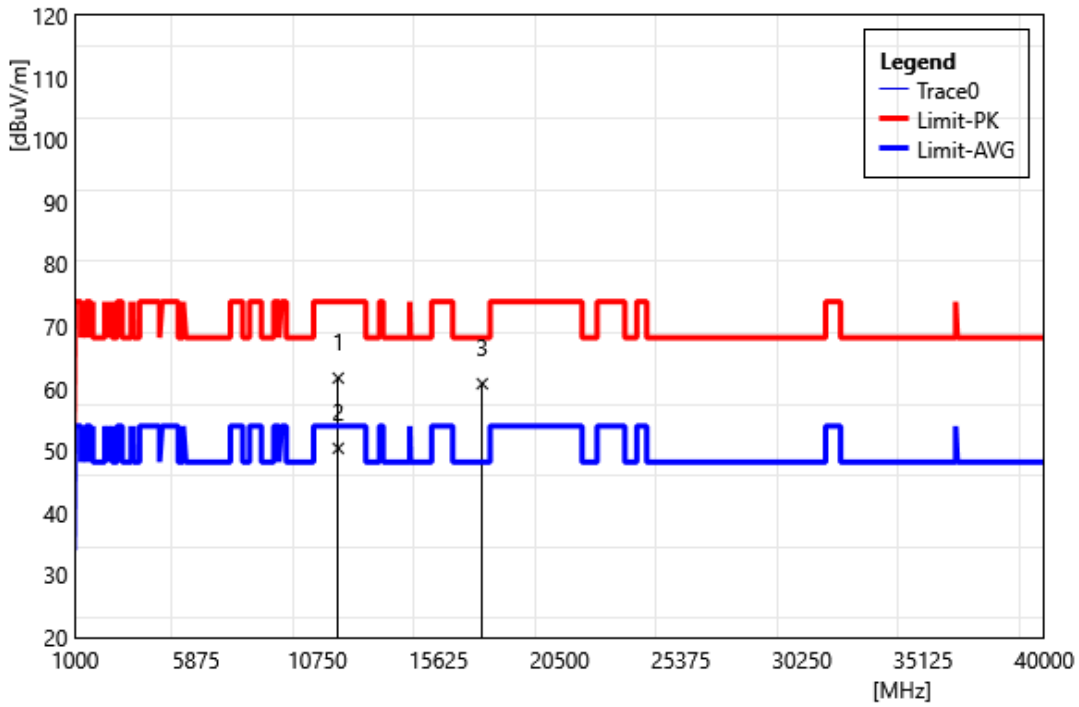

ID	Frequency MHz	Reading dBuV	Correct Factor dB/m	Result dBuV/m	Limit dBuV/m	Margin dB	Remark
1	11590.00	53.98	7.73	61.71	74.00	-12.29	PEAK
2	11590.00	42.68	7.73	50.41	54.00	-3.59	AVG
3	17385.00	53.81	6.99	60.80	68.20	-7.40	PEAK

Test Site:	96603-WG	Standard:	Part 15.407
Test Mode:	802.11n VHT40 5795 MHz		
Polarization:	Vertical		
Remark:			

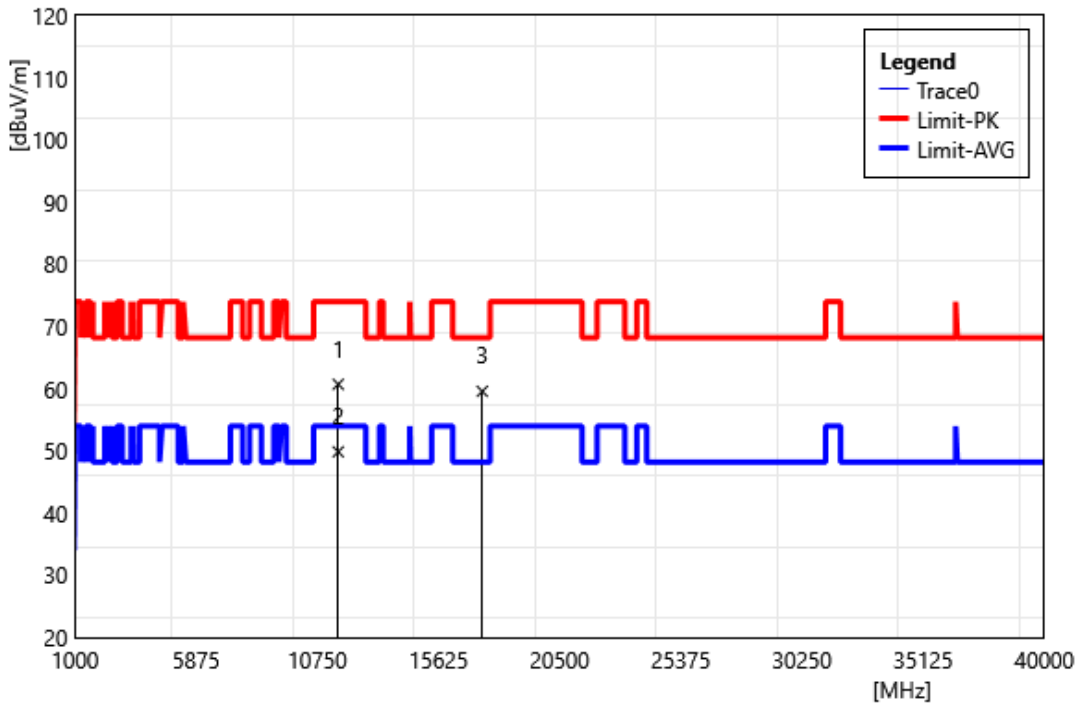

ID	Frequency MHz	Reading dBuV	Correct Factor dB/m	Result dBuV/m	Limit dBuV/m	Margin dB	Remark
1	11590.00	52.90	7.80	60.70	74.00	-13.30	PEAK
2	11590.00	42.06	7.80	49.86	54.00	-4.14	AVG
3	17385.00	52.25	7.33	59.58	68.20	-8.62	PEAK

Test Site:	96603-WG	Standard:	Part 15.407
Test Mode:	802.11n VHT80 5210 MHz		
Polarization:	Horizontal		
Remark:			

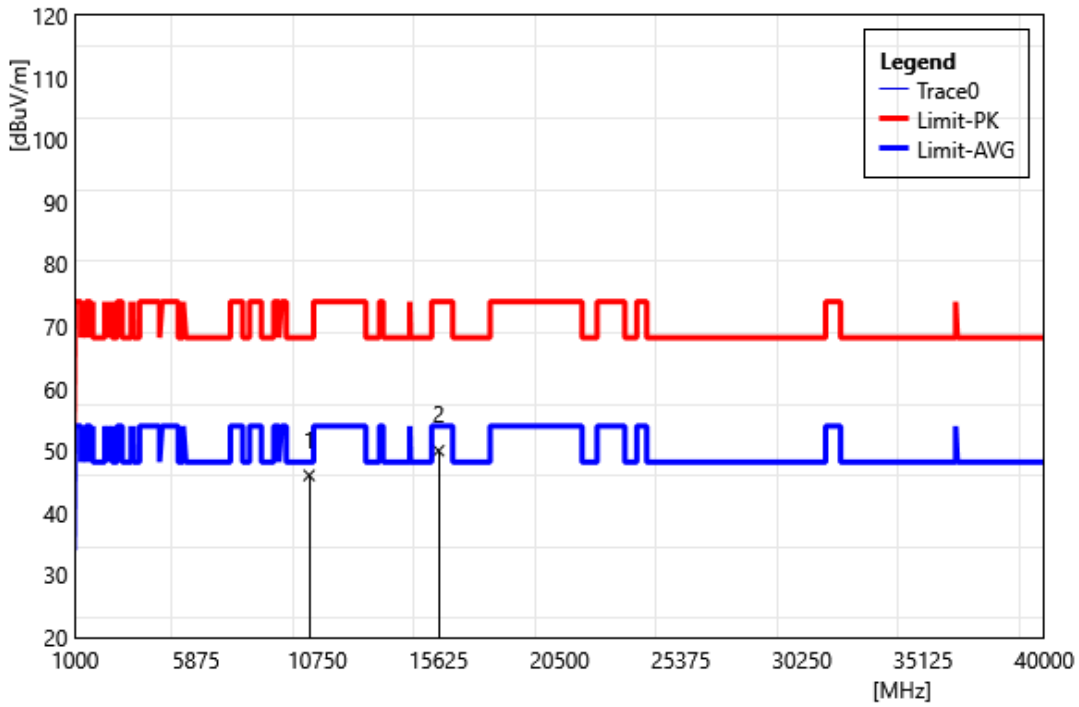

ID	Frequency MHz	Reading dBuV	Correct Factor dB/m	Result dBuV/m	Limit dBuV/m	Margin dB	Remark
1	10420.00	38.81	7.24	46.05	68.20	-22.15	PEAK
2	15630.00	40.81	9.22	50.03	74.00	-23.97	PEAK

Test Site:	96603-WG	Standard:	Part 15.407
Test Mode:	802.11n VHT80 5210 MHz		
Polarization:	Vertical		
Remark:			

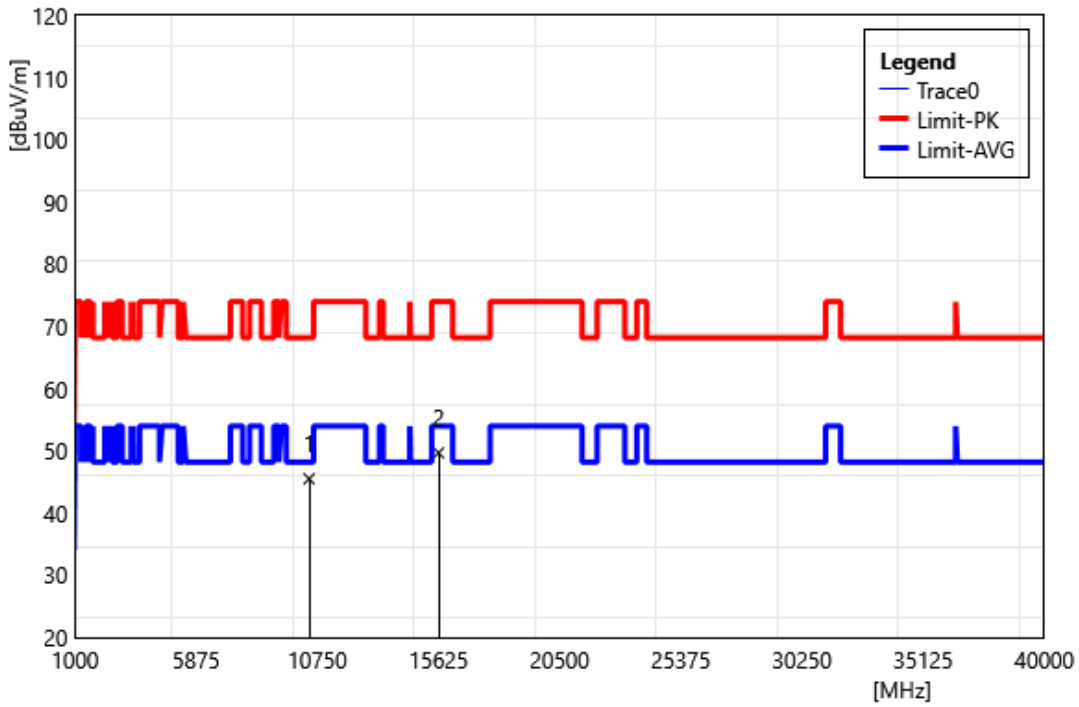

ID	Frequency MHz	Reading dBuV	Correct Factor dB/m	Result dBuV/m	Limit dBuV/m	Margin dB	Remark
1	10420.00	38.10	7.40	45.50	68.20	-22.70	PEAK
2	15630.00	40.28	9.40	49.68	74.00	-24.32	PEAK

Test Site:	96603-WG	Standard:	Part 15.407
Test Mode:	802.11n VHT80 5290 MHz		
Polarization:	Horizontal		
Remark:			

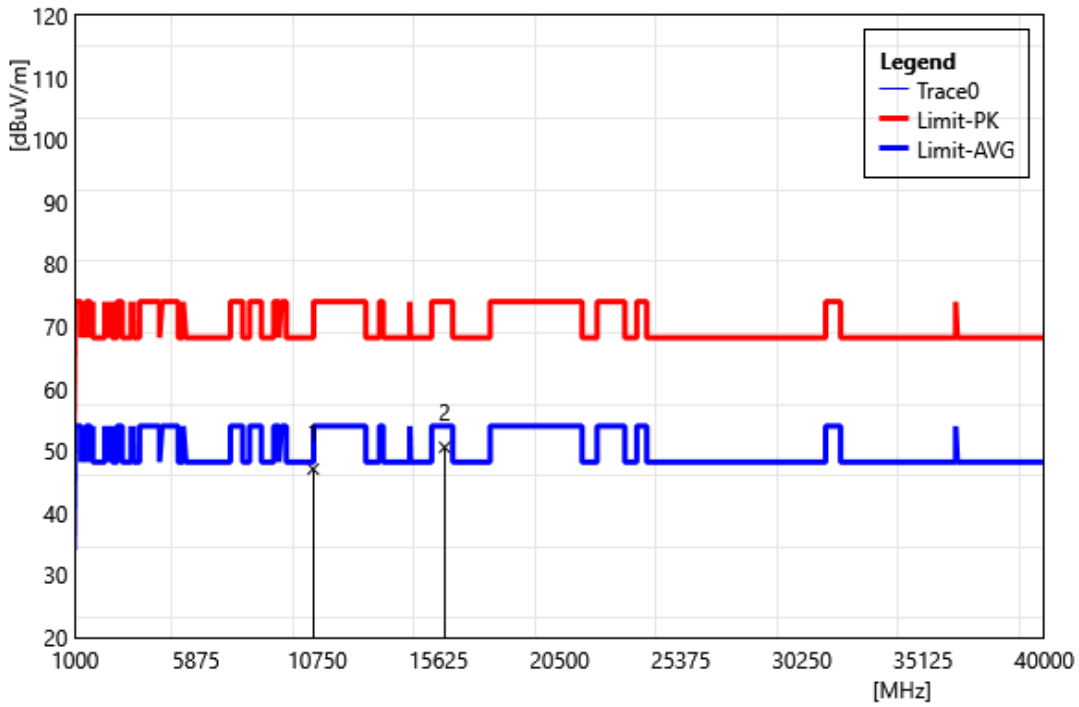

ID	Frequency MHz	Reading dBuV	Correct Factor dB/m	Result dBuV/m	Limit dBuV/m	Margin dB	Remark
1	10580.00	39.91	7.17	47.08	68.20	-21.12	PEAK
2	15870.00	41.02	9.56	50.58	74.00	-23.42	PEAK



Test Site:	96603-WG	Standard:	Part 15.407
Test Mode:	802.11n VHT80 5290 MHz		
Polarization:	Vertical		
Remark:			

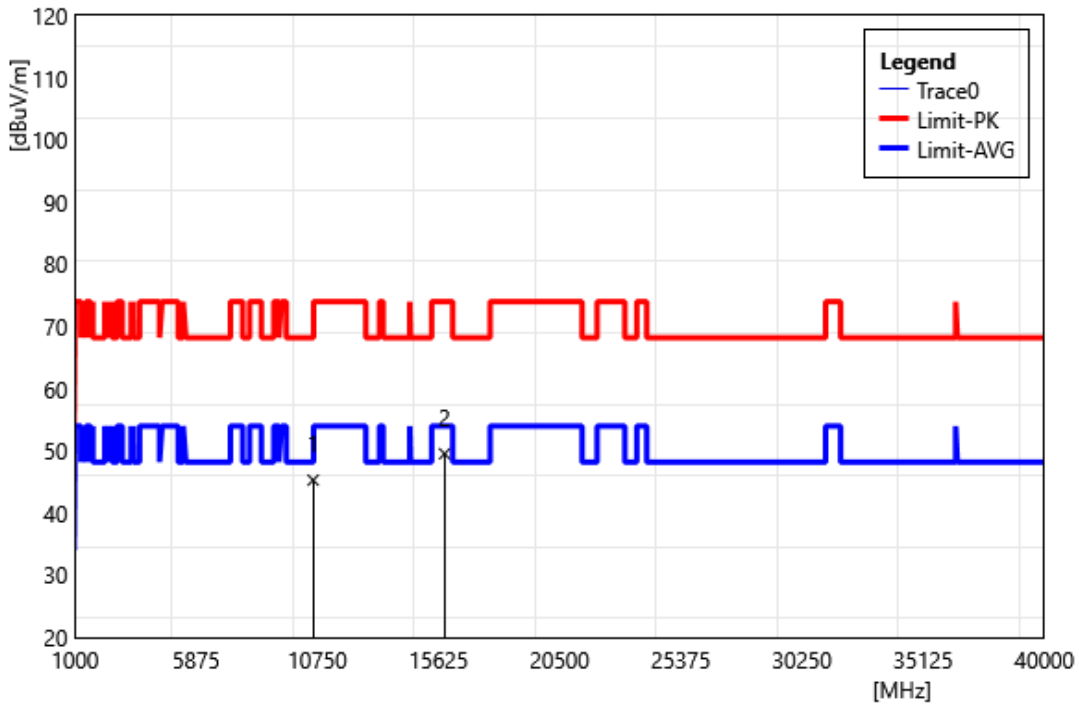

ID	Frequency MHz	Reading dBuV	Correct Factor dB/m	Result dBuV/m	Limit dBuV/m	Margin dB	Remark
1	10580.00	37.96	7.34	45.30	68.20	-22.90	PEAK
2	15870.00	39.74	9.80	49.54	74.00	-24.46	PEAK

Test Site:	96603-WG	Standard:	Part 15.407
Test Mode:	802.11n VHT80 5530 MHz		
Polarization:	Horizontal		
Remark:			

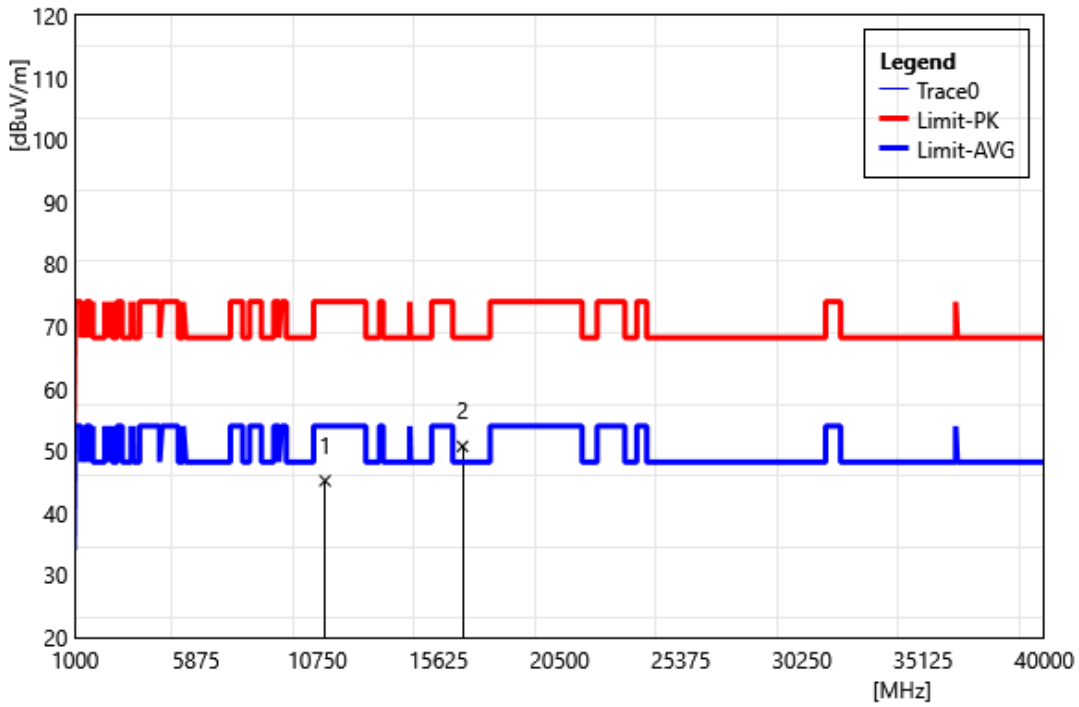

ID	Frequency MHz	Reading dBuV	Correct Factor dB/m	Result dBuV/m	Limit dBuV/m	Margin dB	Remark
1	11060.00	37.82	7.37	45.19	74.00	-28.81	PEAK
2	16590.00	41.75	8.98	50.73	68.20	-17.47	PEAK

Test Site:	96603-WG	Standard:	Part 15.407
Test Mode:	802.11n VHT80 5530 MHz		
Polarization:	Vertical		
Remark:			

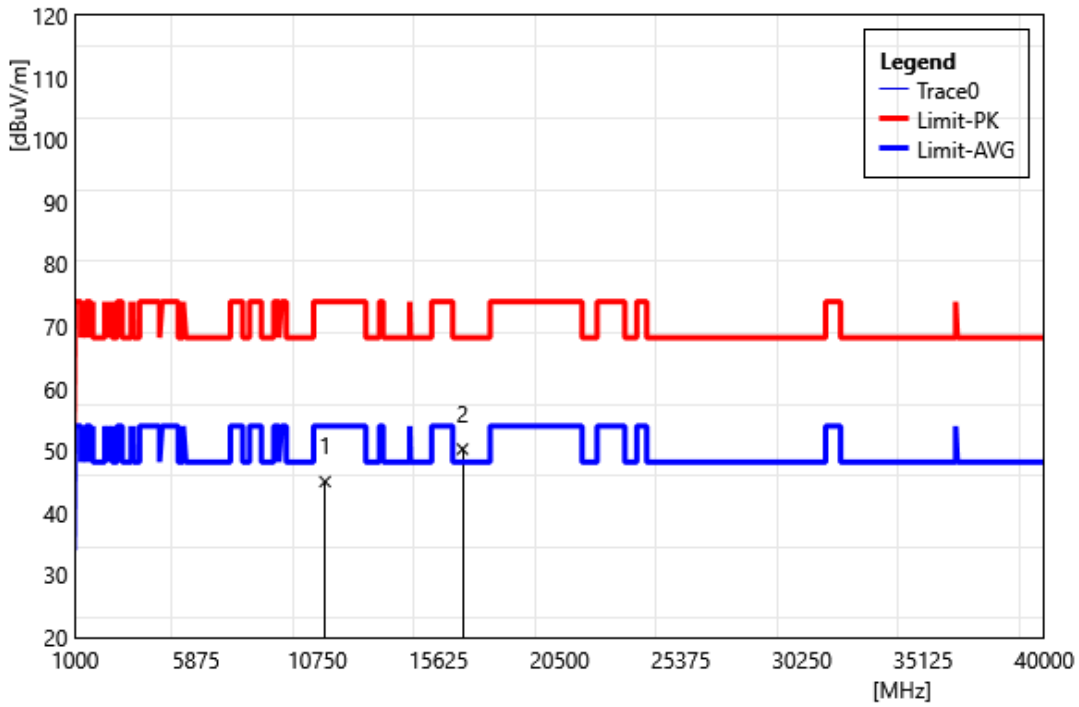

ID	Frequency MHz	Reading dBuV	Correct Factor dB/m	Result dBuV/m	Limit dBuV/m	Margin dB	Remark
1	11060.00	37.63	7.43	45.06	74.00	-28.94	PEAK
2	16590.00	41.10	9.18	50.28	68.20	-17.92	PEAK

Test Site:	96603-WG	Standard:	Part 15.407
Test Mode:	802.11n VHT80 5610 MHz		
Polarization:	Horizontal		
Remark:			

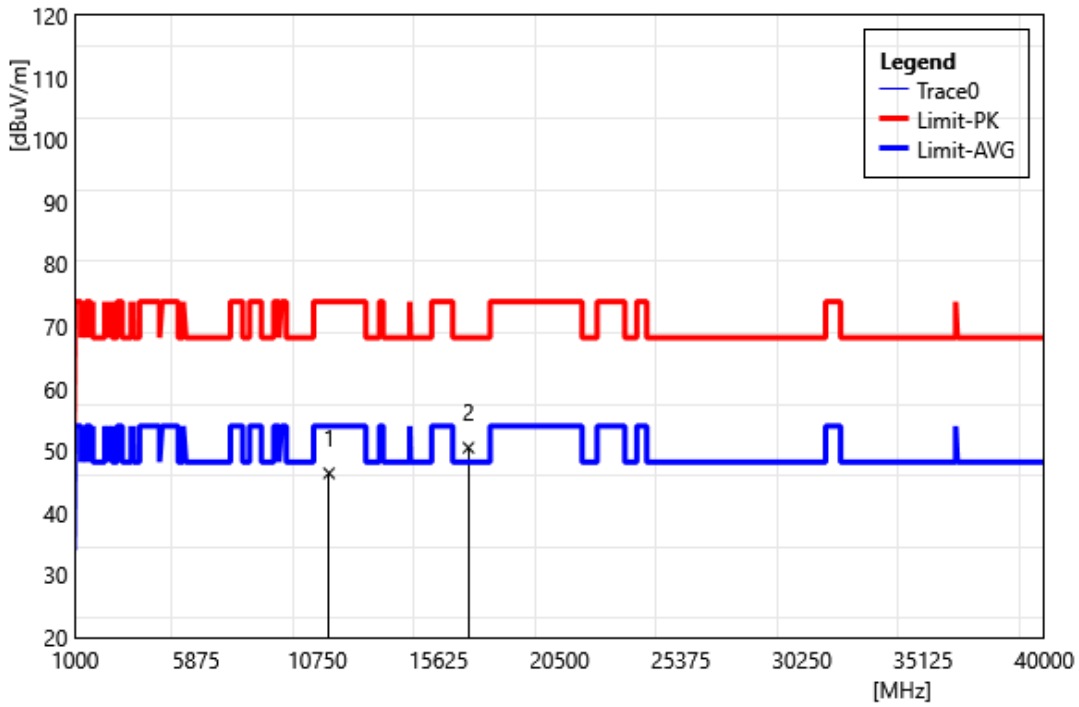

ID	Frequency MHz	Reading dBuV	Correct Factor dB/m	Result dBuV/m	Limit dBuV/m	Margin dB	Remark
1	11220.00	38.69	7.71	46.40	74.00	-27.60	PEAK
2	16830.00	42.35	8.16	50.51	68.20	-17.69	PEAK

Test Site:	96603-WG	Standard:	Part 15.407
Test Mode:	802.11n VHT80 5610 MHz		
Polarization:	Vertical		
Remark:			

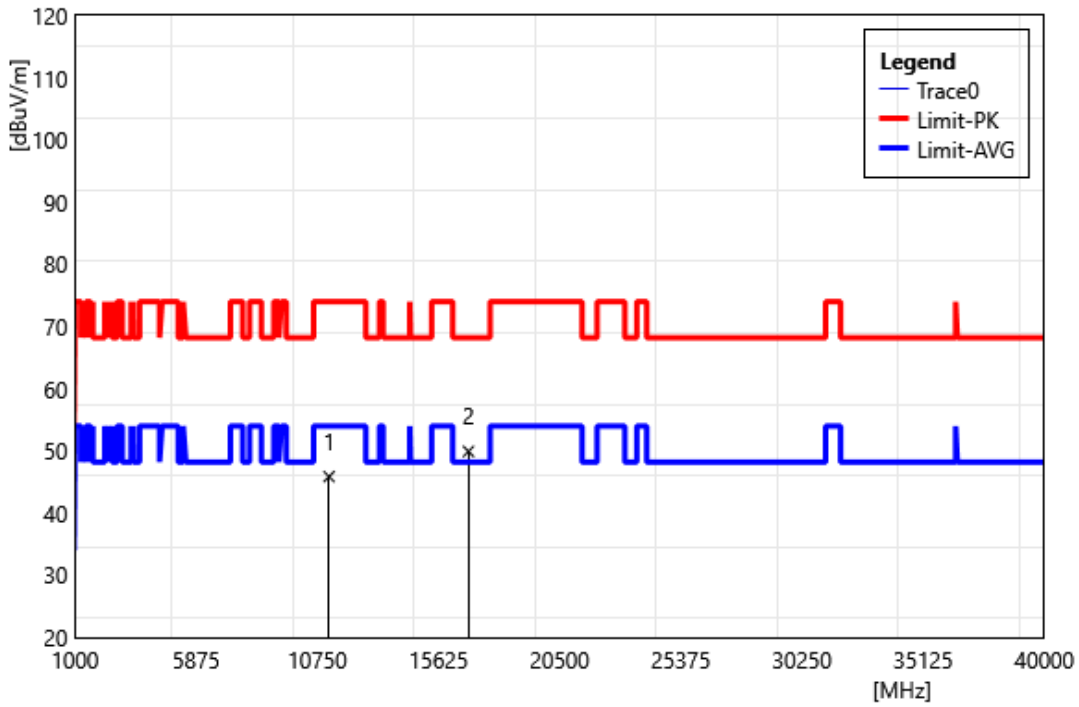

ID	Frequency MHz	Reading dBuV	Correct Factor dB/m	Result dBuV/m	Limit dBuV/m	Margin dB	Remark
1	11220.00	38.07	7.79	45.86	74.00	-28.14	PEAK
2	16830.00	41.52	8.39	49.91	68.20	-18.29	PEAK

Test Site:	96603-WG	Standard:	Part 15.407
Test Mode:	802.11n VHT80 5775 MHz		
Polarization:	Horizontal		
Remark:			

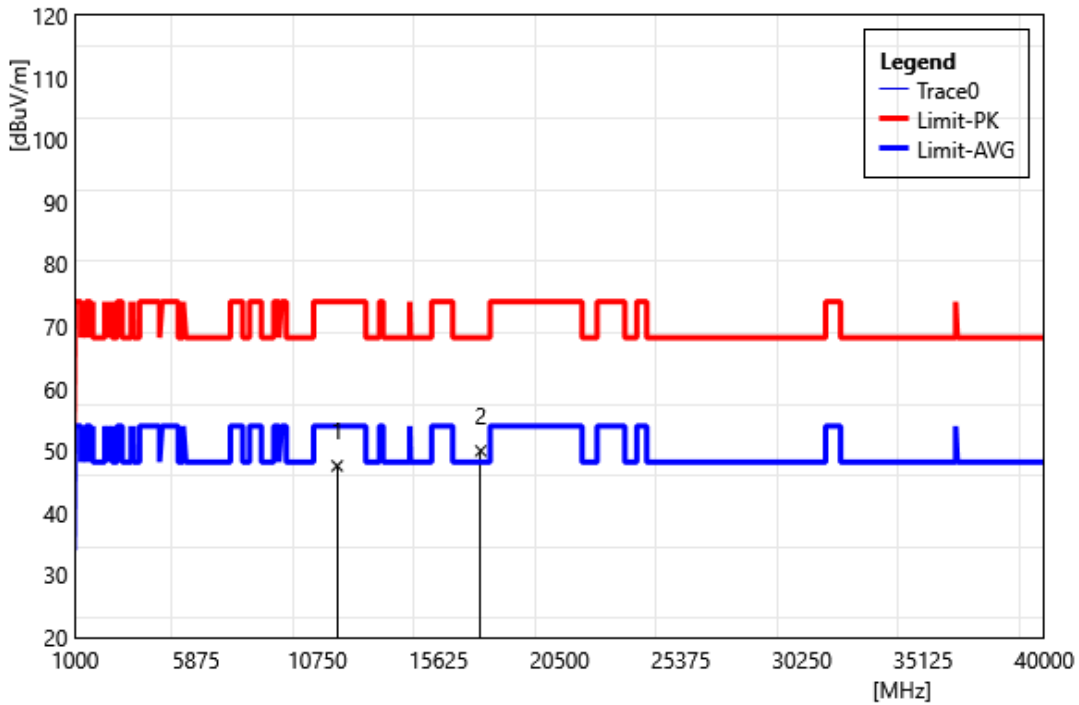

ID	Frequency MHz	Reading dBuV	Correct Factor dB/m	Result dBuV/m	Limit dBuV/m	Margin dB	Remark
1	11550.00	39.80	7.78	47.58	74.00	-26.42	PEAK
2	17325.00	42.83	7.16	49.99	68.20	-18.21	PEAK

Test Site:	96603-WG	Standard:	Part 15.407
Test Mode:	802.11n VHT80 5775 MHz		
Polarization:	Vertical		
Remark:			

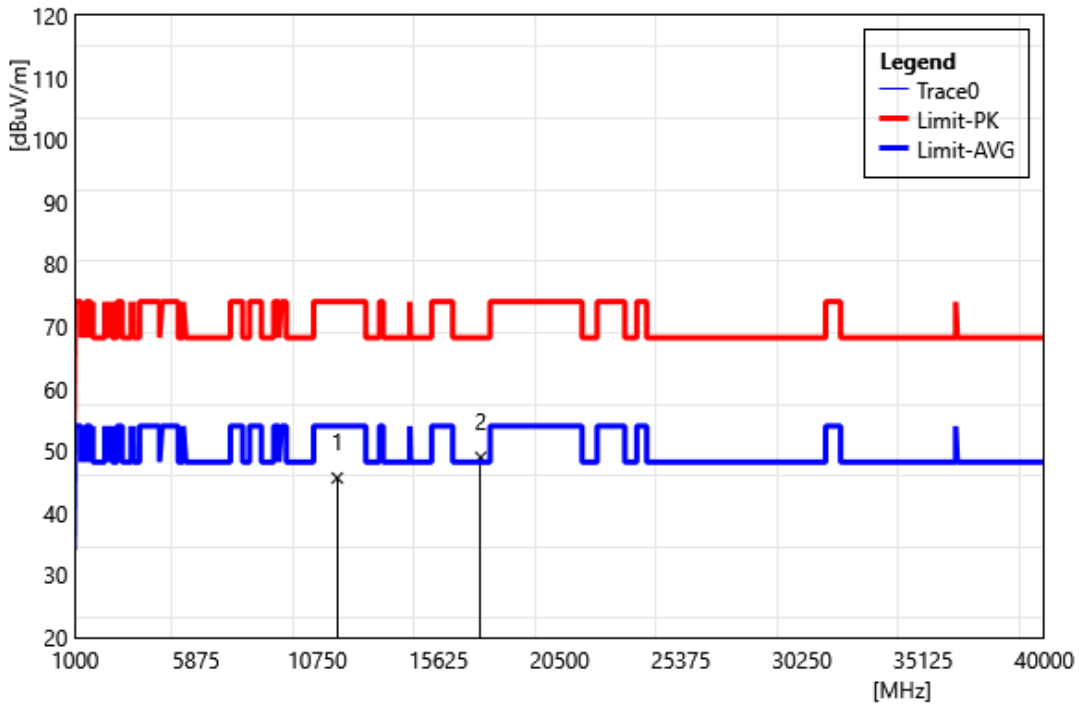

ID	Frequency MHz	Reading dBuV	Correct Factor dB/m	Result dBuV/m	Limit dBuV/m	Margin dB	Remark
1	11550.00	37.81	7.83	45.64	74.00	-28.36	PEAK
2	17325.00	41.54	7.43	48.97	68.20	-19.23	PEAK

Band Edge

Peak
------

Test Site:	96603-WG	Standard:	Part 15.407
Test Mode:	802.11a 5180 MHz		
Polarization:	Vertical		
Remark:			

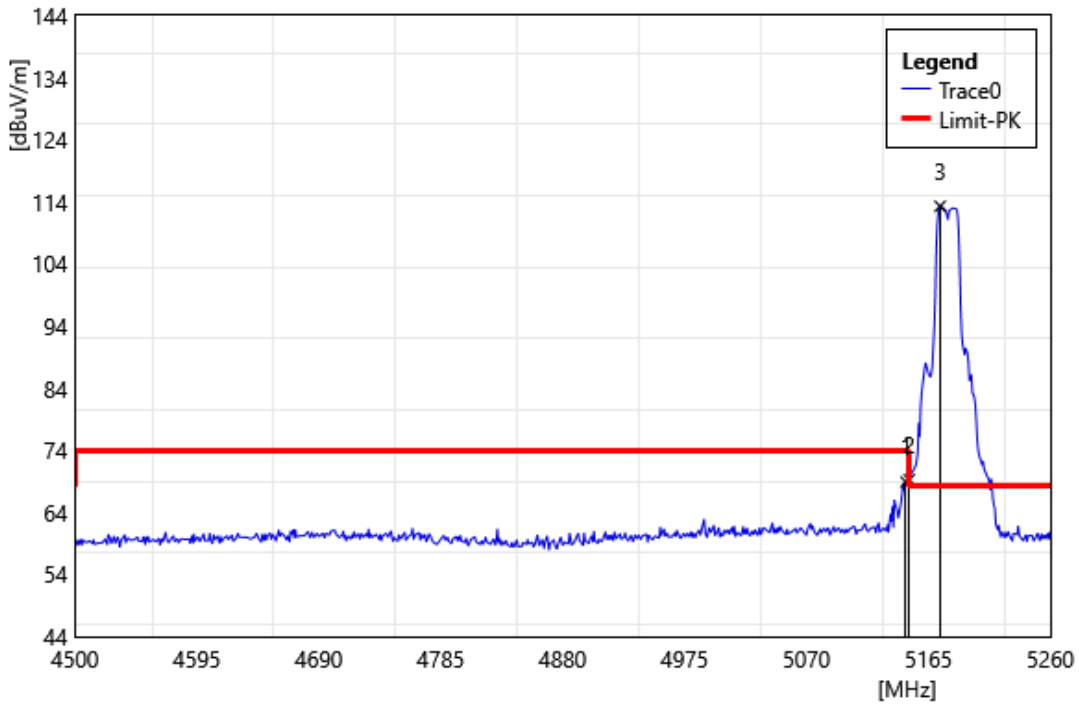

ID	Frequency MHz	Reading dBuV	Correct Factor dB/m	Result dBuV/m	Limit dBuV/m	Margin dB	Remark
1	5147.52	66.77	2.10	68.87	74.00	-5.13	PEAK
2	5150.00	67.16	2.10	69.26	74.00	-4.74	PEAK
3	5174.12	111.25	2.04	113.29	68.20	45.09	PEAK



Test Site:	96603-WG	Standard:	Part 15.407
Test Mode:	802.11a 5180 MHz		
Polarization:	Horizontal		
Remark:			

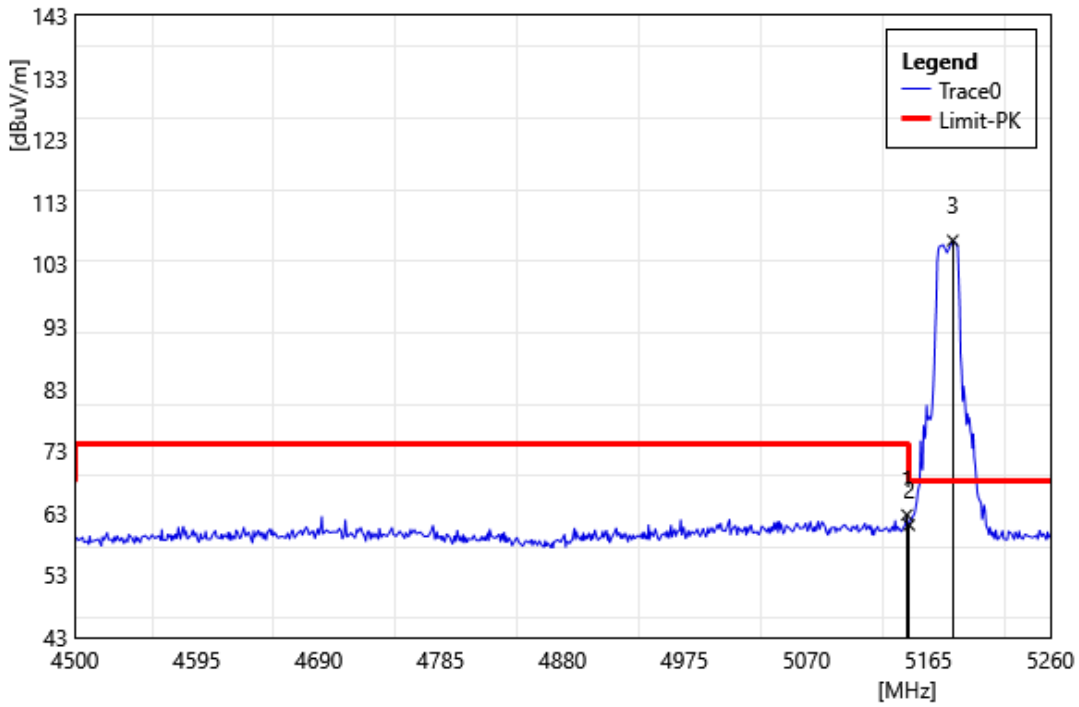

ID	Frequency MHz	Reading dBuV	Correct Factor dB/m	Result dBuV/m	Limit dBuV/m	Margin dB	Remark
1	5148.28	60.61	2.10	62.71	74.00	-11.29	PEAK
2	5150.00	58.97	2.10	61.07	74.00	-12.93	PEAK
3	5184.00	104.85	1.99	106.84	68.20	38.64	PEAK

Test Site:	96603-WG	Standard:	Part 15.407
Test Mode:	802.11a 5320 MHz		
Polarization:	Vertical		
Remark:			

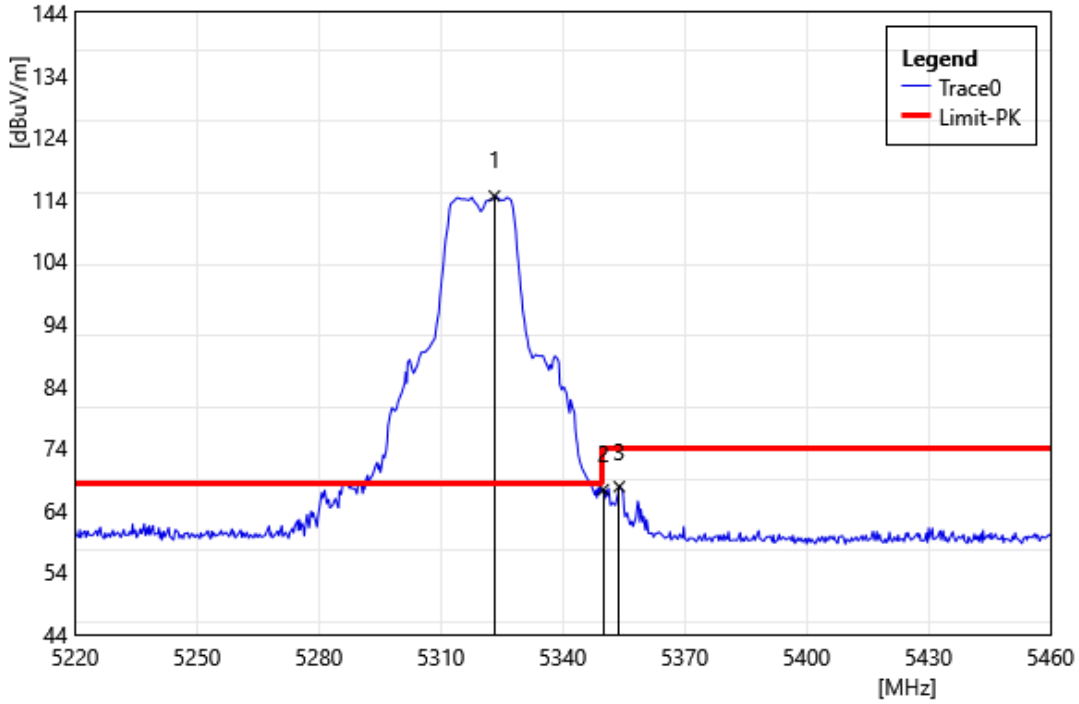

ID	Frequency MHz	Reading dBuV	Correct Factor dB/m	Result dBuV/m	Limit dBuV/m	Margin dB	Remark
1	5323.20	112.81	1.71	114.52	68.20	46.32	PEAK
2	5350.00	65.56	1.72	67.28	74.00	-6.72	PEAK
3	5353.92	66.04	1.72	67.76	74.00	-6.24	PEAK

Test Site:	96603-WG	Standard:	Part 15.407
Test Mode:	802.11a 5320 MHz		
Polarization:	Horizontal		
Remark:			

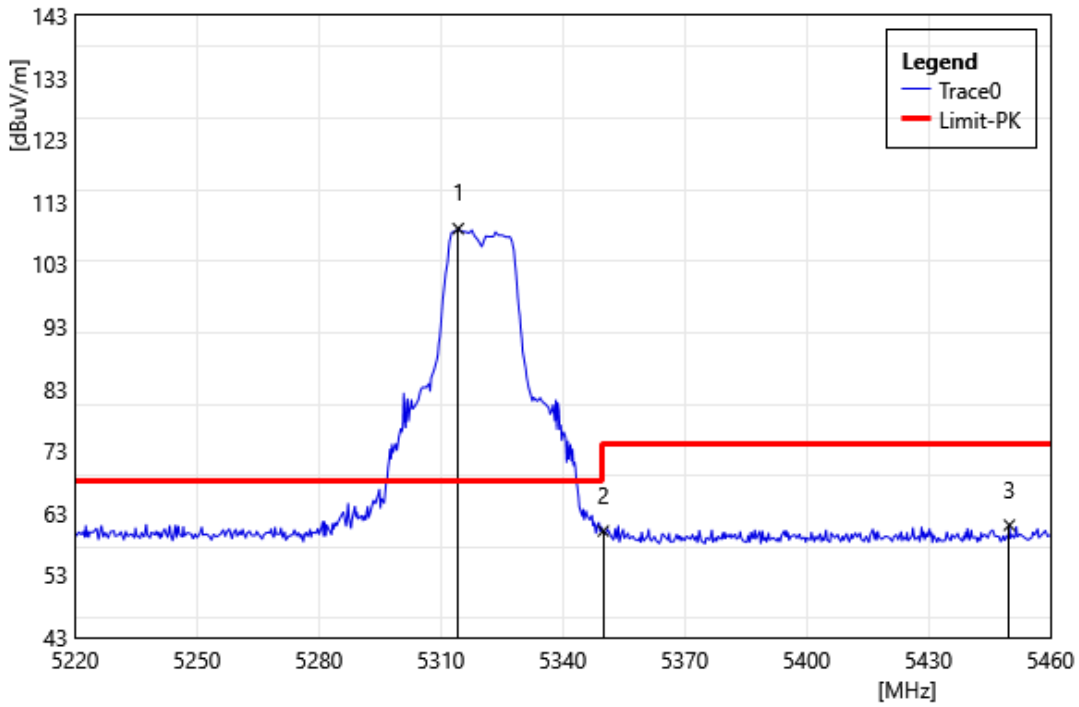

ID	Frequency MHz	Reading dBuV	Correct Factor dB/m	Result dBuV/m	Limit dBuV/m	Margin dB	Remark
1	5314.32	107.04	1.70	108.74	68.20	40.54	PEAK
2	5350.00	58.40	1.72	60.12	74.00	-13.88	PEAK
3	5449.92	59.10	1.95	61.05	74.00	-12.95	PEAK

Test Site:	96603-WG	Standard:	Part 15.407
Test Mode:	802.11a 5500 MHz		
Polarization:	Vertical		
Remark:			

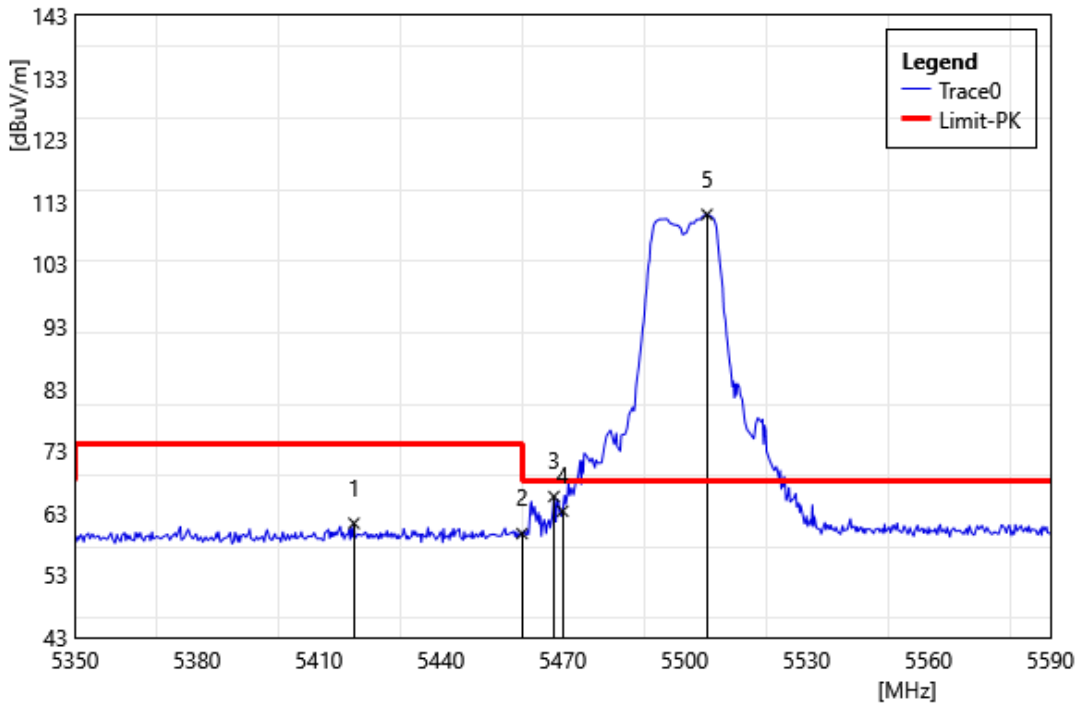

ID	Frequency MHz	Reading dBuV	Correct Factor dB/m	Result dBuV/m	Limit dBuV/m	Margin dB	Remark
1	5418.64	59.60	1.75	61.35	74.00	-12.65	PEAK
2	5460.00	57.69	2.01	59.70	74.00	-14.30	PEAK
3	5467.84	63.61	2.04	65.65	68.20	-2.55	PEAK
4	5470.00	61.26	2.05	63.31	68.20	-4.89	PEAK
5	5505.52	108.71	2.31	111.02	68.20	42.82	PEAK

Test Site:	96603-WG	Standard:	Part 15.407
Test Mode:	802.11a 5500 MHz		
Polarization:	Horizontal		
Remark:			

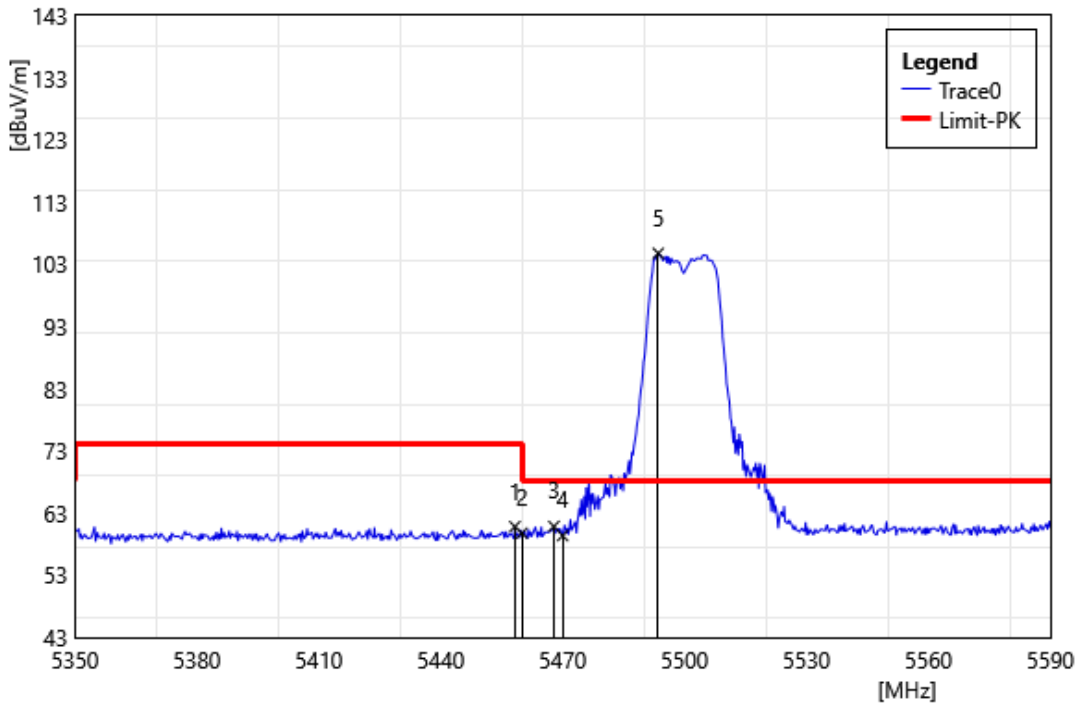

ID	Frequency MHz	Reading dBuV	Correct Factor dB/m	Result dBuV/m	Limit dBuV/m	Margin dB	Remark
1	5458.24	58.83	1.99	60.82	74.00	-13.18	PEAK
2	5460.00	57.76	2.01	59.77	74.00	-14.23	PEAK
3	5467.84	58.82	2.04	60.86	68.20	-7.35	PEAK
4	5470.00	57.32	2.05	59.37	68.20	-8.83	PEAK
5	5493.52	102.54	2.23	104.77	68.20	36.57	PEAK

Test Site:	96603-WG	Standard:	Part 15.407
Test Mode:	802.11a 5700 MHz		
Polarization:	Vertical		
Remark:			

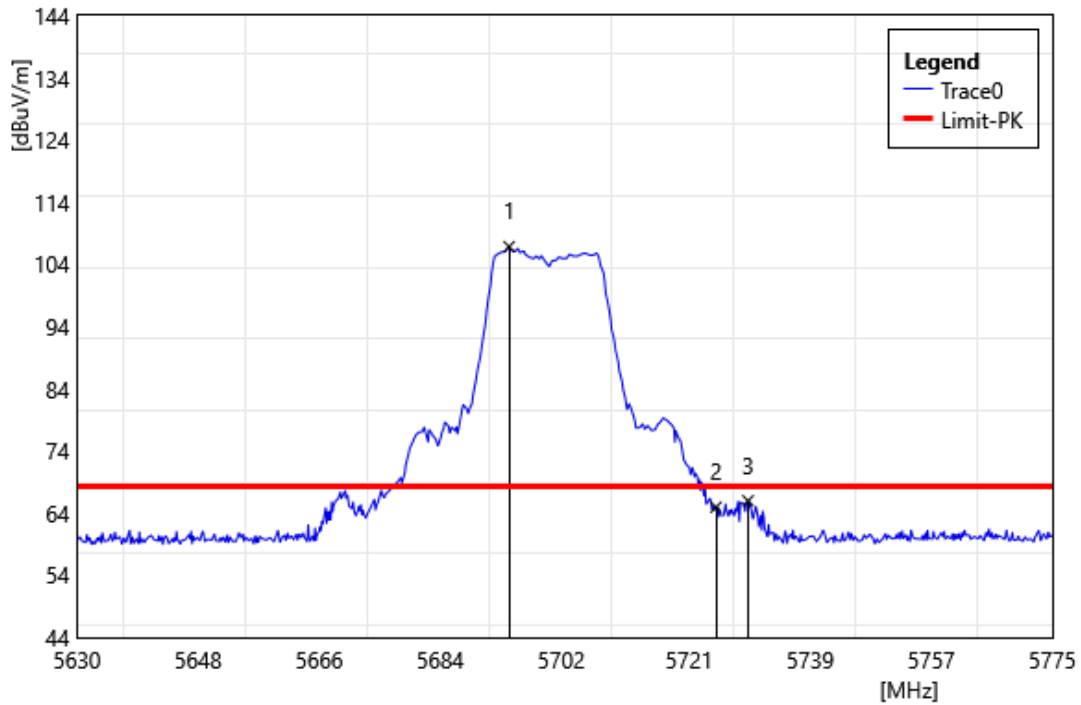

ID	Frequency MHz	Reading dBuV	Correct Factor dB/m	Result dBuV/m	Limit dBuV/m	Margin dB	Remark
1	5694.24	104.05	2.80	106.85	68.20	38.65	PEAK
2	5725.00	61.88	3.07	64.95	68.20	-3.25	PEAK
3	5729.76	62.84	3.14	65.98	68.20	-2.22	PEAK

Test Site:	96603-WG	Standard:	Part 15.407
Test Mode:	802.11a 5700 MHz		
Polarization:	Horizontal		
Remark:			

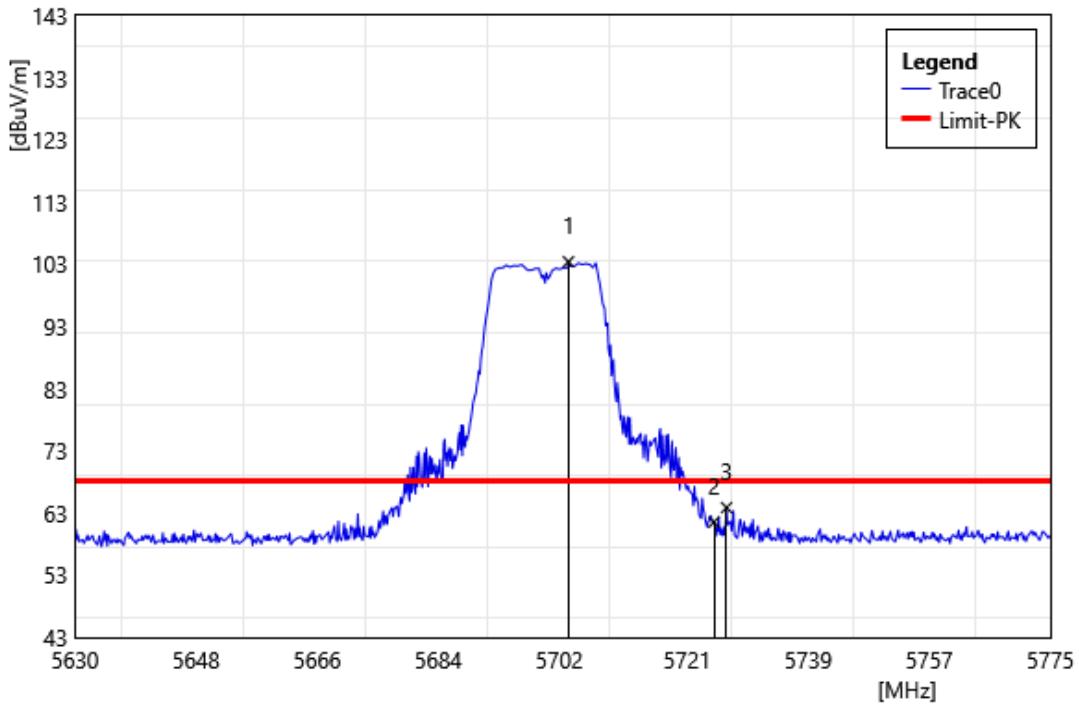

ID	Frequency MHz	Reading dBuV	Correct Factor dB/m	Result dBuV/m	Limit dBuV/m	Margin dB	Remark
1	5703.37	100.58	2.84	103.42	68.20	35.22	PEAK
2	5725.00	58.48	3.07	61.55	68.20	-6.65	PEAK
3	5726.86	60.78	3.10	63.88	68.20	-4.32	PEAK

Test Site:	96603-WG	Standard:	Part 15.407
Test Mode:	802.11a 5745 MHz		
Polarization:	Vertical		
Remark:			

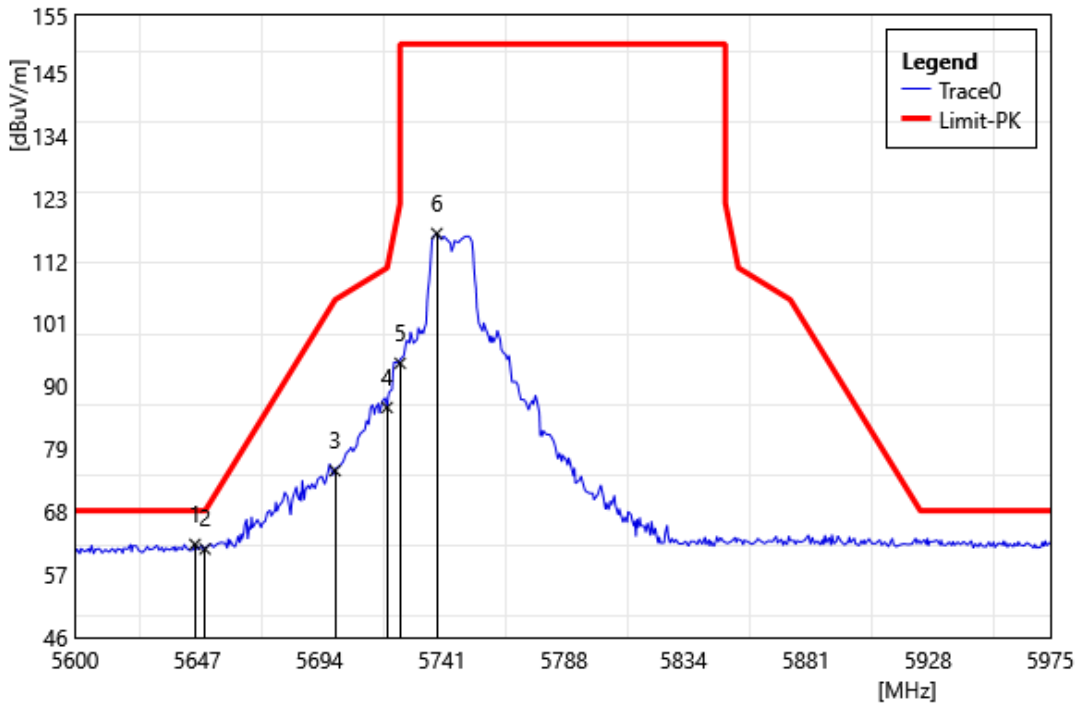

ID	Frequency MHz	Reading dBuV	Correct Factor dB/m	Result dBuV/m	Limit dBuV/m	Margin dB	Remark
1	5646.13	59.62	2.68	62.30	68.20	-5.90	PEAK
2	5650.00	58.80	2.71	61.51	68.20	-6.69	PEAK
3	5700.00	72.60	2.63	75.23	105.20	-29.97	PEAK
4	5720.00	83.49	2.82	86.31	110.80	-24.49	PEAK
5	5725.00	91.18	2.87	94.05	150.00	-55.95	PEAK
6	5739.13	113.81	3.01	116.82	150.00	-33.18	PEAK



Test Site:	96603-WG	Standard:	Part 15.407
Test Mode:	802.11a 5745 MHz		
Polarization:	Horizontal		
Remark:			

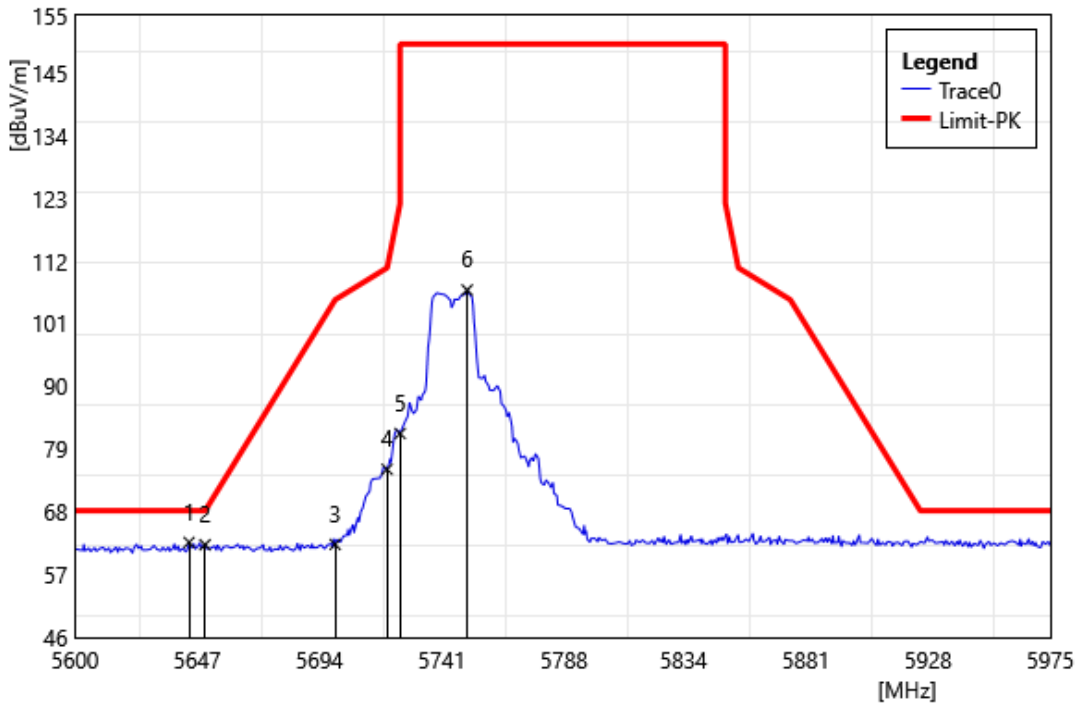

ID	Frequency MHz	Reading dBuV	Correct Factor dB/m	Result dBuV/m	Limit dBuV/m	Margin dB	Remark
1	5643.88	59.99	2.66	62.65	68.20	-5.55	PEAK
2	5650.00	59.53	2.71	62.24	68.20	-5.96	PEAK
3	5700.00	59.67	2.63	62.30	105.20	-42.90	PEAK
4	5720.00	72.64	2.82	75.46	110.80	-35.34	PEAK
5	5725.00	78.88	2.87	81.75	150.00	-68.25	PEAK
6	5750.75	103.78	3.12	106.90	150.00	-43.10	PEAK

Test Site:	96603-WG	Standard:	Part 15.407
Test Mode:	802.11a 5825 MHz		
Polarization:	Vertical		
Remark:			

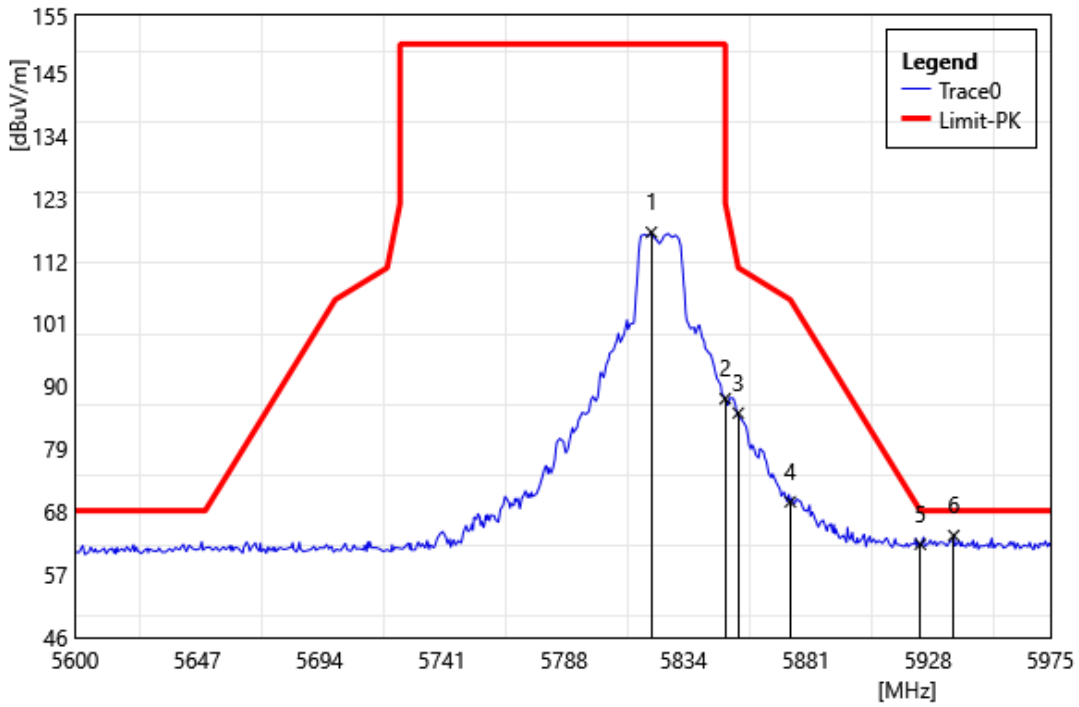

ID	Frequency MHz	Reading dBuV	Correct Factor dB/m	Result dBuV/m	Limit dBuV/m	Margin dB	Remark
1	5821.63	113.52	3.50	117.02	150.00	-32.98	PEAK
2	5850.00	84.33	3.51	87.84	122.20	-34.36	PEAK
3	5855.00	81.84	3.50	85.34	110.80	-25.46	PEAK
4	5875.00	66.30	3.46	69.76	105.20	-35.44	PEAK
5	5925.00	59.09	3.25	62.34	68.20	-5.86	PEAK
6	5937.88	60.68	3.17	63.86	68.20	-4.35	PEAK

Test Site:	96603-WG	Standard:	Part 15.407
Test Mode:	802.11a 5825 MHz		
Polarization:	Horizontal		
Remark:			

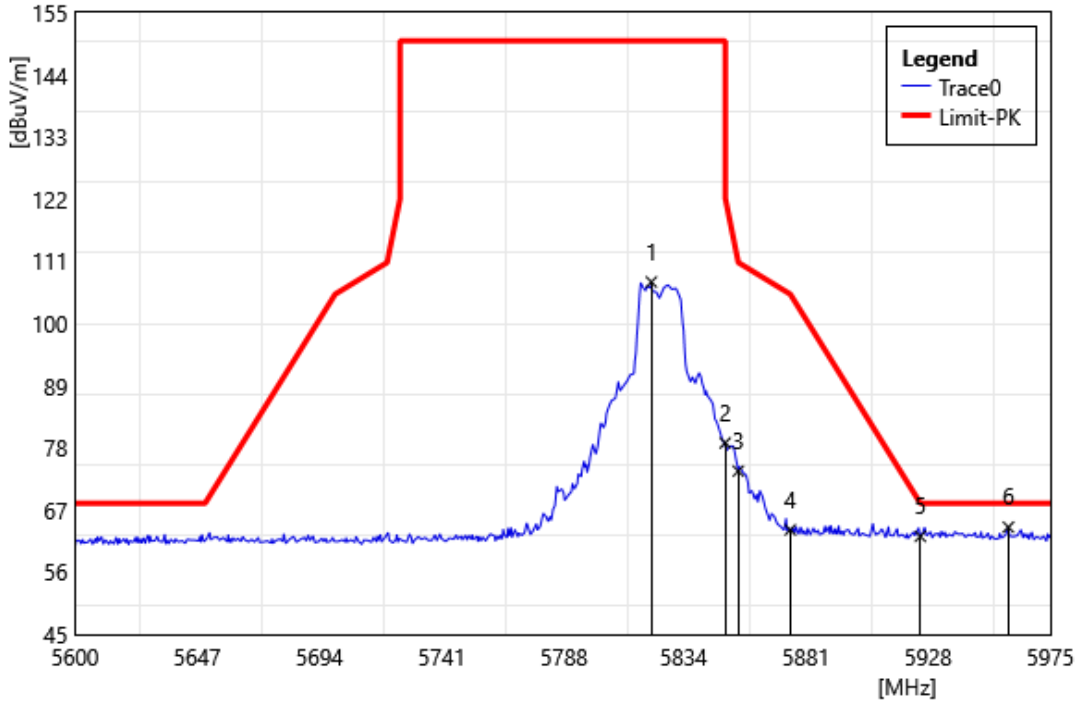

ID	Frequency MHz	Reading dBuV	Correct Factor dB/m	Result dBuV/m	Limit dBuV/m	Margin dB	Remark
1	5821.63	103.87	3.50	107.37	150.00	-42.63	PEAK
2	5850.00	75.37	3.51	78.88	122.20	-43.32	PEAK
3	5855.00	70.40	3.50	73.90	110.80	-36.90	PEAK
4	5875.00	60.04	3.46	63.50	105.20	-41.70	PEAK
5	5925.00	59.10	3.25	62.35	68.20	-5.85	PEAK
6	5958.88	60.90	3.08	63.98	68.20	-4.22	PEAK

Test Site:	96603-WG	Standard:	Part 15.407
Test Mode:	802.11ac VHT20 5180 MHz		
Polarization:	Vertical		
Remark:			

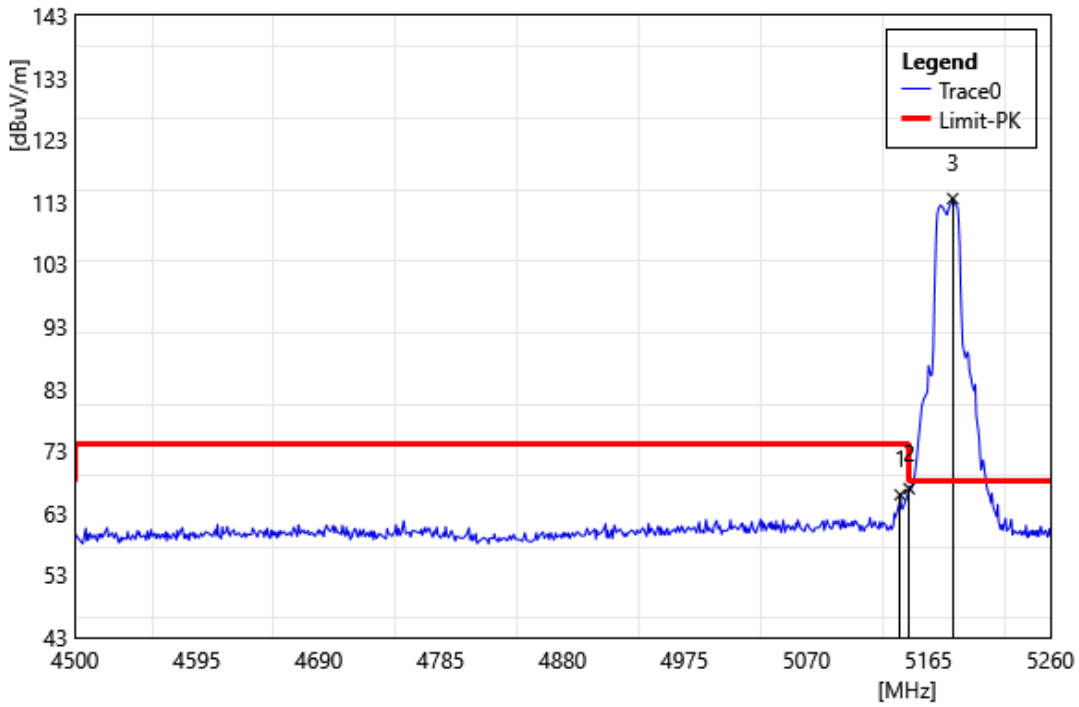

ID	Frequency MHz	Reading dBuV	Correct Factor dB/m	Result dBuV/m	Limit dBuV/m	Margin dB	Remark
1	5142.96	64.11	1.83	65.94	74.00	-8.06	PEAK
2	5150.00	65.08	1.84	66.92	74.00	-7.08	PEAK
3	5184.00	111.83	1.73	113.56	68.20	45.36	PEAK

Test Site:	96603-WG	Standard:	Part 15.407
Test Mode:	802.11ac VHT20 5180 MHz		
Polarization:	Horizontal		
Remark:			

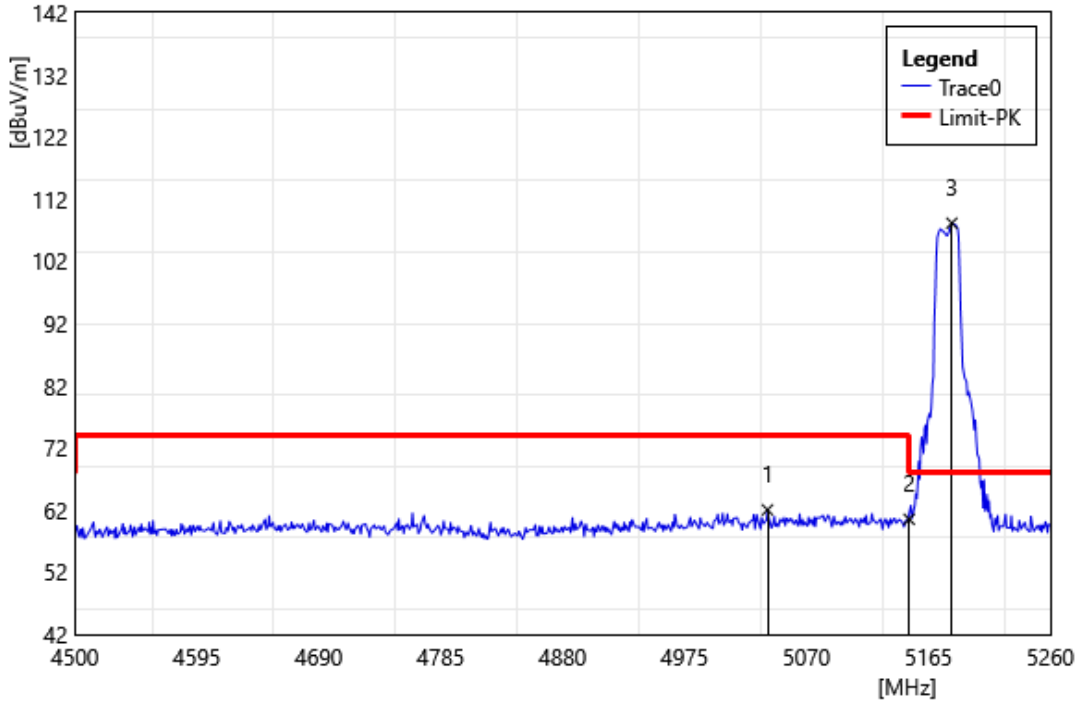

ID	Frequency MHz	Reading dBuV	Correct Factor dB/m	Result dBuV/m	Limit dBuV/m	Margin dB	Remark
1	5039.60	60.42	1.62	62.04	74.00	-11.96	PEAK
2	5150.00	58.69	1.84	60.53	74.00	-13.47	PEAK
3	5183.24	106.40	1.74	108.14	68.20	39.94	PEAK

Test Site:	96603-WG	Standard:	Part 15.407
Test Mode:	802.11ac VHT20 5320 MHz		
Polarization:	Vertical		
Remark:			

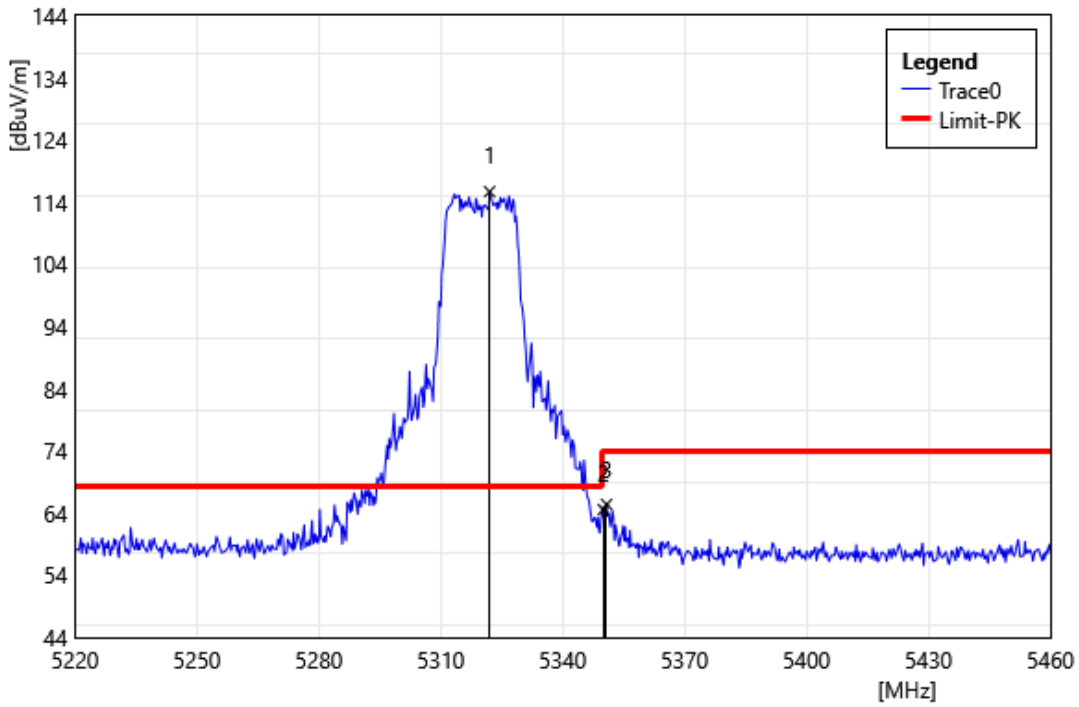

ID	Frequency MHz	Reading dBuV	Correct Factor dB/m	Result dBuV/m	Limit dBuV/m	Margin dB	Remark
1	5322.00	114.22	1.47	115.69	68.20	47.49	PEAK
2	5350.00	63.12	1.43	64.55	74.00	-9.45	PEAK
3	5350.80	63.94	1.44	65.38	74.00	-8.62	PEAK

Test Site:	96603-WG	Standard:	Part 15.407
Test Mode:	802.11ac VHT20 5320 MHz		
Polarization:	Horizontal		
Remark:			

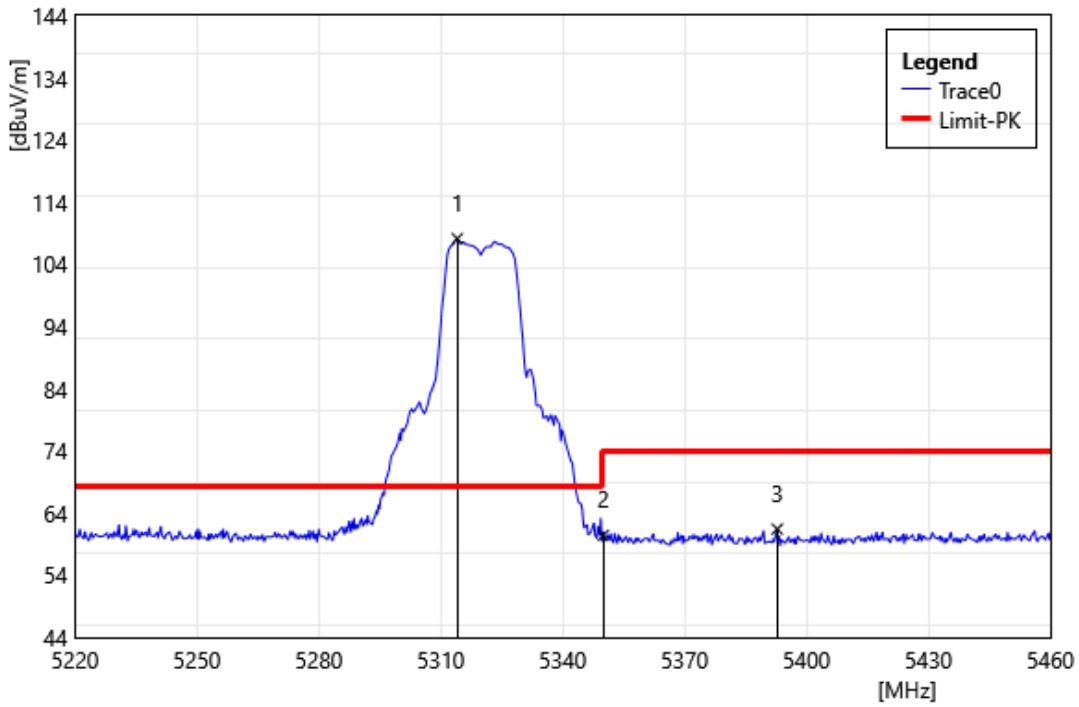

ID	Frequency MHz	Reading dBuV	Correct Factor dB/m	Result dBuV/m	Limit dBuV/m	Margin dB	Remark
1	5314.08	106.65	1.48	108.13	68.20	39.93	PEAK
2	5350.00	58.99	1.43	60.42	74.00	-13.58	PEAK
3	5392.80	59.95	1.47	61.42	74.00	-12.58	PEAK

Test Site:	96603-WG	Standard:	Part 15.407
Test Mode:	802.11ac VHT20 5500 MHz		
Polarization:	Vertical		
Remark:			

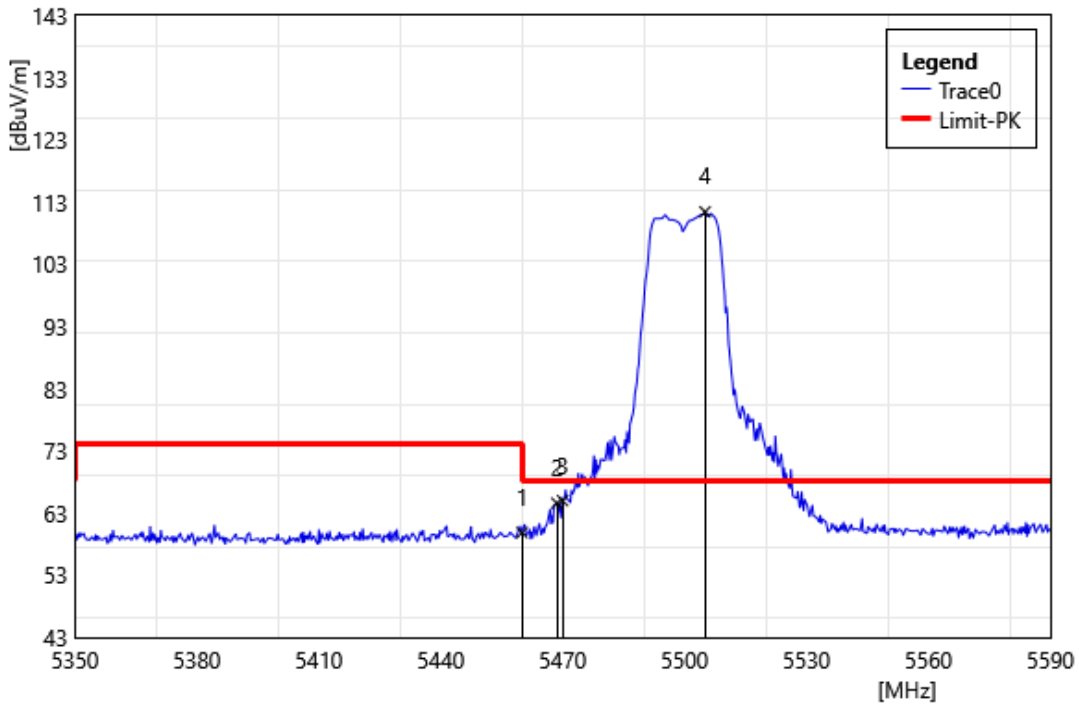

ID	Frequency MHz	Reading dBuV	Correct Factor dB/m	Result dBuV/m	Limit dBuV/m	Margin dB	Remark
1	5460.00	58.05	1.81	59.86	74.00	-14.14	PEAK
2	5468.56	62.71	1.87	64.58	68.20	-3.62	PEAK
3	5470.00	63.11	1.88	64.99	68.20	-3.21	PEAK
4	5505.04	109.32	2.12	111.45	68.20	43.25	PEAK



Test Site:	96603-WG	Standard:	Part 15.407
Test Mode:	802.11ac VHT20 5500 MHz		
Polarization:	Horizontal		
Remark:			

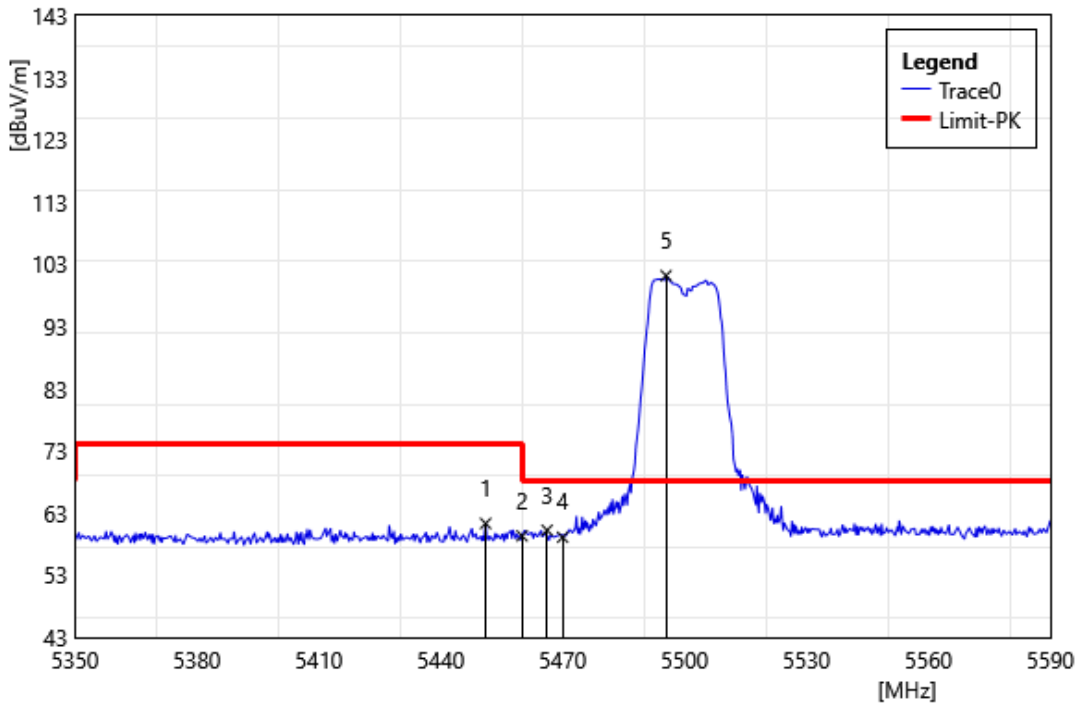

ID	Frequency MHz	Reading dBuV	Correct Factor dB/m	Result dBuV/m	Limit dBuV/m	Margin dB	Remark
1	5451.04	59.58	1.75	61.33	74.00	-12.67	PEAK
2	5460.00	57.52	1.81	59.33	74.00	-14.67	PEAK
3	5466.16	58.38	1.85	60.23	68.20	-7.97	PEAK
4	5470.00	57.24	1.88	59.12	68.20	-9.08	PEAK
5	5495.44	99.14	2.05	101.19	68.20	32.99	PEAK

Test Site:	96603-WG	Standard:	Part 15.407
Test Mode:	802.11ac VHT20 5700 MHz		
Polarization:	Vertical		
Remark:			

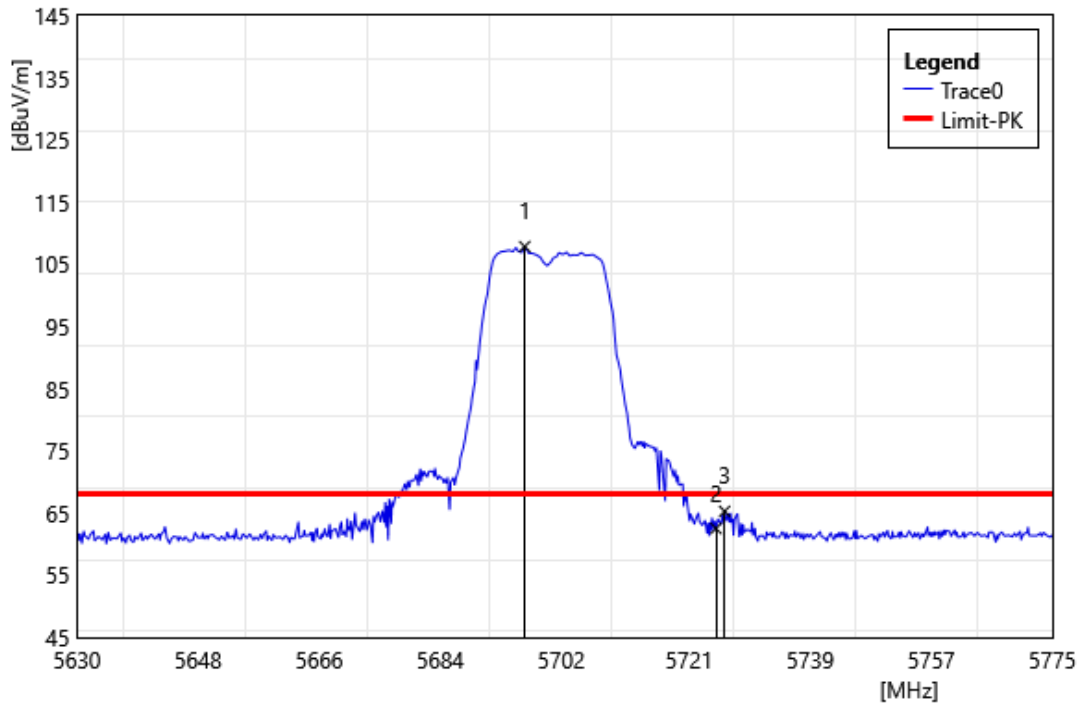

ID	Frequency MHz	Reading dBuV	Correct Factor dB/m	Result dBuV/m	Limit dBuV/m	Margin dB	Remark
1	5696.56	105.22	2.64	107.86	68.20	39.66	PEAK
2	5725.00	59.65	2.87	62.52	68.20	-5.68	PEAK
3	5726.28	62.41	2.88	65.29	68.20	-2.91	PEAK

Test Site:	96603-WG	Standard:	Part 15.407
Test Mode:	802.11ac VHT20 5700 MHz		
Polarization:	Horizontal		
Remark:			

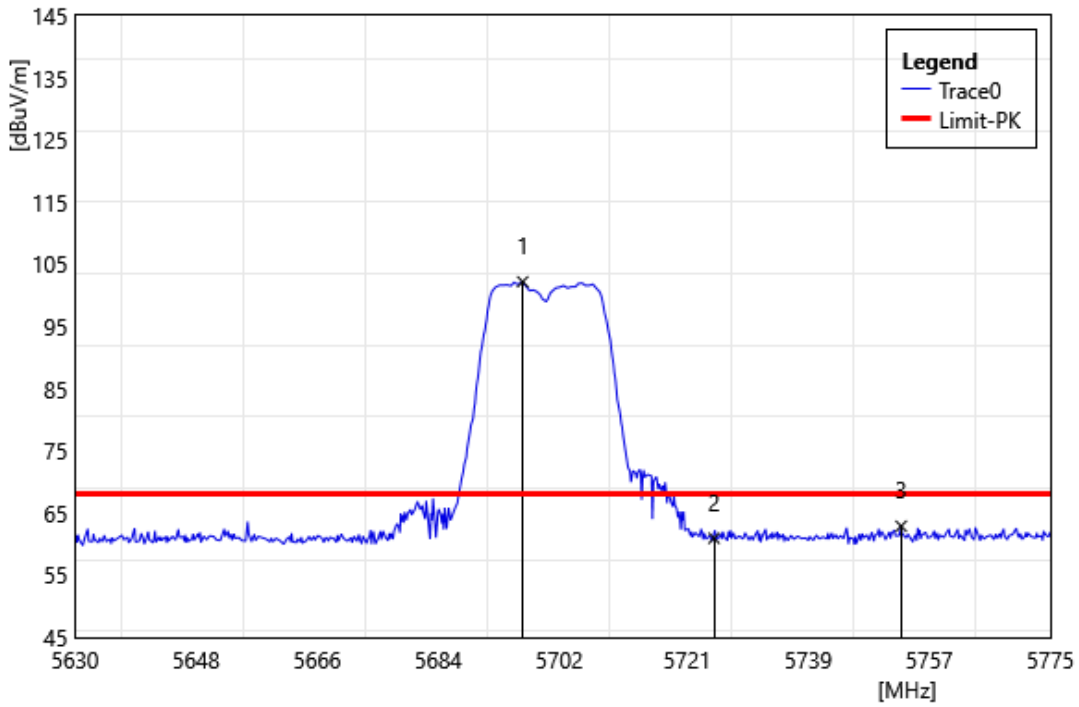

ID	Frequency MHz	Reading dBuV	Correct Factor dB/m	Result dBuV/m	Limit dBuV/m	Margin dB	Remark
1	5696.56	99.56	2.64	102.20	68.20	34.00	PEAK
2	5725.00	58.08	2.87	60.95	68.20	-7.25	PEAK
3	5752.82	59.75	3.14	62.89	68.20	-5.31	PEAK

Test Site:	96603-WG	Standard:	Part 15.407
Test Mode:	802.11ac VHT20 5745 MHz		
Polarization:	Vertical		
Remark:			

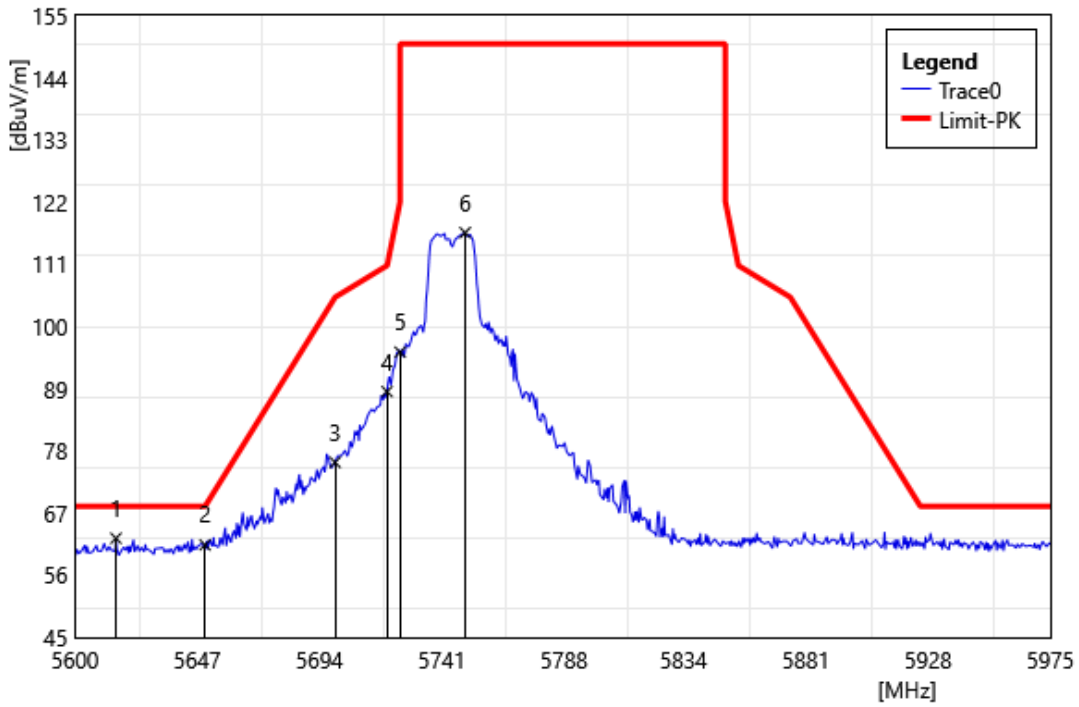

ID	Frequency MHz	Reading dBuV	Correct Factor dB/m	Result dBuV/m	Limit dBuV/m	Margin dB	Remark
1	5615.75	60.06	2.49	62.55	68.20	-5.65	PEAK
2	5650.00	58.66	2.71	61.37	68.20	-6.83	PEAK
3	5700.00	73.34	2.63	75.97	105.20	-29.23	PEAK
4	5720.00	85.66	2.82	88.48	110.80	-22.32	PEAK
5	5725.00	92.61	2.87	95.48	150.00	-54.52	PEAK
6	5750.00	113.50	3.11	116.61	150.00	-33.40	PEAK

Test Site:	96603-WG	Standard:	Part 15.407
Test Mode:	802.11ac VHT20 5745 MHz		
Polarization:	Horizontal		
Remark:			

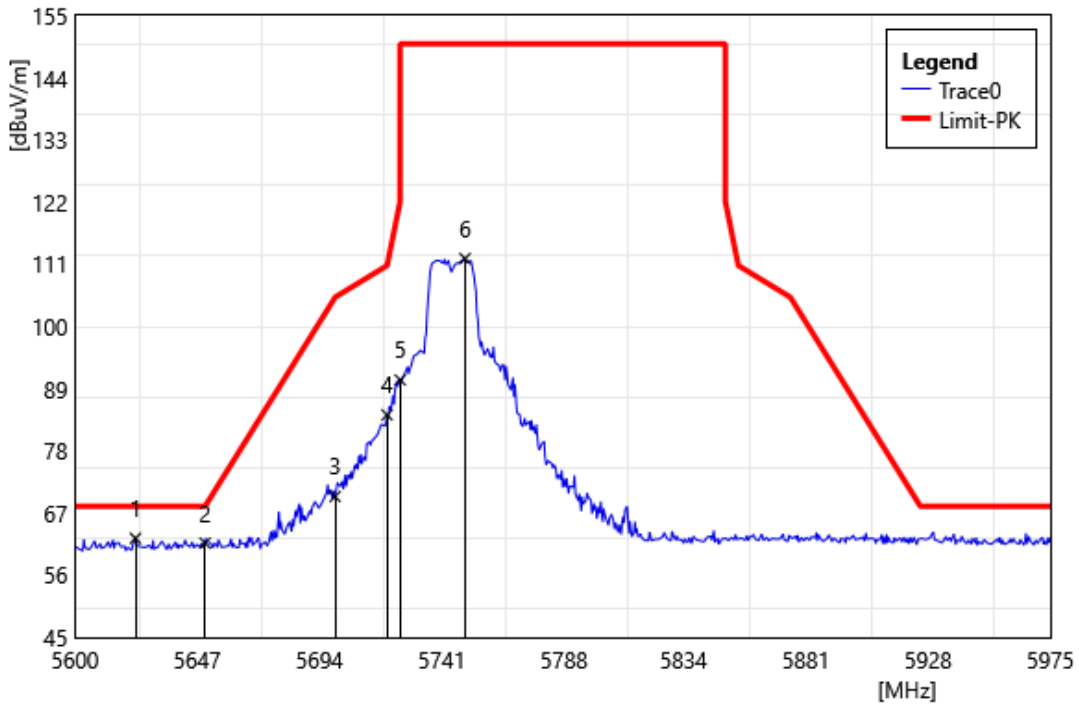

ID	Frequency MHz	Reading dBuV	Correct Factor dB/m	Result dBuV/m	Limit dBuV/m	Margin dB	Remark
1	5623.25	60.00	2.54	62.54	68.20	-5.66	PEAK
2	5650.00	58.97	2.71	61.68	68.20	-6.52	PEAK
3	5700.00	67.30	2.63	69.93	105.20	-35.27	PEAK
4	5720.00	81.55	2.82	84.37	110.80	-26.43	PEAK
5	5725.00	87.69	2.87	90.56	150.00	-59.44	PEAK
6	5750.00	108.91	3.11	112.02	150.00	-37.98	PEAK

Test Site:	96603-WG	Standard:	Part 15.407
Test Mode:	802.11ac VHT20 5825 MHz		
Polarization:	Vertical		
Remark:			

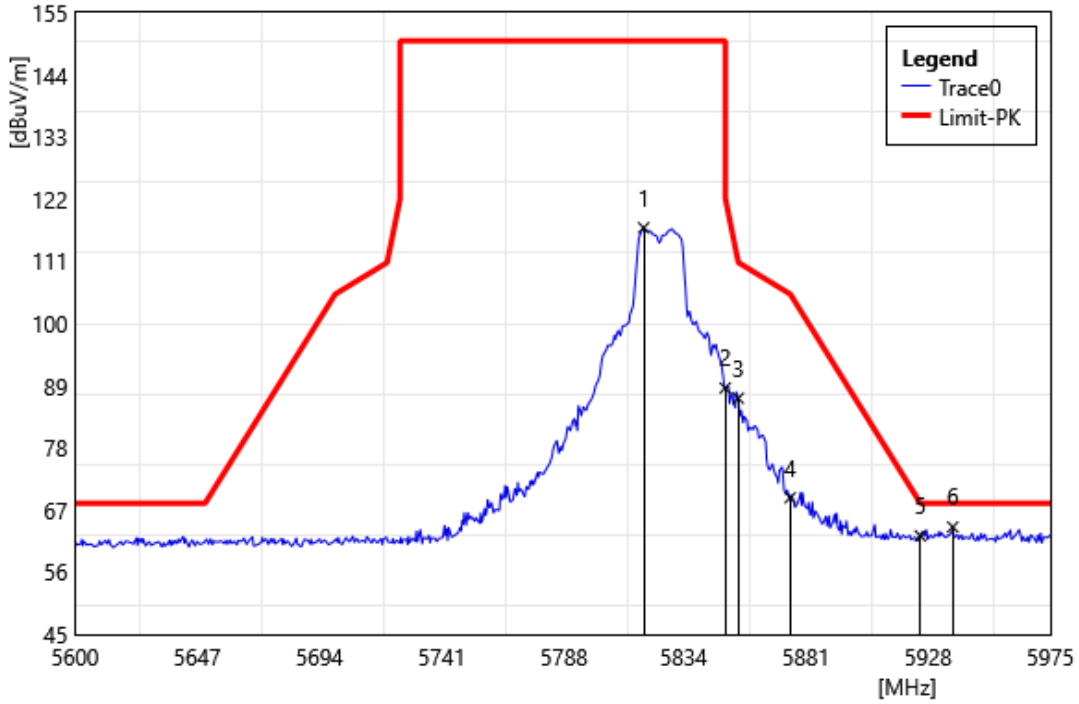

ID	Frequency MHz	Reading dBuV	Correct Factor dB/m	Result dBuV/m	Limit dBuV/m	Margin dB	Remark
1	5818.63	113.43	3.51	116.94	150.00	-33.06	PEAK
2	5850.00	85.09	3.51	88.60	122.20	-33.60	PEAK
3	5855.00	83.28	3.50	86.78	110.80	-24.02	PEAK
4	5875.00	65.71	3.46	69.17	105.20	-36.03	PEAK
5	5925.00	59.21	3.25	62.46	68.20	-5.74	PEAK
6	5937.50	60.83	3.17	64.00	68.20	-4.20	PEAK

Test Site:	96603-WG	Standard:	Part 15.407
Test Mode:	802.11ac VHT20 5825 MHz		
Polarization:	Horizontal		
Remark:			

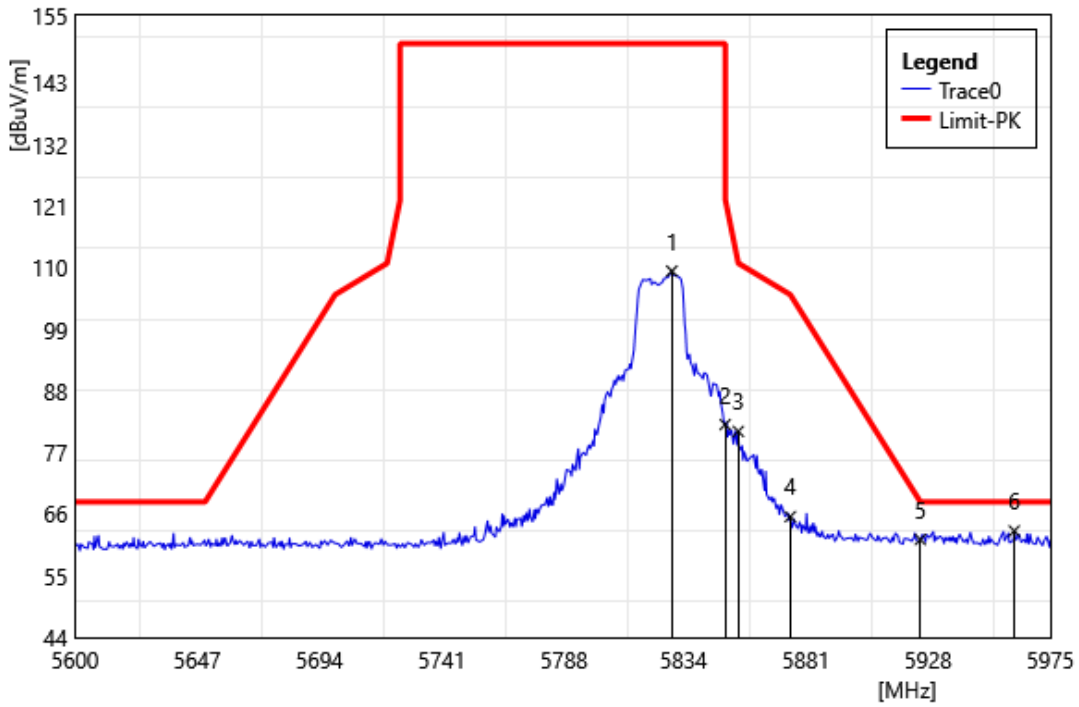

ID	Frequency MHz	Reading dBuV	Correct Factor dB/m	Result dBuV/m	Limit dBuV/m	Margin dB	Remark
1	5829.50	105.88	3.51	109.39	150.00	-40.61	PEAK
2	5850.00	78.49	3.51	82.00	122.20	-40.20	PEAK
3	5855.00	77.28	3.50	80.78	110.80	-30.02	PEAK
4	5875.00	62.10	3.46	65.56	105.20	-39.64	PEAK
5	5925.00	58.23	3.25	61.48	68.20	-6.72	PEAK
6	5961.13	59.92	3.09	63.01	68.20	-5.19	PEAK

Test Site:	96603-WG	Standard:	Part 15.407
Test Mode:	802.11ac VHT40 5190 MHz		
Polarization:	Vertical		
Remark:			

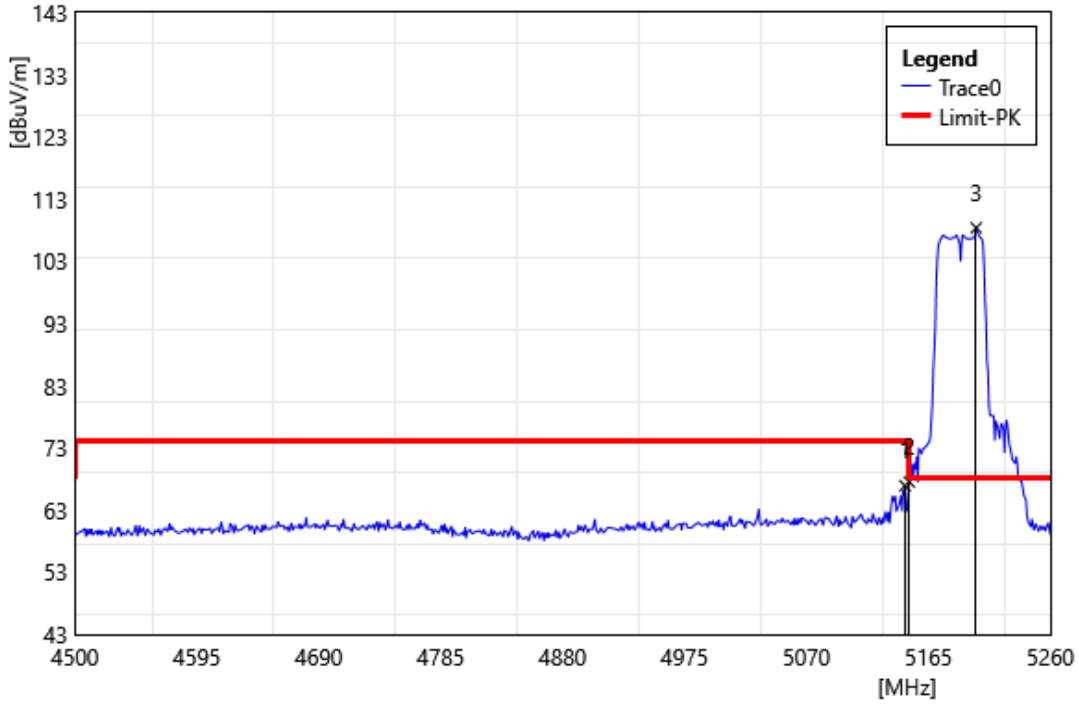

ID	Frequency MHz	Reading dBuV	Correct Factor dB/m	Result dBuV/m	Limit dBuV/m	Margin dB	Remark
1	5146.76	65.08	1.83	66.91	74.00	-7.09	PEAK
2	5150.00	65.71	1.84	67.55	74.00	-6.45	PEAK
3	5202.24	106.73	1.67	108.40	68.20	40.20	PEAK



Test Site:	96603-WG	Standard:	Part 15.407
Test Mode:	802.11ac VHT40 5190 MHz		
Polarization:	Horizontal		
Remark:			

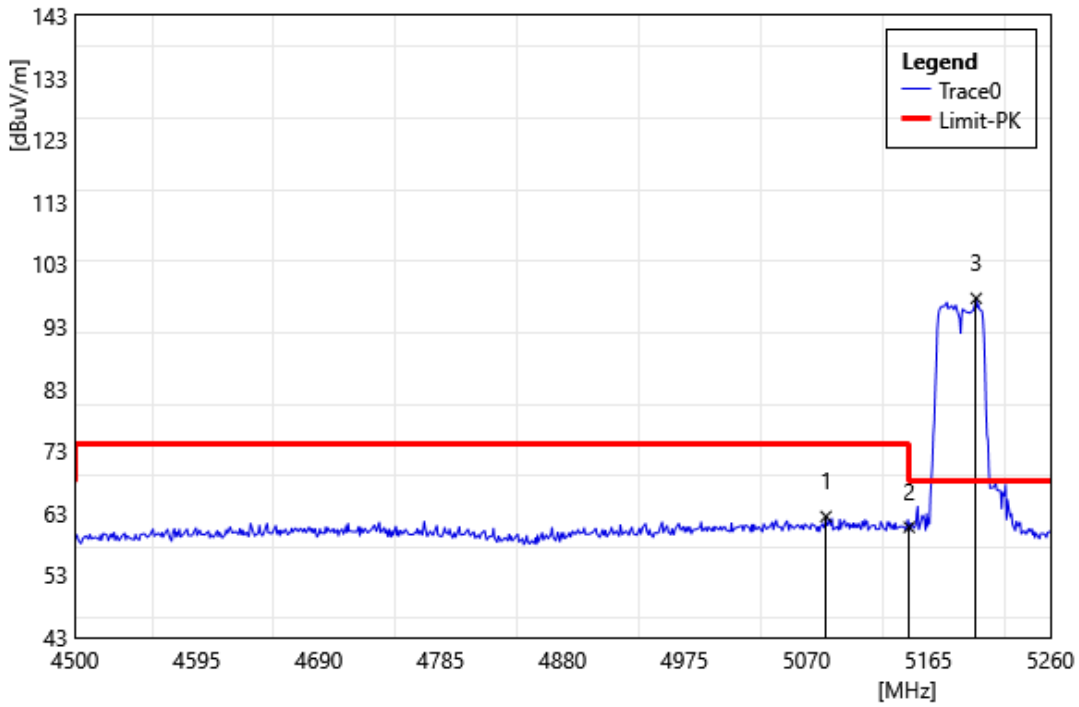

ID	Frequency MHz	Reading dBuV	Correct Factor dB/m	Result dBuV/m	Limit dBuV/m	Margin dB	Remark
1	5085.20	60.75	1.70	62.45	74.00	-11.55	PEAK
2	5150.00	58.87	1.84	60.71	74.00	-13.29	PEAK
3	5202.24	95.86	1.67	97.53	68.20	29.33	PEAK

Test Site:	96603-WG	Standard:	Part 15.407
Test Mode:	802.11ac VHT40 5310 MHz		
Polarization:	Vertical		
Remark:			

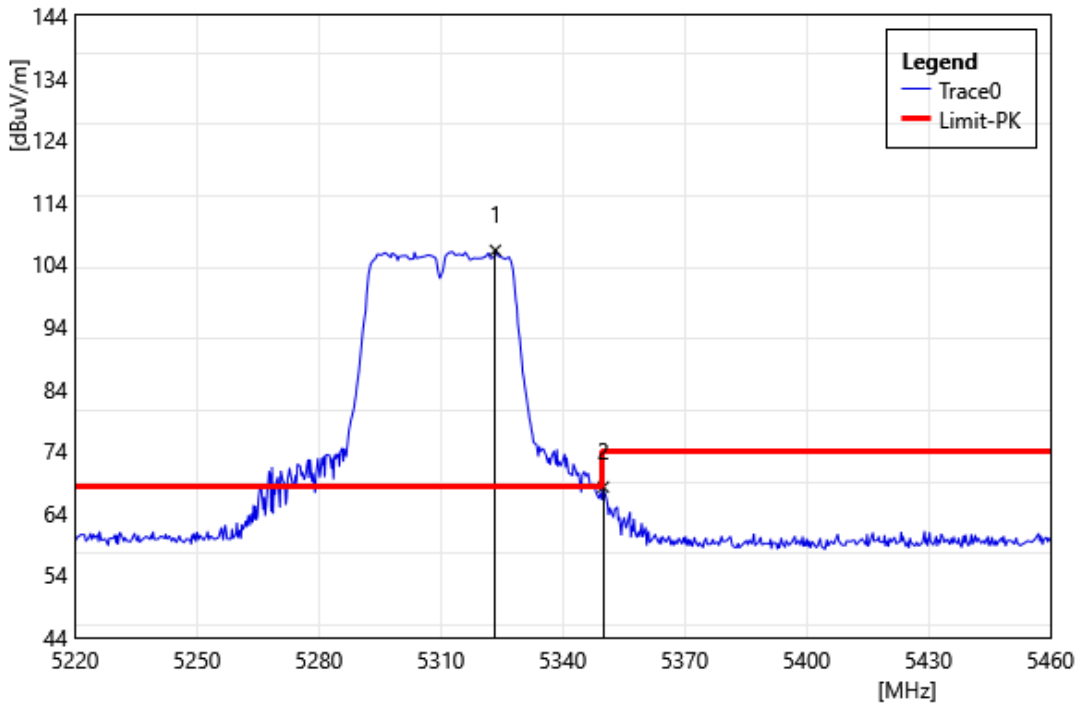

ID	Frequency MHz	Reading dBuV	Correct Factor dB/m	Result dBuV/m	Limit dBuV/m	Margin dB	Remark
1	5323.44	104.80	1.46	106.26	68.20	38.06	PEAK
2	5350.00	66.76	1.43	68.19	74.00	-5.81	PEAK

Test Site:	96603-WG	Standard:	Part 15.407
Test Mode:	802.11ac VHT40 5310 MHz		
Polarization:	Horizontal		
Remark:			

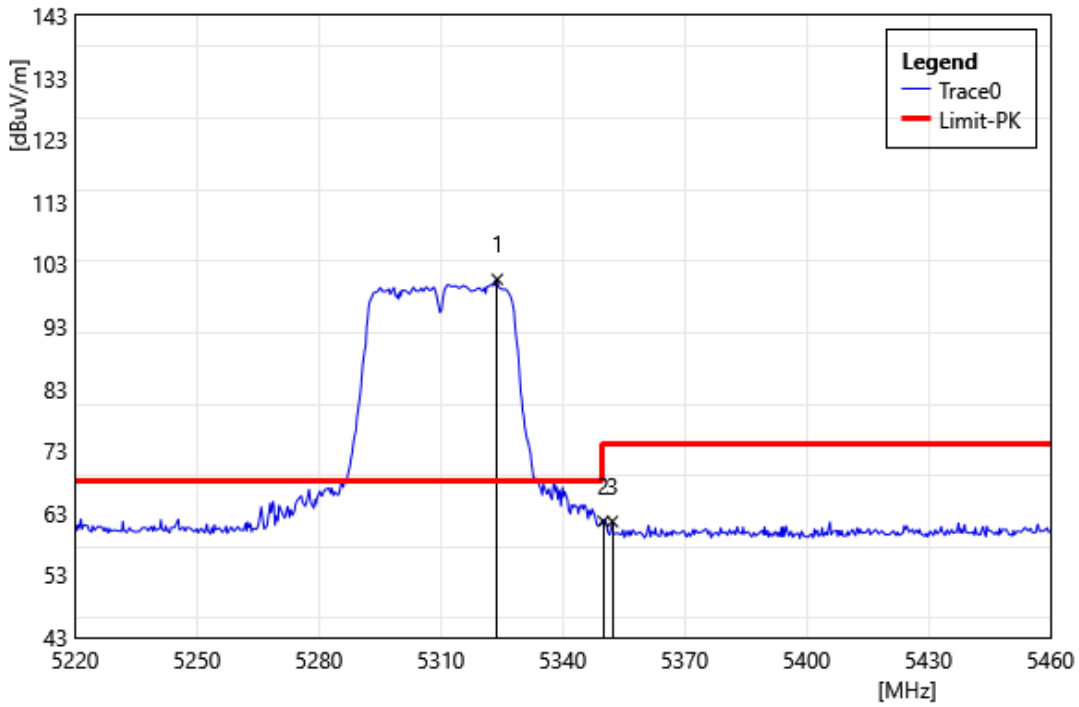

ID	Frequency MHz	Reading dBuV	Correct Factor dB/m	Result dBuV/m	Limit dBuV/m	Margin dB	Remark
1	5323.92	99.12	1.46	100.58	68.20	32.38	PEAK
2	5350.00	60.26	1.43	61.69	74.00	-12.31	PEAK
3	5352.24	60.20	1.44	61.64	74.00	-12.36	PEAK

Test Site:	96603-WG	Standard:	Part 15.407
Test Mode:	802.11ac VHT40 5510 MHz		
Polarization:	Vertical		
Remark:			

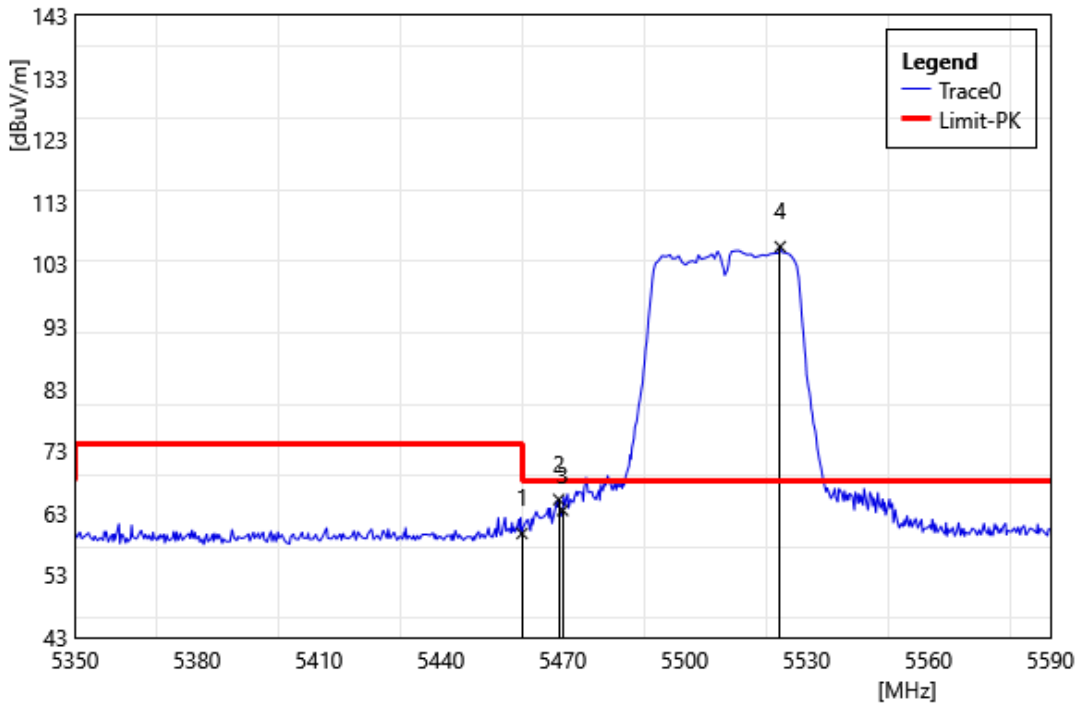

ID	Frequency MHz	Reading dBuV	Correct Factor dB/m	Result dBuV/m	Limit dBuV/m	Margin dB	Remark
1	5460.00	57.90	1.81	59.71	74.00	-14.29	PEAK
2	5469.04	63.31	1.87	65.18	68.20	-3.02	PEAK
3	5470.00	61.56	1.88	63.44	68.20	-4.76	PEAK
4	5523.52	103.64	2.20	105.84	68.20	37.64	PEAK

Test Site:	96603-WG	Standard:	Part 15.407
Test Mode:	802.11ac VHT40 5510 MHz		
Polarization:	Horizontal		
Remark:			

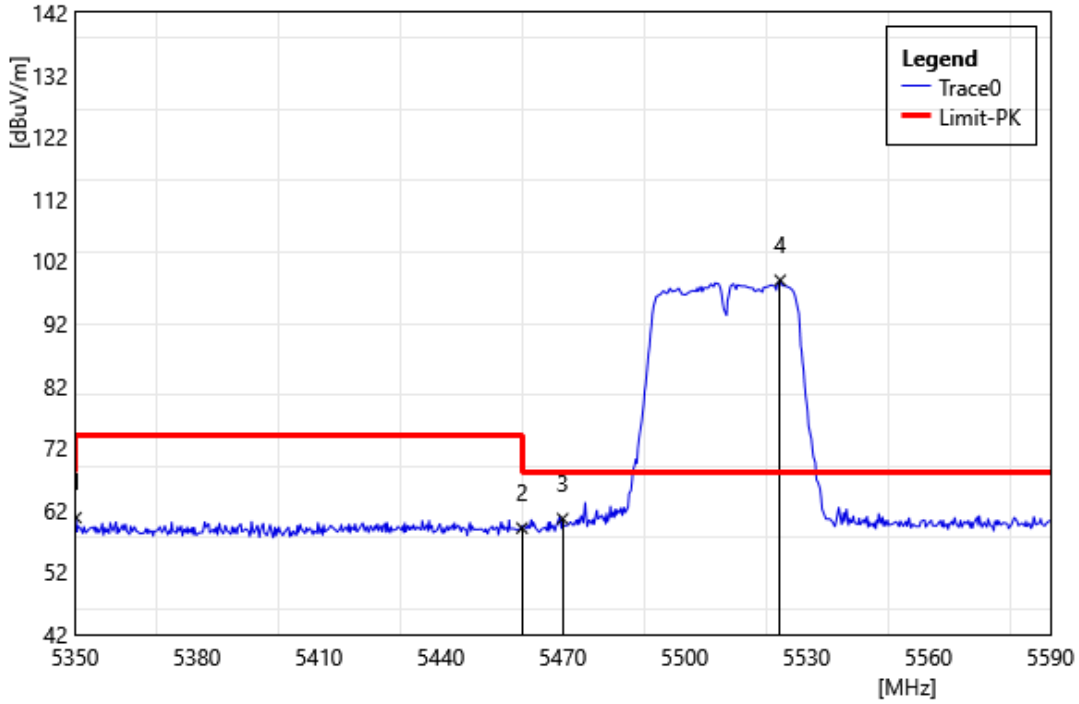

ID	Frequency MHz	Reading dBuV	Correct Factor dB/m	Result dBuV/m	Limit dBuV/m	Margin dB	Remark
1	5350.24	59.34	1.43	60.78	74.00	-13.23	PEAK
2	5460.00	57.28	1.81	59.09	74.00	-14.91	PEAK
3	5470.00	58.73	1.88	60.61	68.20	-7.59	PEAK
4	5523.52	96.78	2.20	98.98	68.20	30.78	PEAK

Test Site:	96603-WG	Standard:	Part 15.407
Test Mode:	802.11ac VHT40 5670 MHz		
Polarization:	Vertical		
Remark:			

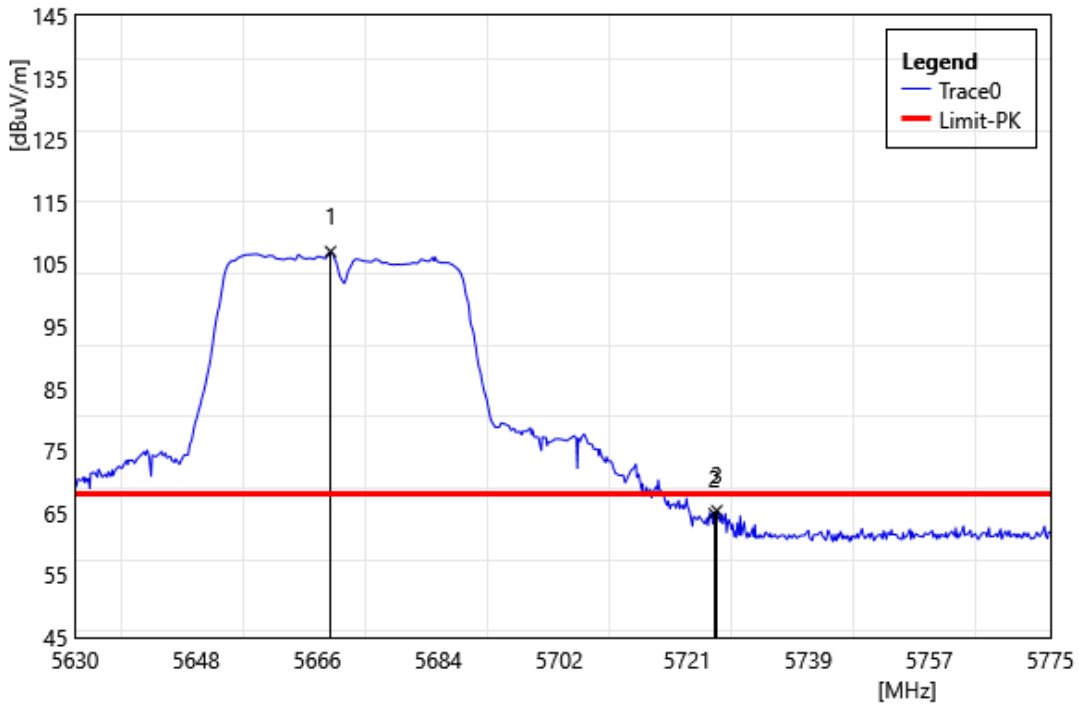

ID	Frequency MHz	Reading dBuV	Correct Factor dB/m	Result dBuV/m	Limit dBuV/m	Margin dB	Remark
1	5667.99	104.38	2.67	107.05	68.20	38.85	PEAK
2	5725.00	62.03	2.87	64.90	68.20	-3.30	PEAK
3	5725.41	62.52	2.87	65.39	68.20	-2.81	PEAK

Test Site:	96603-WG	Standard:	Part 15.407
Test Mode:	802.11ac VHT40 5670 MHz		
Polarization:	Horizontal		
Remark:			

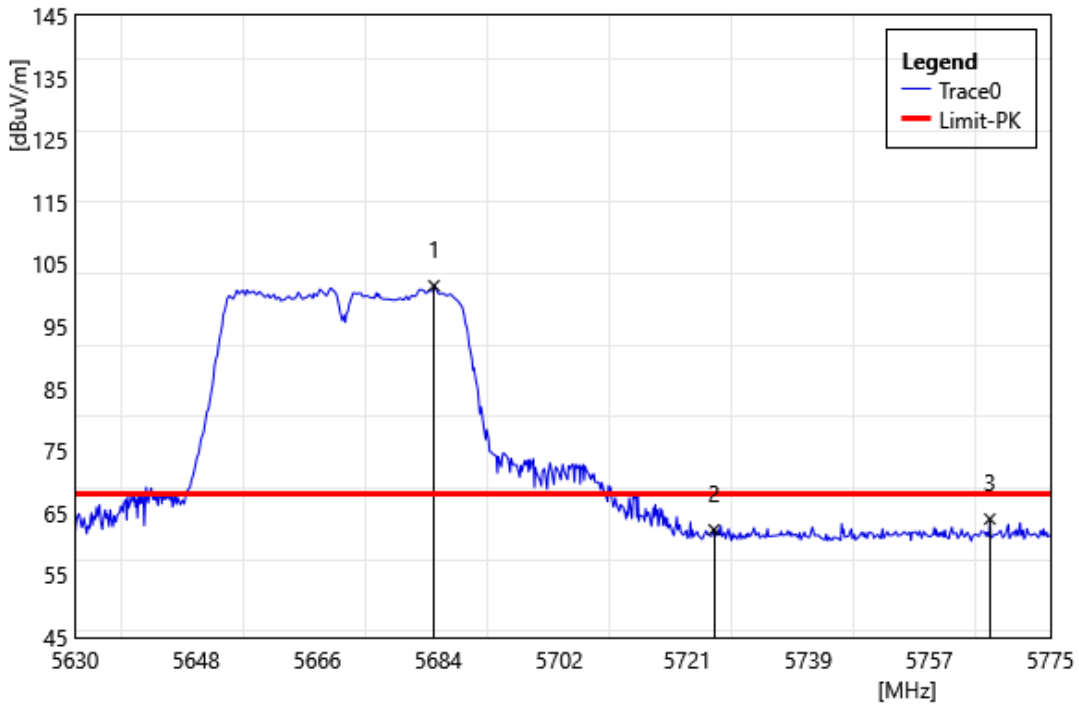

ID	Frequency MHz	Reading dBuV	Correct Factor dB/m	Result dBuV/m	Limit dBuV/m	Margin dB	Remark
1	5683.36	98.91	2.65	101.56	68.20	33.36	PEAK
2	5725.00	59.45	2.87	62.32	68.20	-5.88	PEAK
3	5766.01	60.80	3.24	64.04	68.20	-4.16	PEAK

Test Site:	96603-WG	Standard:	Part 15.407
Test Mode:	802.11ac VHT40 5755 MHz		
Polarization:	Vertical		
Remark:			

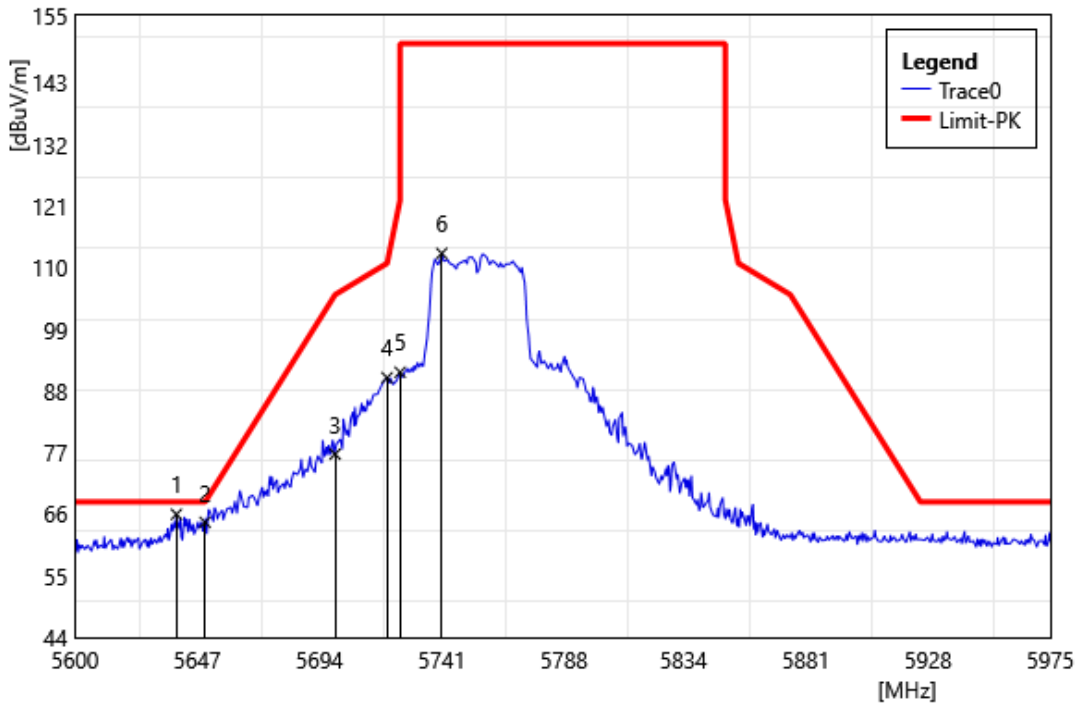

ID	Frequency MHz	Reading dBuV	Correct Factor dB/m	Result dBuV/m	Limit dBuV/m	Margin dB	Remark
1	5639.00	63.34	2.63	65.97	68.20	-2.23	PEAK
2	5650.00	61.85	2.71	64.56	68.20	-3.64	PEAK
3	5700.00	74.09	2.63	76.72	105.20	-28.48	PEAK
4	5720.00	87.56	2.82	90.38	110.80	-20.42	PEAK
5	5725.00	88.47	2.87	91.34	150.00	-58.66	PEAK
6	5741.00	109.52	3.03	112.56	150.00	-37.45	PEAK



Test Site:	96603-WG	Standard:	Part 15.407
Test Mode:	802.11ac VHT40 5755 MHz		
Polarization:	Horizontal		
Remark:			

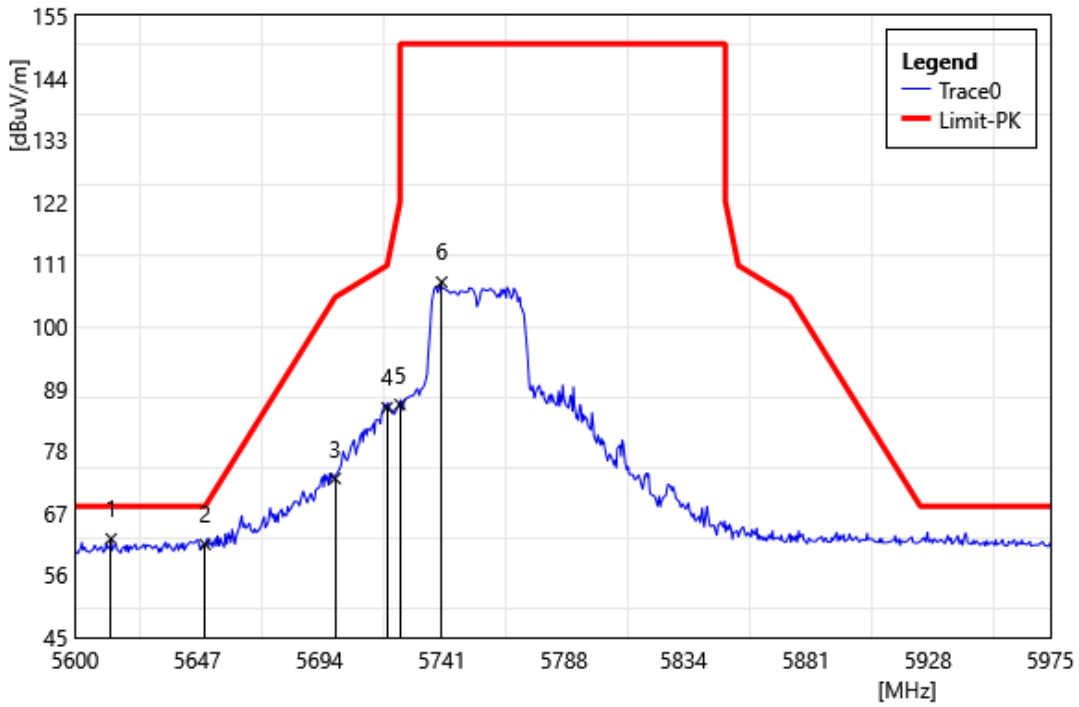

ID	Frequency MHz	Reading dBuV	Correct Factor dB/m	Result dBuV/m	Limit dBuV/m	Margin dB	Remark
1	5613.88	59.97	2.48	62.45	68.20	-5.75	PEAK
2	5650.00	58.73	2.71	61.44	68.20	-6.76	PEAK
3	5700.00	70.48	2.63	73.11	105.20	-32.09	PEAK
4	5720.00	82.81	2.82	85.63	110.80	-25.17	PEAK
5	5725.00	83.32	2.87	86.19	150.00	-63.81	PEAK
6	5741.00	104.85	3.03	107.88	150.00	-42.12	PEAK

Test Site:	96603-WG	Standard:	Part 15.407
Test Mode:	802.11ac VHT40 5795 MHz		
Polarization:	Vertical		
Remark:			

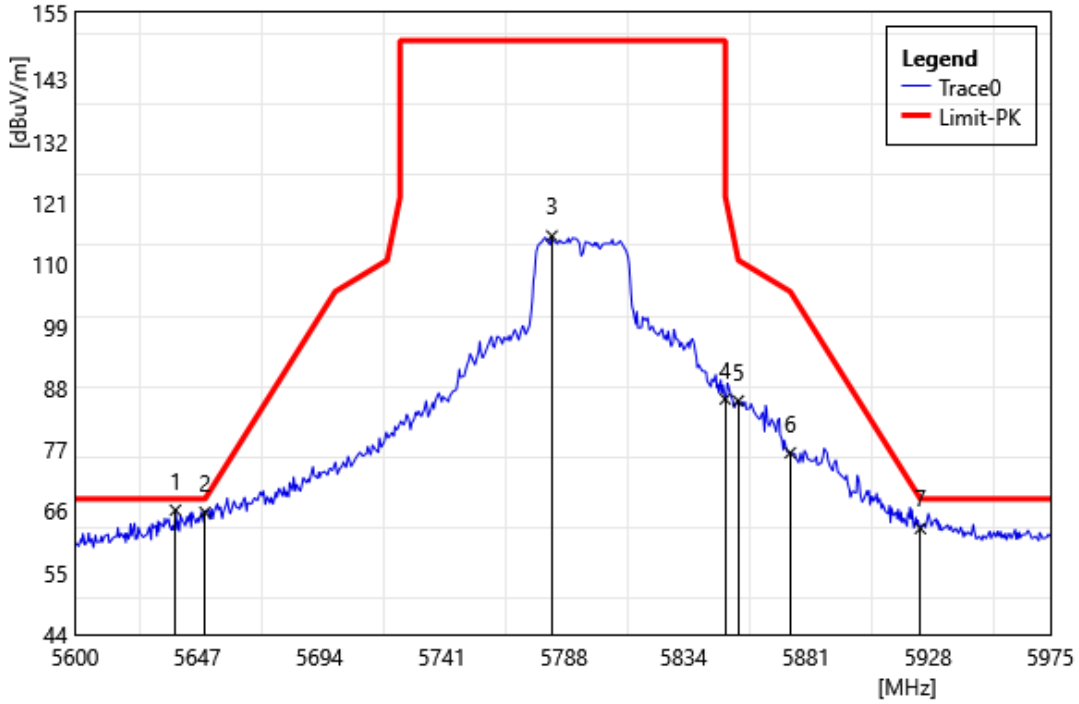

ID	Frequency MHz	Reading dBuV	Correct Factor dB/m	Result dBuV/m	Limit dBuV/m	Margin dB	Remark
1	5638.63	63.55	2.63	66.18	68.20	-2.02	PEAK
2	5650.00	63.08	2.71	65.79	68.20	-2.41	PEAK
3	5783.38	111.76	3.37	115.13	150.00	-34.87	PEAK
4	5850.00	82.51	3.51	86.02	122.20	-36.18	PEAK
5	5855.00	82.18	3.50	85.68	110.80	-25.12	PEAK
6	5875.00	72.97	3.46	76.43	105.20	-28.77	PEAK
7	5925.00	59.66	3.25	62.91	68.20	-5.29	PEAK

Test Site:	96603-WG	Standard:	Part 15.407
Test Mode:	802.11ac VHT40 5795 MHz		
Polarization:	Horizontal		
Remark:			

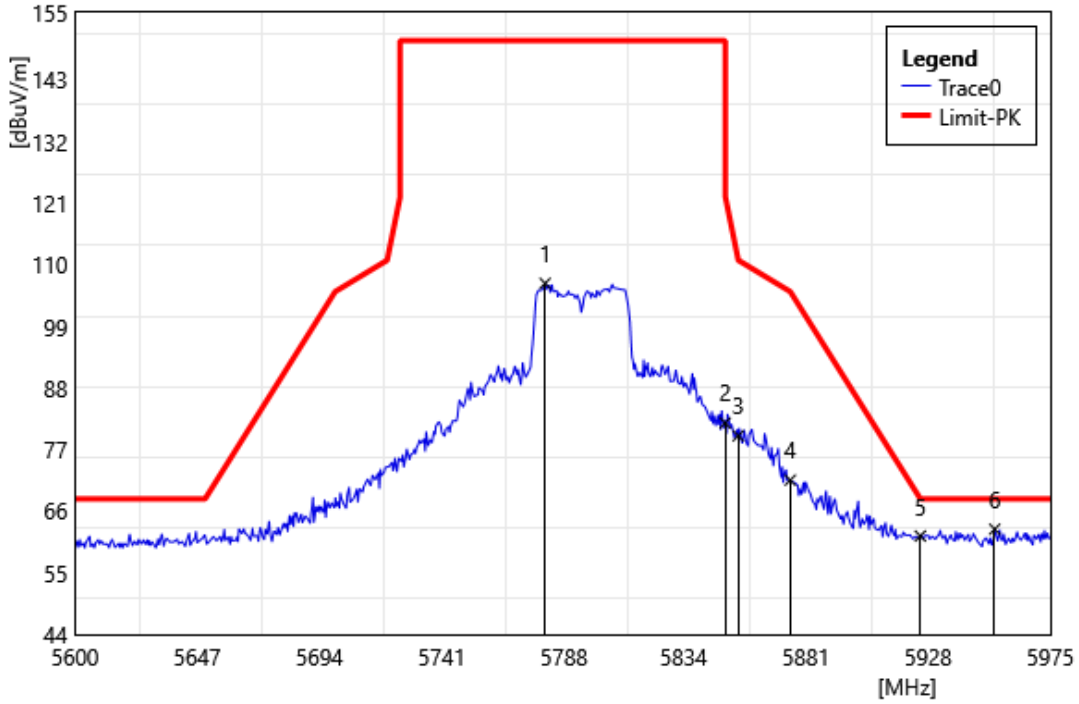

ID	Frequency MHz	Reading dBuV	Correct Factor dB/m	Result dBuV/m	Limit dBuV/m	Margin dB	Remark
1	5780.75	103.31	3.35	106.66	150.00	-43.34	PEAK
2	5850.00	78.24	3.51	81.75	122.20	-40.45	PEAK
3	5855.00	75.95	3.50	79.45	110.80	-31.35	PEAK
4	5875.00	68.09	3.46	71.55	105.20	-33.65	PEAK
5	5925.00	58.32	3.25	61.57	68.20	-6.63	PEAK
6	5953.63	59.69	3.09	62.78	68.20	-5.42	PEAK

Test Site:	96603-WG	Standard:	Part 15.407
Test Mode:	802.11ac VHT80 5210 MHz		
Polarization:	Vertical		
Remark:			

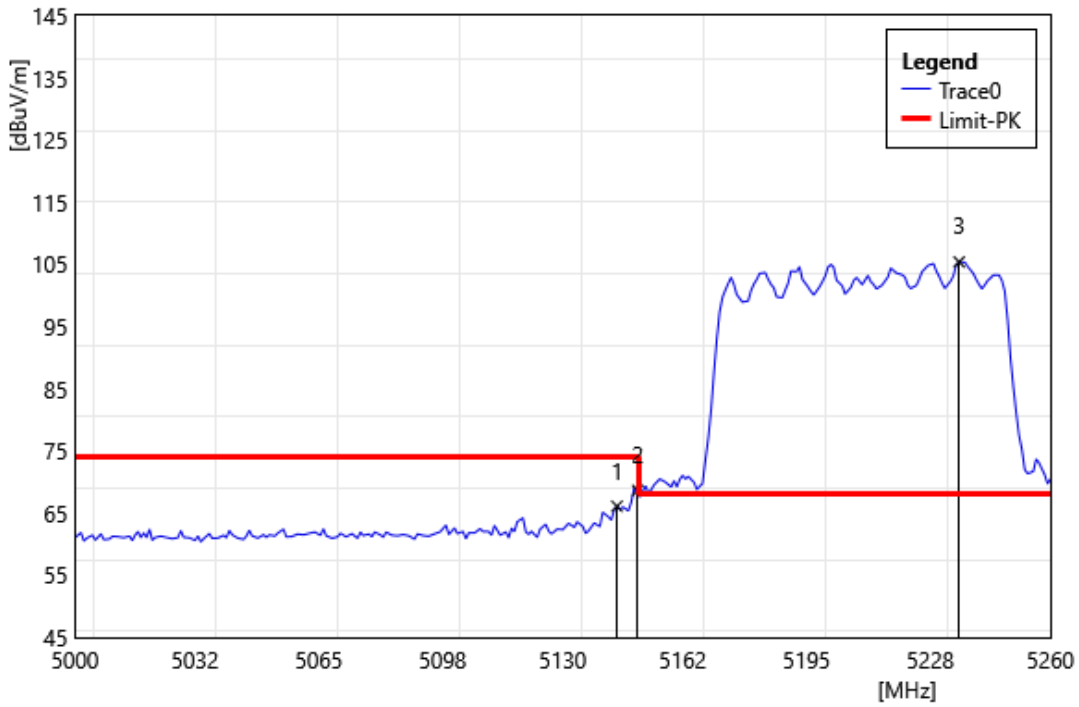

ID	Frequency MHz	Reading dBuV	Correct Factor dB/m	Result dBuV/m	Limit dBuV/m	Margin dB	Remark
1	5144.48	64.27	1.83	66.10	74.00	-7.90	PEAK
2	5150.00	66.81	1.84	68.65	74.00	-5.35	PEAK
3	5235.68	103.84	1.54	105.38	68.20	37.18	PEAK

Test Site:	96603-WG	Standard:	Part 15.407
Test Mode:	802.11ac VHT80 5210 MHz		
Polarization:	Horizontal		
Remark:			

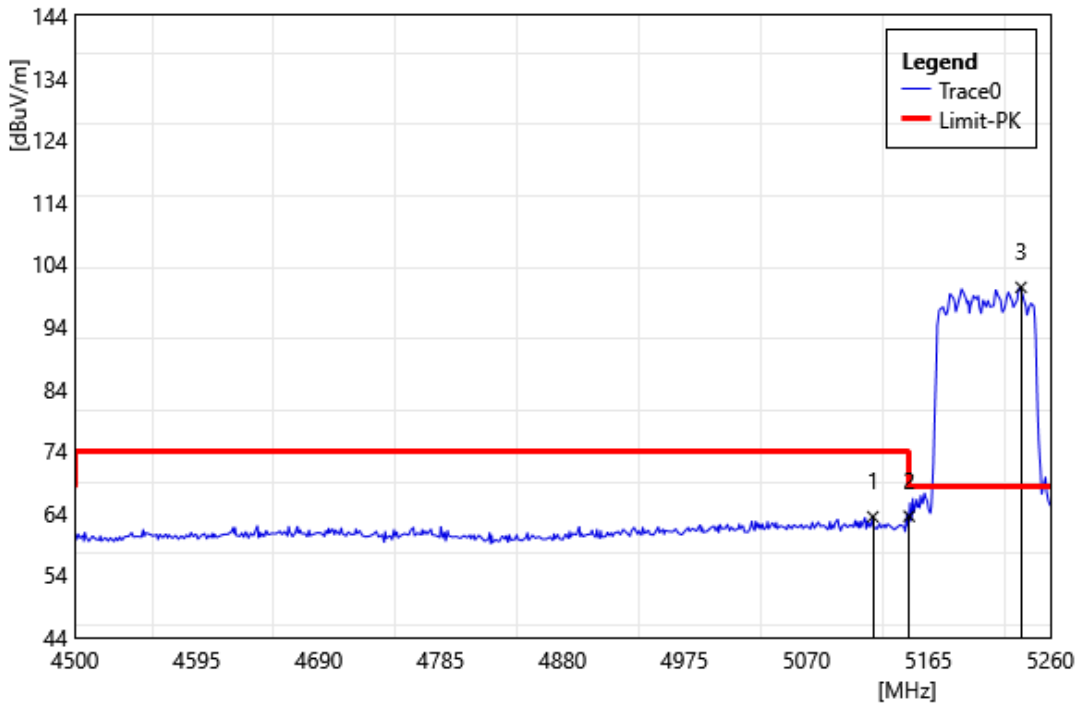

ID	Frequency MHz	Reading dBuV	Correct Factor dB/m	Result dBuV/m	Limit dBuV/m	Margin dB	Remark
1	5121.68	61.64	1.77	63.41	74.00	-10.59	PEAK
2	5150.00	61.66	1.84	63.50	74.00	-10.50	PEAK
3	5237.20	98.78	1.53	100.31	68.20	32.11	PEAK

Test Site:	96603-WG	Standard:	Part 15.407
Test Mode:	802.11ac VHT80 5290 MHz		
Polarization:	Vertical		
Remark:			

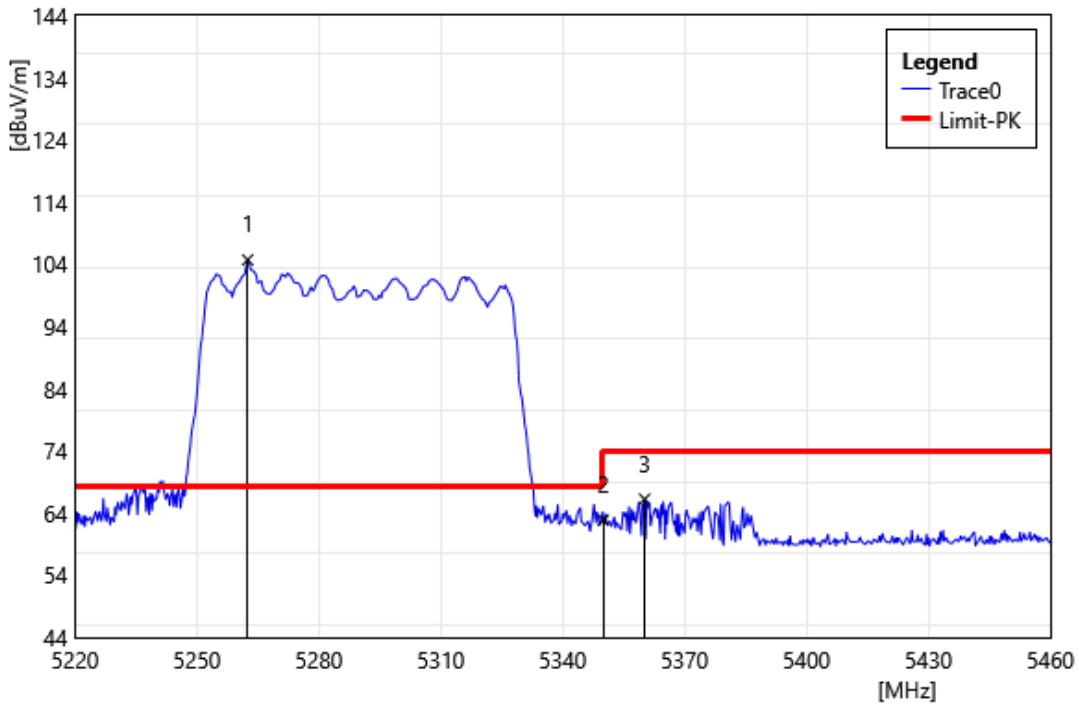

ID	Frequency MHz	Reading dBuV	Correct Factor dB/m	Result dBuV/m	Limit dBuV/m	Margin dB	Remark
1	5262.48	103.22	1.50	104.72	68.20	36.52	PEAK
2	5350.00	61.45	1.43	62.88	74.00	-11.12	PEAK
3	5360.16	64.78	1.45	66.23	74.00	-7.77	PEAK

Test Site:	96603-WG	Standard:	Part 15.407
Test Mode:	802.11ac VHT80 5290 MHz		
Polarization:	Horizontal		
Remark:			

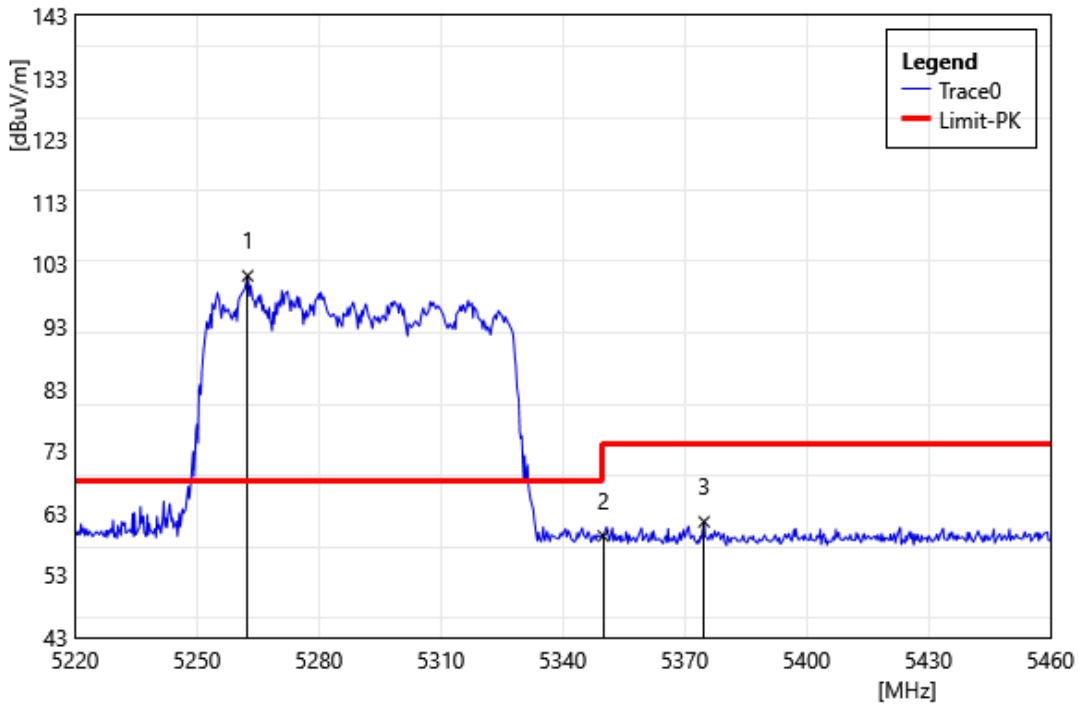

ID	Frequency MHz	Reading dBuV	Correct Factor dB/m	Result dBuV/m	Limit dBuV/m	Margin dB	Remark
1	5262.48	99.65	1.50	101.15	68.20	32.95	PEAK
2	5350.00	57.87	1.43	59.30	74.00	-14.70	PEAK
3	5374.80	60.14	1.45	61.59	74.00	-12.41	PEAK

Test Site:	96603-WG	Standard:	Part 15.407
Test Mode:	802.11ac VHT80 5530 MHz		
Polarization:	Vertical		
Remark:			

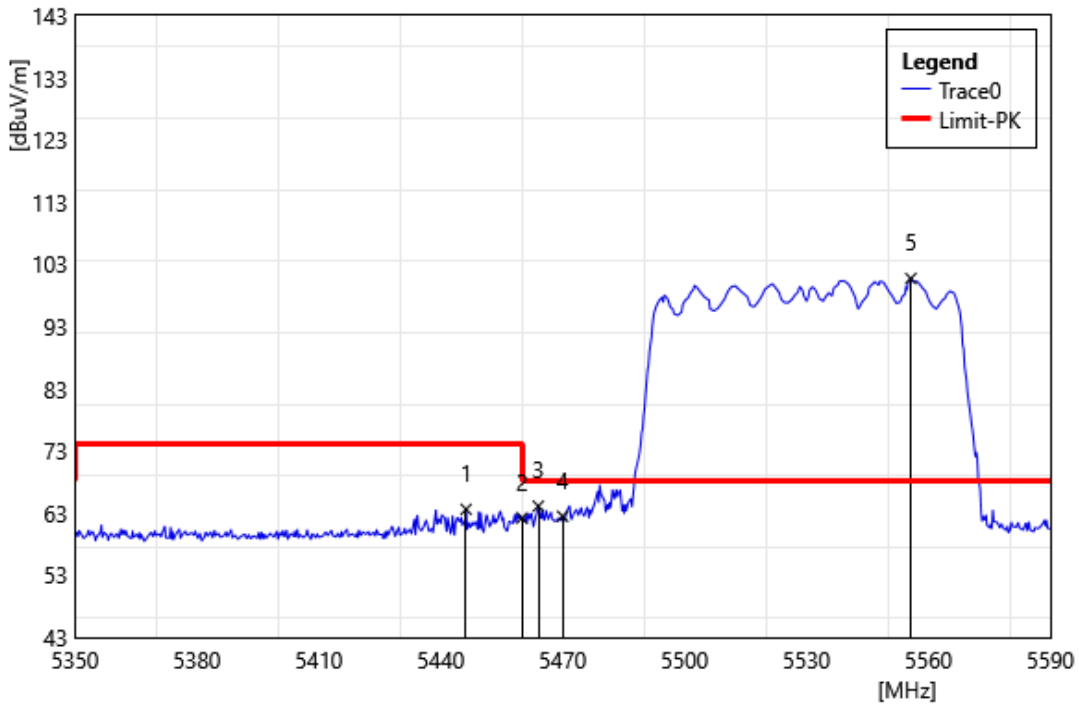

ID	Frequency MHz	Reading dBuV	Correct Factor dB/m	Result dBuV/m	Limit dBuV/m	Margin dB	Remark
1	5446.24	61.90	1.70	63.60	74.00	-10.40	PEAK
2	5460.00	60.39	1.81	62.20	74.00	-11.80	PEAK
3	5464.00	62.29	1.83	64.12	68.20	-4.08	PEAK
4	5470.00	60.60	1.88	62.48	68.20	-5.72	PEAK
5	5555.68	98.37	2.35	100.72	68.20	32.52	PEAK



Test Site:	96603-WG	Standard:	Part 15.407
Test Mode:	802.11ac VHT80 5530 MHz		
Polarization:	Horizontal		
Remark:			

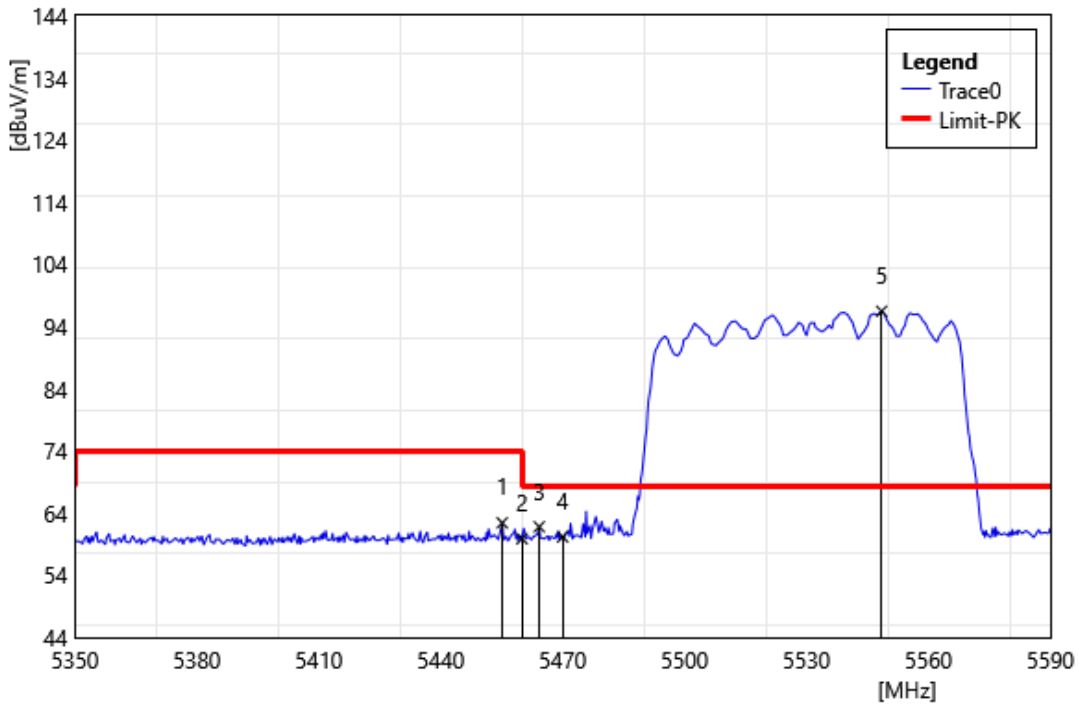

ID	Frequency MHz	Reading dBuV	Correct Factor dB/m	Result dBuV/m	Limit dBuV/m	Margin dB	Remark
1	5455.12	60.66	1.77	62.43	74.00	-11.58	PEAK
2	5460.00	58.06	1.81	59.87	74.00	-14.13	PEAK
3	5464.24	59.96	1.84	61.80	68.20	-6.40	PEAK
4	5470.00	58.28	1.88	60.16	68.20	-8.04	PEAK
5	5548.48	94.13	2.33	96.46	68.20	28.26	PEAK

Test Site:	96603-WG	Standard:	Part 15.407
Test Mode:	802.11ac VHT80 5610 MHz		
Polarization:	Vertical		
Remark:			

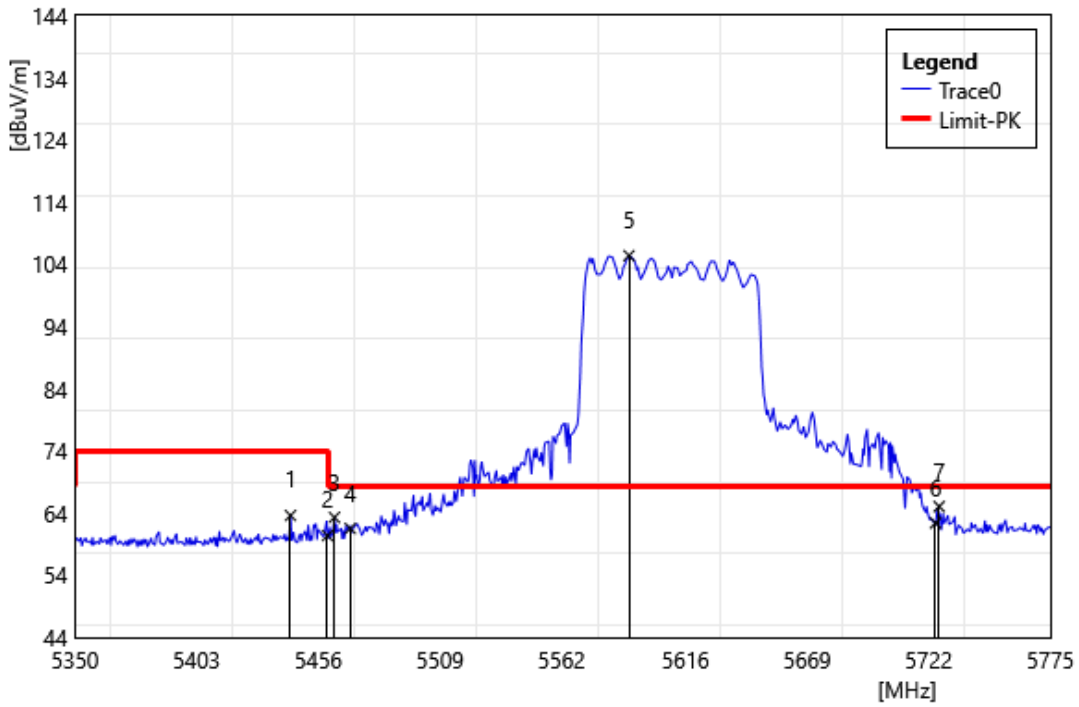

ID	Frequency MHz	Reading dBuV	Correct Factor dB/m	Result dBuV/m	Limit dBuV/m	Margin dB	Remark
1	5443.93	61.92	1.70	63.62	74.00	-10.38	PEAK
2	5460.00	58.56	1.81	60.37	74.00	-13.63	PEAK
3	5463.05	61.48	1.83	63.31	68.20	-4.89	PEAK
4	5470.00	59.65	1.88	61.53	68.20	-6.67	PEAK
5	5591.40	103.02	2.38	105.40	68.20	37.20	PEAK
6	5725.00	59.53	2.87	62.40	68.20	-5.80	PEAK
7	5726.55	62.17	2.89	65.06	68.20	-3.15	PEAK

Test Site:	96603-WG	Standard:	Part 15.407
Test Mode:	802.11ac VHT80 5610 MHz		
Polarization:	Horizontal		
Remark:			

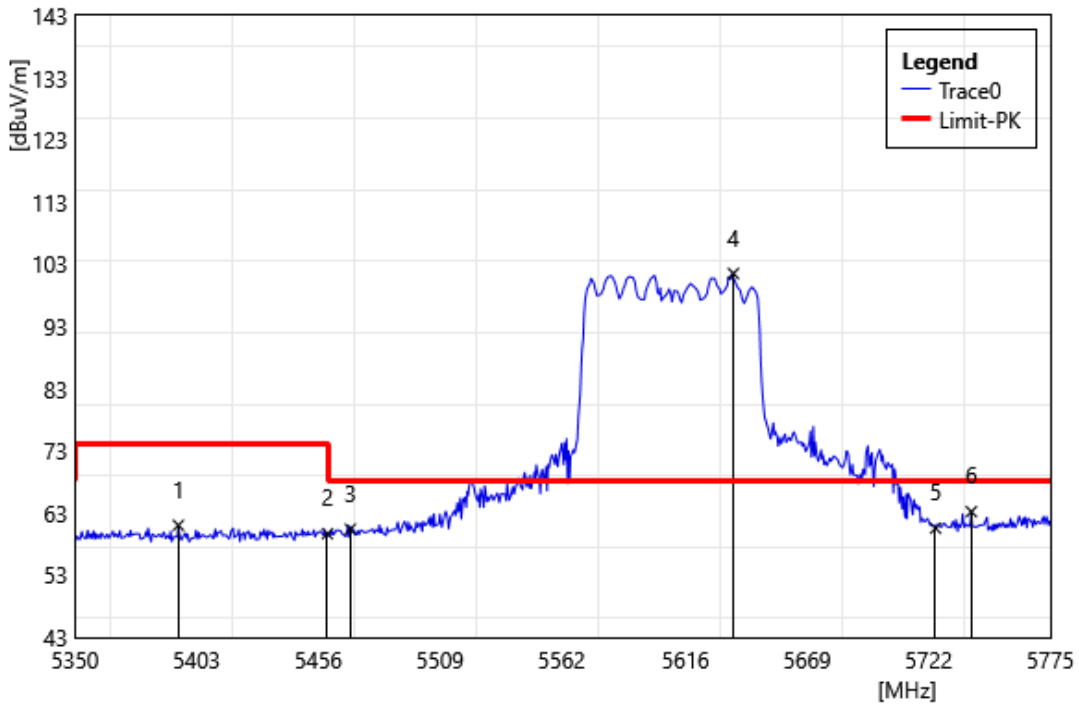

ID	Frequency MHz	Reading dBuV	Correct Factor dB/m	Result dBuV/m	Limit dBuV/m	Margin dB	Remark
1	5395.05	59.57	1.47	61.04	74.00	-12.96	PEAK
2	5460.00	57.86	1.81	59.68	74.00	-14.33	PEAK
3	5470.00	58.53	1.88	60.41	68.20	-7.79	PEAK
4	5636.88	98.90	2.62	101.52	68.20	33.32	PEAK
5	5725.00	57.69	2.87	60.56	68.20	-7.64	PEAK
6	5740.58	60.20	3.02	63.22	68.20	-4.98	PEAK

Test Site:	96603-WG	Standard:	Part 15.407
Test Mode:	802.11ac VHT80 5775 MHz		
Polarization:	Vertical		
Remark:			

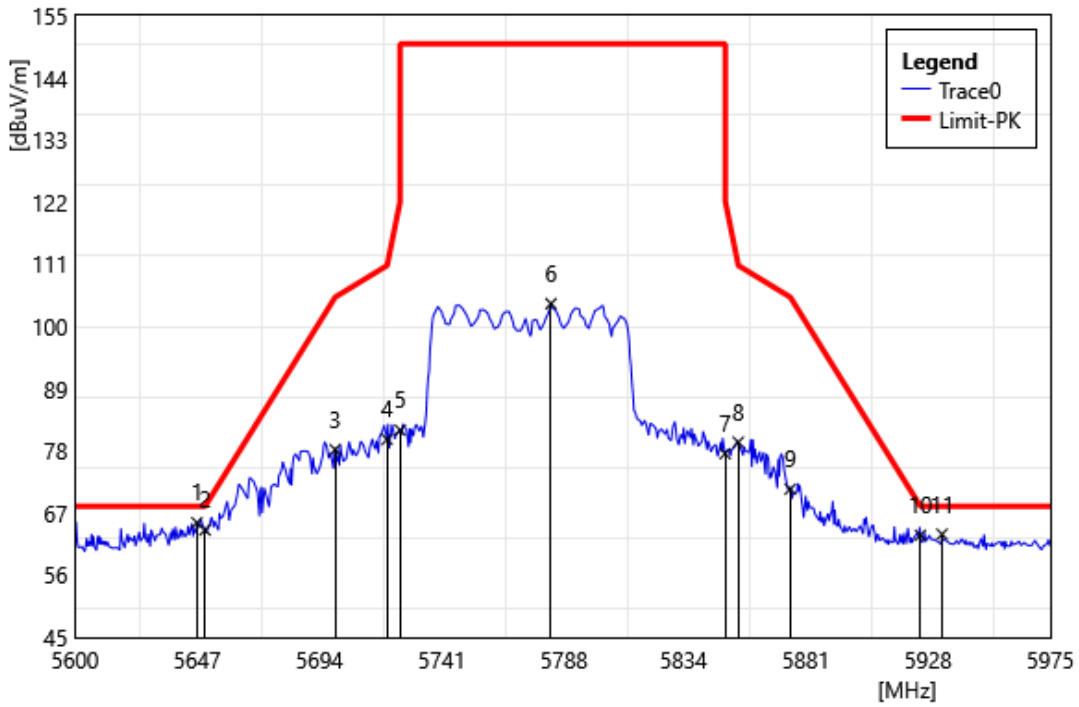

ID	Frequency MHz	Reading dBuV	Correct Factor dB/m	Result dBuV/m	Limit dBuV/m	Margin dB	Remark
1	5646.88	62.61	2.68	65.29	68.20	-2.91	PEAK
2	5650.00	61.30	2.71	64.01	68.20	-4.19	PEAK
3	5700.00	75.59	2.63	78.22	105.20	-26.98	PEAK
4	5720.00	77.19	2.82	80.01	110.80	-30.79	PEAK
5	5725.00	78.81	2.87	81.68	150.00	-68.32	PEAK
6	5783.00	100.67	3.37	104.04	150.00	-45.96	PEAK
7	5850.00	74.00	3.51	77.51	122.20	-44.69	PEAK
8	5855.00	76.05	3.50	79.55	110.80	-31.25	PEAK
9	5875.00	67.75	3.46	71.21	105.20	-33.99	PEAK
10	5925.00	59.82	3.25	63.07	68.20	-5.13	PEAK
11	5933.38	60.07	3.19	63.26	68.20	-4.94	PEAK

Test Site:	96603-WG	Standard:	Part 15.407
Test Mode:	802.11ac VHT80 5775 MHz		
Polarization:	Horizontal		
Remark:			

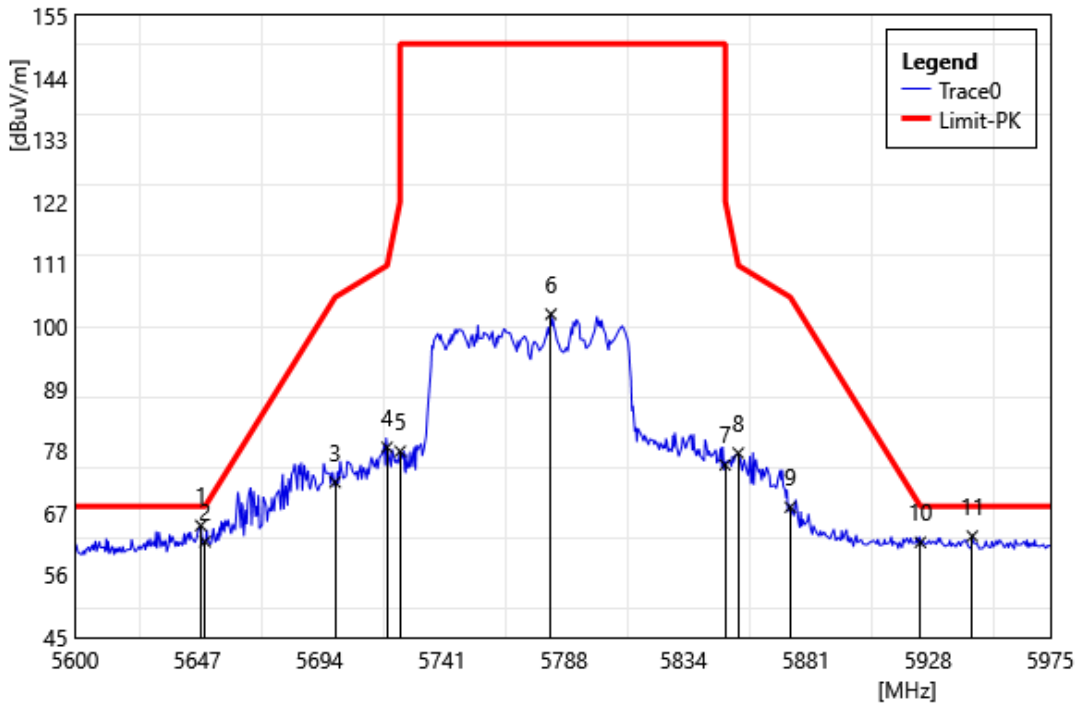

ID	Frequency MHz	Reading dBuV	Correct Factor dB/m	Result dBuV/m	Limit dBuV/m	Margin dB	Remark
1	5648.38	62.11	2.69	64.80	68.20	-3.40	PEAK
2	5650.00	59.23	2.71	61.94	68.20	-6.26	PEAK
3	5700.00	69.82	2.63	72.45	105.20	-32.76	PEAK
4	5720.00	75.81	2.82	78.63	110.80	-32.17	PEAK
5	5725.00	75.05	2.87	77.92	150.00	-72.08	PEAK
6	5783.00	98.82	3.37	102.19	150.00	-47.81	PEAK
7	5850.00	72.01	3.51	75.52	122.20	-46.68	PEAK
8	5855.00	74.12	3.50	77.62	110.80	-33.18	PEAK
9	5875.00	64.58	3.46	68.04	105.20	-37.16	PEAK
10	5925.00	58.57	3.25	61.82	68.20	-6.38	PEAK
11	5945.00	59.80	3.12	62.92	68.20	-5.28	PEAK

Average

Test Site:	96603-WG	Standard:	Part 15.407
Test Mode:	802.11a 5180 MHz		
Polarization:	Vertical		
Remark:			

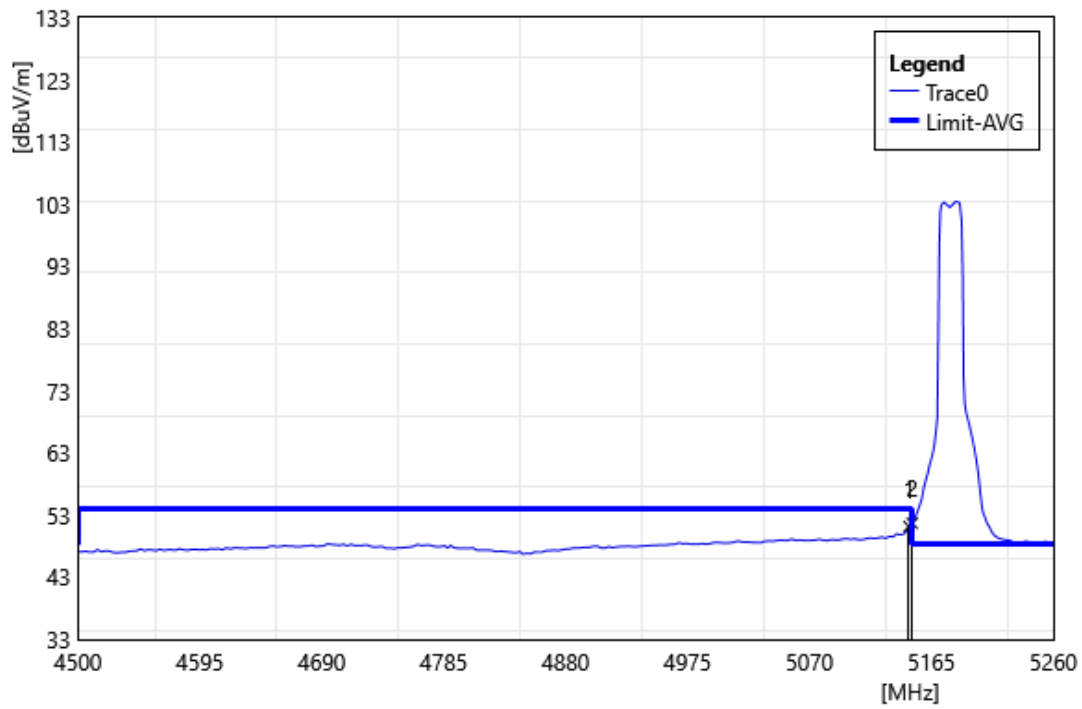

ID	Frequency MHz	Reading dBuV	Correct Factor dB/m	Result dBuV/m	Limit dBuV/m	Margin dB	Remark
1	5147.52	49.07	2.10	51.17	54.00	-2.83	AVG
2	5150.00	49.58	2.10	51.68	54.00	-2.32	AVG

Test Site:	96603-WG	Standard:	Part 15.407
Test Mode:	802.11a 5180 MHz		
Polarization:	Horizontal		
Remark:			

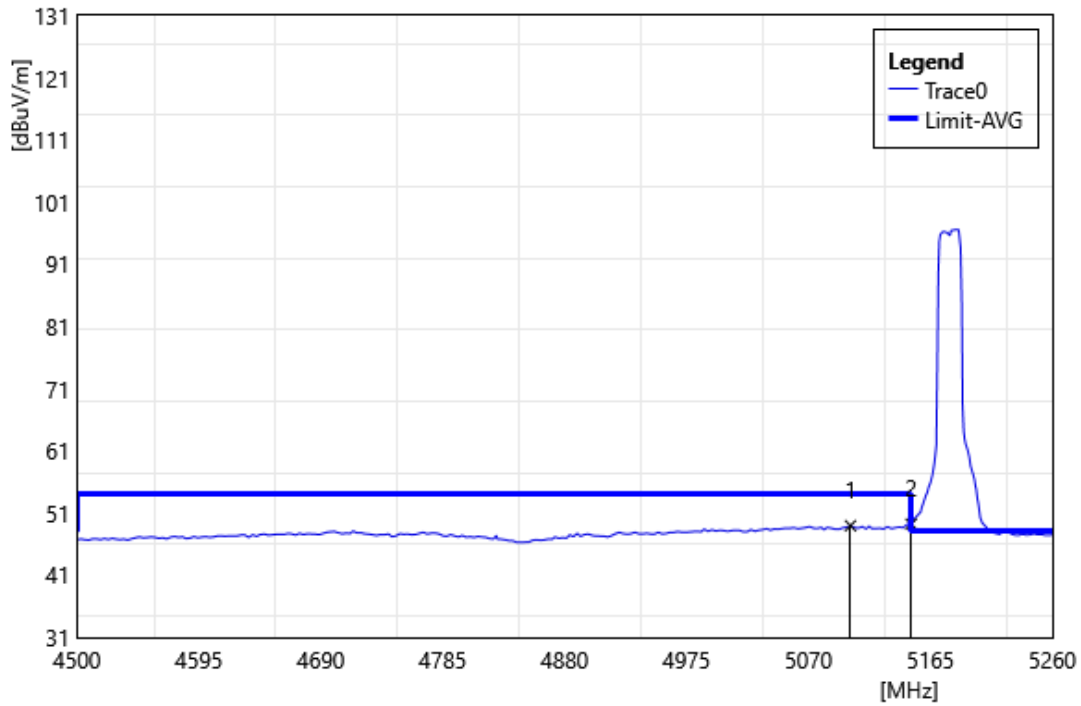

ID	Frequency MHz	Reading dBuV	Correct Factor dB/m	Result dBuV/m	Limit dBuV/m	Margin dB	Remark
1	5102.68	46.96	2.00	48.96	54.00	-5.04	AVG
2	5150.00	47.13	2.10	49.23	54.00	-4.77	AVG

Test Site:	96603-WG	Standard:	Part 15.407
Test Mode:	802.11a 5320 MHz		
Polarization:	Vertical		
Remark:			

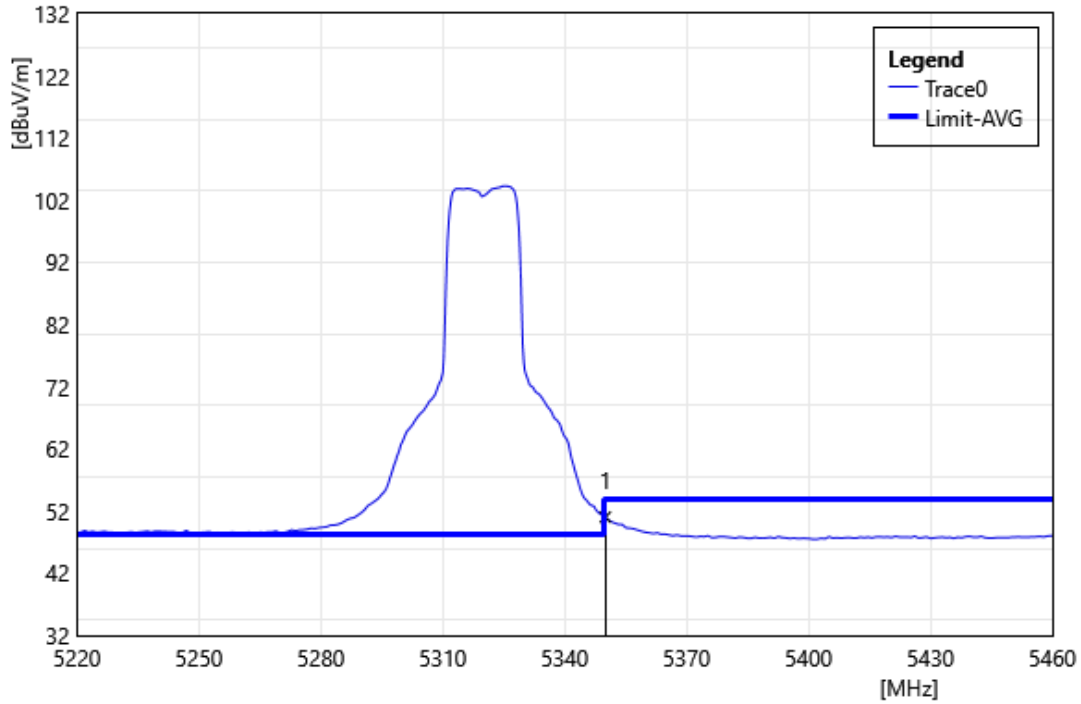

ID	Frequency MHz	Reading dBuV	Correct Factor dB/m	Result dBuV/m	Limit dBuV/m	Margin dB	Remark
1	5350.00	49.31	1.72	51.03	54.00	-2.97	AVG



Test Site:	96603-WG	Standard:	Part 15.407
Test Mode:	802.11a 5320 MHz		
Polarization:	Horizontal		
Remark:			

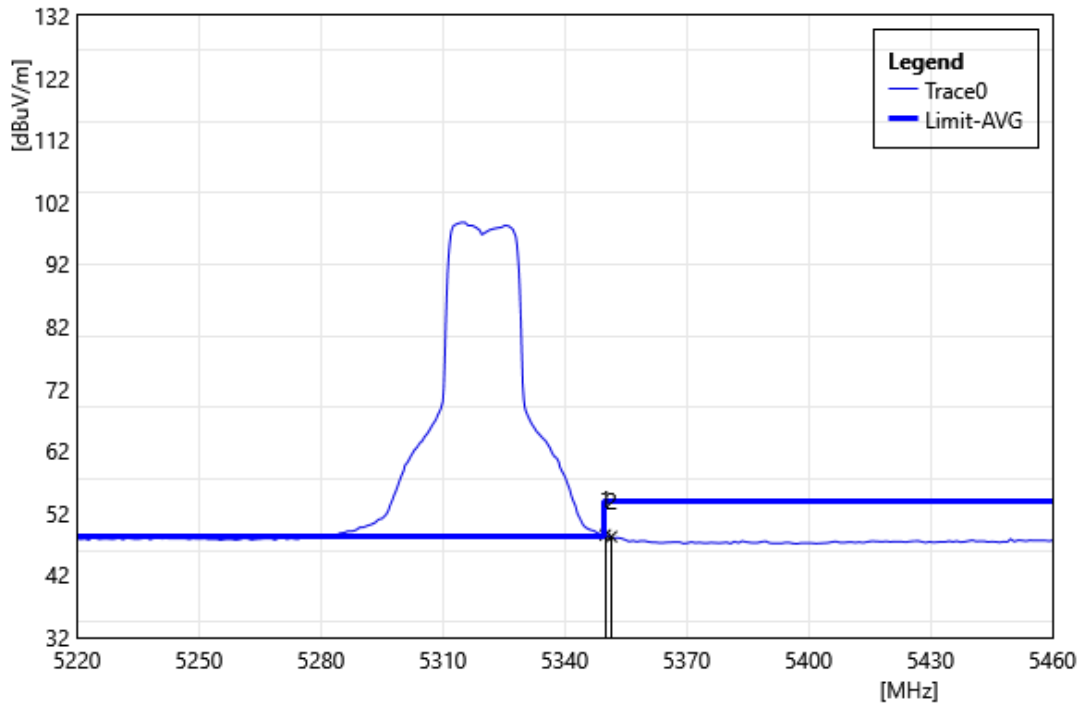

ID	Frequency MHz	Reading dBuV	Correct Factor dB/m	Result dBuV/m	Limit dBuV/m	Margin dB	Remark
1	5350.00	46.76	1.72	48.48	54.00	-5.52	AVG
2	5351.52	46.49	1.73	48.22	54.00	-5.78	AVG

Test Site:	96603-WG	Standard:	Part 15.407
Test Mode:	802.11a 5500 MHz		
Polarization:	Vertical		
Remark:			

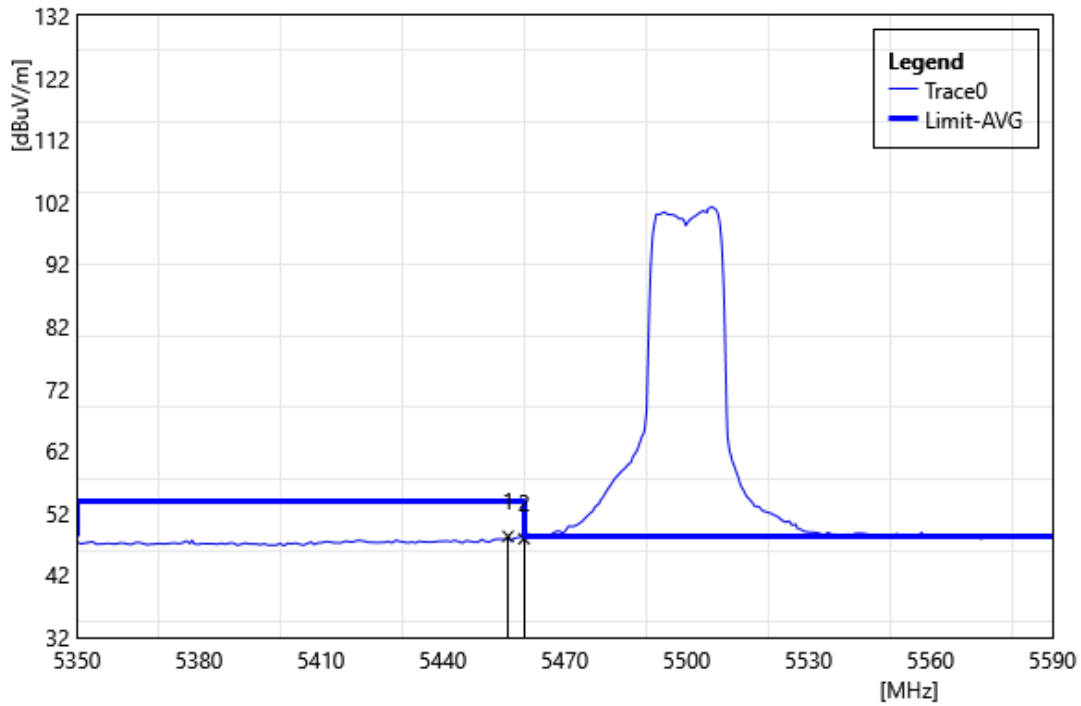

ID	Frequency MHz	Reading dBuV	Correct Factor dB/m	Result dBuV/m	Limit dBuV/m	Margin dB	Remark
1	5456.08	46.26	1.99	48.25	54.00	-5.75	AVG
2	5460.00	45.86	2.01	47.87	54.00	-6.13	AVG

Test Site:	96603-WG	Standard:	Part 15.407
Test Mode:	802.11a 5500 MHz		
Polarization:	Horizontal		
Remark:			

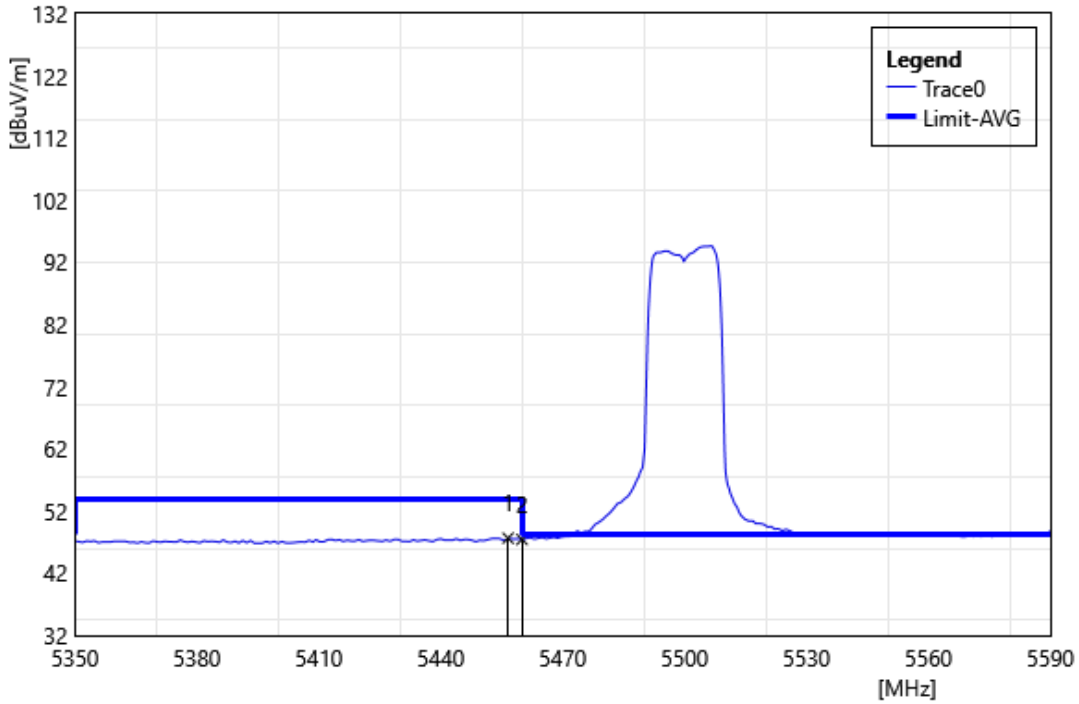

ID	Frequency MHz	Reading dBuV	Correct Factor dB/m	Result dBuV/m	Limit dBuV/m	Margin dB	Remark
1	5456.56	45.65	1.99	47.64	54.00	-6.36	AVG
2	5460.00	45.41	2.01	47.42	54.00	-6.58	AVG

Test Site:	96603-WG	Standard:	Part 15.407
Test Mode:	802.11ac VHT20 5180 MHz		
Polarization:	Vertical		
Remark:			

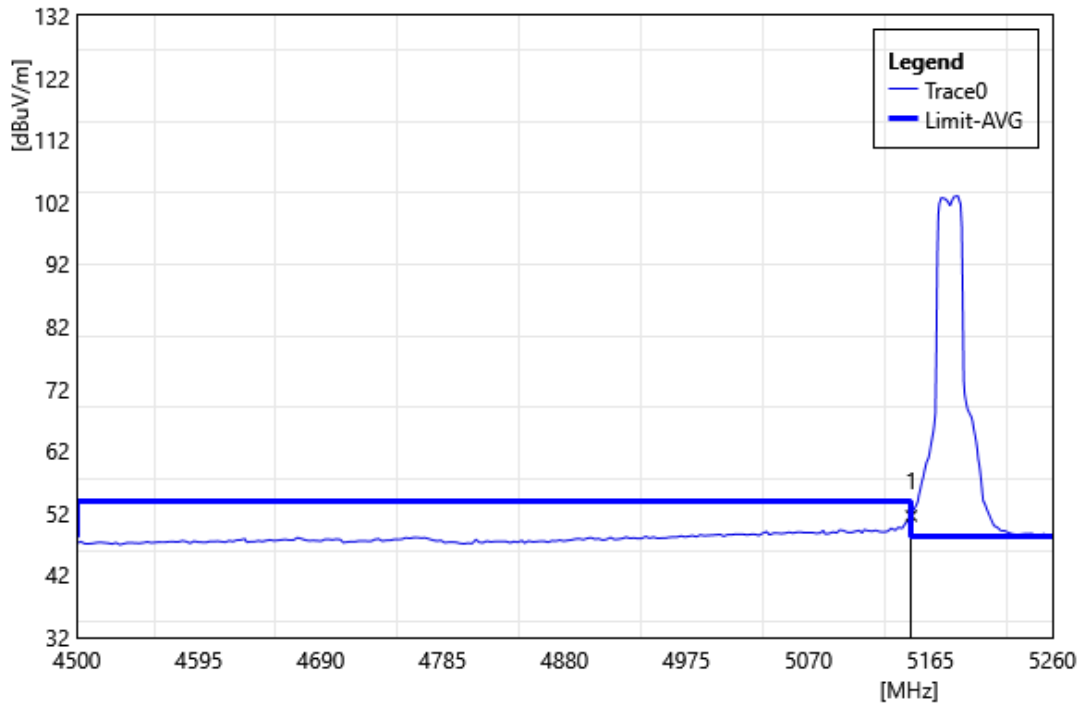

ID	Frequency MHz	Reading dBuV	Correct Factor dB/m	Result dBuV/m	Limit dBuV/m	Margin dB	Remark
1	5150.00	49.71	1.84	51.55	54.00	-2.45	AVG

Test Site:	96603-WG	Standard:	Part 15.407
Test Mode:	802.11ac VHT20 5180 MHz		
Polarization:	Horizontal		
Remark:			

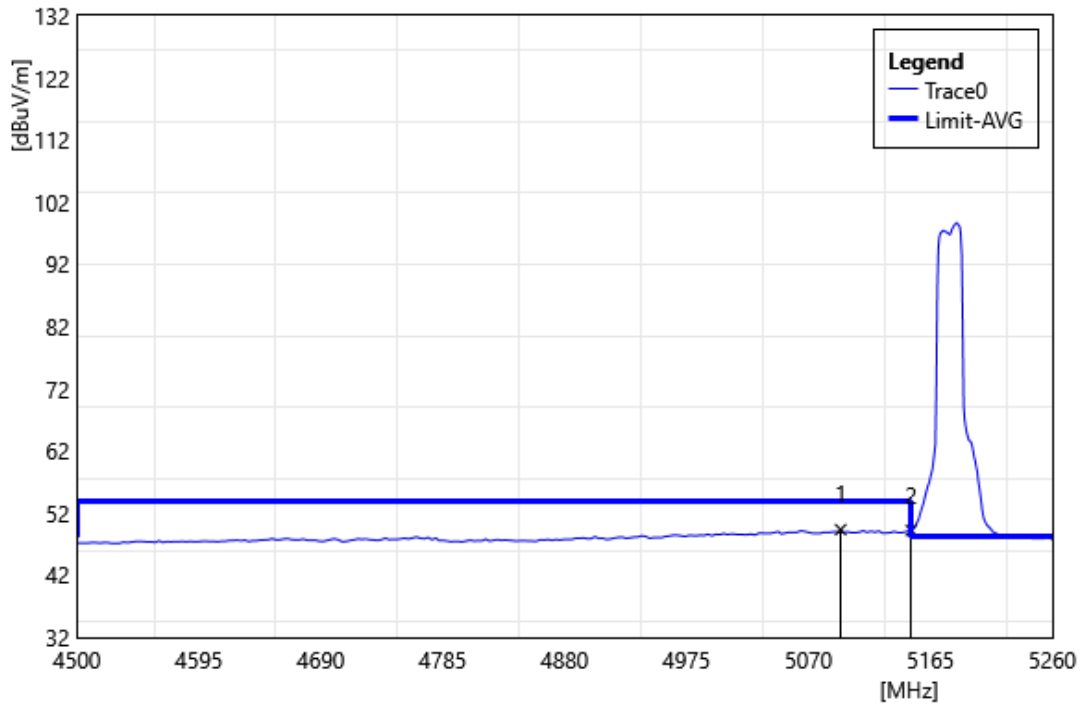

ID	Frequency MHz	Reading dBuV	Correct Factor dB/m	Result dBuV/m	Limit dBuV/m	Margin dB	Remark
1	5095.08	47.63	1.71	49.34	54.00	-4.66	AVG
2	5150.00	47.37	1.84	49.21	54.00	-4.79	AVG

Test Site:	96603-WG	Standard:	Part 15.407
Test Mode:	802.11ac VHT20 5320 MHz		
Polarization:	Vertical		
Remark:			

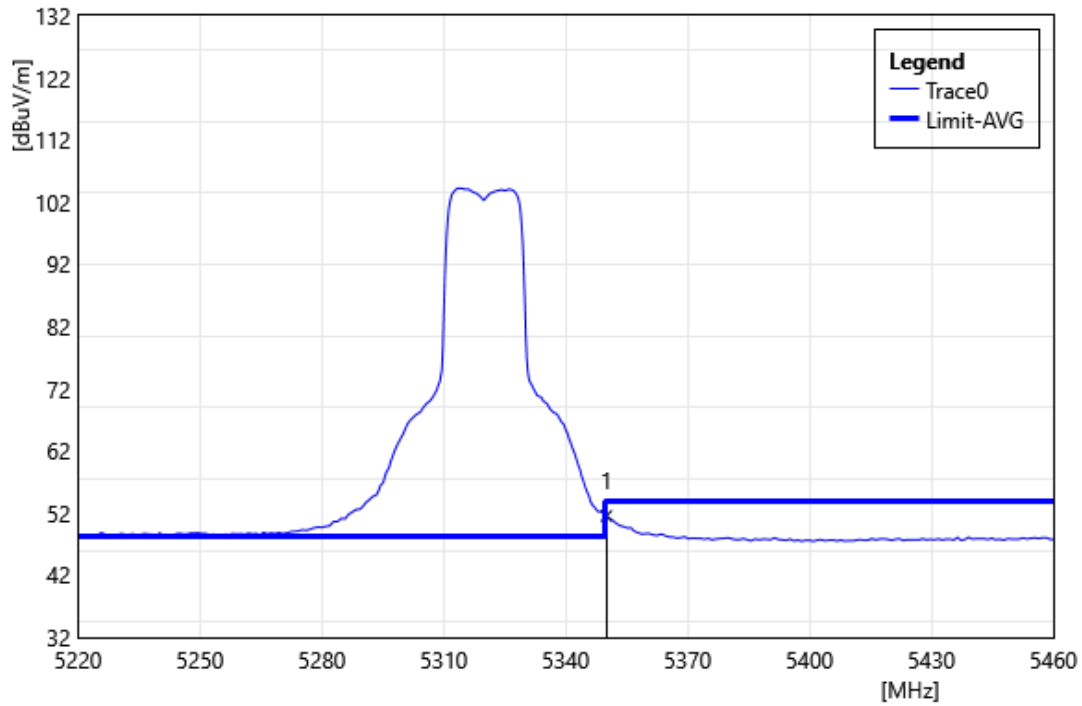

ID	Frequency MHz	Reading dBuV	Correct Factor dB/m	Result dBuV/m	Limit dBuV/m	Margin dB	Remark
1	5350.00	50.11	1.43	51.54	54.00	-2.46	AVG

Test Site:	96603-WG	Standard:	Part 15.407
Test Mode:	802.11ac VHT20 5320 MHz		
Polarization:	Horizontal		
Remark:			

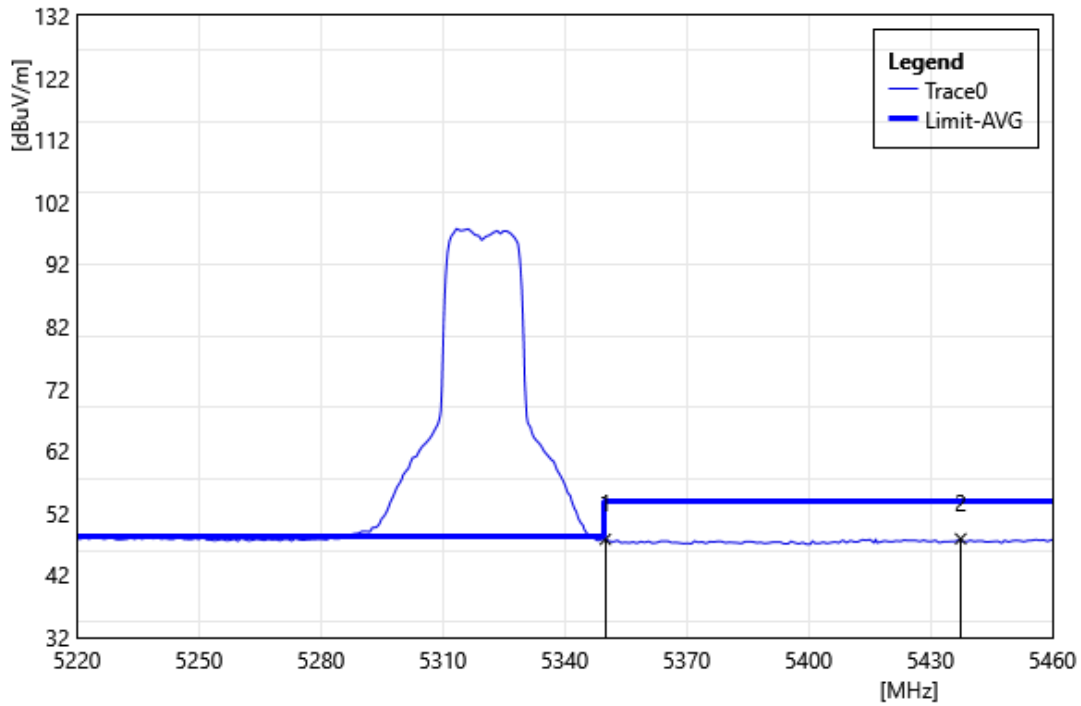

ID	Frequency MHz	Reading dBuV	Correct Factor dB/m	Result dBuV/m	Limit dBuV/m	Margin dB	Remark
1	5350.00	46.33	1.43	47.76	54.00	-6.24	AVG
2	5437.44	46.20	1.66	47.86	54.00	-6.14	AVG

Test Site:	96603-WG	Standard:	Part 15.407
Test Mode:	802.11ac VHT20 5500 MHz		
Polarization:	Vertical		
Remark:			

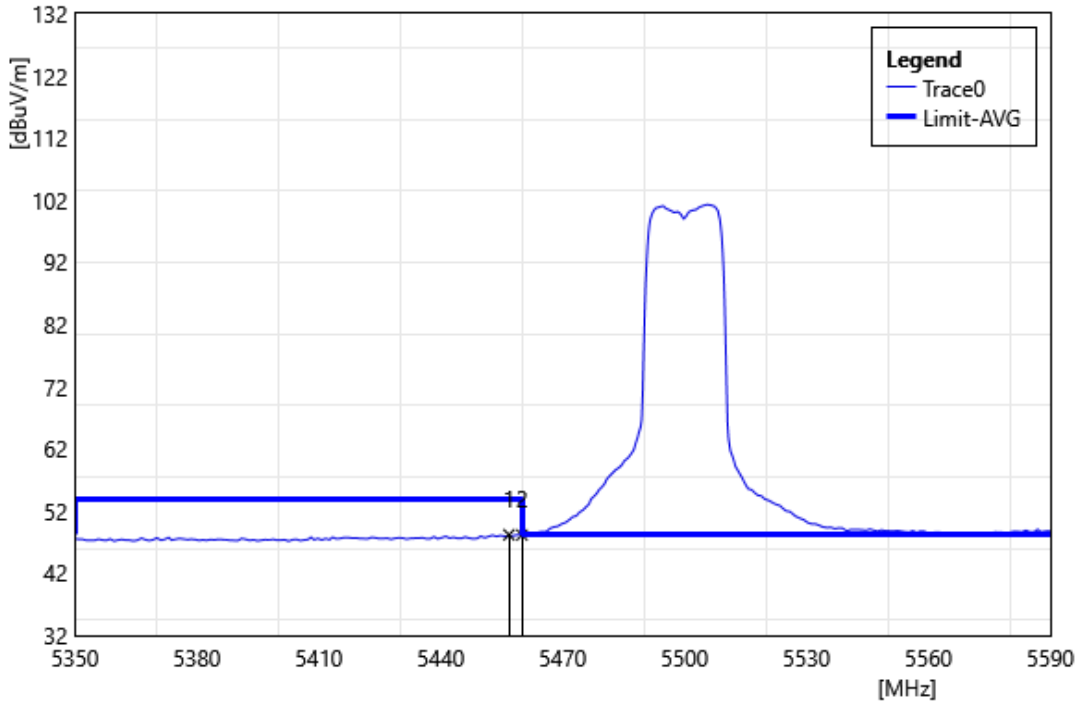

ID	Frequency MHz	Reading dBuV	Correct Factor dB/m	Result dBuV/m	Limit dBuV/m	Margin dB	Remark
1	5456.80	46.41	1.78	48.19	54.00	-5.82	AVG
2	5460.00	46.35	1.81	48.16	54.00	-5.84	AVG



Test Site:	96603-WG	Standard:	Part 15.407
Test Mode:	802.11ac VHT20 5500 MHz		
Polarization:	Horizontal		
Remark:			

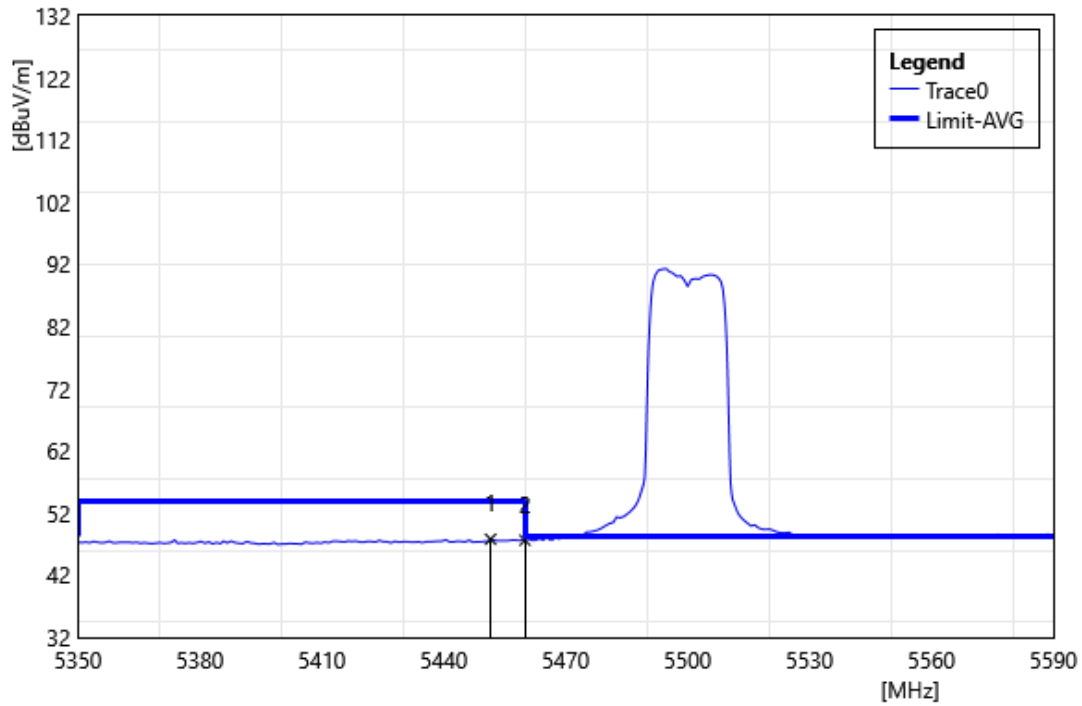

ID	Frequency MHz	Reading dBuV	Correct Factor dB/m	Result dBuV/m	Limit dBuV/m	Margin dB	Remark
1	5451.52	46.05	1.75	47.80	54.00	-6.21	AVG
2	5460.00	45.83	1.81	47.64	54.00	-6.36	AVG

Test Site:	96603-WG	Standard:	Part 15.407
Test Mode:	802.11ac VHT40 5190 MHz		
Polarization:	Vertical		
Remark:			

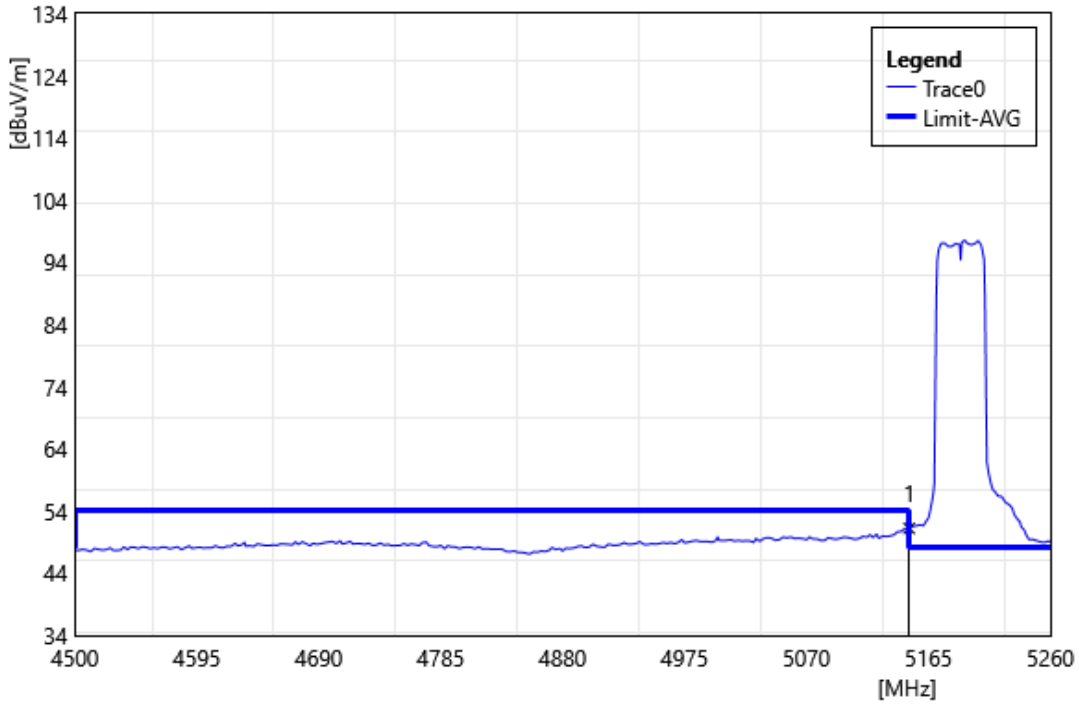

ID	Frequency MHz	Reading dBuV	Correct Factor dB/m	Result dBuV/m	Limit dBuV/m	Margin dB	Remark
1	5150.00	49.38	1.84	51.22	54.00	-2.78	AVG

Test Site:	96603-WG	Standard:	Part 15.407
Test Mode:	802.11ac VHT40 5190 MHz		
Polarization:	Horizontal		
Remark:			

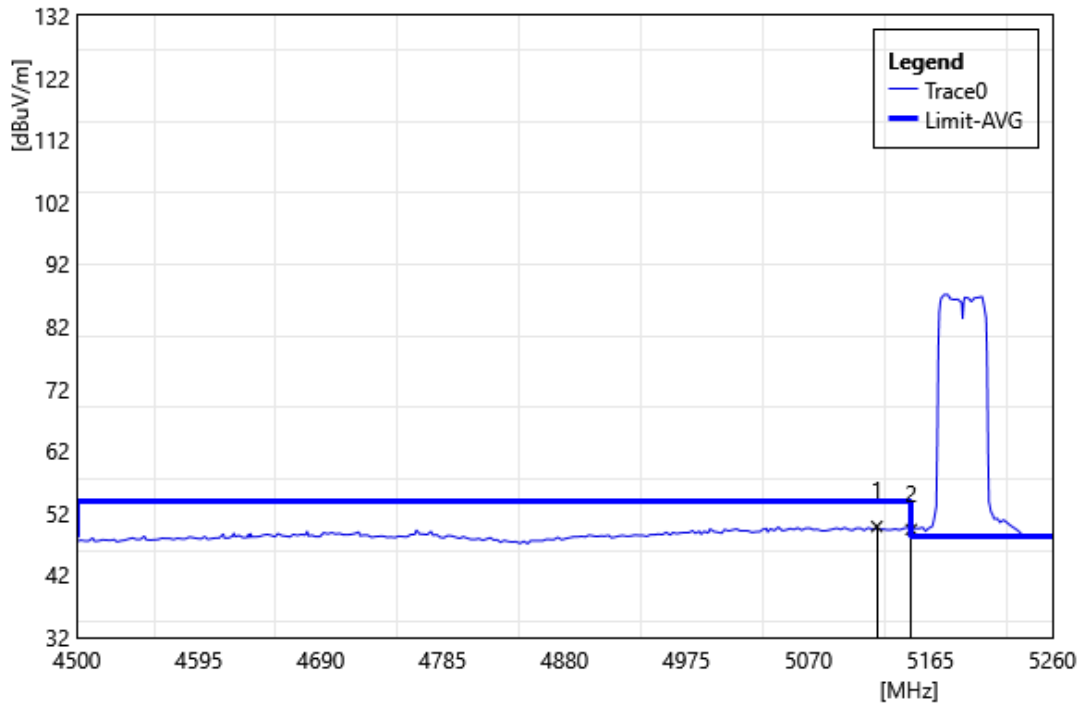

ID	Frequency MHz	Reading dBuV	Correct Factor dB/m	Result dBuV/m	Limit dBuV/m	Margin dB	Remark
1	5123.20	48.06	1.78	49.84	54.00	-4.16	AVG
2	5150.00	47.52	1.84	49.36	54.00	-4.64	AVG

Test Site:	96603-WG	Standard:	Part 15.407
Test Mode:	802.11ac VHT40 5310 MHz		
Polarization:	Vertical		
Remark:			

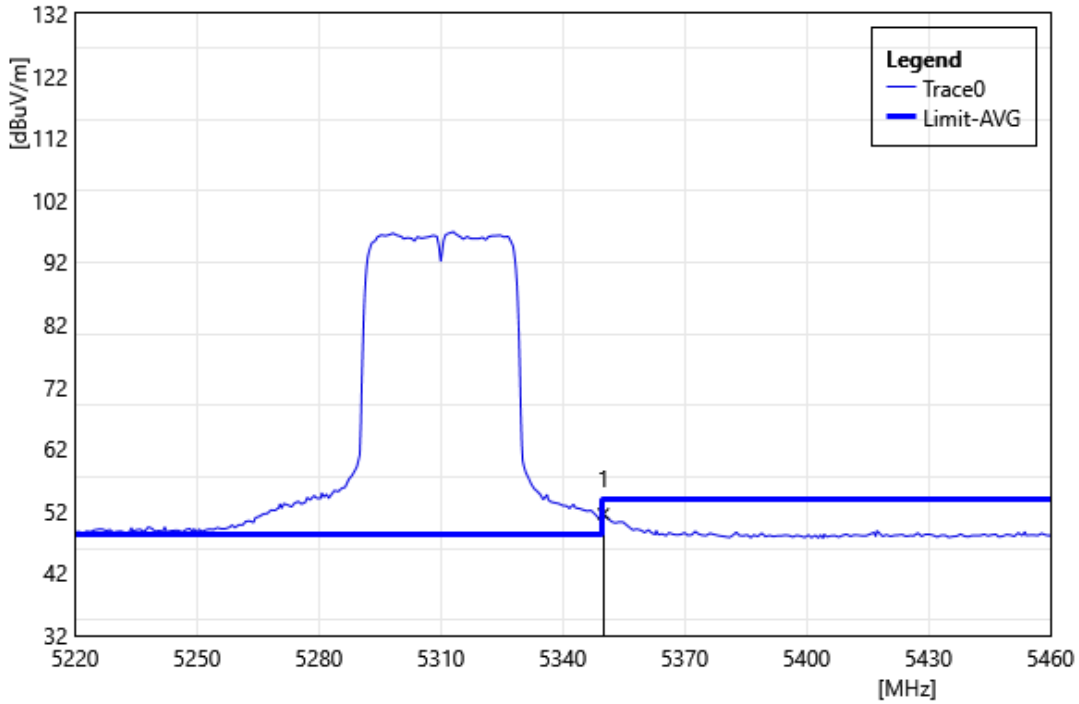

ID	Frequency MHz	Reading dBuV	Correct Factor dB/m	Result dBuV/m	Limit dBuV/m	Margin dB	Remark
1	5350.00	50.12	1.43	51.55	54.00	-2.45	AVG

Test Site:	96603-WG	Standard:	Part 15.407
Test Mode:	802.11ac VHT40 5310 MHz		
Polarization:	Horizontal		
Remark:			

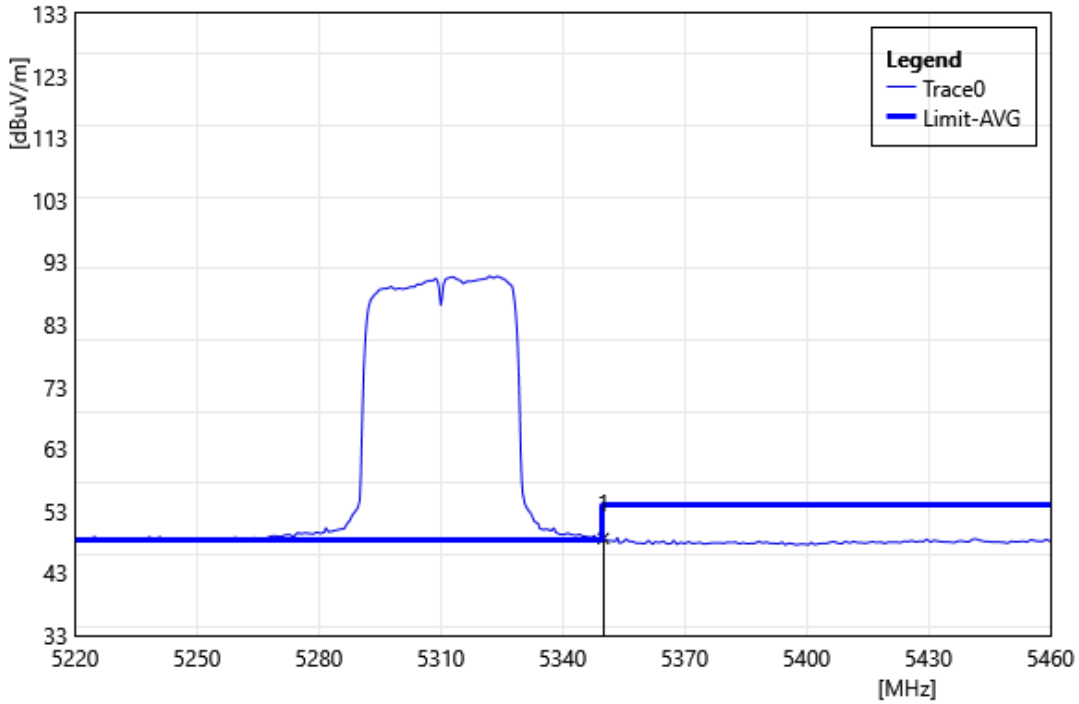

ID	Frequency MHz	Reading dBuV	Correct Factor dB/m	Result dBuV/m	Limit dBuV/m	Margin dB	Remark
1	5350.00	47.15	1.43	48.58	54.00	-5.42	AVG

Test Site:	96603-WG	Standard:	Part 15.407
Test Mode:	802.11ac VHT40 5510 MHz		
Polarization:	Vertical		
Remark:			

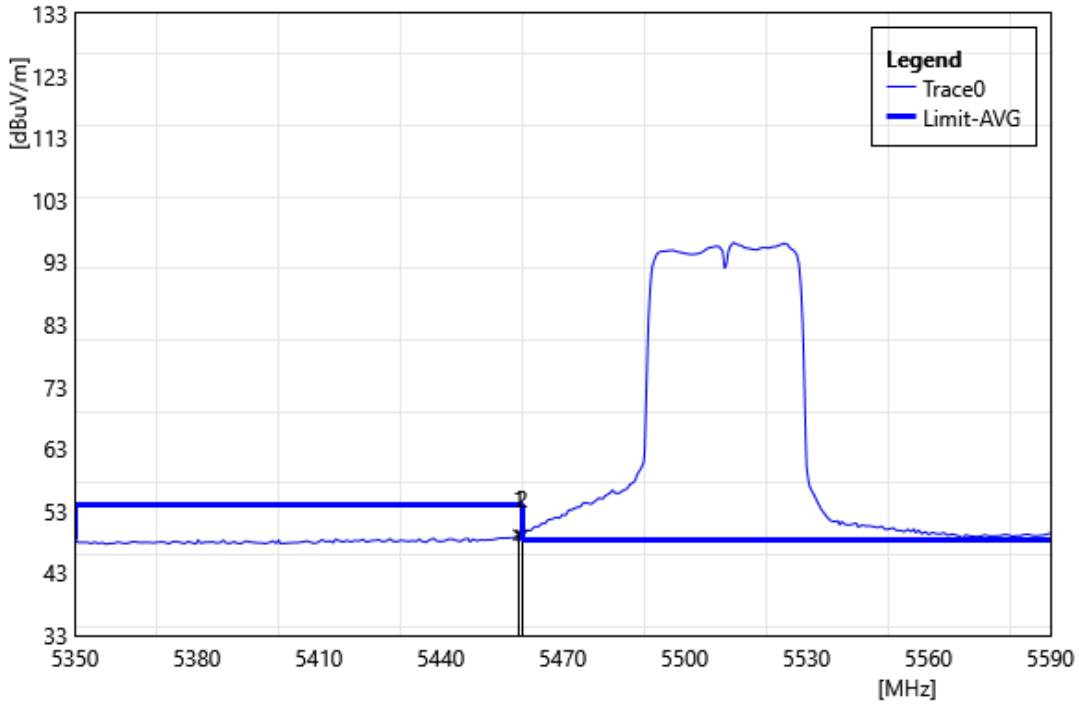

ID	Frequency MHz	Reading dBuV	Correct Factor dB/m	Result dBuV/m	Limit dBuV/m	Margin dB	Remark
1	5459.20	47.35	1.81	49.16	54.00	-4.84	AVG
2	5460.00	47.29	1.81	49.10	54.00	-4.90	AVG

Test Site:	96603-WG	Standard:	Part 15.407
Test Mode:	802.11ac VHT40 5510 MHz		
Polarization:	Horizontal		
Remark:			

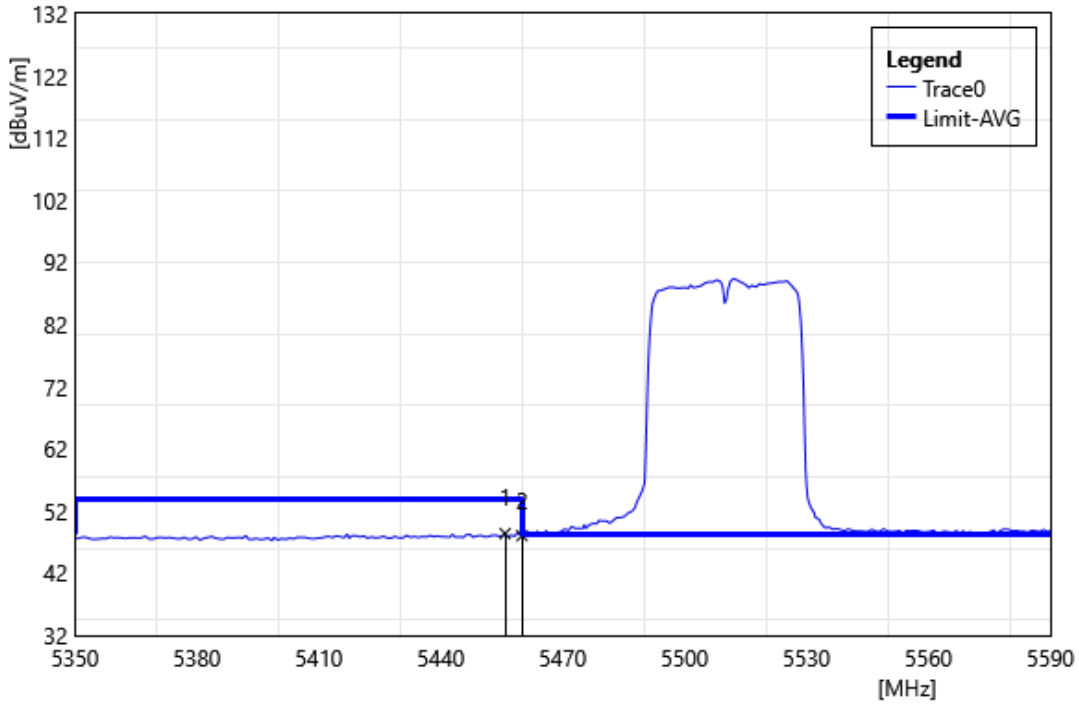

ID	Frequency MHz	Reading dBuV	Correct Factor dB/m	Result dBuV/m	Limit dBuV/m	Margin dB	Remark
1	5455.84	46.58	1.78	48.36	54.00	-5.64	AVG
2	5460.00	46.23	1.81	48.04	54.00	-5.96	AVG

Test Site:	96603-WG	Standard:	Part 15.407
Test Mode:	802.11ac VHT80 5210 MHz		
Polarization:	Vertical		
Remark:			

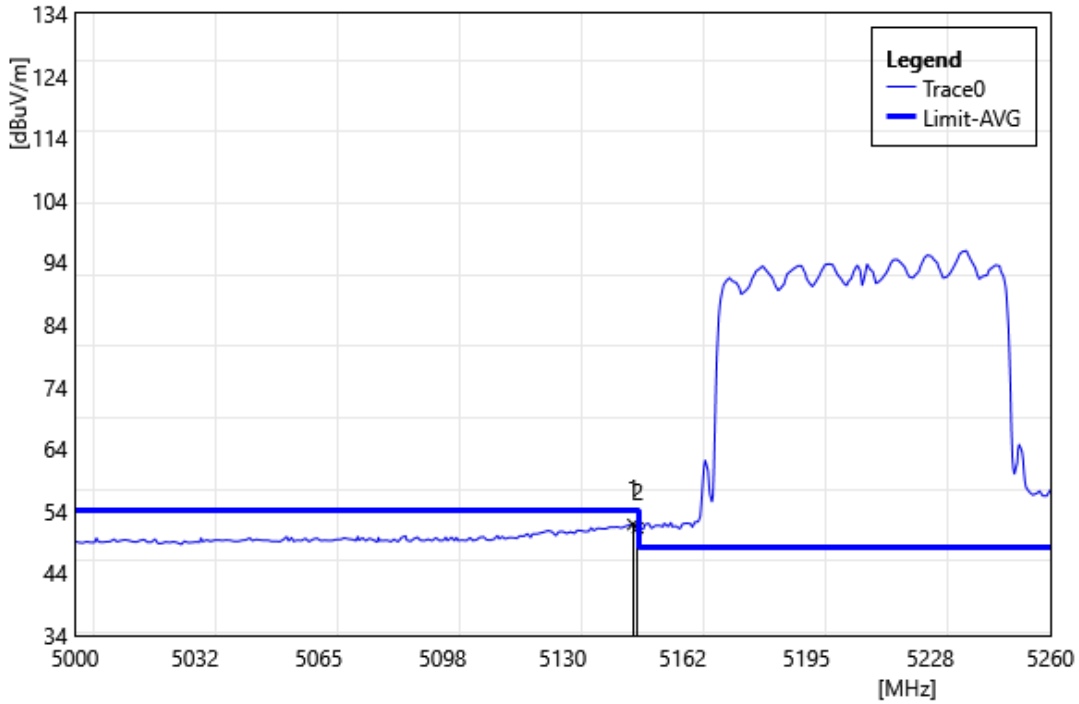

ID	Frequency MHz	Reading dBuV	Correct Factor dB/m	Result dBuV/m	Limit dBuV/m	Margin dB	Remark
1	5148.72	50.00	1.84	51.84	54.00	-2.16	AVG
2	5150.00	49.45	1.84	51.29	54.00	-2.71	AVG



Test Site:	96603-WG	Standard:	Part 15.407
Test Mode:	802.11ac VHT80 5210 MHz		
Polarization:	Horizontal		
Remark:			

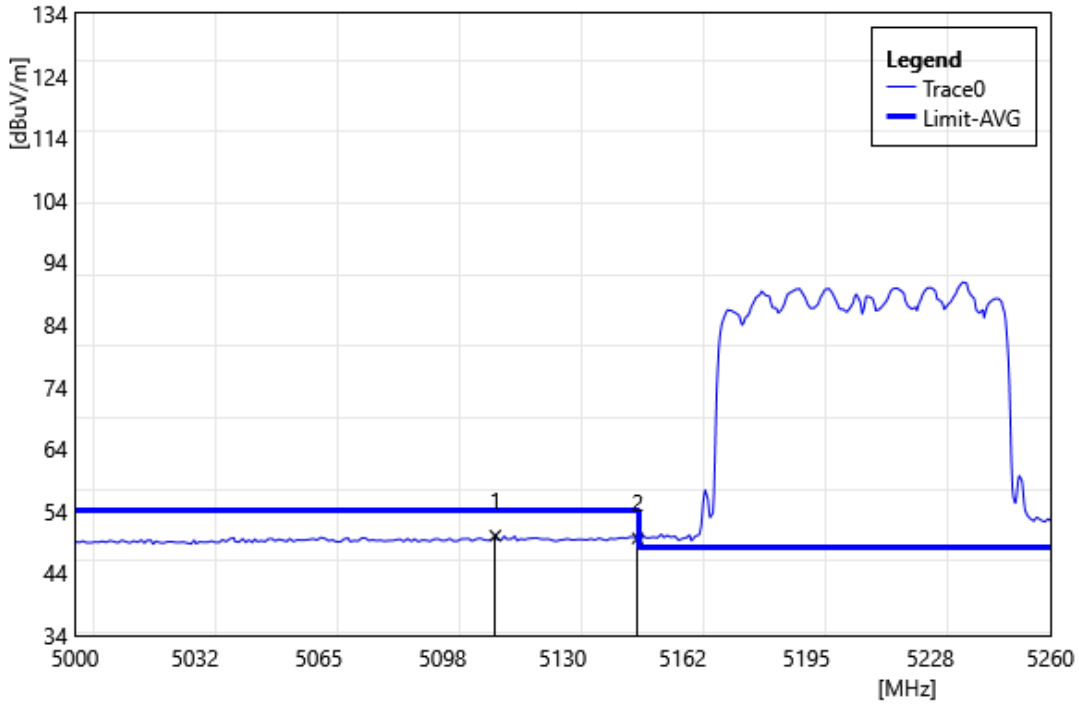

ID	Frequency MHz	Reading dBuV	Correct Factor dB/m	Result dBuV/m	Limit dBuV/m	Margin dB	Remark
1	5112.06	48.28	1.75	50.03	54.00	-3.97	AVG
2	5150.00	47.78	1.84	49.62	54.00	-4.38	AVG

Test Site:	96603-WG	Standard:	Part 15.407
Test Mode:	802.11ac VHT80 5290 MHz		
Polarization:	Vertical		
Remark:			

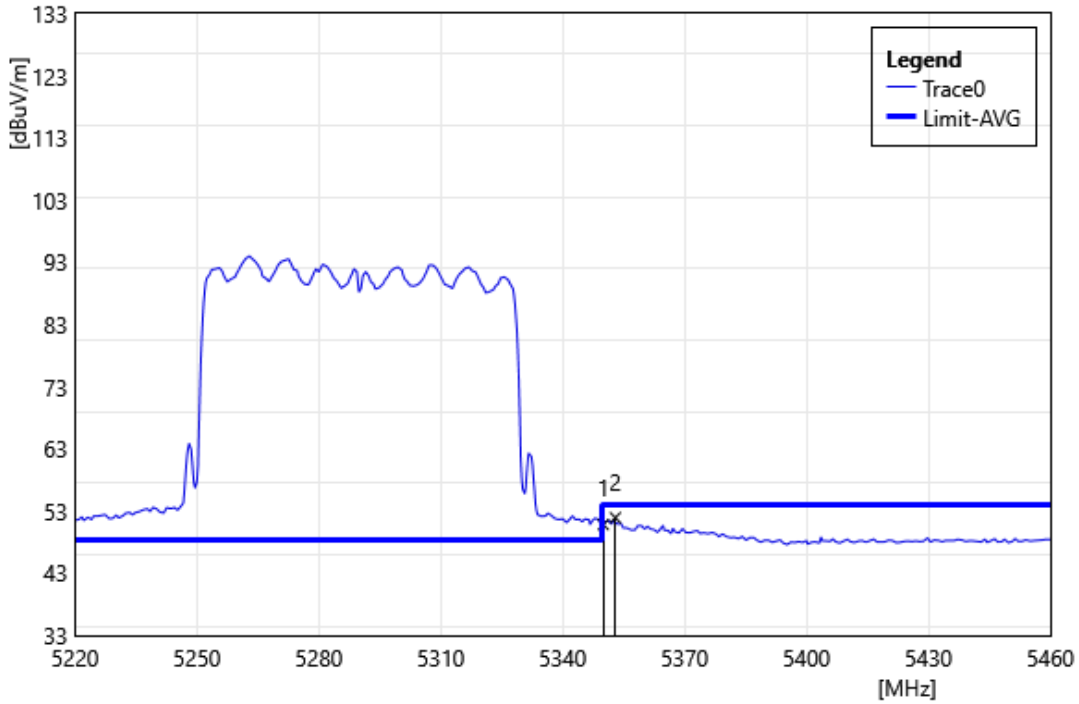

ID	Frequency MHz	Reading dBuV	Correct Factor dB/m	Result dBuV/m	Limit dBuV/m	Margin dB	Remark
1	5350.00	49.40	1.43	50.83	54.00	-3.17	AVG
2	5352.96	50.48	1.44	51.92	54.00	-2.08	AVG

Test Site:	96603-WG	Standard:	Part 15.407
Test Mode:	802.11ac VHT80 5290 MHz		
Polarization:	Horizontal		
Remark:			

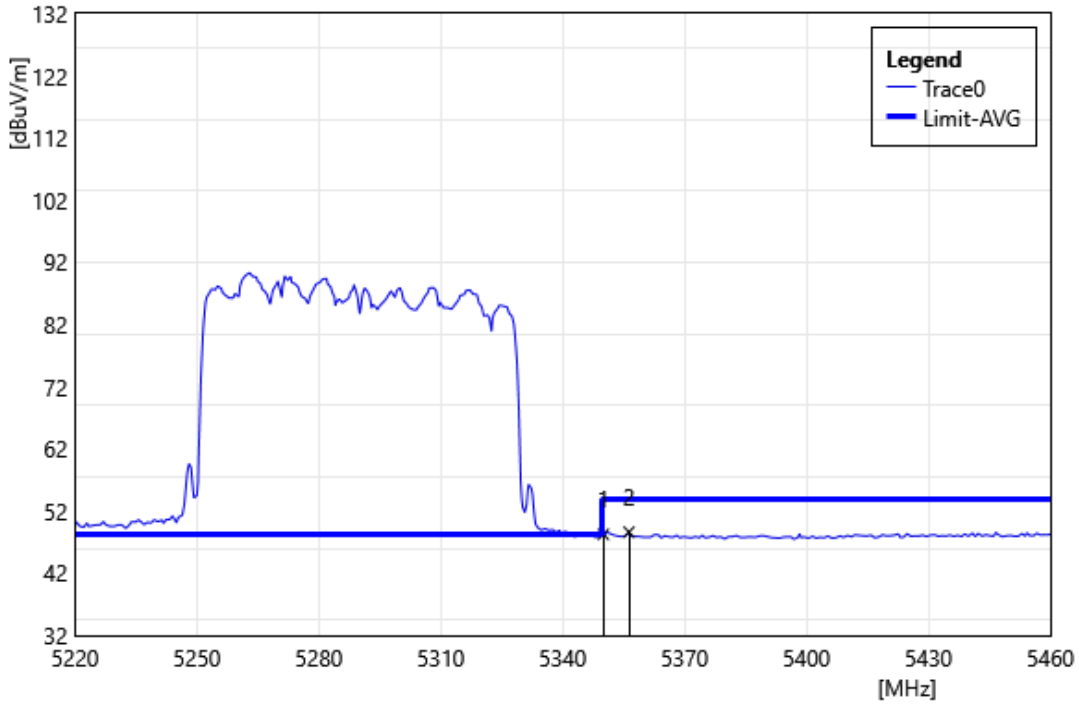

ID	Frequency MHz	Reading dBuV	Correct Factor dB/m	Result dBuV/m	Limit dBuV/m	Margin dB	Remark
1	5350.00	46.83	1.43	48.26	54.00	-5.74	AVG
2	5356.32	47.18	1.44	48.62	54.00	-5.39	AVG

Test Site:	96603-WG	Standard:	Part 15.407
Test Mode:	802.11ac VHT80 5530 MHz		
Polarization:	Vertical		
Remark:			

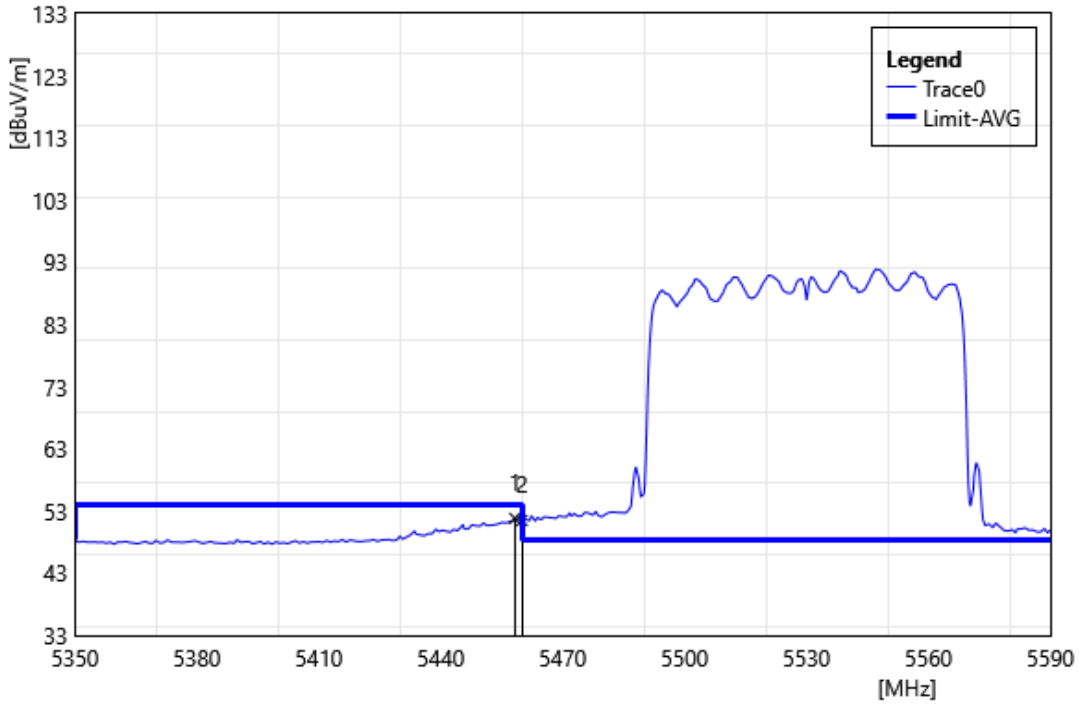

ID	Frequency MHz	Reading dBuV	Correct Factor dB/m	Result dBuV/m	Limit dBuV/m	Margin dB	Remark
1	5458.24	50.02	1.79	51.81	54.00	-2.19	AVG
2	5460.00	49.67	1.81	51.48	54.00	-2.52	AVG

Test Site:	96603-WG	Standard:	Part 15.407
Test Mode:	802.11ac VHT80 5530 MHz		
Polarization:	Horizontal		
Remark:			

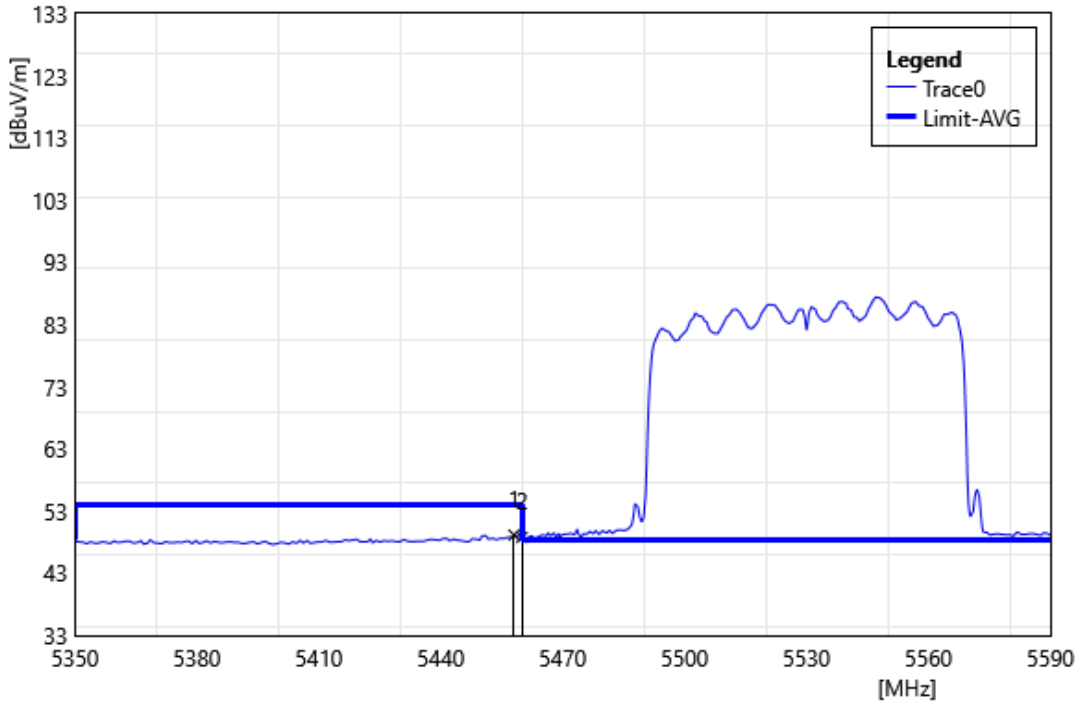

ID	Frequency MHz	Reading dBuV	Correct Factor dB/m	Result dBuV/m	Limit dBuV/m	Margin dB	Remark
1	5458.00	47.36	1.79	49.15	54.00	-4.85	AVG
2	5460.00	46.95	1.81	48.76	54.00	-5.24	AVG

Test Site:	96603-WG	Standard:	Part 15.407
Test Mode:	802.11ac VHT80 5610 MHz		
Polarization:	Vertical		
Remark:			

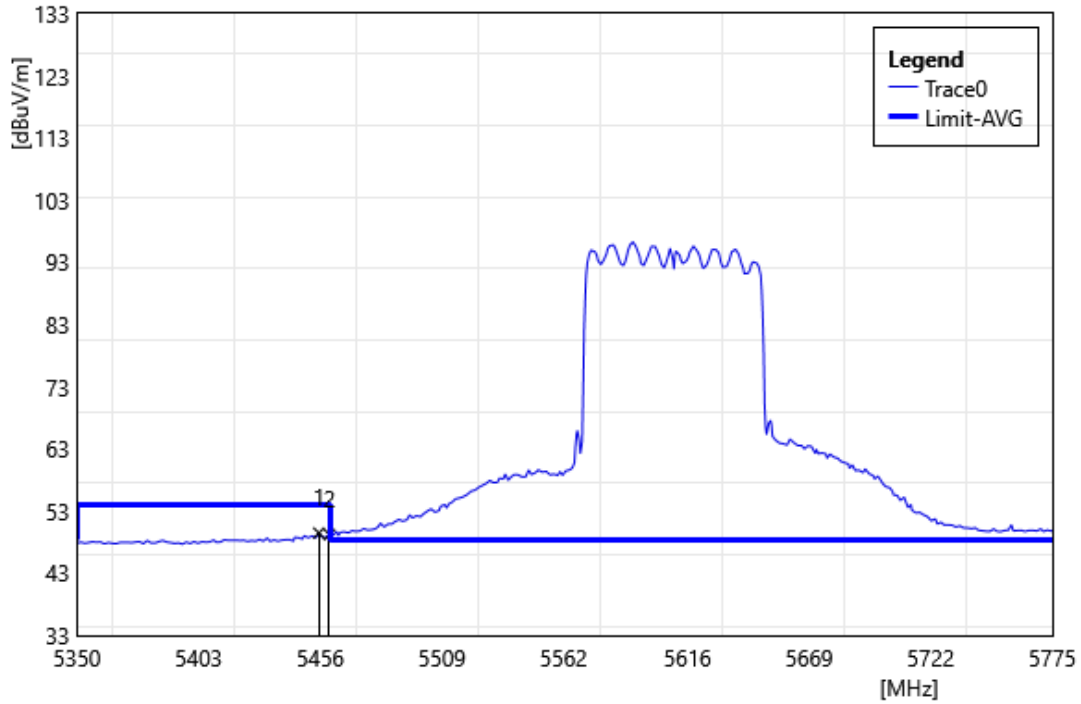

ID	Frequency MHz	Reading dBuV	Correct Factor dB/m	Result dBuV/m	Limit dBuV/m	Margin dB	Remark
1	5455.40	47.69	1.77	49.46	54.00	-4.54	AVG
2	5460.00	47.39	1.81	49.20	54.00	-4.80	AVG

Test Site:	96603-WG	Standard:	Part 15.407
Test Mode:	802.11ac VHT80 5610 MHz		
Polarization:	Horizontal		
Remark:			

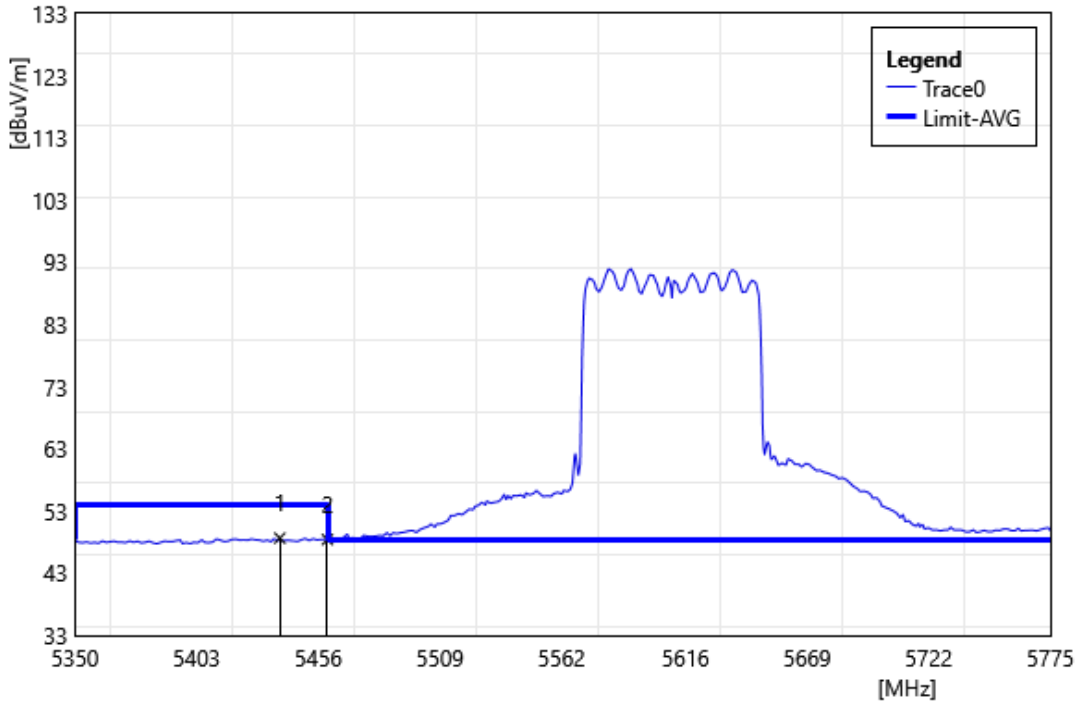

ID	Frequency MHz	Reading dBuV	Correct Factor dB/m	Result dBuV/m	Limit dBuV/m	Margin dB	Remark
1	5439.25	46.99	1.67	48.66	54.00	-5.34	AVG
2	5460.00	46.61	1.81	48.42	54.00	-5.58	AVG

**Duty cycle**

Reference Appendix A / Appendix B

**Maximum Conducted Output Power Measurement**

Reference Appendix A

**26 dB RF Bandwidth Measurement & 99 % Occupied Bandwidth Measurement**

Reference Appendix A / Appendix B

**6 dB RF Bandwidth Measurement**

Reference Appendix A / Appendix B

**Maximum Power Spectral Density Measurement**

Reference Appendix A / Appendix B

---END---