





Certificate No. : 4271.01

**Prüfbericht – Produkte**  
Test Report - Products

<b>Prüfbericht-Nr.:</b> <i>Test report no.:</i>	<b>IN22T1OT 001</b> <b>ULR-TC568822300000100F</b>	<b>Auftrags-Nr.:</b> <i>Order no.:</i>	<b>146701433 010</b>	Seite 1 von 197 Page 1 of 197
<b>Kunden-Referenz-Nr.:</b> <i>Client reference no.:</i>	2141358	<b>Auftragsdatum:</b> <i>Order date:</i>	2022-07-20	
<b>Auftraggeber:</b> <i>Client:</i>	GE Vingmed Ultrasound AS Strandpromenaden 45, N-3183, Horten, Norway			
<b>Prüfgegenstand:</b> <i>Test item:</i>	Vscan Air SL	<b>Serien-Nr.:</b> <b>Serial No.:</b>	VA020000065 VA020000068	
<b>Bezeichnung.:</b> <i>Identification .:</i>	Vscan Air SL			
<b>Auftrags-Inhalt:</b> <i>Order content:</i>	Testing and issue of Test report with Grant Certificate			
<b>Prüfgrundlage:</b> <i>Test specification:</i>	FCC Part 15 Subpart C 15.247,15.205, 15.207 & 15.209 RSS 247 Issue 2,RSS Gen Issue 5			
<b>Wareneingangsdatum:</b> <i>Date of sample receipt:</i>	2022-07-26			
<b>Prüfmuster-Nr</b> <i>Test sample no</i>	A003307764-003 A003307764-004			
<b>Prüfzeitraum:</b> <i>Testing period:</i>	2022-08-09 - 2022-09-20			
<b>Ort der Prüfung:</b> <i>Place of testing:</i>	Wireless laboratory, Bangalore			
<b>Prüflaboratorium:</b> <i>Testing laboratory:</i>	TÜV Rheinland (India) Pvt.Ltd., 27/B, 2nd Cross, Electronic City Phase1 Bangalore -560 100, India  FCC Test site registration number: 496599 ISED Test site registration number: 3466E-1			
<b>Prüfergebnis*:</b> <i>Test result*:</i>	Pass			
<b>geprüft von:</b> <i>tested by:</i>	<b>genehmigt von:</b> <i>authorized by:</i>			
<b>Datum:</b> <i>Date:</i> 2022-09-29			<b>Ausstellatum:</b> <i>Issue date:</i> 2023-04-11	
<b>Stellung / Position:</b>	Yogesh V Engineer		<b>Stellung / Position:</b>	Madhu K N Senior Engineer
<b>Sonstiges / Other:</b>	FCC ID: YOM-VSCANAIRSL IC: 9136A-VSCANAIRSL			
<b>Zustand des Prüfgegenstandes bei Anlieferung:</b> <i>Condition of the test item at delivery:</i>	<b>Prüfmuster vollständig und unbeschädigt</b> <b>Test item complete and undamaged</b>			
* Legende:	1 = sehr gut P(ass) = entspricht o.g. Prüfgrundlage(n)	2 = gut F(ail) = entspricht nicht o.g. Prüfgrundlage(n)	3 = befriedigend N/A = nicht anwendbar	4 = ausreichend N/T = nicht
* Legend:	1 = very good P(ass) = passed a.m. test specification(s)	2 = good F(ail) = failed a.m. test specification(s)	3 = satisfactory N/A = not applicable	4 = sufficient N/T = not
<b>Dieser Prüfbericht bezieht sich nur auf das o.g. Prüfmuster und darf ohne Genehmigung der Prüfstelle nicht auszugsweise vervielfältigt werden. Dieser Bericht berechtigt nicht zur Verwendung eines Prüfzeichens.</b> <i>This test report only relates to the a. m. test sample. Without permission of the test center this test report is not permitted to be duplicated in extracts. This test report does not entitle to carry any test mark.</i>				

V05

**Prüfbericht - Nr.:**  
Test Report No.:

**IN22T1OT 001**  
**ULR-TC568822300000100F**

Seite 2 von 197  
Page 2 of 197

- |          |   |
|----------|---|
| <b>1</b> | <p>Alle eingesetzten Prüfmittel waren zum angegebenen Prüfzeitraum gemäß eines festgelegten Kalibrierungsprogramms unseres Prüfhauses kalibriert. Sie entsprechen den in den Prüfprogrammen hinterlegten Anforderungen. Die Rückverfolgbarkeit der eingesetzten Prüfmittel ist durch die Einhaltung der Regelungen unseres Managementsystems gegeben.<br/>Detaillierte Informationen bezüglich Prüfkonditionen, Prüfequipment und Messunsicherheiten sind im Prüflabor vorhanden und können auf Wunsch bereitgestellt werden.</p> <p><i>The equipment used during the specified testing period was calibrated according to our test laboratory calibration program. The equipment fulfils the requirements included in the relevant standards. The traceability of the test equipment used is ensured by compliance with the regulations of our management system. Detailed information regarding test conditions, equipment and measurement uncertainty is available in the test laboratory and could be provided on request.</i></p>  |
| <b>2</b> | <p>Wie vertraglich vereinbart, wurde dieses Dokument nur digital unterzeichnet. Der TÜV Rheinland hat nicht überprüft, welche rechtlichen oder sonstigen diesbezüglichen Anforderungen für dieses Dokument gelten. Diese Überprüfung liegt in der Verantwortung des Benutzers dieses Dokuments. Auf Verlangen des Kunden kann der TÜV Rheinland die Gültigkeit der digitalen Signatur durch ein gesondertes Dokument bestätigen. Diese Anfrage ist an unseren Vertrieb zu richten. Eine Umweltgebühr für einen solchen zusätzlichen Service wird erhoben.</p> <p><i>As contractually agreed, this document has been signed digitally only. TUV Rheinland has not verified and unable to verify which legal or other pertaining requirements are applicable for this document. Such verification is within the responsibility of the user of this document. Upon request by its client, TUV Rheinland can confirm the validity of the digital signature by a separate document. Such request shall be addressed to our Sales department. An environmental fee for such additional service will be charged.</i></p> |
| <b>3</b> | <p>Prüfklausel mit der Note * wurden an qualifizierte Unterauftragnehmer vergeben und sind unter der jeweiligen Prüfklausel des Berichts beschrieben.<br/>Abweichungen von Prüfspezifikation(en) oder Kundenanforderungen sind in der jeweiligen Prüfklausel im Bericht aufgeführt.</p> <p><i>Test clauses with remark of * are subcontracted to qualified subcontractors and described under the respective test clause in the report.<br/>Deviations of testing specification(s) or customer requirements are listed in specific test clause in the report.</i></p>   |
| <b>4</b> | <p>Die Entscheidungsregel für Konformitätserklärungen in diesem Prüfbericht basiert auf der "Null-Grenzwert-Regel" und der "Einfachen Akzeptanz" gemäß ILAC G8:2019 und IEC Guide 115:2021, es sei denn, in der auf Seite 1 dieses Berichts genannten angewandten Norm ist etwas anderes festgelegt oder vom Kunden gewünscht. Dies bedeutet, dass die Messunsicherheit nicht berücksichtigt wird und daher auch nicht im Prüfbericht angegeben wird.</p> <p><i>The decision rule for statements of conformity in this test report is based on the "Zero Guard Band Rule" and "Simple Acceptance" in accordance with ILAC G8:2019 and IEC Guide 115:2021, unless otherwise specified in the applied standard mentioned on Page 1 of this report or requested by the customer. This means that measurement uncertainty is not taken in account and hence also not declared in the test report.</i></p>   |

**Prüfbericht - Nr.:**  
Test Report No.:

**IN22T1OT 001**  
**ULR-TC568822300000100F**

Seite 3 von 197  
Page 3 of 197

## TEST SUMMARY

Test Item	Applicable Standard		Result
	FCC	ISED	
Maximum conducted output power	FCC 15.247 (b)(3)	RSS 247 Issue 2, Section 5.4 (d)	Pass
Maximum Power Spectral Density	FCC 15.247(e)	RSS 247 Issue 2, Section 5.2 (b)	Pass
DTS Bandwidth	FCC 15.247(a)(2)	RSS 247 Issue 2, Section 5.2 (a)	Pass
Emissions in non-restricted frequency bands	FCC 15.247(d)	RSS 247 Issue 2, Section 5.5	Pass
Spurious Radiated Emissions and Restricted Bands of Operation	FCC 15.209 / FCC 15.205	RSS-Gen Issue 5, Section 8.9 /8.10	Pass
Conducted Spurious Emission on AC Power lines	FCC 15.207	RSS-Gen Issue 5,Section 8.8	Pass

Product Category: Electronics Testing  
Test Discipline: EMC Test Facility

**Prüfbericht - Nr.:**  
*Test Report No.:*

**IN22T1OT 001**  
**ULR-TC568822300000100F**

Seite 4 von 197  
Page 4 of 197

## REVISION HISTORY OF THIS REPORT

Report Number	Version	Description	Issue date
IN22T1OT 001 ULR-TC568822300000100F	01	Initial issue of report	2023-03-29
IN22T1OT 001 ULR-TC568822300000100F	02	Reviewer comments updated	2023-04-11

**Prüfbericht - Nr.:**  
*Test Report No.:*

**IN22T1OT 001**  
**ULR-TC568822300000100F**

Seite 5 von 197  
Page 5 of 197

## Table of Contents

1	GENERAL REMARKS .....	6
1.1	Attachments .....	6
2	TEST SITES .....	7
2.1	Testing Facilities.....	7
2.2	List of Test and Measurement Instruments.....	7
3	GENERAL PRODUCT INFORMATION.....	9
3.1	Product Function and Intended Use.....	9
3.2	Ratings and System Details of Equipment under Test .....	9
3.3	Measurement Uncertainty: .....	10
4	TEST SET-UP AND OPERATION MODE .....	11
4.1	Principle of Configuration Selection .....	11
4.2	Operation and Software of the EUT .....	11
4.3	Special Accessories and Auxiliary Equipment .....	12
4.4	Simultaneous Transmission .....	12
4.5	Countermeasures to achieve EMC Compliance .....	12
4.6	List of frequencies .....	12
4.7	Report references.....	13
5	OPERATIONAL DESCRIPTION.....	14
6	TEST METHODOLOGY .....	15
6.1	Conducted Spurious Emission Test on AC Power Line.....	15
6.2	Radiated Emission Test .....	16
7	TEST RESULTS FOR Wi-Fi.....	18
7.1	Maximum Average Conducted Output Power.....	18
7.2	Maximum Power Spectral Density .....	31
7.3	DTS Bandwidth & 99% Bandwidth.....	44
7.4	Emissions in non-restricted frequency bands and Conducted Spurious Emission.....	67
7.5	Spurious Radiated Emissions & Restricted Bands of Operation .....	115
8	TEST RESULTS FOR BLUETOOTH LOW ENERGY .....	152
8.1	Maximum Peak Conducted Output Power.....	152
8.2	Maximum Power Spectral Density .....	155
8.3	DTS Bandwidth & 99% Bandwidth.....	158
8.4	Emissions in non-restricted frequency bands and Conducted Spurious Emission.....	161
8.5	Spurious Radiated Emissions & Restricted Bands of Operation .....	167
8.6	Conducted Spurious Emission Test on AC Power Line.....	188
9	LIST OF TABLES.....	197

**Prüfbericht - Nr.:**  
*Test Report No.:*

**IN22T1OT 001**  
**ULR-TC568822300000100F**

Seite 6 von 197  
Page 6 of 197

# 1 GENERAL REMARKS

## 1.1 Attachments

All attachments are part of this test report and are issued in separate document

- 1: TEST SETUP PHOTOS
- 2: EUT EXTERNAL PHOTOS
- 3: EUT INTERNAL PHOTOS
- 4: FCC LABEL AND LABEL LOCATION
- 5: BLOCK DIAGRAM
- 6: SPECIFICATION OF EUT
- 7: SCHEMATIC DIAGRAM
- 8: BILL OF MATERIAL
- 9: USER MANUAL
- 10: MAXIMUM PERMISSIBLE EXPOSURE INFORMATION

**Prüfbericht - Nr.:**  
Test Report No.:

**IN22T1OT 001**  
**ULR-TC568822300000100F**

Seite 7 von 197  
Page 7 of 197

## 2 TEST SITES

### 2.1 Testing Facilities

1. TÜV Rheinland (India) Pvt.Ltd.,  
27/B, 2nd Cross,  
ElectronicCityPhase1  
Bangalore – 560 100,  
India

2. TUV Rheinland (India) Pvt.Ltd.,  
108 , Beside ISBR Business School,  
Electronic city Phase I  
Bangalore - 560 100.  
India

Radiated Measurement site type :  
Fully anechoic chamber (used for above 1 GHz  
measurements)

Radiated Measurement site type :  
Semi anechoic chamber (used for below 1 GHz  
measurements)

### 2.2 List of Test and Measurement Instruments

Table 1: List of test and measurement instruments

Equipment	Manufacturer	Model Name	Serial Number	Firmware Versions	Calibration Due Date	Periodicity	Test Facility
EMI Receiver	Rohde & Schwarz	ESW 44	101732	4.73 SP5	04.08.2023	Yearly	Radiated Spurious Emission
EMI Receiver	Rohde & Schwarz	ESW 44	101733	1.72SP1	12.02.2023	Yearly	
Active loop antenna	Frankonia	LAX-10	LAX-10-800	-	31.01.2023	Yearly	
Balloon and Biconical Antenna	Schwarzbeck	VHBB-9124 / BBA-9106	1028	-	03.02.2023	Yearly	
Log - Periodical Antenna	Schwarzbeck	VUSLP-9111B	9111B-111	-	04.02.2023	Yearly	
Horn Antenna	Frankonia	HAX-18	HAX18-802	-	20.05.2023	Yearly	
Horn Antenna	ETS	3117	00133355	-	06.02.2023	Yearly	
Semi Anechoic Chamber	Frankonia	-	-	-	-	-	
Fully Anechoic Chamber	Albatross	-	-	-	-	-	
Spectrum Analyser	Agilent Technologies	E4407B	US41192772	A.14.06	15.12.2022	Yearly	Antenna-Port Conducted test
EMI Receiver	Rohde & Schwarz	ESR7	101133	3.48 SP3	22.07.2023	Yearly	Conducted AC Power line Test
Pulse Limiter	Rohde & Schwarz	ESH3-Z2	100811	-	12.07.2023	Yearly	
LISN	Rohde & Schwarz	ENV216	100022	-	07.10.2022	Yearly	

**Prüfbericht - Nr.:**  
*Test Report No.:*

**IN22T1OT 001**  
**ULR-TC568822300000100F**

Seite 8 von 197  
Page 8 of 197

**Table 2: Instrument application Software versions**

<b>SL. No.</b>	<b>Test Type</b>	<b>Application software</b>	<b>Version</b>
1	Radiated spurious emission measurement in 10mtr-SAC	BAT EMC	3.20.0.17
2	Radiated spurious emission measurement in 3mtr-FAC	EMC 32	10.60.20



**Prüfbericht - Nr.:**  
Test Report No.:

**IN22T1OT 001**  
**ULR-TC568822300000100F**

Seite 9 von 197  
Page 9 of 197

### 3 GENERAL PRODUCT INFORMATION

#### 3.1 Product Function and Intended Use

Vscan Air SL consists of a dual headed probe which integrates both, Sector and linear array transducers, and an app which can be installed on Android or iOS mobile devices.

Vscan Air SL is a battery-operated software-based general-purpose ultrasound imaging system for use by qualified and trained healthcare professionals or practitioners that are legally authorized or licensed by law in the country, state or other local municipality in which he or she practices. The users may or may not be working under supervision or authority of a physician. Users may also include Medical Students working under the supervision or authority of a physician during their education / training. The device is enabling visualization and measurement of anatomical structures and fluid including blood flow.

#### 3.2 Ratings and System Details of Equipment under Test

Table 3: Ratings and System Details as declared by Client\*

<b>Radio Protocol</b>	Wi-Fi	BLE
<b>Operating Frequency Range</b>	2412MHz to 2462MHz	2402MHz to 2480MHz
<b>No. of Channels</b>	11 (Refer Table 5)	40 (Refer Table 6)
<b>Channel Spacing</b>	5MHz	2MHz
<b>Maximum measured power (e.i.r.p)</b>	17.08dBm at 802.11g 6Mbps	8.16dBm at 1Mbps
<b>Modulation</b>	802.11b: DSSS (1Mbps,11Mbps) 802.11g: OFDM (6Mbps, 54Mbps) 802.11n: OFDM (20MHz: MCS0, MCS7,40MHz: MCS0, MCS7)	GFSK
<b>Number of antennas</b>	1	
<b>Antenna Gain</b>	2.53dBi	
<b>Antenna Type</b>	PCB Antenna	
<b>Supply Voltage to Product</b>	3.6V DC Li-Ion battery	
<b>Environmental conditions</b>	Storage	-20degC to +70degC Relative Humidity <95%
	Operating	0 degC to +35degC Relative Humidity <95%
<b>EUT Dimension</b>	141 x 67 x 33 mm	

\***Disclaimer:** The information/data is supplied by the client and the same is considered to arrive at the final value. Any changes made apart from the specified specification, can directly impact on the tests results. Refer the products user manual for more details.

**Prüfbericht - Nr.:**  
*Test Report No.:*

**IN22T1OT 001**  
**ULR-TC568822300000100F**

Seite 10 von 197  
Page 10 of 197

**Note:** Product **Vscan Air SL** has multiple protocols. All the supported wireless protocols and their respective test results are issued in separate test reports, refer clause 4.7 Report references

### 3.3 Measurement Uncertainty:

Reported uncertainties represent expanded uncertainties expressed at approximately the 95% confidence level using a coverage factor of  $k = 2$

**Table 4: Measurement Uncertainty**

<b>Parameter</b>	<b>Uncertainty</b>
Occupied Channel Bandwidth	±5 %
RF output power, conducted	±1.5 dB
Power Spectral Density, conducted	±3 dB
Unwanted Emissions, conducted	±3 dB
All emissions, radiated	±6 dB
Temperature	±3 °C
Supply Voltages	±3 %
Time	±5 %

**Prüfbericht - Nr.:**  
Test Report No.:

**IN22T1OT 001**  
**ULR-TC568822300000100F**

Seite 11 von 197  
Page 11 of 197

## 4 TEST SET-UP AND OPERATION MODE

### 4.1 Principle of Configuration Selection

Transmission was enabled with highest possible duty cycle on low, mid and high channels

This product operates in 2 mode (Linear and Sector) as described in operational description under clause 5 of this test report, these mode of operations are related to analog circuitry and do not affect the RF characteristics.

4.1.1 EUT Mode of operation Mode	Description
Sector	Deep scanning uses Sector transducer, with Wi-Fi in Tx and Rx mode and BLE is used for initial paring
Linear	Shallow scanning uses Linear transducer with Wi-Fi in Tx and Rx mode and BLE is used for initial paring
Charging mode	Scanning is paused and probe stays connected to display device via Wi-Fi.

#### 4.1.2 Following configurations are used for testing

Test cases	Mode of operation
All conducted RF test cases	Special configuration tool is used to enable the Wi-Fi and BLE continuous transmission as needed
All radiated test cases < 1 GHz	Linear mode, Sector mode and charging mode as defined in 4.1.1
All radiated test cases > 1 GHz	Special configuration tool is used to enable the Wi-Fi and BLE continuous transmission as needed

### 4.2 Operation and Software of the EUT

Hardware Version of Vscan Air SL: GP000170 Rev01  
 Hardware Version of Digital board: GP200400 Rev15  
 Hardware Version of HV board: GP200401 Rev11  
 Hardware Version of Analog board: GP200402 Rev10  
 Probe FW Version :1.1.23.355

Vscan Air Application software:

- Vscan Air R2 for iOS
- Vscan Air R2 for Android

**Note:** Both Probe FW and App SW version has R2 features included.

APP Software Version: 1.1.26.18955

EUT can be configured for different test conditions using calibrator tool commands

Calibrator tool version = 0.80

Medical Device name of the probe: Vscan Air SL

Medical Device name of the application SW (app): Vscan Air

GlobTek Power adapter - GTM46101-1005-USB

Vscan Air Charger - GP200304

XP Power - VEU10US050

Anker wireless charger - A2503

**Prüfbericht - Nr.:**  
Test Report No.:

**IN22T1OT 001**  
**ULR-TC568822300000100F**

Seite 12 von 197  
Page 12 of 197

### 4.3 Special Accessories and Auxiliary Equipment

- None

### 4.4 Simultaneous Transmission

This product doesn't supports Simultaneous operation

### 4.5 Countermeasures to achieve EMC Compliance

- None

### 4.6 List of frequencies

Frequency Band (MHz)	Channel No.	Channel Frequency (MHz)
2412 – 2462	1	2412
	2	2417
	3	2422
	4	2427
	5	2432
	6	2437
	7	2442
	8	2447
	9	2452
	10	2457
	11	2462

Table 5: List of Wi-Fi center Frequencies

#### Channel used for Wi-Fi 2.4GHz testing

**Protocol: WLAN 802.11b**

Channel Low : 2412 MHz  
Channel Mid : 2437 MHz  
Channel High : 2462 MHz

**Protocol: WLAN 802.11g**

Channel Low : 2412 MHz  
Channel Mid : 2437 MHz  
Channel High : 2462 MHz

**Protocol: WLAN 802.11n HT20**

Channel Low : 2412 MHz  
Channel Mid : 2437 MHz  
Channel High : 2462 MHz

**Protocol: WLAN 802.11n HT40**

Channel Low : 2422 MHz  
Channel High : 2452 MHz

**Prüfbericht - Nr.:**  
Test Report No.:

**IN22T1OT 001**  
**ULR-TC568822300000100F**

Seite 13 von 197  
Page 13 of 197

Frequency Band (GHz)	Channel No.	Frequency (MHz)
<b>BLE</b> <b>(2.4-2.4835)</b>	<b>0</b>	<b>2402</b>
	1	2404
	2	2406
	3	2408
	:	:
	:	:
	18	2438
	<b>19</b>	<b>2440</b>
	20	2442
	:	:
	:	:
	36	2474
	37	2476
	38	2478
	<b>39</b>	<b>2480</b>

Table 6: List of BLE Center frequencies

#### Channel used for BLE testing

Channel low : 2402MHz

Channel mid : 2440MHz

Channel High : 2480MHz

#### Note:

TUV Sample Identification number : A003307764 - 003 – Conducted test Sample  
A003307764 - 004 – Radiated test Sample

## 4.7 Report references

**Note:** Product **VscanAir SL** has multiple protocols. All the supported wireless protocols and their respective test results are issued in separate test reports, following table lists the report numbers.

Radio Protocol	Report Number
<b>RF test report for Wi-Fi (2.4GHz) and BLE – (This report)</b>	ULR-TC568822300000100F
RF test report for Wi-Fi (5GHz UNII-1 & UNII-3)	ULR-TC568822300000101F
SAR test report for Wi-Fi (2.4GHz and 5GHz)	ULR-TC568822300000105F

**Prüfbericht - Nr.:**  
Test Report No.:

**IN22T1OT 001**  
**ULR-TC568822300000100F**

Seite 14 von 197  
Page 14 of 197

## 5 OPERATIONAL DESCRIPTION

Vscan Air SL is a handheld, pocket sized, battery powered general purpose diagnostic ultrasound system. The system consists of a probe with two heads. One for deep scanning (Sector) and another one for shallow scanning (Linear). The probe can be paired with a mobile device through WiFi, to see the ultrasound image. Mobile device needs an app (available in iOS & android) to enable pairing and ultrasound imaging. The internal battery operation is designed for providing approximately one hour of active scanning capacity with a fully charged battery. The probe supports Qi wireless charging to charge the battery. Probe will automatically turn off during charging.

Mode	Description
Sector / Curved	Deep scanning uses Sector transducer, with Wi-Fi in Tx and Rx mode and BLE is used for initial paring
Linear	Shallow scanning uses Linear transducer with Wi-Fi in Tx and Rx mode and BLE is used for initial paring
Charging mode	Probe will automatically turn off during charging, i.e. Wi-Fi and BLE are turned off



## 6.2 Radiated Emission Test

The radiated emission measurement was performed according to the procedures in ANSI C63.10-2013. The equipment under test (EUT) was placed at the middle of the 80 cm high turntable for below 1 GHz & 1.5 m height for above 1 GHz measurement, and the EUT is 3 meters far from the measuring antenna. The turntable was rotated 360° for obtaining the maximum emission. The height of the measuring antennas was scanned between 1 m and 4 m, and the antenna rotated to repeat the measurements for both the horizontal and vertical antenna polarizations. Repeat the measurement steps until the maximum emissions were obtained. The measurement above 1000 MHz was performed by horn antenna, The measurement below 30 MHz was performed by loop antenna, Measurement from 30 MHz to 200 MHz was performed by Baloon and Biconical Antenna, and measurement from 200 MHz to 1 GHz was performed by Log-Periodic Antenna.

The EUT was rotated around the X-, Y-, and Z-Axis and the results from worst case axis are recorded

### 6.2.1 Test Setup Configuration

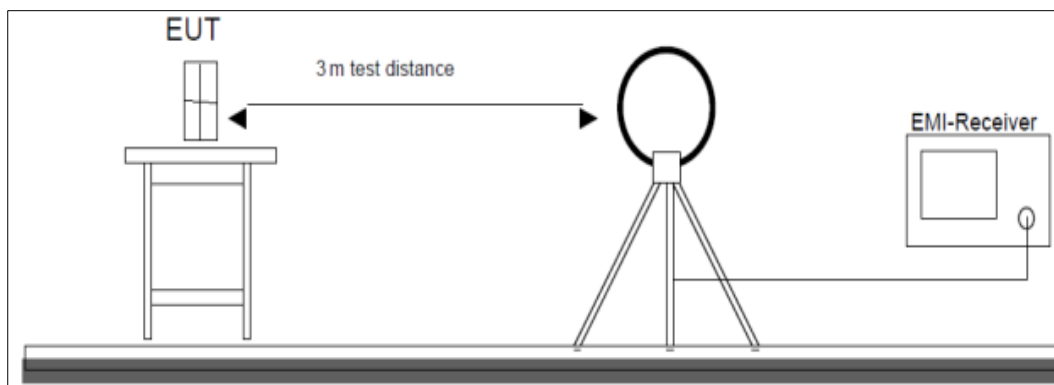

Figure 1: Frequency Range 9 kHz- 30 MHz

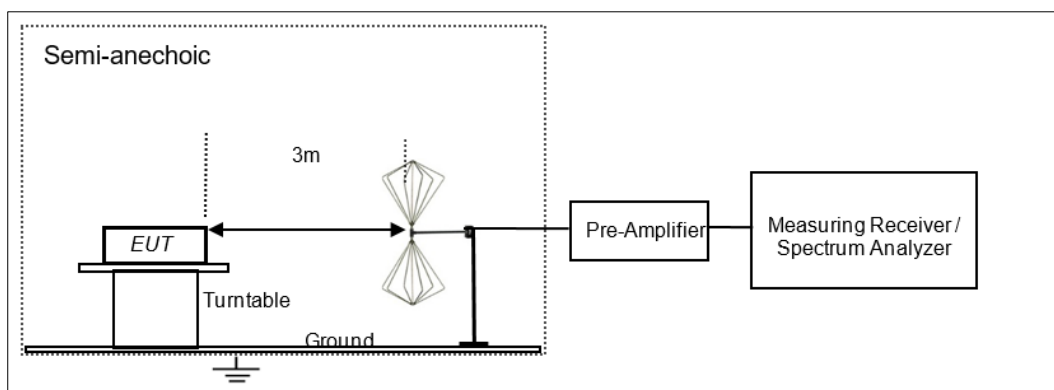
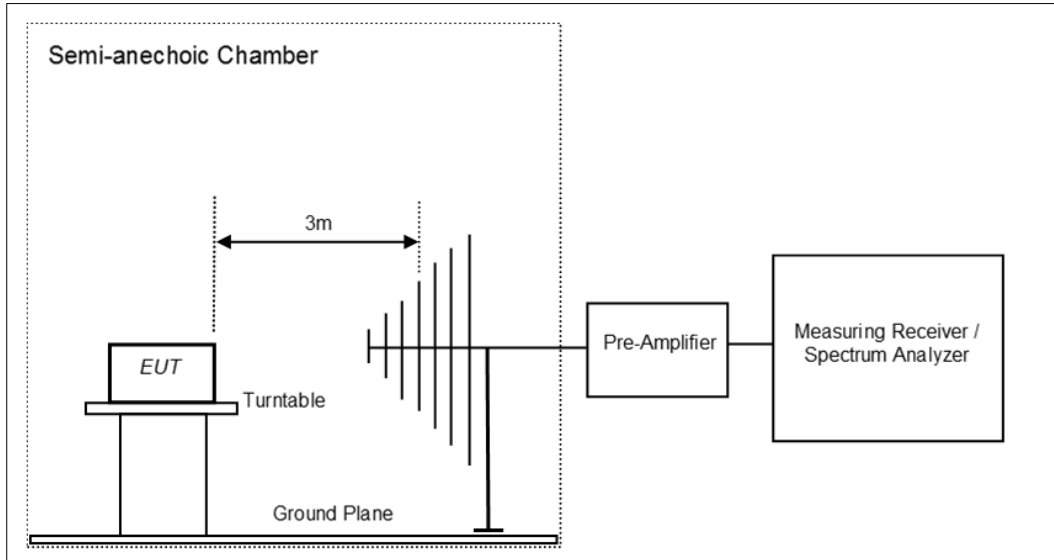
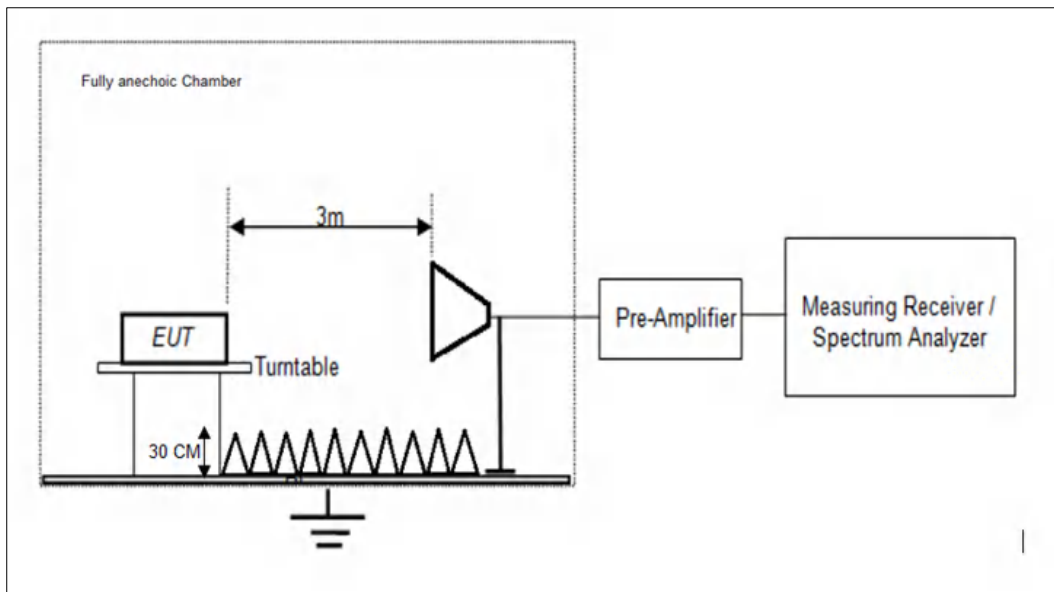

Figure 2: Frequency Range 30 MHz – 200 MHz





**Figure 3: Frequency Range 200 MHz - 1GHz**



**Figure 4: Frequency Range above 1 GHz**

**Prüfbericht - Nr.:**  
Test Report No.:

**IN22T1OT 001**  
**ULR-TC568822300000100F**

Seite 18 von 197  
Page 18 of 197

## 7 TEST RESULTS FOR Wi-Fi

### 7.1 Maximum Average Conducted Output Power

**Result**

**Pass**

Test Specification	FCC part 15 Subpart C 15.247 (b)(3) / RSS 247 Issue 2, Section 5.4 (d)
Test Method	Subclause 11.9.2.2.6 of ANSI C63.10
Measurement Bandwidth	300kHz
Detector	Average sample detector mode
Port of testing	Antenna port
Requirement	Power $\leq 1$ W (30 dBm) & e.i.r.p $\leq 4$ W (36 dBm)

#### Test Method

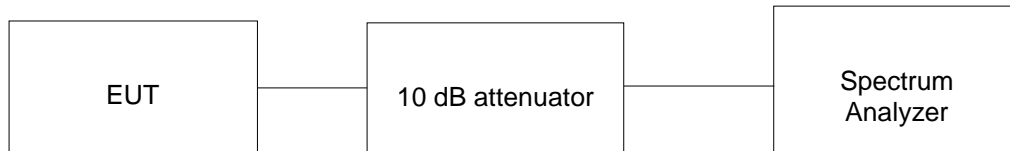

#### Test Condition

##### Normal Test Condition:

Temperature (Norm) = + 22.3 °C

Voltage = 3.6V Li-Ion battery

Relative humidity: 62%

#### KDB Guidelines applied:

Measurements were made as per section 8.3.2.2 in KDB 558074 D01 15.247 Measurement Guidance v05r02.

**Prüfbericht - Nr.:**  
Test Report No.:

**IN22T1OT 001**  
**ULR-TC568822300000100F**

Seite 19 von 197  
Page 19 of 197

**Test results:**

**Note:**

1. All the losses are included during measurement and final values are mentioned in the test report.
2. Total Average Output power (dBm) = Measured Average power (dBm) + Attenuator factor (10dB) + Cable loss (0.6dB)
3. This product do not support additional beamforming gain / directional gain, it uses signal antenna and hence directional gain of the single antenna is 2.53 dBi

**Modulation: 802.11b**

Data rate	Channel Frequency (MHz)	Measured Average Power (dBm)	Final Average power (e.i.r.p) (dBm)	Power Limit (dBm)	e.i.r.p Limit (dBm)
1Mbps	2412	14.52	17.05	30.00	36.00
	2437	14.18	16.71	30.00	36.00
	2462	13.95	16.48	30.00	36.00
11Mbps	2412	14.20	16.73	30.00	36.00
	2437	14.20	16.73	30.00	36.00
	2462	13.77	16.30	30.00	36.00

**Data Rate: 1Mbps**

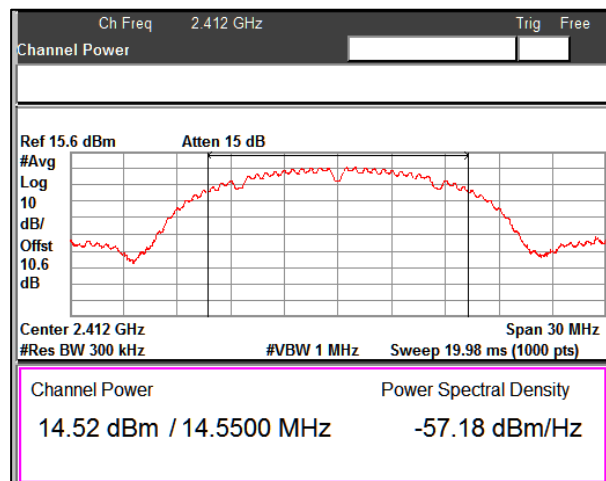

Channel Frequency 2412MHz

**Prüfbericht - Nr.:**  
Test Report No.:

**IN22T1OT 001**  
**ULR-TC568822300000100F**

Seite 20 von 197  
Page 20 of 197

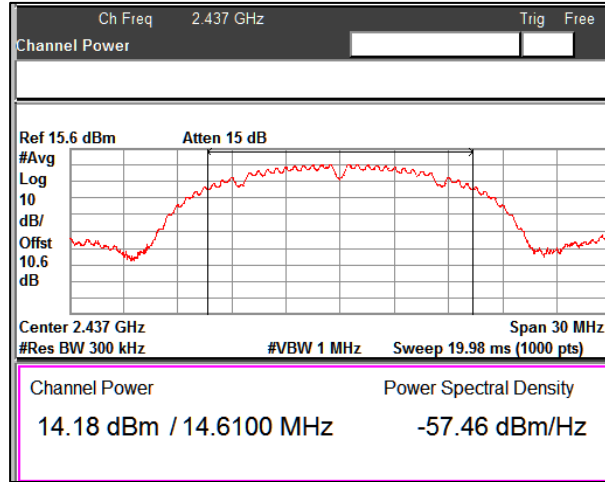

Channel Frequency 2437MHz

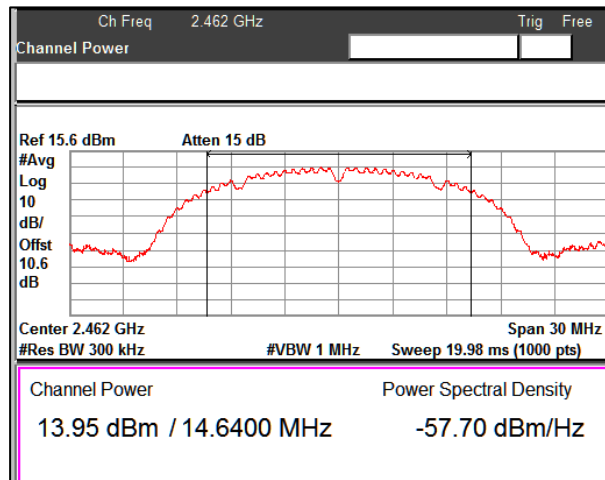

Channel Frequency 2462MHz

Data Rate: 11Mbps

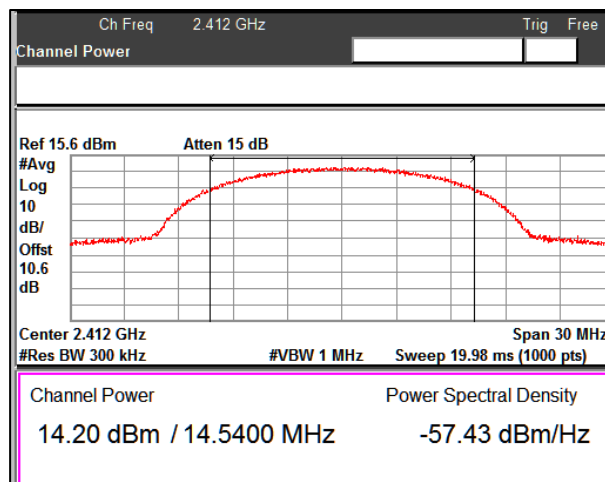

Channel Frequency 2412MHz

**Prüfbericht - Nr.:**  
Test Report No.:

**IN22T1OT 001**  
**ULR-TC568822300000100F**

Seite 21 von 197  
Page 21 of 197

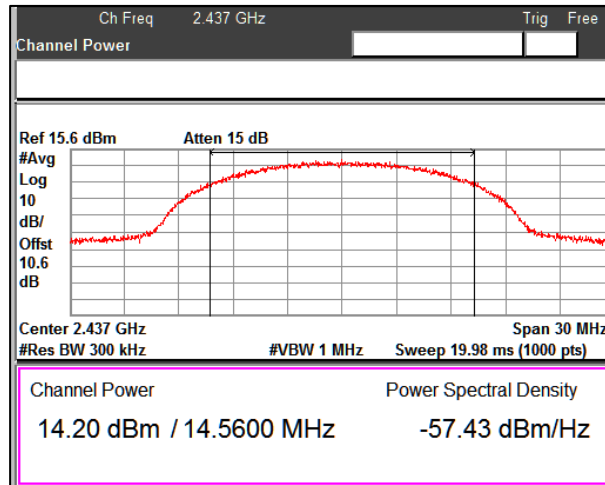

Channel Frequency 2437MHz

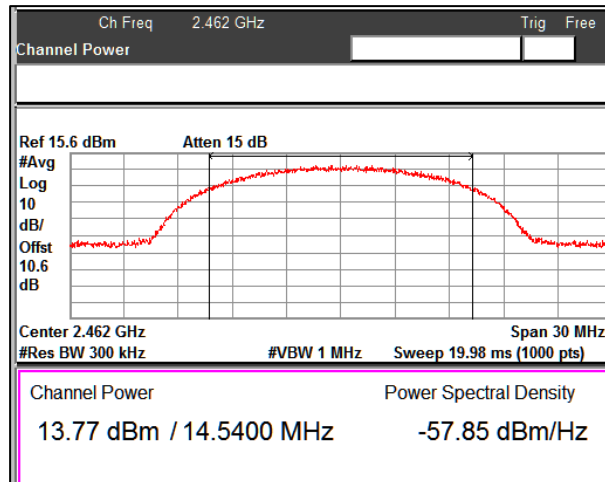

Channel Frequency 2462MHz

**Modulation: 802.11g**

Data rate	Channel Frequency (MHz)	Measured Average Power (dBm)	Final Average power (e.i.r.p) (dBm)	Power Limit (dBm)	e.i.r.p Limit (dBm)
6Mbps	2412	10.12	12.65	30.00	36.00
	2437	14.55	17.08	30.00	36.00
	2462	9.52	12.05	30.00	36.00
24Mbps	2412	9.42	11.95	30.00	36.00
	2437	12.95	15.48	30.00	36.00
	2462	8.55	11.08	30.00	36.00
54Mbps	2412	8.62	11.15	30.00	36.00
	2437	10.17	12.70	30.00	36.00
	2462	8.40	10.93	30.00	36.00

**Prüfbericht - Nr.:**  
Test Report No.:

**IN22T1OT 001**  
**ULR-TC568822300000100F**

Seite 22 von 197  
Page 22 of 197

Data rate: 6Mbps

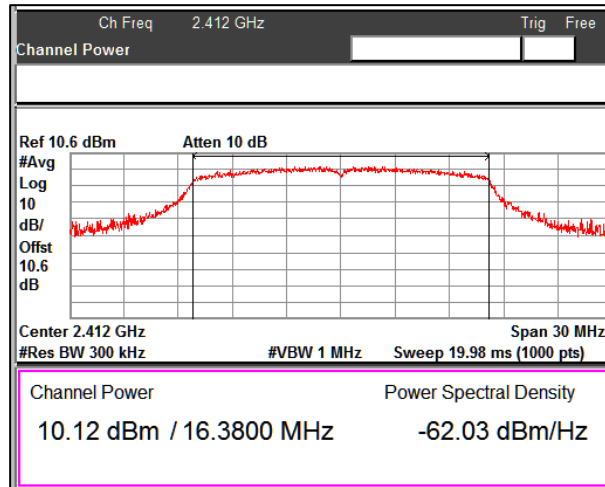

Channel Frequency: 2412MHz

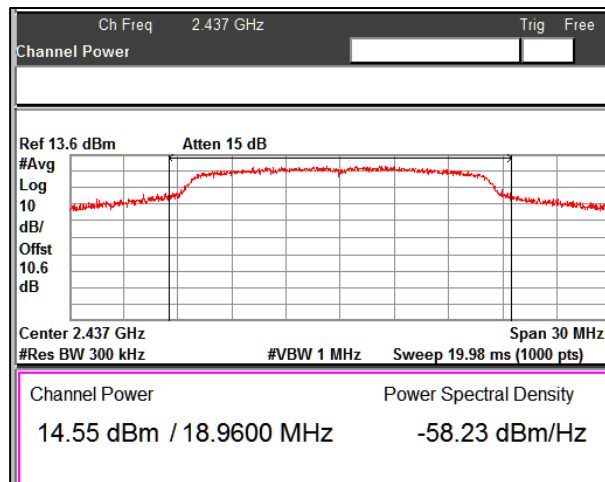

Channel Frequency: 2437MHz

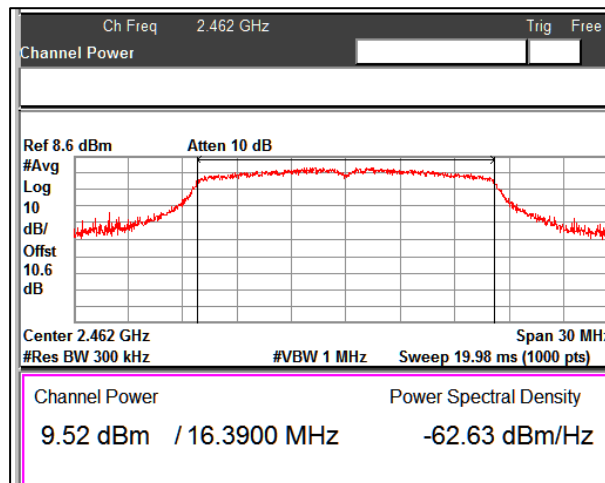

Channel Frequency: 2462MHz

**Prüfbericht - Nr.:**  
Test Report No.:

**IN22T1OT 001**  
**ULR-TC568822300000100F**

Seite 23 von 197  
Page 23 of 197

Data rate: 24Mbps

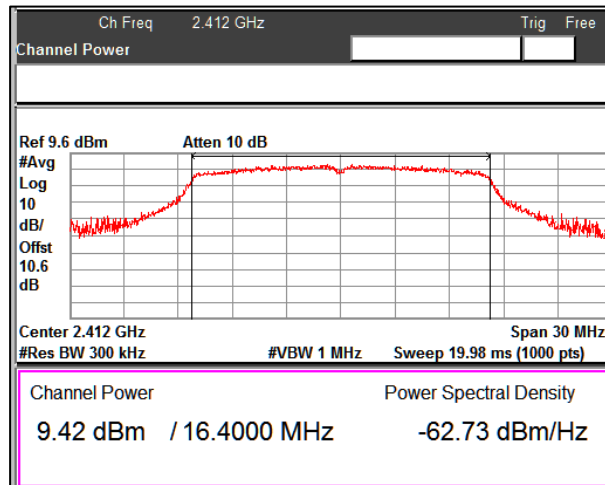

Channel Frequency: 2412MHz

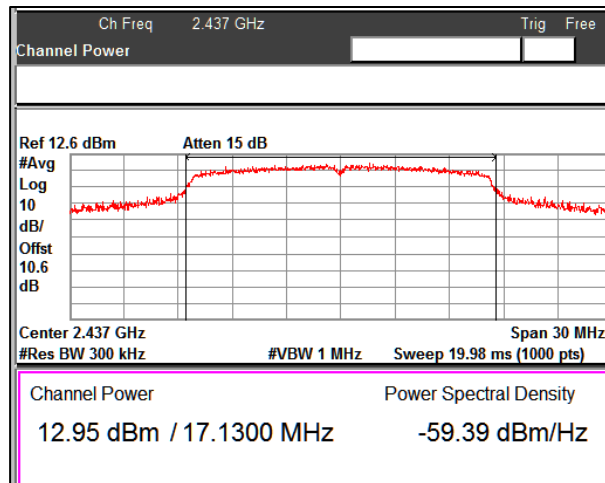

Channel Frequency: 2437MHz

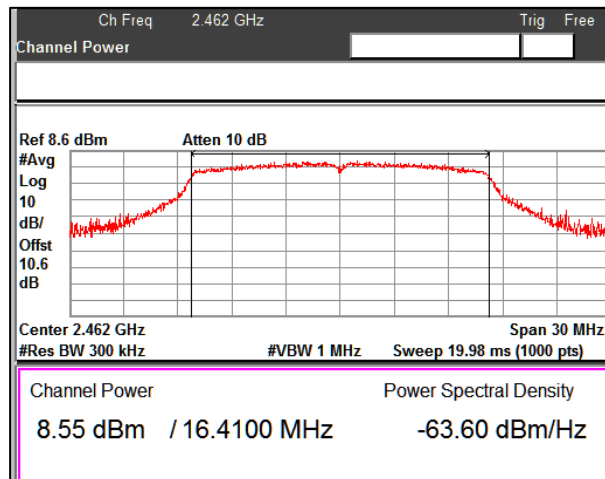

Channel Frequency: 2462MHz

**Prüfbericht - Nr.:**  
Test Report No.:

**IN22T1OT 001**  
**ULR-TC568822300000100F**

Seite 24 von 197  
Page 24 of 197

Data rate: 54Mbps

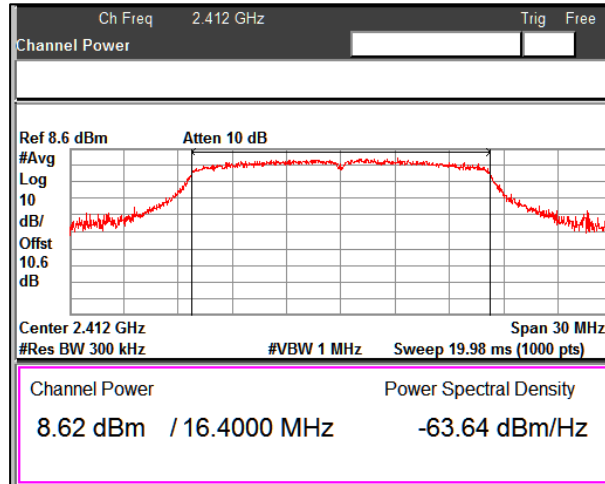

Channel Frequency: 2412MHz

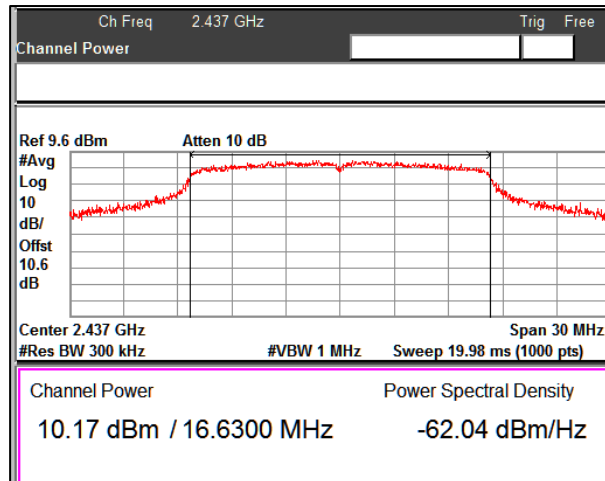

Channel Frequency: 2437MHz

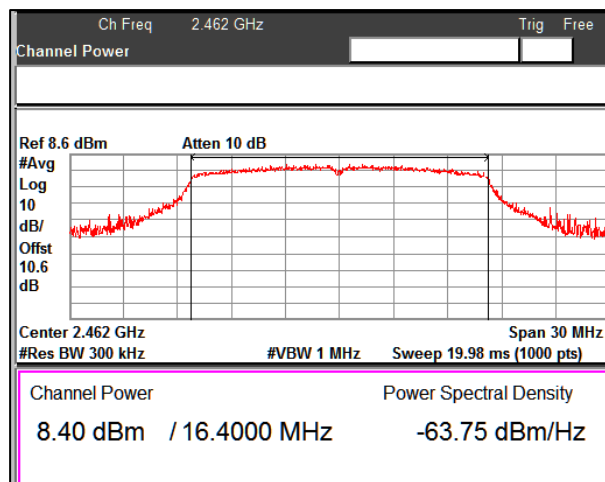

Channel Frequency: 2462MHz



**Prüfbericht - Nr.:**  
Test Report No.:

**IN22T1OT 001**  
**ULR-TC568822300000100F**

Seite 25 von 197  
Page 25 of 197

**Modulation: 802.11n HT20**

Data rate	Channel Frequency (MHz)	Measured Average Power (dBm)	Final Average power (e.i.r.p) (dBm)	Power Limit (dBm)	e.i.r.p Limit (dBm)
MCS0	2412	10.26	12.79	30.00	36.00
	2437	13.78	16.31	30.00	36.00
	2462	9.56	12.09	30.00	36.00
MCS4	2412	9.54	12.07	30.00	36.00
	2437	11.97	14.50	30.00	36.00
	2462	8.87	11.40	30.00	36.00
MCS7	2412	8.54	11.07	30.00	36.00
	2437	9.16	11.69	30.00	36.00
	2462	8.03	10.56	30.00	36.00

**Data rate: MCS0**

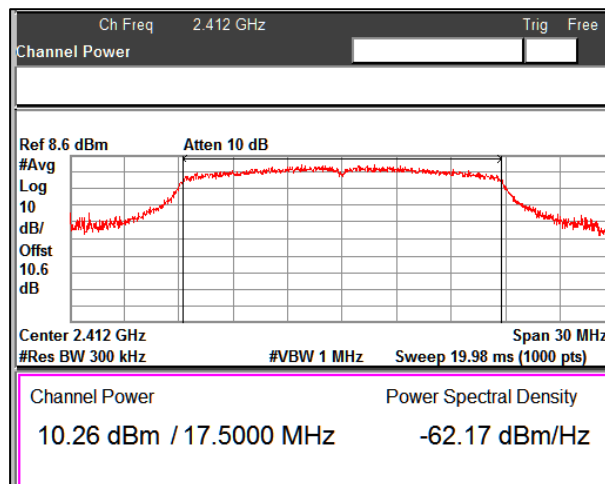

Channel Frequency: 2412MHz

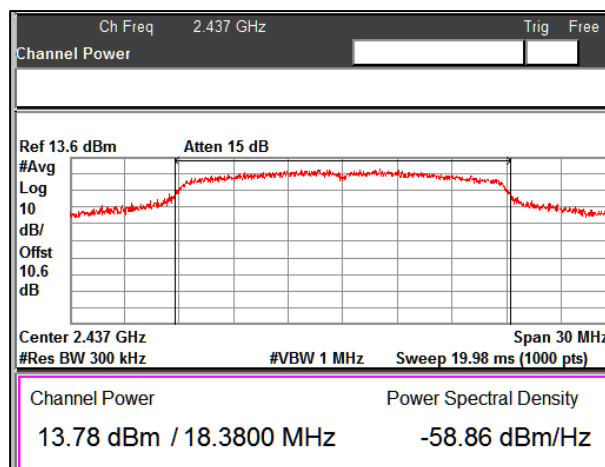

Channel Frequency: 2437MHz

**Prüfbericht - Nr.:**  
Test Report No.:

**IN22T1OT 001**  
**ULR-TC568822300000100F**

Seite 26 von 197  
Page 26 of 197

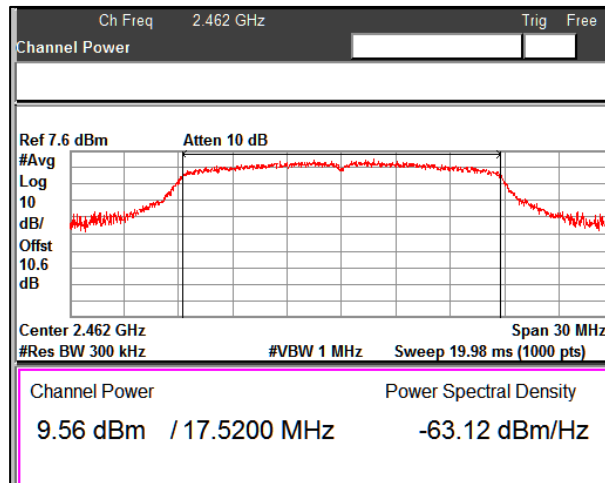

Channel Frequency: 2462MHz

Data rate: MCS4

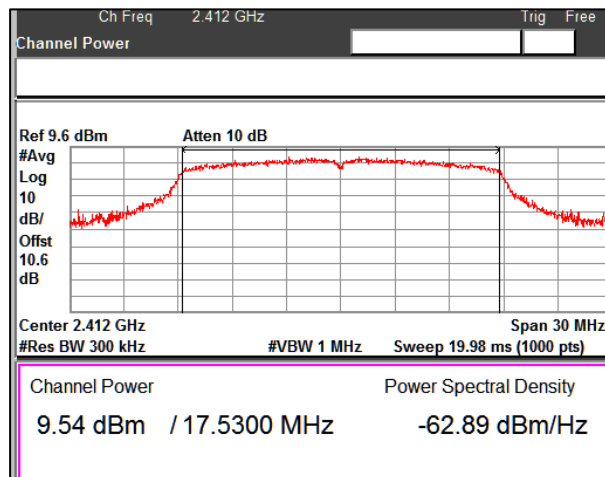

Channel Frequency: 2412MHz

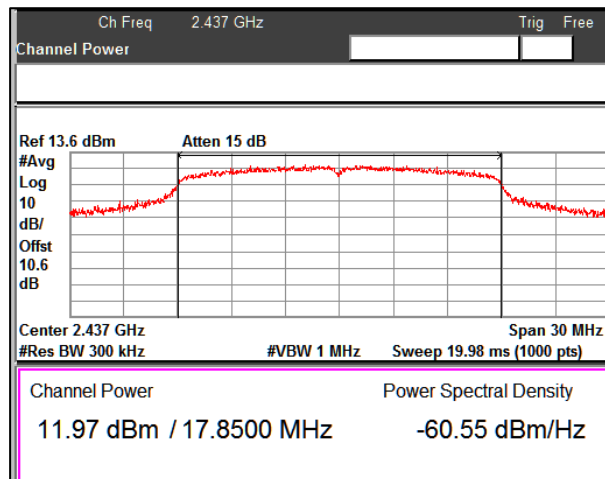

Channel Frequency: 2437MHz

**Prüfbericht - Nr.:**  
Test Report No.:

**IN22T1OT 001**  
**ULR-TC568822300000100F**

Seite 27 von 197  
Page 27 of 197

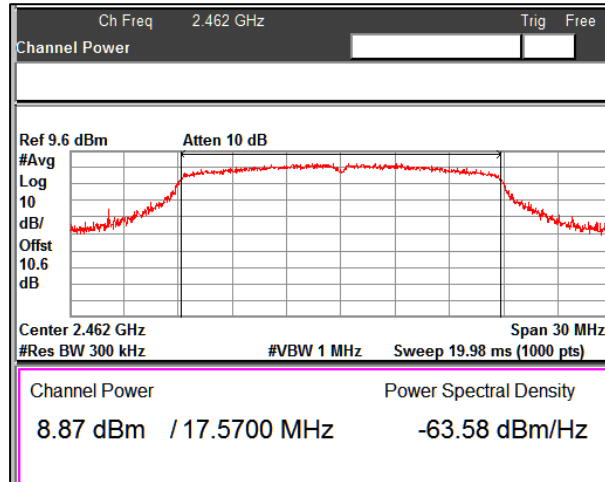

Channel Frequency: 2462MHz

Data rate: MCS7

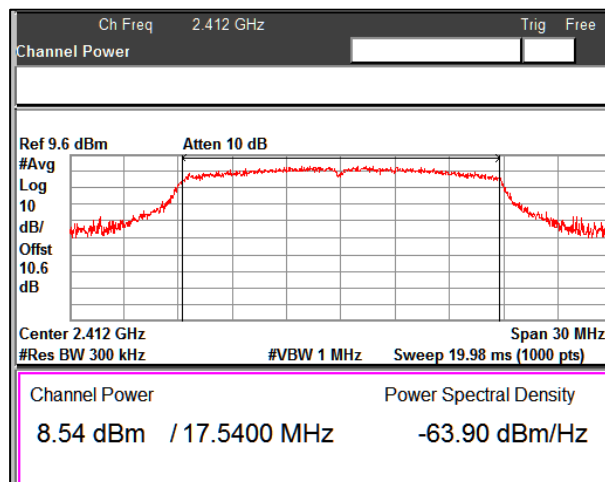

Channel Frequency: 2412MHz

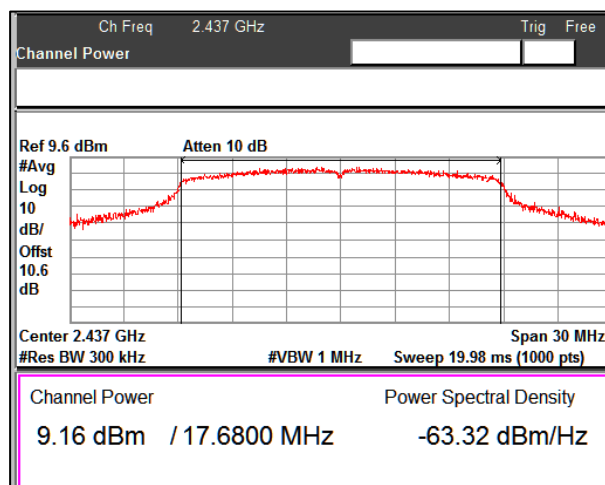

Channel Frequency: 2437MHz

**Prüfbericht - Nr.:**  
Test Report No.:

**IN22T1OT 001**  
**ULR-TC568822300000100F**

Seite 28 von 197  
Page 28 of 197

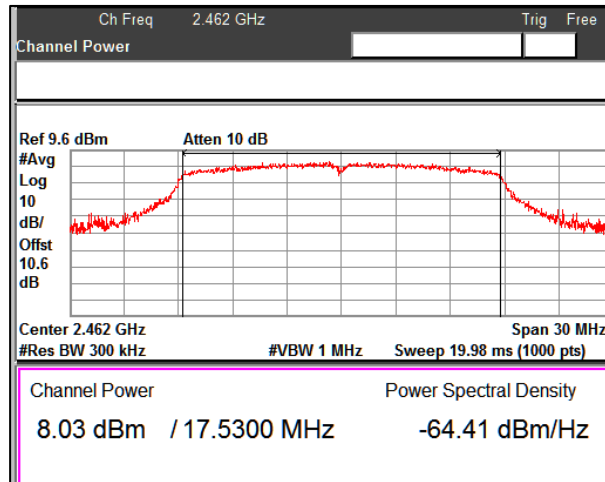

Channel Frequency: 2462MHz

**Modulation: 802.11n HT40**

Data rate	Channel Frequency (MHz)	Measured Average Power (dBm)	Final Average power (e.i.r.p) (dBm)	Power Limit (dBm)	e.i.r.p Limit (dBm)
MCS0	2422	6.93	9.46	30.00	36.00
	2452	6.68	9.21	30.00	36.00
MCS4	2422	5.74	8.27	30.00	36.00
	2452	5.35	7.88	30.00	36.00
MCS7	2422	4.74	7.27	30.00	36.00
	2452	4.42	6.95	30.00	36.00

**Data rate: MCS0**

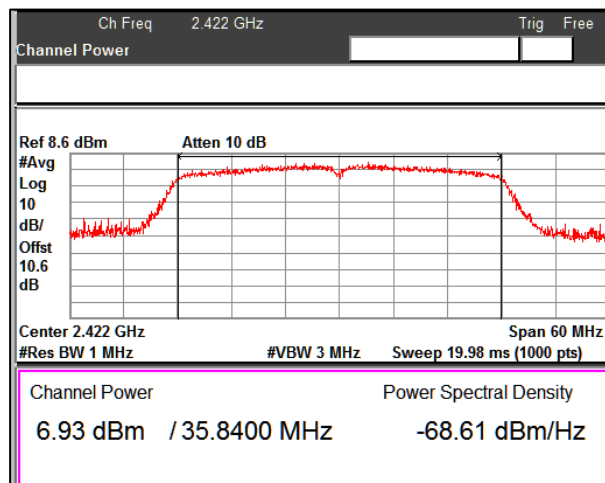

Channel Frequency: 2422MHz

**Prüfbericht - Nr.:**  
Test Report No.:

**IN22T1OT 001**  
**ULR-TC568822300000100F**

Seite 29 von 197  
Page 29 of 197

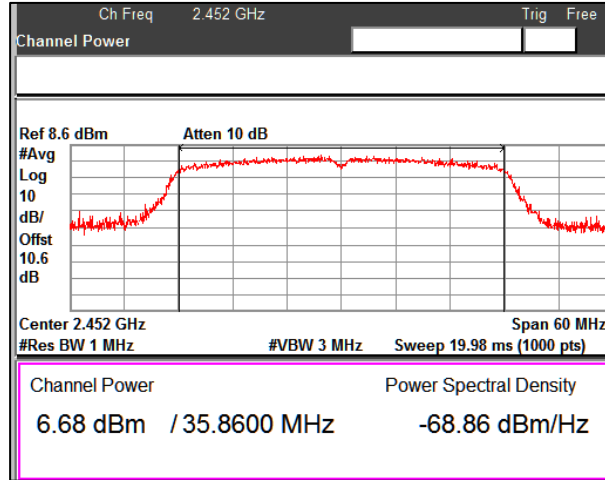

Channel Frequency: 2452MHz

Data rate: MCS4

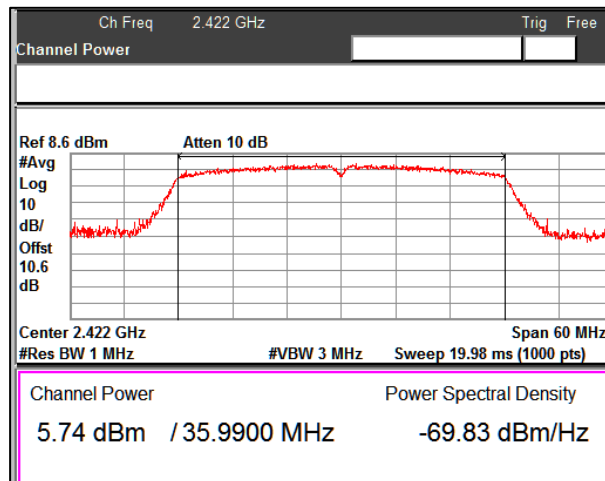

Channel Frequency: 2422MHz

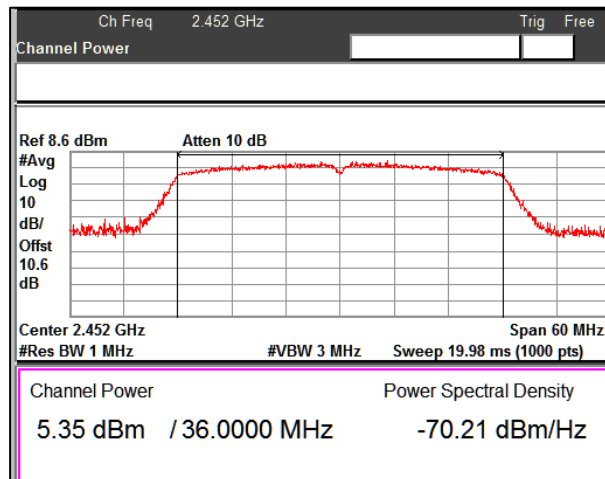

Channel Frequency: 2452MHz

**Prüfbericht - Nr.:**  
Test Report No.:

**IN22T1OT 001**  
**ULR-TC568822300000100F**

Seite 30 von 197  
Page 30 of 197

Data rate: MCS7

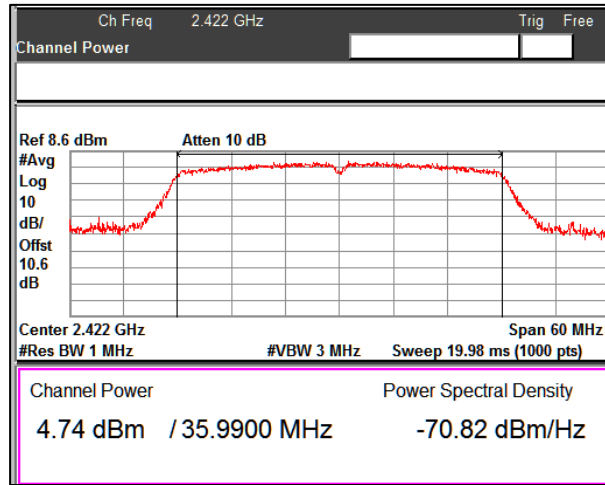

Channel Frequency: 2422MHz

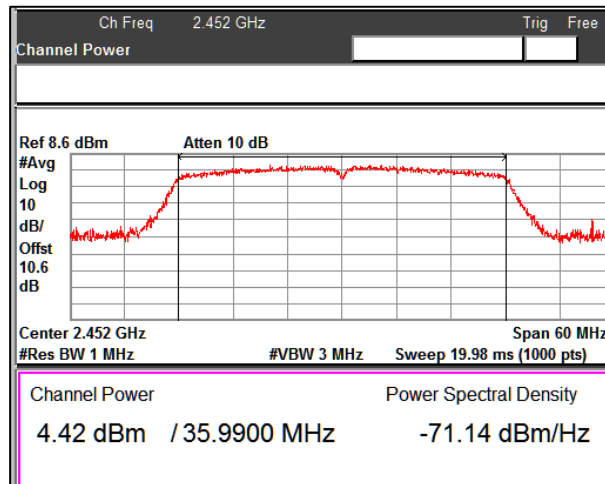

Channel Frequency: 2452MHz

**Prüfbericht - Nr.:**  
Test Report No.:

**IN22T1OT 001**  
**ULR-TC568822300000100F**

Seite 31 von 197  
Page 31 of 197

## 7.2 Maximum Power Spectral Density

### Result

### Pass

Test Specification	FCC part 15 Subpart C 15.247 (e) / RSS 247 Issue 2, Section 5.2 (b)
Test Method	Subclause 11.10.7 of ANSI C63.10
Measurement Bandwidth	100 kHz
Detector	Average sample detector mode
Port of testing	Antenna port
Requirement	For digitally modulated systems, the power spectral density conducted from the intentional radiator to the antenna shall not be greater than 8 dBm

### Test Method:

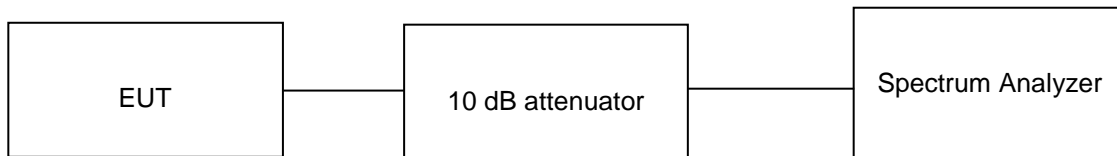

### Test Condition

#### Normal Test Condition:

Temperature (Norm) = + 25°C

Voltage = 3.6V Li-Ion battery

Relative humidity: 62 %

### KDB Guidelines applied:

Measurements were made as per section 8.4 in KDB 558074 D01 15.247 Measurement Guidance v05r02.

**Prüfbericht - Nr.:**  
Test Report No.:

**IN22T1OT 001**  
**ULR-TC568822300000100F**

Seite 32 von 197  
Page 32 of 197

**Test results:**

**Note:**

1. All the losses are included during measurement and final values are mentioned in the test report.
2. Total Average PSD (dBm) = Measured Average PSD (dBm) + Attenuator factor (10dB) + Cable loss (0.6dB)
3. This product do not support additional beamforming gain / directional gain, it uses signal antenna and hence directional gain of the single antenna is 2.53 dBi

**Modulation: 802.11b**

Data rate	Channel Frequency (MHz)	Measured average PSD (dBm/100kHz)	PSD Limit (dBm/100kHz)
1Mbps	2412	4.75	8.00
	2437	4.89	8.00
	2462	4.79	8.00
11Mbps	2412	5.47	8.00
	2437	6.61	8.00
	2462	4.59	8.00

**Data rate:1Mbps**

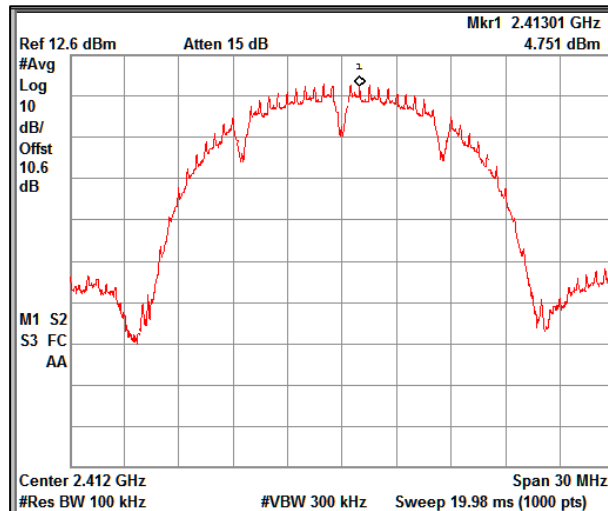

Channel Frequency: 2412MHz

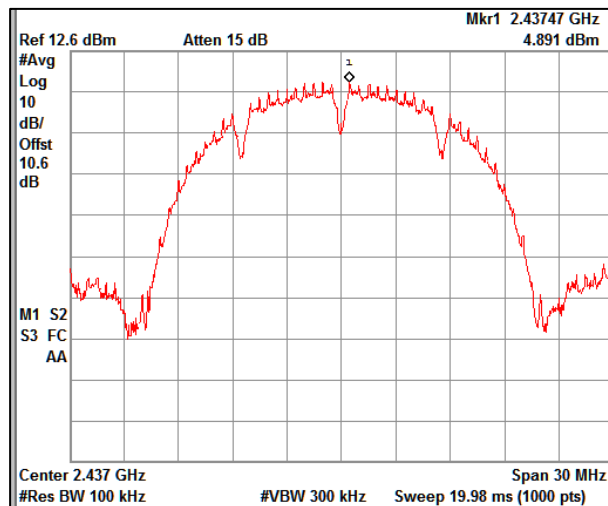

Channel Frequency: 2437MHz



**Prüfbericht - Nr.:**  
Test Report No.:

**IN22T1OT 001**  
**ULR-TC568822300000100F**

Seite 33 von 197  
Page 33 of 197

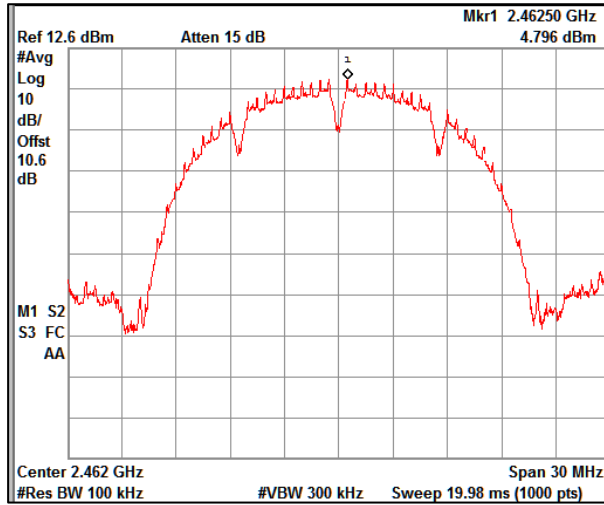

Channel Frequency: 2462MHz

Data rate: 11Mbps

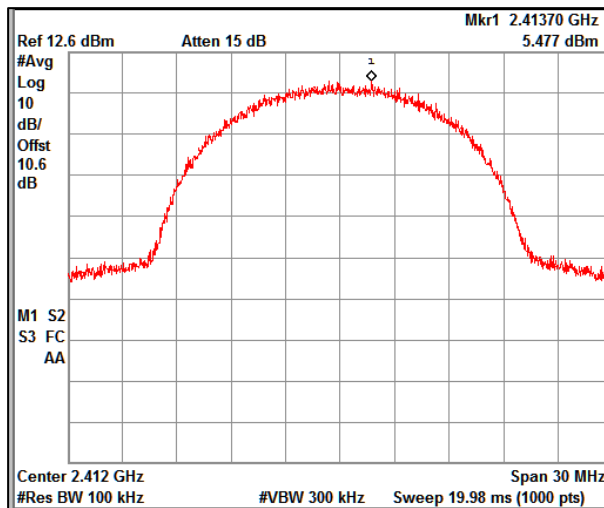

Channel Frequency: 2412MHz

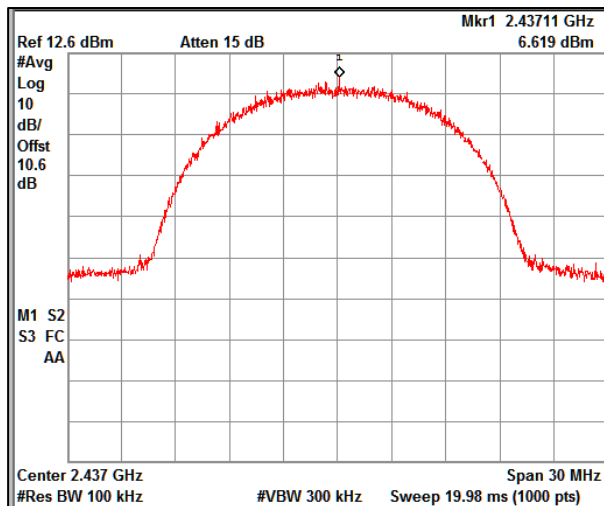

Channel Frequency: 2437MHz

**Prüfbericht - Nr.:**  
Test Report No.:

**IN22T1OT 001**  
**ULR-TC568822300000100F**

Seite 34 von 197  
Page 34 of 197

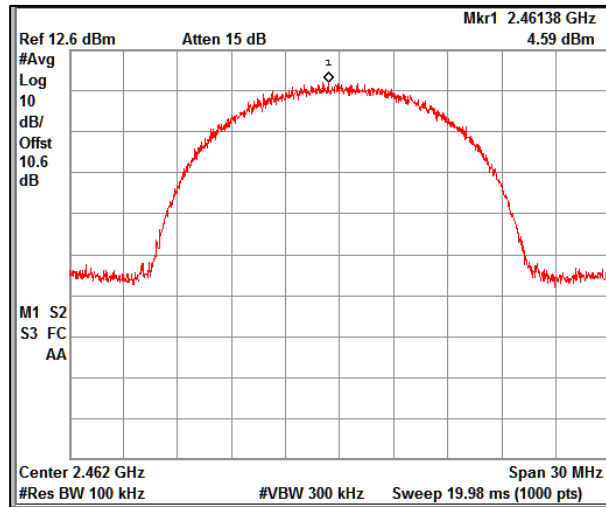

Channel Frequency: 2462MHz

Modulation: 802.11g

Data rate	Channel Frequency (MHz)	Measured average PSD (dBm/100kHz)	PSD Limit (dBm/100kHz)
6Mbps	2412	-0.68	8.00
	2437	4.54	8.00
	2462	-0.82	8.00
24Mbps	2412	-0.16	8.00
	2437	3.44	8.00
	2462	-1.52	8.00
54Mbps	2412	-0.26	8.00
	2437	1.34	8.00
	2462	-0.94	8.00

Data rate: 6Mbps

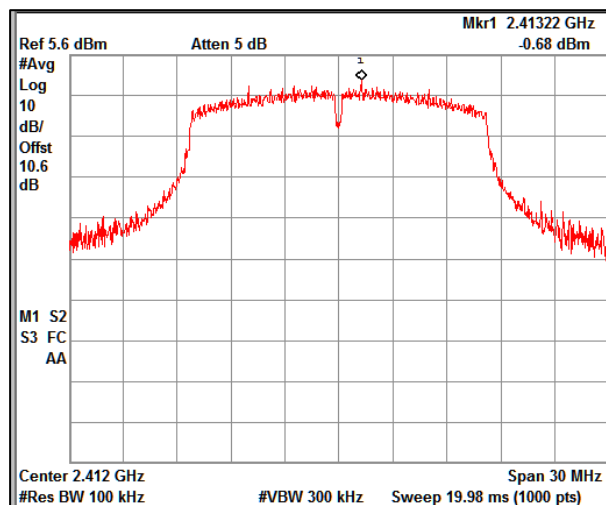

Channel Frequency: 2412MHz

**Prüfbericht - Nr.:**  
Test Report No.:

**IN22T1OT 001**  
**ULR-TC568822300000100F**

Seite 35 von 197  
Page 35 of 197

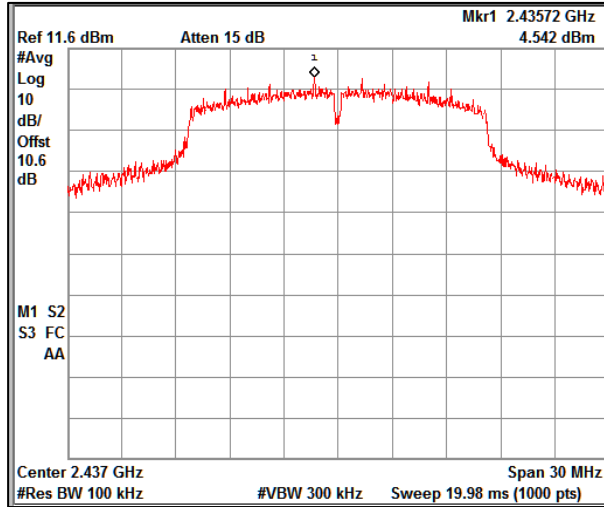

Channel Frequency: 2437MHz

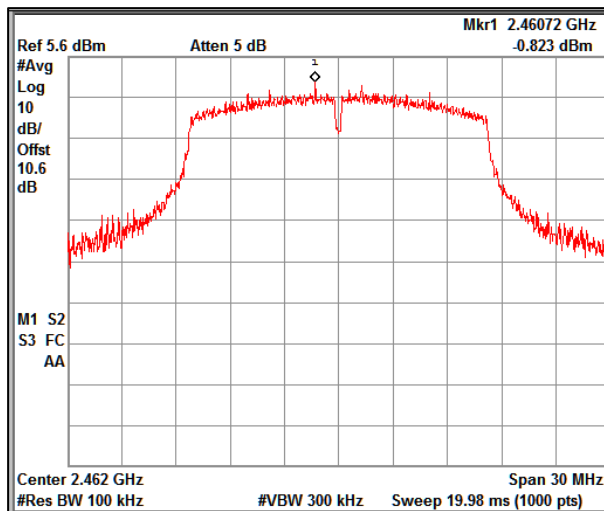

Channel Frequency: 2462MHz

Data rate: 24Mbps

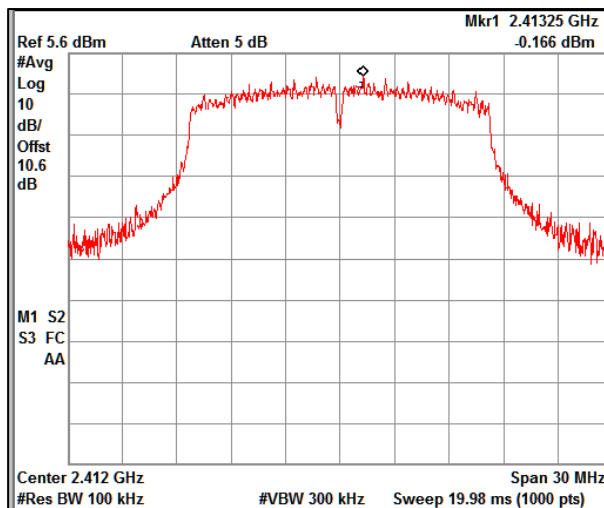

Channel Frequency: 2412MHz

**Prüfbericht - Nr.:**  
Test Report No.:

**IN22T1OT 001**  
**ULR-TC568822300000100F**

Seite 36 von 197  
Page 36 of 197

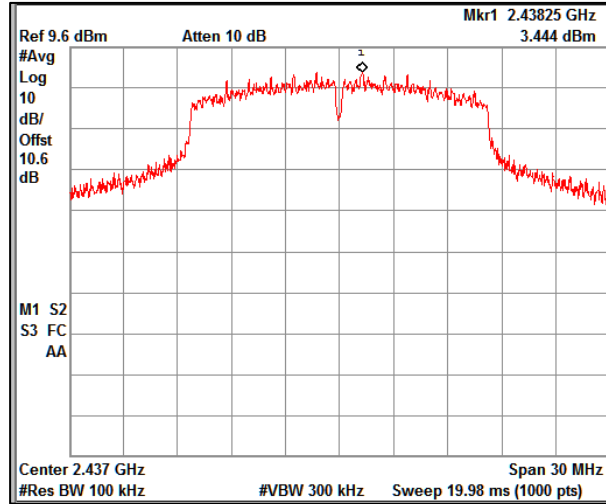

Channel Frequency: 2437MHz

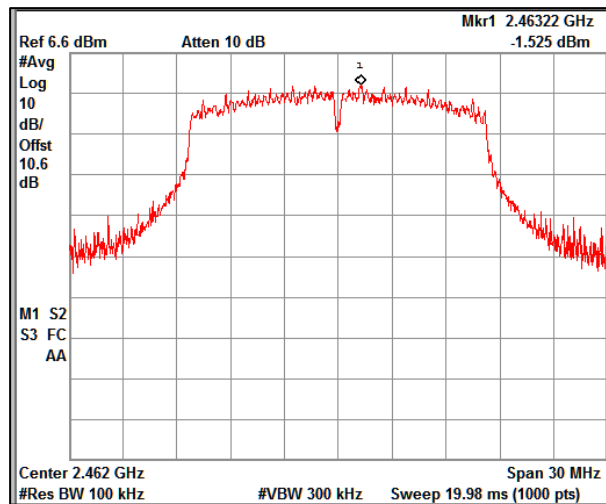

Channel Frequency: 2462MHz

Data rate: 54Mbps

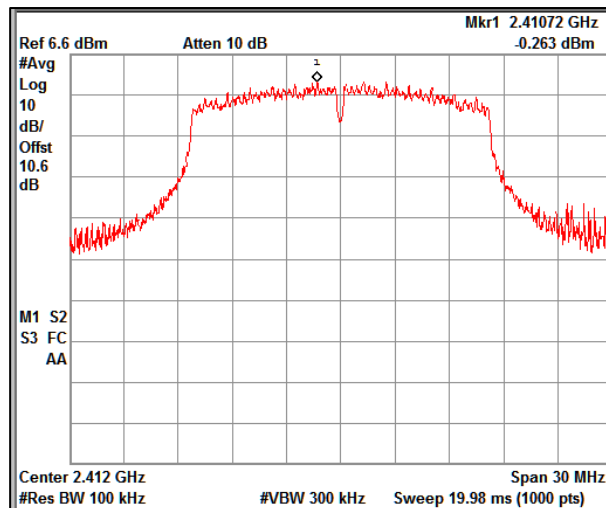

Channel Frequency: 2412MHz

**Prüfbericht - Nr.:**  
Test Report No.:

**IN22T1OT 001**  
**ULR-TC568822300000100F**

Seite 37 von 197  
Page 37 of 197

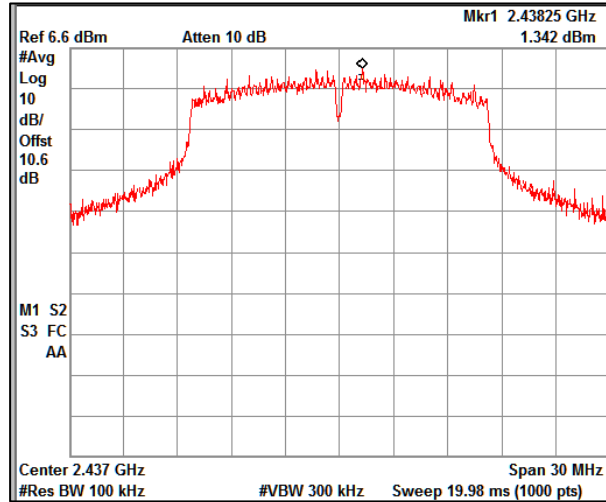

Channel Frequency: 2437MHz

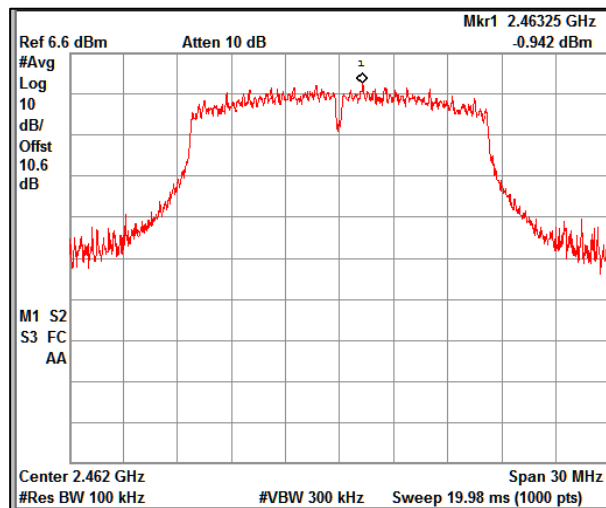

Channel Frequency: 2462MHz

**Modulation: 802.11n HT20**

Data rate	Channel Frequency (MHz)	Measured average PSD (dBm/100kHz)	PSD Limit (dBm/100kHz)
MCS0	2412	-0.30	8.00
	2437	3.77	8.00
	2462	-1.39	8.00
MCS4	2412	0.20	8.00
	2437	3.06	8.00
	2462	-0.91	8.00
MCS7	2412	0.15	8.00
	2437	0.59	8.00
	2462	-0.47	8.00





**Prüfbericht - Nr.:**  
Test Report No.:

**IN22T1OT 001**  
**ULR-TC568822300000100F**

Seite 40 von 197  
Page 40 of 197

Data rate: MCS7

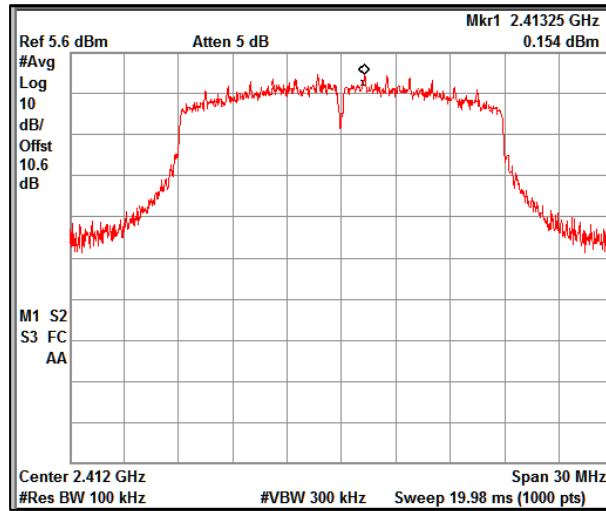

Channel Frequency: 2412MHz

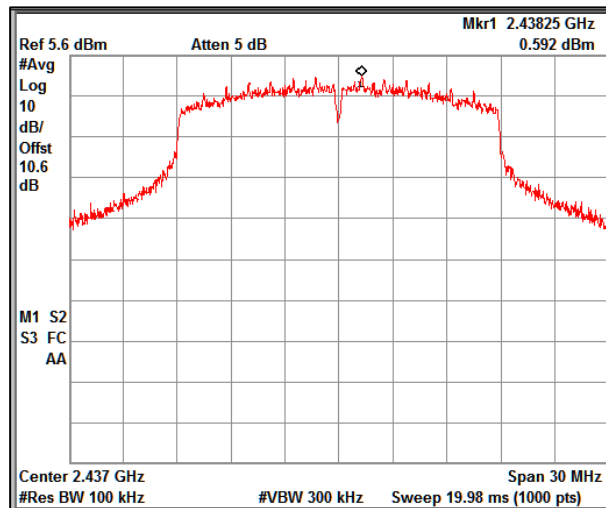

Channel Frequency: 2437MHz

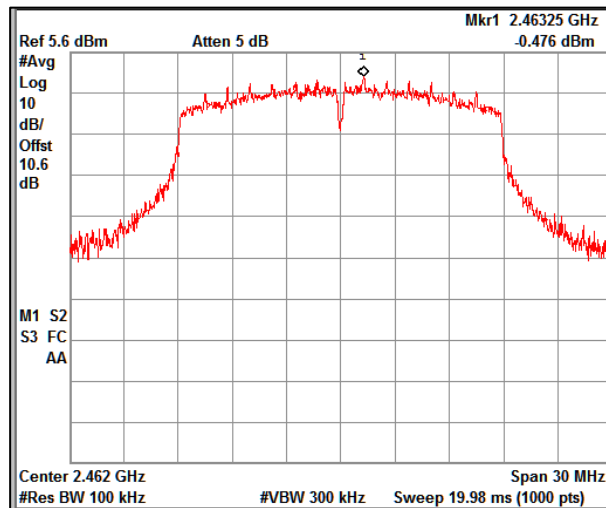

Channel Frequency: 2462MHz



**Prüfbericht - Nr.:**  
Test Report No.:

**IN22T1OT 001**  
**ULR-TC568822300000100F**

Seite 41 von 197  
Page 41 of 197

**Modulation: 802.11n HT40**

Data rate	Channel Frequency (MHz)	Measured average PSD (dBm/100kHz)	PSD Limit (dBm/100kHz)
MCS0	2422	-6.07	8.00
	2452	-5.30	8.00
MCS4	2422	-4.59	8.00
	2452	-5.34	8.00
MCS7	2422	-4.96	8.00
	2452	-5.02	8.00

**Data rate: MCS0**

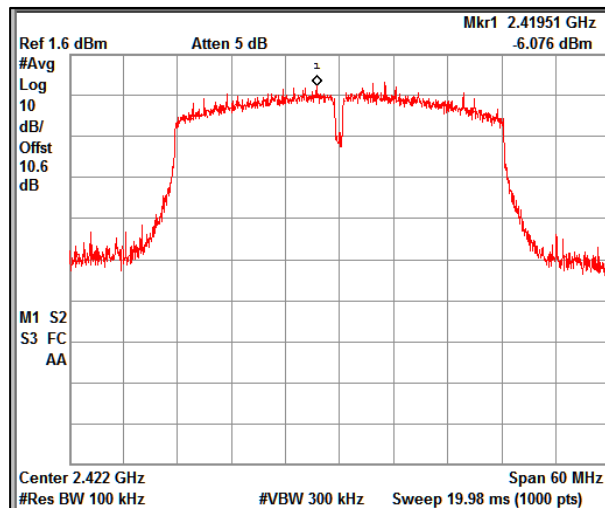

Channel Frequency: 2422MHz

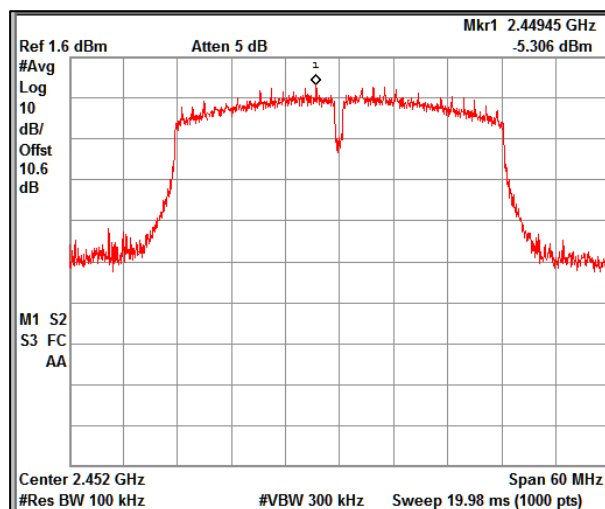

Channel Frequency: 2452MHz



**Prüfbericht - Nr.:**  
Test Report No.:

**IN22T1OT 001**  
**ULR-TC568822300000100F**

Seite 43 von 197  
Page 43 of 197

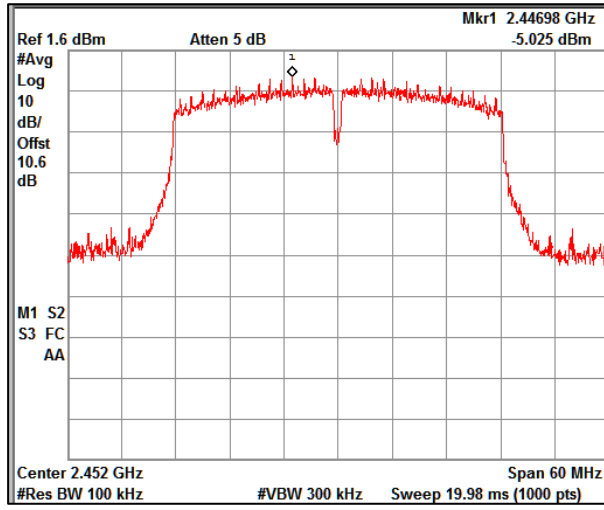

**Prüfbericht - Nr.:**  
Test Report No.:

**IN22T1OT 001**  
**ULR-TC568822300000100F**

Seite 44 von 197  
Page 44 of 197

### 7.3 DTS Bandwidth & 99% Bandwidth

<b>Result</b>	<b>Pass</b>
Test Specification	FCC part 15 Subpart C 15.247 (a) (2) / RSS 247 Issue 2, Section 5.2 (a)
Test Method	Subclause 11.8.1 of ANSI C63.10
Measurement Bandwidth	100 kHz for x dB bandwidth 1 to 5% of OCB for 99% bandwidth
Detector	Peak
Port of testing	Antenna port
Requirement	The minimum 6 dB bandwidth shall be at least 500 kHz

**Test Method:**

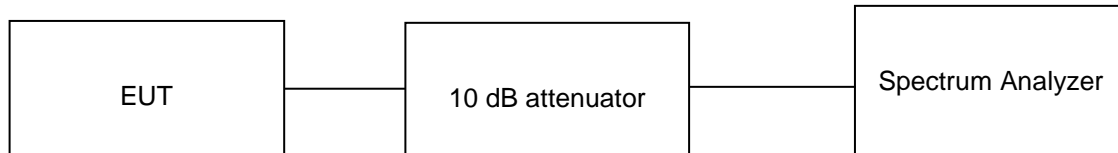

**Test Condition**

**Normal Test Condition:**

Temperature (Norm) = + 25 °C

Voltage= 3.6V Li-Ion battery

Relative humidity: 62 %

**KDB Guidelines applied:**

Measurements were made as per section 8.2 in KDB 558074 D01 15.247 Measurement Guidance v05r02.

**Prüfbericht - Nr.:**  
Test Report No.:

**IN22T1OT 001**  
**ULR-TC568822300000100F**

Seite 45 von 197  
Page 45 of 197

**Test results:**

**Note:**

1. All the losses are included during measurement and final values are mentioned in the test report.
2. For 6 dB Bandwidth Measurements were made as per section 8.2 in KDB 558074 D01 15.247 Measurement Guidance v05r02.
3. For OCW 99 % Bandwidth measurements were made as per section 6.9.3 ANSI C63.10-2013 & 6.7 RSS GEN issue 5

**Modulation: 802.11b**

Data rate	Channel Frequency (MHz)	6 dB Bandwidth (MHz)	99% OBW (MHz)	Minimum Limit (MHz)
1Mbps	2412	14.52	14.55	0.5
	2437	14.57	14.61	0.5
	2462	14.56	14.64	0.5
11Mbps	2412	14.51	14.54	0.5
	2442	14.48	14.56	0.5
	2462	14.49	14.54	0.5

**Graphs for 6 dB bandwidth measurement**

**Data rate: 1Mbps**

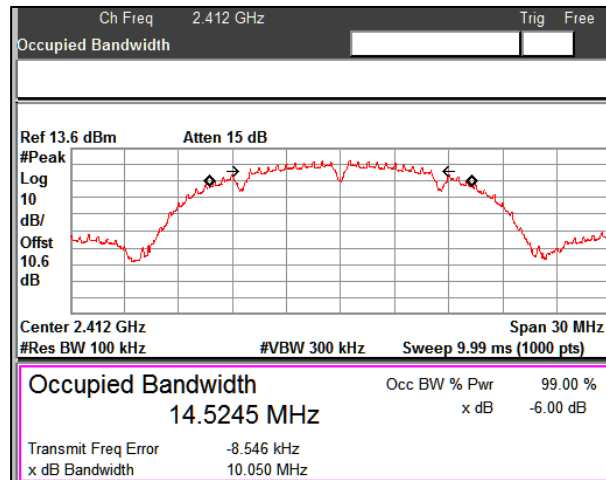

Channel Frequency: 2412MHz

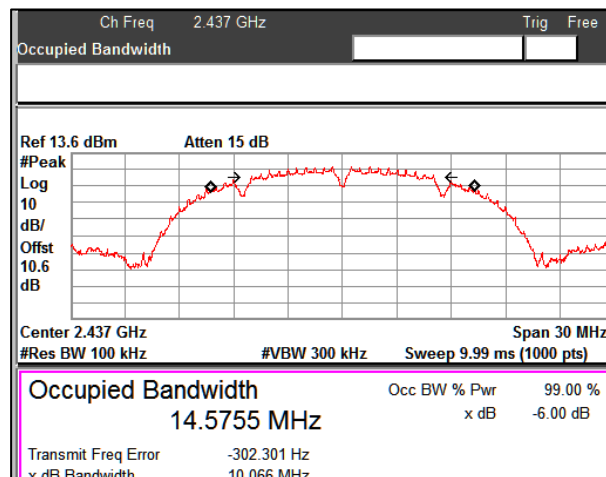

Channel Frequency: 2437MHz

**Prüfbericht - Nr.:**  
Test Report No.:

**IN22T1OT 001**  
**ULR-TC568822300000100F**

Seite 46 von 197  
Page 46 of 197

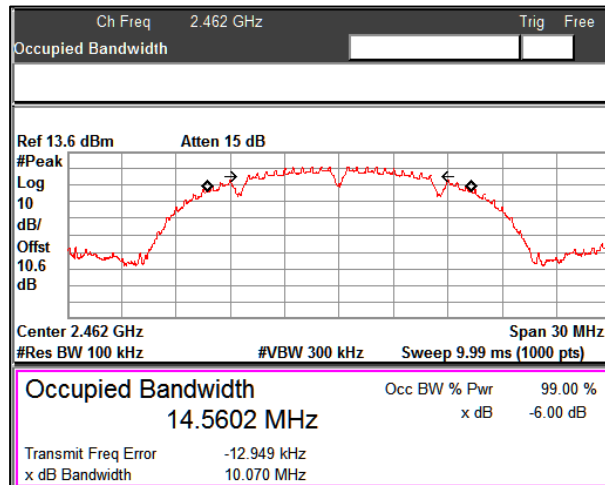

Channel Frequency: 2462MHz

Data rate: 11Mbps

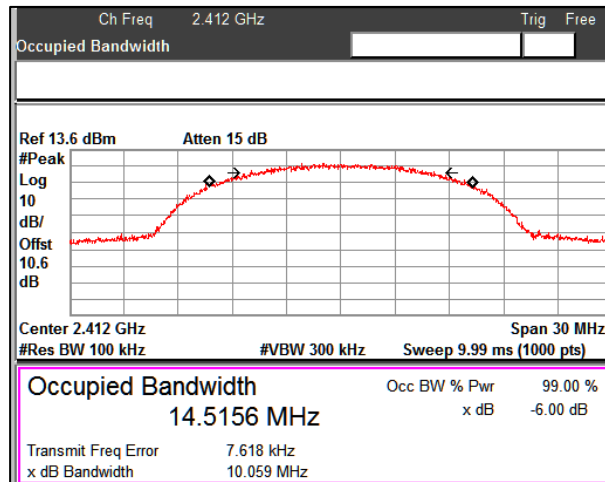

Channel Frequency: 2412MHz

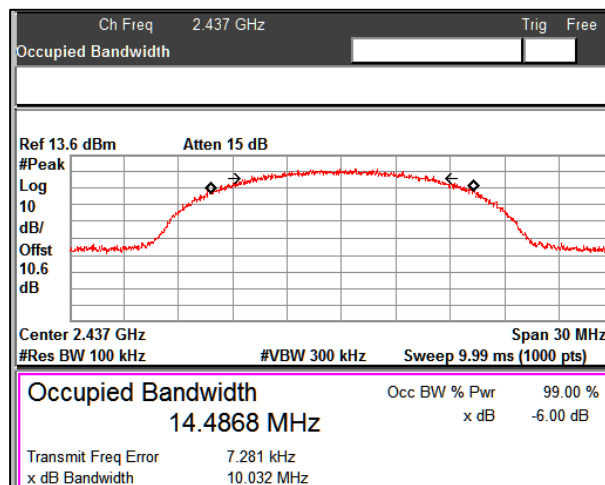

Channel Frequency: 2437MHz

**Prüfbericht - Nr.:**  
Test Report No.:

**IN22T1OT 001**  
**ULR-TC568822300000100F**

Seite 47 von 197  
Page 47 of 197

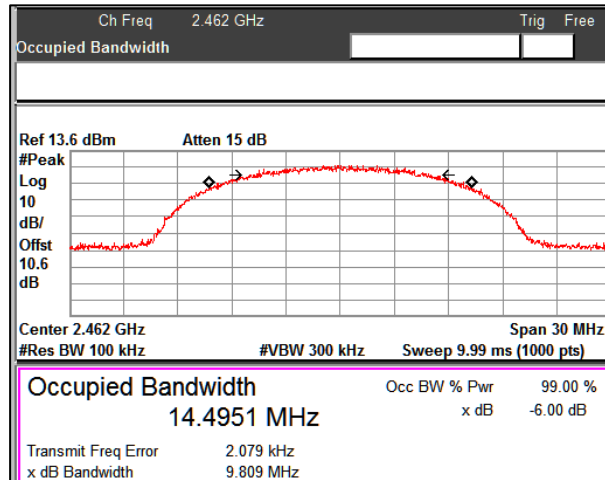

Channel Frequency: 2462MHz

**Graphs for OCW 99 % bandwidth measurement**

**Data rate: 1Mbps**

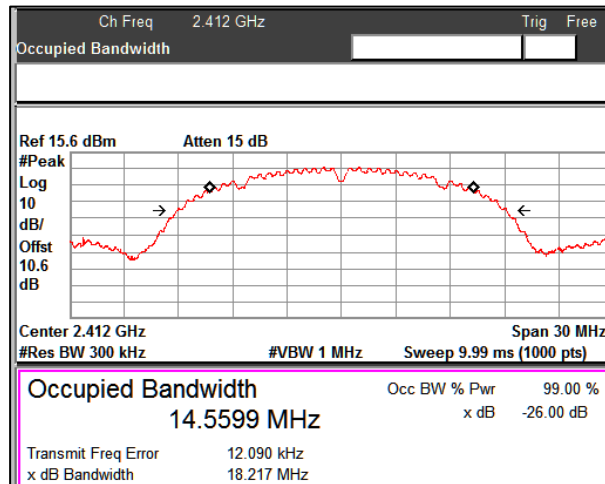

Channel Frequency: 2412MHz

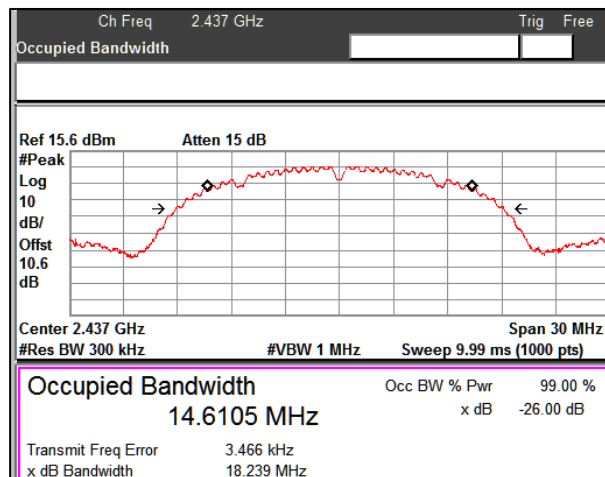

Channel Frequency: 2437MHz

**Prüfbericht - Nr.:**  
Test Report No.:

**IN22T1OT 001**  
**ULR-TC568822300000100F**

Seite 48 von 197  
Page 48 of 197

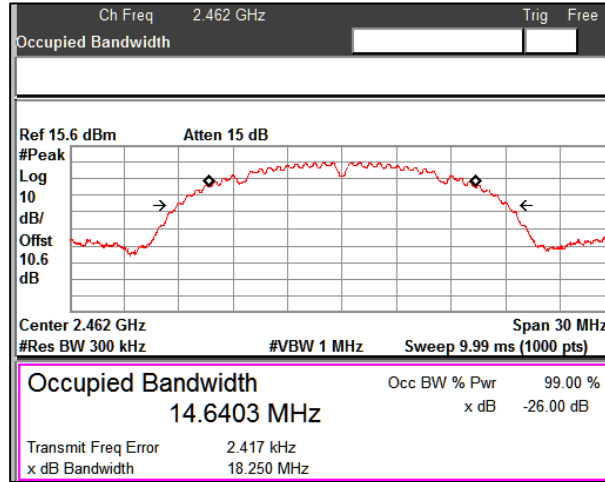

Channel Frequency: 2462MHz

Data rate: 11Mbps

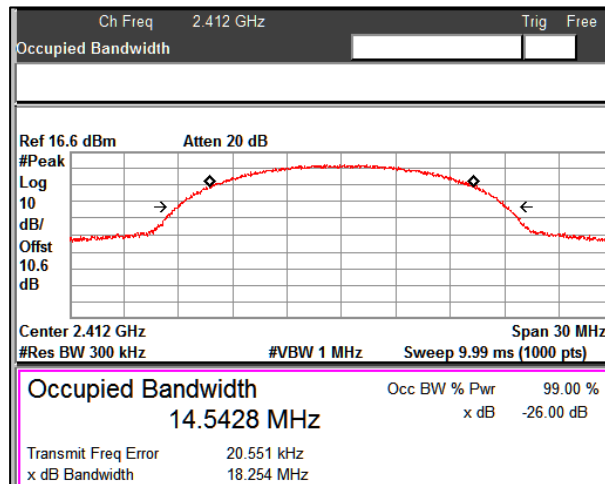

Channel Frequency: 2412MHz

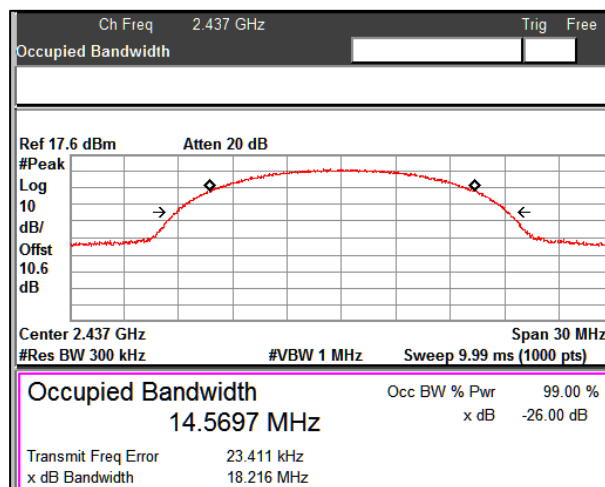

Channel Frequency: 2437MHz



**Prüfbericht - Nr.:**  
Test Report No.:

**IN22T1OT 001**  
**ULR-TC568822300000100F**

Seite 49 von 197  
Page 49 of 197

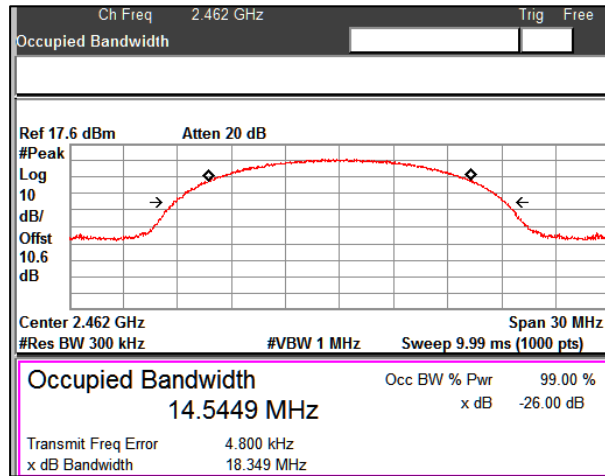

Channel Frequency: 2462MHz

**Modulation: 802.11g**

Data rate	Channel Frequency (MHz)	6 dB Bandwidth (MHz)	99% OBW (MHz)	Minimum Limit (MHz)
6Mbps	2412	16.24	16.38	0.5
	2437	17.84	18.96	0.5
	2462	16.23	16.39	0.5
24Mbps	2412	16.26	16.40	0.5
	2437	16.43	17.13	0.5
	2462	16.26	16.41	0.5
54Mbps	2412	16.23	16.40	0.5
	2437	16.32	16.63	0.5
	2462	16.24	16.40	0.5

**Graphs for 6 dB bandwidth measurement**

**Data Rate: 6Mbps**

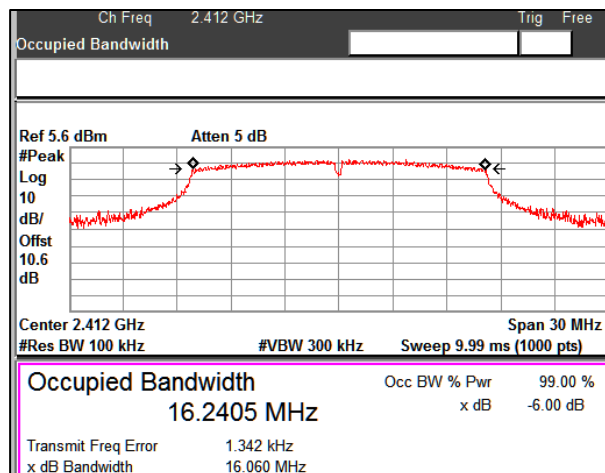

Channel Frequency: 2412MHz

**Prüfbericht - Nr.:**  
Test Report No.:

**IN22T1OT 001**  
**ULR-TC568822300000100F**

Seite 50 von 197  
Page 50 of 197

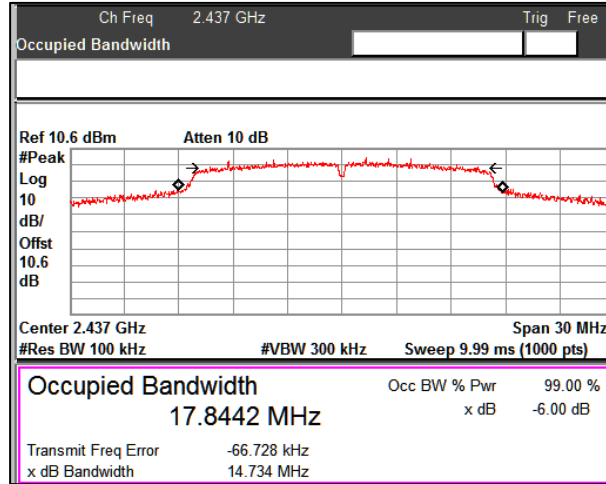

Channel Frequency: 2437MHz

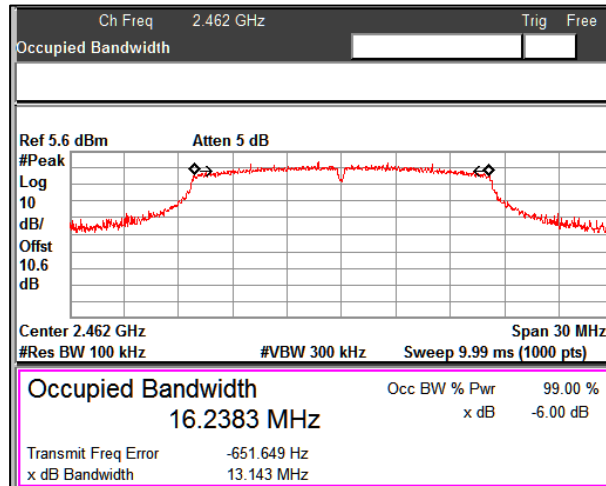

Channel Frequency: 2462MHz

Data Rate: 24Mbps

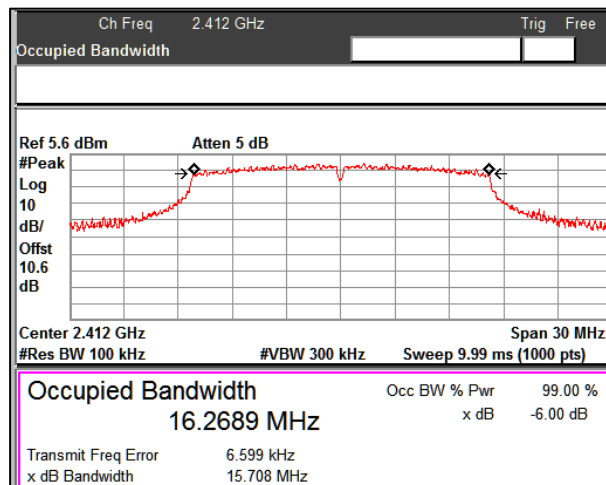

Channel Frequency: 2412MHz

**Prüfbericht - Nr.:**  
Test Report No.:

**IN22T1OT 001**  
**ULR-TC568822300000100F**

Seite 51 von 197  
Page 51 of 197

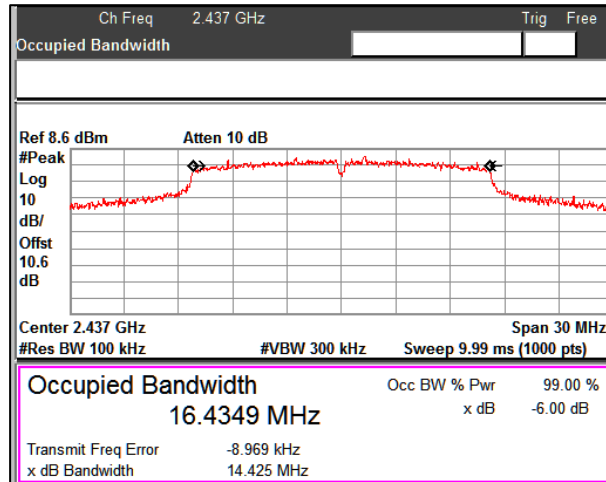

Channel Frequency: 2437MHz

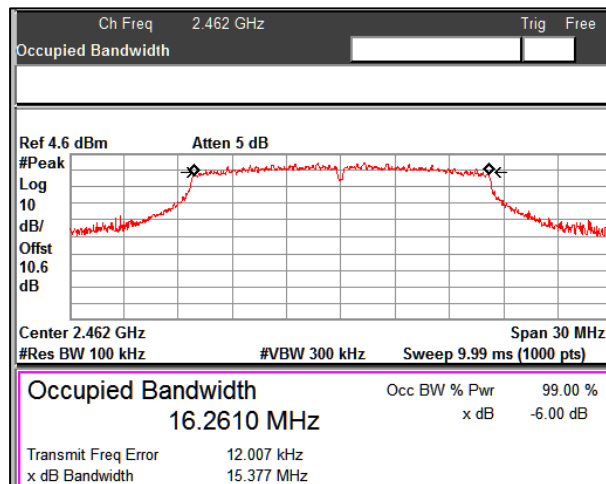

Channel Frequency: 2462MHz

Data Rate: 54Mbps

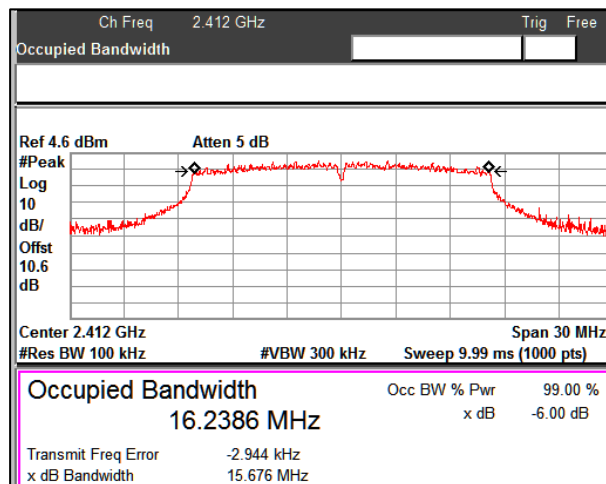

Channel Frequency: 2412MHz

**Prüfbericht - Nr.:**  
Test Report No.:

**IN22T1OT 001**  
**ULR-TC568822300000100F**

Seite 52 von 197  
Page 52 of 197

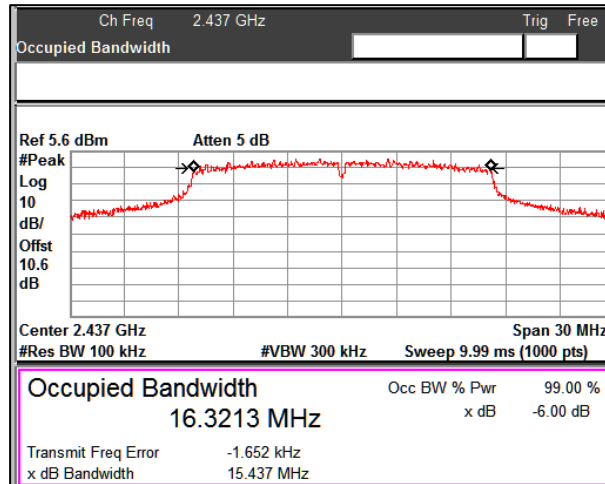

Channel Frequency: 2437MHz

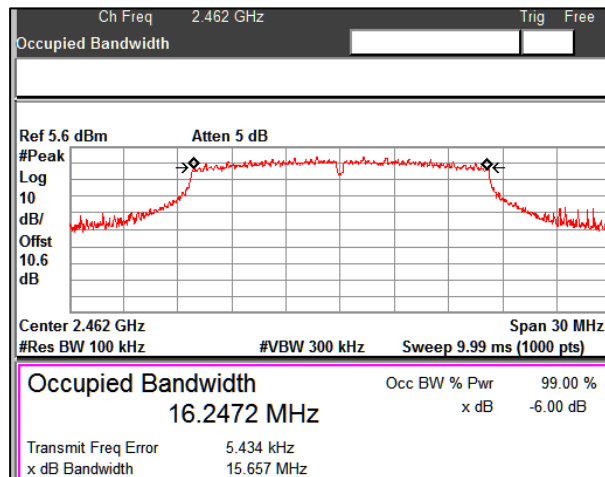

Channel Frequency: 2462MHz

Graphs for OCW 99 % bandwidth measurement

Data Rate: 6Mbps

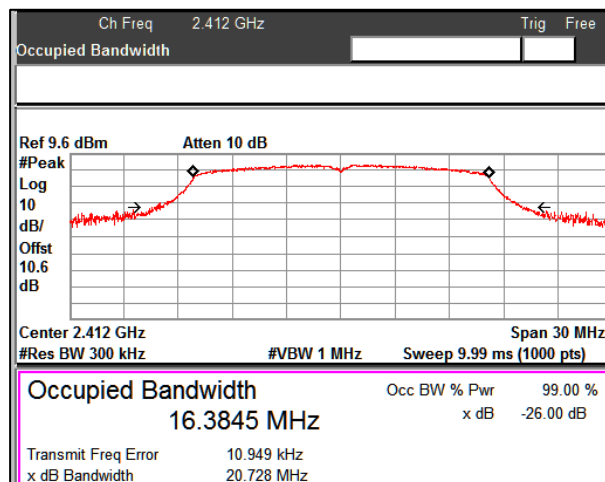

Channel Frequency: 2412MHz

**Prüfbericht - Nr.:**  
Test Report No.:

**IN22T1OT 001**  
**ULR-TC568822300000100F**

Seite 53 von 197  
Page 53 of 197

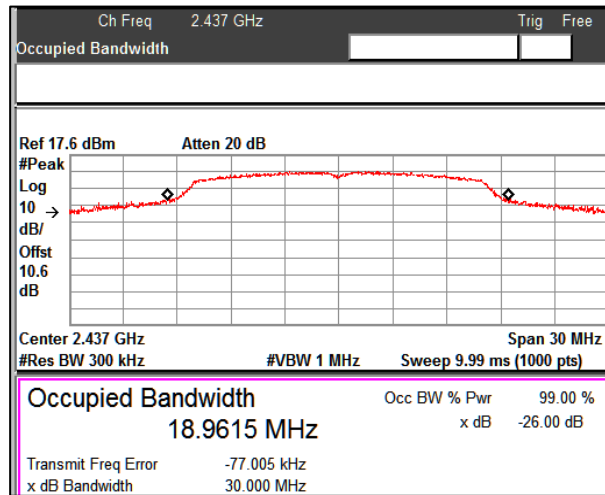

Channel Frequency: 2437MHz

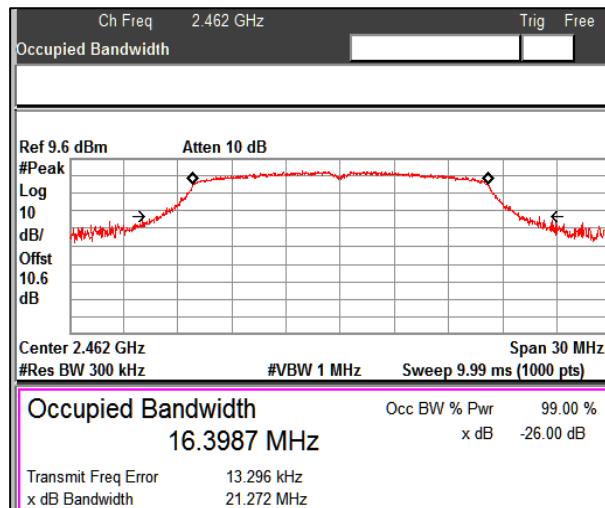

Channel Frequency: 2462MHz

Data Rate: 24Mbps

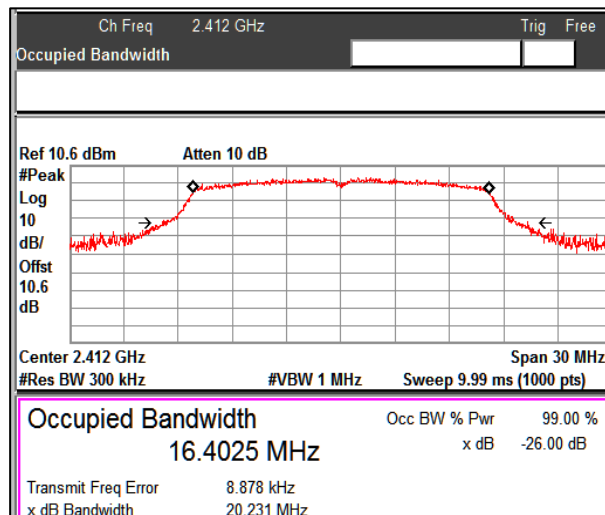

Channel Frequency: 2412MHz

**Prüfbericht - Nr.:**  
Test Report No.:

**IN22T1OT 001**  
**ULR-TC568822300000100F**

Seite 54 von 197  
Page 54 of 197

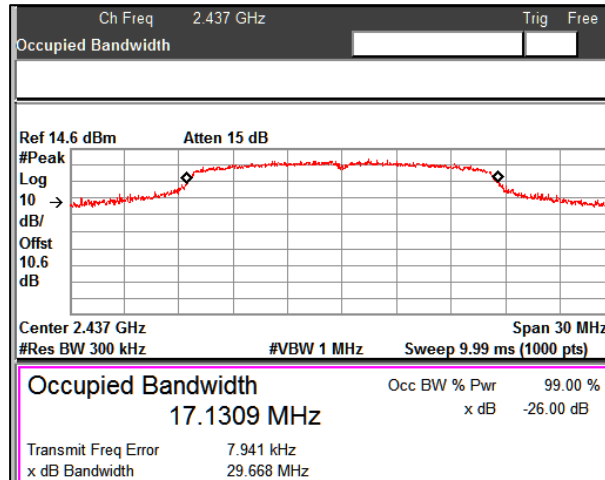

Channel Frequency: 2437MHz

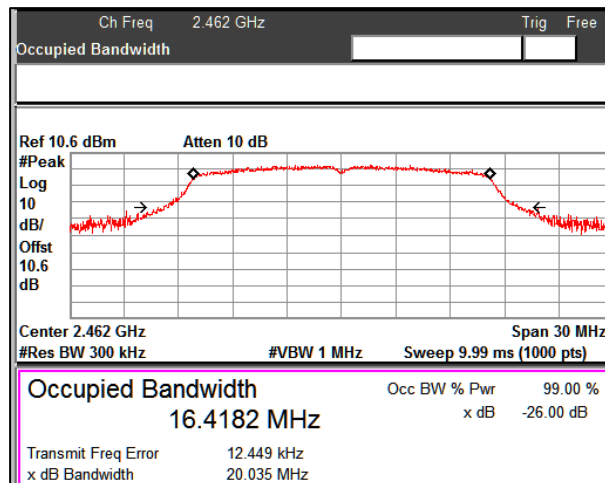

Channel Frequency: 2462MHz

**Data Rate: 54Mbps**

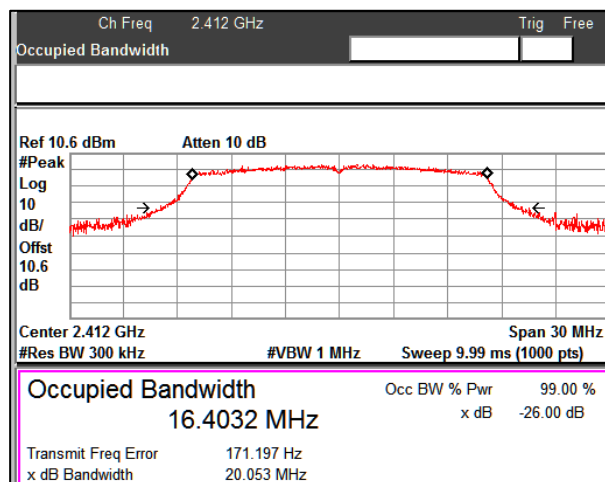

Channel Frequency: 2412MHz

**Prüfbericht - Nr.:**  
Test Report No.:

**IN22T1OT 001**  
**ULR-TC568822300000100F**

Seite 55 von 197  
Page 55 of 197

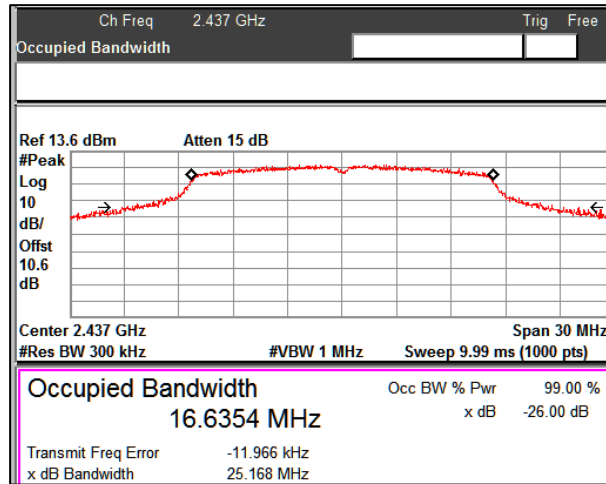

Channel Frequency: 2437MHz

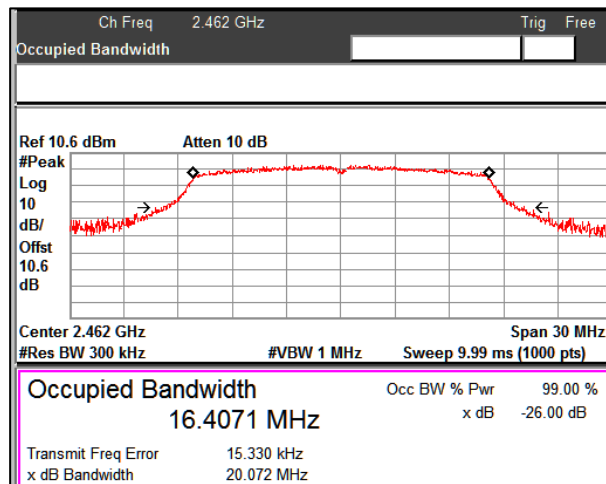

Channel Frequency: 2462MHz

**Modulation: 802.11n HT20**

Data rate	Channel Frequency (MHz)	6 dB Bandwidth (MHz)	99% OBW (MHz)	Minimum Limit (MHz)
MCS0	2412	17.38	17.50	0.5
	2437	17.74	18.38	0.5
	2462	17.39	17.52	0.5
MCS4	2412	17.41	17.53	0.5
	2437	17.56	17.85	0.5
	2462	17.39	17.57	0.5
MCS7	2412	17.42	17.54	0.5
	2437	17.46	17.68	0.5
	2462	17.39	17.53	0.5

**Prüfbericht - Nr.:**  
Test Report No.:

**IN22T1OT 001**  
**ULR-TC568822300000100F**

Seite 56 von 197  
Page 56 of 197

**Graphs for 6 dB bandwidth measurement**

**Data Rate: MCS0**

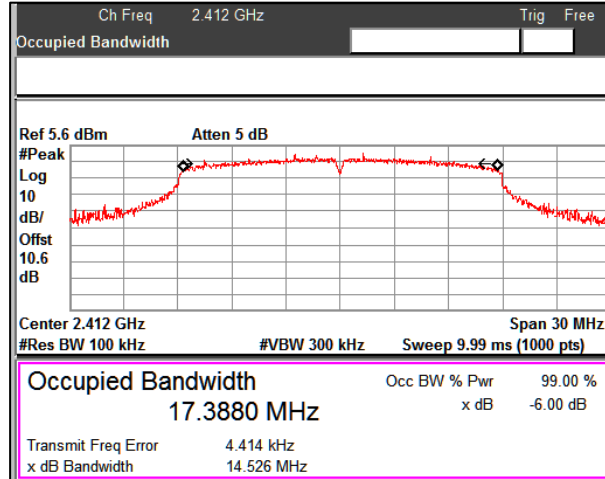

Channel Frequency: 2412MHz

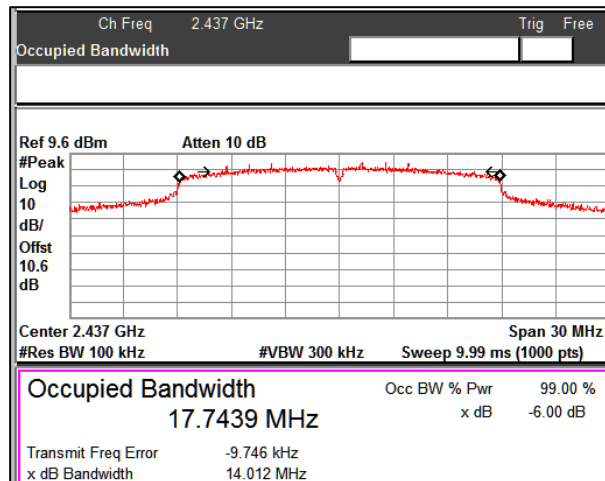

Channel Frequency: 2437MHz

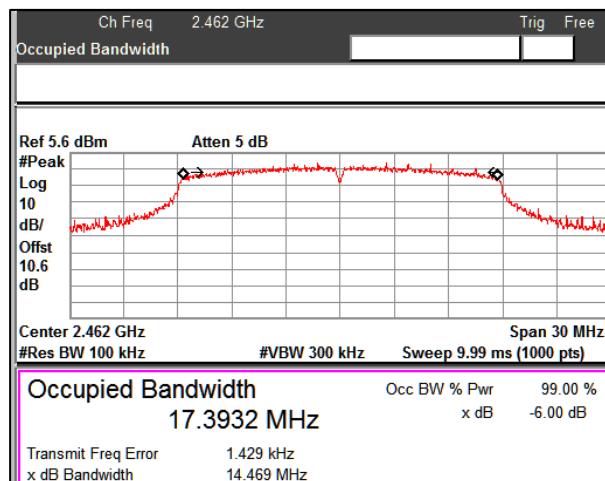

Channel Frequency: 2462MHz



**Prüfbericht - Nr.:**  
Test Report No.:

**IN22T1OT 001**  
**ULR-TC568822300000100F**

Seite 57 von 197  
Page 57 of 197

Data Rate: MCS4

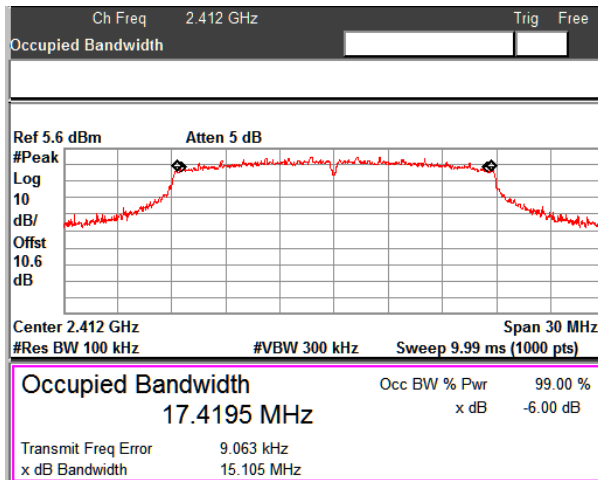

Channel Frequency: 2412MHz

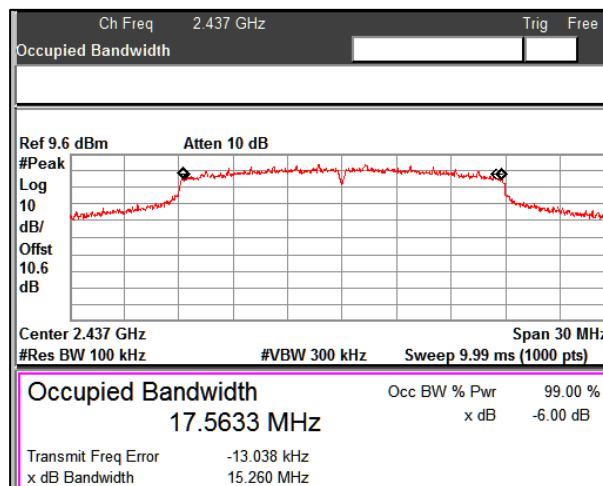

Channel Frequency: 2437MHz

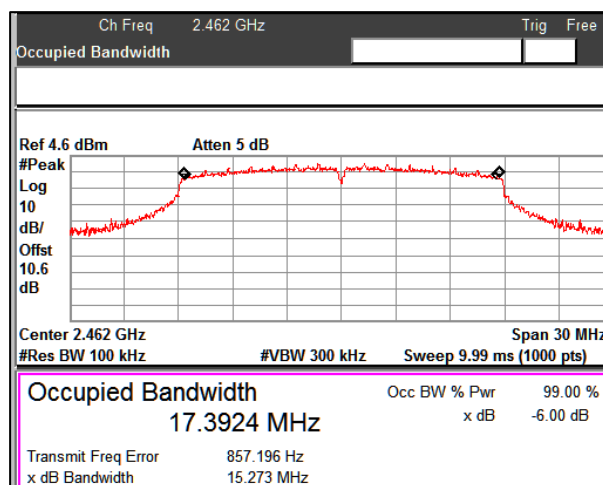

Channel Frequency: 2462MHz

**Prüfbericht - Nr.:**  
Test Report No.:

**IN22T1OT 001**  
**ULR-TC568822300000100F**

Seite 58 von 197  
Page 58 of 197

Data Rate: MCS7

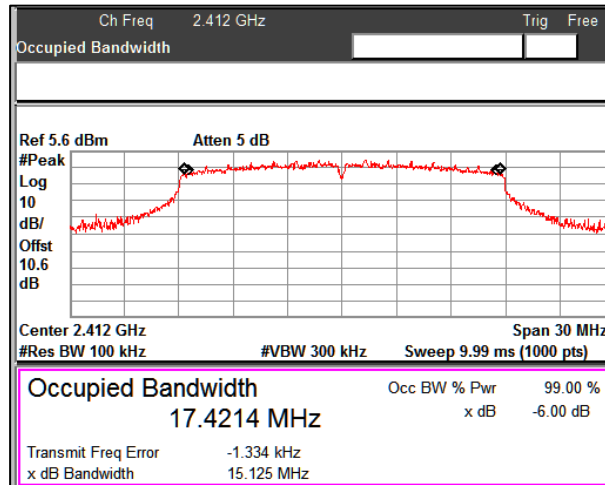

Channel Frequency: 2412MHz

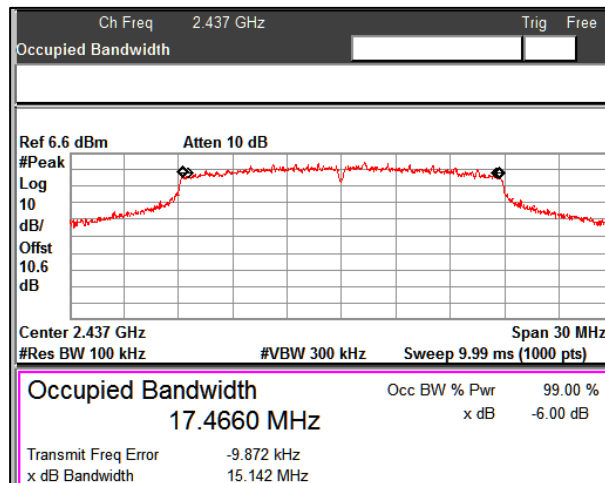

Channel Frequency: 2437MHz

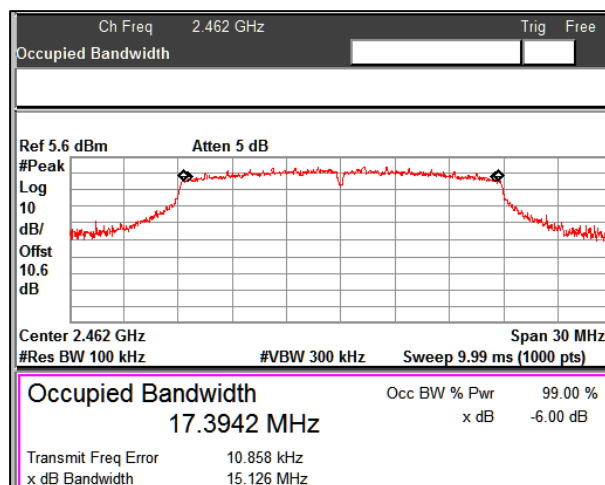

Channel Frequency: 2462MHz

**Prüfbericht - Nr.:**  
Test Report No.:

**IN22T1OT 001**  
**ULR-TC568822300000100F**

Seite 59 von 197  
Page 59 of 197

**Graphs for OCW 99 % bandwidth measurement**

Data Rate: MCS0

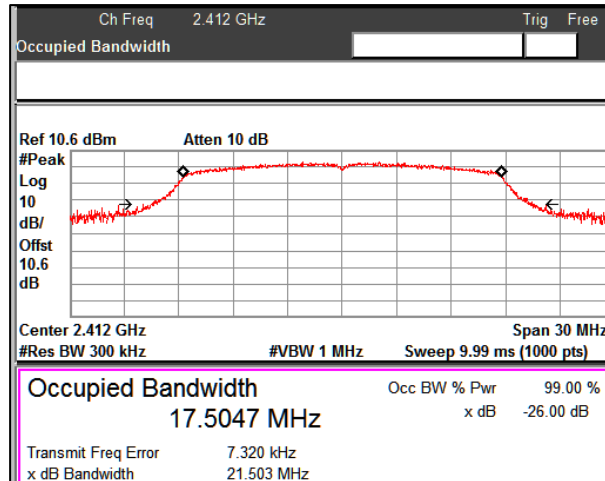

Channel Frequency: 2412MHz

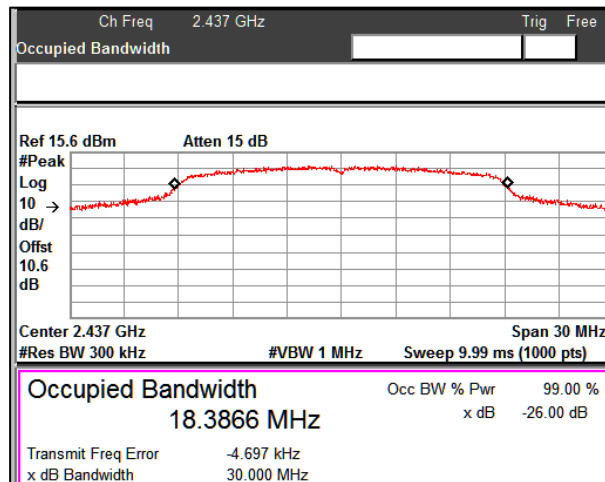

Channel Frequency: 2437MHz

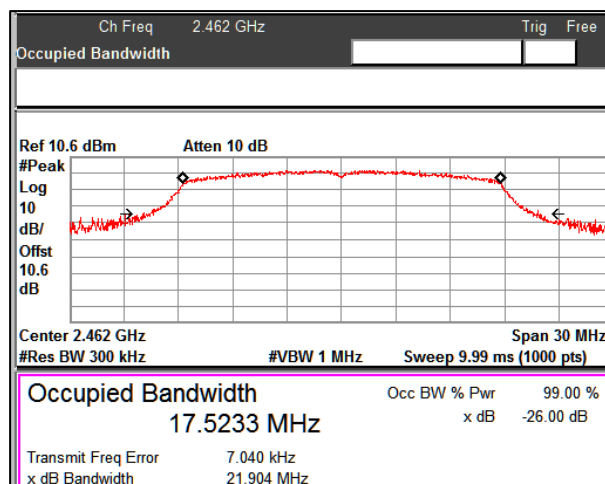

Channel Frequency: 2462MHz

**Prüfbericht - Nr.:**  
Test Report No.:

**IN22T1OT 001**  
**ULR-TC568822300000100F**

Seite 60 von 197  
Page 60 of 197

Data Rate: MCS4

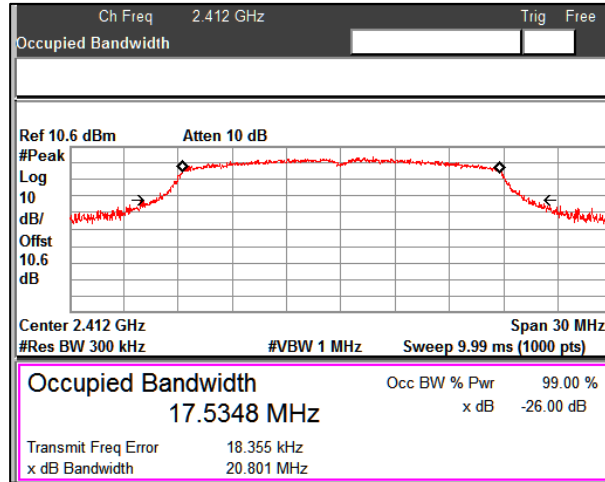

Channel Frequency: 2412MHz

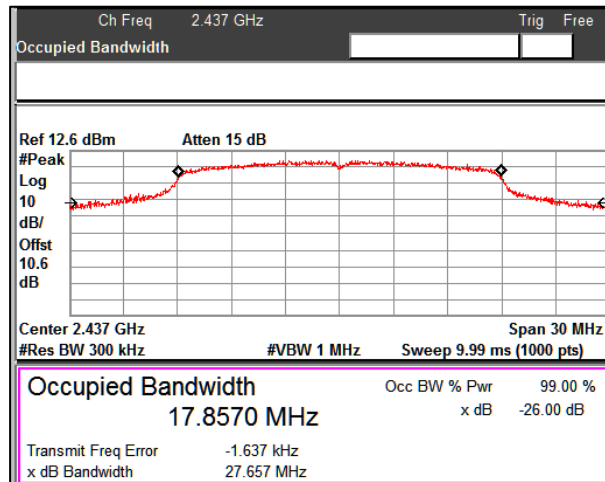

Channel Frequency: 2437MHz

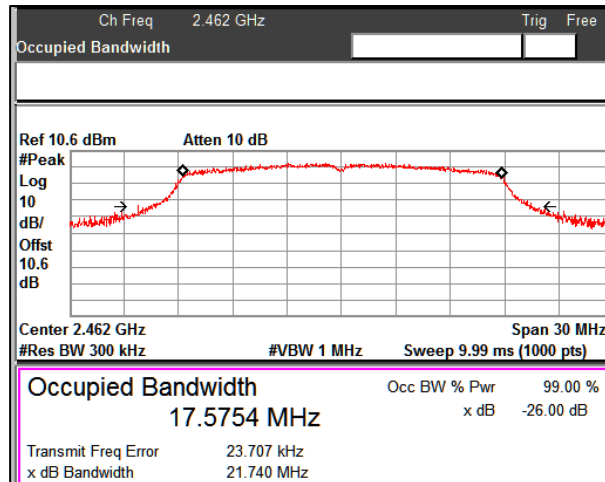

Channel Frequency: 2462MHz

**Prüfbericht - Nr.:**  
Test Report No.:

**IN22T1OT 001**  
**ULR-TC568822300000100F**

Seite 61 von 197  
Page 61 of 197

Data Rate: MCS7

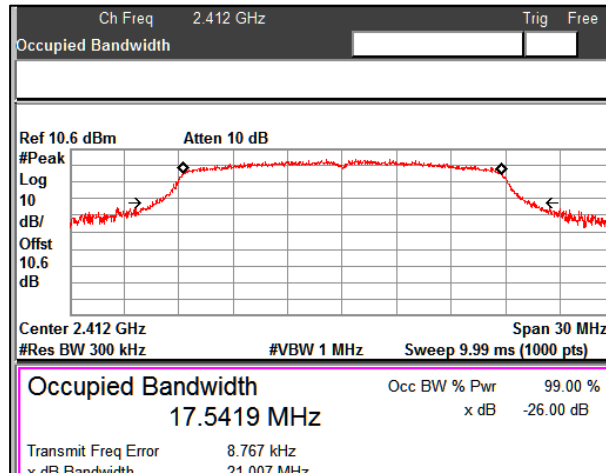

Channel Frequency: 2412MHz

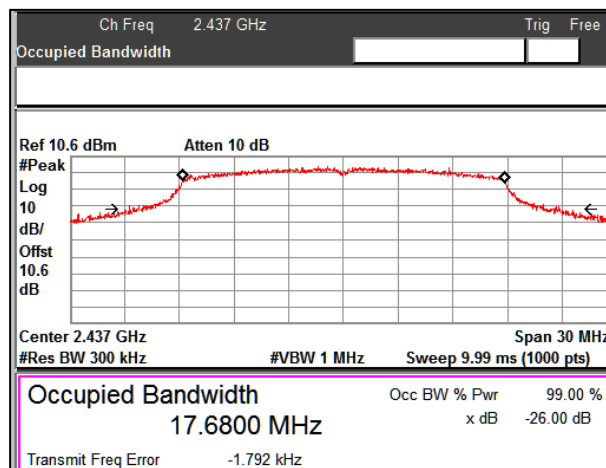

Channel Frequency: 2437MHz

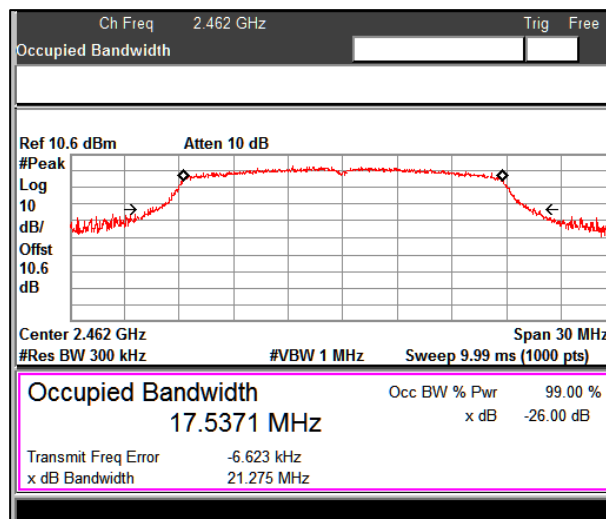

Channel Frequency: 2462MHz

**Prüfbericht - Nr.:**  
Test Report No.:

**IN22T1OT 001**  
**ULR-TC568822300000100F**

Seite 62 von 197  
Page 62 of 197

**Modulation: 802.11n HT40**

Data rate	Channel Frequency (MHz)	6 dB Bandwidth (MHz)	99% OBW (MHz)	Minimum Limit (MHz)
MCS0	2422	35.54	35.84	0.5
	2452	35.54	35.84	0.5
MCS4	2422	35.61	35.99	0.5
	2452	35.64	36.00	0.5
MCS7	2422	35.59	35.99	0.5
	2452	35.60	35.99	0.5

**Graphs for 6 dB bandwidth measurement**

**Data Rate: MCS0**

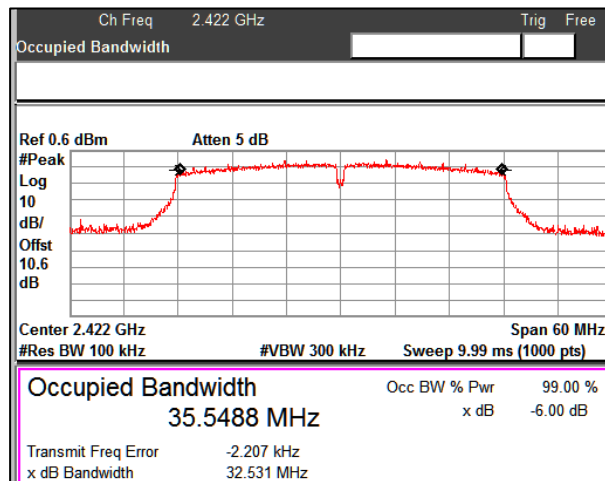

Channel Frequency 2422MHz

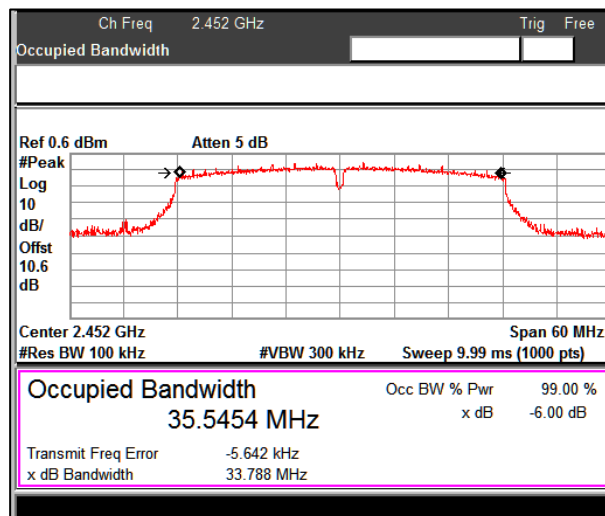

Channel Frequency 2452MHz

**Prüfbericht - Nr.:**  
Test Report No.:

**IN22T1OT 001**  
**ULR-TC568822300000100F**

Seite 63 von 197  
Page 63 of 197

Data Rate: MCS4

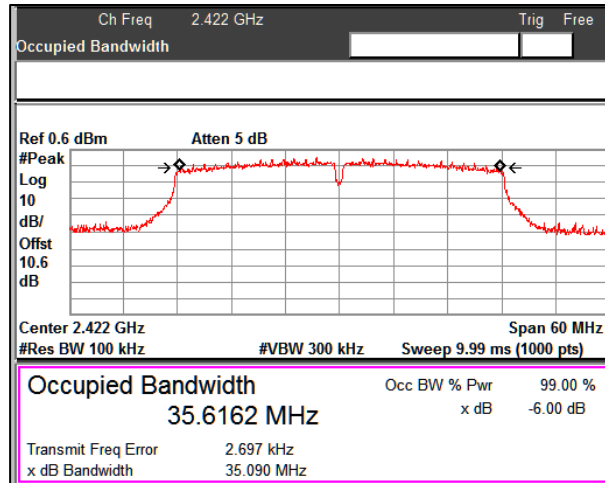

Channel Frequency 2422MHz

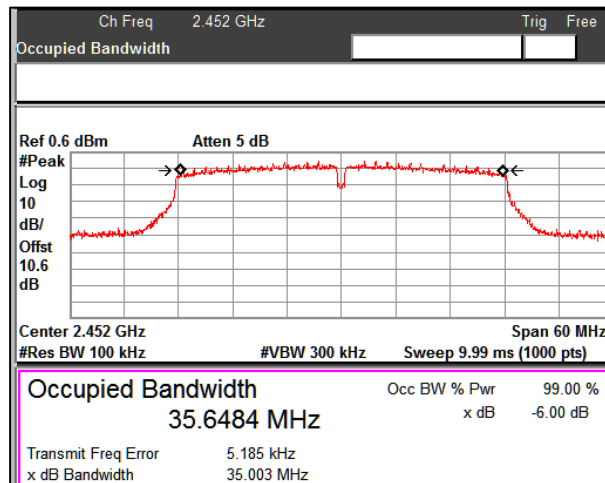

Channel Frequency 2452MHz

Data Rate: MCS7

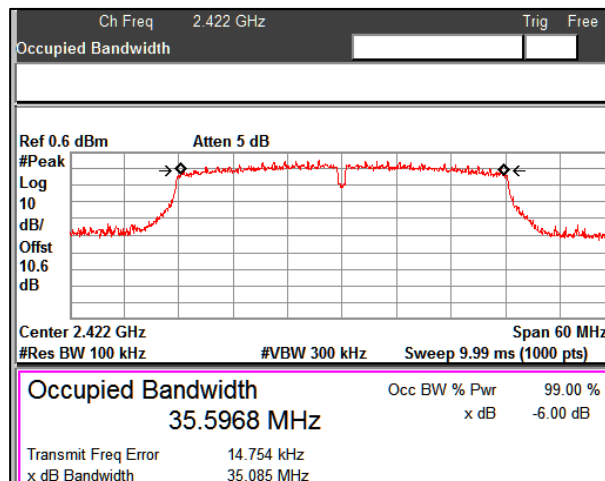

Channel Frequency 2422MHz

**Prüfbericht - Nr.:**  
Test Report No.:

**IN22T1OT 001**  
**ULR-TC568822300000100F**

Seite 64 von 197  
Page 64 of 197

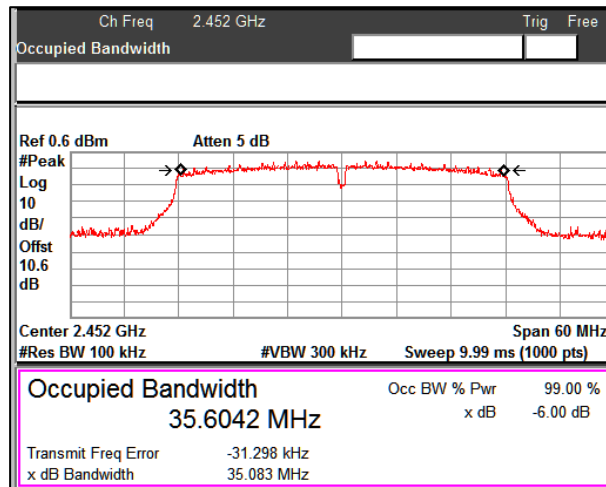

Channel Frequency 2452MHz

**Graphs for OCW 99 % bandwidth measurement**

Data Rate: MCS0

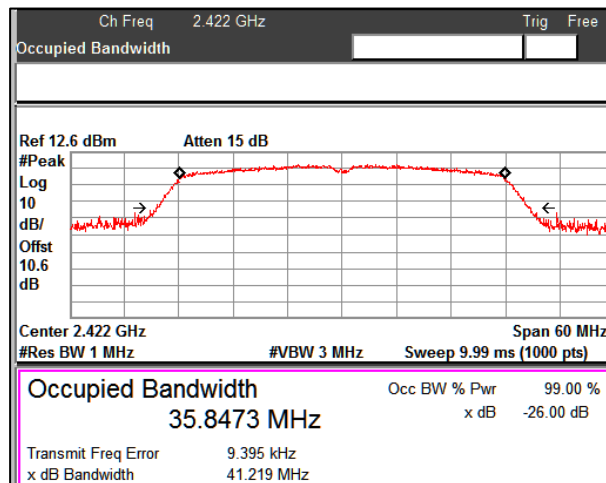

Channel Frequency 2422MHz

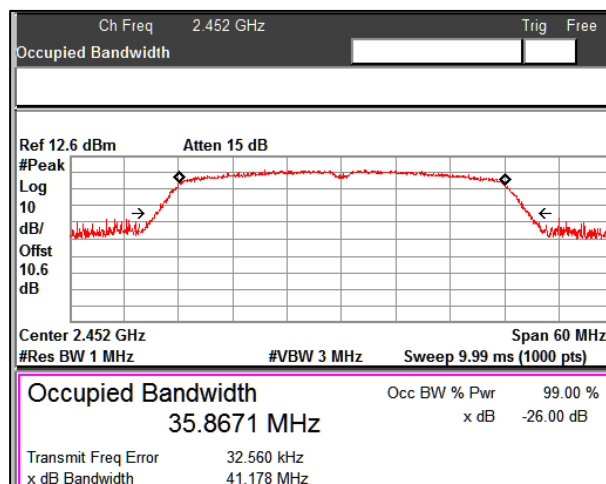

Channel Frequency 2452MHz



**Prüfbericht - Nr.:**  
Test Report No.:

**IN22T1OT 001**  
**ULR-TC568822300000100F**

Seite 65 von 197  
Page 65 of 197

**Data Rate: MCS4**

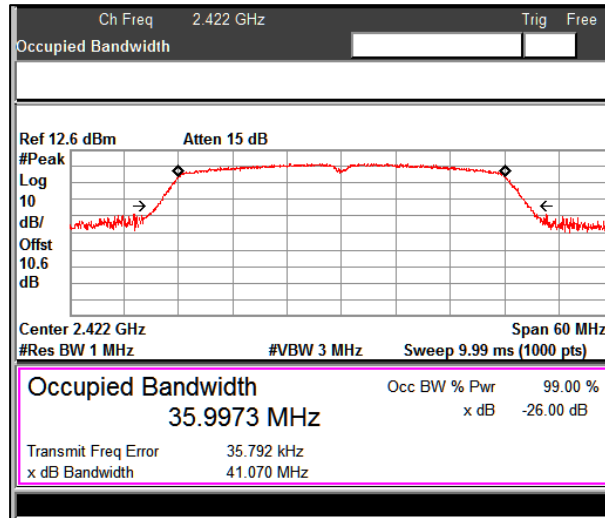

Channel Frequency 2422MHz

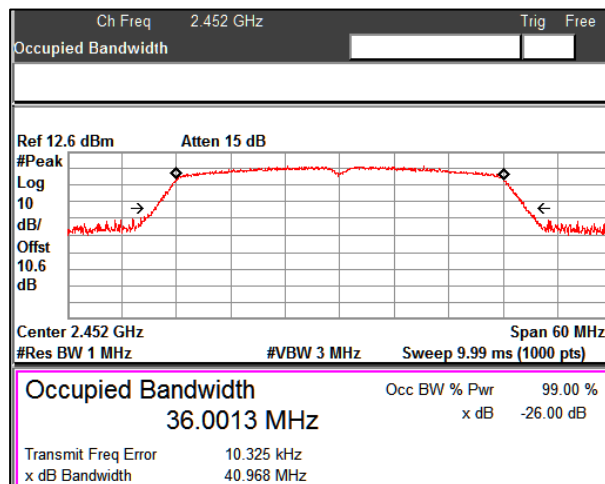

Channel Frequency 2452MHz

**Data Rate: MCS7**

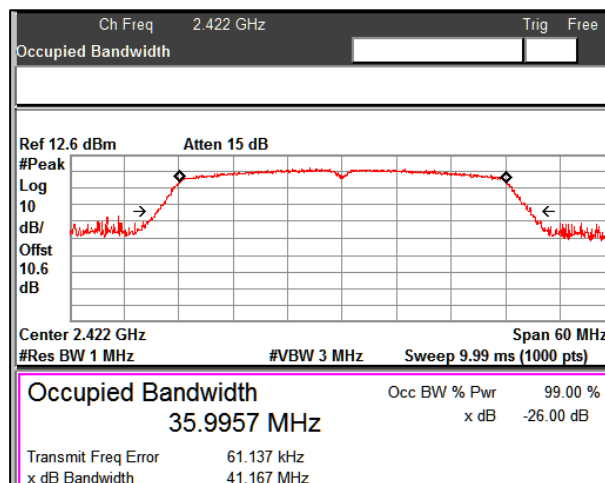

Channel Frequency 2422MHz

**Prüfbericht - Nr.:**  
Test Report No.:

**IN22T1OT 001**  
**ULR-TC568822300000100F**

Seite 66 von 197  
Page 66 of 197

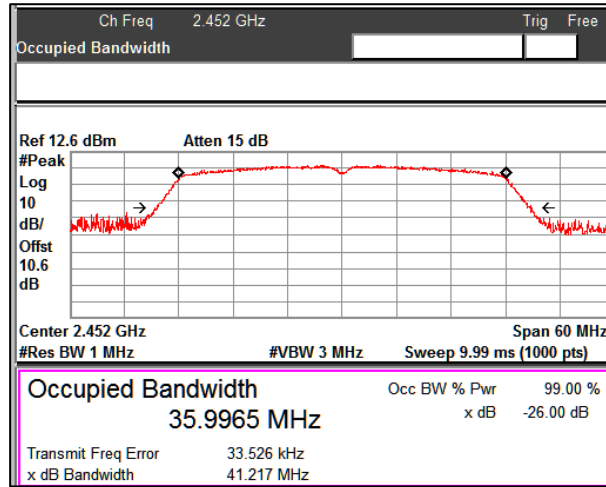

Channel Frequency 2452MHz

**Prüfbericht - Nr.:**  
Test Report No.:

**IN22T1OT 001**  
**ULR-TC568822300000100F**

Seite 67 von 197  
Page 67 of 197

## 7.4 Emissions in non-restricted frequency bands and Conducted Spurious Emission

**Result**

**Pass**

Test Specification FCC part 15 Subpart C 15.247 (d) / RSS 247 Issue 2, Section 5.5

Test Method Subclause 11.11 of ANSI C63.10

Measurement Bandwidth 100 kHz

Detector Peak

Port of testing Antenna port

Requirement

In any 100kHz bandwidth outside the frequency band in which the spread spectrum or digitally modulated intentional radiator is operating, the radio frequency power that is produced by the intentional radiator shall be at least 30dB below that in the 100kHz bandwidth within the band that contains the highest level of the desired power, based on either an RF conducted or a radiated measurement, provided the transmitter demonstrates compliance with the peak conducted power limits

If the transmitter complies with the conducted power limits based on the use of RMS averaging over a time interval, the attenuation required under this paragraph shall be 30 dB instead of 20 dB

### Test Method:

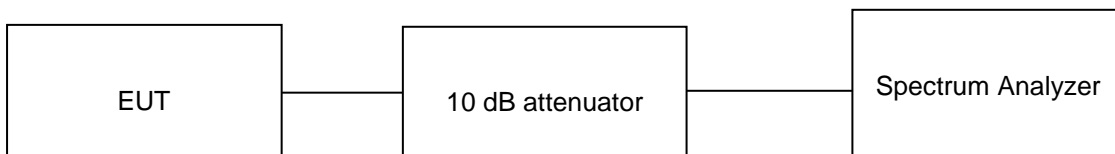

### Test Condition

#### Normal Test Condition:

Temperature (Norm) = +25 °C

Voltage = 3.6V Li-Ion battery

Relative humidity: 62 %

#### KDB Guidelines applied:

Measurements were made as per section 8.5 in KDB 558074 D01 15.247 Measurement Guidance v05r02.

**Prüfbericht - Nr.:**  
Test Report No.:

**IN22T1OT 001**  
**ULR-TC568822300000100F**

Seite 68 von 197  
Page 68 of 197

**Test results:**

**Note:**

1. All the losses are included during measurement and final values are mentioned in the test report.
2. Final Value (dBm) = Measured Value (dBm) + Attenuator factor (10dB) + Cable loss (0.6dB)
3. This product do not support additional beamforming gain / directional gain, it uses signal antenna and hence directional gain of the single antenna is 2.53 dBi

**7.4.1 Band edge and reference plots**

**Modulation: 802.11b**

Data Rate	Channel Frequency (MHz)	Reference Value (B) (dBm)	Band edge Frequency (MHz)	Value at Band edge (A) (dBm)	A-B (dBc)	Minimum Limit (dBc)
1Mbps	2412	2396.4	-38.21	5.49	-43.7	-30
	2462	2483.5	-49.99	5.07	-55.06	-30
11Mbps	2412	2400	-36.83	6.66	-43.49	-30
	2462	2483.5	-51.78	6.00	-57.78	-30

**Data rate: 1Mbps**

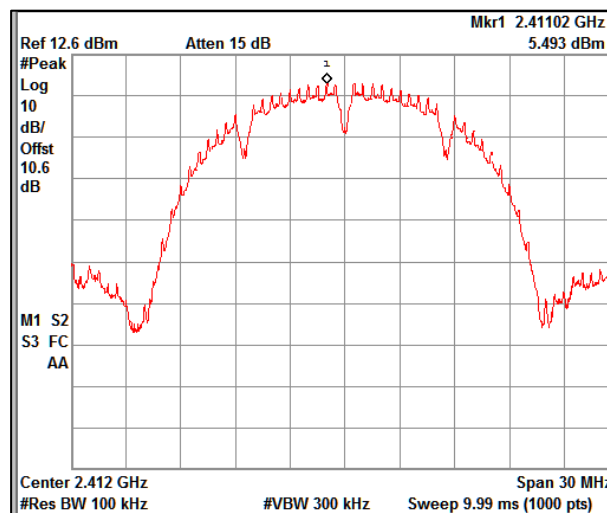

Reference plot for 2412MHz

**Prüfbericht - Nr.:**  
Test Report No.:

**IN22T1OT 001**  
**ULR-TC568822300000100F**

Seite 69 von 197  
Page 69 of 197

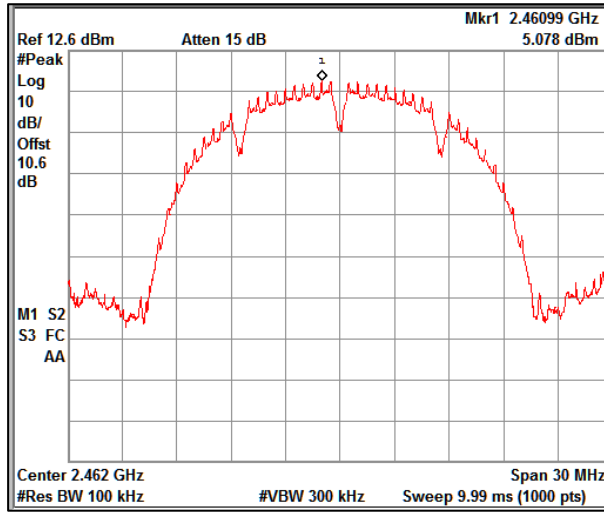

Reference plot for 2462MHz

Data rate: 11Mbps

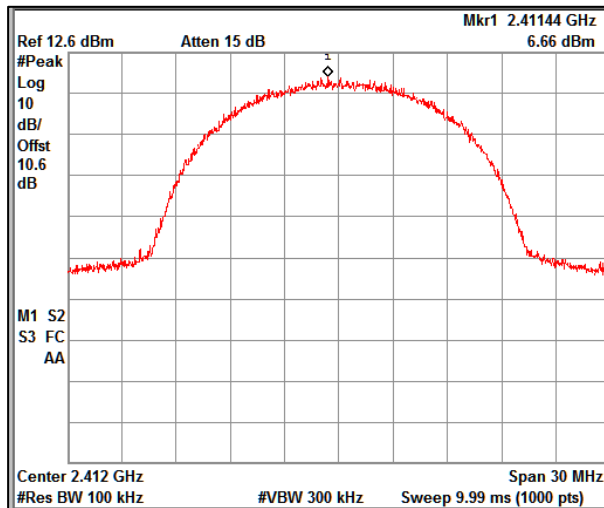

Reference plot for 2412MHz

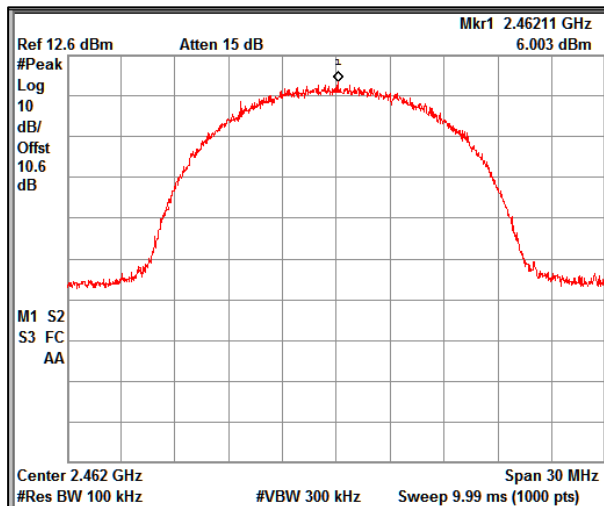

Reference plot for 2462MHz

Data rate: 1Mbps

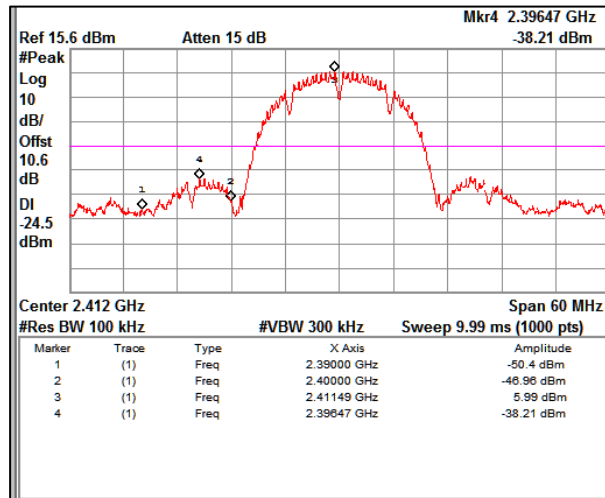

Band edge Channel Frequency 2412MHz

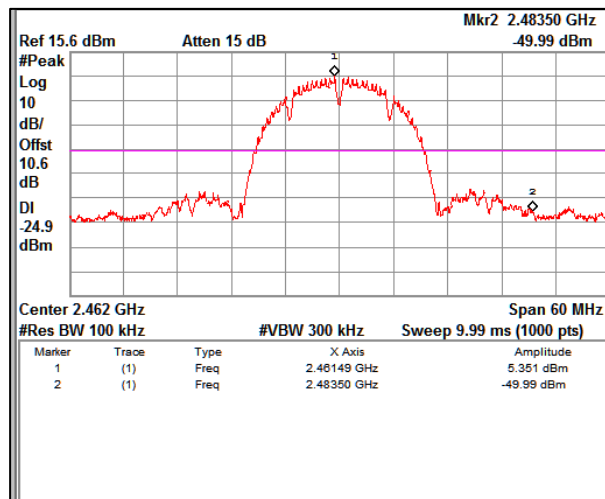

Band edge Channel Frequency 2462MHz

Data rate: 11Mbps

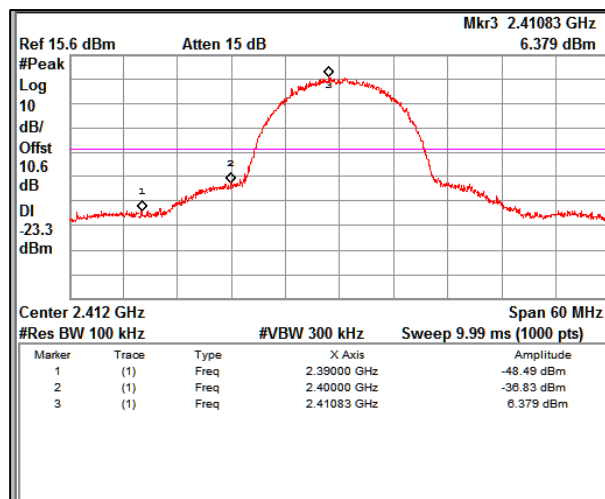

Band edge Channel Frequency 2412MHz

**Prüfbericht - Nr.:**  
Test Report No.:

**IN22T1OT 001**  
**ULR-TC568822300000100F**

Seite 71 von 197  
Page 71 of 197

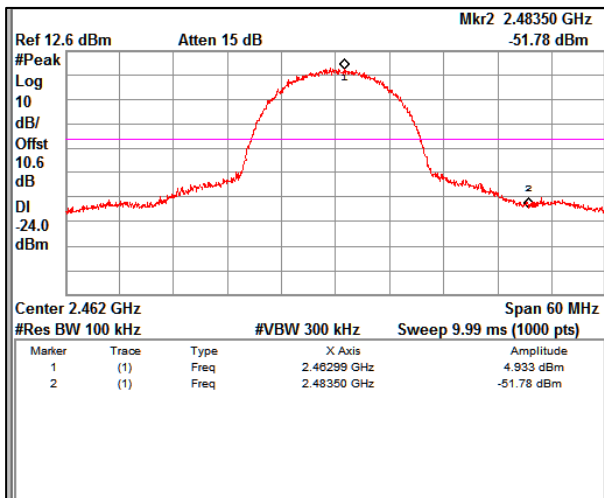

Band edge Channel Frequency 2462MHz

Modulation: 802.11b

Data Rate	Channel Frequency (MHz)	Reference Value (B) (dBm)	Band edge Frequency (MHz)	Value at Band edge (A) (dBm)	A-B (dBc)	Minimum Limit (dBc)
6Mbps	2412	2398.2	-32.21	1.10	-33.31	-30
	2462	2483.5	-49.44	-0.60	-48.84	-30
24Mbps	2412	2398.2	-33.43	-0.33	-33.10	-30
	2462	2483.5	-47.32	-0.84	-46.48	-30
54Mbps	2412	2400	-35.15	-0.03	-35.12	-30
	2462	2483.5	-47.22	-0.69	-46.53	-30

Data rate: 6Mbps

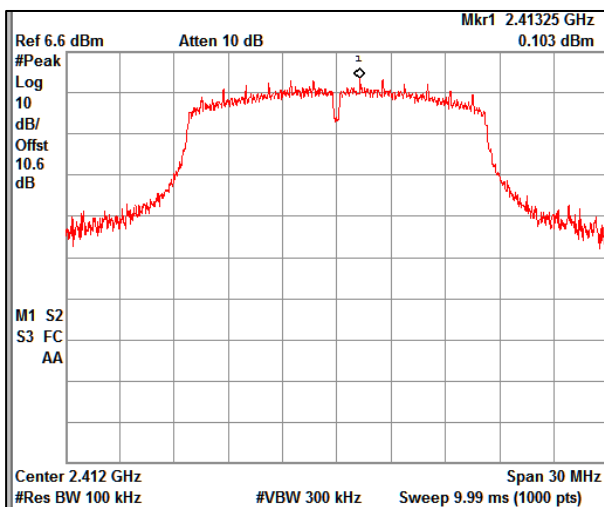

Reference plot for 2412MHz

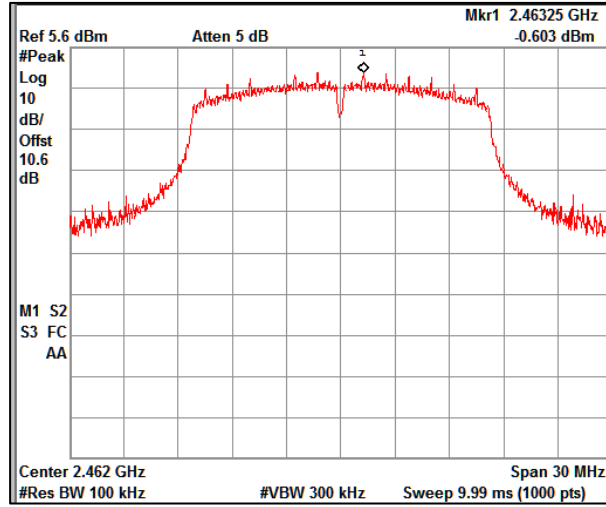

Data rate: 24Mbps

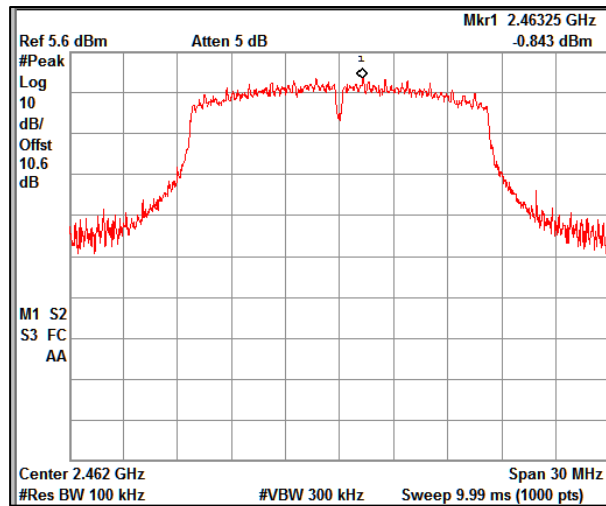
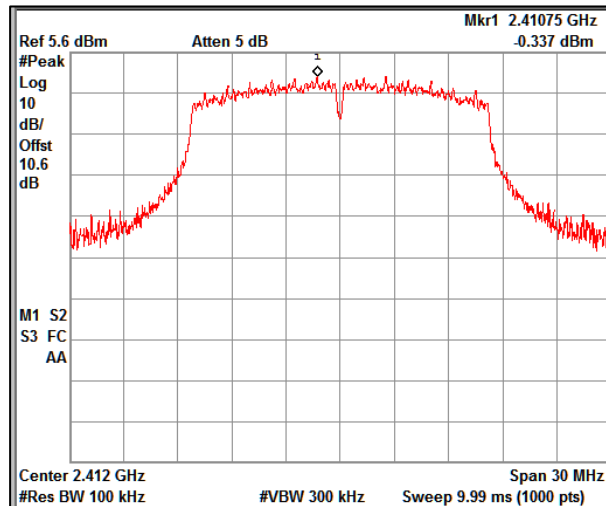



Data rate: 54Mbps

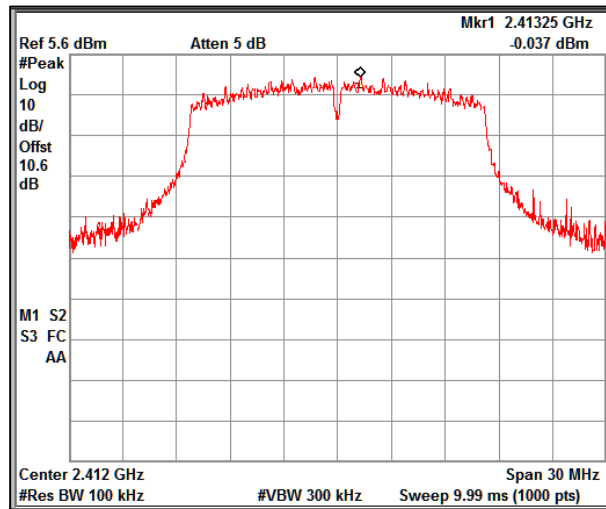

Reference plot for 2412MHz

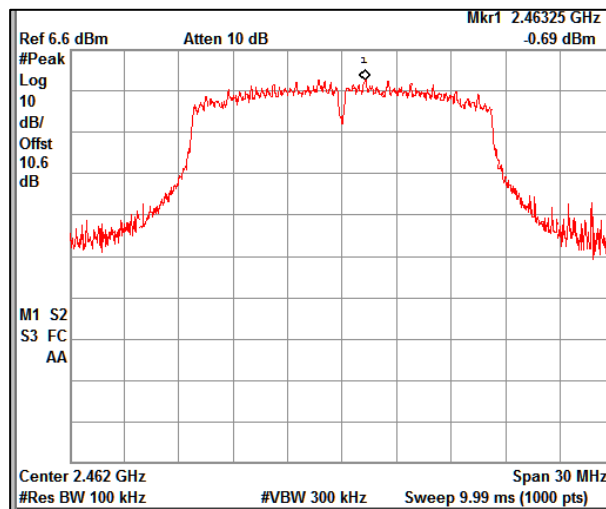

Reference plot for 2462MHz

Data rate: 6Mbps

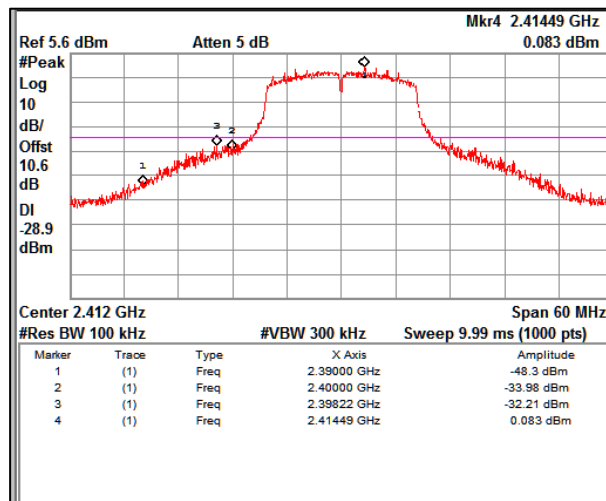

Band edge Channel Frequency 2412MHz

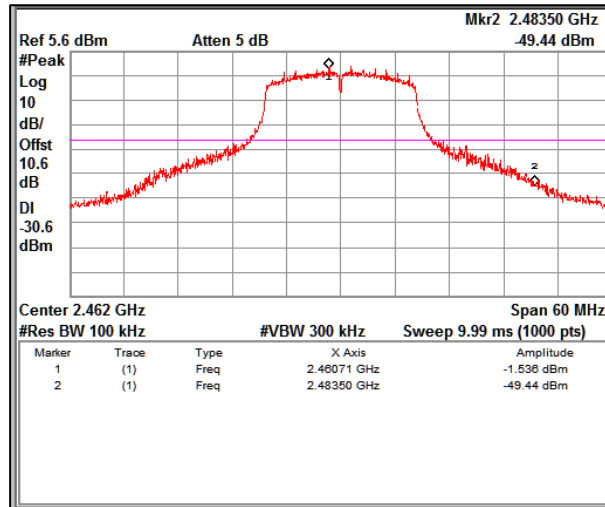

Band edge Channel Frequency 2462MHz

Data rate: 24Mbps

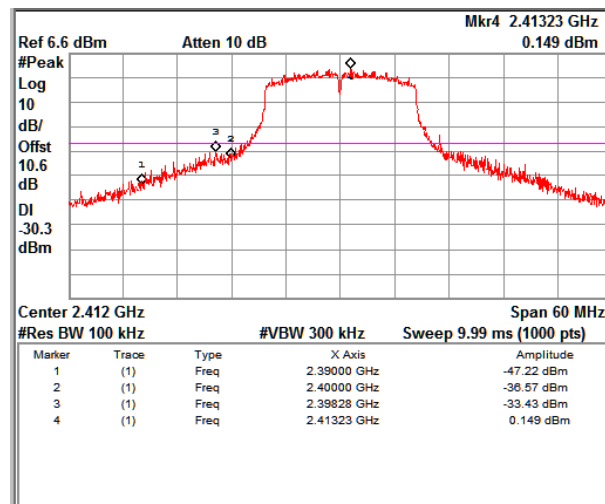

Band edge Channel Frequency 2412MHz

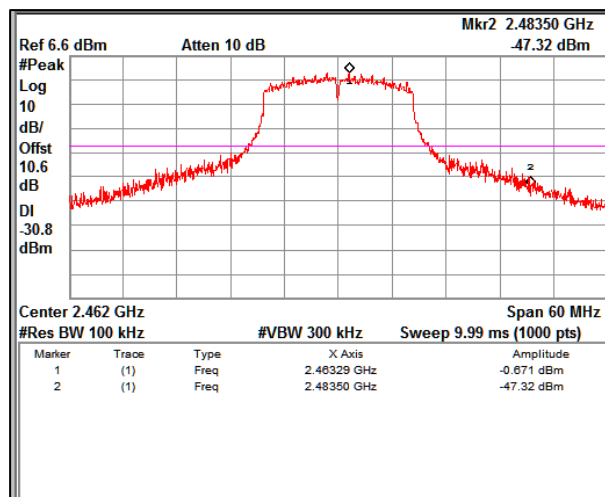

Band edge Channel Frequency 2462MHz

**Prüfbericht - Nr.:**  
Test Report No.:

**IN22T1OT 001**  
**ULR-TC568822300000100F**

Seite 75 von 197  
Page 75 of 197

Data rate: 54Mbps

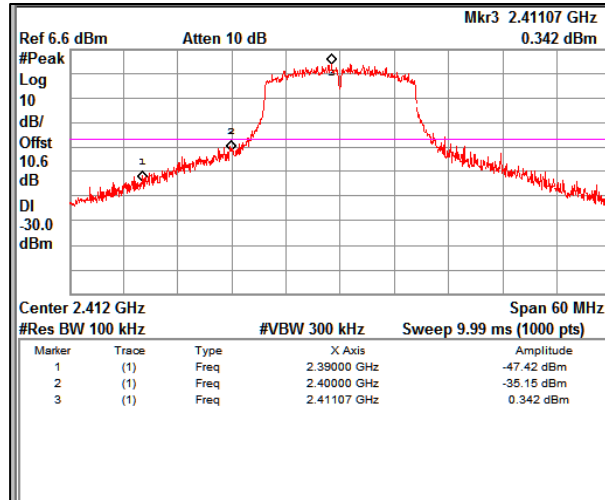

Band edge Channel Frequency 2412MHz

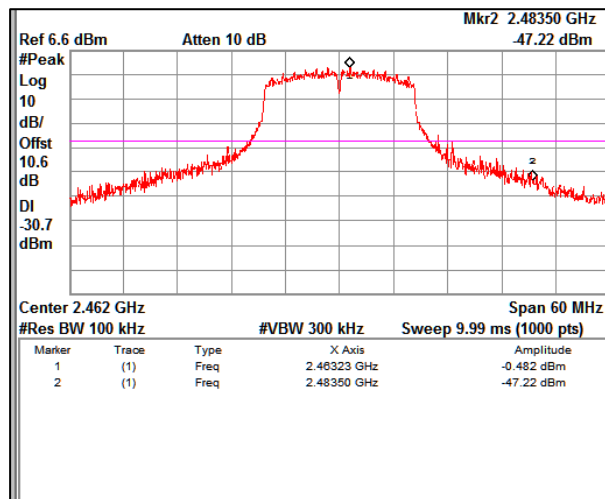

Band edge Channel Frequency 2462MHz

**Prüfbericht - Nr.:**  
Test Report No.:

**IN22T1OT 001**  
**ULR-TC568822300000100F**

Seite 76 von 197  
Page 76 of 197

**Modulation: 802.11n HT20**

Data Rate	Channel Frequency (MHz)	Reference Value (B) (dBm)	Band edge Frequency (MHz)	Value at Band edge (A) (dBm)	A-B (dB)	Minimum Limit (dB)
MCS0	2412	2400	-34.00	0.03	-34.03	-30
	2462	2483.5	-47.05	-0.27	-46.78	-30
MCS4	2412	2400	-35.78	0.51	-36.29	-30
	2462	2483.5	-50.50	-0.25	-50.25	-30
MCS7	2412	2400	-33.96	0.46	-34.42	-30
	2462	2483.5	-46.09	-0.20	-45.89	-30

**Data rate: MCS0**

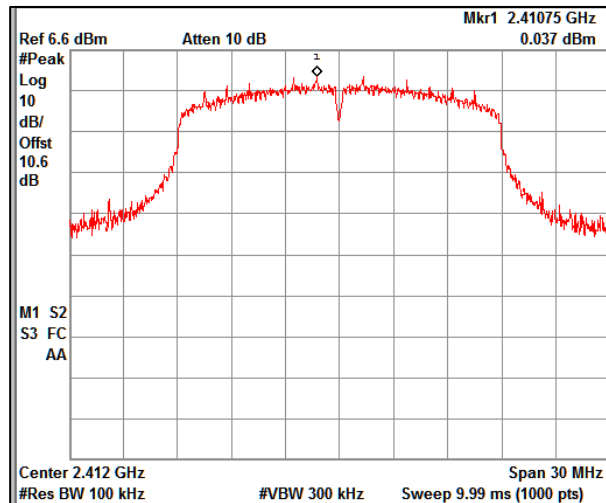

Reference plot for 2412MHz

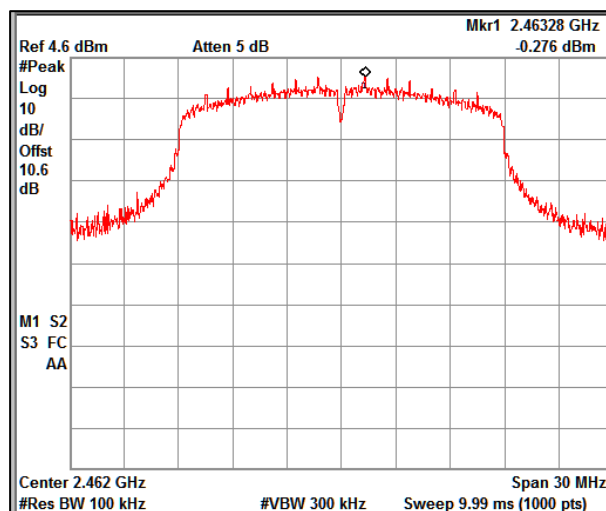

Reference plot for 2462MHz

**Prüfbericht - Nr.:**  
Test Report No.:

**IN22T1OT 001**  
**ULR-TC568822300000100F**

Seite 77 von 197  
Page 77 of 197

Data rate: MCS4

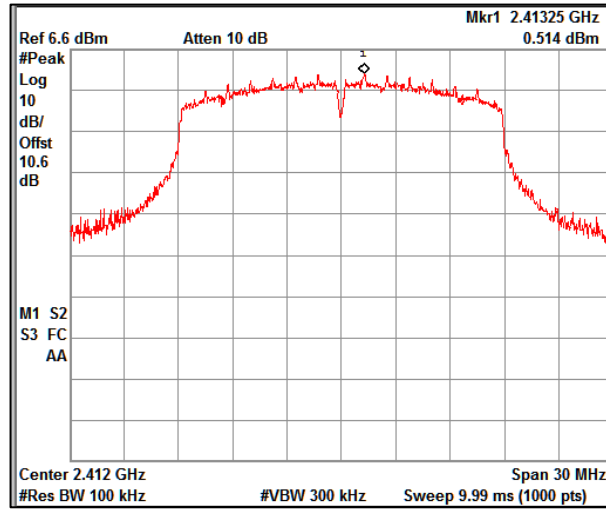

Reference plot for 2412MHz

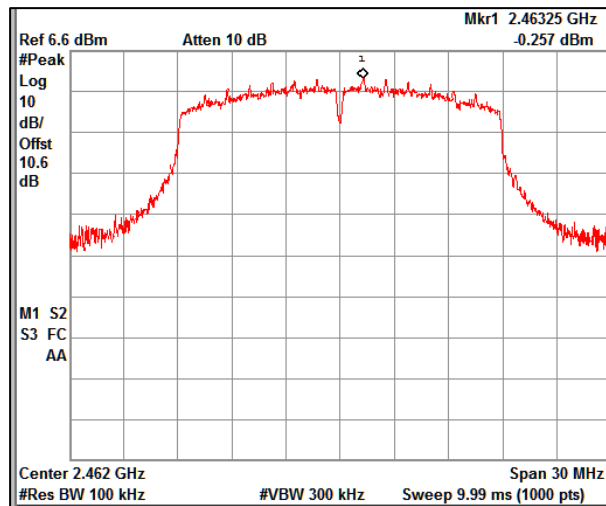

Reference plot for 2462MHz

Data rate: MCS7

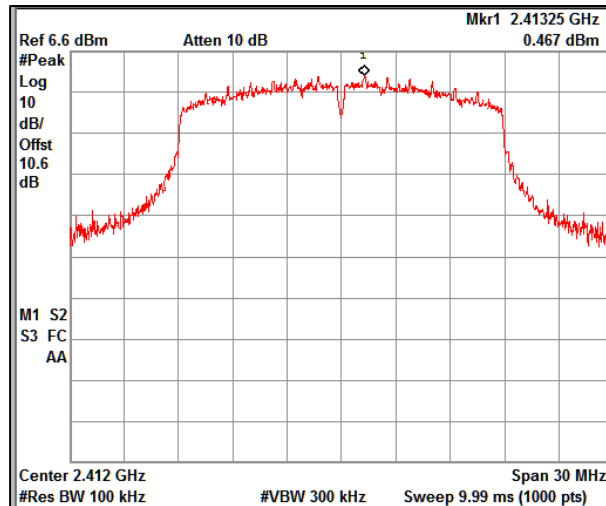

Reference plot for 2412MHz

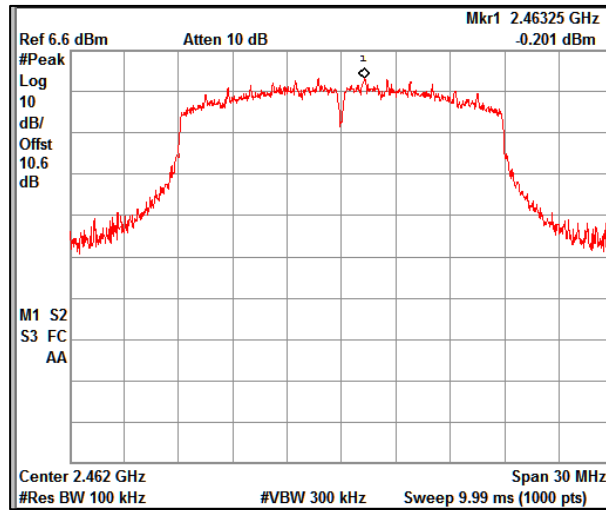

Reference plot for 2462MHz

Data rate: MCS0

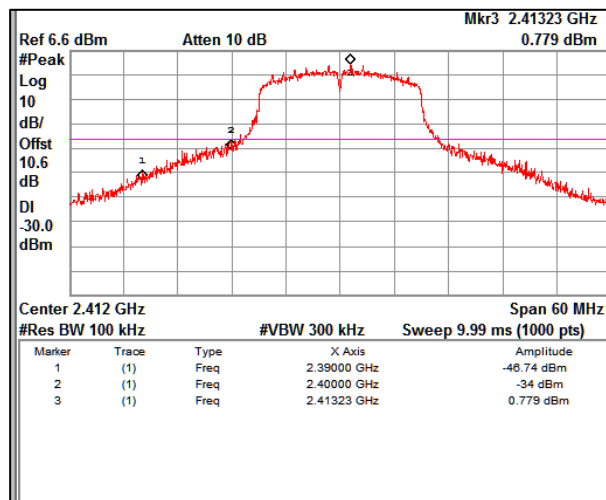

Band edge Channel Frequency 2412MHz

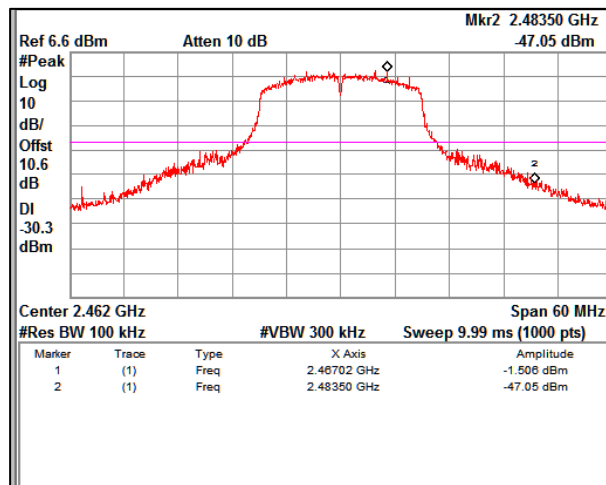

Band edge Channel Frequency 2462MHz

Data rate: MCS4

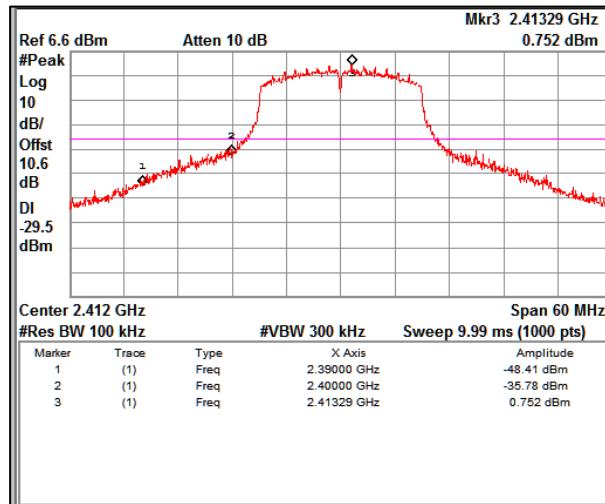

Band edge Channel Frequency 2412MHz

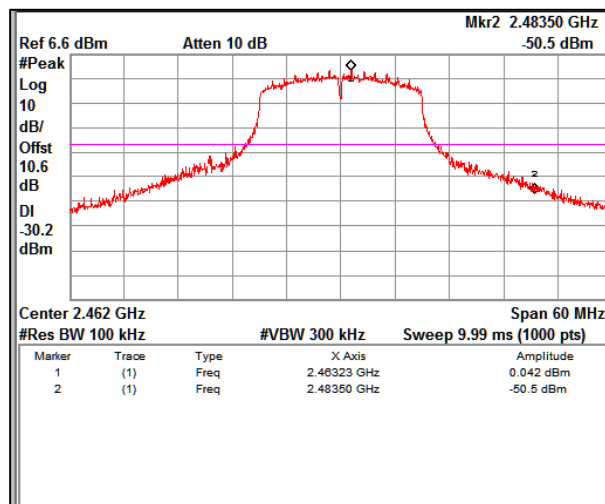

Band edge Channel Frequency 2462MHz

Data rate: MCS7

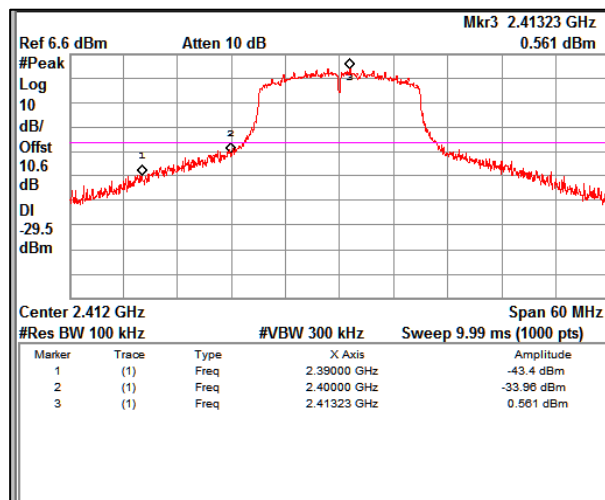

Band edge Channel Frequency 2412MHz

**Prüfbericht - Nr.:**  
Test Report No.:

**IN22T1OT 001**  
**ULR-TC568822300000100F**

Seite 80 von 197  
Page 80 of 197

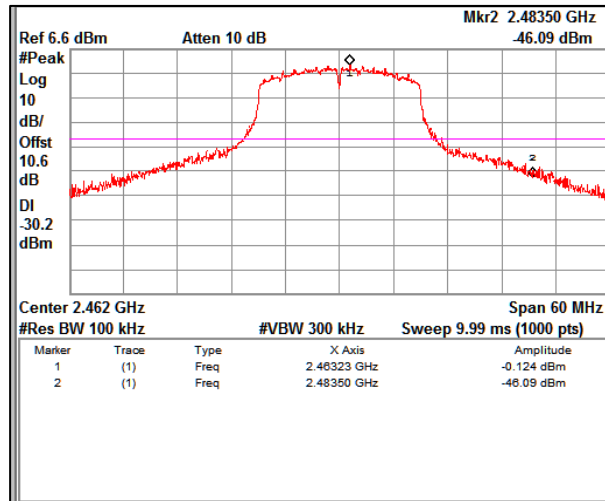

Band edge Channel Frequency 2462MHz

Modulation: 802.11n HT40

Data Rate	Channel Frequency (MHz)	Reference Value (B) (dBm)	Band edge Frequency (MHz)	Value at Band edge (A) (dBm)	A-B (dBc)	Minimum Limit (dBc)
MCS0	2422	2395.8	-39.75	-4.86	-34.89	-30
	2452	2483.5	-47.03	-4.88	-42.15	-30
MCS4	2422	2400	-43.13	-4.40	-38.73	-30
	2452	2483.5	-49.77	-4.82	-44.95	-30
MCS7	2422	2396.2	-41.16	-4.54	-36.62	-30
	2452	2483.5	-47.90	-4.84	-43.06	-30

Data rate: MCS0

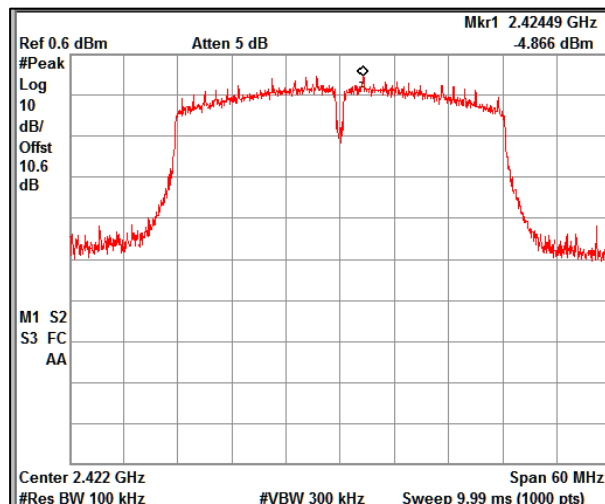

Reference plot for 2422MHz







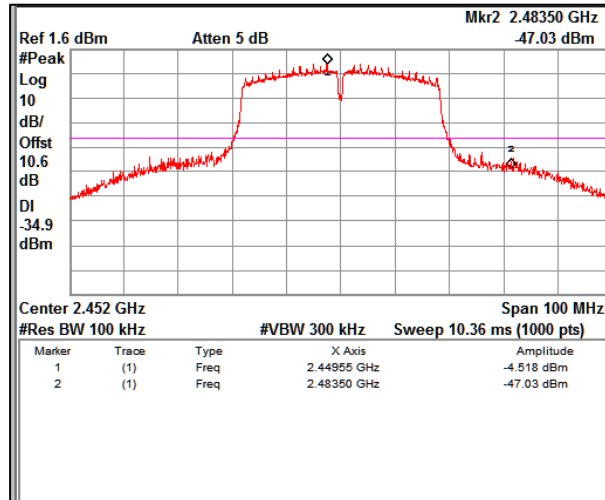

Band edge Channel Frequency 2452MHz

Data rate: MCS4

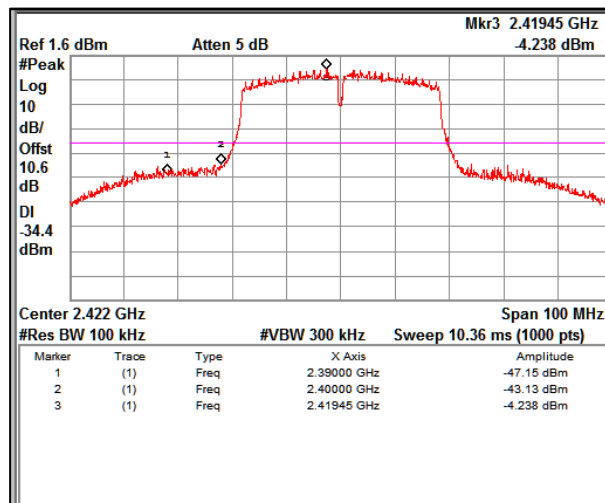

Band edge Channel Frequency 2422MHz

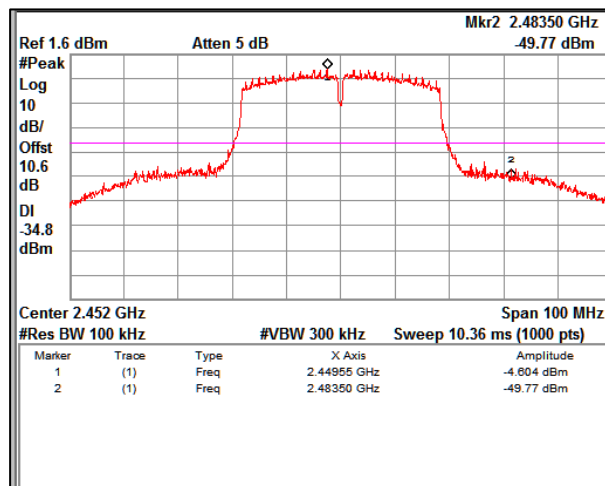

Band edge Channel Frequency 2452MHz

Data rate: MCS7

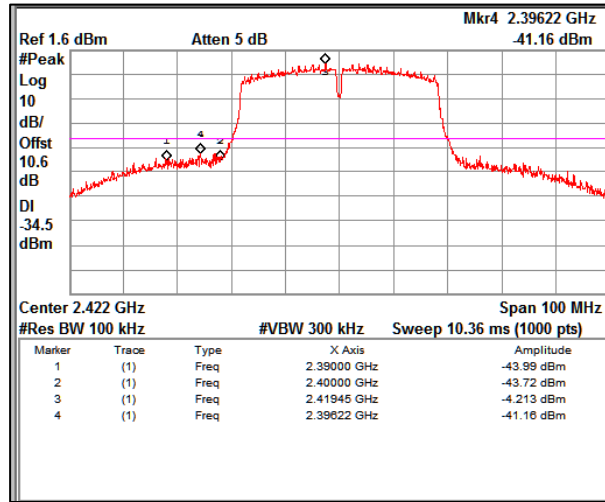

Band edge Channel Frequency 2422MHz

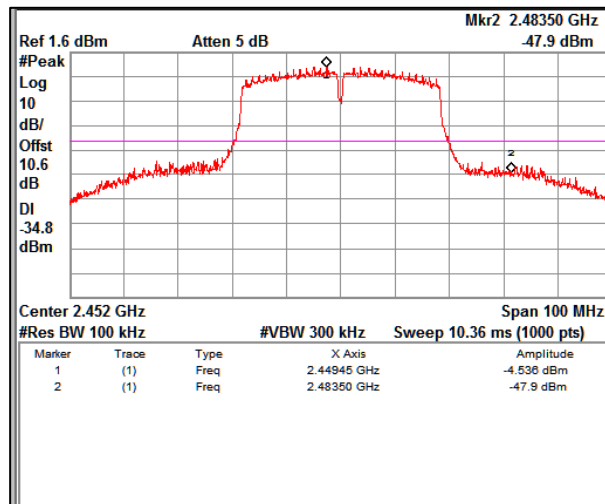

Band edge Channel Frequency 2452MHz

Prüfbericht - Nr.:  
Test Report No.:

IN22T1OT 001  
ULR-TC568822300000100F

Seite 85 von 197  
Page 85 of 197

### 7.4.2 Out-Of-Band Emissions

Modulation: 802.11b

Data rate 1Mbps

Channel Frequency 2412MHz

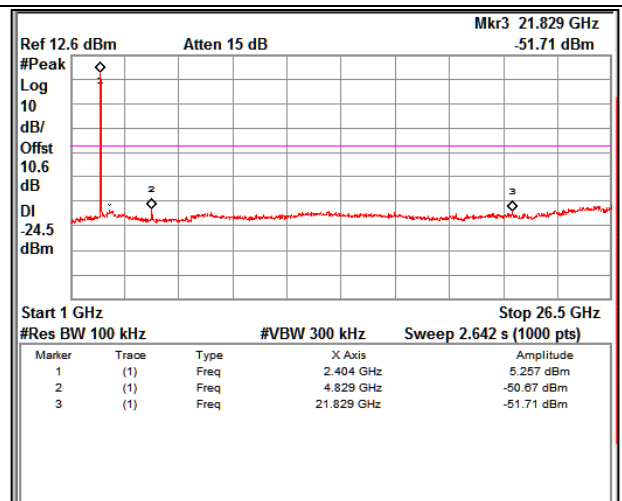
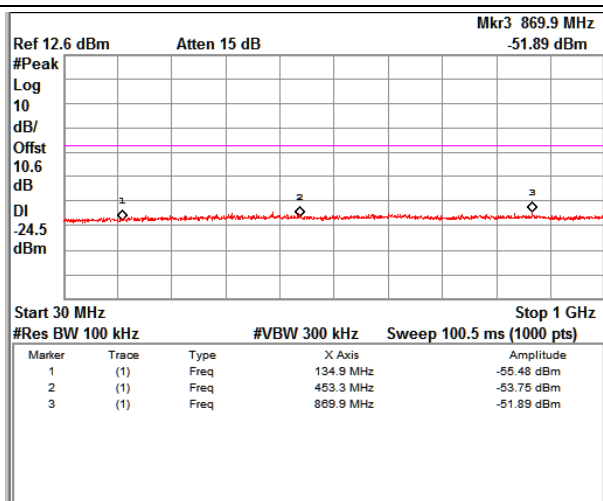
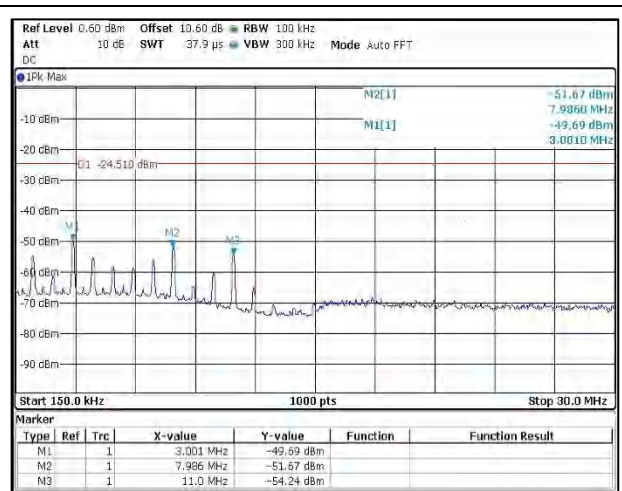
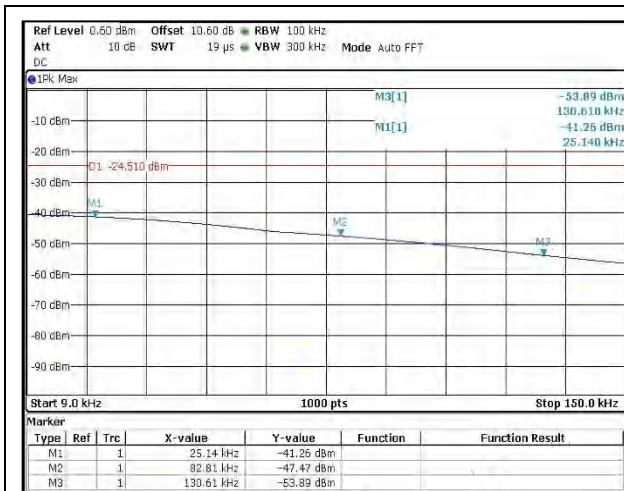

Channel Frequency 2437MHz

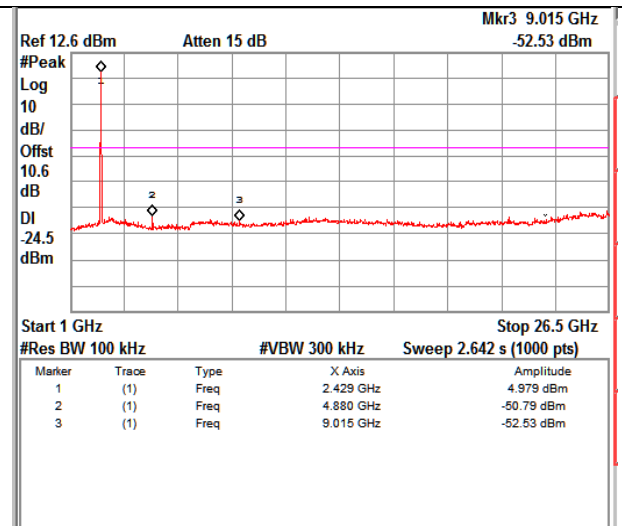
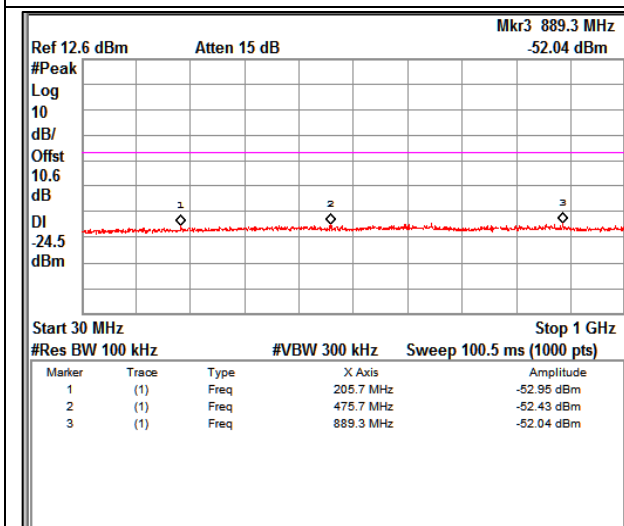
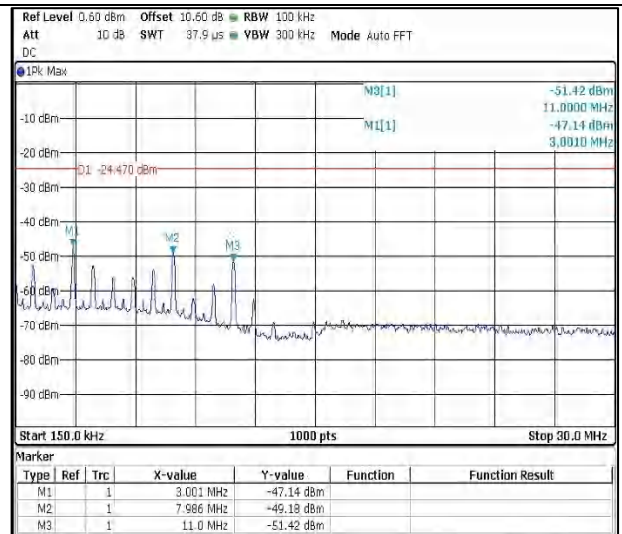
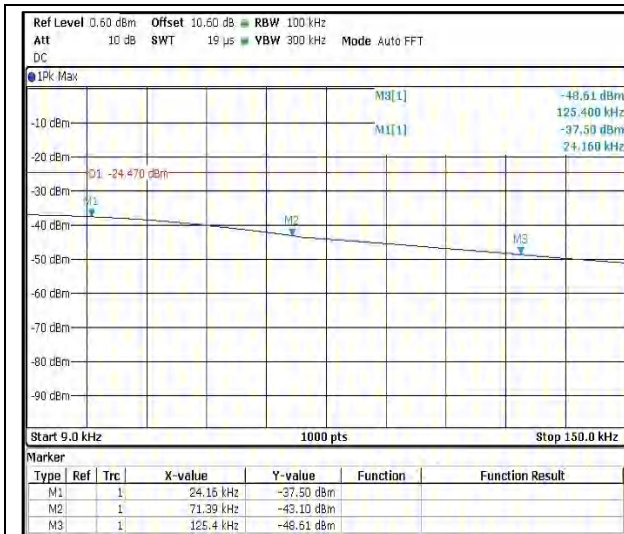

Prüfbericht - Nr.:  
Test Report No.:

IN22T1OT 001  
ULR-TC568822300000100F

Seite 87 von 197  
Page 87 of 197

Channel Frequency 2462MHz

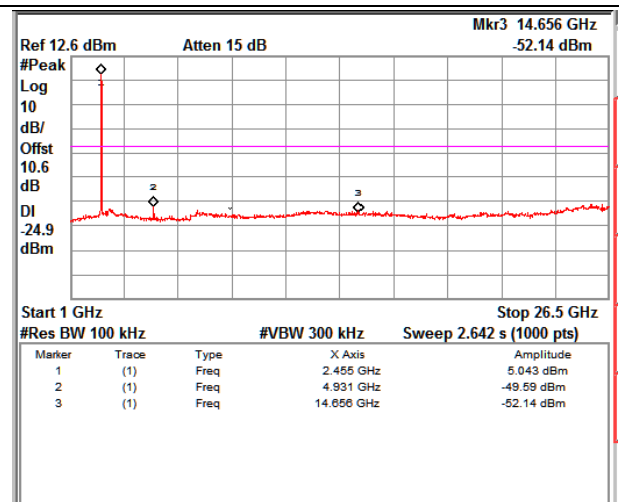
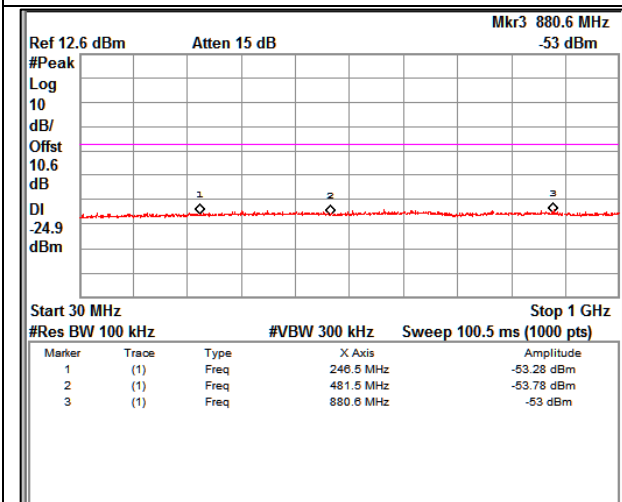
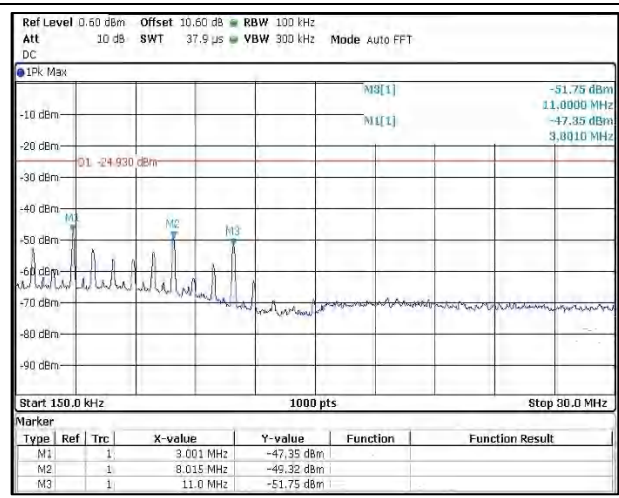
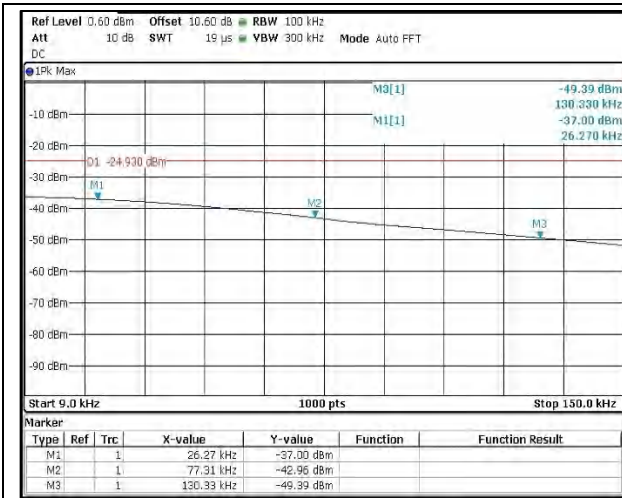

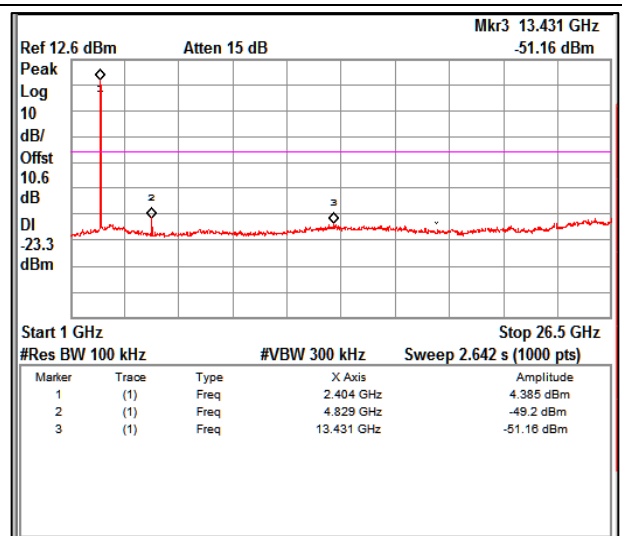
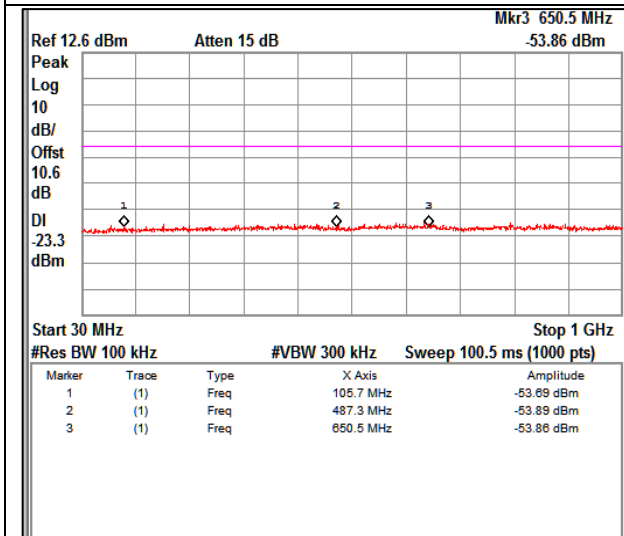
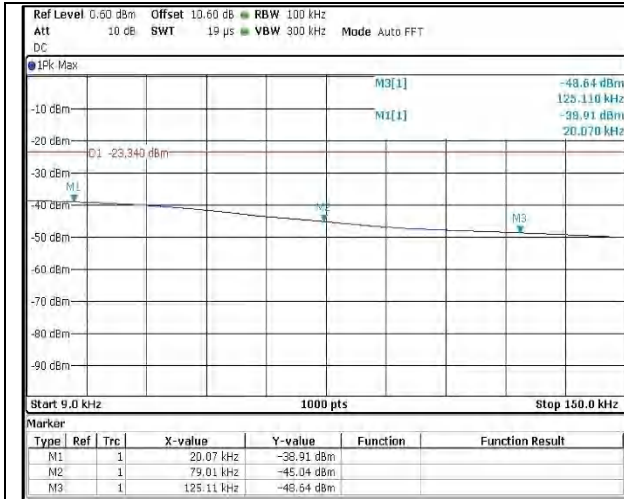
**Modulation: 802.11b**
**Data rate 11Mbps**
**Channel Frequency 2412MHz**



Prüfbericht - Nr.:  
Test Report No.:

IN22T1OT 001  
ULR-TC568822300000100F

Seite 89 von 197  
Page 89 of 197

Channel Frequency 2437MHz

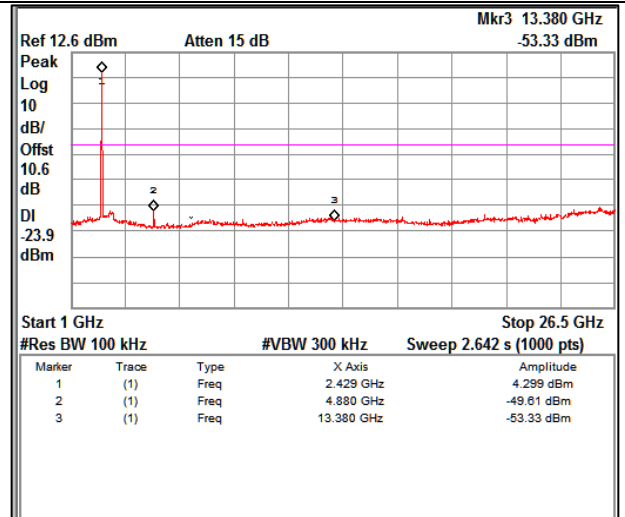
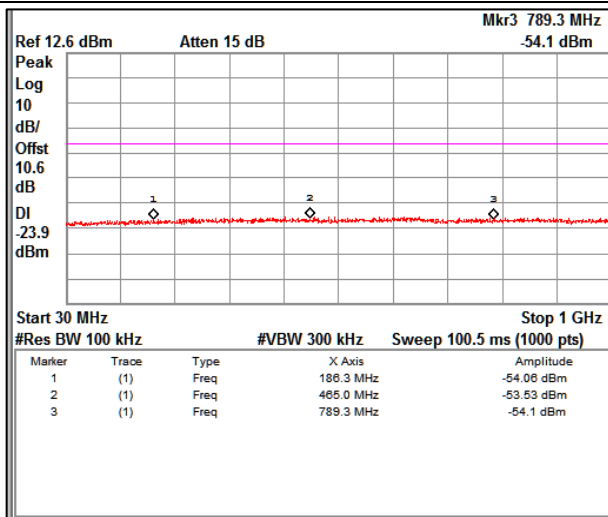
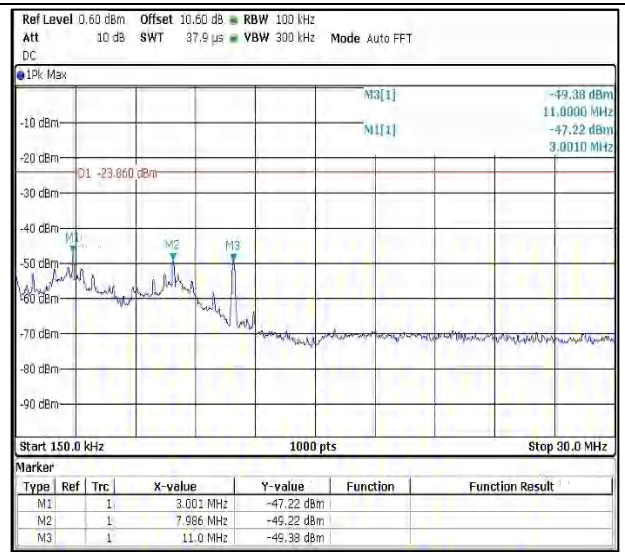
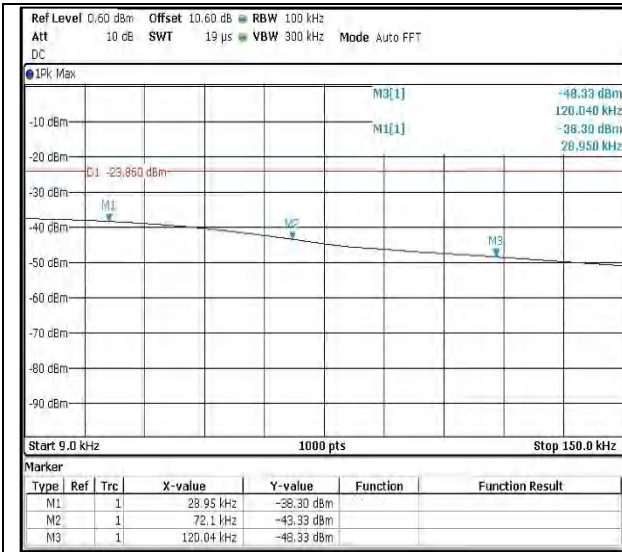

Channel Frequency 2462MHz

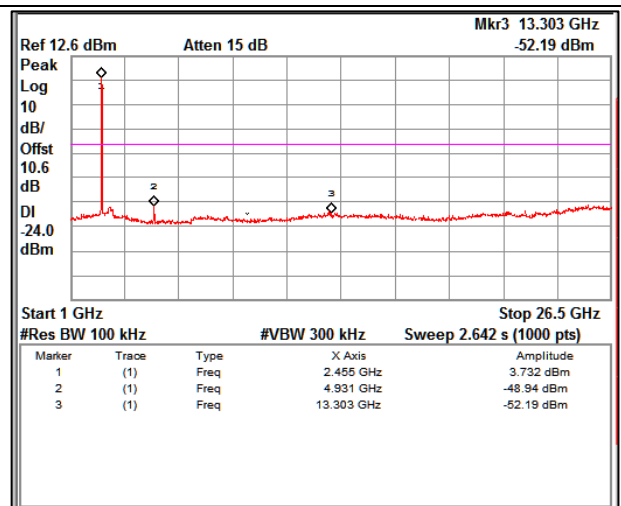
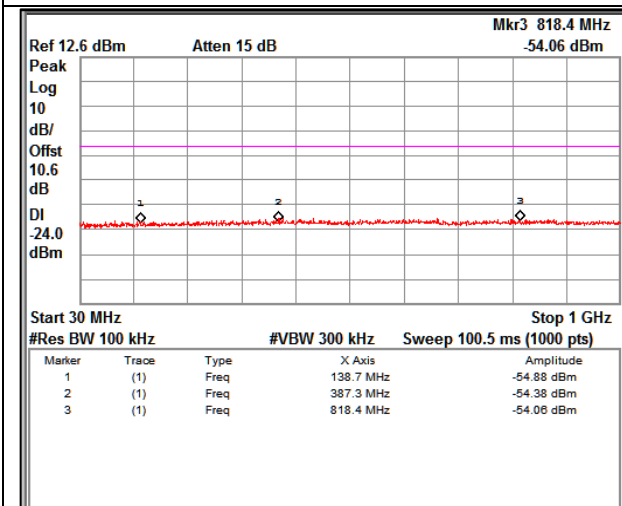
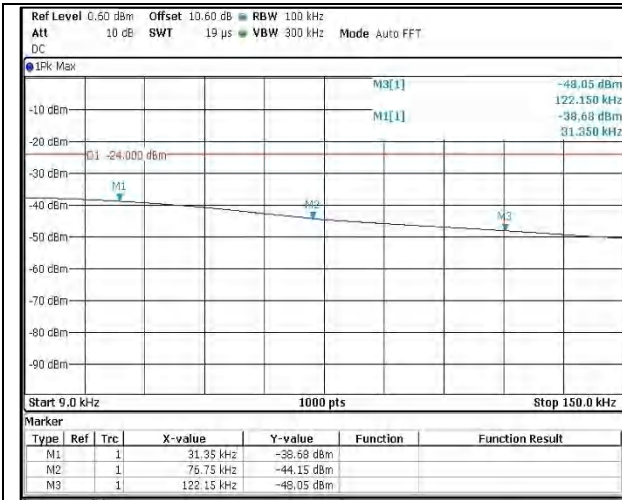

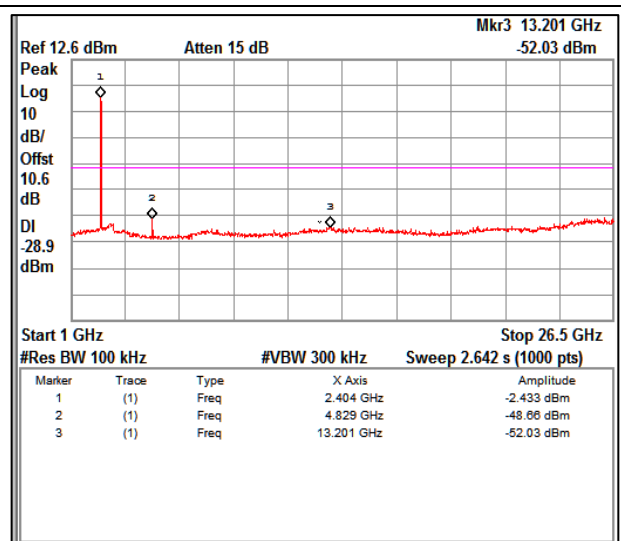
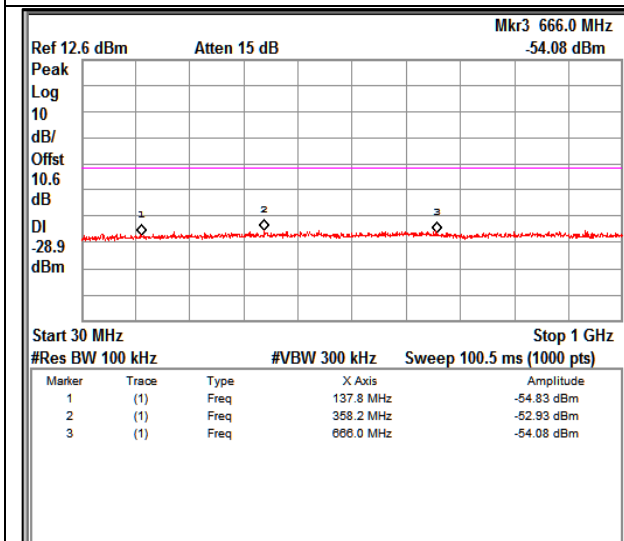
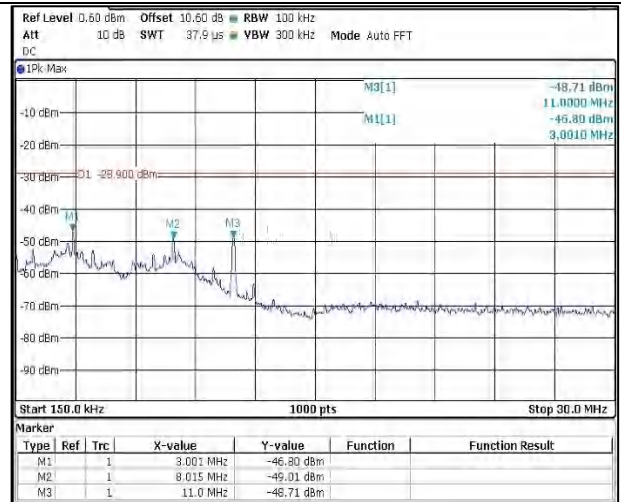
**Modulation: 802.11g**
**Data rate 6Mbps**
**Channel Frequency 2412MHz**

Channel Frequency 2437MHz

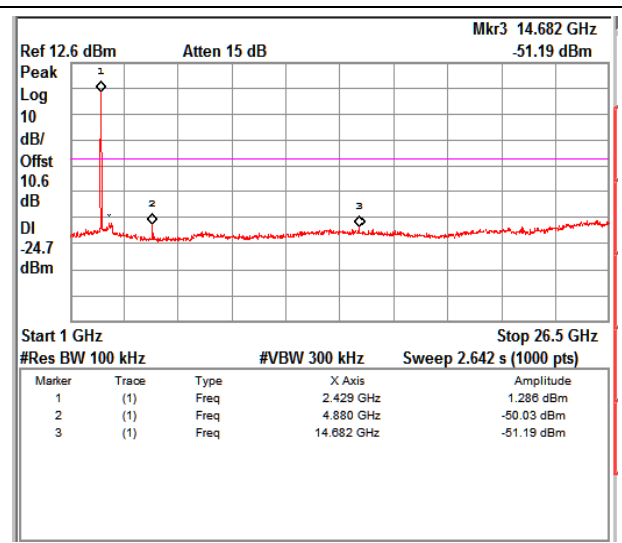
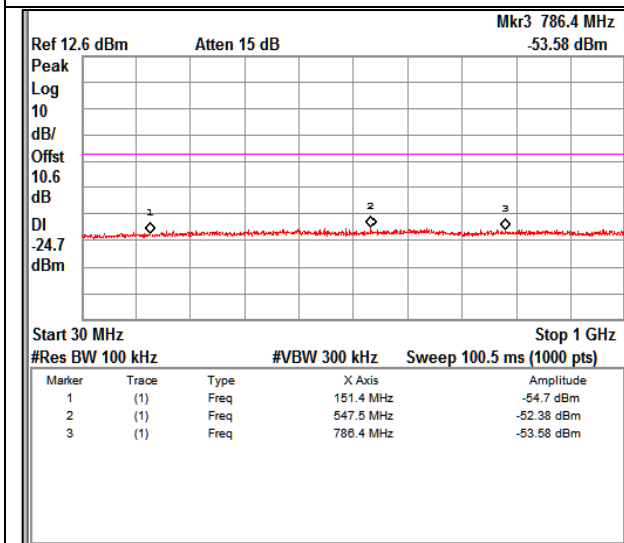
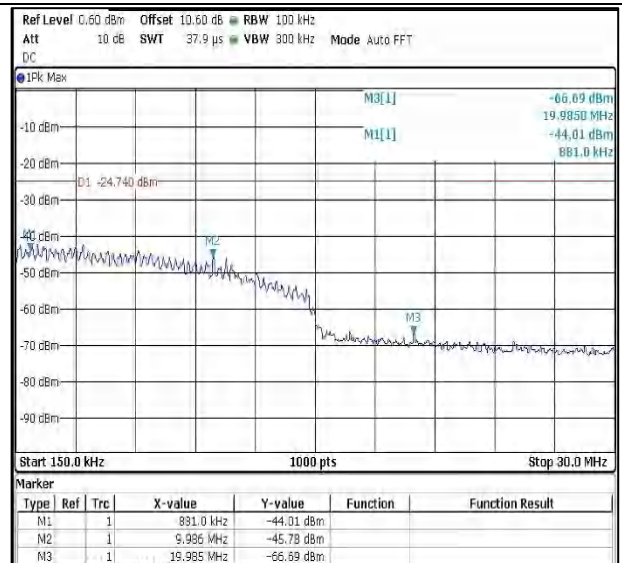
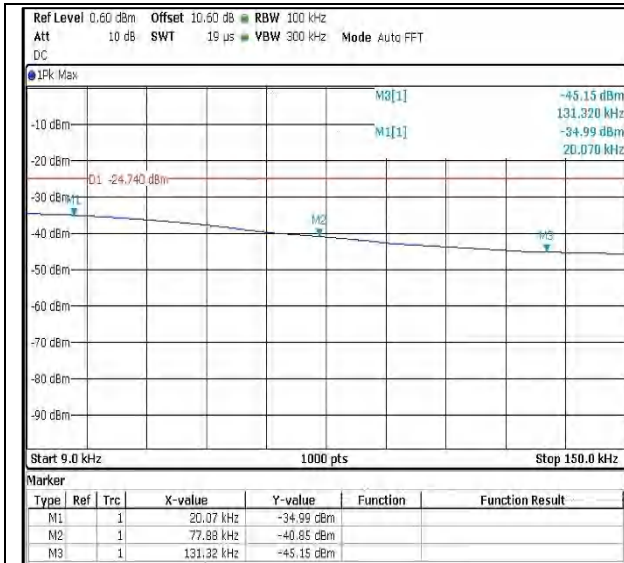

Prüfbericht - Nr.:  
Test Report No.:

IN22T1OT 001  
ULR-TC568822300000100F

Seite 93 von 197  
Page 93 of 197

Channel Frequency 2462MHz

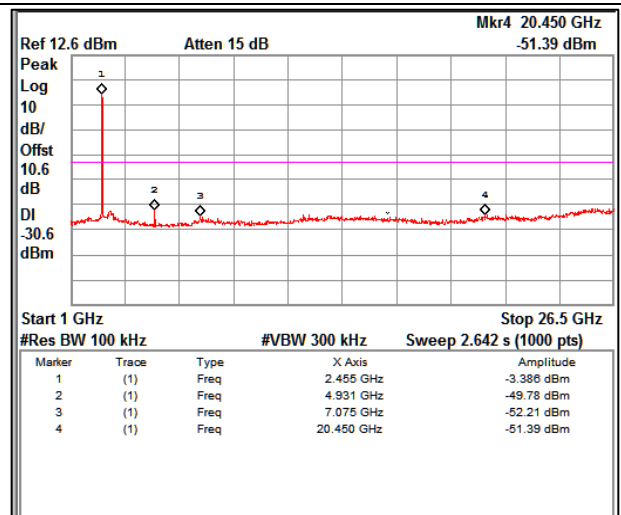
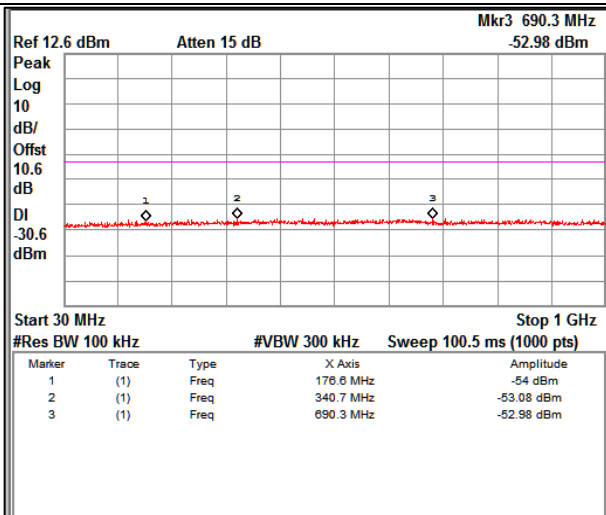
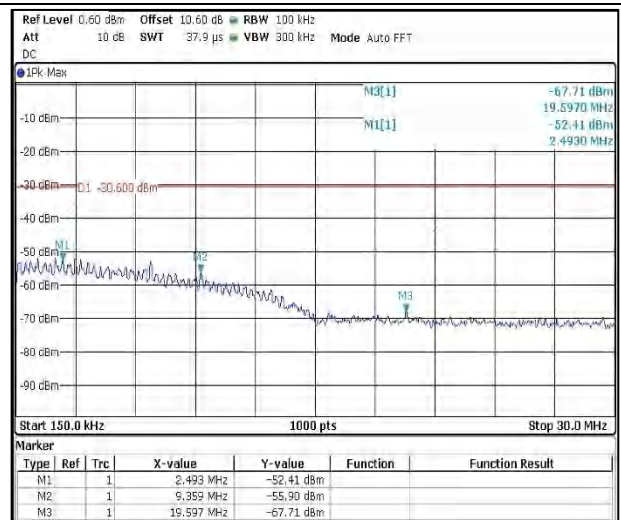
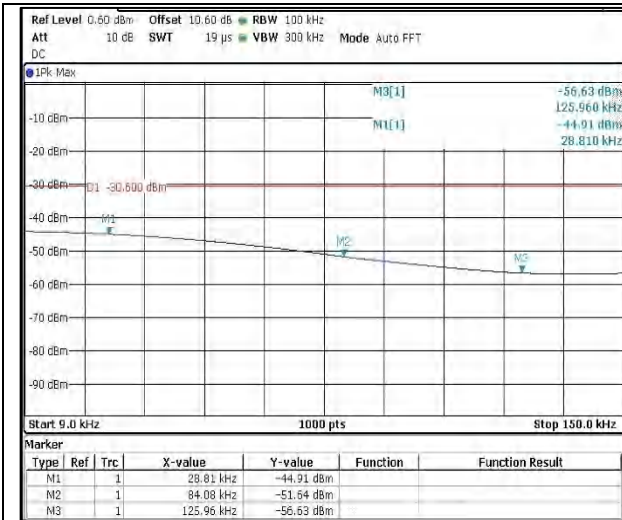

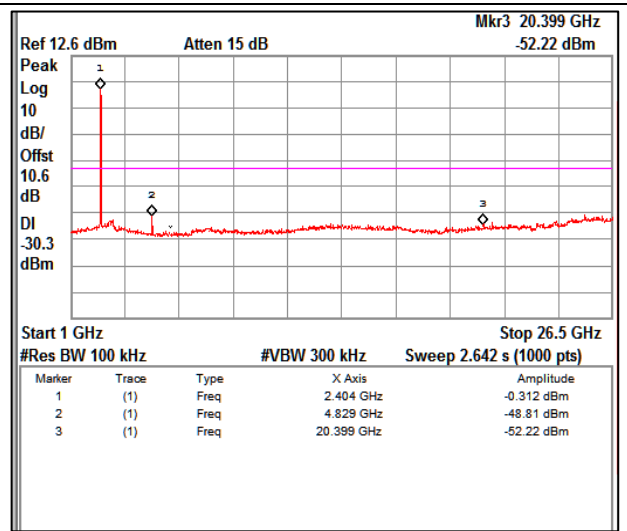
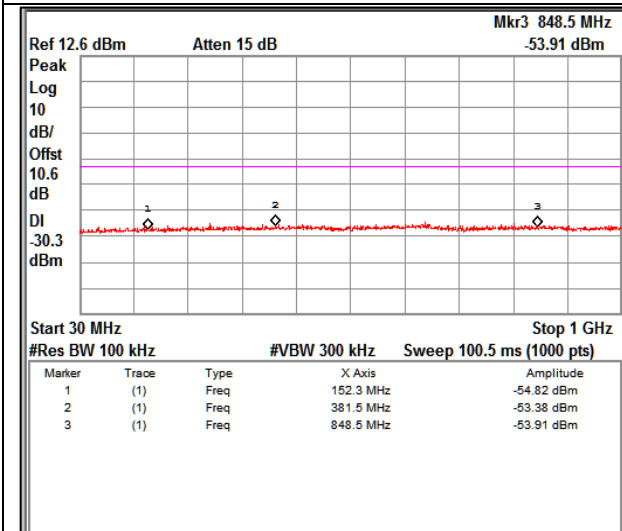
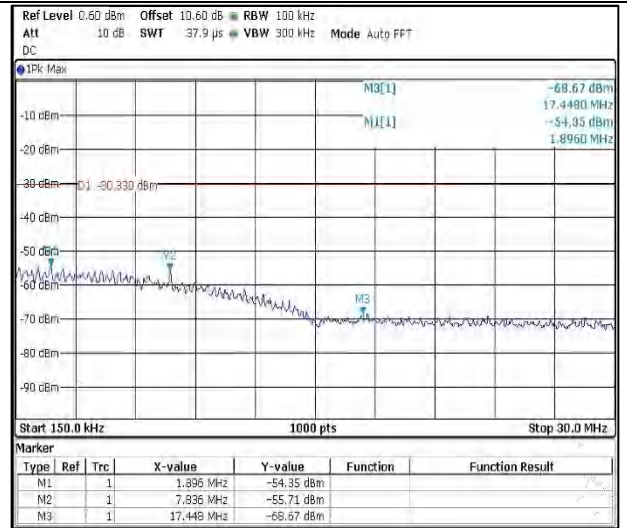
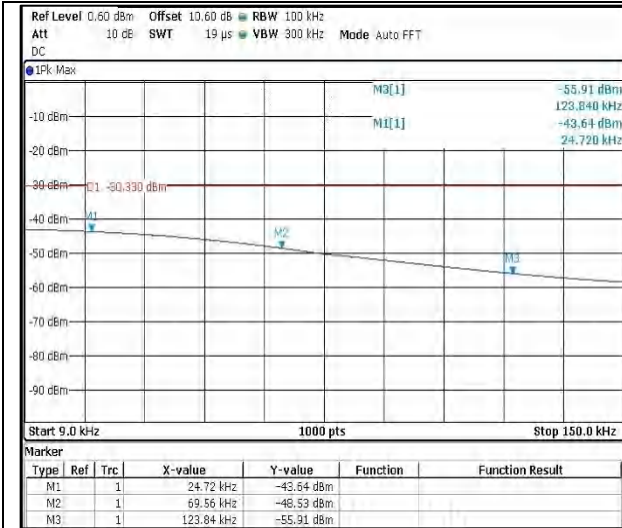
**Modulation: 802.11g**
**Data rate 24Mbps**
**Channel Frequency 2412MHz**



Channel Frequency 2437MHz

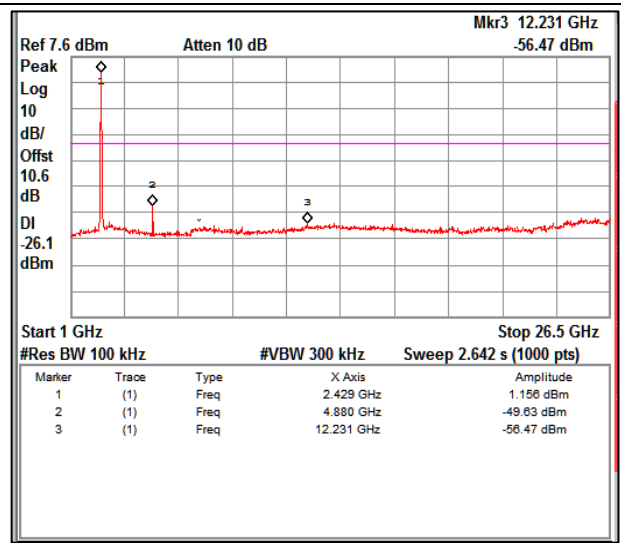
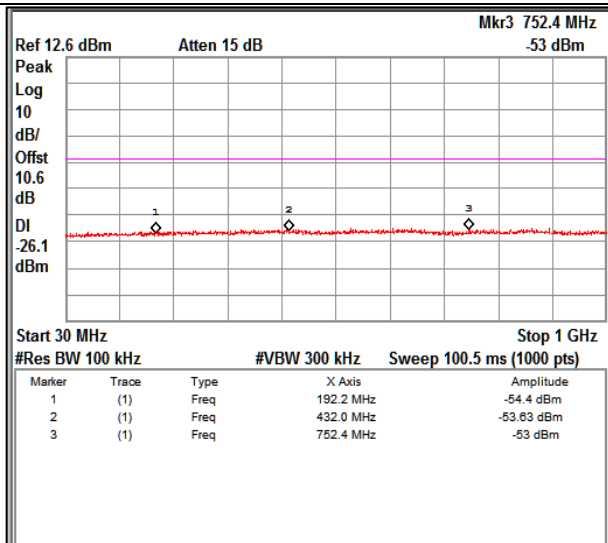
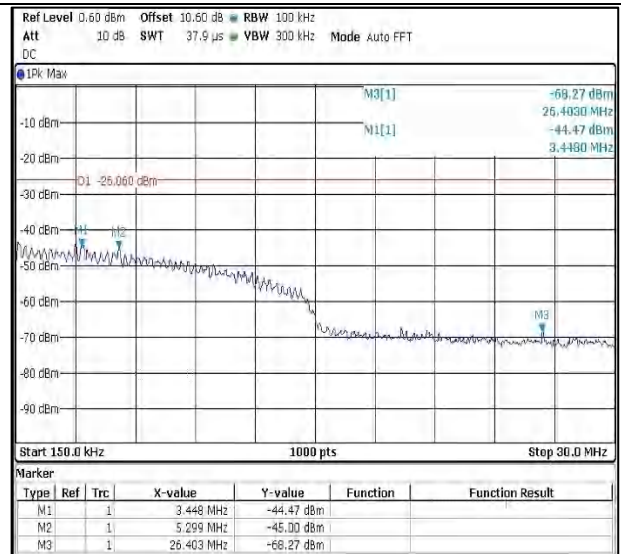
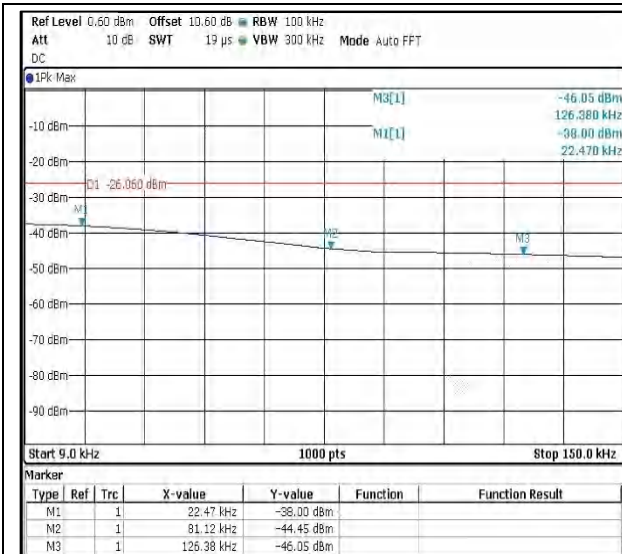

Channel Frequency 2462MHz

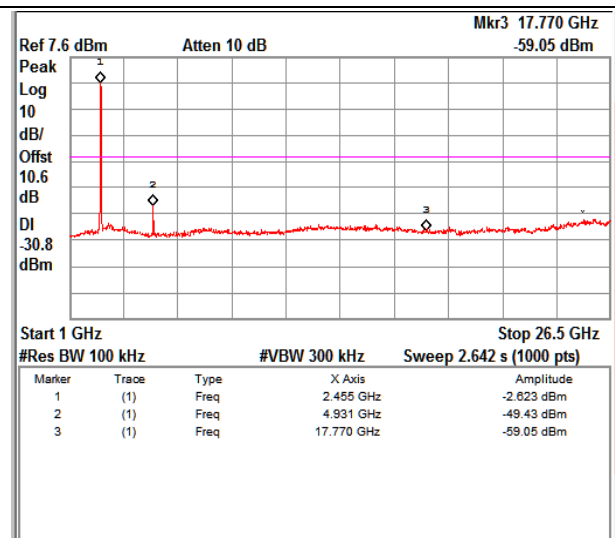
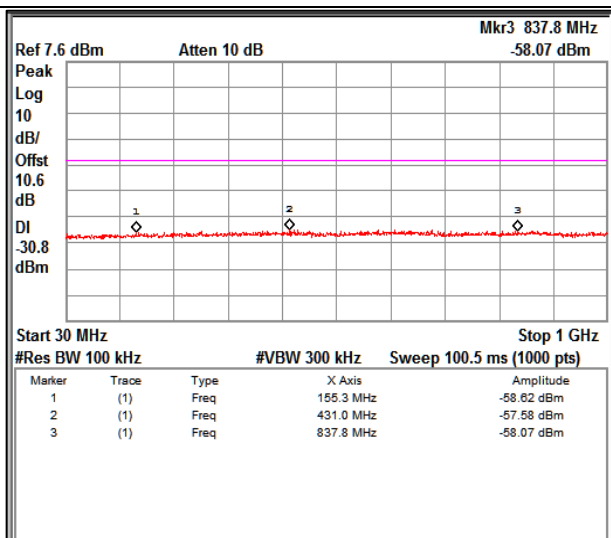
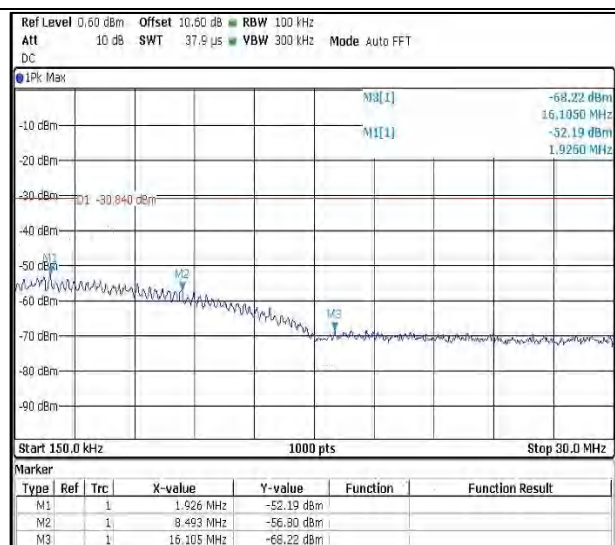
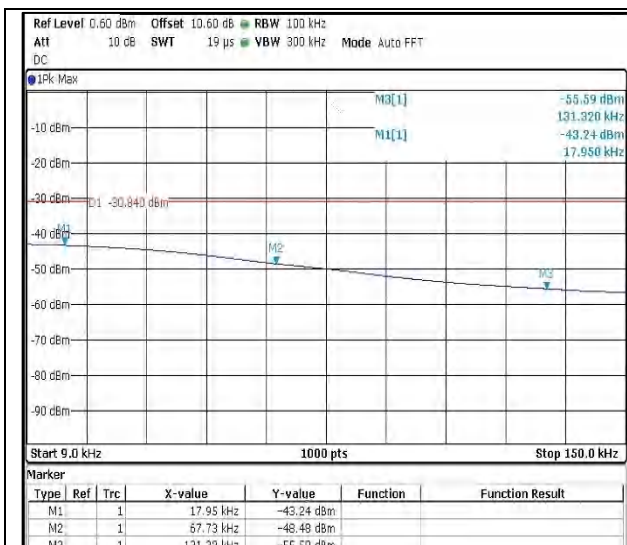



**Prüfbericht - Nr.:**  
Test Report No.:

**IN22T1OT 001**  
**ULR-TC568822300000100F**

Seite 97 von 197  
Page 97 of 197

**Modulation: 802.11g**

**Data rate 54Mbps**

**Channel Frequency 2412MHz**

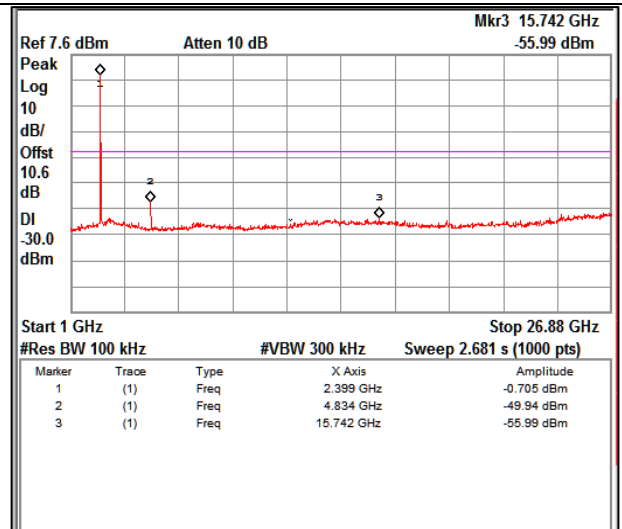
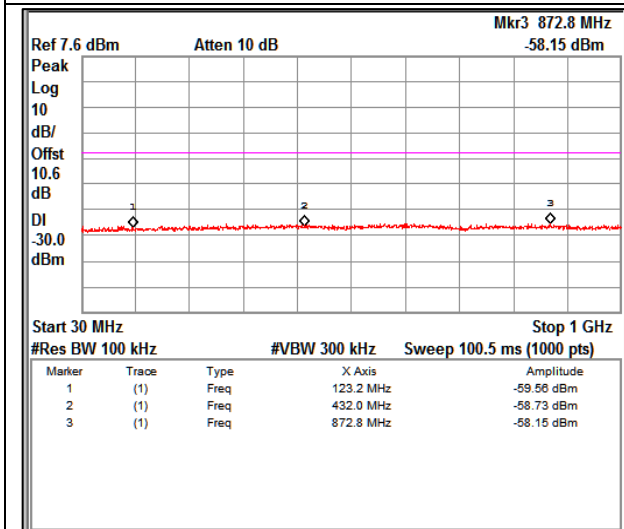
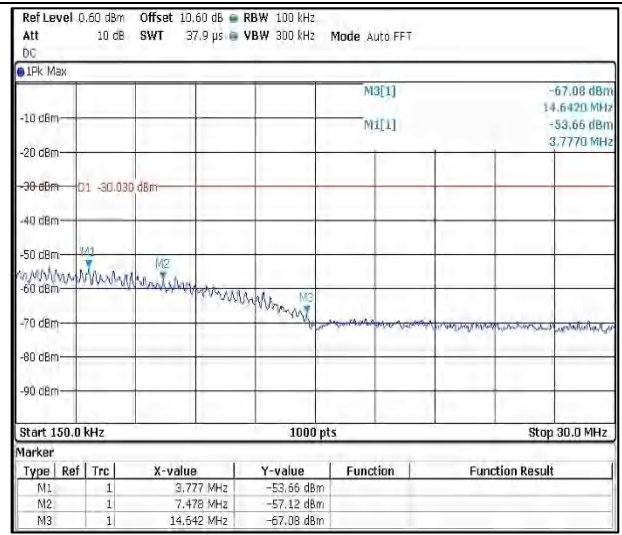
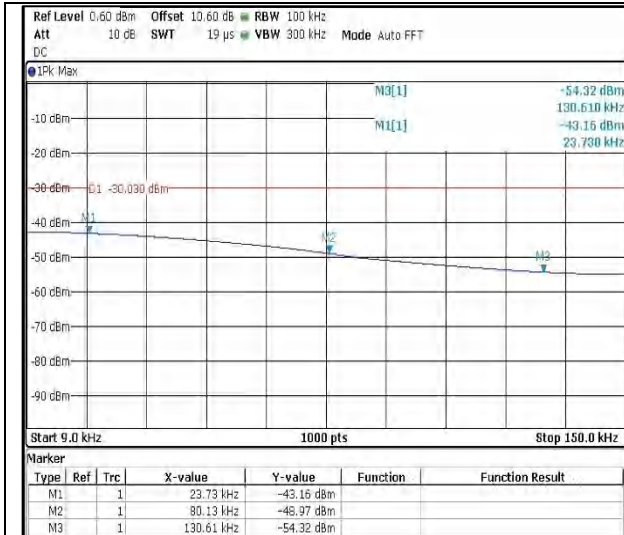

Prüfbericht - Nr.:  
Test Report No.:

IN22T1OT 001  
ULR-TC568822300000100F

Seite 98 von 197  
Page 98 of 197

Channel Frequency 2437MHz

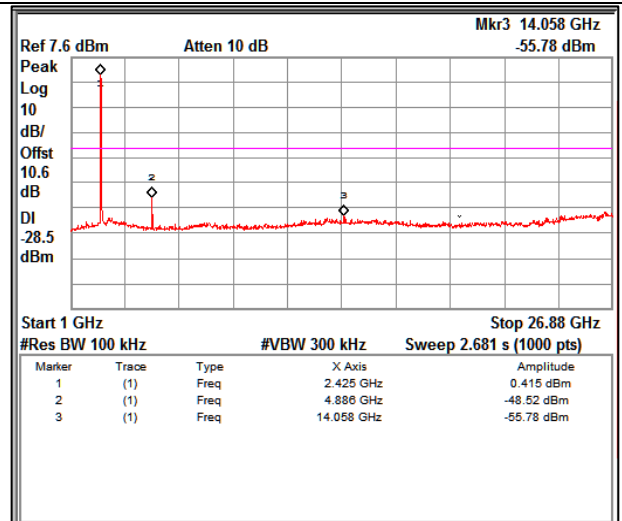
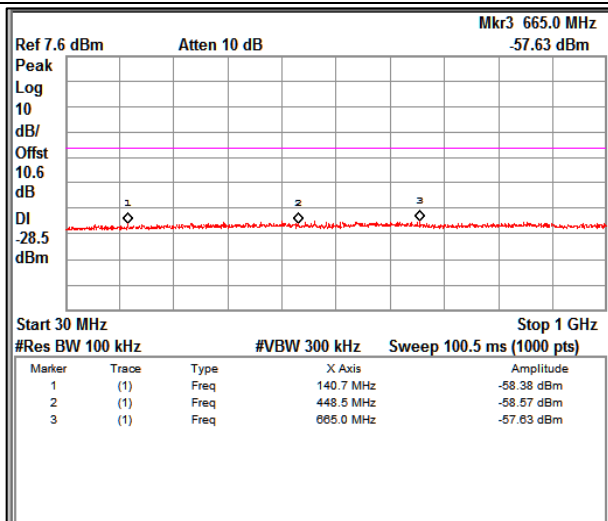
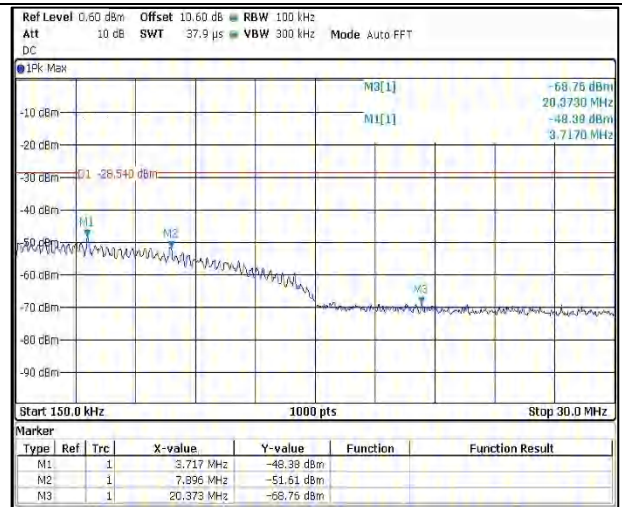
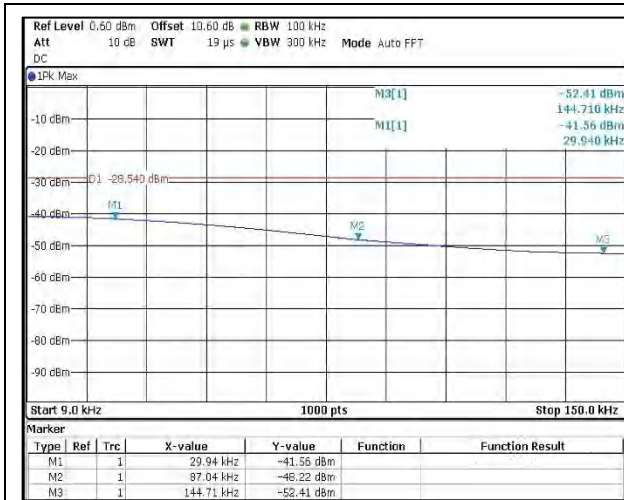

**Channel Frequency 2462MHz**

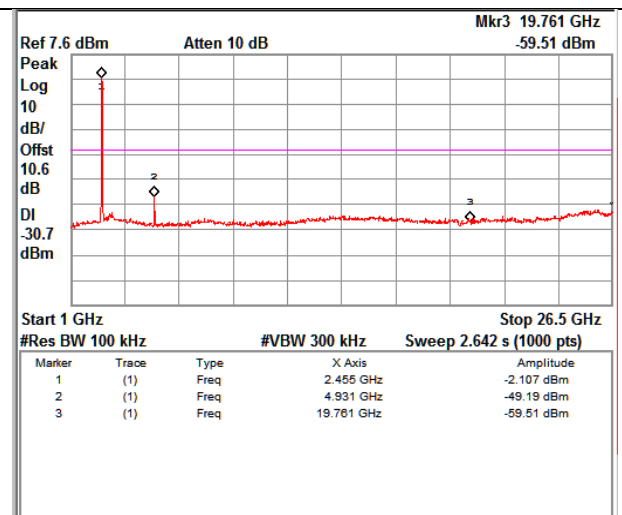
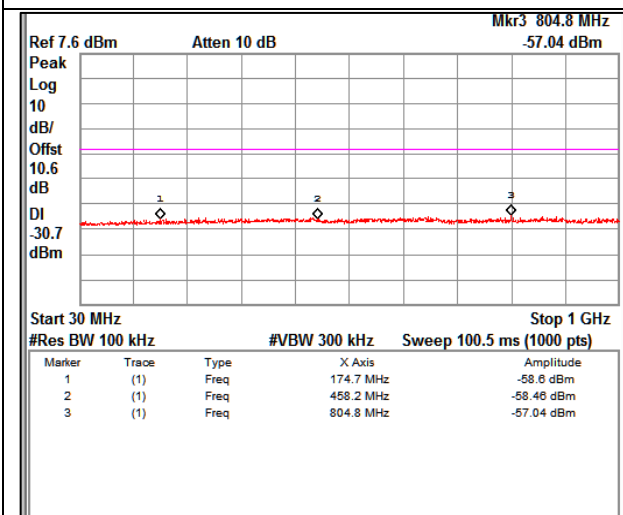
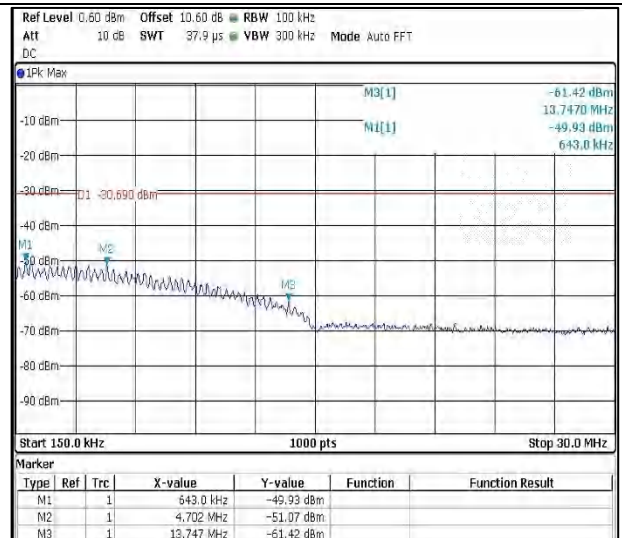
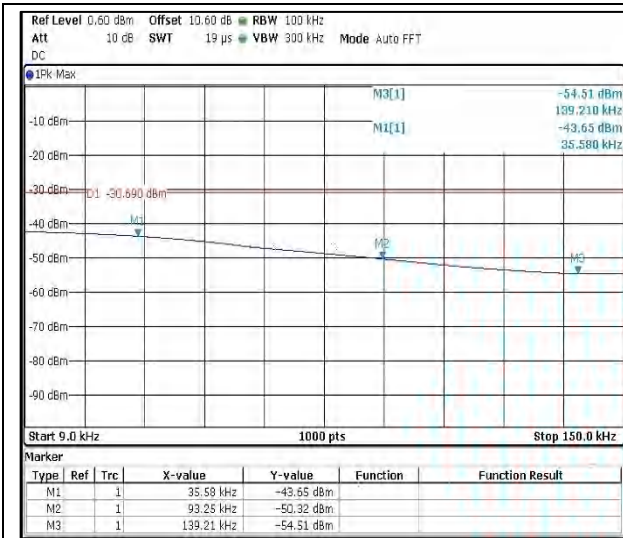

**Modulation: 802.11n HT20**
**Data rate MCS0**
**Channel Frequency 2412MHz**
