

APPLICATION CERTIFICATION FCC Part 15C  
On Behalf of  
XIAMEN COMFORT SCIENCE & TECHNOLOGY GROUP CO., LTD

Massage Chair  
Model No.: HMC-600, OGI-3220A

FCC ID: YMX-HMC600

Prepared for : XIAMEN COMFORT SCIENCE & TECHNOLOGY GROUP CO.,  
LTD

Address : (5/F)NO.168, QIANPU ROAD, SIMING DISTRICT, XIAMEN,  
FUJIAN, CHINA

Prepared by : Shenzhen Accurate Technology Co., Ltd.

Address : 1/F., Building A, Changyuan New Material Port, Science & Industry  
Park, Nanshan District, Shenzhen, Guangdong, P.R. China

Tel: (0755) 26503290

Fax: (0755) 26503396

Report No. : ATE20190505

Date of Test : April 15-18, 2019

Date of Report : April 22, 2019

## TABLE OF CONTENTS

Description	Page
Test Report Certification	
<b>TABLE OF CONTENTS</b> .....	<b>2</b>
<b>1. GENERAL INFORMATION</b> .....	<b>5</b>
1.1. Description of Device (EUT).....	5
1.2. Accessory and Auxiliary Equipment .....	5
1.3. Description of Test Facility .....	6
1.4. Measurement Uncertainty .....	6
<b>2. MEASURING DEVICE AND TEST EQUIPMENT</b> .....	<b>7</b>
<b>3. OPERATION OF EUT DURING TESTING</b> .....	<b>8</b>
3.1. Operating Mode .....	8
3.2. Configuration and peripherals .....	8
<b>4. TEST PROCEDURES AND RESULTS</b> .....	<b>9</b>
<b>5. 20DB BANDWIDTH TEST</b> .....	<b>10</b>
5.1. Block Diagram of Test Setup.....	10
5.2. The Requirement For Section 15.247(a)(1).....	10
5.3. EUT Configuration on Measurement .....	10
5.4. Operating Condition of EUT .....	10
5.5. Test Procedure .....	10
5.6. Test Result .....	11
<b>6. CARRIER FREQUENCY SEPARATION TEST</b> .....	<b>16</b>
6.1. Block Diagram of Test Setup.....	16
6.2. The Requirement For Section 15.247(a)(1).....	16
6.3. EUT Configuration on Measurement .....	16
6.4. Operating Condition of EUT .....	16
6.5. Test Procedure .....	17
6.6. Test Result .....	17
<b>7. NUMBER OF HOPPING FREQUENCY TEST</b> .....	<b>23</b>
7.1. Block Diagram of Test Setup.....	23
7.2. The Requirement For Section 15.247(a)(1)(iii).....	23
7.3. EUT Configuration on Measurement .....	23
7.4. Operating Condition of EUT .....	23
7.5. Test Procedure .....	23
7.6. Test Result .....	24
<b>8. DWELL TIME TEST</b> .....	<b>26</b>
8.1. Block Diagram of Test Setup.....	26
8.2. The Requirement For Section 15.247(a)(1)(iii).....	26
8.3. EUT Configuration on Measurement .....	26
8.4. Operating Condition of EUT .....	26
8.5. Test Procedure .....	26
8.6. Test Result .....	27
<b>9. MAXIMUM PEAK OUTPUT POWER TEST</b> .....	<b>33</b>
9.1. Block Diagram of Test Setup.....	33

9.2.	The Requirement For Section 15.247(b)(1).....	33
9.3.	EUT Configuration on Measurement .....	33
9.4.	Operating Condition of EUT .....	33
9.5.	Test Procedure .....	33
9.6.	Test Result .....	34
<b>10.</b>	<b>RADIATED EMISSION TEST .....</b>	<b>40</b>
10.1.	Block Diagram of Test Setup.....	40
10.2.	The Limit For Section 15.247(d) .....	41
10.3.	Restricted bands of operation .....	43
10.4.	Configuration of EUT on Measurement .....	43
10.5.	Operating Condition of EUT .....	44
10.6.	Test Procedure .....	44
10.7.	Data Sample.....	45
10.8.	The Field Strength of Radiation Emission Measurement Results .....	45
<b>11.</b>	<b>BAND EDGE COMPLIANCE TEST .....</b>	<b>58</b>
11.1.	Block Diagram of Test Setup.....	58
11.2.	The Requirement For Section 15.247(d) .....	58
11.3.	EUT Configuration on Measurement .....	58
11.4.	Operating Condition of EUT .....	58
11.5.	Test Procedure .....	59
11.6.	Test Result .....	59
<b>12.</b>	<b>AC POWER LINE CONDUCTED EMISSION FOR FCC PART 15 SECTION 15.207(A) ..</b>	<b>70</b>
12.1.	Block Diagram of Test Setup.....	70
12.2.	Power Line Conducted Emission Measurement Limits.....	71
12.3.	Configuration of EUT on Measurement .....	71
12.4.	Operating Condition of EUT .....	71
12.5.	Test Procedure .....	71
12.6.	Data Sample.....	72
12.7.	Power Line Conducted Emission Measurement Results .....	72
<b>13.</b>	<b>ANTENNA REQUIREMENT.....</b>	<b>75</b>
13.1.	The Requirement .....	75
13.2.	Antenna Construction .....	75

## Test Report Certification

Applicant : XIAMEN COMFORT SCIENCE & TECHNOLOGY GROUP CO., LTD  
Manufacturer : XIAMEN OGAWA INTELLIGENT HEALTH EQUIPMENT CO., LTD  
EUT Description : Massage Chair  
Model No. : HMC-600, OGI-3220A  
Brand Name : n.a.

Measurement Procedure Used:

### FCC Rules and Regulations Part 15 Subpart C Section 15.247: 2018 ANSI C63.10: 2013

The device described above is tested by Shenzhen Accurate Technology Co., Ltd. to determine the maximum emission levels emanating from the device. The maximum emission levels are compared to the FCC Part 15 Subpart C Section 15.247 limits. The measurement results are contained in this test report and Shenzhen Accurate Technology Co., Ltd. is assumed full responsibility for the accuracy and completeness of these measurements. Also, this report shows that the Equipment Under Test (EUT) is to be technically compliant with the FCC requirements.

This report applies to above tested sample only. This report shall not be reproduced in part without written approval of Shenzhen Accurate Technology Co., Ltd.

Date of Test : April 15-18, 2019  
Date of Report : April 22, 2019

Prepared by : \_\_\_\_\_  
(Bob Wang, Engineer)

Approved & Authorized Signer : \_\_\_\_\_  
(Sean Liu, Manager)



## 1. GENERAL INFORMATION

### 1.1. Description of Device (EUT)

Model Number	:	HMC-600, OGI-3220A (Note: These samples are same except their appearance color is different. So we prepare HMC-600 for test only.)
Bluetooth version	:	V 5.0
Frequency Range	:	2402MHz-2480MHz
Number of Channels	:	79
Antenna Gain(Max)	:	0dBi
Antenna type	:	Plate loaded ceramic antenna
Adapter Input Voltage	:	AC 110-120V; 60Hz
Modulation mode	:	GFSK, $\pi/4$ DQPSK, 8DPSK
Applicant	:	XIAMEN COMFORT SCIENCE & TECHNOLOGY GROUP CO., LTD
Address	:	(5/F)NO.168, QIANPU ROAD, SIMING DISTRICT, XIAMEN, FUJIAN, CHINA
Manufacturer	:	XIAMEN OGAWA INTELLIGENT HEALTH EQUIPMENT CO., LTD
Address	:	THREE FLOOR NO 38-40 TIANYANG ROAD JIMEI ZONE XIAMEN T:3521880
Date of sample received	:	April 10, 2019
Date of Test	:	April 15-18, 2019
Sample Number	:	1900355

### 1.2. Accessory and Auxiliary Equipment

N/A

### 1.3. Description of Test Facility

EMC Lab	:	Recognition of accreditation by Federal Communications Commission (FCC) The Designation Number is CN1189 The Registration Number is 708358
		Listed by Innovation, Science and Economic Development Canada (ISED) The Registration Number is 5077A-2
		Accredited by China National Accreditation Service for Conformity Assessment (CNAS) The Registration Number is CNAS L3193
		Accredited by American Association for Laboratory Accreditation (A2LA) The Certificate Number is 4297.01
Name of Firm	:	Shenzhen Accurate Technology Co., Ltd.
Site Location	:	1/F., Building A, Changyuan New Material Port, Science & Industry Park, Nanshan District, Shenzhen, Guangdong, P.R. China

### 1.4. Measurement Uncertainty

Conducted Emission Expanded Uncertainty	=	2.23dB, k=2
Radiated emission expanded uncertainty (9kHz-30MHz)	=	3.08dB, k=2
Radiated emission expanded uncertainty (30MHz-1000MHz)	=	4.42dB, k=2
Radiated emission expanded uncertainty (Above 1GHz)	=	4.06dB, k=2

## 2. MEASURING DEVICE AND TEST EQUIPMENT

**Table 1: List of Test and Measurement Equipment**

Kind of equipment	Manufacturer	Type	S/N	Calibrated dates	Calibrated until
EMI Test Receiver	Rohde&Schwarz	ESCS30	100307	Jan. 05, 2019	1 Year
EMI Test Receiver	Rohde&Schwarz	ESPI3	101526/003	Jan. 05, 2019	1 Year
Spectrum Analyzer	Agilent	E7405A	MY45115511	Jan. 05, 2019	1 Year
Pre-Amplifier	Rohde&Schwarz	CBLU1183540-01	3791	Jan. 05, 2019	1 Year
Loop Antenna	Schwarzbeck	FMZB1516	1516131	Jan. 05, 2019	1 Year
Bilog Antenna	Schwarzbeck	VULB9163	9163-323	Jan. 05, 2019	1 Year
Horn Antenna	Schwarzbeck	BBHA9120D	9120D-655	Jan. 05, 2019	1 Year
Horn Antenna	Schwarzbeck	BBHA9170	9170-359	Jan. 05, 2019	1 Year
LISN	Rohde&Schwarz	ESH3-Z5	100305	Jan. 05, 2019	1 Year
LISN	Schwarzbeck	NSLK8126	8126431	Jan. 05, 2019	1 Year
Highpass Filter	Wainwright Instruments	WHKX3.6/18G-10SS	N/A	Jan. 05, 2019	1 Year
Band Reject Filter	Wainwright Instruments	WRCG2400/2485-2375/2510-60/11SS	N/A	Jan. 05, 2019	1 Year
RF COAXIAL CABLE	SUHNER	N-5m(Frequency range:9KHz-26.5GHz)	NO.3	Jan. 05, 2019	1 Year
RF COAXIAL CABLE	SUHNER	N-5m(Frequency range:9KHz-26.5GHz)	NO.4	Jan. 05, 2019	1 Year
RF COAXIAL CABLE	SUHNER	N-1m(Frequency range:9KHz-26.5GHz)	NO.5	Jan. 05, 2019	1 Year
RF COAXIAL CABLE	SUHNER	N-1m(Frequency range:9KHz-26.5GHz)	NO.6	Jan. 05, 2019	1 Year
Temporary antenna connector	NTGS	14AE	N/A	March 20, 2019	N/A

Note: The temporary antenna connector is soldered on the PCB board in order to perform conducted tests and this temporary antenna connector is listed in the equipment list.

### 3. OPERATION OF EUT DURING TESTING

#### 3.1. Operating Mode

The mode is used: Transmitting mode  
Low Channel: 2402MHz  
Middle Channel: 2441MHz  
High Channel: 2480MHz  
Hopping

#### 3.2. Configuration and peripherals

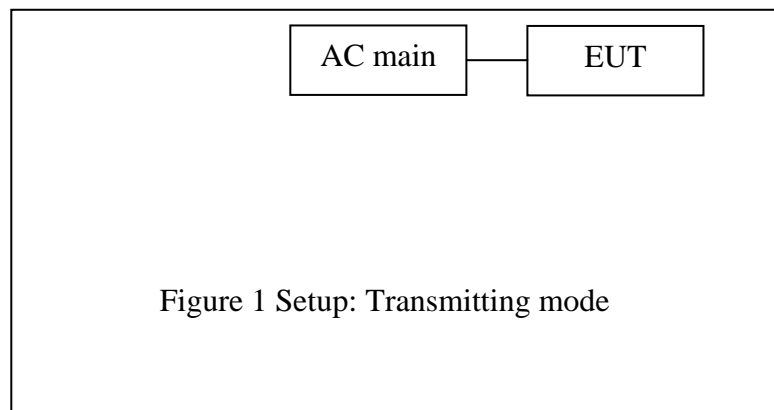



#### 4. TEST PROCEDURES AND RESULTS

<b>FCC Rules</b>	<b>Description of Test</b>	<b>Result</b>
Section 15.207	Conducted Emission Test	Compliant
Section 15.247(a)(1)	20dB Bandwidth Test	Compliant
Section 15.247(a)(1)	Carrier Frequency Separation Test	Compliant
Section 15.247(a)(1)(iii)	Number Of Hopping Frequency Test	Compliant
Section 15.247(a)(1)(iii)	Dwell Time Test	Compliant
Section 15.247(b)(1)	Maximum Peak Output Power Test	Compliant
Section 15.247(d) Section 15.209	Radiated Emission Test	Compliant
Section 15.247(d)	Band Edge Compliance Test	Compliant
Section 15.203	Antenna Requirement	Compliant

## 5. 20DB BANDWIDTH TEST

### 5.1. Block Diagram of Test Setup

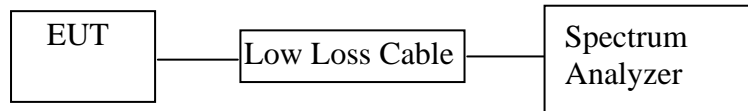

(EUT: Massage Chair)

### 5.2. The Requirement For Section 15.247(a)(1)

Section 15.247(a)(1): Frequency hopping systems shall have hopping channel carrier frequencies separated by a minimum of 25 kHz or the 20 dB bandwidth of the hopping channel, whichever is greater.

### 5.3. EUT Configuration on Measurement

The equipment are installed on the emission measurement to meet the commission requirements and operating regulations in a manner which tends to maximize its emission characteristics in normal application.

### 5.4. Operating Condition of EUT

5.4.1. Setup the EUT and simulator as shown as Section 5.1.

5.4.2. Turn on the power of all equipment.

5.4.3. Let the EUT work in TX (Hopping off) modes measure it. The transmit frequency are 2402-2480MHz. We select 2402MHz, 2441MHz, and 2480MHz TX frequency to transmit.

### 5.5. Test Procedure

5.5.1. The transmitter output was connected to the spectrum analyzer through a low loss cable.

5.5.2. Set RBW of spectrum analyzer to 100 kHz and VBW to 300 kHz.

5.5.3. The 20dB bandwidth is defined as the total spectrum the power of which is higher than peak power minus 20dB.

### 5.6. Test Result

Test Lab: Shielding room

Channel	Frequency (MHz)	GFSK 20dB Bandwidth (MHz)	Π/4-DQPSK 20dB Bandwidth (MHz)	8DPSK 20dB Bandwidth (MHz)	Result
Low	2402	1.128	1.422	1.422	Pass
Middle	2441	1.128	1.410	1.416	Pass
High	2480	1.128	1.404	1.410	Pass

The spectrum analyzer plots are attached as below.

#### GFSK Mode

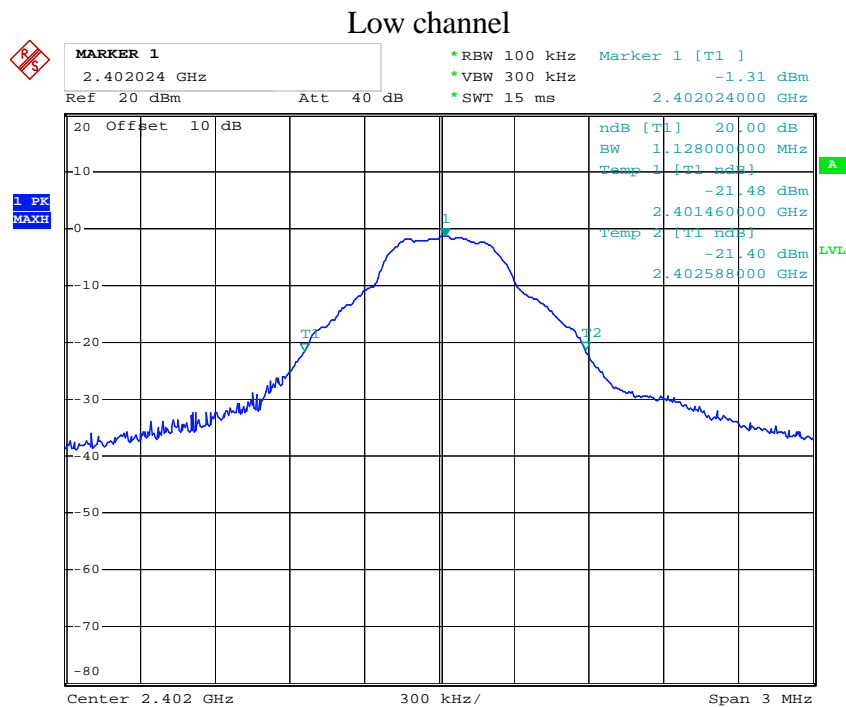

Comment A:  
Date: 17.APR.2019 19:49:24

### Middle channel

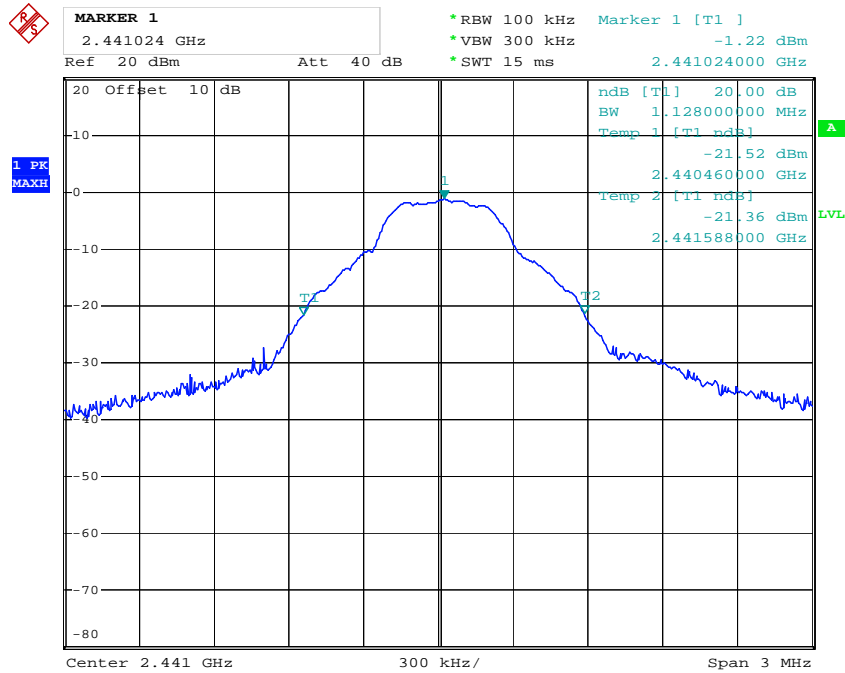

Comment A:  
Date: 17.APR.2019 19:50:12

### High channel

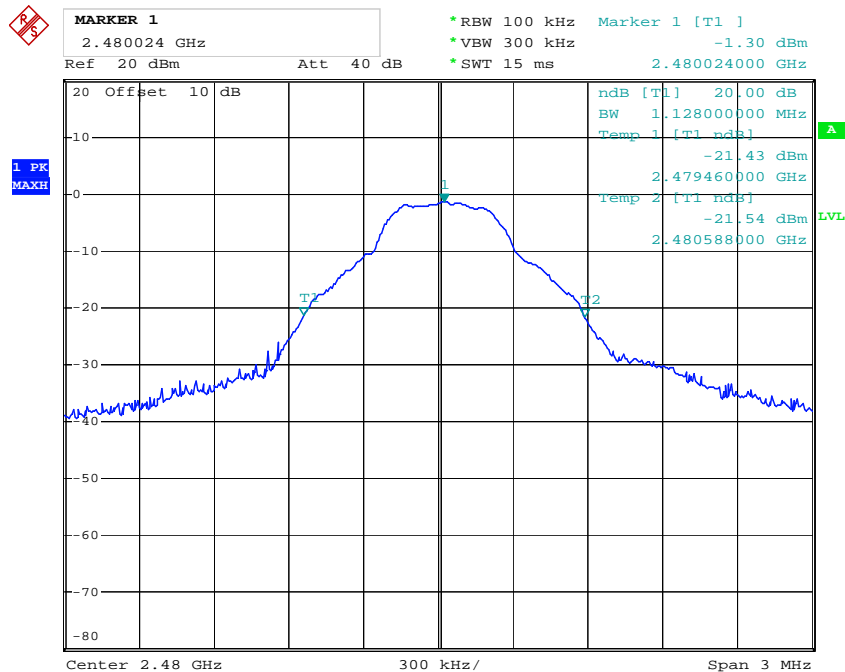

Comment A:  
Date: 17.APR.2019 19:50:55

Π/4-DQPSK Mode

Low channel

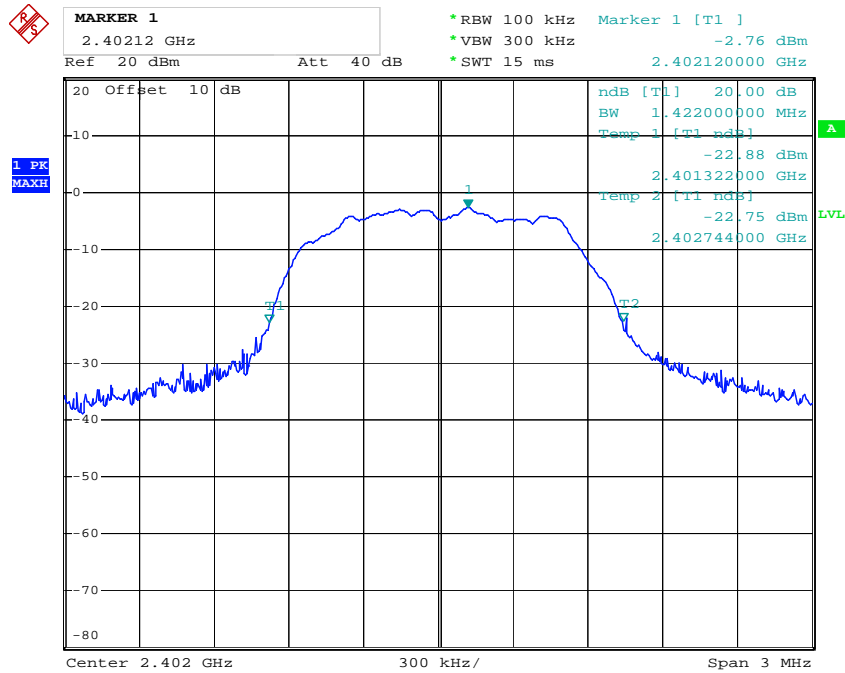

Comment A:  
Date: 17.APR.2019 19:55:20

Middle channel

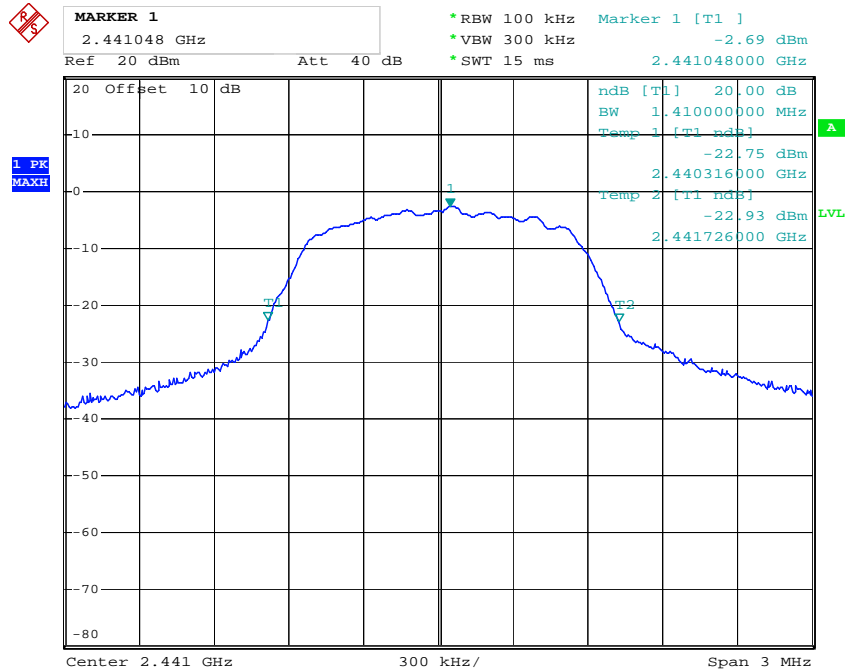

Comment A:  
Date: 17.APR.2019 19:53:19

### High channel

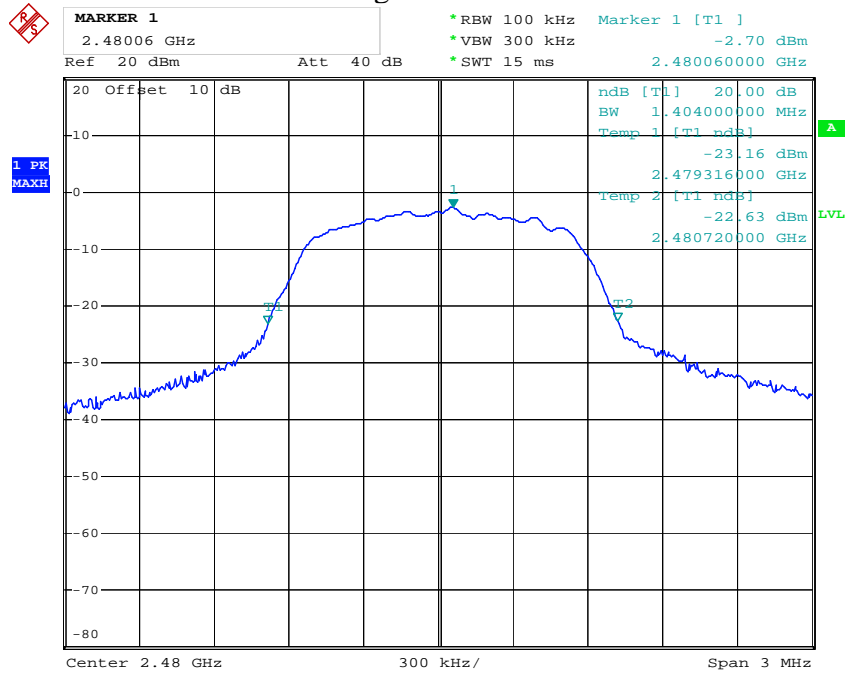

Comment A:  
 Date: 17.APR.2019 19:52:13

### 8DPSK Mode

### Low channel

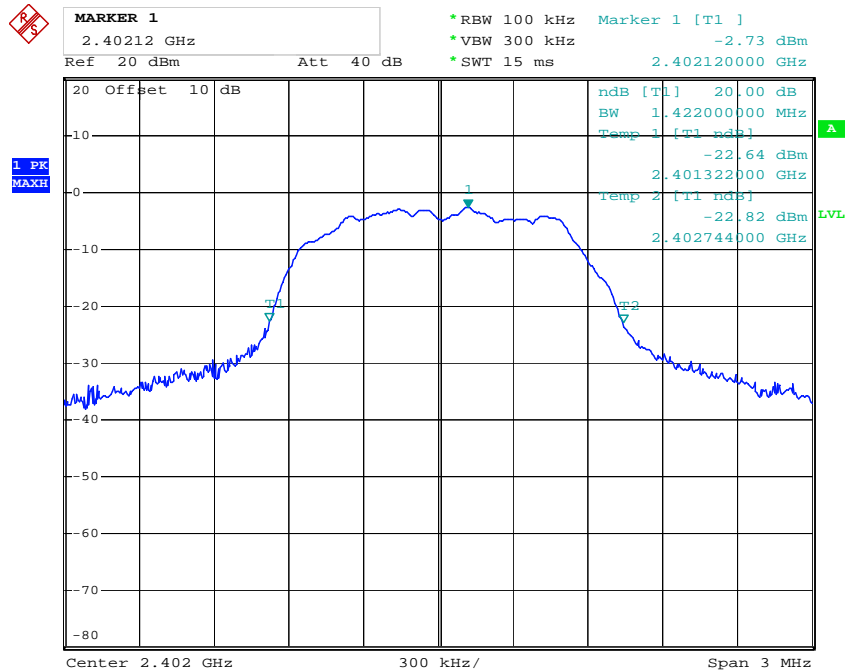

Comment A:  
 Date: 17.APR.2019 19:57:53

### Middle channel

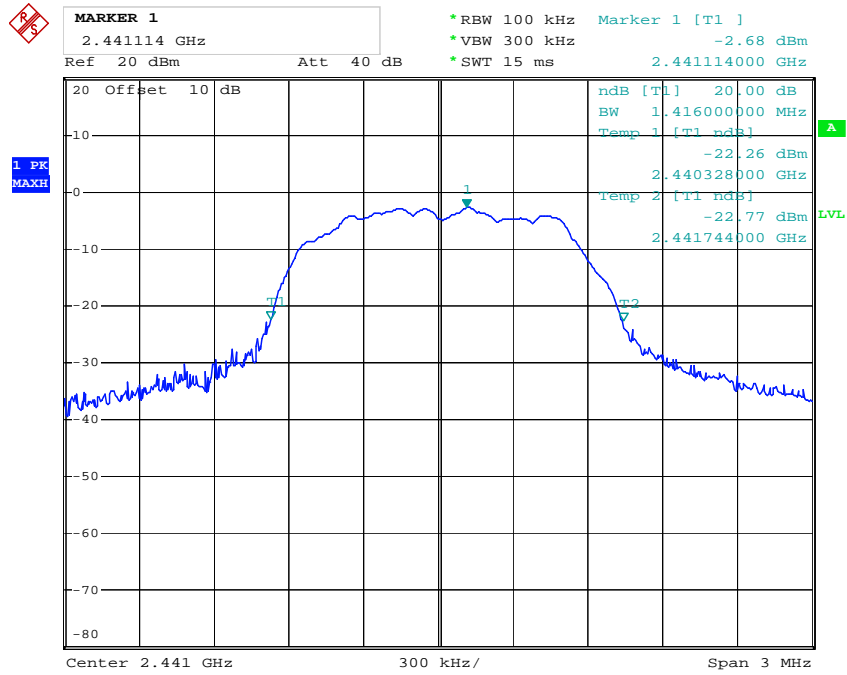

Comment A:  
 Date: 17.APR.2019 19:59:02

### High channel

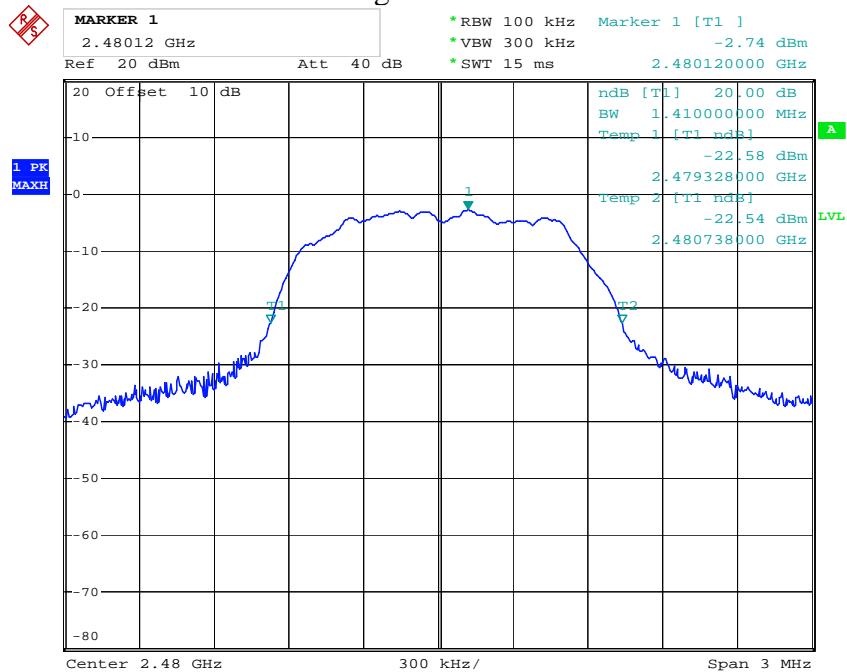

Comment A:  
 Date: 17.APR.2019 19:59:51

## 6. CARRIER FREQUENCY SEPARATION TEST

### 6.1. Block Diagram of Test Setup

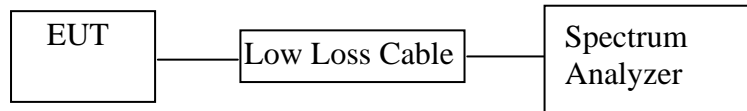

(EUT: Massage Chair)

### 6.2. The Requirement For Section 15.247(a)(1)

Section 15.247(a)(1): Frequency hopping systems shall have hopping channel carrier frequencies separated by a minimum of 25 kHz or the 20 dB bandwidth of the hopping channel, whichever is greater. Alternatively, frequency hopping systems operating in the 2400-2483.5 MHz band may have hopping channel carrier frequencies that are separated by 25 kHz or two-thirds of the 20 dB bandwidth of the hopping channel, whichever is greater, provided the systems operate with an output power no greater than 125 mW. The system shall hop to channel frequencies that are selected at the system hopping rate from a pseudorandomly ordered list of hopping frequencies. Each frequency must be used equally on the average by each transmitter. The system receivers shall have input bandwidths that match the hopping channel bandwidths of their corresponding transmitters and shall shift frequencies in synchronization with the transmitted signals.

### 6.3. EUT Configuration on Measurement

The equipment are installed on the emission measurement to meet the commission requirements and operating regulations in a manner which tends to maximize its emission characteristics in normal application.

### 6.4. Operating Condition of EUT

6.4.1. Setup the EUT and simulator as shown as Section 6.1.

6.4.2. Turn on the power of all equipment.

6.4.3. Let the EUT work in TX (Hopping on) modes measure it. The transmit frequency are 2402-2480MHz. We select 2402MHz, 2441MHz, and 2480MHz TX frequency to transmit.



### 6.5. Test Procedure

6.5.1. The transmitter output was connected to the spectrum analyzer through a low loss cable.

6.5.2. Set RBW of spectrum analyzer to 30 kHz and VBW to 100 kHz. Adjust Span to 2MHz.

6.5.3. Set the adjacent channel of the EUT Maxhold another trace.

6.5.4. Measurement the channel separation

### 6.6. Test Result

Test Lab: Shielding room

#### GFSK

Channel	Frequency (MHz)	Channel Separation(MHz)	Limit (MHz)	Result
Low	2402	1.002	25KHz or 2/3*20dB bandwidth	PASS
	2403			
Middle	2440	1.002	25KHz or 2/3*20dB bandwidth	PASS
	2441			
High	2479	1.002	25KHz or 2/3*20dB bandwidth	PASS
	2480			

#### Π/4-DQPSK

Channel	Frequency (MHz)	Channel Separation(MHz)	Limit (MHz)	Result
Low	2402	1.008	25KHz or 2/3*20dB bandwidth	PASS
	2403			
Middle	2440	1.002	25KHz or 2/3*20dB bandwidth	PASS
	2441			
High	2479	1.002	25KHz or 2/3*20dB bandwidth	PASS
	2480			

#### 8DPSK

Channel	Frequency (MHz)	Channel Separation(MHz)	Limit (MHz)	Result
Low	2402	1.002	25KHz or 2/3*20dB bandwidth	PASS
	2403			
Middle	2440	1.002	25KHz or 2/3*20dB bandwidth	PASS
	2441			
High	2479	1.002	25KHz or 2/3*20dB bandwidth	PASS
	2480			

GFSK Mode

Low channel

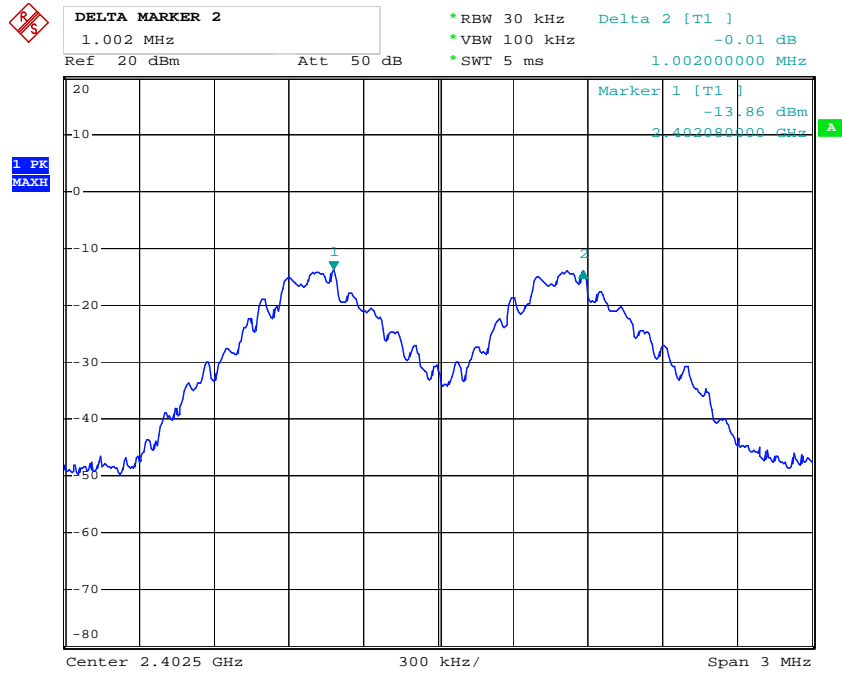

Comment A:  
Date: 17.APR.2019 21:48:03

Middle channel

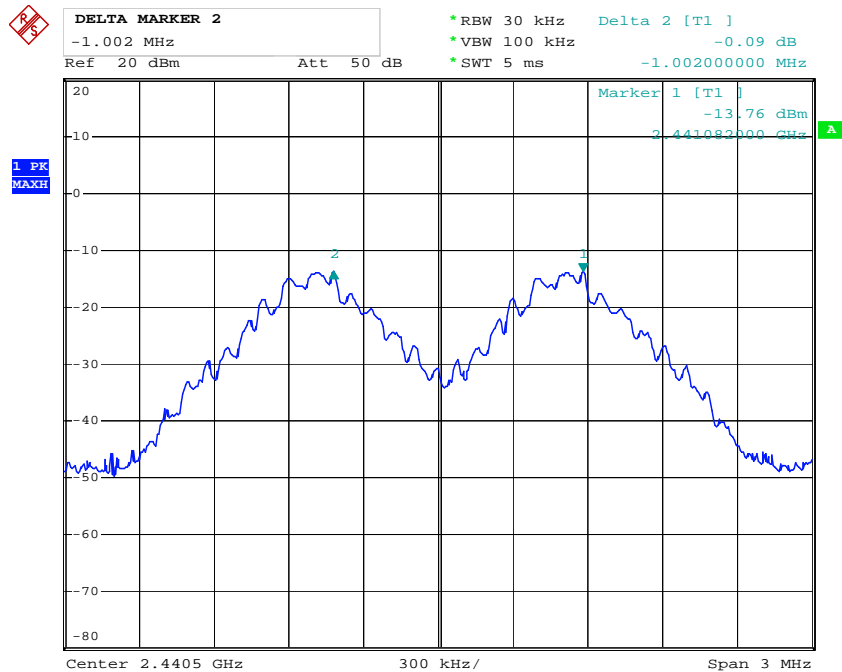

Comment A:  
Date: 17.APR.2019 21:50:44

## High channel

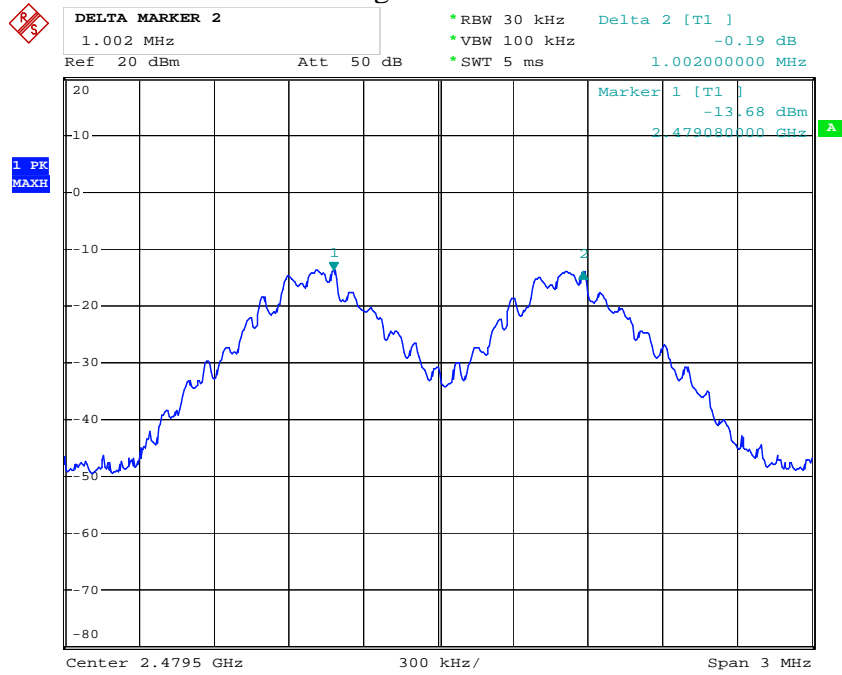

Comment A:  
Date: 17.APR.2019 21:52:11

## Π/4-DQPSK Mode

## Low channel

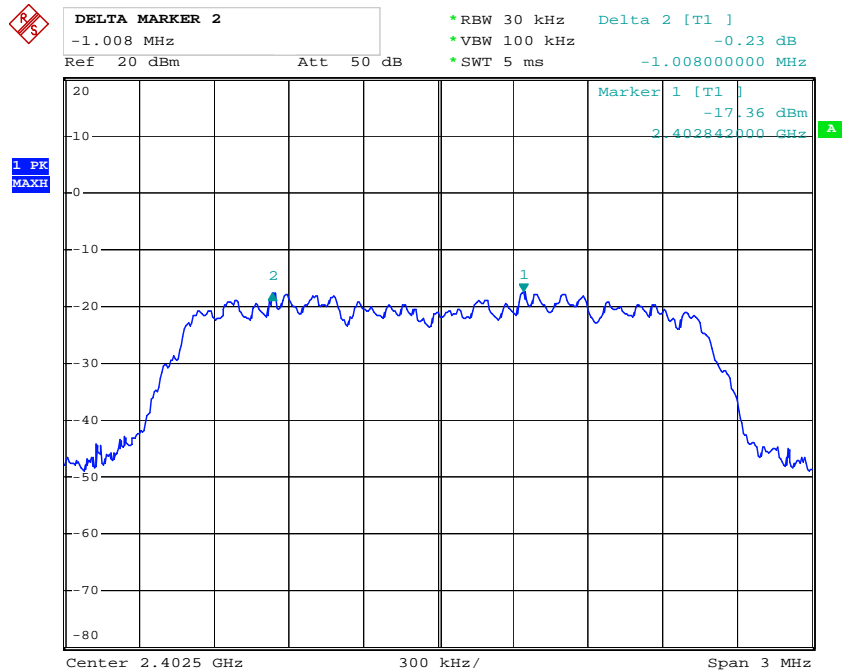

Comment A:  
Date: 17.APR.2019 22:04:49

### Middle channel

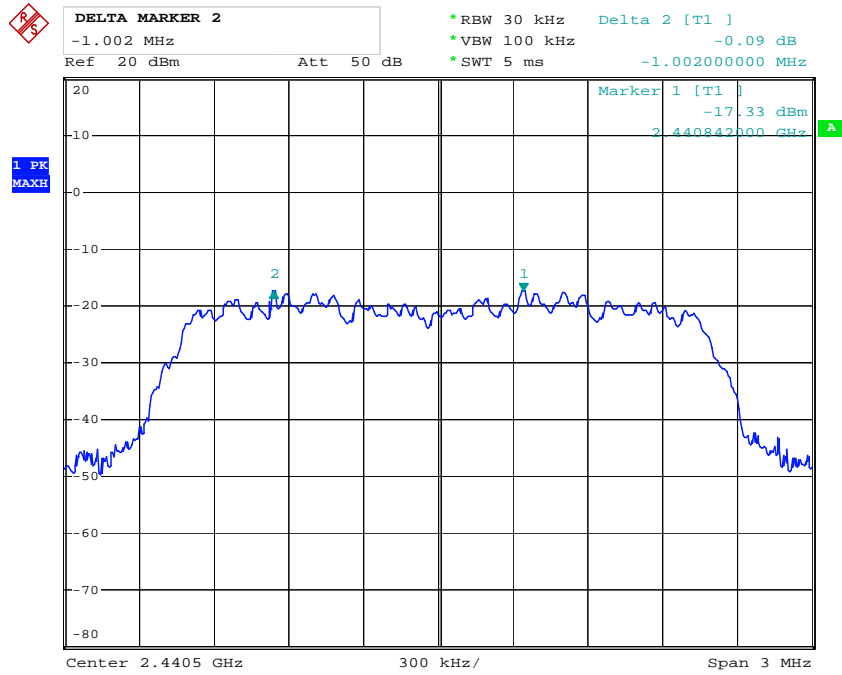

Comment A:  
Date: 17.APR.2019 22:02:28

### High channel

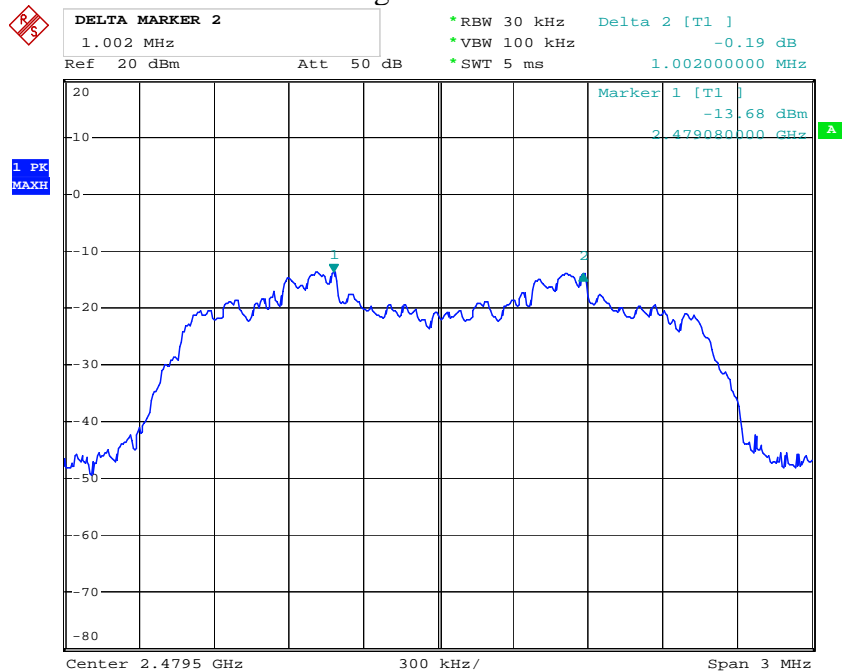

Comment A:  
Date: 17.APR.2019 21:53:08

8DPSK Mode

Low channel

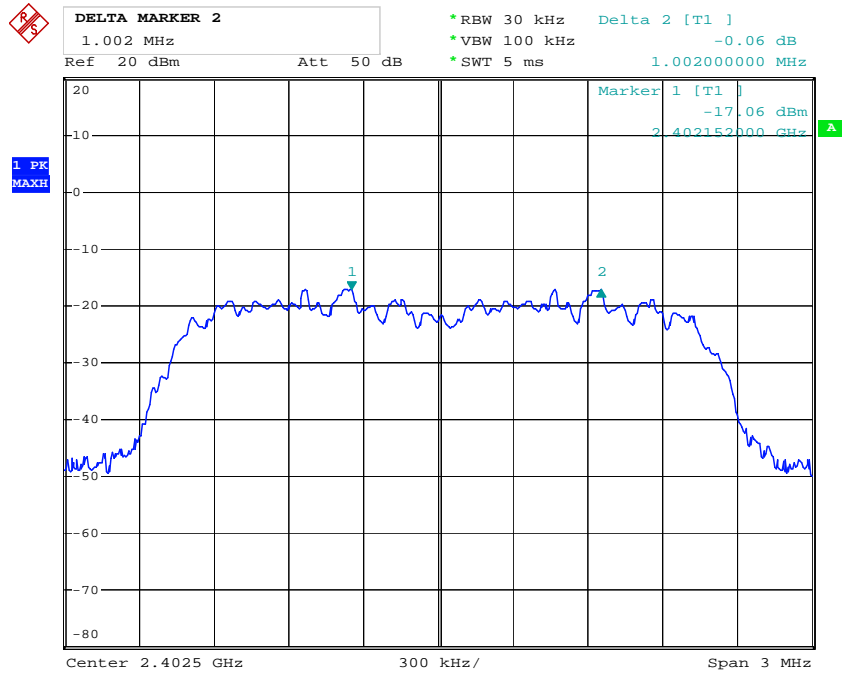

Comment A:  
Date: 17.APR.2019 22:07:44

Middle channel

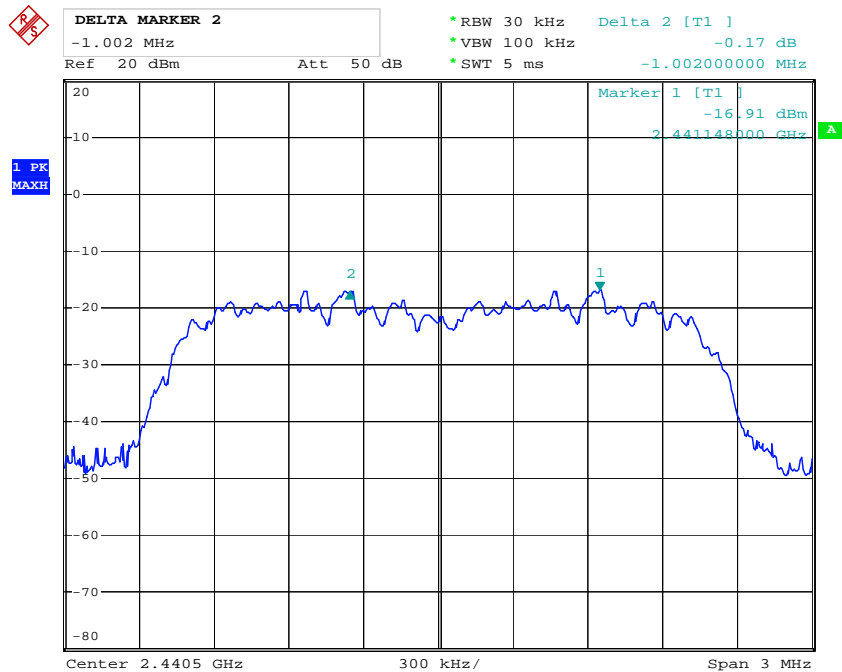

Comment A:  
Date: 17.APR.2019 22:09:08

### High channel

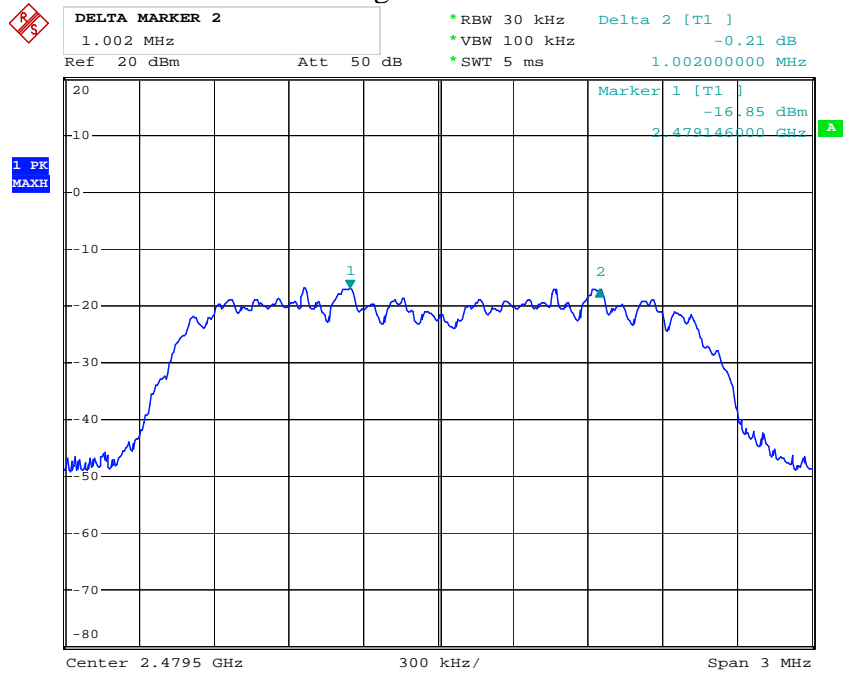

Comment A:  
Date: 17.APR.2019 22:10:53

## 7. NUMBER OF HOPPING FREQUENCY TEST

### 7.1. Block Diagram of Test Setup

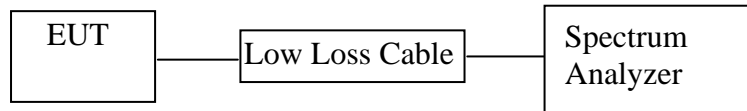

(EUT: Massage Chair)

### 7.2. The Requirement For Section 15.247(a)(1)(iii)

Section 15.247(a)(1)(iii): Frequency hopping systems in the 2400-2483.5 MHz band shall use at least 15 channels.

### 7.3. EUT Configuration on Measurement

The equipment are installed on the emission measurement to meet the commission requirements and operating regulations in a manner which tends to maximize its emission characteristics in normal application.

### 7.4. Operating Condition of EUT

7.4.1. Setup the EUT and simulator as shown as Section 7.1.

7.4.2. Turn on the power of all equipment.

7.4.3. Let the EUT work in TX (Hopping on) modes measure it.

### 7.5. Test Procedure

7.5.1. The transmitter output was connected to the spectrum analyzer through a low loss cable.

7.5.2. Set the spectrum analyzer as RBW=100 kHz, VBW=300 kHz.

7.5.3. Max hold, view and count how many channel in the band.

### 7.6. Test Result

Test Lab: Shielding room

Total number of hopping channel	Measurement result(CH)	Limit(CH)
	79	≥15

Number of hopping channels(GFSK)

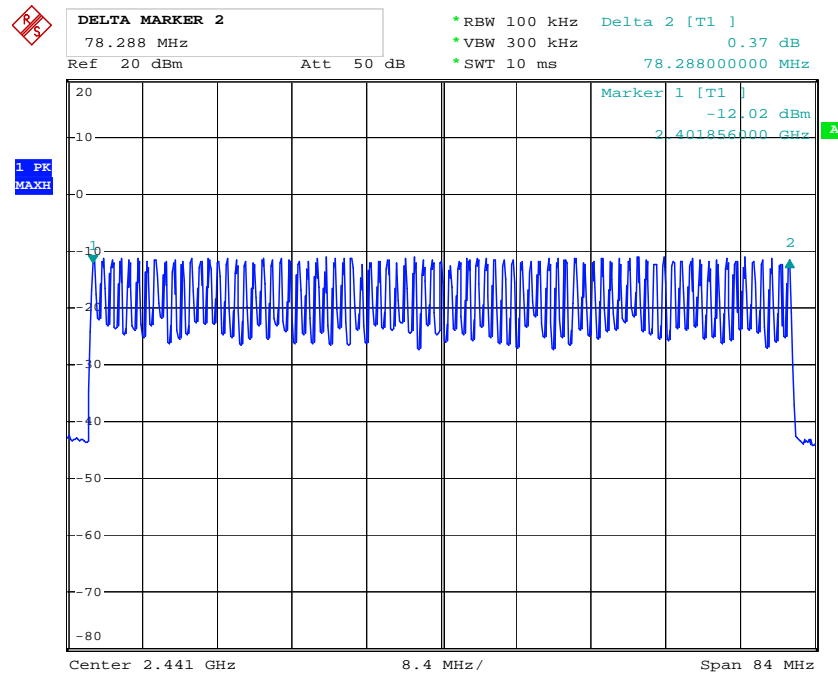

Comment A:  
Date: 17.APR.2019 22:20:16



### Number of hopping channels( $\Pi/4$ -DQPSK)

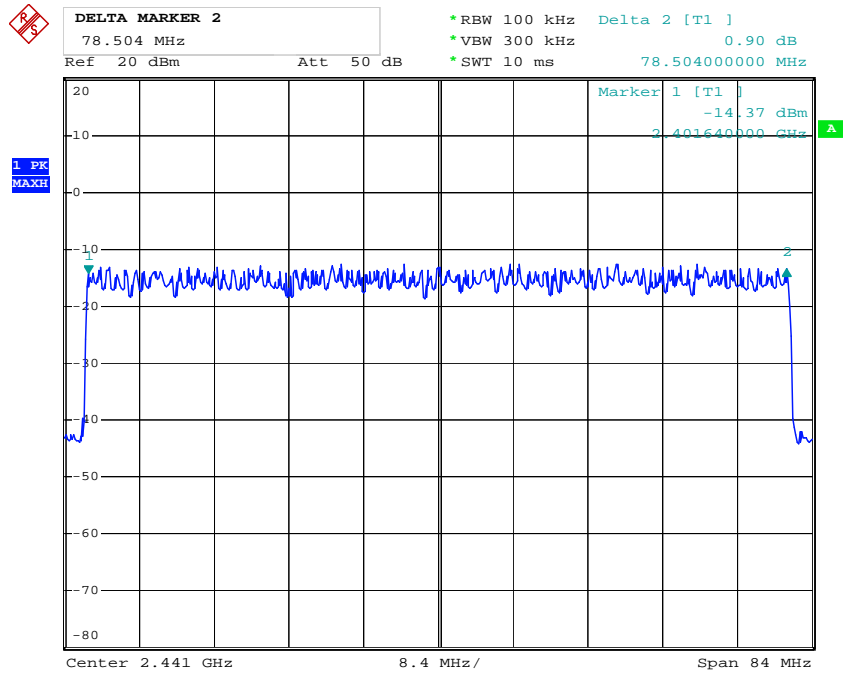

Comment A:  
Date: 17.APR.2019 22:17:37

### Number of hopping channels(8DPSK)

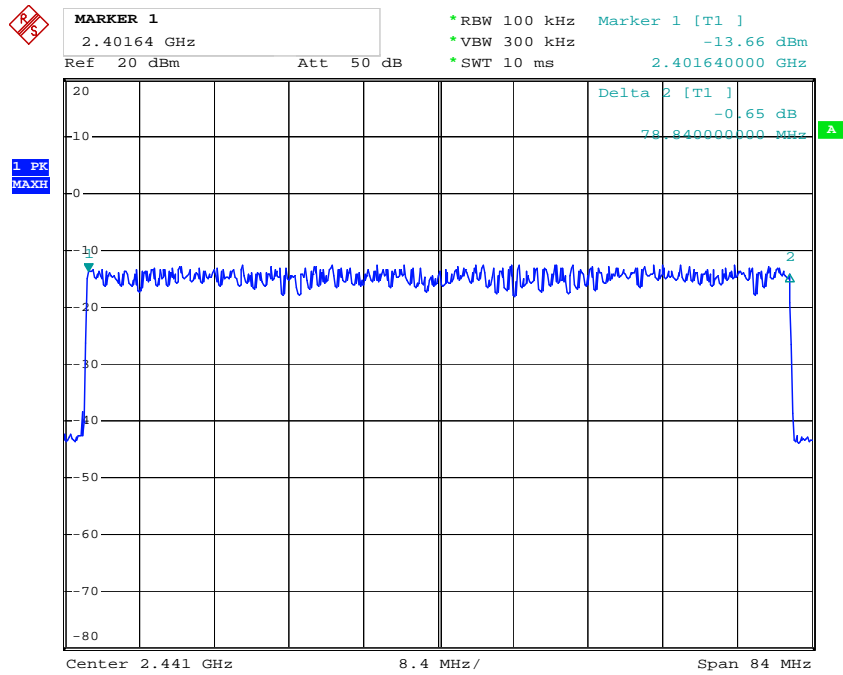

Comment A:  
Date: 17.APR.2019 22:15:10

## 8. DWELL TIME TEST

### 8.1. Block Diagram of Test Setup

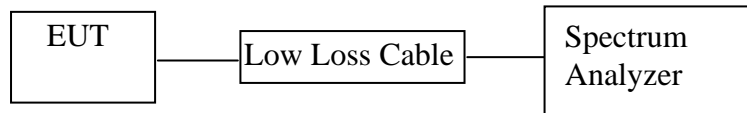

(EUT: Massage Chair)

### 8.2. The Requirement For Section 15.247(a)(1)(iii)

Section 15.247(a)(1)(iii): Frequency hopping systems in the 2400-2483.5 MHz band shall use at least 15 channels. The average time of occupancy on any channel shall not be greater than 0.4 seconds within a period of 0.4 seconds multiplied by the number of hopping channels employed. Frequency hopping systems may avoid or suppress transmissions on a particular hopping frequency provided that a minimum of 15 channels are used.

### 8.3. EUT Configuration on Measurement

The equipment are installed on the emission measurement to meet the commission requirements and operating regulations in a manner which tends to maximize its emission characteristics in normal application.

### 8.4. Operating Condition of EUT

8.4.1. Setup the EUT and simulator as shown as Section 8.1.

8.4.2. Turn on the power of all equipment.

8.4.3. Let the EUT work in TX (Hopping on) modes measure it. The transmit frequency are 2402-2480MHz. We select 2402MHz, 2441MHz, and 2480MHz TX frequency to transmit.

### 8.5. Test Procedure

8.5.1. The transmitter output was connected to the spectrum analyzer through a low loss cable.

8.5.2. Set center frequency of spectrum analyzer = operating frequency.

8.5.3. Set the spectrum analyzer as RBW=1MHz, VBW=3MHz, Span=0Hz, Adjust Sweep=5ms, 10ms, 15ms. Get the pulse time.

8.5.4. Repeat above procedures until all frequency measured were complete.

## 8.6. Test Result

Test Lab: Shielding room

### GFSK Mode (Worst case)

Mode	Channel Frequency (MHz)	Pulse Time (ms)	Dwell Time (ms)	Limit (ms)
DH1	2441	0.41	131.2	400
A period transmit time = $0.4 \times 79 = 31.6$ Dwell time = pulse time $\times (1600/(2*79)) \times 31.6$				
DH3	2441	1.71	273.6	400
A period transmit time = $0.4 \times 79 = 31.6$ Dwell time = pulse time $\times (1600/(4*79)) \times 31.6$				
DH5	2441	2.97	316.8	400
A period transmit time = $0.4 \times 79 = 31.6$ Dwell time = pulse time $\times (1600/(6*79)) \times 31.6$				

### $\Pi/4$ -DQPSK (Worst case)

Mode	Channel Frequency (MHz)	Pulse Time (ms)	Dwell Time (ms)	Limit (ms)
DH1	2441	0.40	128.0	400
A period transmit time = $0.4 \times 79 = 31.6$ Dwell time = pulse time $\times (1600/(2*79)) \times 31.6$				
DH3	2441	1.68	268.8	400
A period transmit time = $0.4 \times 79 = 31.6$ Dwell time = pulse time $\times (1600/(4*79)) \times 31.6$				
DH5	2441	2.97	316.8	400
A period transmit time = $0.4 \times 79 = 31.6$ Dwell time = pulse time $\times (1600/(6*79)) \times 31.6$				

### 8DPSK (Worst case)

Mode	Channel Frequency (MHz)	Pulse Time (ms)	Dwell Time (ms)	Limit (ms)
DH1	2441	0.41	131.2	400
A period transmit time = $0.4 \times 79 = 31.6$ Dwell time = pulse time $\times (1600/(2*79)) \times 31.6$				
DH3	2441	1.71	273.6	400
A period transmit time = $0.4 \times 79 = 31.6$ Dwell time = pulse time $\times (1600/(4*79)) \times 31.6$				
DH5	2441	3.00	320.0	400
A period transmit time = $0.4 \times 79 = 31.6$ Dwell time = pulse time $\times (1600/(6*79)) \times 31.6$				

Note: We tested GFSK mode and  $\Pi/4$ -DQPSK & 8DPSK mode the low, middle and high channel and recorded the worst case data for all test mode.

The spectrum analyzer plots are attached as below.

## GFSK Mode

### DH1 Middle channel

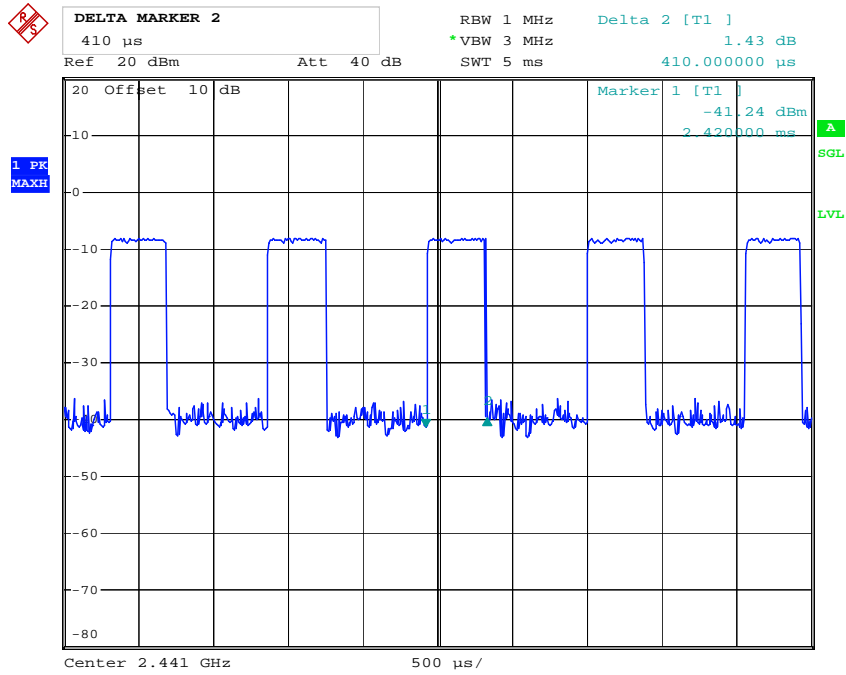

Comment A:  
Date: 17.APR.2019 21:21:53

### DH3 Middle channel

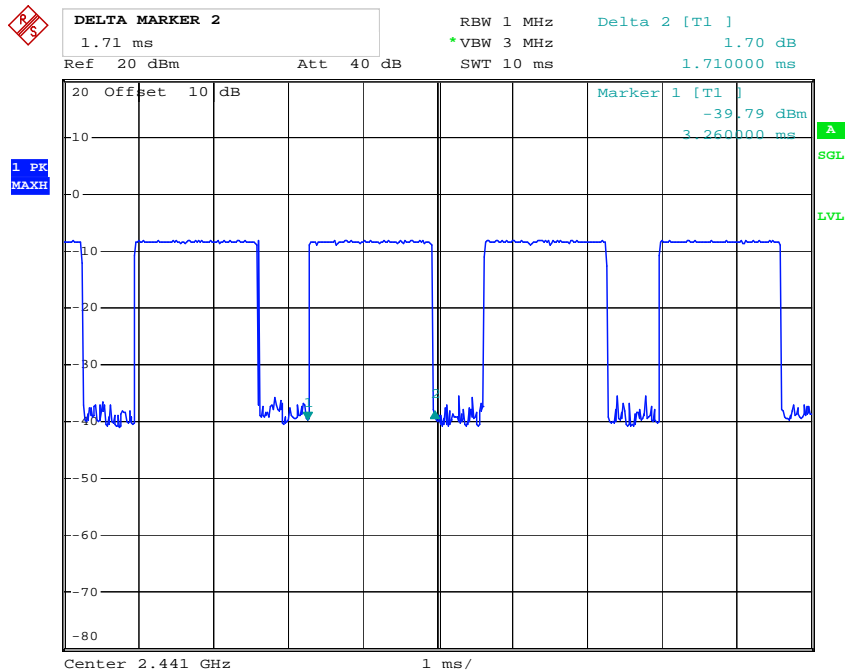

Comment A:  
Date: 17.APR.2019 21:23:59

### DH5 Middle channel

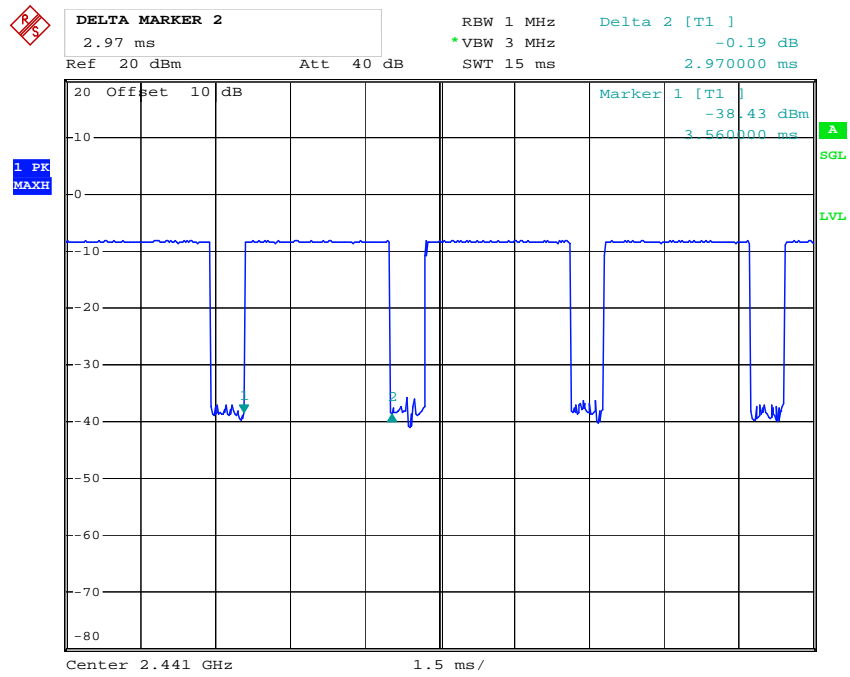

Comment A:  
Date: 17.APR.2019 21:25:56

### Π/4-DQPSK

### 2DH1 Middle channel

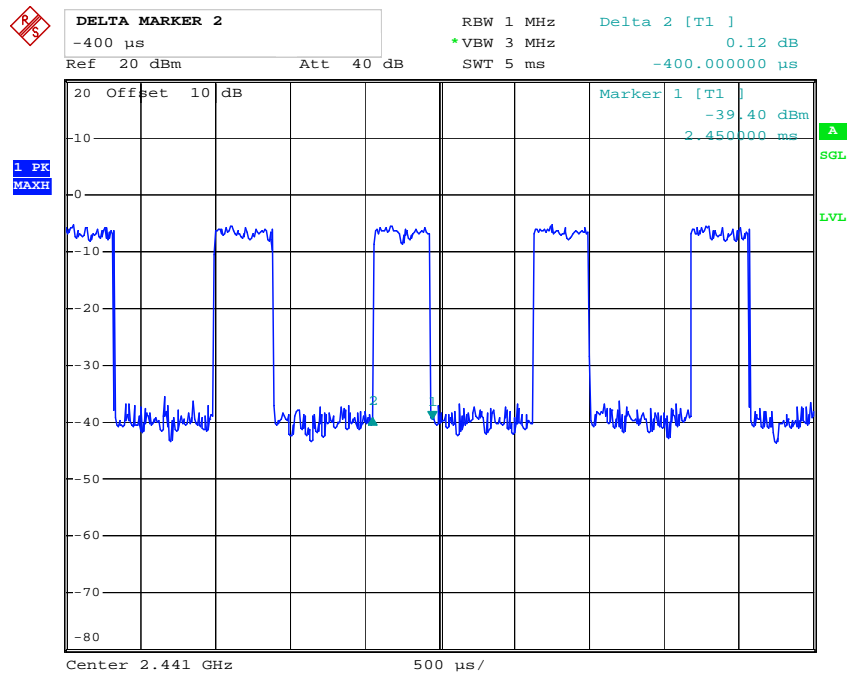

Comment A:  
Date: 17.APR.2019 21:33:14

## 2DH3 Middle channel

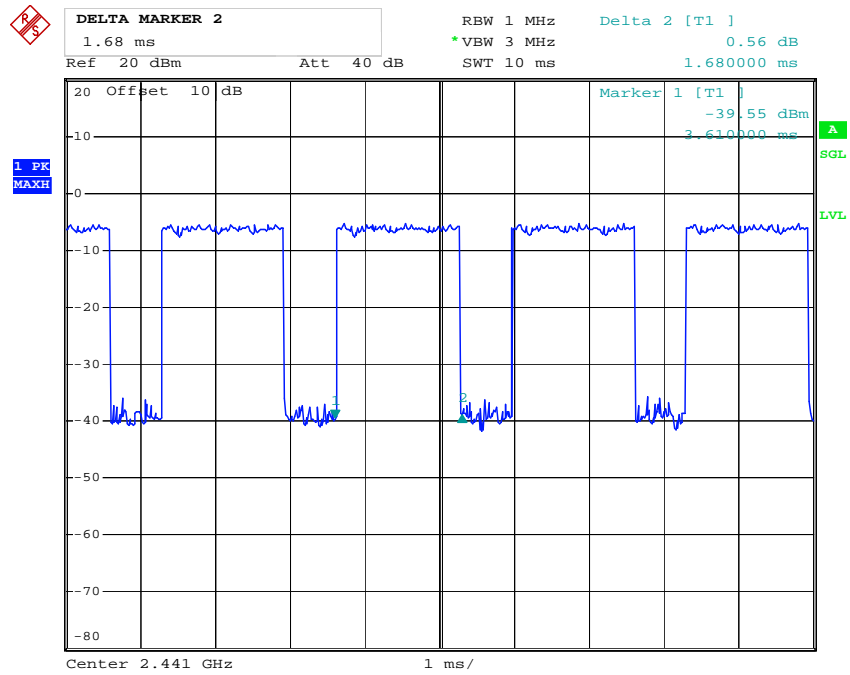

## 2DH5 Middle channel

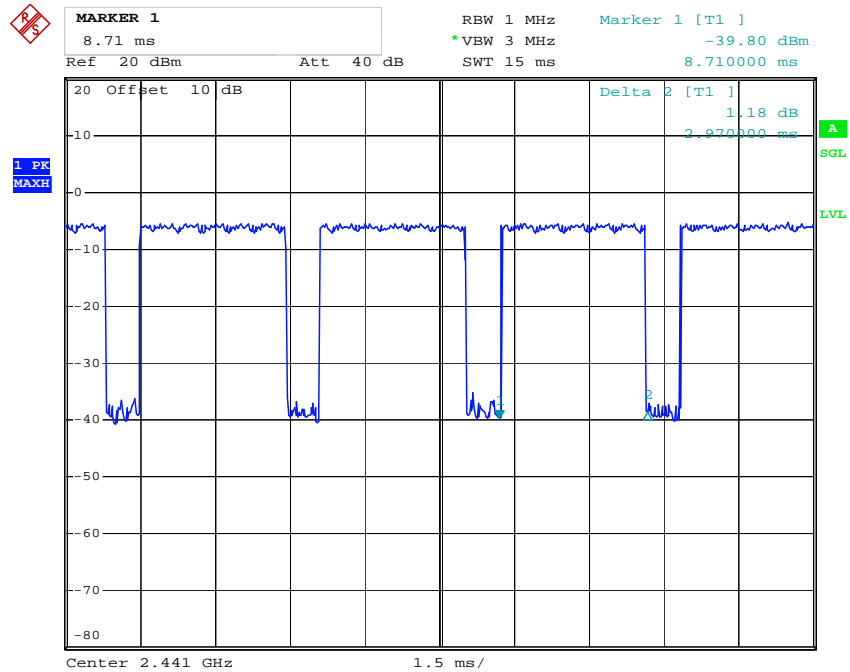

8DPSK

3DH1 Middle channel

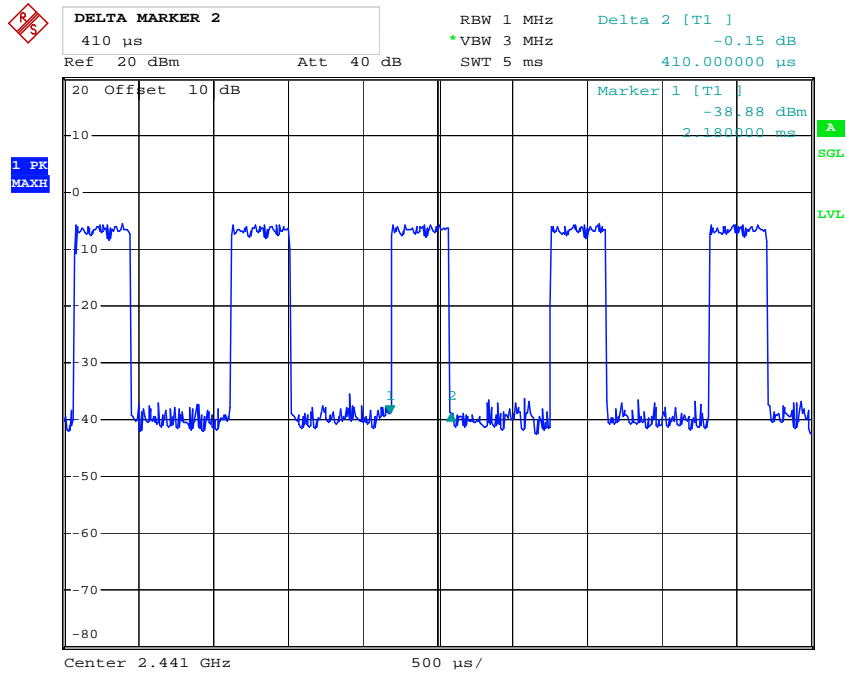

Comment A:  
Date: 17.APR.2019 21:36:46

3DH3 Middle channel

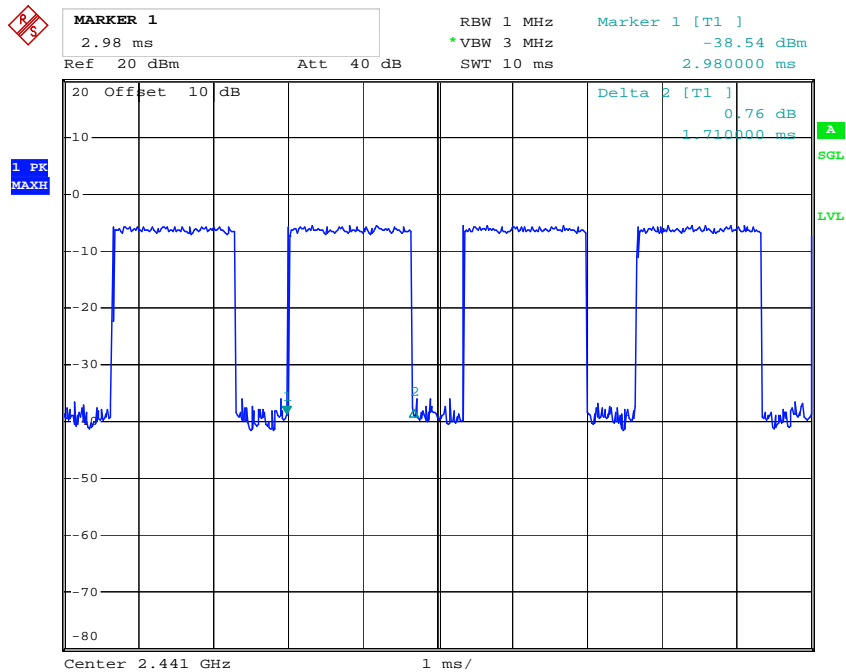

Comment A:  
Date: 17.APR.2019 21:38:23

### 3DH5 Middle channel

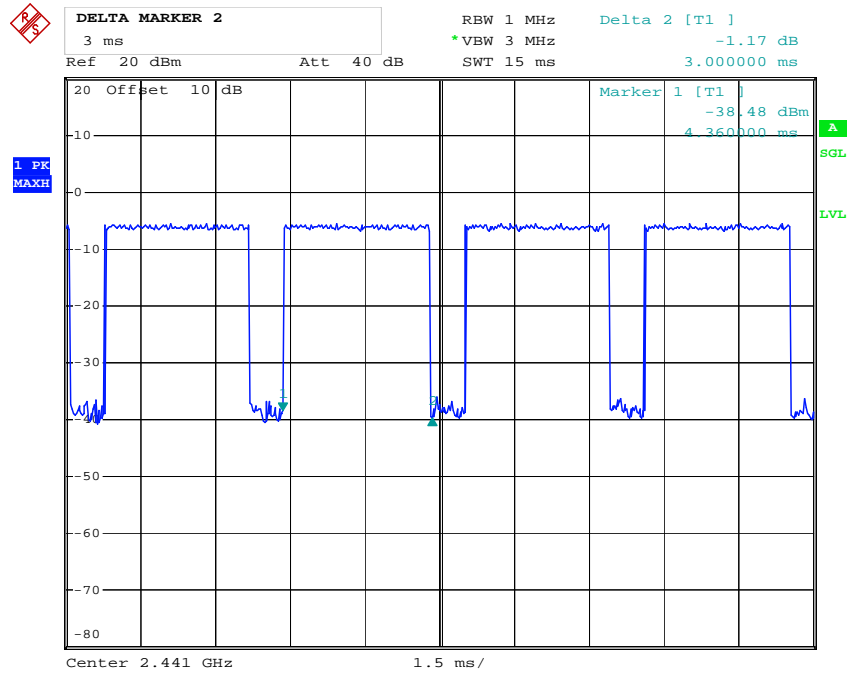

Comment A:  
Date: 17.APR.2019 21:39:16



## 9. MAXIMUM PEAK OUTPUT POWER TEST

### 9.1. Block Diagram of Test Setup

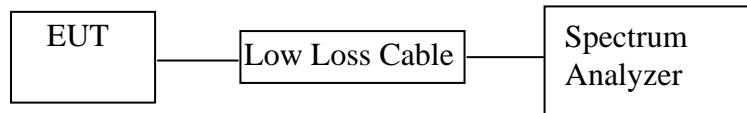

(EUT: Massage Chair)

### 9.2. The Requirement For Section 15.247(b)(1)

Section 15.247(b)(1): For frequency hopping systems operating in the 2400-2483.5 MHz band employing at least 75 non-overlapping hopping channels, and all frequency hopping systems in the 5725-5850 MHz band: 1 watt. For all other frequency hopping systems in the 2400-2483.5 MHz band: 0.125 watts.

### 9.3. EUT Configuration on Measurement

The equipment are installed on the emission Measurement to meet the commission requirements and operating regulations in a manner which tends to maximize its emission characteristics in normal application.

### 9.4. Operating Condition of EUT

9.4.1. Setup the EUT and simulator as shown as Section 9.1.

9.4.2. Turn on the power of all equipment.

9.4.3. Let the EUT work in TX (Hopping off) modes measure it. The transmit frequency are 2402-2480MHz. We select 2402MHz, 2441MHz, and 2480MHz TX frequency to transmit.

### 9.5. Test Procedure

9.5.1. The transmitter output was connected to the spectrum analyzer through a low loss cable.

9.5.2. Set RBW of spectrum analyzer to 3MHz and VBW to 10MHz.

9.5.3. Measurement the maximum peak output power.

## 9.6. Test Result

Test Lab: Shielding room

### GFSK Mode

Channel	Frequency (MHz)	Peak Output Power (dBm/W)	Limits dBm / W
Low	2402	-1.25/0.0007	21 / 0.125
Middle	2441	-1.19/0.0008	21 / 0.125
High	2480	-1.25/0.0007	21 / 0.125

### Π/4-DQPSK Mode

Channel	Frequency (MHz)	Peak Output Power (dBm/W)	Limits dBm / W
Low	2402	0.82/0.0012	21 / 0.125
Middle	2441	0.85/0.0012	21 / 0.125
High	2480	0.85/0.0012	21 / 0.125

### 8DPSK

Channel	Frequency (MHz)	Peak Output Power (dBm/W)	Limits dBm / W
Low	2402	1.25/0.0013	21 / 0.125
Middle	2441	1.37/0.0014	21 / 0.125
High	2480	1.28/0.0013	21 / 0.125

The spectrum analyzer plots are attached as below.

## GFSK Mode

### Low channel

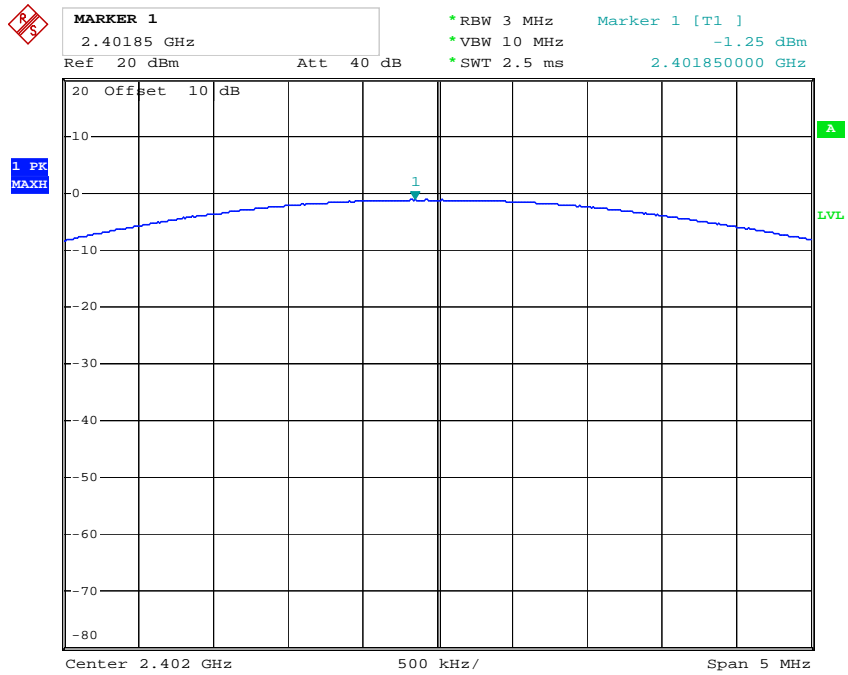

Comment A:  
Date: 17.APR.2019 19:36:52

### Middle channel

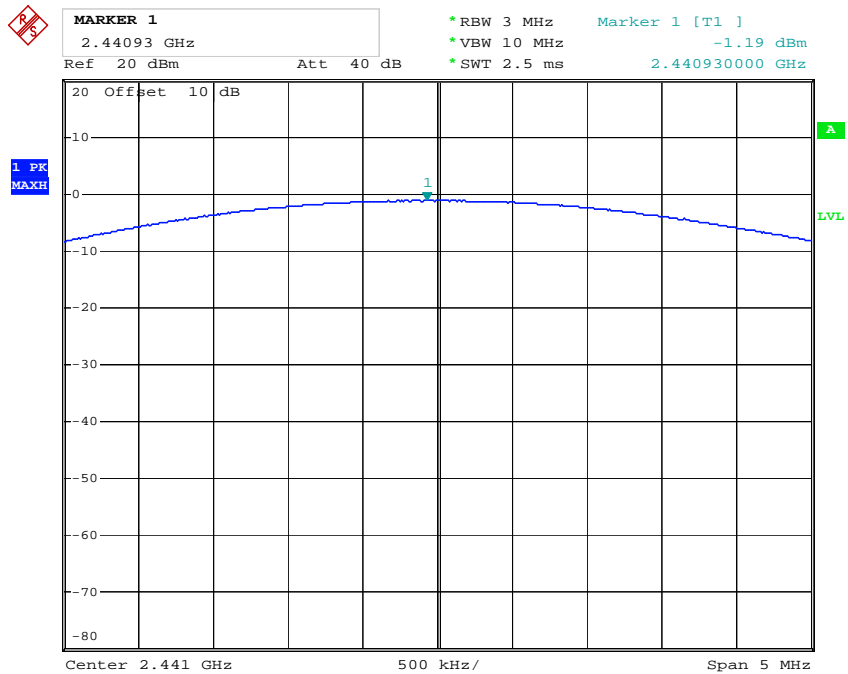

Comment A:  
Date: 17.APR.2019 19:39:08

### High channel

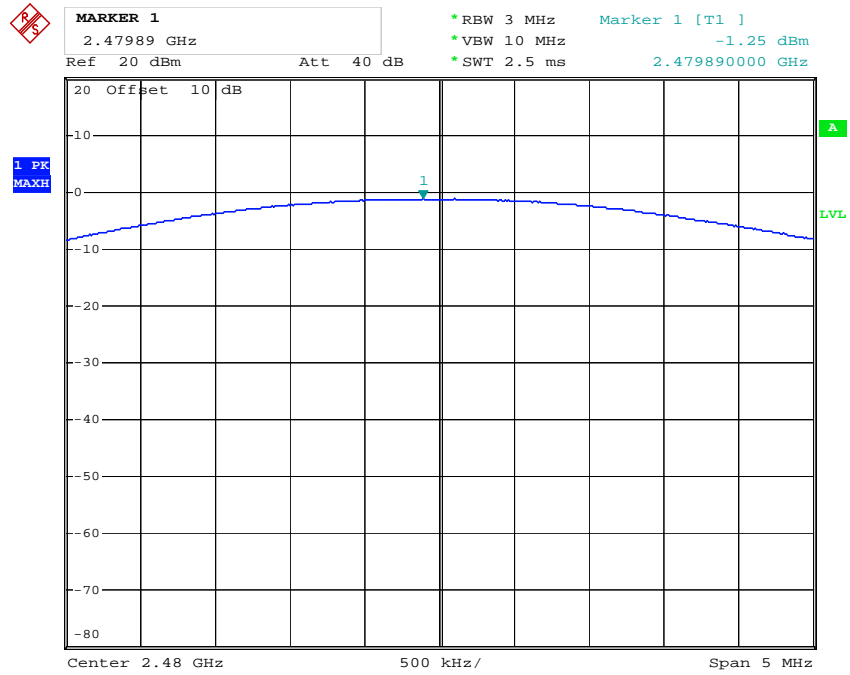

Comment A:  
Date: 17.APR.2019 19:39:53

### Π/4-DQPSK Mode

### Low channel

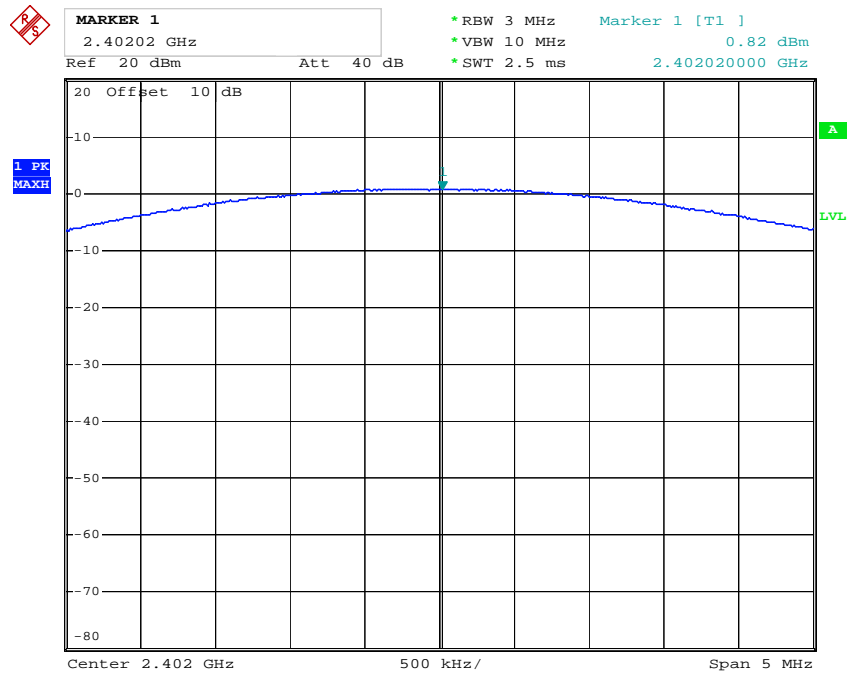

Comment A:  
Date: 17.APR.2019 19:42:17

### Middle channel

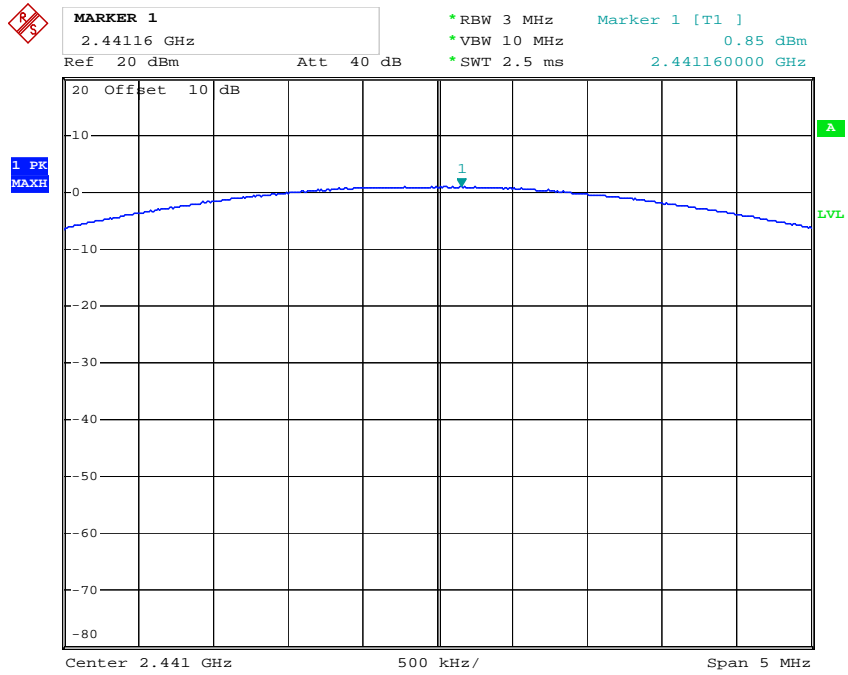

Comment A:  
Date: 17.APR.2019 19:41:46

### High channel

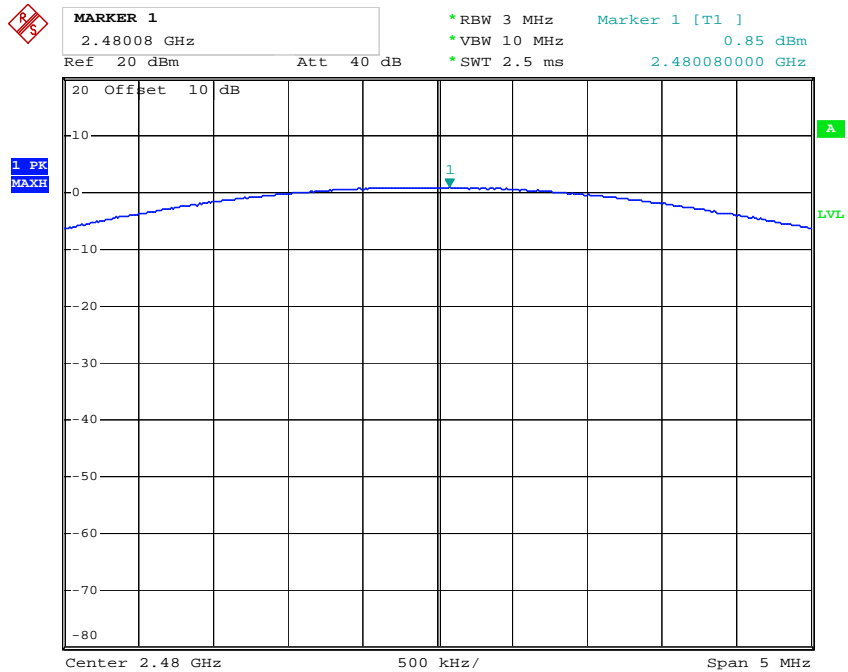

Comment A:  
Date: 17.APR.2019 19:40:53

8DPSK Mode

Low channel

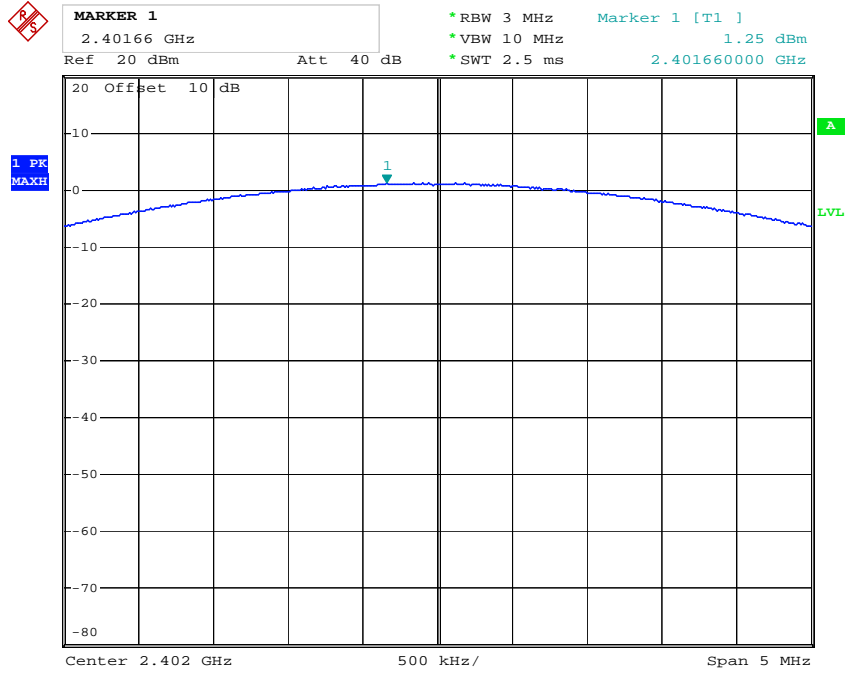

Comment A:  
Date: 17.APR.2019 19:45:04

Middle channel

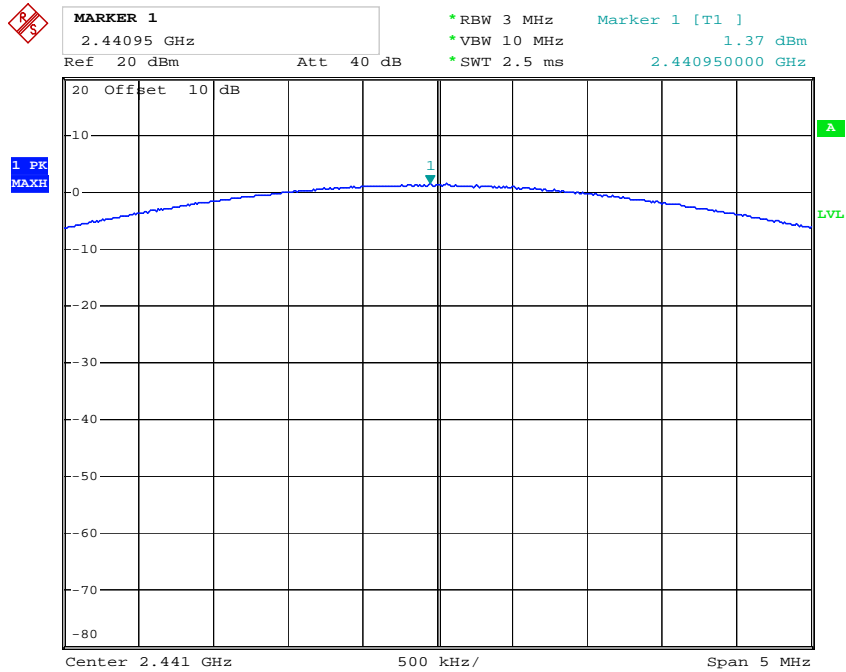

Comment A:  
Date: 17.APR.2019 19:44:28

### High channel

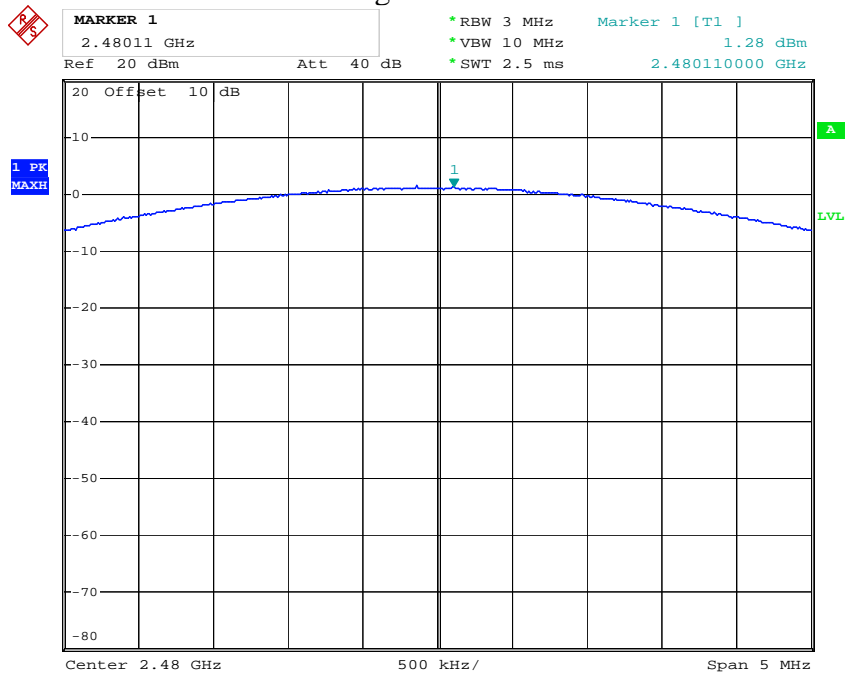

Comment A:  
Date: 17.APR.2019 19:43:52

## 10. RADIATED EMISSION TEST

### 10.1. Block Diagram of Test Setup

#### 10.1.1. Block diagram of connection between the EUT and peripherals

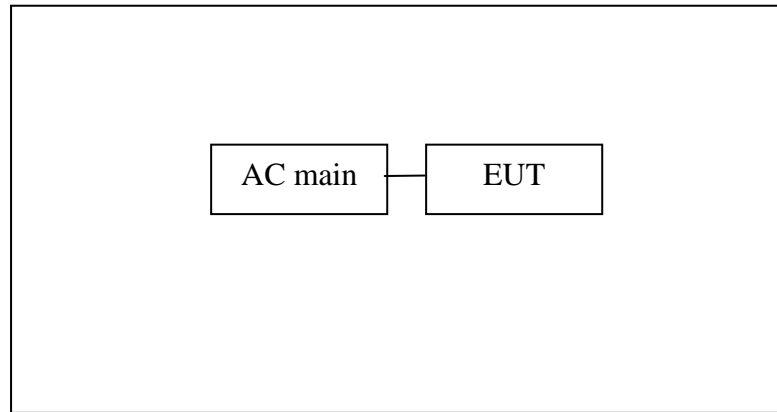

#### 10.1.2. Setup: Transmitting mode Semi-Anechoic Chamber Test Setup Diagram

(A) Radiated Emission Test Set-Up, Frequency below 30MHz

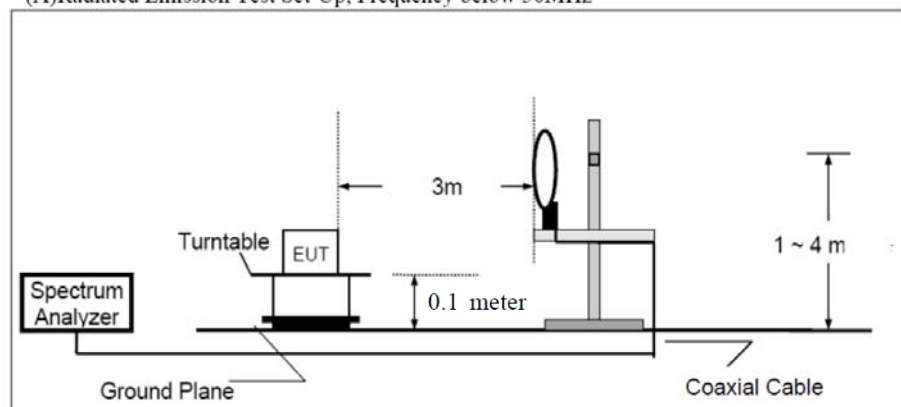



(B) Radiated Emission Test Set-Up, Frequency 30MHz-1GHz

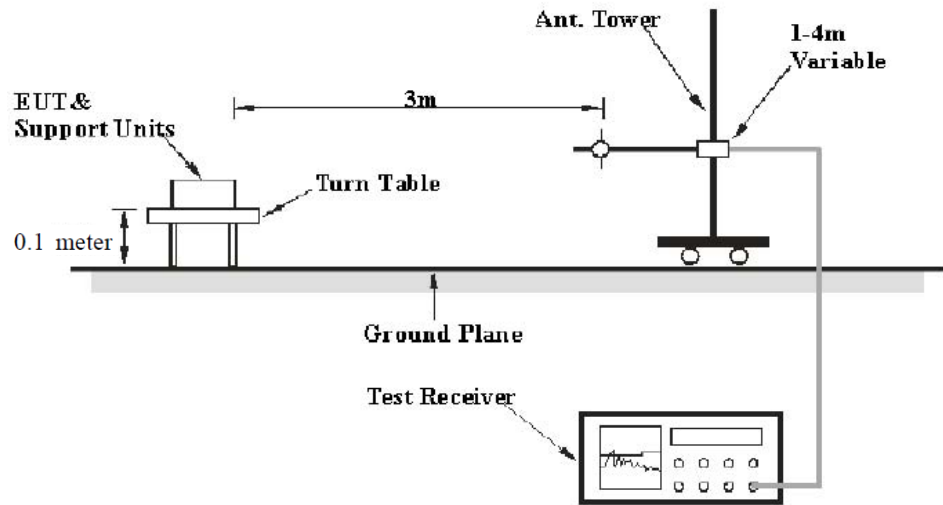

(C) Radiated Emission Test Set-Up, Frequency above 1GHz

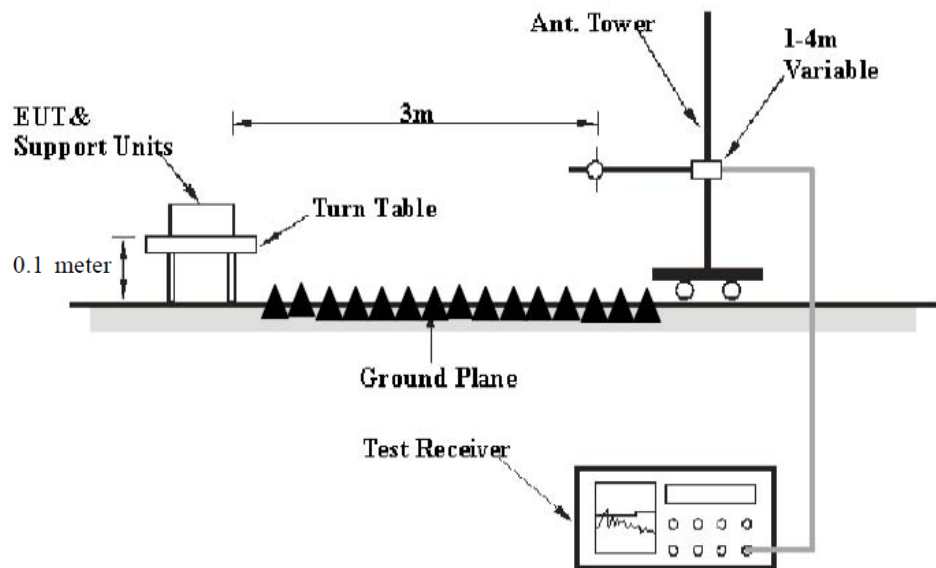

## 10.2. The Limit For Section 15.247(d)

Section 15.247(d): In any 100 kHz bandwidth outside the frequency band in which the spread spectrum or digitally modulated intentional radiator is operating, the radio frequency power that is produced by the intentional radiator shall be at least 20 dB below that in the 100 kHz bandwidth within the band that contains the highest level of the desired power, based on either an RF conducted or a radiated measurement, provided the transmitter demonstrates compliance with the peak conducted power limits. If the transmitter complies with the conducted power limits based on the use of RMS averaging over a time interval, as permitted under paragraph (b)(3) of this section, the attenuation required under this paragraph shall be 30 dB instead of 20 dB. Attenuation below the

general limits specified in Section 15.209(a) is not required. In addition, radiated emissions which fall in the restricted bands, as defined in Section 15.205(a), must also comply with the radiated emission limits specified in Section 15.209(a).

### 10.3.Restricted bands of operation

#### 10.3.1.FCC Part 15.205 Restricted bands of operation

(a) Except as shown in paragraph (d) of this section, Only spurious emissions are permitted in any of the frequency bands listed below:

MHz	MHz	MHz	GHz
0.090-0.110	16.42-16.423	399.9-410	4.5-5.15
<sup>1</sup> 0.495-0.505	16.69475-16.69525	608-614	5.35-5.46
2.1735-2.1905	16.80425-16.80475	960-1240	7.25-7.75
4.125-4.128	25.5-25.67	1300-1427	8.025-8.5
4.17725-4.17775	37.5-38.25	1435-1626.5	9.0-9.2
4.20725-4.20775	73-74.6	1645.5-1646.5	9.3-9.5
6.215-6.218	74.8-75.2	1660-1710	10.6-12.7
6.26775-6.26825	108-121.94	1718.8-1722.2	13.25-13.4
6.31175-6.31225	123-138	2200-2300	14.47-14.5
8.291-8.294	149.9-150.05	2310-2390	15.35-16.2
8.362-8.366	156.52475-156.52525	2483.5-2500	17.7-21.4
8.37625-8.38675	156.7-156.9	2690-2900	22.01-23.12
8.41425-8.41475	162.0125-167.17	3260-3267	23.6-24.0
12.29-12.293	167.72-173.2	3332-3339	31.2-31.8
12.51975-12.52025	240-285	3345.8-3358	36.43-36.5
12.57675-12.57725	322-335.4	3600-4400	( <sup>2</sup> )
13.36-13.41			

<sup>1</sup>Until February 1, 1999, this restricted band shall be 0.490-0.510

<sup>2</sup>Above 38.6

(b) Except as provided in paragraphs (d) and (e), the field strength of emission appearing within these frequency bands shall not exceed the limits shown in Section 15.209. At frequencies equal to or less than 1000MHz, Compliance with the limits in Section 15.209 shall be demonstrated using measurement instrumentation employing a CISPR quasi-peak detector. Above 1000MHz, compliance with the emission limits in Section 15.209 shall be demonstrated based on the average value of the measured emissions. The provisions in Section 15.35 apply to these measurements.

### 10.4.Configuration of EUT on Measurement

The equipment is installed on Radiated Emission Measurement to meet the commission requirements and operating regulations in a manner which tends to maximize its emission characteristics in normal application.

## 10.5. Operating Condition of EUT

10.5.1. Setup the EUT and simulator as shown as Section 10.1.

10.5.2. Turn on the power of all equipment.

10.5.3. Let the EUT work in TX modes measure it. The transmit frequency are 2402-2480MHz. We select 2402MHz, 2441MHz, and 2480MHz TX frequency to transmit.

## 10.6. Test Procedure

The EUT and its simulators are placed on a turntable, which is 0.8 meter high above ground (Below 1GHz). The EUT and its simulators are placed on a turntable, which is 1.5 meter high above ground (Above 1GHz). The turntable can rotate 360 degrees to determine the position of the maximum emission level. EUT is set 3.0 meters away from the receiving antenna, which is mounted on an antenna tower. The antenna can be moved up and down between 1.0 meter and 4 meters to find out the maximum emission level. Broadband antenna (calibrated bi-log antenna) is used as receiving antenna. Both horizontal and vertical polarizations of the antenna are set on measurement. In order to find the maximum emission levels, all of the EUT location must be manipulated according to ANSI C63.10:2013 on radiated emission measurement. This EUT was tested in 3 orthogonal positions and the worst case position data was reported.

During the radiated emission test, the spectrum analyzer was set with the following configurations:

1. The resolution bandwidth and video bandwidth of test receiver/spectrum analyzer is 120kHz for Quasi-peak at frequency below 1GHz.
2. The resolution bandwidth of test receiver/spectrum analyzer is 1MHz and video bandwidth is 3MHz for peak measurement with peak detector at frequency above 1GHz.
3. The resolution bandwidth of test receiver/spectrum analyzer is 1MHz and video bandwidth is 10Hz for Average measurement with peak detection at frequency above 1GHz.
4. All modes of operation were investigated and the worst-case emissions are reported.

### 10.7.Data Sample

Frequency (MHz)	Reading (dB $\mu$ v)	Factor (dB/m)	Result (dB $\mu$ v/m)	Limit (dB $\mu$ v/m)	Margin (dB)	Remark
X.XX	48.69	-13.35	35.34	46	-10.66	QP

Frequency(MHz) = Emission frequency in MHz

Reading(dB $\mu$ v) = Uncorrected Analyzer/Receiver reading

Factor (dB/m) = Antenna factor + Cable Loss – Amplifier gain

Result(dB $\mu$ v/m) = Reading(dB $\mu$ v) + Factor(dB/m)

Limit (dB $\mu$ v/m) = Limit stated in standard

Margin (dB) = Result(dB $\mu$ v/m) - Limit (dB $\mu$ v/m)

QP = Quasi-peak Reading

Calculation Formula:

Margin(dB) = Result (dB $\mu$ V/m)–Limit(dB $\mu$ V/m)

Result(dB $\mu$ V/m)= Reading(dB $\mu$ V)+ Factor(dB/m)

The “Margin” column of the following data tables indicates the degree of compliance with the applicable limit. For example, a margin of -7dB means the emission is 7dB below the limit.

### 10.8.The Field Strength of Radiation Emission Measurement Results

**PASS.**

Test Lab: 3m Anechoic chamber

Note: 1.We tested GFSK mode,  $\Pi/4$ -DQPSK & 8DPSK Mode and recorded the worst case data (GFSK mode) for all test mode.

2. Testing is carried out with frequency rang 9kHz to the tenth harmonics, which above 3th Harmonics are attenuated more than 20dB below the permissible limits or the field strength is too small to be measured. The measurements greater than 20dB below the limit from 9kHz to 30MHz and 18 to 26.5GHz.

The spectrum analyzer plots are attached as below.

Below 1GHz



**ACCURATE TECHNOLOGY CO., LTD.**

F1,Bldg,A,Changyuan New Material Port Keyuan Rd,  
Science & Industry Park,Nanshan Shenzhen,P.R.China

Site: 1# Chamber

Tel:+86-0755-26503290

Fax:+86-0755-26503396

Job No.: jp2019 #102

Standard: FCC Class B 3M Radiated

Test item: Radiation Test

Temp.( C)/Hum.(%) 25 C / 55 %

EUT: Massage Chair

Mode: TX 2402MHz

Model: HMC-600

Manufacturer: XIAMEN OGAWA INTELLIGENT HEALTH EQUIPMENT CO., LTD

Polarization: Vertical

Power Source: AC 120V/60Hz

Date: 19/04/17/

Time: 10/34/52

Engineer Signature: Ben

Distance: 3m

Note: Report NO.:ATE20190505



No.	Freq. (MHz)	Reading (dBuV/m)	Factor (dB)	Result (dBuV/m)	Limit (dBuV/m)	Margin (dB)	Detector	Height (cm)	Degree (deg.)	Remark
1	30.1053	56.63	-20.23	36.40	40.00	-3.60	QP	100	236	
2	43.3853	58.66	-24.16	34.50	40.00	-5.50	QP	100	185	
3	66.8395	57.16	-27.36	29.80	40.00	-10.20	QP	100	96	
4	128.9385	60.29	-27.69	32.60	43.50	-10.90	QP	100	63	
5	174.4265	65.06	-26.46	38.60	43.50	-4.90	QP	100	175	
6	216.8803	61.86	-24.04	37.82	46.00	-8.18	QP	100	196	



**ACCURATE TECHNOLOGY CO., LTD.**

F1,Bldg,A,Changyuan New Material Port Keyuan Rd,  
Science & Industry Park,Nanshan Shenzhen,P.R.China

Site: 1# Chamber  
Tel:+86-0755-26503290  
Fax:+86-0755-26503396

Job No.: jp2019 #103	Polarization: Horizontal
Standard: FCC Class B 3M Radiated	Power Source: AC 120V/60Hz
Test item: Radiation Test	Date: 19/04/17/
Temp.( C)/Hum.(%) 25 C / 55 %	Time: 10/38/01
EUT: Massage Chair	Engineer Signature: Ben
Mode: TX 2402MHz	Distance: 3m
Model: HMC-600	
Manufacturer: XIAMEN OGAWA INTELLIGENT HEALTH EQUIPMENT CO., LTD	

Note: Report NO.:ATE20190505

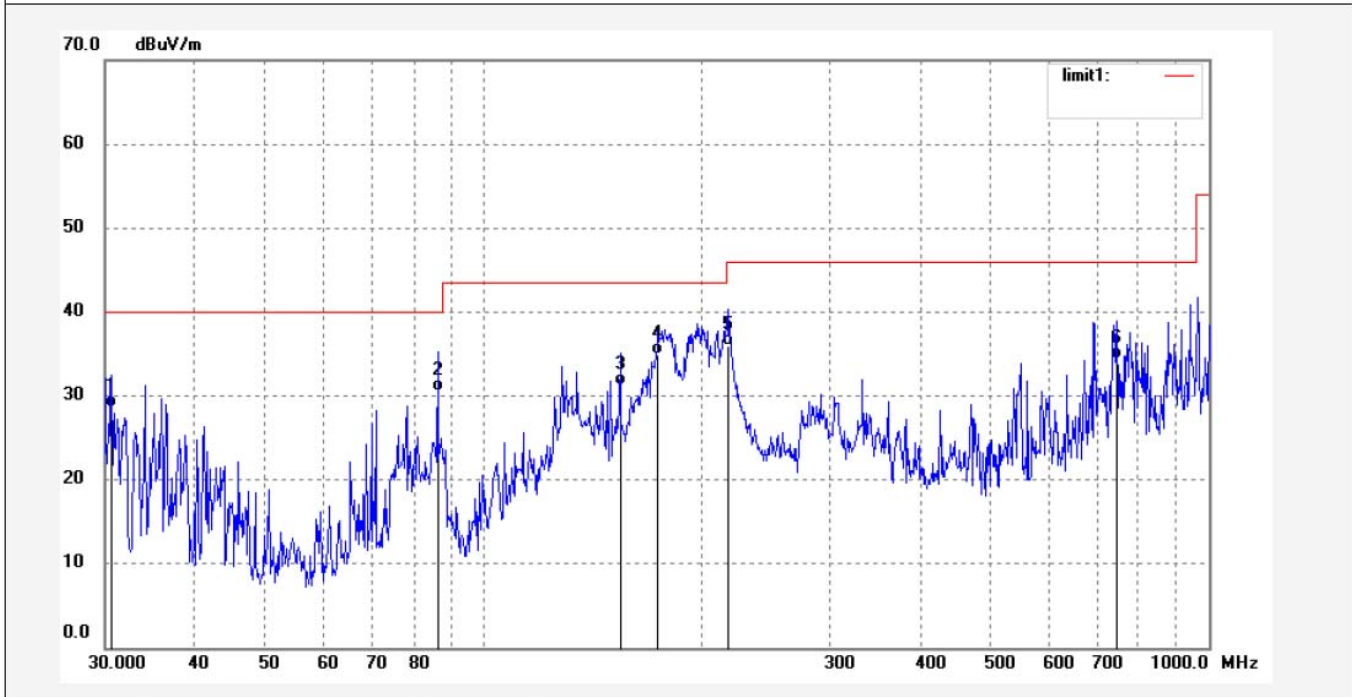

No.	Freq. (MHz)	Reading (dBuV/m)	Factor (dB)	Result (dBuV/m)	Limit (dBuV/m)	Margin (dB)	Detector	Height (cm)	Degree (deg.)	Remark
1	30.6387	48.96	-20.36	28.60	40.00	-11.40	QP	100	123	
2	86.3823	58.05	-27.45	30.60	40.00	-9.40	QP	100	201	
3	154.2427	58.88	-27.68	31.20	43.50	-12.30	QP	100	236	
4	173.8146	61.29	-26.39	34.90	43.50	-8.60	QP	100	196	
5	216.8803	60.04	-24.04	36.00	46.00	-10.00	QP	100	145	
6	747.0465	44.80	-10.40	34.40	46.00	-11.60	QP	100	178	



**ACCURATE TECHNOLOGY CO., LTD.**

F1,Bldg.A,Changyuan New Material Port Keyuan Rd,  
Science & Industry Park,Nanshan Shenzhen,P.R.China

Site: 1# Chamber

Tel:+86-0755-26503290

Fax:+86-0755-26503396

Job No.: jp2019 #104

Standard: FCC Class B 3M Radiated

Test item: Radiation Test

Temp.( C)/Hum.(%) 25 C / 55 %

EUT: Massage Chair

Mode: TX 2441MHz

Model: HMC-600

Manufacturer: XIAMEN OGAWA INTELLIGENT HEALTH EQUIPMENT CO., LTD

Polarization: Horizontal

Power Source: AC 120V/60Hz

Date: 19/04/17/

Time: 10/42/54

Engineer Signature: Ben

Distance: 3m

Note: Report NO.:ATE20190505

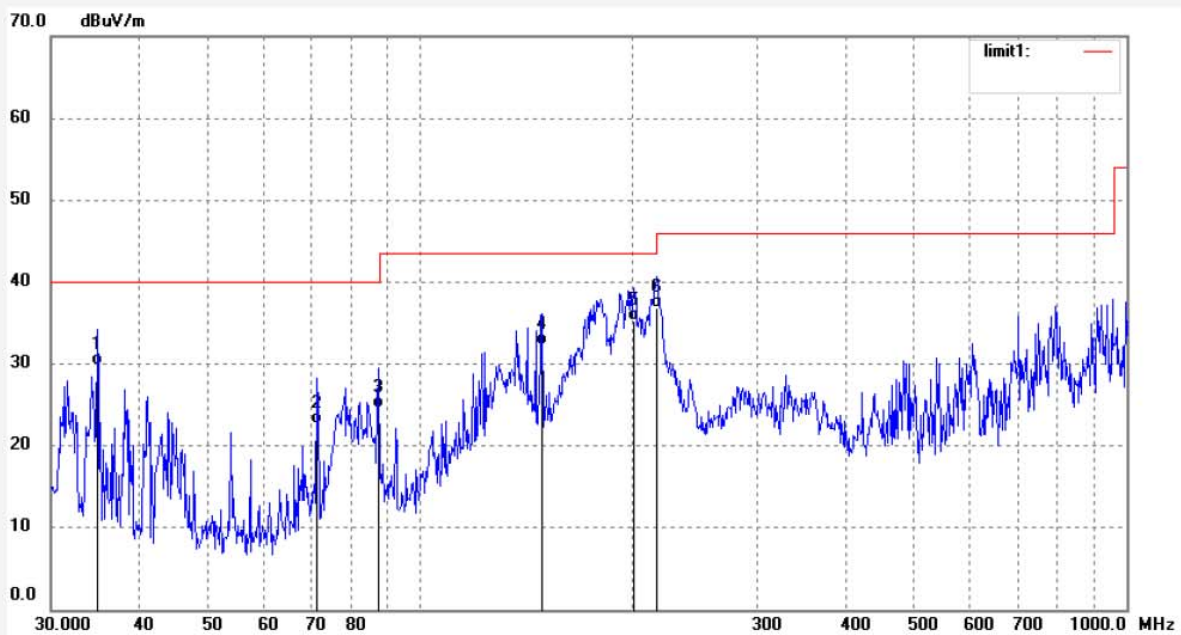

No.	Freq. (MHz)	Reading (dBuV/m)	Factor (dB)	Result (dBuV/m)	Limit (dBuV/m)	Margin (dB)	Detector	Height (cm)	Degree (deg.)	Remark
1	34.8928	51.22	-21.42	29.80	40.00	-10.20	QP	100	136	
2	71.4539	50.24	-27.54	22.70	40.00	-17.30	QP	100	265	
3	87.2980	52.04	-27.44	24.60	40.00	-15.40	QP	100	326	
4	148.9173	60.36	-28.06	32.30	43.50	-11.20	QP	100	65	
5	200.7470	59.64	-24.34	35.30	43.50	-8.20	QP	100	198	
6	216.1194	60.95	-24.05	36.90	46.00	-9.10	QP	100	236	





**ACCURATE TECHNOLOGY CO., LTD.**

F1,Bldg,A,Changyuan New Material Port Keyuan Rd,  
Science & Industry Park,Nanshan Shenzhen,P.R.China

Site: 1# Chamber  
Tel:+86-0755-26503290  
Fax:+86-0755-26503396

Job No.: jp2019 #105

Standard: FCC Class B 3M Radiated

Test item: Radiation Test

Temp.( C)/Hum.(%) 25 C / 55 %

EUT: Massage Chair

Mode: TX 2441MHz

Model: HMC-600

Manufacturer: XIAMEN OGAWA INTELLIGENT HEALTH EQUIPMENT CO., LTD

Polarization: Vertical

Power Source: AC 120V/60Hz

Date: 19/04/17/

Time: 10/46/09

Engineer Signature: Ben

Distance: 3m

Note: Report NO.:ATE20190505

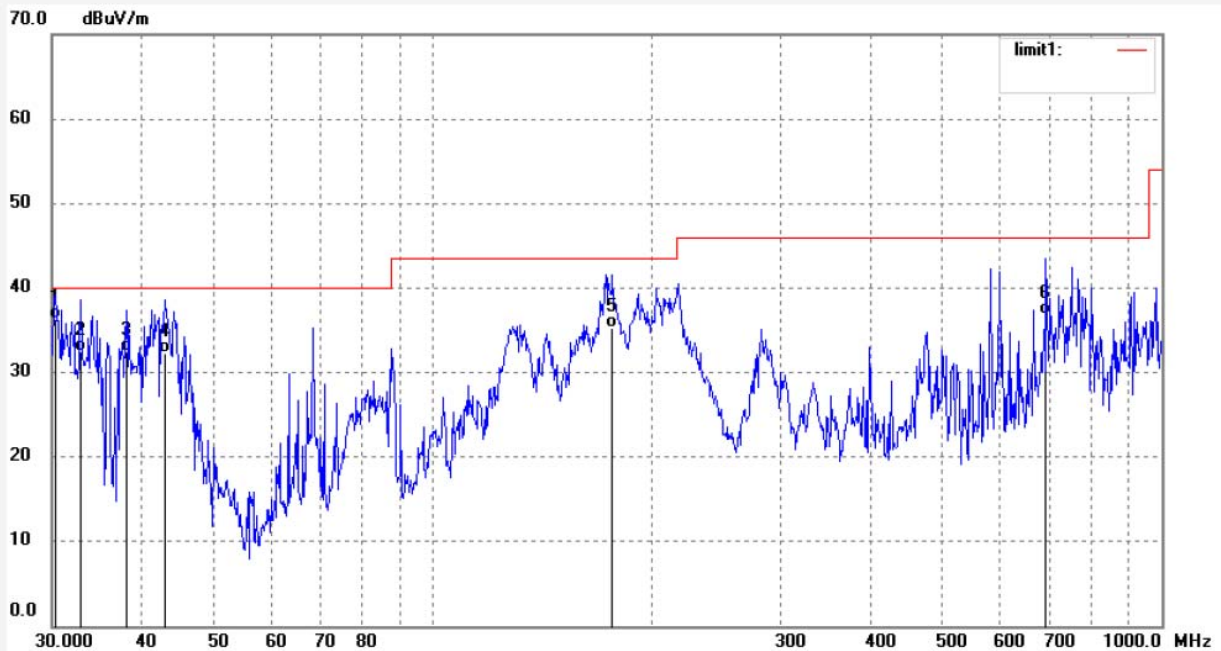

No.	Freq. (MHz)	Reading (dBuV/m)	Factor (dB)	Result (dBuV/m)	Limit (dBuV/m)	Margin (dB)	Detector	Height (cm)	Degree (deg.)	Remark
1	30.3179	56.68	-20.28	36.40	40.00	-3.60	QP	100	123	
2	32.8697	53.31	-20.91	32.40	40.00	-7.60	QP	100	156	
3	37.9628	55.23	-22.73	32.50	40.00	-7.50	QP	100	256	
4	42.9305	56.28	-24.08	32.20	40.00	-7.80	QP	100	190	
5	176.2746	61.59	-26.39	35.20	43.50	-8.30	QP	100	263	
6	693.9101	48.41	-11.61	36.80	46.00	-9.20	QP	100	236	



**ACCURATE TECHNOLOGY CO., LTD.**

F1,Bldg,A,Changyuan New Material Port Keyuan Rd,  
Science & Industry Park,Nanshan Shenzhen,P.R.China

Site: 1# Chamber  
Tel:+86-0755-26503290  
Fax:+86-0755-26503396

Job No.: jp2019 #106	Polarization: Vertical
Standard: FCC Class B 3M Radiated	Power Source: AC 120V/60Hz
Test item: Radiation Test	Date: 19/04/17/
Temp.( C)/Hum.(%) 25 C / 55 %	Time: 10/51/40
EUT: Massage Chair	Engineer Signature: Ben
Mode: TX 2480MHz	Distance: 3m
Model: HMC-600	
Manufacturer: XIAMEN OGAWA INTELLIGENT HEALTH EQUIPMENT CO., LTD	

Note: Report NO.:ATE20190505

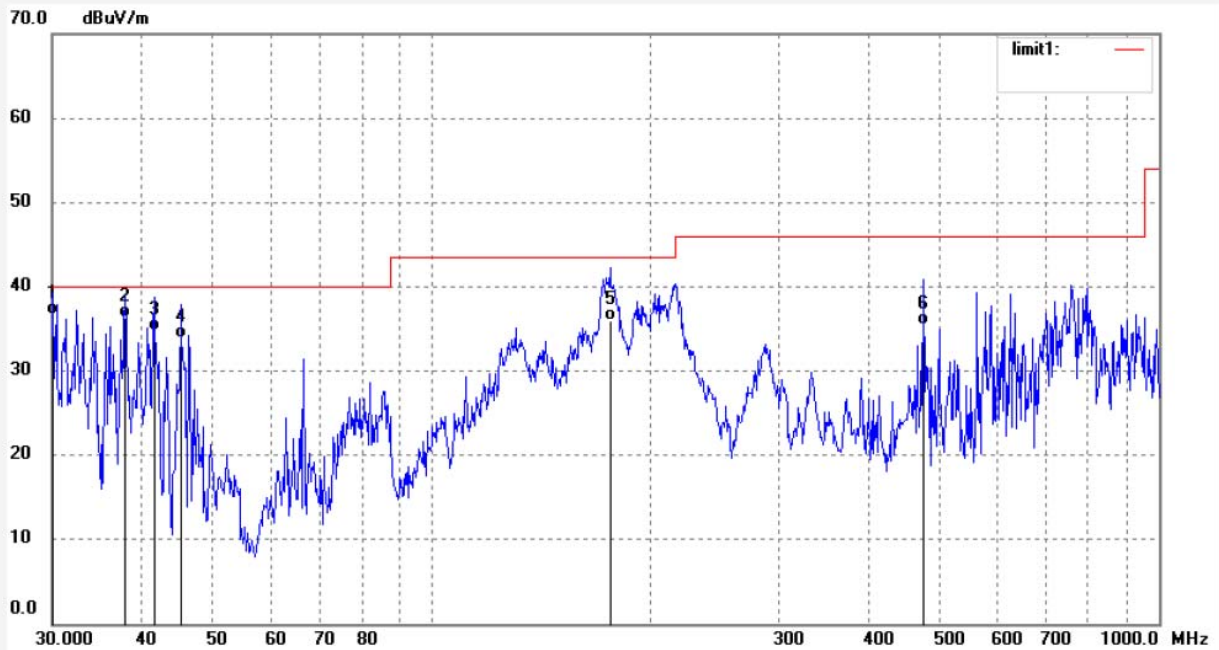

No.	Freq. (MHz)	Reading (dBuV/m)	Factor (dB)	Result (dBuV/m)	Limit (dBuV/m)	Margin (dB)	Detector	Height (cm)	Degree (deg.)	Remark
1	30.0000	56.90	-20.20	36.70	40.00	-3.30	QP	100	123	
2	37.8297	58.97	-22.67	36.30	40.00	-3.70	QP	100	192	
3	41.4483	58.64	-23.84	34.80	40.00	-5.20	QP	100	296	
4	45.0951	58.26	-24.46	33.80	40.00	-6.20	QP	100	123	
5	175.6564	62.34	-26.44	35.90	43.50	-7.60	QP	100	256	
6	474.7912	52.09	-16.69	35.40	46.00	-10.60	QP	100	123	



**ACCURATE TECHNOLOGY CO., LTD.**

F1,Bldg,A,Changyuan New Material Port Keyuan Rd,  
Science & Industry Park,Nanshan Shenzhen,P.R.China

Site: 1# Chamber  
Tel:+86-0755-26503290  
Fax:+86-0755-26503396

Job No.: jp2019 #122

Standard: FCC PK

Test item: Radiation Test

Temp.( C)/Hum.(%) 25 C / 55 %

EUT: Massage Chair

Mode: TX 2402MHz

Model: HMC-600

Manufacturer: XIAMEN OGAWA INTELLIGENT HEALTH EQUIPMENT CO., LTD

Polarization: Horizontal

Power Source: AC 120V/60Hz

Date: 19/04/18/

Time: 10/11/45

Engineer Signature: Ben

Distance: 3m

Note: Report NO.:ATE20190505

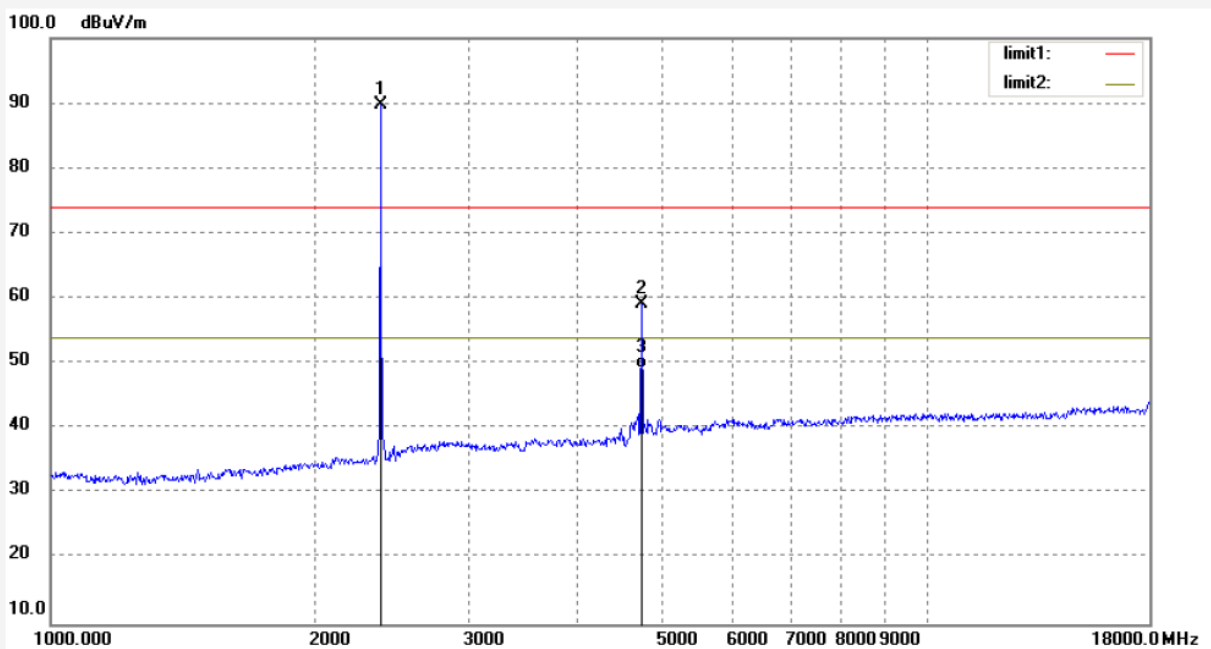

No.	Freq. (MHz)	Reading (dBuV/m)	Factor (dB)	Result (dBuV/m)	Limit (dBuV/m)	Margin (dB)	Detector	Height (cm)	Degree (deg.)	Remark
1	2402.000	96.14	-6.37	89.77			peak	100	23	
2	4804.000	58.48	0.70	59.18	74.00	-14.82	peak	100	236	
3	4804.000	48.60	0.70	49.30	54.00	-4.70	AVG	100	236	

Above 1GHz



**ACCURATE TECHNOLOGY CO., LTD.**

F1,Bldg,A,Changyuan New Material Port Keyuan Rd,  
Science & Industry Park,Nanshan Shenzhen,P.R.China

Site: 1# Chamber  
Tel:+86-0755-26503290  
Fax:+86-0755-26503396

Job No.: jp2019 #123	Polarization: Vertical
Standard: FCC PK	Power Source: AC 120V/60Hz
Test item: Radiation Test	Date: 19/04/18/
Temp.( C)/Hum.(%) 25 C / 55 %	Time: 10/15/14
EUT: Massage Chair	Engineer Signature: Ben
Mode: TX 2402MHz	Distance: 3m
Model: HMC-600	
Manufacturer: XIAMEN OGAWA INTELLIGENT HEALTH EQUIPMENT CO., LTD	

Note: Report NO.:ATE20190505

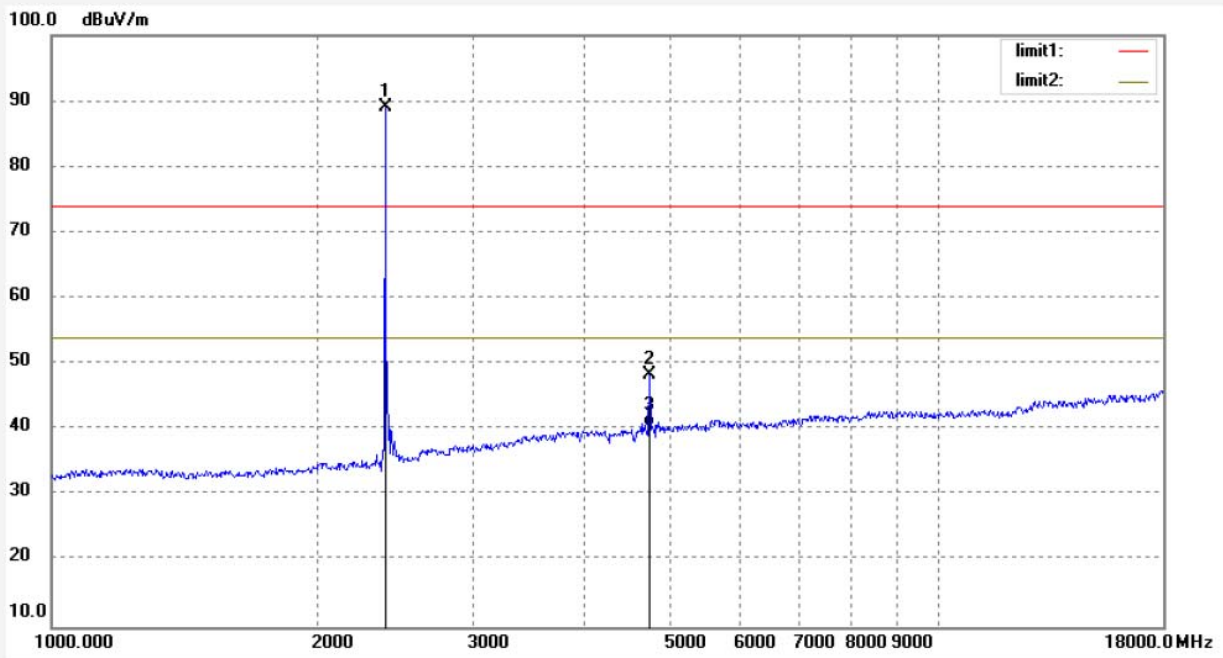

No.	Freq. (MHz)	Reading (dBuV/m)	Factor (dB)	Result (dBuV/m)	Limit (dBuV/m)	Margin (dB)	Detector	Height (cm)	Degree (deg.)	Remark
1	2402.000	95.52	-6.37	89.15			peak	100	125	
2	4804.000	47.67	0.70	48.37	74.00	-25.63	peak	100	195	
3	4804.000	39.80	0.70	40.50	54.00	-13.50	AVG	100	195	



**ACCURATE TECHNOLOGY CO., LTD.**

F1,Bldg,A,Changyuan New Material Port Keyuan Rd,  
Science & Industry Park,Nanshan Shenzhen,P.R.China

Site: 1# Chamber  
Tel:+86-0755-26503290  
Fax:+86-0755-26503396

Job No.: jp2019 #122

Standard: FCC PK

Test item: Radiation Test

Temp.( C)/Hum.(%) 25 C / 55 %

EUT: Massage Chair

Mode: TX 2402MHz

Model: HMC-600

Manufacturer: XIAMEN OGAWA INTELLIGENT HEALTH EQUIPMENT CO., LTD

Polarization: Horizontal

Power Source: AC 120V/60Hz

Date: 19/04/18/

Time: 10/11/45

Engineer Signature: Ben

Distance: 3m

Note: Report NO.:ATE20190505

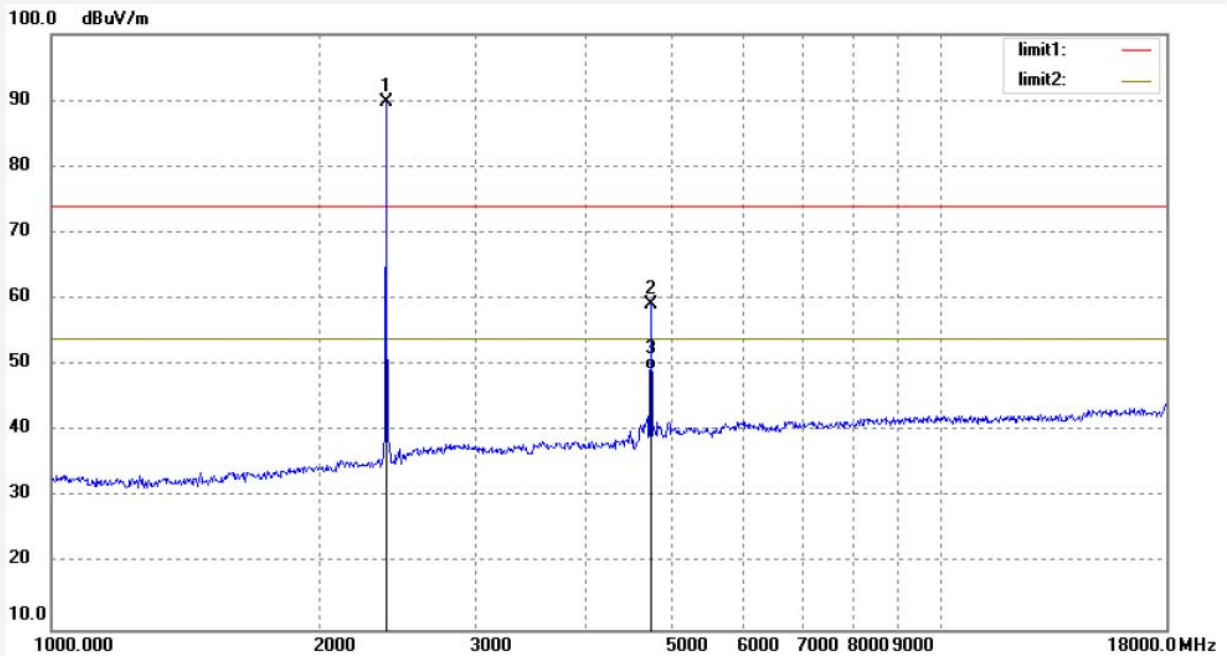

No.	Freq. (MHz)	Reading (dBuV/m)	Factor (dB)	Result (dBuV/m)	Limit (dBuV/m)	Margin (dB)	Detector	Height (cm)	Degree (deg.)	Remark
1	2402.000	96.14	-6.37	89.77			peak	100	23	
2	4804.000	58.48	0.70	59.18	74.00	-14.82	peak	100	236	
3	4804.000	48.60	0.70	49.30	54.00	-4.70	AVG	100	236	



## ACCURATE TECHNOLOGY CO., LTD.

F1,Bldg,A,Changyuan New Material Port Keyuan Rd,  
Science & Industry Park,Nanshan Shenzhen,P.R.China

Site: 1# Chamber

Tel:+86-0755-26503290

Fax:+86-0755-26503396

Job No.: jp2019 #124

Standard: FCC PK

Test item: Radiation Test

Temp.( C)/Hum.(%) 25 C / 55 %

EUT: Massage Chair

Mode: TX 2441MHz

Model: HMC-600

Manufacturer: XIAMEN OGAWA INTELLIGENT HEALTH EQUIPMENT CO., LTD

Polarization: Vertical

Power Source: AC 120V/60Hz

Date: 19/04/18/

Time: 10/18/12

Engineer Signature: Ben

Distance: 3m

Note: Report NO.:ATE20190505

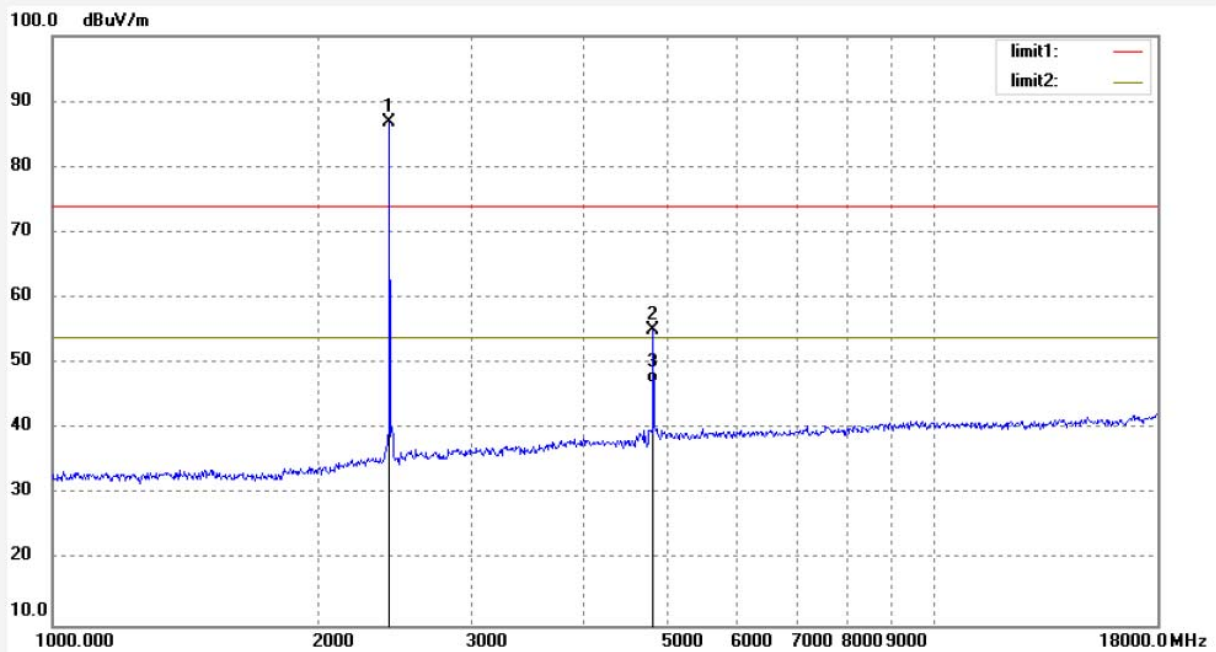

No.	Freq. (MHz)	Reading (dBuV/m)	Factor (dB)	Result (dBuV/m)	Limit (dBuV/m)	Margin (dB)	Detector	Height (cm)	Degree (deg.)	Remark
1	2441.000	92.95	-6.20	86.75			peak	100	67	
2	4882.000	54.09	1.07	55.16	74.00	-18.84	peak	100	156	
3	4882.000	46.03	1.07	47.10	54.00	-6.90	AVG	100	156	



**ACCURATE TECHNOLOGY CO., LTD.**

F1,Bldg,A,Changyuan New Material Port Keyuan Rd,  
Science & Industry Park,Nanshan Shenzhen,P.R.China

Site: 1# Chamber

Tel:+86-0755-26503290

Fax:+86-0755-26503396

Job No.: jp2019 #125

Standard: FCC PK

Test item: Radiation Test

Temp.( C)/Hum.(%) 25 C / 55 %

EUT: Massage Chair

Mode: TX 2441MHz

Model: HMC-600

Manufacturer: XIAMEN OGAWA INTELLIGENT HEALTH EQUIPMENT CO., LTD

Polarization: Horizontal

Power Source: AC 120V/60Hz

Date: 19/04/18/

Time: 10/21/24

Engineer Signature: Ben

Distance: 3m

Note: Report NO.:ATE20190505

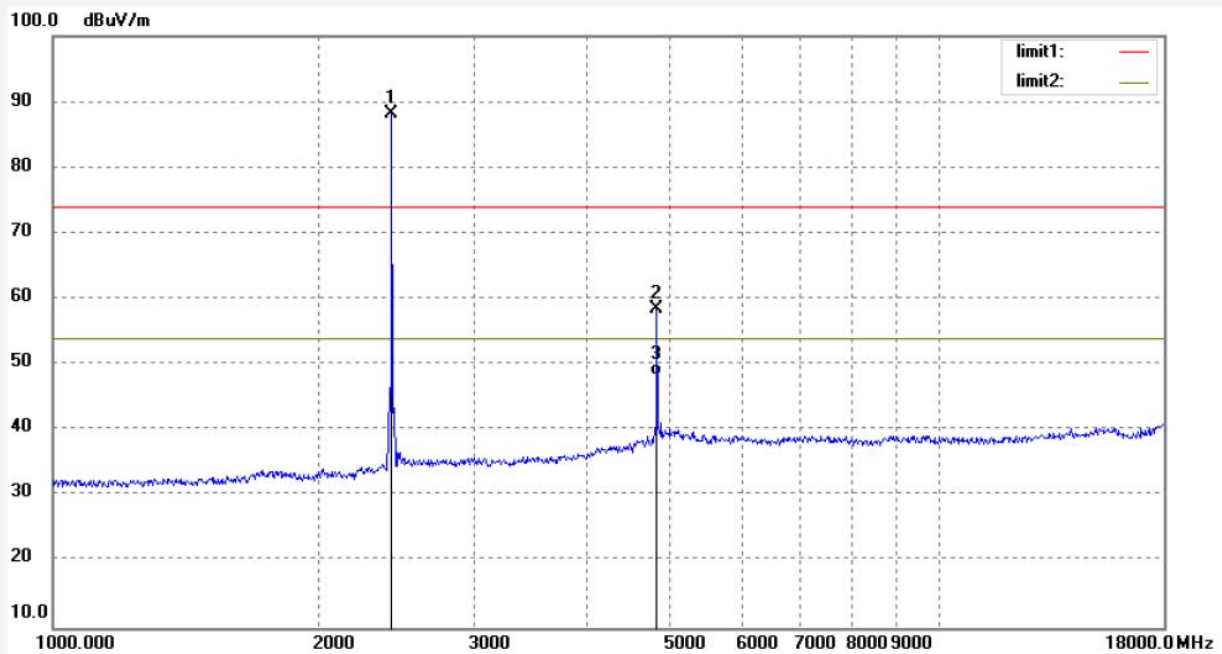

No.	Freq. (MHz)	Reading (dBuV/m)	Factor (dB)	Result (dBuV/m)	Limit (dBuV/m)	Margin (dB)	Detector	Height (cm)	Degree (deg.)	Remark
1	2441.000	94.41	-6.20	88.21			peak	100	168	
2	4882.000	57.45	1.07	58.52	74.00	-15.48	peak	100	156	
3	4882.000	47.23	1.07	48.30	54.00	-5.70	AVG	100	156	



**ACCURATE TECHNOLOGY CO., LTD.**

F1,Bldg,A,Changyuan New Material Port Keyuan Rd,  
Science & Industry Park,Nanshan Shenzhen,P.R.China

Site: 1# Chamber  
Tel:+86-0755-26503290  
Fax:+86-0755-26503396

Job No.: jp2019 #126	Polarization: Horizontal
Standard: FCC PK	Power Source: AC 120V/60Hz
Test item: Radiation Test	Date: 19/04/18/
Temp.( C)/Hum.(%) 25 C / 55 %	Time: 10/23/59
EUT: Massage Chair	Engineer Signature: Ben
Mode: TX 2480MHz	Distance: 3m
Model: HMC-600	
Manufacturer: XIAMEN OGAWA INTELLIGENT HEALTH EQUIPMENT CO., LTD	

Note: Report NO.:ATE20190505

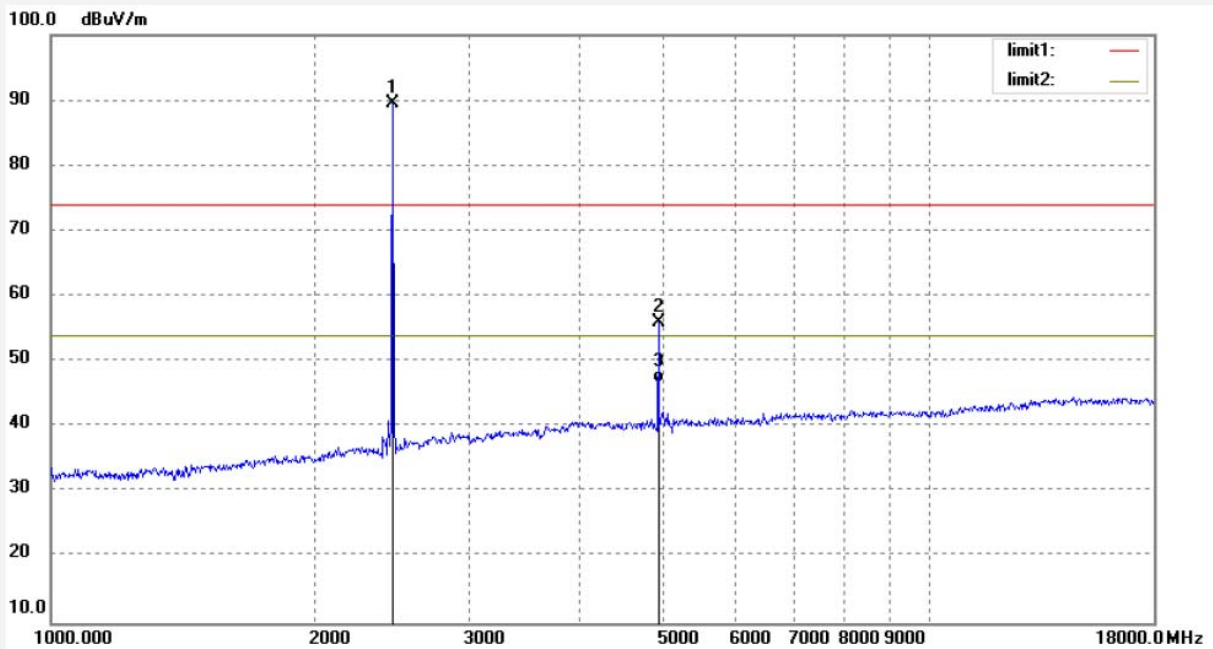

No.	Freq. (MHz)	Reading (dBuV/m)	Factor (dB)	Result (dBuV/m)	Limit (dBuV/m)	Margin (dB)	Detector	Height (cm)	Degree (deg.)	Remark
1	2480.000	95.61	-6.04	89.57			peak	100	256	
2	4960.000	54.54	1.50	56.04	74.00	-17.96	peak	100	145	
3	4960.000	45.40	1.50	46.90	54.00	-7.10	AVG	100	145	





**ACCURATE TECHNOLOGY CO., LTD.**

F1,Bldg,A,Changyuan New Material Port Keyuan Rd,  
Science & Industry Park,Nanshan Shenzhen,P.R.China

Site: 1# Chamber

Tel:+86-0755-26503290

Fax:+86-0755-26503396

Job No.: jp2019 #127

Standard: FCC PK

Test item: Radiation Test

Temp.( C)/Hum.(%) 25 C / 55 %

EUT: Massage Chair

Mode: TX 2480MHz

Model: HMC-600

Manufacturer: XIAMEN OGAWA INTELLIGENT HEALTH EQUIPMENT CO., LTD

Polarization: Vertical

Power Source: AC 120V/60Hz

Date: 19/04/18/

Time: 10/26/36

Engineer Signature: Ben

Distance: 3m

Note: Report NO.:ATE20190505

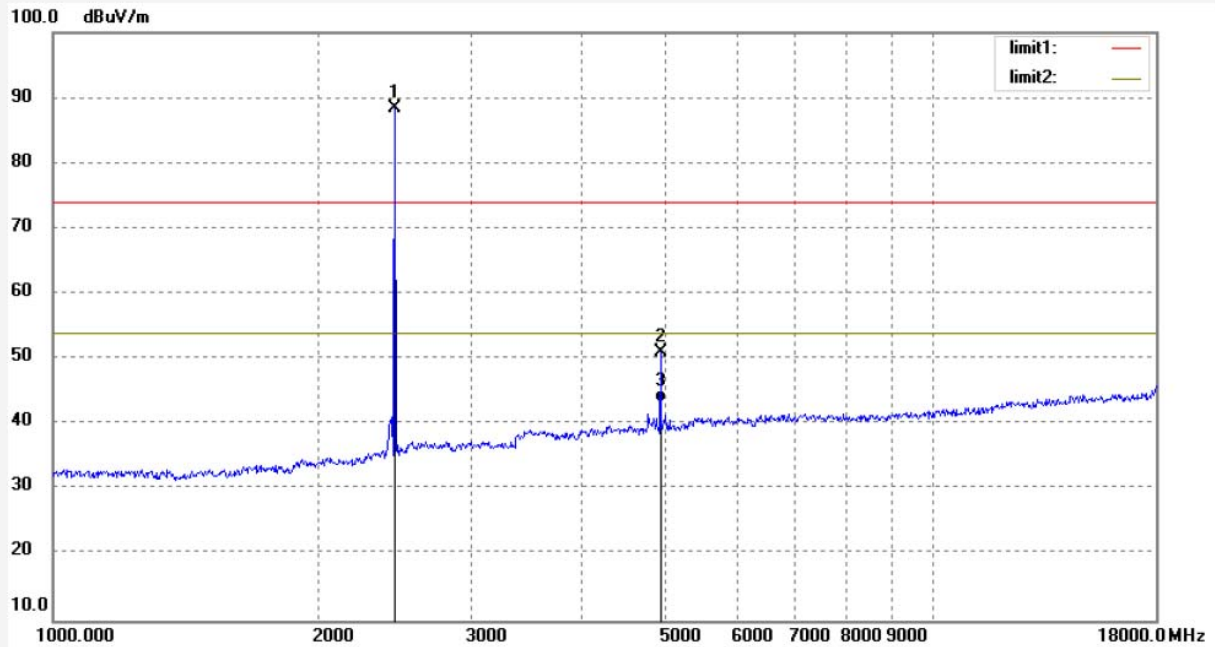

No.	Freq. (MHz)	Reading (dBuV/m)	Factor (dB)	Result (dBuV/m)	Limit (dBuV/m)	Margin (dB)	Detector	Height (cm)	Degree (deg.)	Remark
1	2480.000	94.53	-6.04	88.49			peak	100	310	
2	4960.000	49.65	1.50	51.15	74.00	-22.85	peak	100	203	
3	4960.000	42.00	1.50	43.50	54.00	-10.50	AVG	100	203	

## 11. BAND EDGE COMPLIANCE TEST

### 11.1. Block Diagram of Test Setup

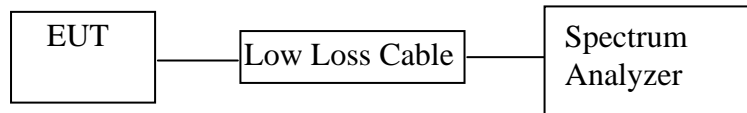

(EUT: Massage Chair)

### 11.2. The Requirement For Section 15.247(d)

Section 15.247(d): In any 100 kHz bandwidth outside the frequency band in which the spread spectrum or digitally modulated intentional radiator is operating, the radio frequency power that is produced by the intentional radiator shall be at least 20 dB below that in the 100 kHz bandwidth within the band that contains the highest level of the desired power, based on either an RF conducted or a radiated measurement, provided the transmitter demonstrates compliance with the peak conducted power limits. If the transmitter complies with the conducted power limits based on the use of RMS averaging over a time interval, as permitted under paragraph (b)(3) of this section, the attenuation required under this paragraph shall be 30 dB instead of 20 dB. Attenuation below the general limits specified in Section 15.209(a) is not required. In addition, radiated emissions which fall in the restricted bands, as defined in Section 15.205(a), must also comply with the radiated emission limits specified in Section 15.209(a).

### 11.3. EUT Configuration on Measurement

The equipment are installed on the emission Measurement to meet the commission requirements and operating regulations in a manner which tends to maximize its emission characteristics in normal application.

### 11.4. Operating Condition of EUT

11.4.1. Setup the EUT and simulator as shown as Section 11.1.

11.4.2. Turn on the power of all equipment.

11.4.3. Let the EUT work in TX (Hopping off, Hopping on) modes measure it. The transmit frequency are 2402-2480MHz. We select 2402MHz, 2480MHz TX frequency to transmit.

### 11.5. Test Procedure

11.5.1. The transmitter output was connected to the spectrum analyzer via a low loss cable.

11.5.2. Set RBW of spectrum analyzer to 100 kHz and VBW to 300 kHz with convenient frequency span including 100 kHz bandwidth from band edge.

11.5.3. The band edges was measured and recorded.

### 11.6. Test Result

Test Lab: Shielding room

Note: Both hopping-on mode and hopping-off mode had been pre-tested, and only the worst case was recorded in the test report.

Frequency (MHz)	Result of Band Edge (dBc)	Limit of Band Edge (dBc)
GFSK Mode		
2400.00	43.26	> 20dBc
2483.50	46.58	> 20dBc
Π/4-DQPSK Mode		
2400.00	44.49	> 20dBc
2483.50	47.03	> 20dBc
8DPSK Mode		
2400.00	45.21	> 20dBc
2483.50	46.82	> 20dBc

The spectrum analyzer plots are attached as below.

## GFSK Mode

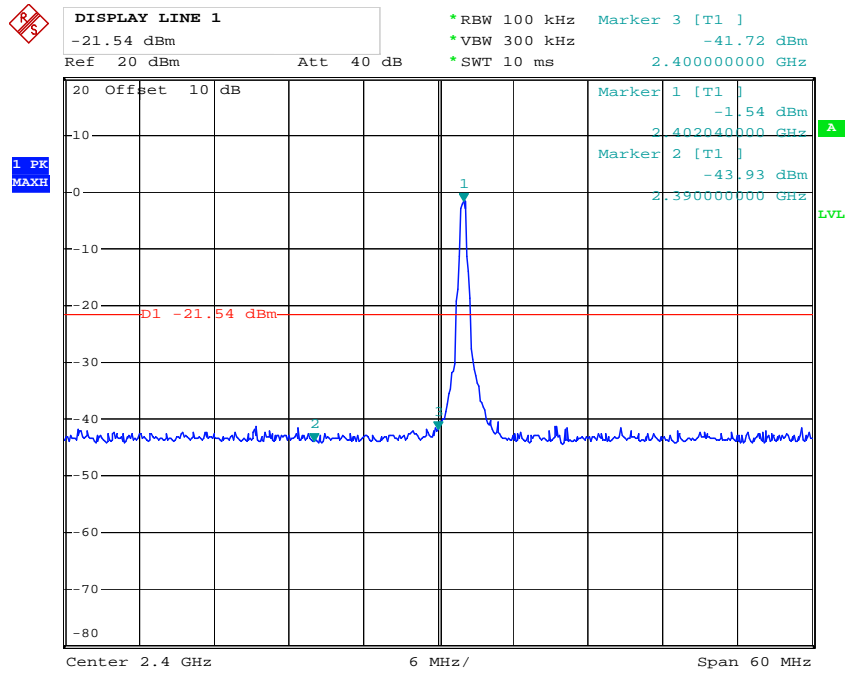

Comment A:  
 Date: 18.APR.2019 12:19:20

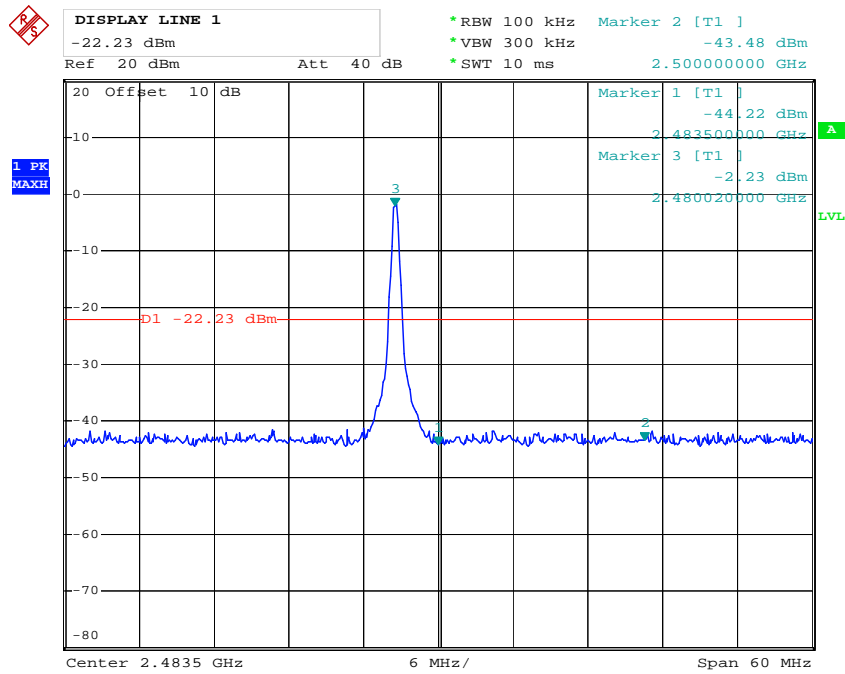

Comment A:  
 Date: 18.APR.2019 10:19:55

### Π/4-DQPSK Mode

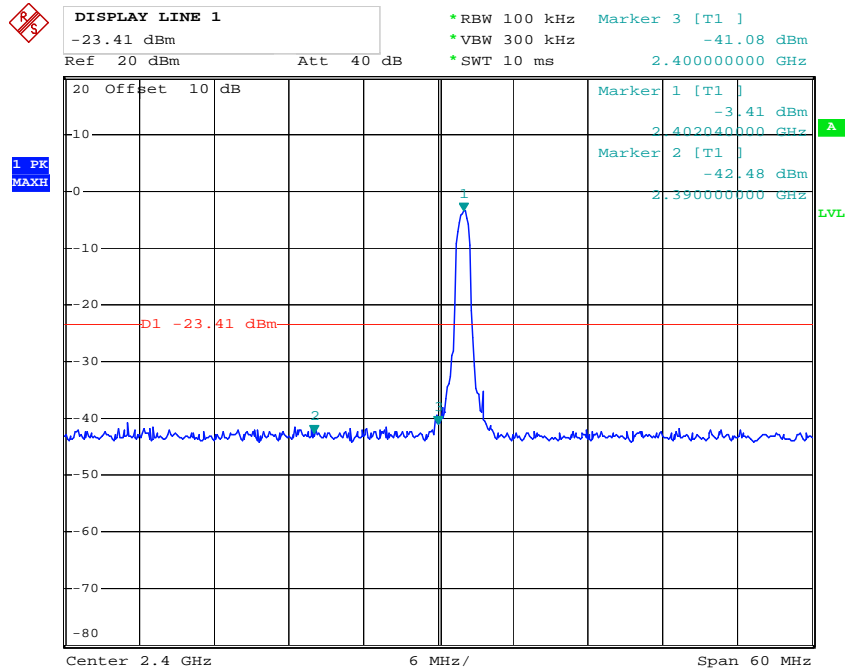

Comment A:  
Date: 18.APR.2019 10:24:31

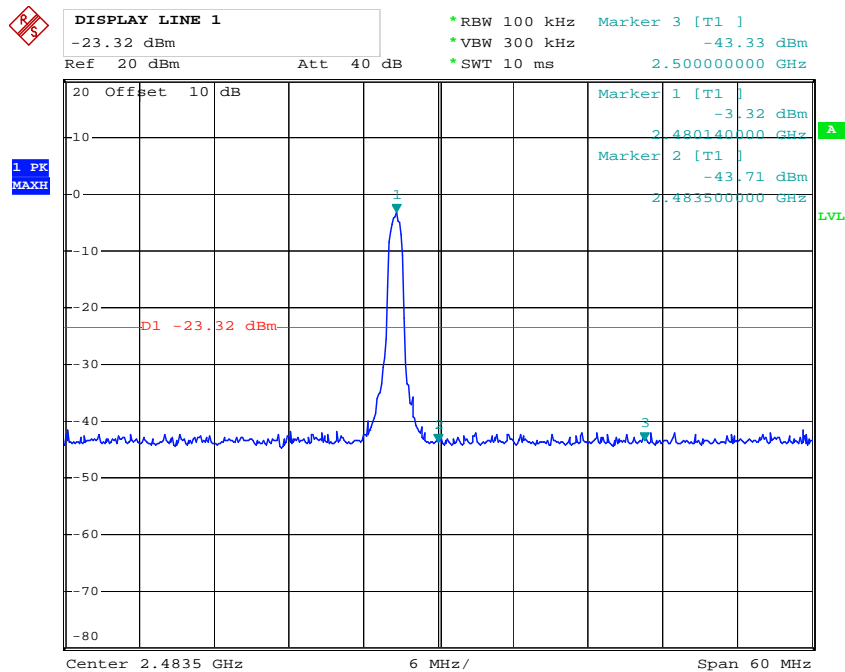

Comment A:  
Date: 18.APR.2019 10:33:19

## 8DPSK Mode

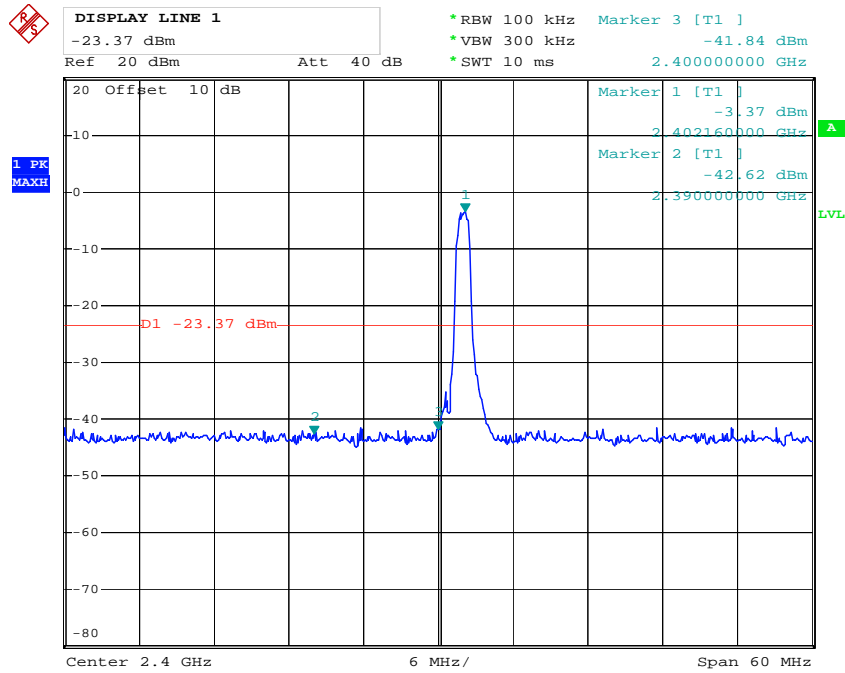

Comment A:  
Date: 18.APR.2019 10:26:14

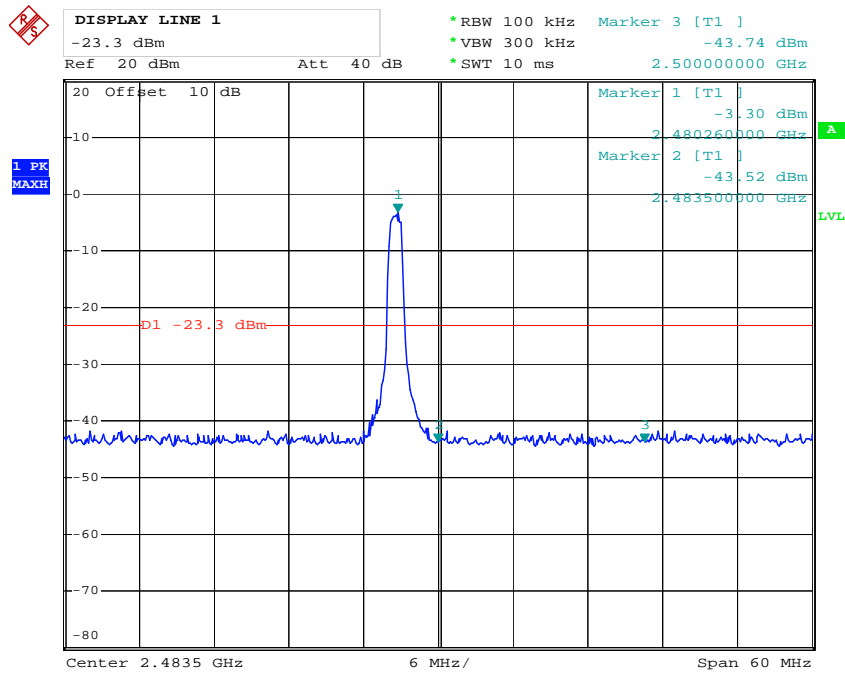

Comment A:  
Date: 18.APR.2019 10:28:15

## Radiated Band Edge Result

Note:

1. Emissions attenuated more than 20 dB below the permissible value are not reported.
2. The field strength is calculated by adding the antenna factor, high pass filter loss(if used) and cable loss, and subtracting the amplifier gain(if any)from the measured reading. The basic equation calculation is as follows:

Result = Reading + Corrected Factor

3. Display the measurement of peak values.

Test Procedure:

The EUT and its simulators are placed on a turntable, which is 1.5 meter high above ground(Above 1GHz). The turntable can rotate 360 degrees to determine the position of the maximum emission level. EUT is set 3.0 meters away from the receiving antenna, which is mounted on an antenna tower. The antenna can be moved up and down between 1.0 meter and 4 meters to find out the maximum emission level. Broadband antenna (calibrated bi-log antenna) is used as receiving antenna. Both horizontal and vertical polarizations of the antenna are set on measurement. In order to find the maximum emission levels, all of the EUT location must be manipulated according to ANSI C63.10:2013 on radiated emission measurement. The EUT was tested in 3 orthogonal planes.

Let the EUT work in TX (Hopping off, Hopping on) modes measure it.  
We select 2402MHz, 2480MHz TX frequency to transmit(Hopping off mode).  
We select 2402-2480MHz TX frequency to transmit(Hopping on mode).

During the radiated emission test, the spectrum analyzer was set with the following configurations:

- 1.The resolution bandwidth of test receiver/spectrum analyzer is 1MHz and video bandwidth is 3MHz for peak measurement with peak detector at frequency above 1GHz.
- 2.The resolution bandwidth of test receiver/spectrum analyzer is 1MHz and video bandwidth is 10Hz for Average measurement with peak detection at frequency above 1GHz.
- 3.All modes of operation were investigated and the worst case (GFSK mode) emissions are reported.

Test Lab: 3m Anechoic chamber

Non-hopping mode



**ACCURATE TECHNOLOGY CO., LTD.**

F1,Bldg,A,Changyuan New Material Port Keyuan Rd,  
Science & Industry Park,Nanshan Shenzhen,P.R.China

Site: 1# Chamber  
Tel:+86-0755-26503290  
Fax:+86-0755-26503396

Job No.: jp2019 #130	Polarization: Horizontal
Standard: FCC PK	Power Source: AC 120V/60Hz
Test item: Radiation Test	Date: 19/04/18/
Temp.( C)/Hum.(%) 25 C / 55 %	Time: 10/38/39
EUT: Massage Chair	Engineer Signature: Ben
Mode: TX 2402MHz	Distance: 3m
Model: HMC-600	
Manufacturer: XIAMEN OGAWA INTELLIGENT HEALTH EQUIPMENT CO., LTD	

Note: Report NO.:ATE20190505

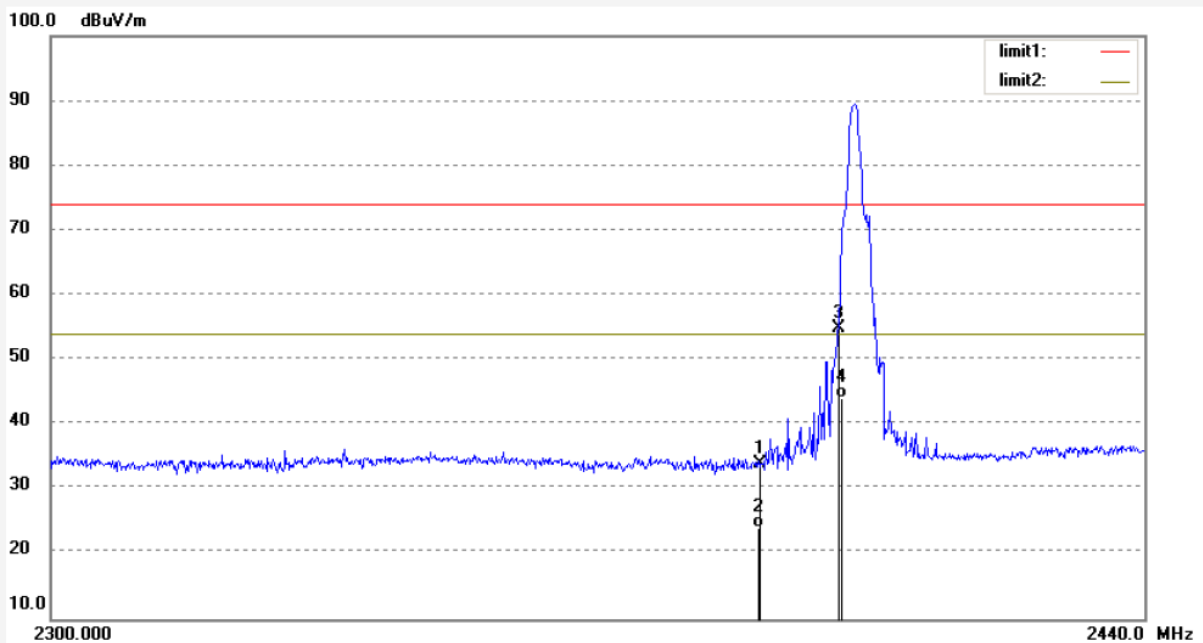

No.	Freq. (MHz)	Reading (dBuV/m)	Factor (dB)	Result (dBuV/m)	Limit (dBuV/m)	Margin (dB)	Detector	Height (cm)	Degree (deg.)	Remark
1	2390.000	40.30	-6.32	33.98	74.00	-40.02	peak	100	123	
2	2390.000	30.42	-6.32	24.10	54.00	-29.90	AVG	100	123	
3	2400.000	61.11	-6.27	54.84	74.00	-19.16	peak	100	203	
4	2400.000	50.27	-6.27	44.00	54.00	-10.00	AVG	100	203	

Note: Average measurement with peak detection at No.2&4





**ACCURATE TECHNOLOGY CO., LTD.**

F1,Bldg,A,Changyuan New Material Port Keyuan Rd,  
Science & Industry Park,Nanshan Shenzhen,P.R.China

Site: 1# Chamber  
Tel:+86-0755-26503290  
Fax:+86-0755-26503396

Job No.: jp2019 #131	Polarization: Vertical
Standard: FCC PK	Power Source: AC 120V/60Hz
Test item: Radiation Test	Date: 19/04/18/
Temp.( C)/Hum.(%) 25 C / 55 %	Time: 10/41/43
EUT: Massage Chair	Engineer Signature: Ben
Mode: TX 2402MHz	Distance: 3m
Model: HMC-600	
Manufacturer: XIAMEN OGAWA INTELLIGENT HEALTH EQUIPMENT CO., LTD	

Note: Report NO.:ATE20190505

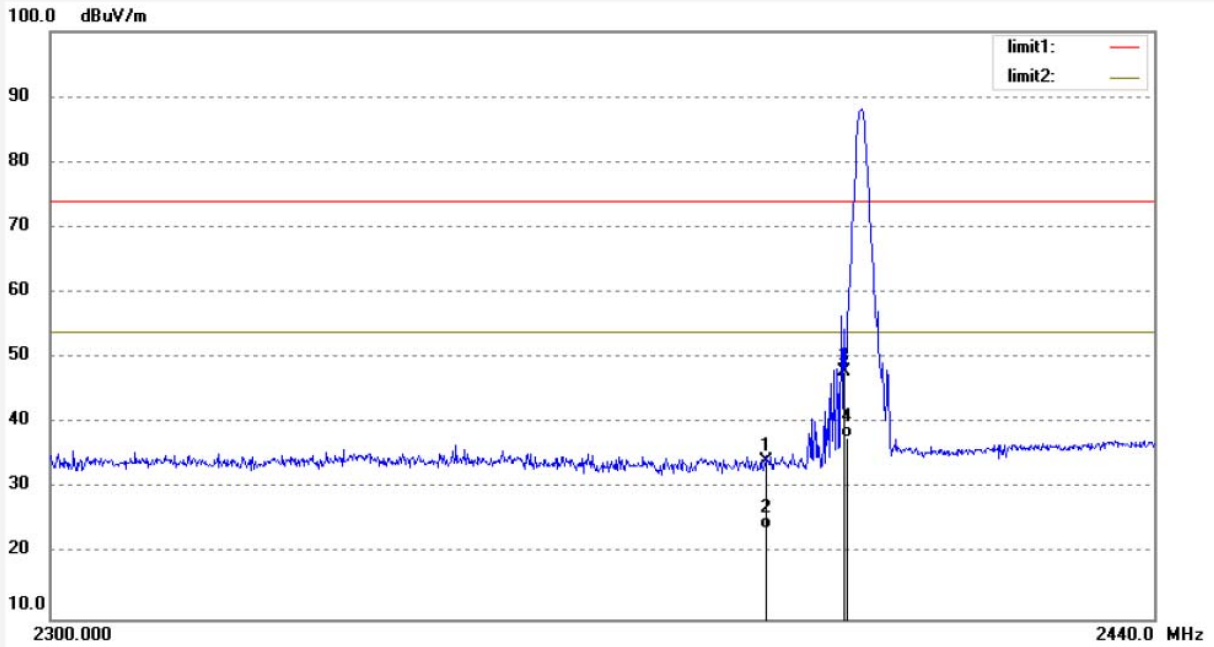

No.	Freq. (MHz)	Reading (dBuV/m)	Factor (dB)	Result (dBuV/m)	Limit (dBuV/m)	Margin (dB)	Detector	Height (cm)	Degree (deg.)	Remark
1	2390.000	40.55	-6.32	34.23	74.00	-39.77	peak	100	194	
2	2390.000	30.22	-6.32	23.90	54.00	-30.10	AVG	100	194	
3	2400.000	54.09	-6.27	47.82	74.00	-26.18	peak	100	206	
4	2400.000	44.07	-6.27	37.80	54.00	-16.20	AVG	100	206	

Note: Average measurement with peak detection at No.2&4



**ACCURATE TECHNOLOGY CO., LTD.**

F1,Bldg,A,Changyuan New Material Port Keyuan Rd,  
Science & Industry Park,Nanshan Shenzhen,P.R.China

Site: 1# Chamber  
Tel:+86-0755-26503290  
Fax:+86-0755-26503396

Job No.: jp2019 #129	Polarization: Horizontal
Standard: FCC PK	Power Source: AC 120V/60Hz
Test item: Radiation Test	Date: 19/04/18/
Temp.( C)/Hum.(%) 25 C / 55 %	Time: 10/32/05
EUT: Massage Chair	Engineer Signature: Ben
Mode: TX 2480MHz	Distance: 3m
Model: HMC-600	
Manufacturer: XIAMEN OGAWA INTELLIGENT HEALTH EQUIPMENT CO., LTD	

Note: Report NO.:ATE20190505

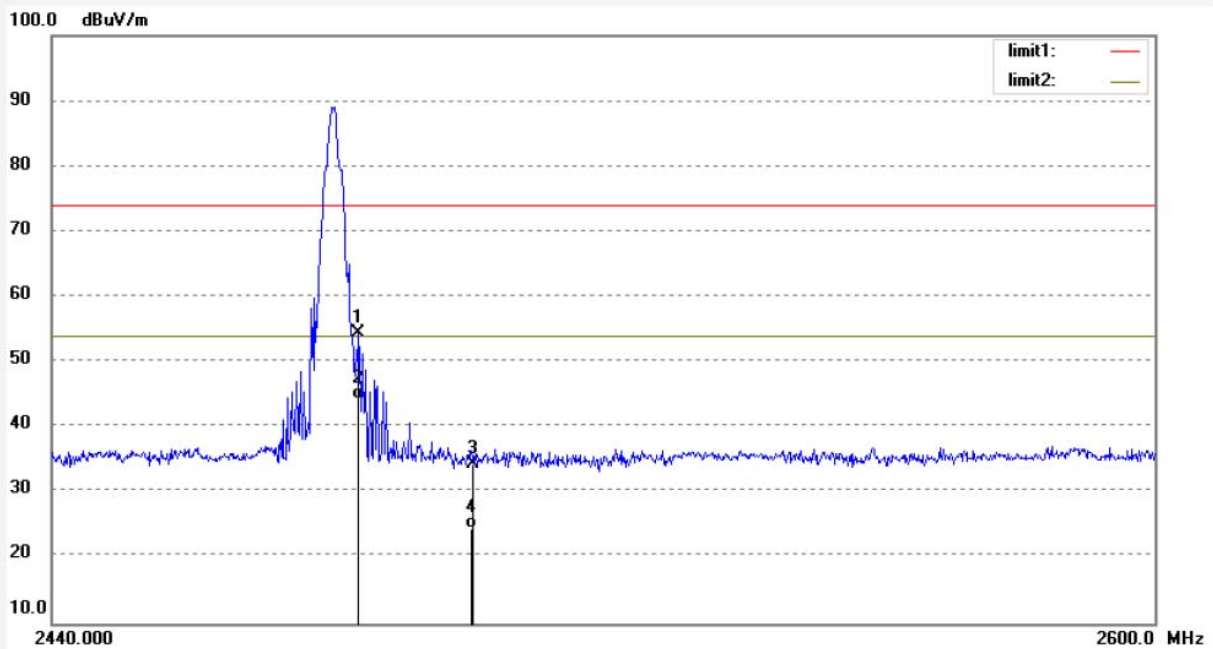

No.	Freq. (MHz)	Reading (dBuV/m)	Factor (dB)	Result (dBuV/m)	Limit (dBuV/m)	Margin (dB)	Detector	Height (cm)	Degree (deg.)	Remark
1	2483.500	60.27	-5.89	54.38	74.00	-19.62	peak	100	196	
2	2483.500	50.09	-5.89	44.20	54.00	-9.80	AVG	100	196	
3	2500.000	40.22	-5.81	34.41	74.00	-39.59	peak	100	236	
4	2500.000	30.31	-5.81	24.50	54.00	-29.50	AVG	100	236	

Note: Average measurement with peak detection at No.2&4



**ACCURATE TECHNOLOGY CO., LTD.**

F1,Bldg,A,Changyuan New Material Port Keyuan Rd,  
Science & Industry Park,Nanshan Shenzhen,P.R.China

Site: 1# Chamber  
Tel:+86-0755-26503290  
Fax:+86-0755-26503396

Job No.: jp2019 #128	Polarization: Vertical
Standard: FCC PK	Power Source: AC 120V/60Hz
Test item: Radiation Test	Date: 19/04/18/
Temp.( C)/Hum.(%) 25 C / 55 %	Time: 10/29/42
EUT: Massage Chair	Engineer Signature: Ben
Mode: TX 2480MHz	Distance: 3m
Model: HMC-600	
Manufacturer: XIAMEN OGAWA INTELLIGENT HEALTH EQUIPMENT CO., LTD	

Note: Report NO.:ATE20190505

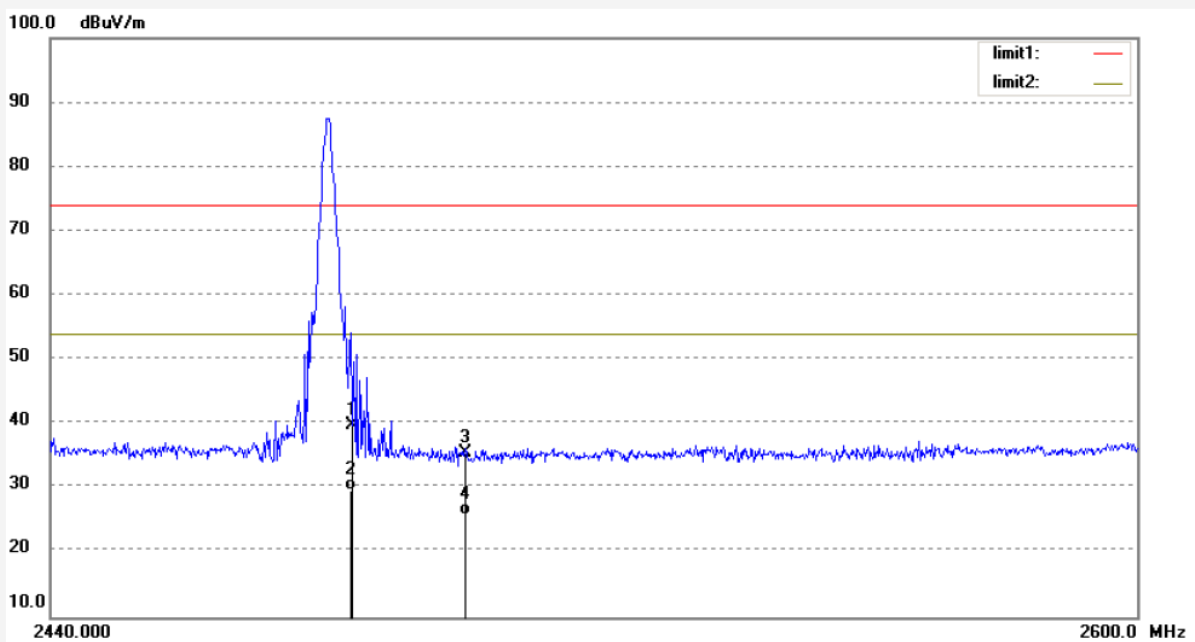

No.	Freq. (MHz)	Reading (dBuV/m)	Factor (dB)	Result (dBuV/m)	Limit (dBuV/m)	Margin (dB)	Detector	Height (cm)	Degree (deg.)	Remark
1	2483.500	45.74	-5.89	39.85	74.00	-34.15	peak	100	103	
2	2483.500	35.69	-5.89	29.80	54.00	-24.20	AVG	100	103	
3	2500.000	41.39	-5.81	35.58	74.00	-38.42	peak	100	95	
4	2500.000	31.71	-5.81	25.90	54.00	-28.10	AVG	100	95	

Note: Average measurement with peak detection at No.2&4

Hopping mode



**ACCURATE TECHNOLOGY CO., LTD.**

F1,Bldg,A,Changyuan New Material Port Keyuan Rd,  
Science & Industry Park,Nanshan Shenzhen,P.R.China

Site: 1# Chamber  
Tel:+86-0755-26503290  
Fax:+86-0755-26503396

Job No.: jp2019 #120	Polarization: Vertical
Standard: FCC PK	Power Source: AC 120V/60Hz
Test item: Radiation Test	Date: 19/04/18/
Temp.( C)/Hum.(%) 25 C / 55 %	Time: 10/06/16
EUT: Massage Chair	Engineer Signature: Ben
Mode: HOPPING(GFSK)	Distance: 3m
Model: HMC-600	
Manufacturer: XIAMEN OGAWA INTELLIGENT HEALTH EQUIPMENT CO., LTD	

Note: Report NO.:ATE20190505

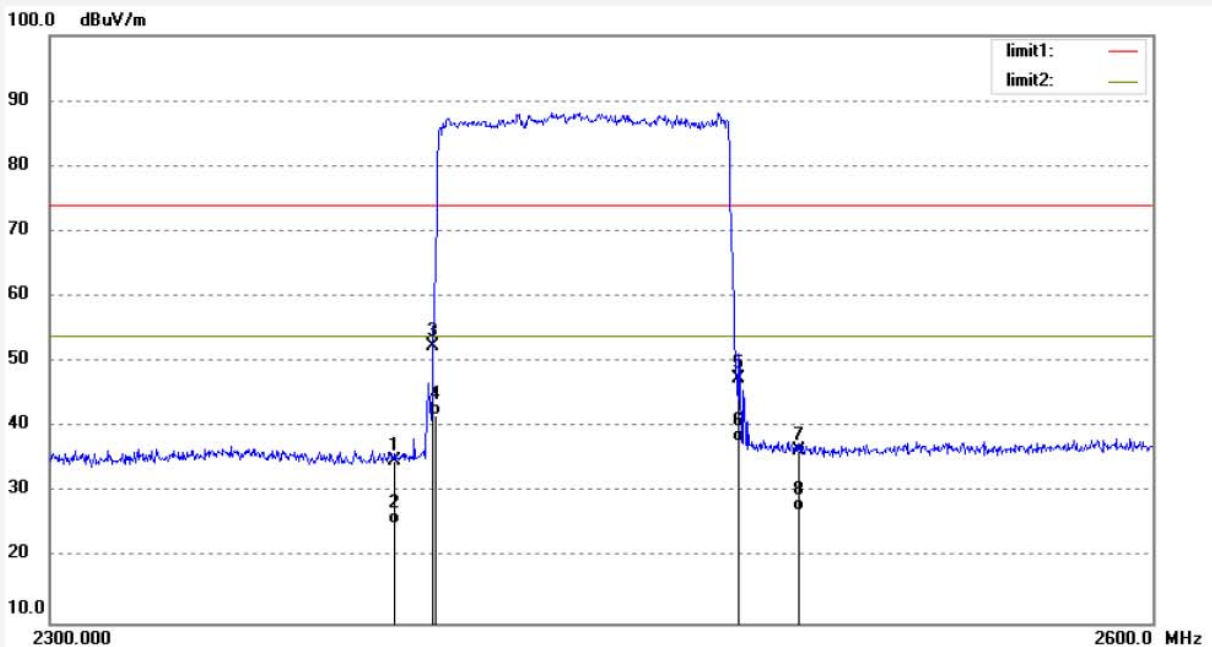

No.	Freq. (MHz)	Reading (dBuV/m)	Factor (dB)	Result (dBuV/m)	Limit (dBuV/m)	Margin (dB)	Detector	Height (cm)	Degree (deg.)	Remark
1	2390.000	41.16	-6.32	34.84	74.00	-39.16	peak	100	256	
2	2390.000	31.62	-6.32	25.30	54.00	-28.70	AVG	100	256	
3	2400.000	58.65	-6.27	52.38	74.00	-21.62	peak	100	195	
4	2400.000	48.07	-6.27	41.80	54.00	-12.20	AVG	100	195	
5	2483.500	53.30	-5.89	47.41	74.00	-26.59	peak	100	136	
6	2483.500	43.69	-5.89	37.80	54.00	-16.20	AVG	100	136	
7	2500.000	42.31	-5.81	36.50	74.00	-37.50	peak	100	296	
8	2500.000	32.91	-5.81	27.10	54.00	-26.90	AVG	100	296	

Note: Average measurement with peak detection at No.2&4&6&8



**ACCURATE TECHNOLOGY CO., LTD.**

F1,Bldg,A,Changyuan New Material Port Keyuan Rd,  
Science & Industry Park,Nanshan Shenzhen,P.R.China

Site: 1# Chamber  
Tel:+86-0755-26503290  
Fax:+86-0755-26503396

Job No.: jp2019 #121	Polarization: Horizontal
Standard: FCC PK	Power Source: AC 120V/60Hz
Test item: Radiation Test	Date: 19/04/18/
Temp.( C)/Hum.(%) 25 C / 55 %	Time: 10/09/05
EUT: Massage Chair	Engineer Signature: Ben
Mode: HOPPING(GFSK)	Distance: 3m
Model: HMC-600	
Manufacturer: XIAMEN OGAWA INTELLIGENT HEALTH EQUIPMENT CO., LTD	

Note: Report NO.:ATE20190505

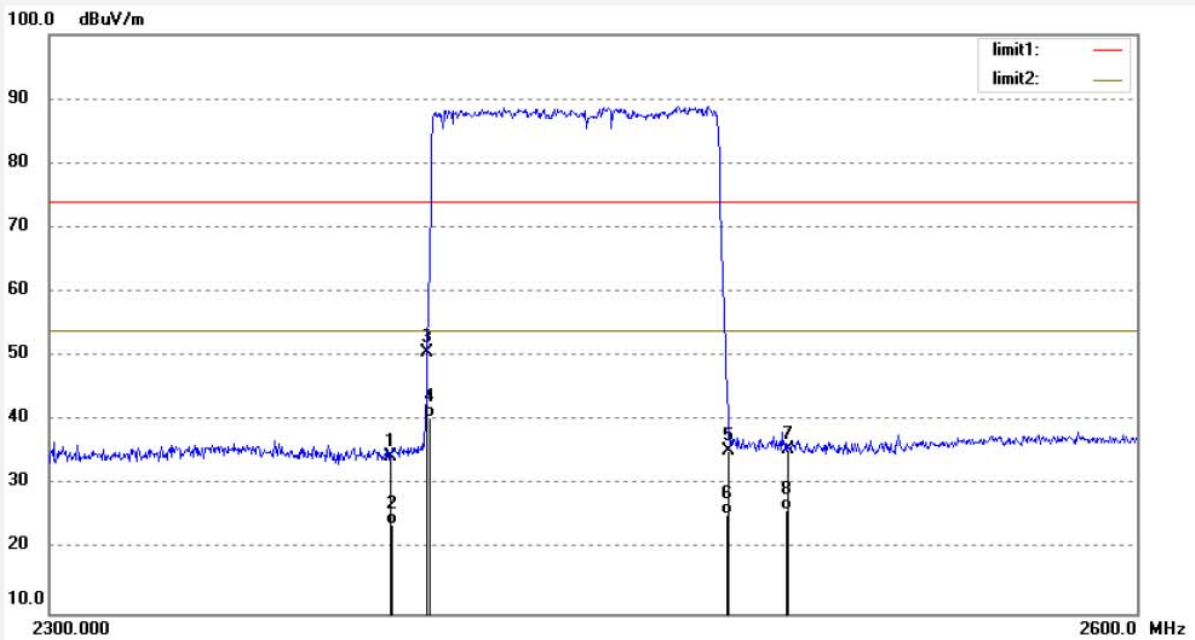

No.	Freq. (MHz)	Reading (dBuV/m)	Factor (dB)	Result (dBuV/m)	Limit (dBuV/m)	Margin (dB)	Detector	Height (cm)	Degree (deg.)	Remark
1	2390.000	40.69	-6.32	34.37	74.00	-39.63	peak	100	278	
2	2390.000	30.22	-6.32	23.90	54.00	-30.10	AVG	100	278	
3	2400.000	56.98	-6.27	50.71	74.00	-23.29	peak	100	196	
4	2400.000	46.77	-6.27	40.50	54.00	-13.50	AVG	100	196	
5	2483.500	41.27	-5.89	35.38	74.00	-38.62	peak	100	245	
6	2483.500	31.29	-5.89	25.40	54.00	-28.60	AVG	100	245	
7	2500.000	41.25	-5.81	35.44	74.00	-38.56	peak	100	106	
8	2500.000	31.81	-5.81	26.00	54.00	-28.00	AVG	100	106	

Note: Average measurement with peak detection at No.2&4&6&8

## 12.AC POWER LINE CONDUCTED EMISSION FOR FCC PART

### 15 SECTION 15.207(A)

#### 12.1.Block Diagram of Test Setup

12.1.1.Block diagram of connection between the EUT and simulators

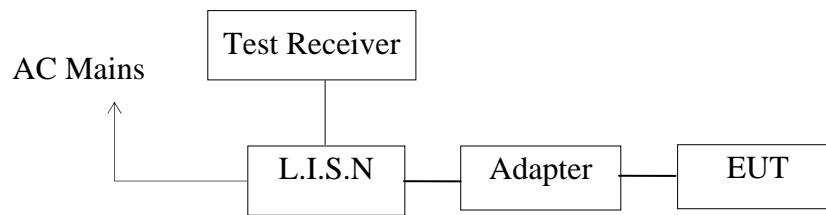

(EUT: Massage Chair)

#### 12.1.2.Test System Setup

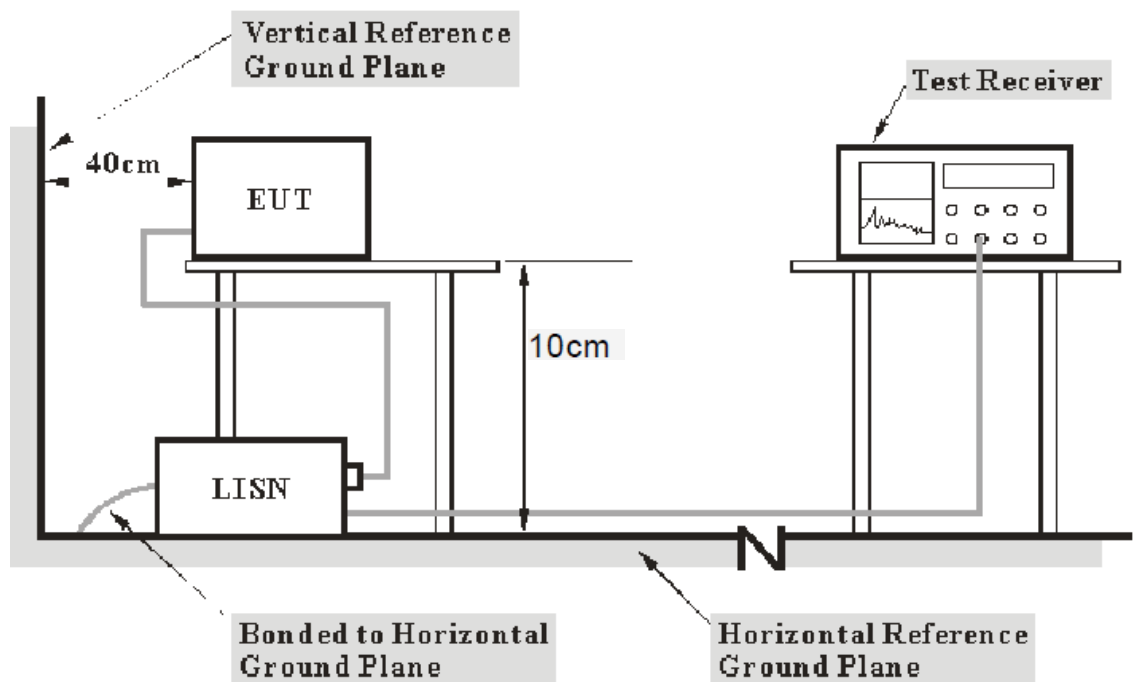

- Note:**
1. Support units were connected to second LISN.
  2. Both of LISNs (AMN) 80 cm from EUT and at the least 80 cm from other units and other metal planes support units.

## 12.2. Power Line Conducted Emission Measurement Limits

Frequency (MHz)	Limit dB(μV)	
	Quasi-peak Level	Average Level
0.15 - 0.50	66.0 – 56.0 *	56.0 – 46.0 *
0.50 - 5.00	56.0	46.0
5.00 - 30.00	60.0	50.0

NOTE1: The lower limit shall apply at the transition frequencies.  
 NOTE2: The limit decreases linearly with the logarithm of the frequency in the range 0.15MHz to 0.50MHz.

## 12.3. Configuration of EUT on Measurement

The equipments are installed on Power Line Conducted Emission Measurement to meet the commission requirement and operating regulations in a manner, which tends to maximize its emission characteristics in a normal application.

## 12.4. Operating Condition of EUT

12.4.1. Setup the EUT and simulator as shown as Section 12.1.

12.4.2. Turn on the power of all equipment.

12.4.3. Let the EUT work in test mode and measure it.

## 12.5. Test Procedure

The EUT is put on the plane 0.1m high above the ground by insulating support and is connected to the power mains through a line impedance stabilization network (L.I.S.N.). This provides a 50ohm coupling impedance for the EUT system. Please refer the block diagram of the test setup and photographs. Both sides of AC lines are checked to find out the maximum conducted emission. In order to find the maximum emission levels, the relative positions of equipment and all of the interface cables shall be changed according to ANSI C63.10: 2013 on Conducted Emission Measurement. The bandwidth of test receiver (R & S ESCS30) is set at 9kHz.

The frequency range from 150kHz to 30MHz is checked.

### 12.6.Data Sample

Frequency (MHz)	Transducer value (dB)	QuasiPeak Level (dBμV)	Average Level (dBμV)	QuasiPeak Limit (dBμV)	Average Limit (dBμV)	QuasiPeak Margin (dB)	Average Margin (dB)	Remark (Pass/Fail)
X.XX	10.5	51.1	34.2	56.0	46.0	4.9	11.8	Pass

Frequency(MHz) = Emission frequency in MHz

Transducer value(dB) = Insertion loss of LISN + Cable Loss

Level(dBμV) = Quasi-peak Reading/Average Reading + Transducer value

Limit (dBμV) = Limit stated in standard

Margin = Limit (dBμV) - Level (dBμV)

Calculation Formula:

Margin = Limit (dBμV) - Level (dBμV)

### 12.7.Power Line Conducted Emission Measurement Results

**PASS.**

Test Lab: Shielding room

The frequency range from 150kHz to 30MHz is checked.

Maximizing procedure was performed on the six (6) highest emissions of the EUT. Emissions attenuated more than 20 dB below the permissible value are not reported.

All data was recorded in the Quasi-peak and average detection mode.

The spectral diagrams are attached as below.



ACCURATE TECHNOLOGY CO., LTD

CONDUCTED EMISSION STANDARD FCC PART 15B

EUT: Massage Chair M/N:HMC-600  
 Manufacturer: XIAMEN OGAWA INTELLIGENT HEALTH EQUIPMENT CO., LTD  
 Operating Condition: ON  
 Test Site: 1#Shielding Room  
 Operator: Ben  
 Test Specification: N 120V 60Hz  
 Comment: Report NO.:ATE20190505  
 Start of Test: 2019-4-15 / 17:42:18

SCAN TABLE: "V 150K-30MHz fin"

Short Description: \_SUB\_STD\_VTERM2 1.70  
 Start Stop Step Detector Meas. IF Transducer  
 Frequency Frequency Width Time Bandw.  
 150.0 kHz 30.0 MHz 4.5 kHz QuasiPeak 1.0 s 9 kHz NSLK8126 2008  
 Average

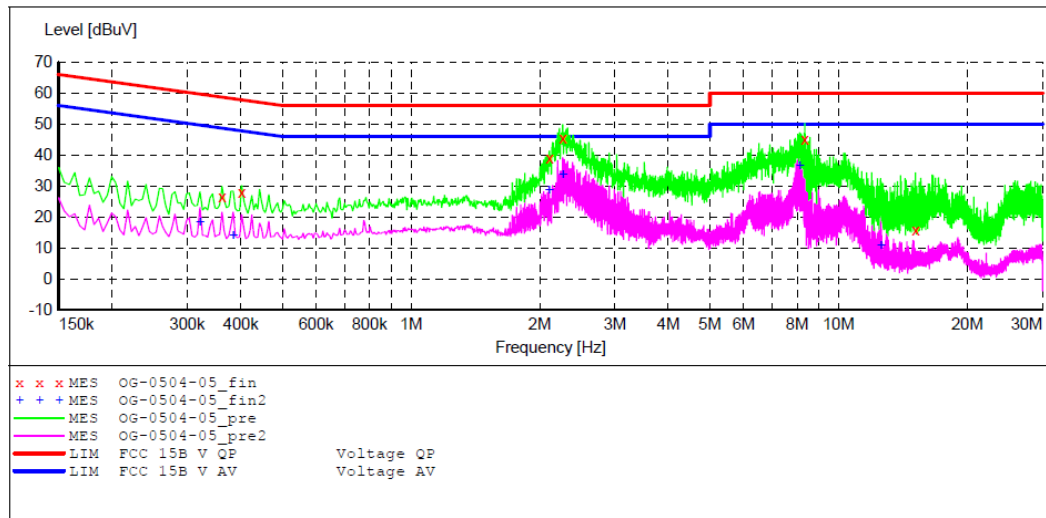

MEASUREMENT RESULT: "OG-0504-05\_fin"

2019-4-15 17:44

Frequency MHz	Level dBuV	Transd dB	Limit dBuV	Margin dB	Detector	Line	PE
0.361500	26.70	10.9	59	32.0	QP	N	GND
0.402000	27.90	11.0	58	29.9	QP	N	GND
2.107500	38.90	11.3	56	17.1	QP	N	GND
2.265000	45.40	11.3	56	10.6	QP	N	GND
8.340000	45.10	11.5	60	14.9	QP	N	GND
15.135000	15.80	11.6	60	44.2	QP	N	GND

MEASUREMENT RESULT: "OG-0504-05\_fin2"

2019-4-15 17:44

Frequency MHz	Level dBuV	Transd dB	Limit dBuV	Margin dB	Detector	Line	PE
0.321000	18.30	10.9	50	31.4	AV	N	GND
0.384000	14.00	10.9	48	34.2	AV	N	GND
2.103000	28.60	11.3	46	17.4	AV	N	GND
2.265000	33.70	11.3	46	12.3	AV	N	GND
8.115000	36.50	11.5	50	13.5	AV	N	GND
12.570000	10.80	11.6	50	39.2	AV	N	GND

**ACCURATE TECHNOLOGY CO., LTD**

**CONDUCTED EMISSION STANDARD FCC PART 15B**

EUT: Massage Chair M/N:HMC-600  
 Manufacturer: XIAMEN OGAWA INTELLIGENT HEALTH EQUIPMENT CO., LTD  
 Operating Condition: ON  
 Test Site: 1#Shielding Room  
 Operator: Ben  
 Test Specification: L 120V 60Hz  
 Comment: Report NO.:ATE20190505  
 Start of Test: 2019-4-15 / 17:59:50

**SCAN TABLE: "V 150K-30MHz fin"**

Start Frequency	Stop Frequency	Step Width	Detector	Meas. Time	IF Bandw.	Transducer
150.0 kHz	30.0 MHz	4.5 kHz	QuasiPeak	1.0 s	9 kHz	NSLK8126 2008
Average						

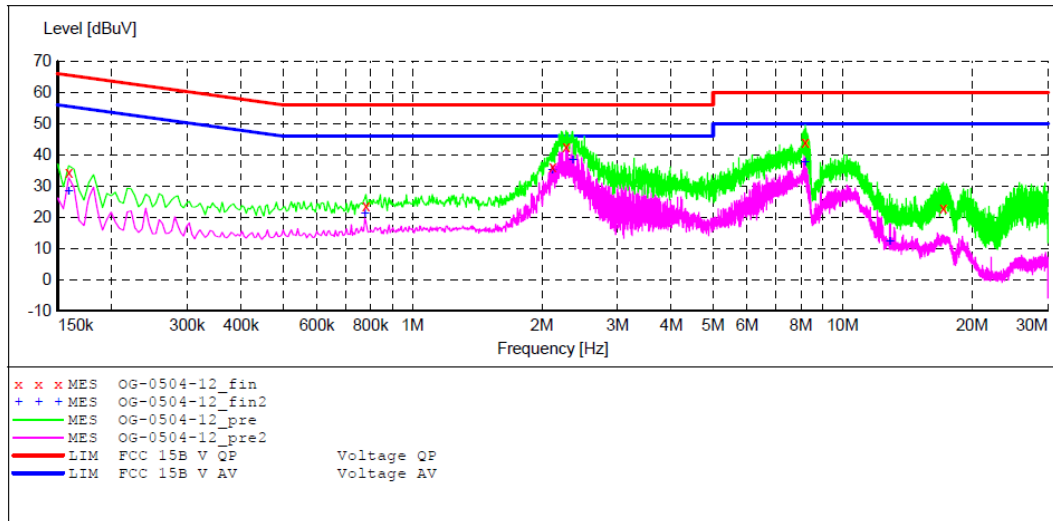

**MEASUREMENT RESULT: "OG-0504-12\_fin"**

2019-4-15 18:01

Frequency MHz	Level dBuV	Transd dB	Limit dBuV	Margin dB	Detector	Line	PE
0.159000	34.40	10.8	66	31.1	QP	L1	GND
0.780000	23.80	11.1	56	32.2	QP	L1	GND
2.121000	36.30	11.3	56	19.7	QP	L1	GND
2.278500	42.70	11.3	56	13.3	QP	L1	GND
8.187000	44.00	11.5	60	16.0	QP	L1	GND
17.155500	22.90	11.7	60	37.1	QP	L1	GND

**MEASUREMENT RESULT: "OG-0504-12\_fin2"**

2019-4-15 18:01

Frequency MHz	Level dBuV	Transd dB	Limit dBuV	Margin dB	Detector	Line	PE
0.159000	28.50	10.8	56	27.0	AV	L1	GND
0.775500	21.10	11.1	46	24.9	AV	L1	GND
2.112000	35.00	11.3	46	11.0	AV	L1	GND
2.355000	38.40	11.3	46	7.6	AV	L1	GND
8.187000	37.60	11.5	50	12.4	AV	L1	GND
12.867000	12.30	11.6	50	37.7	AV	L1	GND

## 13.ANTENNA REQUIREMENT

### 13.1.The Requirement

According to Section 15.203, an intentional radiator shall be designed to ensure that no antenna other than that furnished by the responsible party shall be used with the device.

### 13.2.Antenna Construction

Device is equipped with permanent attached antenna, which isn't displaced by other antenna. The Max Antenna gain of EUT is 0dBi. Therefore, the equipment complies with the antenna requirement of Section 15.203.

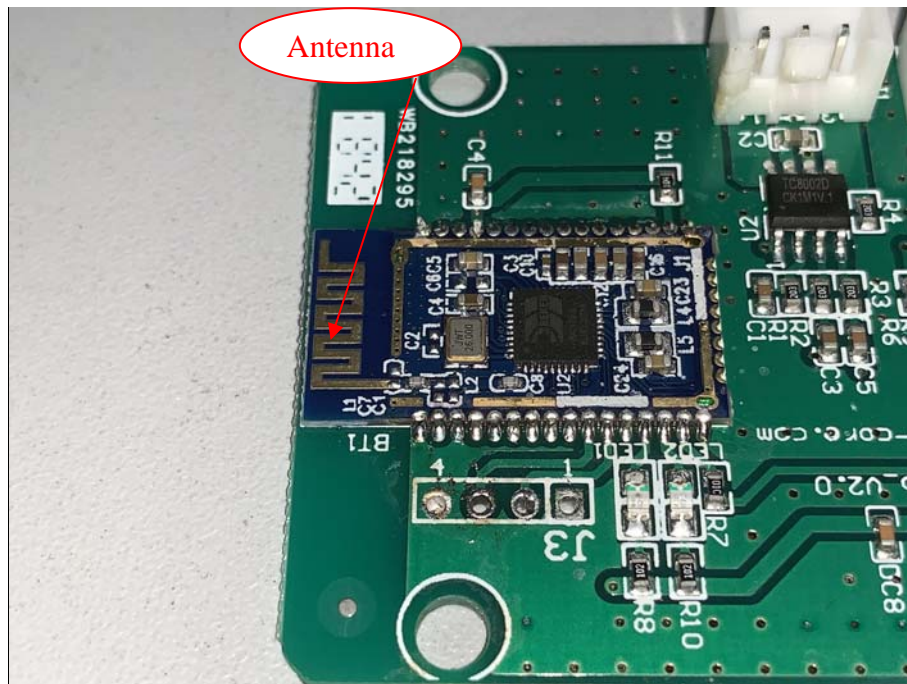

\*\*\*\*\* End of Test Report \*\*\*\*\*