

Osaki

Instruction Manual

Model No. Maxim 3D LE

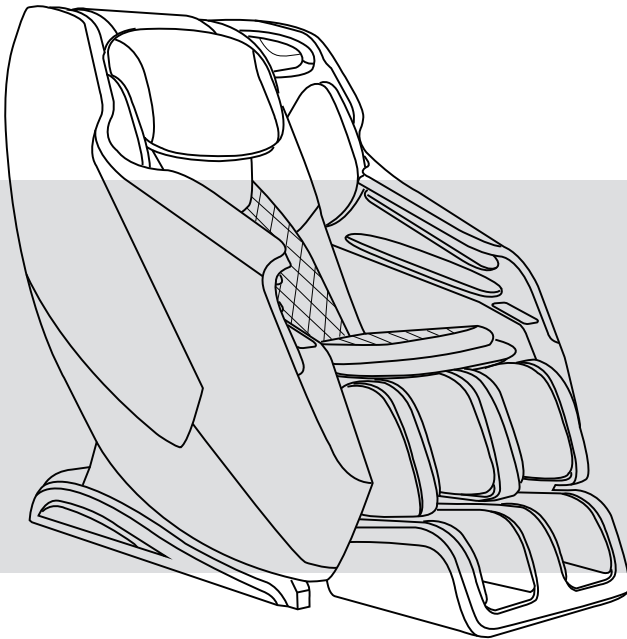

Before operating this unit, please read these instructions completely.

Contents

Before Use

IMPORTANT SAFETY INSTRUCTIONS	1
Safety Precautions	2-3
FCC Radiation Exposure Statement	4
Industry Canada Notice	5
Chair Components	6-7
Chair Installation	8
Setting up the massage chair	9
Preparation before Use	10-11

How to Use

Controller	12
How to Use.....	13-18

Q&A / Important

Cleaning and maintenance	19
Troubleshooting	20
Grounding Instructions.....	21
Chair Specifications.....	22

Thank you for purchasing this Massage Chair.
Before using your massage chair, please read the contents of this
instruction manual and refer to it when needed.

IMPORTANT SAFETY INSTRUCTIONS

When using an electrical appliance, basic precautions should always be followed, including the following:

Read all instructions before using (this appliance).

DANGER To reduce the risk of electric shock:

- Always unplug this appliance from the electrical outlet immediately after using and before cleaning.
- Never use pins or other metallic fasteners with this appliance.
- Carefully examine the covering before each use. Discard the appliance if the covering shows any sign of deterioration, such as checking, blistering, or cracking.

WARNING To reduce the risks of burns, fire, electric shock or injury to persons:

- An appliance should never be left unattended when plugged in. Unplug from outlet when not in use, and before putting on or taking off parts.
- Close supervision is necessary when this appliance is used by, on, or near children, invalids, or disabled persons.
- Use this appliance only for its intended use as described in this manual. Do not use attachments not recommended by the manufacturer.
- Never operate this appliance if it has a damaged cord or plug, if it is not working properly, if it has been dropped or damaged, or dropped into water. Return the appliance to a service center for examination and repair.
- Do not carry this appliance by supply cord or use cord as a handle.
- Keep the cord away from heated surfaces.
- Never operate the appliance with the air openings blocked. Keep the air openings free of lint, hair, and the like.
- Never drop or insert any object into any opening.
- Do not use outdoors.
- Do not operate where aerosol (spray) products are being used or where oxygen is being administered.
- To disconnect, turn all controls to the off position, then remove plug from outlet.
- Keep children away from extended foot support.
- Connect this appliance to a properly grounded outlet only. See Grounding Instructions.
- Use heated surfaces carefully. May cause serious burns. Do not use over insensitive skin areas or in the presence of poor circulation. The unattended use of heat by children or incapacitated persons may be dangerous.
- Do not operate under blanket or pillow. Excessive heating can occur and cause fire, electric shock, or injury to persons.

SAVE THESE INSTRUCTIONS

Safety Precautions

When using the massage chair, basic precautions should always be followed to reduce the risk of electric shock, burns, fire or injury to persons. Please read the following precautions before using the massage chair.

- Make sure the power plug is securely inserted into a proper electrical outlet to reduce the risk of short-circuit and fire.
- It is highly recommended that a surge protector is used to prevent from damage.
- DO NOT use the massage chair in areas where the humidity is high such as sauna steam rooms, pools, bathrooms, AC or heating vents, etc.
- DO NOT use the massage chair outdoors and avoid areas with direct sunlight.
- If the chair is not being used, turn the power switch to the OFF position and unplug the massage chair from the electrical outlet to prevent any damages to the chair when there are power outages/surges that may cause serious damage.
- Never plug/unplug the power cord plug socket with wet hands.
- Close and continuous supervision is necessary when the massage chair is used by, on or near children or disabled persons.
- No more than one person should use the massage chair at the same time.
- The massage chair is intended for use as described in the Instruction Manual. Do not use any attachments other than those recommended by the manufacturer.
- DO NOT attempt to stand or sit on the backrest, armrest or footrest in order to prevent accident, injury or damage to the chair.
- Avoid falling asleep while using the massage chair.
- Always keep the massage chair clean, and never insert any objects into or around the gaps of the massage chair.
- DO NOT move the massage chair by pulling on the power supply cord.
- Make sure there are no children, pets or other obstacles behind or underneath the massage chair.
- If you find any rips or tears in the fabric of the massage chair, contact the service department and stop using the chair immediately.
- This massage chair is designed for household use and should not be used in non-residential settings.

Safety Precautions

- Please consult your doctor if you are in doubt as to whether or not you should use this massage chair.
- Please consult a doctor before using the massage chair if you are pregnant, undergoing any medical treatment, using a medical electronic device such as a pacemaker, or are experiencing any of the following: malignant tumor, heart disease, back pain, abnormal or curved back bone, osteoporosis or acute illness.
- If you experience pain while using the massage chair, stop using the chair immediately and consult your doctor.
- Never use a massage function on swollen or inflamed parts of the body.
- DO NOT use the massage chair for more than 30 minutes at a time.
- DO NOT use the massage chair where aerosol(spray) products are being used or where oxygen is being administered.
- This massage chair is a non-professional product designed to provide a comfortable massage and should not be substituted for appropriate medical treatment.
- Never operate the appliance with the air hoses that inflate while they are blocked. Keep the air openings free of lint, hair, and any other obstructions.
- Check the skin which is in contact with the heated area of the appliance frequently to reduce the risk of injury. If the heating pad malfunctions and extreme heat is produced it may cause serious burns.
- Burns may result from improper use. If this is the case immediately shut off the chair and unplug from the outlet.
- Remove all sharp objects from the body and pockets such as keys and pens.
- Keep children away from extended foot support (or other similar parts.)
- DO NOT WET-DO NOT USE PINS.
- NEVER REMOVE COVER.

Caution

The user's weight is usually limited to 220 lbs.

For those who are weighing 220 lbs or more, the product operations may make more noise and the fabric cover may wear out faster.

FCC Radiation Exposure Statement

FCC Radiation Exposure Statement: (mobile device)

This device contains licence-exempt transmitter(s)/receiver(s) that comply with Innovation, Science and Economic Development Canada's licence-exempt RSS(s). Operation is subject to the following two conditions:

- (1) This device may not cause interference.
- (2) This device must accept any interference, including interference that may cause undesired operation of the device.

L'émetteur/récepteur exempt de licence contenu dans le présent appareil est conforme aux CNR d'Innovation, Sciences et Développement économique Canada applicables aux appareils radio exempts de licence. L'exploitation est autorisée aux deux conditions suivantes :

- 1) L'appareil ne doit pas produire de brouillage;
- 2) L'appareil doit accepter tout brouillage radioélectrique subi, même si le brouillage est susceptible d'en compromettre le fonctionnement.

Changes or modifications not expressly approved by the party responsible for compliance could void the user's authority to operate the equipment.

This equipment has been tested and found to comply with the limits for a Class B digital device, pursuant to part 15 of the FCC Rules. These limits are designed to provide reasonable protection against harmful interference in a residential installation. This equipment generates, uses and can radiate radio frequency energy and, if not installed and used in accordance with the instructions, may cause harmful interference to radio communications. However, there is no guarantee that interference will not occur in a particular installation. If this equipment does cause harmful interference to radio or television reception, which can be determined by turning the equipment off and on, the user is encouraged to try to correct the interference by one or more of the following measures:

- Reorient or relocate the receiving antenna.
- Increase the separation between the equipment and receiver.
- Connect the equipment into an outlet on a circuit different from that to which the receiver is connected.
- Consult the dealer or an experienced radio/ TV technician for help.

Industry Canada Notice

Industry Canada Notice

This device complies with Industry Canada licence-exempt RSS standard(s).

1. Operation is subject to the following two conditions:

- (1) this device may not cause interference, and
- (2) this device must accept any interference, including interference that may cause undesired operation of the device.

2. Changes or modifications not expressly approved by the party responsible for compliance could void the user's authority to operate the equipment.

Avis d'Industrie Canada

Le présent appareil est conforme aux CNR d'Industrie Canada applicables aux appareils radio exempts de licence.

1. L'exploitation est autorisée aux deux conditions suivantes :

- (1) l'appareil ne doit pas produire de brouillage, et
- (2) l'utilisateur de l'appareil doit accepter tout brouillage radioélectrique subi, même si le brouillage est susceptible d'en compromettre le fonctionnement.

2. Cet appareil numérique ne dépasse pas les Rèlements sur l'interférence radio par un appareil numérique de classe B stipulées dans les Règlement sur l'interférence radio d'industrie Canada.

Chair Components

Front

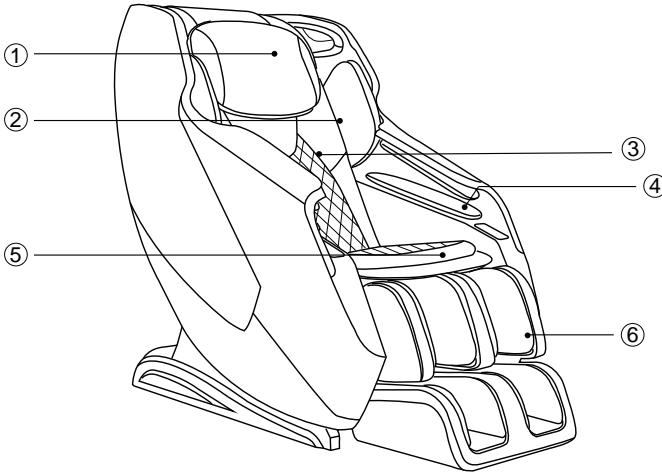

① Pillow Pad

② Shoulder side massage section

③ Backrest Pad

④ Hand and arm massage section

⑤ Seat Cushion

⑥ Legrest

Bluetooth Speaker

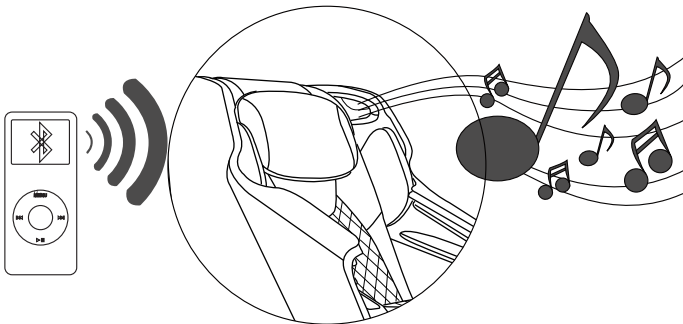



NOTE:

The bluetooth speaker can only connects with one bluetooth device at a time. Please turn off your bluetooth device after using so that other users can enjoy it as well

Chair Components

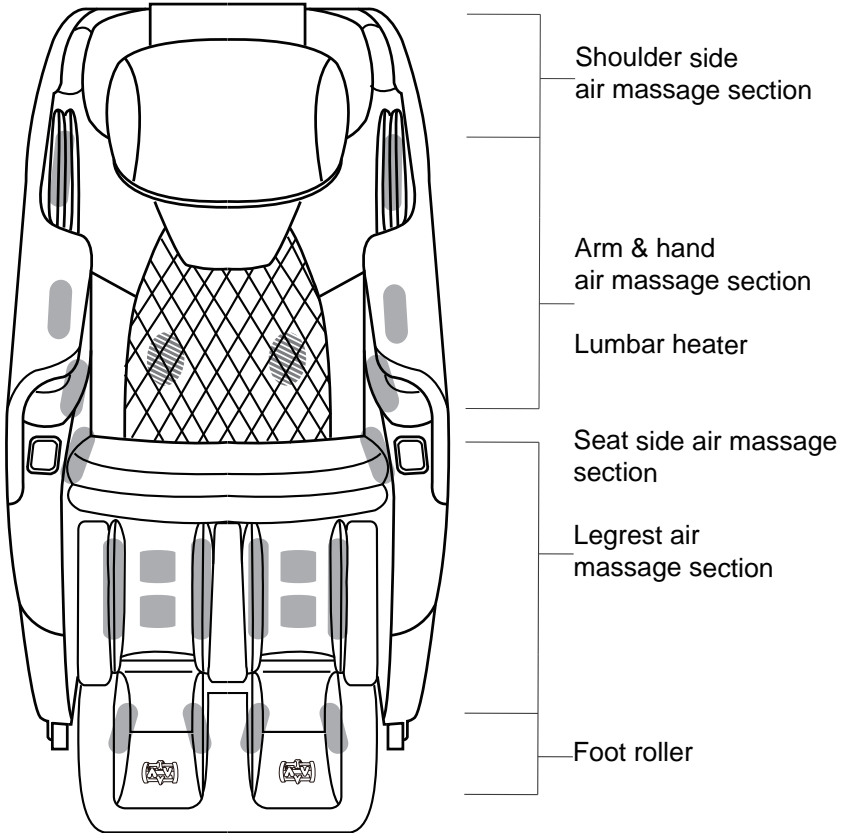
Air Massage Area



 Air bag

 Heat

 Foot Roller

Chair Installation

1. Take out the main unit and accessories from two boxes.

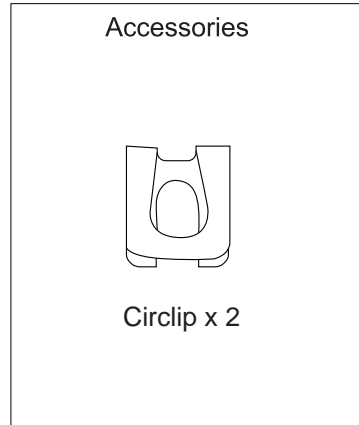
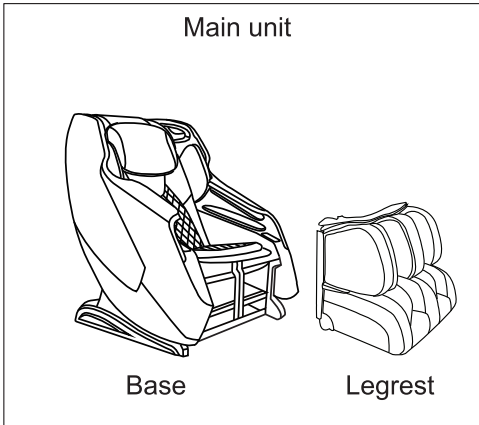

2. Connect the wires and air pipes from the footrest and seat part respectively.

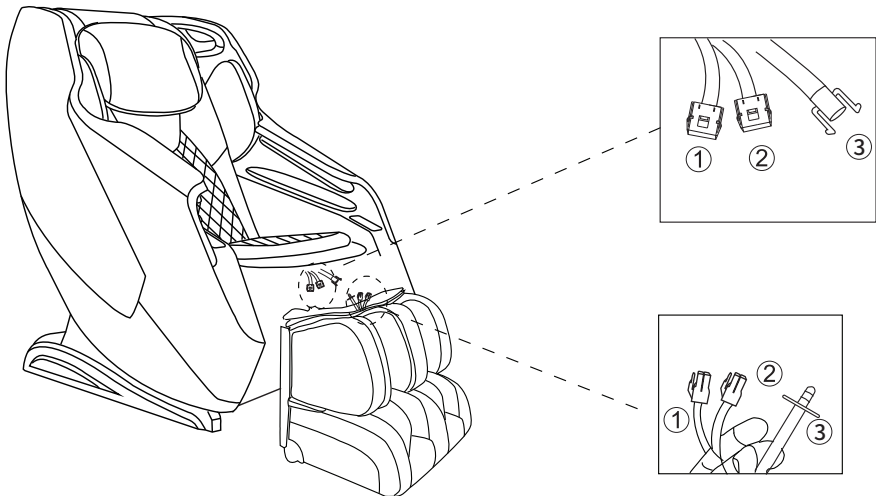

Setting up the massage chair

1. Installation Position.

- Ensure there is adequate space to recline.

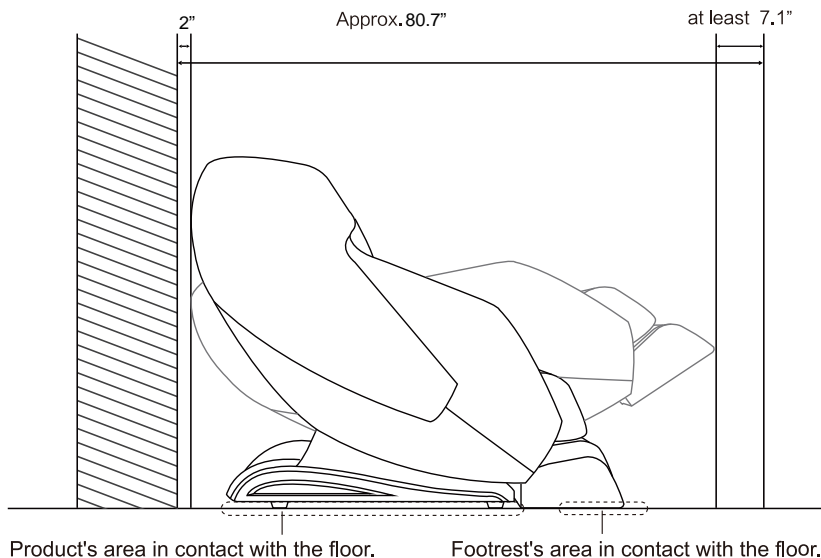

- Do not expose the massage lounger to direct sunlight or high temperatures, such as in front of heating sources, because this can cause discoloration or hardening of the synthetic leather.
- Place the unit on a mat to prevent floor damage.
- When placing a mat under the unit, the size of the mat should be sufficient to cover the areas where the unit touches and where the legrest could touch the floor, as shown in the diagram on the above.
- Install the unit near a power outlet.

Preparation before Use

1. Check the space around the product.

Make sure there is no person, pet, or other object close to the product.

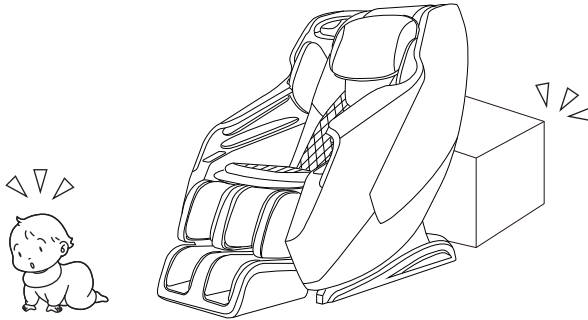

2. Make sure there is no foreign matter in the seams of the product.

- Before sitting on the product, make sure there is no foreign matter between any two parts of it.
- Do not put hands, arms or head between the backrest and the back cover.
- Do not put pets on the product (such as its back cover, backrest and armrests).

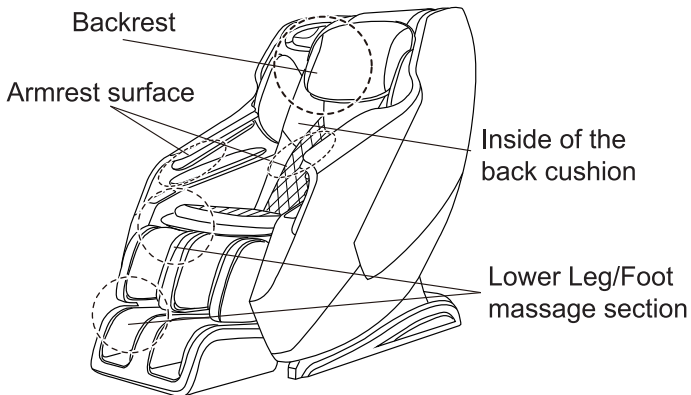

Preparation before Use

3. Power on the product

- ① Push the power connector into the appliance inlet till the end.
- ② Insert the power plug into the power outlet till the end.
- ③ Turn the switch to "I" position

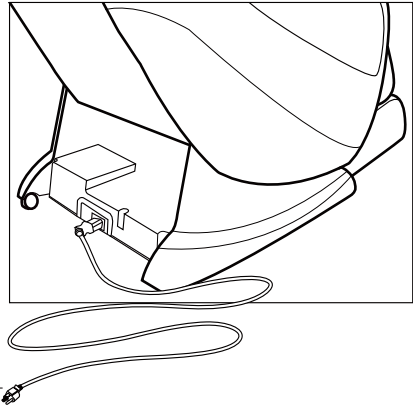
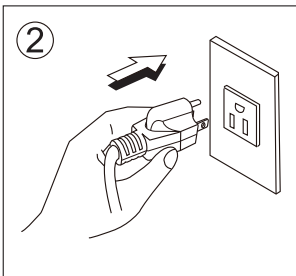
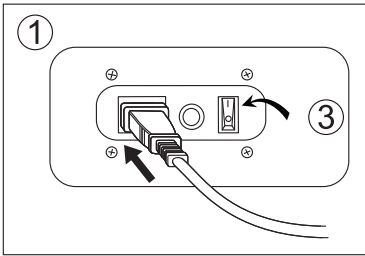

4. Make sure the massage rollers are retracted.

If they are not, press ON button to return them to the retracting position.

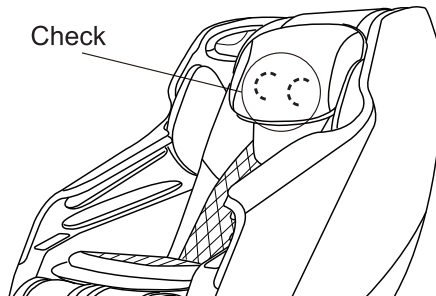

How to Use

Controller

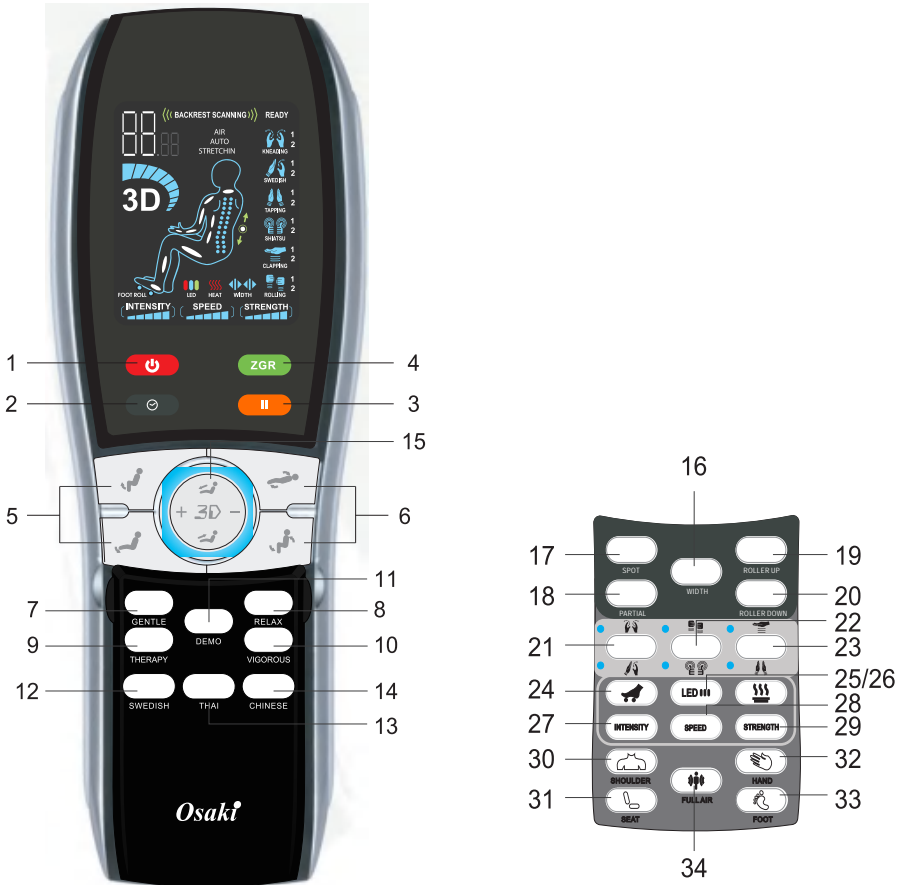

How to Use

Product Operation Guide

Connect to the power supply, then turn the switch to "I" position, thus the chair will be in idle mode, and the backrest angle will reach the highest position as well as the footrest angle will reach the lowest position. During its idle mode, there are only five functions: ON/OFF, Incline, Recline, Incline Leg, Recline Leg that can be operated.

Control Buttons for the Massage Chair

1. ON/OFF

The Start/Stop Control Button

Press this button to light up the LCD screen. Press any massage function button to start massage. This will initiate the timer function. Press this button again to stop all massage functions, massage chair will return to its original position.

2. TIMER

Time interval Control Button

When a massage function is activated, the timer is preset at 15 minutes. Every single press on this button will change the timer interval in the sequence of 20 > 25 > 30 > 5 > 10 > 15 > 20 minutes.

3. PAUSE

Press this button once to halt current massage function and countdown timer. During pause mode, the pause button will be blinking.

Press this button again to cease the Pause function and resume previous massage function as well as countdown timer.

4. Zero Gravity

Press this button to active the Zero Gravity function, press again to return to idle position.

Note: Zero Gravity button is NOT controllable during auto programs of Thai.

5. LEGREST RECLINE AND RESTORE





Angle Adjustment Button for Leg rest.

Keep pressing either button until the leg rest reaches your desired position.

How to Use

6. CHAIR RECLINE AND RESTORE

Keep pressing  to comfortably lay flat or to restore the chair  to its original position.

Full body Auto massage program

7.GENTLE

8.RELAX

9.THERAPY

10.VIGOROUS

11.DEMO

12.SWEDISH

13.THAI

14 . CHINESE

15.LEGREST LENGTH ADJUSTMENT BUTTON

These two control buttons can adjust the length of chair legrest.

Press  or  once to lengthen or shorten the chair legrest.

Notes :

1) Please press the button gently to avoid sticking the button.

2) When ZGR is activated before any program , the chair will scan and adjust the length of leg rest automatically.

16.WIDTH

The Width Adjustment Button for Rolling Function.

When Rolling function is engaged, every single press on this button will change the massage width interval in the sequence of Narrow>Wide in cycle.

17.Spot

The Spot Back massage

This button allows the user to select spot massage for any part on the back.

Press this button activate spot massage at the required location.

Press this again to switch to partial function.

18.Partial

The Partial Back massage.

Press this button to switch to partial function.

How to Use

19/20. Roller up/ Roller down

The massage position adjustment button for spot and partial massage. When the manual or automatic shoulder scanning can't meet individual requirements, you manually fine tune the shoulder height location by pressing up/ down button within sound 8 seconds. Once appropriate location found release the key, the final position will be lock.

Note: In the spot or partial massage, you can also use these two buttons to adjust the massage position.

Manual Massage Program

21. KNEADING

Kneading function Start Stop Control Button -5 levels of strength to be adjusted Press this button to activate rhythmic mode 1 Kneading function for a full back massage at medium strength. Press the button again to activate mode 2 Kneading function. Press the button for the third time to stop Kneading function and switch to mode 1 Swedish function.

21. SWEDISH

Swedish function Start/Stop Control Button -5 levels of speed to be adjusted. When mode 2 Kneading function is engaged, press this button to activate rhythmic mode 1 Swedish function for a full back massage at medium speed. Press this button again to activate mode 2 Swedish function. Press once more to stop the Swedish function. To activate Swedish function directly, press this button 3 times during idle mode.

22. TAPPING

Tapping function Start/Stop Control , 5 levels of speed to be adjusted. Press this button to activate rhythmic mode 1 Tapping function for a full back massage at medium speed. Press the button again to activate mode 2 Tapping function. Press the button for the third time to stop Tapping function and switch to mode 1 Shiatsu function.

How to Use

22.SHIATSU

Shiatsu function Start/Stop Control , 5 levels of speed to be adjusted. When mode 2 Tapping function is engaged, press this button to activate rhythmic mode 1 Shiatsu function for a full back massage at medium speed. Press this button again to activate mode 2 Shiatsu function. Press once more to stop the Shiatsu function. To activate Shiatsu function directly, press this button 3 times during idle mode.

23.CLAPPING

Clapping function Start/Stop Control ,5 levels of speed to be adjusted. Press this button to activate rhythmic mode 1 Clapping function for a full back massage at medium speed. Press the button again to activate mode 2 Clapping function.Press the button for the third time to stop Clapping function and switch to Rolling function.

23.ROLLING

Rolling function Start/Stop Control Button -2 levels of width to be adjusted. When mode 2 Clapping function is engaged, press this button to activate Rolling function for a full back massage.Press this button again to stop the Rolling function. To activate Rolling directly, press this button 3 times during idle mode.

Note: This function cannot perform "Spot" massage function.

24.Foot Roller

Foot roll function Start/Stop Control Button.

Press once to activate the roller on foot, press again to stop the foot roll function.

25.LED LIGHTING

LED Lighting Function Start/Stop Control Button.

Press this button to activate LED lighting function. Press again to stop the LED Lighting function.

How to Use

26.HEAT

Lumbar Heat function Start/Stop Control Button.

Press this button to activate lumbar heat function, press this button again to stop the Heat function.

Note: During Auto Program mode, pressing this button can also disable/enable the Heat function.

27.Intensity

The Intensity Adjustment Button for Air-pressure-5 levels of intensity to be adjusted. After activating the air-pressure function(Auto and Manual), press this button to adjust the intensity in the cycle.

28.SPEED

The Speed Adjustment Button for Tapping, Clapping, Rolling and Shiatsu function. When Tapping, Clapping, Rolling or Shiatsu function is engaged, every single press on this button will change the massage speed interval in the sequence of " Lv1 > LV2 > LV3 > LV4 >Lv5 " in cycle.

29.STRENGTH

The Strength Adjustment Button for kneading function.

When Kneading function is engaged, every single press on this button will change the massage speed strength interval in the sequence of " Lv1 > Lv2 > Lv3 > Lv4 > Lv5 " in cycle.

Setting Air Squeeze

30.SHOULDER

Shoulder Air Squeeze Massage Control Button -5 levels of intensity to be adjusted. Press this button once to activate rhythmic air massage at shoulder Press this button again to stop the function.

31.BACK & SEAT

Back and Seat Air Squeeze Massage Control Button 5 levels of intensity to be adjusted. Press this button once to activate rhythmic air massage at back and seat. Press this button again to stop the function.

How to Use

32.HAND

Hand Air Squeeze Massage Control Button - 5 levels of intensity to be adjusted. Press this button once to activate rhythmic air pressure massage at Hand Rest. Press this button again to stop the function.

33.FOOT

Footrest Air Squeeze Massage Control Button -5 levels of intensity to be adjusted. Press this button once to activate rhythmic air pressure massage at Footrest. Press this button again to stop the function.

34.Full Body Air Pressure Massage

Full Body Air Pressure massage.

Press once to activate the air-pressure massage at full body Press again to stop the function.

Finish Operating

Please press the " ON / OFF " button after use. Massage Rollers will restore to its original position: then switch the power supply button under the chair to " o " and unplug the machine from the wire socket.

Cleaning and maintenance

1. Cleaning of the synthetic leather

Wipe the synthetic leather with a soft dry cloth.

- Do not clean the product with chemicals such as thinners, gasoline and alcohol.
- When using a leather maintenance product (cleaning cloth) sold on the market, follow its directions for use.
- If the synthetic leather is very dirty, wipe it with the method below.



- ① Put a piece of soft cloth into water or 3% to 5% neutral detergent contained hot water and wring it out.
- ② Wipe surface of the synthetic leather with the soft cloth.
- ③ Wipe the detergent with a piece of cloth once soaked in clean water and wrung out.
- ④ Wipe with a piece of wrung soft cloth.
- ⑤ Have the synthetic leather take natural air drying.

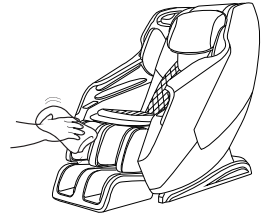

- If it is difficult to remove the stains on the synthetic leather, soak a piece of melamine foam bought from the market into a neutral detergent and use it wipe the product.
- Do not dry the surface by a hair drier.
- Surface of the synthetic leather may be dyed by fabric colors; therefore, be careful when wiping the product with denim or colored cloth.
- Synthetic leather may discolor, so the position in contact with the hair dye used should be covered by a towel.

2. Cleaning of the plastic parts

- 1) Put a piece of soft cloth into water or neutral detergent contained hot water, wring it out and wipe the plastic parts.
- Do not clean the product with chemicals such as thinners, gasoline and alcohol.
- 2) Wipe with a piece of cloth once soaked in clean water and wrung out.
- Wring the cloth out before using it to wipe the remote controller.
- 3) Have the plastic parts take natural air drying.

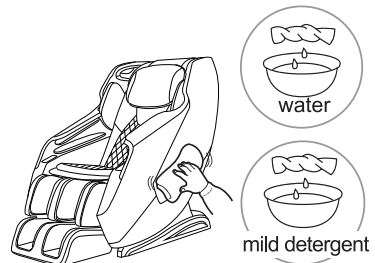

Troubleshooting

This page summarizes the most common problems you could encounter with the product. If you are unable to solve the problem with the information below, contact service center immediately.

If the problem encountered is not listed, please try the following suggestions:

1. Turn off the product and unplug it.
2. Wait for 60 minutes.
3. Plug the product back to the recommended outlet and restart.
4. If the problem persists, contact the authorized service center.

Problem	Possible Cause	Suggestion
The product does not work	The product is not plugged in properly.	Ensure the voltage on the product corresponds to the local mains voltage and then plug in again. Make sure the outlet is properly working.
The product stopped working	The product has just finished its auto timer session and has automatically switched to standby mode.	If you want another session, press the Power button again.
The product stopped working	You may have used the product continuously for 45 minutes where the over heat protection has been activated.	Unplug the product and let it cool down for 60 minutes before you use it again.
The product does not work	An excessive load has been applied on the product.	Reduce the excessive load and start again.
The product is abnormally warm	The product is likely to be overused.	Unplug the product and let it cool down before using it again.
Noise can be heard from the product	Noise is made by the mechanical parts of the product.	This is normal and does not mean that the product is faulty.

Grounding Instructions

This product must be grounded. If it should malfunction or break down, grounding provides a path of least resistance for the electric current to reduce the risk of electric shock. This product is equipped with a cord with an equipment-grounding conductor and a grounding plug. The plug must be plugged into an appropriate outlet that is properly installed and grounded in accordance with all local codes and ordinances.

Danger-Improper connection of the equipment-grounding conductor can result in a risk of electric shock. Check with a qualified electrician or service technician if the product will not fit the outlet, have a proper outlet installed by a qualified electrician.

This product is for use on a nominal 120V circuit and has grounding plug that looks like that plug illustrated below. Make sure that the product is connected to an outlet having the same configuration as the plug. No adapter should be used with this product.

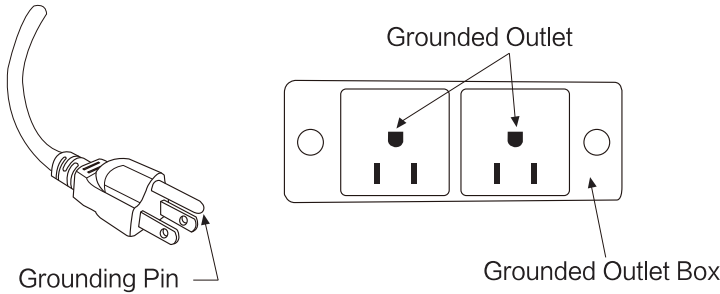

Chair Specifications

Description	Specifications
Model No.	Maxim 3D LE
Rated Voltage	110-120V~
Rated Frequency	60Hz
Rated Current	1.1A
Rated Time	15 minutes
Dimensions(L x W x H)	Upright: 60.6"X29.9"X47.2"
	Reclined: 72.4"X29.9"X40.2"
N.W./G.W.	BOX1: 172.4/206.1lbs
	BOX2: 44.8/50.3lbs
Length of Wire	Controller wire: 59.0"
	Power supply wire: 70.9"
Usage Condition	Environment temperature: 32°F~95°F
	Contrasting humidity: 20-80RH
Storage Condition	Storage temperature: 23°F~95°F
	Storage humidity: 20-80RH
Safety Feature	Equipped with overheated and power
Maximum body weight of user	220 lbs